



Excellence in Compliance Testing

## **Certification Test Report**

**FCC ID: HSW-XDM2510  
IC: 4492A-XDM2510**

**FCC Rule Part: 15.247  
IC Radio Standards Specification: RSS-210**

**ACS Report Number: 11-0034.W06.11.A**

Manufacturer: RFM/Cirronet  
Model: XDM2510HP, XDM2510HC

Test Begin Date: March 1, 2011  
Test End Date: April 4, 2011

Report Issue Date: April 4, 2011



FOR THE SCOPE OF ACCREDITATION UNDER LAB Code 200612-0

This report must not be used by the client to claim product certification, approval, or endorsement by NVLAP, NIST, or any agency of the Federal Government.

Reviewed by:

**Kirby Munroe  
Director, Wireless Certifications  
ACS, Inc.**

This test report shall not be reproduced except in full. This report may be reproduced in part with prior written consent of ACS, Inc. The results contained in this report are representative of the sample(s) submitted for evaluation.

**This report contains 23 pages**

# TABLE OF CONTENTS

<b>1</b>	<b>GENERAL</b>	<b>3</b>
1.1	PURPOSE	3
1.2	PRODUCT DESCRIPTION	3
1.3	TEST METHODOLOGY AND CONSIDERATIONS	3
<b>2</b>	<b>TEST FACILITIES</b>	<b>4</b>
2.1	LOCATION	4
2.2	LABORATORY ACCREDITATIONS/RECOGNITIONS/CERTIFICATIONS	4
2.3	RADIATED EMISSIONS TEST SITE DESCRIPTION	5
2.3.1	<i>Semi-Anechoic Chamber Test Site</i>	5
2.3.2	<i>Open Area Tests Site (OATS)</i>	6
2.4	CONDUCTED EMISSIONS TEST SITE DESCRIPTION	7
<b>3</b>	<b>APPLICABLE STANDARD REFERENCES</b>	<b>7</b>
<b>4</b>	<b>LIST OF TEST EQUIPMENT</b>	<b>8</b>
<b>5</b>	<b>SUPPORT EQUIPMENT</b>	<b>9</b>
<b>6</b>	<b>EQUIPMENT UNDER TEST SETUP BLOCK DIAGRAM</b>	<b>9</b>
<b>7</b>	<b>SUMMARY OF TESTS</b>	<b>10</b>
7.1	ANTENNA REQUIREMENT – FCC: SECTION 15.203	10
7.2	POWER LINE CONDUCTED EMISSIONS – FCC: SECTION 15.207 IC: RSS-GEN 7.2.4	10
7.2.1	<i>Measurement Procedure</i>	10
7.2.2	<i>Measurement Results</i>	10
7.3	6dB /99% BANDWIDTH – FCC: SECTION 15.247(A)(2) IC: RSS-210 A8.2(A)	13
7.3.1	<i>Measurement Procedure</i>	13
7.3.2	<i>Measurement Results</i>	13
7.4	PEAK OUTPUT POWER REQUIREMENT - FCC SECTION 15.247(B)(3) IC: RSS-210 A8.4(4)	15
7.4.1	<i>Measurement Procedure</i>	15
7.4.2	<i>Measurement Results</i>	15
7.5	BAND-EDGE COMPLIANCE AND SPURIOUS EMISSIONS-FCC 15.247D IC:RSS-210 2.6, A8.5	16
7.5.1	<i>Band-Edge Compliance of RF Conducted Emissions</i>	16
7.5.1.1	<i>Measurement Procedure</i>	16
7.5.1.2	<i>Measurement Results</i>	16
7.5.2	<i>RF Conducted Spurious Emissions</i>	18
7.5.2.1	<i>Measurement Procedure</i>	18
7.5.2.2	<i>Measurement Results</i>	18
7.5.3	<i>Radiated Spurious Emissions (Restricted Bands) - FCC Sec. 15.205 IC: RSS-210 2.6</i>	20
7.5.3.1	<i>Measurement Procedure</i>	20
7.5.3.2	<i>Duty Cycle Correction</i>	20
7.5.3.3	<i>Measurement Results</i>	20
7.5.3.4	<i>Sample Calculation:</i>	21
7.6	PEAK POWER SPECTRAL DENSITY- FCC SECTION 15.247(E) IC: RSS-210 A8.2(B)	22
7.6.1	<i>Measurement Procedure</i>	22
7.6.2	<i>Measurement Results</i>	22
<b>8</b>	<b>CONCLUSION</b>	<b>23</b>

## **1 GENERAL**

### **1.1 Purpose**

The purpose of this report is to demonstrate compliance with Part 15 Subpart C of the FCC's Code of Federal Regulations and Industry Canada's Radio Standards Specification RSS-210 for a single modular approval.

### **1.2 Product description**

The XDM2510 module is wireless transceiver designed for industrial automation, monitoring and control applications. Basic operating parameters of the radio are:

Band of operation:	2405 – 2480 MHz
Number of hopping channels:	16
Channel spacing	5 MHz
Output power (maximum):	9 dBm
Modulation format:	O-QPSK
Antennas:	12 dBi Monopole, RFM/Cirronet, PN: - OMNI2412 12 dBi Multi-Element Patch, RFM/Cirronet, PN: 800485
RF connector:	UFL
Operating Voltage:	3.6VDC

Manufacturer Information:  
RFM/CIRRONET  
3709 Premiere Parkway  
Duluth, GA, 30097  
USA

Test Sample Serial Number(s): 00006A

Test Sample Condition: The test samples were provided in good working order with no visible defects.

### **1.3 Test Methodology and Considerations**

A test evaluation board was utilized to supply power and program the EUT for test modes. See Section 5.0 – 6.0 for additional details.

The XDM2510HP and XDM2510HC models are electrically identical and differ only in their mounting option. The XDM2510HC is designed for reflow soldering and the XDM2510HP is designed for socket mounting. To allow use of a test fixture during testing the XDM2510HP model was evaluated.

## **2 TEST FACILITIES**

### **2.1 Location**

The radiated and conducted emissions test sites are located at the following address:

Advanced Compliance Solutions  
5015 B.U. Bowman Drive  
Buford, GA 30518  
Phone: (770) 831-8048  
Fax: (770) 831-8598

### **2.2 Laboratory Accreditations/Recognitions/Certifications**

ACS is accredited to ISO/IEC 17025 by the National Institute of Standards and Technology under their National Voluntary Laboratory Accreditation Program (NVLAP), Lab Code 200612-0. Unless otherwise specified, all tests methods described within this report are covered under the ISO/IEC 17025 scope of accreditation.

The Semi-Anechoic Chamber Test Site, Open Area Test Site (OATS) and Conducted Emissions Site have been fully described, submitted to, and accepted by the FCC, Industry Canada and the Japanese Voluntary Control Council for Interference by information technology equipment.

FCC Registration Number: 894540

Industry Canada Lab Code: IC 4175A

VCCI Member Number: 1831

- VCCI OATS Registration Number R-1526
- VCCI Conducted Emissions Site Registration Number: C-1608

### 2.3 Radiated Emissions Test Site Description

#### 2.3.1 Semi-Anechoic Chamber Test Site

The Semi-Anechoic Chamber Test Site consists of a 20' x 30' x 18' shielded enclosure. The chamber is lined with Toyo Ferrite Grid Absorber, model number FFG-1000. The ferrite tile grid is 101 x 101 x 19mm thick and weighs approximately 550 grams. These tiles are mounted on steel panels and installed directly on the inner walls of the chamber.

The turntable is 150cm in diameter and is located 160cm from the back wall of the chamber. The chamber is grounded via 1 - 8' copper ground rod, installed at the center of the back wall, it is bound to the ground plane using 3/4" stainless steel braided cable.

The turntable is all steel, flush mounted table installed in an all steel frame. The table is remotely operated from inside the control room located 25' from the range. The turntable is electrically bonded to the surrounding ground plane via steel fingers installed on the edge of the turn table. The steel fingers make constant contact with the ground plane during operation.

Behind the turntable is a 3' x 6' x 4' deep shielded pit used for support equipment if necessary. The pit is equipped with 1 - 4" PVC chases from the turntable to the pit that allow for cabling to the EUT if necessary. The underside of the turntable can be accessed from the pit so cables can be supplied to the EUT from the pit.

A diagram of the Semi-Anechoic Chamber Test Site is shown in Figure 2.3-1 below:

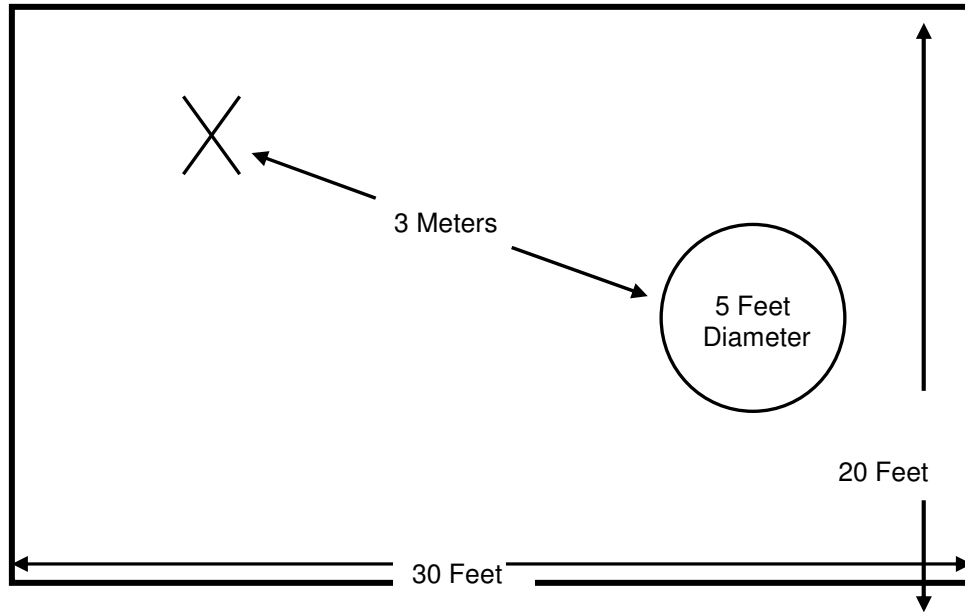

Figure 2.3-1: Semi-Anechoic Chamber Test Site

**2.3.2 Open Area Tests Site (OATS)**

The open area test site consists of a 40' x 66' concrete pad covered with a perforated electro-plated galvanized sheet metal. The perforations in the sheet metal are 1/8" holes that are staggered every 3/16". The individual sheets are placed to overlap each other by 1/4" and are riveted together to provide a continuous seam. Rivets are spaced every 3" in a 3 x 20 meter perimeter around the antenna mast and EUT area. Rivets in the remaining area are spaced as necessary to properly secure the ground plane and maintain the electrical continuity.

The entire ground plane extends 12' beyond the turntable edge and 16' beyond the antenna mast when set to a 10 meter measurement distance. The ground plane is grounded via 4 - 8' copper ground rods, each installed at a corner of the ground plane and bound to the ground plane using 3/4" stainless steel braided cable.

The turntable is an all aluminum 10' flush mounted table installed in an all aluminum frame. The table is remotely operated from inside the control room located 40' from the range. The turntable is electrically bonded to the surrounding ground plane via steel fingers installed on the edge of the turn table. The steel fingers make constant contact with the ground plane during operation.

Adjacent to the turntable is a 7' x 7' square and 4' deep concrete pit used for support equipment if necessary. The pit is equipped with 5 - 4" PVC chases from the pit to the control room that allow for cabling to the EUT if necessary. The underside of the turntable can be accessed from the pit so cables can be supplied to the EUT from the pit. The pit is covered with 2 sheets of 1/4" diamond style re-enforced steel sheets. The sheets are painted to match the perforated steel ground plane; however the underside edges have been masked off to maintain the electrical continuity of the ground plane. All reflecting objects are located outside of the ellipse defined in ANSI C63.4.

A diagram of the Open Area Test Site is shown in Figure 2.3-2 below:

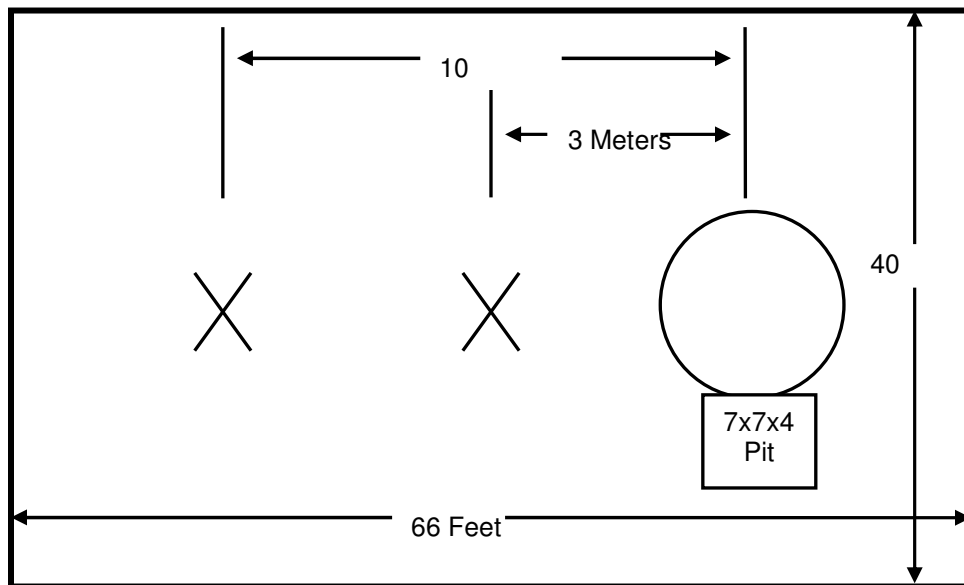

**Figure 2.3-2: Open Area Test Site**

## 2.4 Conducted Emissions Test Site Description

The AC mains conducted EMI site is located in the main EMC lab. It consists of an 8' x 8' solid aluminum horizontal group reference plane (GRP) bonded every 3" to an 8' X 8' vertical ground plane.

The site is of sufficient size to test table top and floor standing equipment in accordance with section 6.1.4 of ANSI C63.4.

A diagram of the room is shown below in figure 4.1.3-1:

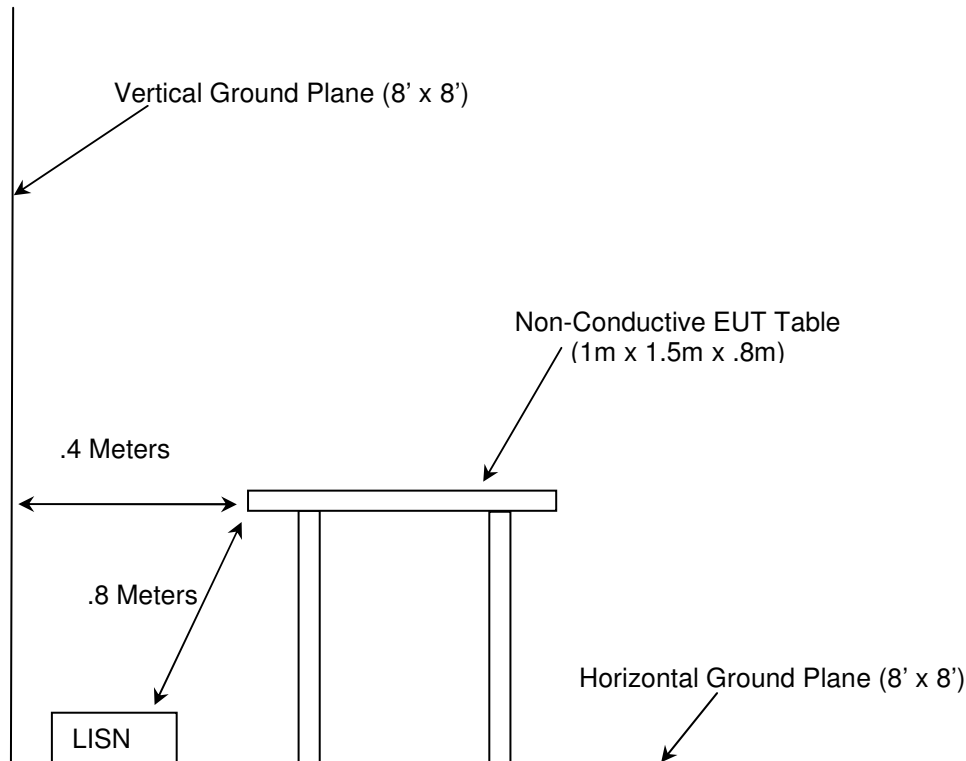

Figure 2.4-1: AC Mains Conducted EMI Site

## 3 APPLICABLE STANDARD REFERENCES

The following standards were used:

- ❖ ANSI C63.4-2003: Method of Measurements of Radio-Noise Emissions from Low-Voltage Electrical and Electronic Equipment in the 9KHz to 40GHz
- ❖ US Code of Federal Regulations (CFR): Title 47, Part 2, Subpart J: Equipment Authorization Procedures, 2010
- ❖ US Code of Federal Regulations (CFR): Title 47, Part 15, Subpart C: Radio Frequency Devices, Intentional Radiators, 2010
- ❖ FCC KDB Publication No. 558074 - Guidance on Measurements for Digital Transmission Systems (47 CFR 15.247), March 2005
- ❖ Industry Canada Radio Standards Specification: RSS-210 - Low-power License-exempt Radiocommunication Devices (All Frequency Bands): Category I Equipment, Issue 8, December 2010
- ❖ Industry Canada Radio Standards Specification: RSS-GEN – General Requirements and Information for the Certification of Radiocommunication Equipment, Issue 3, December 2010.

#### 4 LIST OF TEST EQUIPMENT

The calibration interval of test equipment is annually or the manufacturer's recommendations. Where the calibration interval deviates from the annual cycle based on the instrument manufacturer's recommendations, it shall be stated below.

**Table 4-1: Test Equipment**

AssetID	Manufacturer	Model #	Equipment Type	Serial #	Last Calibration Date	Calibration Due Date
1	Rohde & Schwarz	ESM - Display	Spectrum Analyzers	833771/007	9/23/2010	9/23/2012
2	Rohde & Schwarz	ESM-Receiver	Spectrum Analyzers	839587/003	9/23/2010	9/23/2012
22	Agilent	8449B	Amplifiers	3008A00526	9/2/2010	8/30/2011
25	Chase	CBL6111	Antennas	1043	9/13/2010	9/13/2012
30	Spectrum Technologies	DRH-0118	Antennas	970102	5/8/2009	5/8/2011
73	Agilent	8447D	Amplifiers	2727A05624	3/21/2011	3/21/2012
152	EMCO	3825/2	LISN	9111-1905	11/2/2010	11/2/2012
153	EMCO	3825/2	LISN	9411-2268	1/13/2011	1/13/2012
167	ACS	Chamber EMI Cable Set	Cable Set	167	1/26/2011	1/26/2012
168	Hewlett Packard	11947A	Attenuators	44829	2/4/2011	2/4/2012
283	Rohde & Schwarz	FSP40	Spectrum Analyzers	1000033	8/31/2010	8/31/2011
291	Florida RF Cables	SMRE-200W-12.0-SMRE	Cables	None	12/7/2010	12/7/2011
292	Florida RF Cables	SMR-290AW-480.0-SMR	Cables	None	12/7/2010	12/7/2011
324	ACS	Belden	Cables	8214	7/9/2010	7/9/2011
340	Aeroflex/Weinschel	AS-20	Attenuators	7136	10/5/2010	10/5/2011
422	Florida RF	SMS-200AW-72.0-SMR	Cables	805	12/29/2010	12/29/2011
432	Microwave Circuits	H8G020G4	Filters	264066	7/16/2010	7/16/2011



5 SUPPORT EQUIPMENT

Table 5-1: Support Equipment

Item	Equipment Type	Manufacturer	Model Number	Serial Number
1	9V ITE Power Supply	Globtek, Inc.	GT-21088-0909-W2	013853 17/04
2	XDM2140 Evaluation Board	RFM	800953 Rev A	NA

6 EQUIPMENT UNDER TEST SETUP BLOCK DIAGRAM

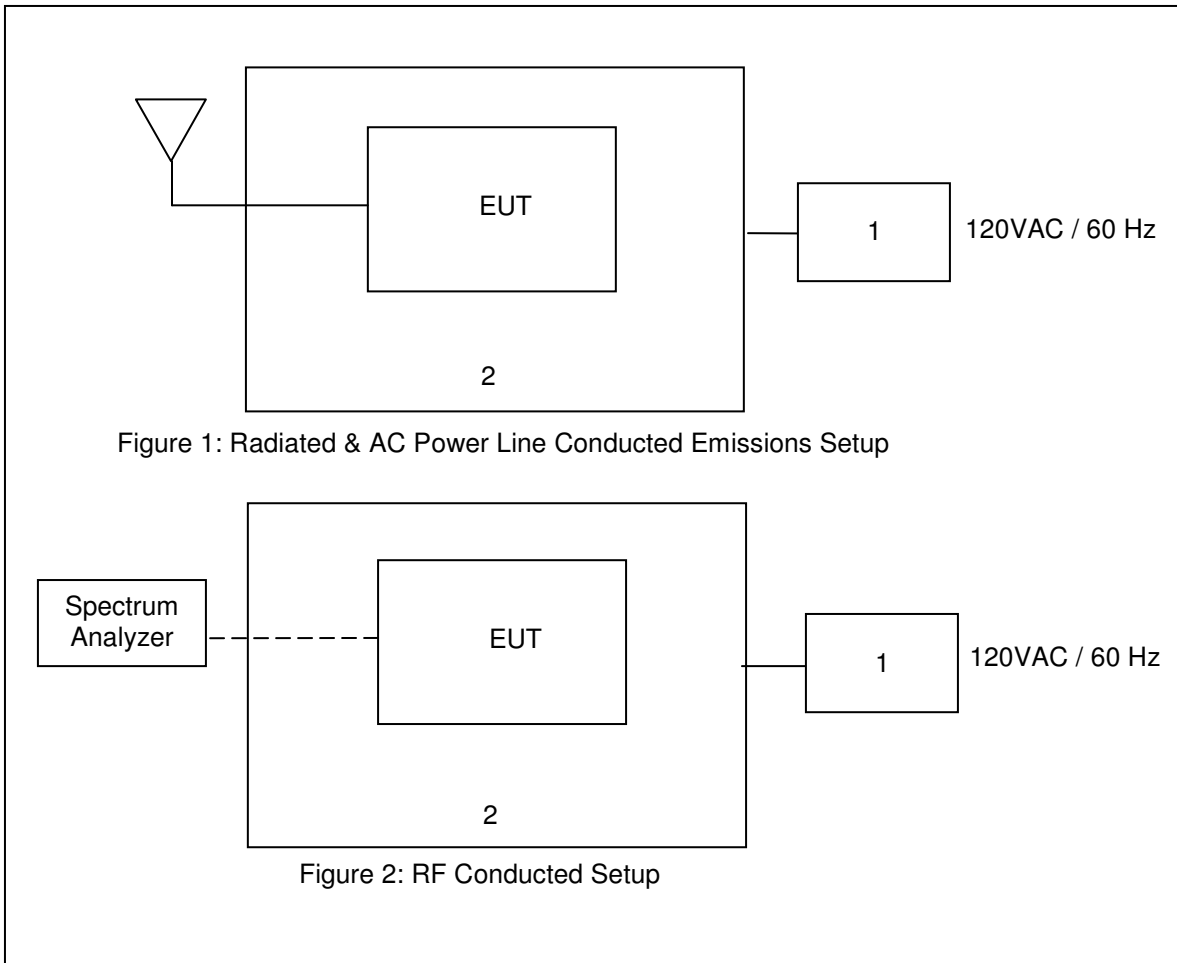

## 7 SUMMARY OF TESTS

Along with the tabular data shown below, plots were taken of all signals deemed important enough to document.

### 7.1 Antenna Requirement – FCC: Section 15.203

The XDM2510HP and XDM2510HC utilize an UFL connector soldered directly to the PCB board thus satisfying the unique antenna coupling specified in Part 15.203.

### 7.2 Power Line Conducted Emissions – FCC: Section 15.207 IC: RSS-Gen 7.2.4

#### 7.2.1 Measurement Procedure

ANSI C63.4 sections 6 and 7 were the guiding documents for this evaluation. Conducted emissions were performed from 150kHz to 30MHz with the spectrum analyzer's resolution bandwidth set to 9kHz and the video bandwidth set to 30kHz. The calculation for the conducted emissions is as follows:

**Corrected Reading = Analyzer Reading + LISN Loss + Cable Loss**

**Margin = Applicable Limit - Corrected Reading**

#### 7.2.2 Measurement Results

Results of the test are shown below in and Table 7.2.2-1 to 7.2.2-4.

**Table 7.2.2-1: Line 1 Conducted EMI Results – Dipole Antenna**

Frequency (MHz)	Level (dBuV)	Transducer (dB)	Limit (dBuV)	Margin (dB)	Line	PE	Detector
0.359	29.81	10.18	58.75	28.9	L1	FLO	QP
5.313	28.12	10.15	60.00	31.9	L1	FLO	QP
6.28	29.41	10.17	60.00	30.6	L1	FLO	QP
7.15	30.81	10.17	60.00	29.2	L1	FLO	QP
7.243	30.73	10.18	60.00	29.3	L1	FLO	QP
7.34	29.46	10.18	60.00	30.5	L1	FLO	QP
0.359	23.53	10.18	48.75	25.2	L1	FLO	AVG
5.313	24.20	10.15	50.00	25.8	L1	FLO	AVG
6.28	25.55	10.17	50.00	24.5	L1	FLO	AVG
7.15	27.57	10.17	50.00	22.4	L1	FLO	AVG
7.243	27.51	10.18	50.00	22.5	L1	FLO	AVG
7.34	26.28	10.18	50.00	23.7	L1	FLO	AVG

Table 7.2.2-2: Line 2 Conducted EMI Results - Dipole Antenna

Frequency (MHz)	Level (dBuV)	Transducer (dB)	Limit (dBuV)	Margin (dB)	Line	PE	Detector
0.193	28.27	10.08	63.91	35.6	L2	FLO	QP
0.387	29.49	10.21	58.13	28.6	L2	FLO	QP
0.483	31.91	10.00	56.29	24.4	L2	FLO	QP
1.834	27.67	10.00	56.00	28.3	L2	FLO	QP
6.085	28.77	10.16	60.00	31.2	L2	FLO	QP
7.05	26.29	10.17	60.00	33.7	L2	FLO	QP
0.193	19.07	10.08	53.91	34.8	L2	FLO	AVG
0.387	22.95	10.21	48.13	25.2	L2	FLO	AVG
0.483	25.22	10.00	46.29	21.1	L2	FLO	AVG
1.834	20.65	10.00	46.00	25.4	L2	FLO	AVG
6.085	23.78	10.16	50.00	26.2	L2	FLO	AVG
7.05	21.21	10.17	50.00	28.8	L2	FLO	AVG

Table 7.2.2-3: Line 1 Conducted EMI Results – Patch Antenna

Frequency (MHz)	Level (dBuV)	Transducer (dB)	Limit (dBuV)	Margin (dB)	Line	PE	Detector
0.192	27.82	10.08	63.95	36.1	L1	FLO	QP
0.388	29.96	10.21	58.11	28.1	L1	FLO	QP
0.482	32.70	10.00	56.30	23.6	L1	FLO	QP
1.448	25.76	10.00	56.00	30.2	L1	FLO	QP
1.933	28.50	10.00	56.00	27.5	L1	FLO	QP
7.923	25.17	10.20	60.00	34.8	L1	FLO	QP
0.192	19.50	10.08	53.95	34.4	L1	FLO	AVG
0.388	23.20	10.21	48.11	24.9	L1	FLO	AVG
0.482	25.56	10.00	46.30	20.7	L1	FLO	AVG
1.448	19.29	10.00	46.00	26.7	L1	FLO	AVG
1.933	20.82	10.00	46.00	25.2	L1	FLO	AVG
7.923	21.74	10.20	50.00	28.3	L1	FLO	AVG

Table 7.2.2-4: Line 2 Conducted EMI Results - Patch Antenna

Frequency (MHz)	Level (dBuV)	Transducer (dB)	Limit (dBuV)	Margin (dB)	Line	PE	Detector
0.291	26.34	10.02	60.50	34.2	L2	FLO	QP
0.385	30.34	10.21	58.17	27.8	L2	FLO	QP
0.483	32.38	10.00	56.29	23.9	L2	FLO	QP
1.837	27.62	10.00	56.00	28.4	L2	FLO	QP
2.706	23.37	10.11	56.00	32.6	L2	FLO	QP
5.314	26.94	10.15	60.00	33.1	L2	FLO	QP
0.291	19.13	10.02	50.50	31.4	L2	FLO	AVG
0.385	23.17	10.21	48.17	25.0	L2	FLO	AVG
0.483	25.09	10.00	46.29	21.2	L2	FLO	AVG
1.837	20.23	10.00	46.00	25.8	L2	FLO	AVG
2.706	16.98	10.11	46.00	29.0	L2	FLO	AVG
5.314	20.70	10.15	50.00	29.3	L2	FLO	AVG

7.3 6dB / 99% Bandwidth – FCC: Section 15.247(a)(2) IC: RSS-210 A8.2(a)

7.3.1 Measurement Procedure

The 6dB bandwidth was measured in accordance with the FCC KDB Publication No. 558074 “Guidance on Measurements for Digital Transmission Systems (47 CFR 15.247)”. The RBW of the spectrum analyzer was set to 100 kHz and VBW 300 kHz. Span was set large enough to capture the entire emissions and >> RBW.

The 99% occupied bandwidth was measured with the spectrum analyzer span set to fully display the emission and side bands. The RBW was to ~ 1% of the span. The trace was set to max hold with a sample detector. The occupied bandwidth measurement function of the analyzer was used for the 99% bandwidth.

7.3.2 Measurement Results

Results are shown below in table 7.3.2-1 and figure 7.3.2-1 to 7.3.2-6:

Table 7.3.2-1: 6dB / 99% Bandwidth

Frequency [MHz]	6dB Bandwidth [MHz]	99% Bandwidth [MHz]
2405	1.54	2.27
2440	1.50	2.27
2480	1.51	2.28

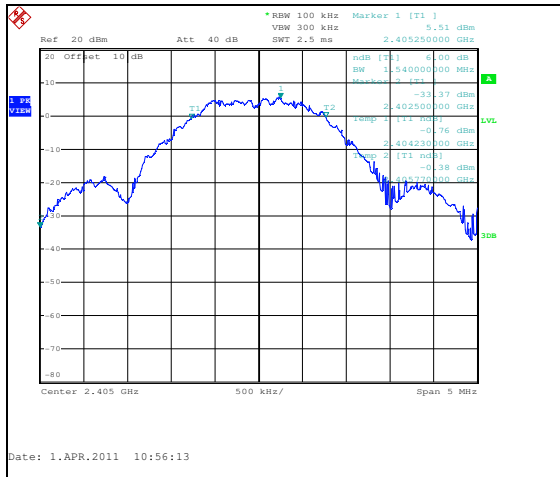

Figure 7.3.2-1: 6dB Bandwidth Plot – 2405MHz

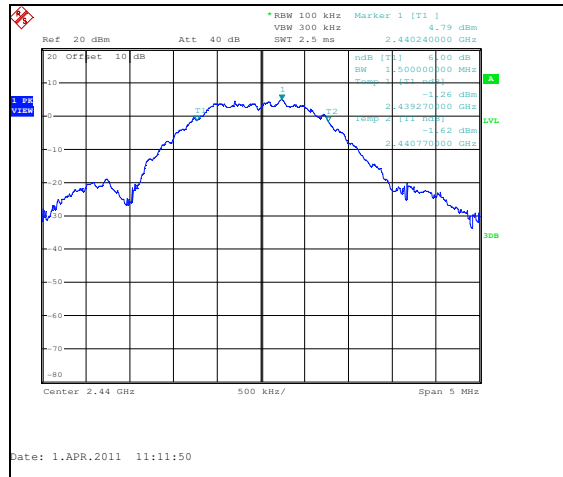

Figure 7.3.2-2: 6dB Bandwidth Plot – 2440MHz

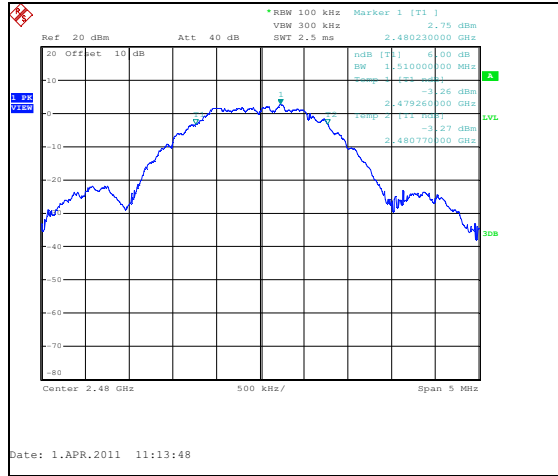

Figure 7.3.2-3: 6dB Bandwidth Plot – 2480MHz

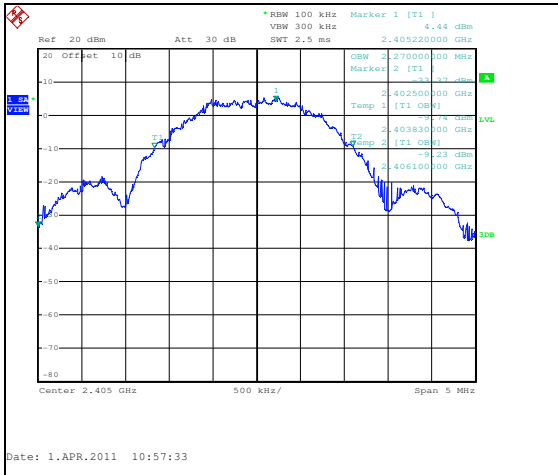

Figure 7.3.2-4: 99% Bandwidth Plot – 2405MHz

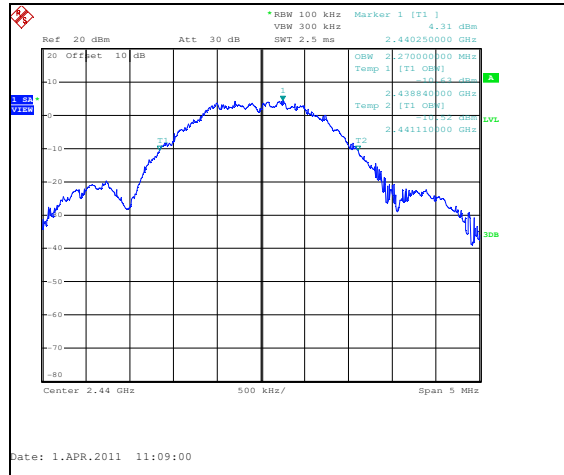

Figure 7.3.2-5: 99% Bandwidth Plot – 2440MHz

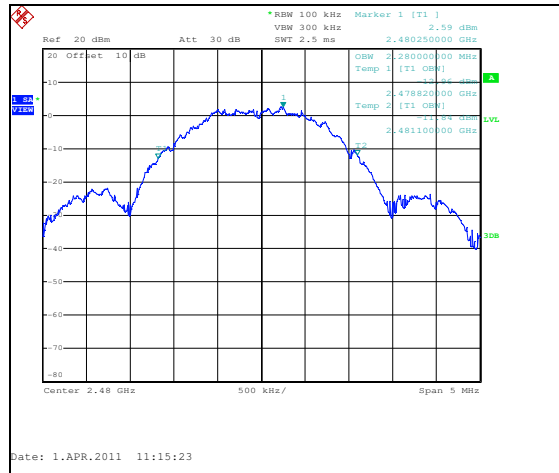

Figure 7.3.2-6: 99% Bandwidth Plot – 2480MHz

7.4 Peak Output Power Requirement - FCC Section 15.247(b)(3) IC: RSS-210 A8.4(4)

7.4.1 Measurement Procedure

The Peak Output Power was measured in accordance with the FCC KDB Publication No. 558074 "Guidance on Measurements for Digital Transmission Systems (47 CFR 15.247)" Power Option 1. The RF output of the equipment under test was directly connected to the input of the Spectrum Analyzer. Data was collected with the EUT operating at maximum power.

7.4.2 Measurement Results

Results are shown below in Table 7.4.2-1 and Figures 7.4.2-1 to 7.4.2-3.

Table 7.4.2-1: Peak Output Power

Frequency (MHz)	Output Power (dBm)
2405	8.90
2440	7.71
2480	6.36

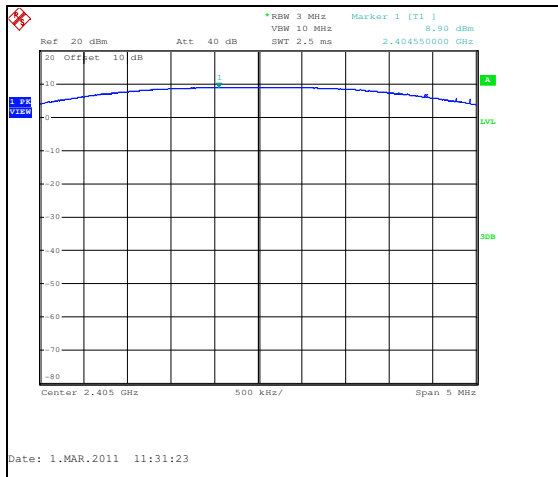

Figure 7.4.2-1: Output power – 2405MHz

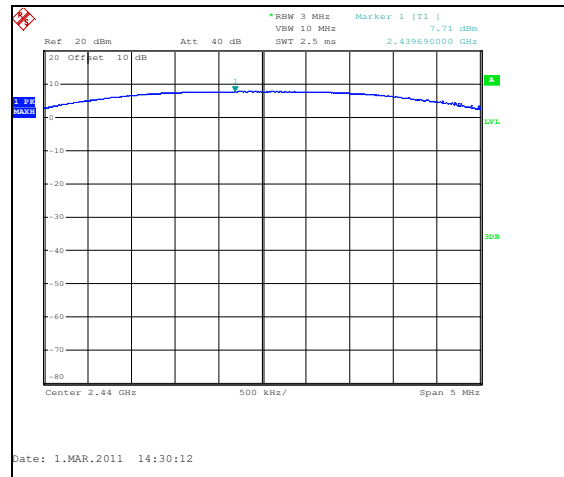

Figure 7.4.2-2: Output power – 2440MHz

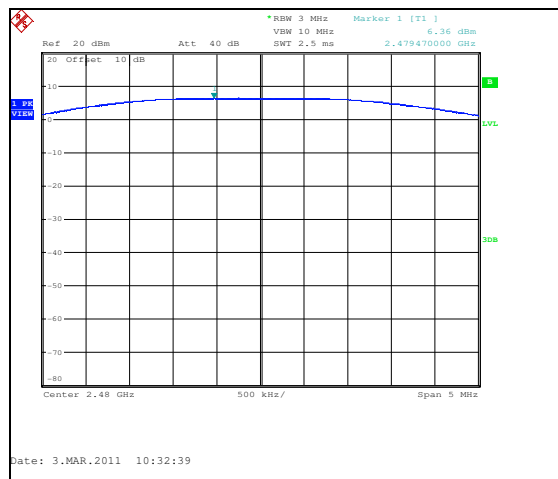

Figure 7.4.2-3: Output power – 2480MHz

**7.5 Band-Edge Compliance and Spurious Emissions-FCC 15.247d IC:RSS-210 2.6, A8.5**

**7.5.1 Band-Edge Compliance of RF Conducted Emissions**

**7.5.1.1 Measurement Procedure**

The EUT was investigated at the low and high channels of operation to determine band-edge compliance. All antenna types were evaluated. Because the upper band-edge coincides with a restricted band, band-edge compliance for the upper band-edge was determined based on the marker-delta method.

The lower band-edge compliance was determined using the conducted marker-delta method in which the radio frequency power that is produced by the EUT is at least 20 dB below that in the 100 kHz bandwidth within the band that contains the highest level of desired power.

**7.5.1.2 Measurement Results**

Band-edge compliance is displayed in Tables 7.5.1.2-1 to 7.5.1.2-2 and Figures 7.5.1.2-1 to 7.5.1.2-5.

**Table 7.5.1.2-1: Upper Band-edge Radiated Emissions – Dipole Antenna**

Frequency (MHz)	Uncorrected Level (dBuV)		Antenna Factor (dB/m)	Correction Factors (dB)	Fundamental Level (dBuV/m)		Marker-Delta (dB)	Band-Edge Level (dBuV/m)		Margin to Limit (dBuV/m)	
	pk	Qpk/Avg			pk	Qpk/Avg		pk	Qpk/Avg	74	54
2480	93.50	93.50	H	0.91	94.41	68.03	39.98	54.43	28.05	19.57	25.95
2480	107.06	107.06	V	0.91	107.97	81.59	41.07	66.90	40.52	7.10	13.48

**Table 7.5.1.2-2: Upper Band-edge Radiated Emissions – Patch Antenna**

Frequency (MHz)	Uncorrected Level (dBuV)		Antenna Factor (dB/m)	Correction Factors (dB)	Fundamental Level (dBuV/m)		Marker-Delta (dB)	Band-Edge Level (dBuV/m)		Margin to Limit (dBuV/m)	
	pk	Qpk/Avg			pk	Qpk/Avg		pk	Qpk/Avg	74	54
2480	92.62	92.62	H	0.86	93.48	67.11	40.65	52.83	26.46	21.17	27.54
2480	113.60	113.60	V	0.86	114.46	88.09	40.92	73.54	47.17	0.46	6.83

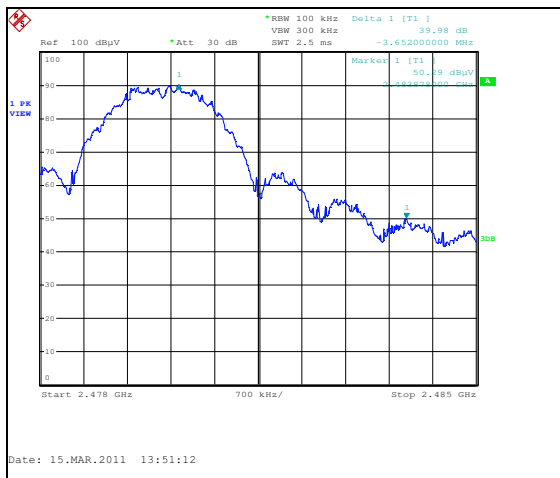

**Figure 7.5.1.2-1: Dipole Upper Band-edge - HPol**

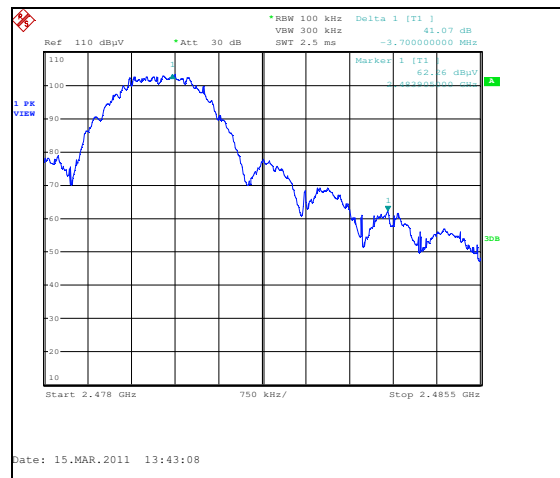

**Figure 7.5.1.2-2: Dipole Upper Band-edge - VPol**



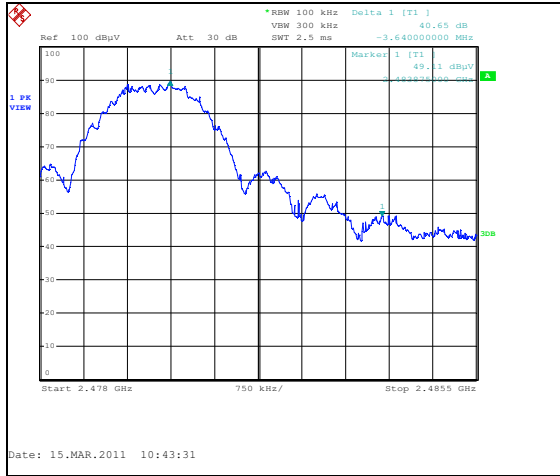

Figure 7.5.1.2-3: Patch Upper Band-edge - HPol

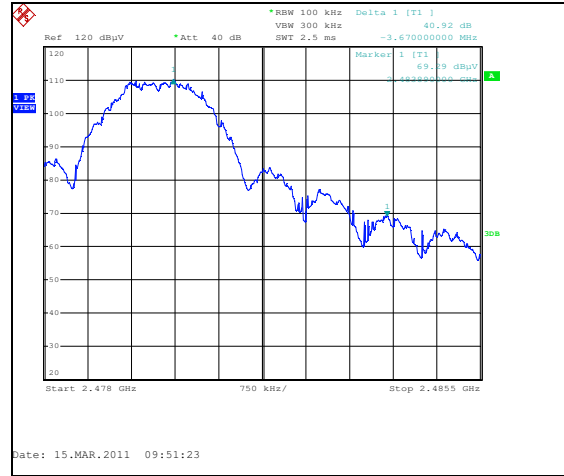

Figure 7.5.1.2-4: Patch Upper Band-edge - VPol

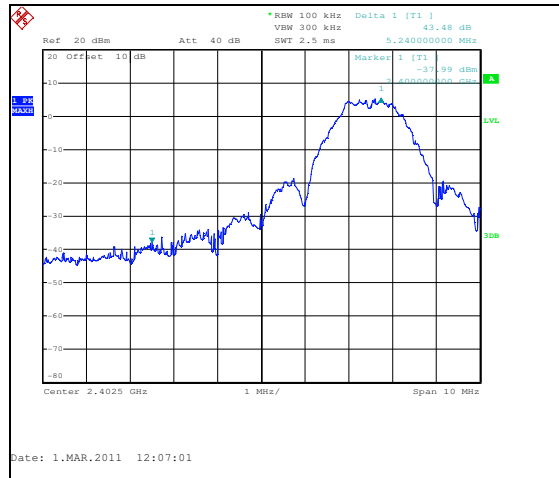

Figure 7.5.1.2-5: Lower Band-edge (Conducted)

## 7.5.2 RF Conducted Spurious Emissions

### 7.5.2.1 Measurement Procedure

The RF Conducted Spurious Emissions were measured in accordance with the FCC KDB Publication No. 558074 "Guidance on Measurements for Digital Transmission Systems (47 CFR 15.247)". The RF output of the equipment under test was directly connected to the input of the Spectrum Analyzer. The EUT was investigated for conducted spurious emissions from 30MHz to 25GHz, 10 times the highest fundamental frequency. For each measurement, the spectrum analyzer's RBW was set to 100 kHz and the VBW was set to 300 kHz. The peak detector and Max Hold function of the analyzer were utilized.

### 7.5.2.2 Measurement Results

RF Conducted Emissions are displayed in Figures 7.5.2.2-1 through 7.5.2.2-9.

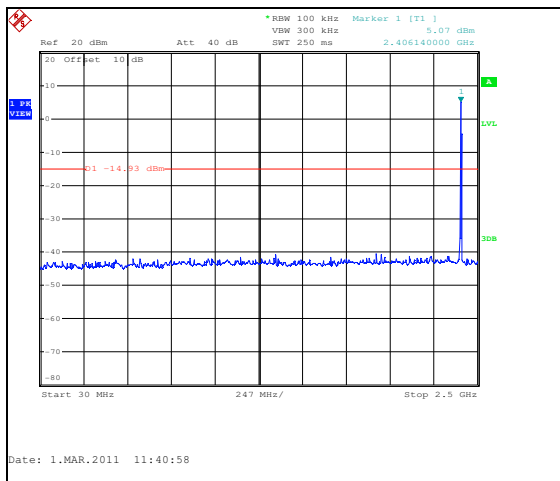

Figure 7.5.2.2-1: 30 MHz – 2.5 GHz – 2405MHz

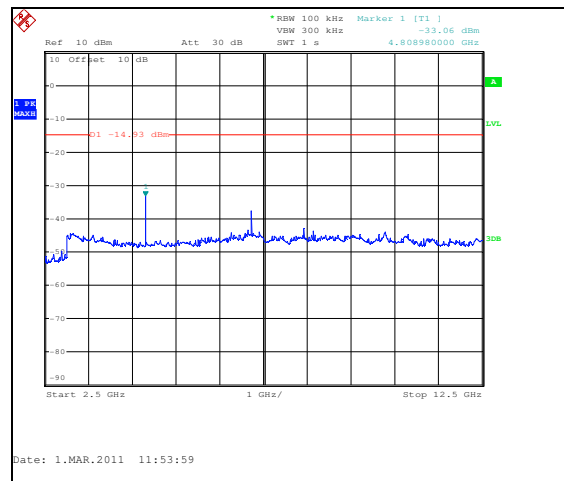

Figure 7.5.2.2-2: 2.5 GHz – 12.5 GHz – 2405MHz

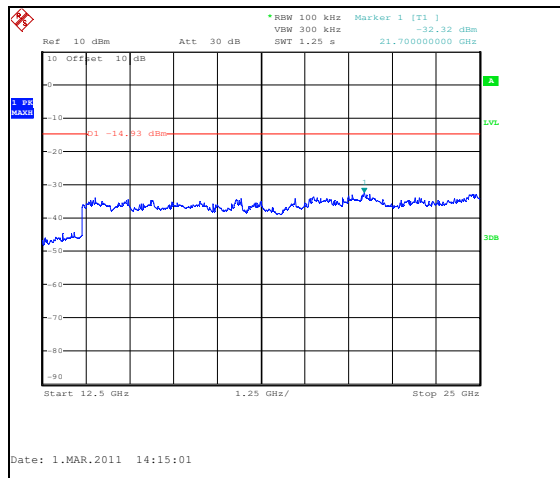

Figure 7.5.2.2-3: 12.5 GHz – 25 GHz – 2405MHz

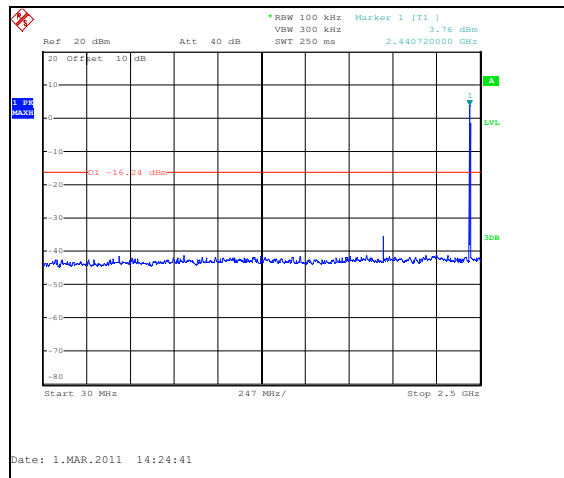

Figure 7.5.2.2-4: 30 MHz – 2.5 GHz – 2440MHz

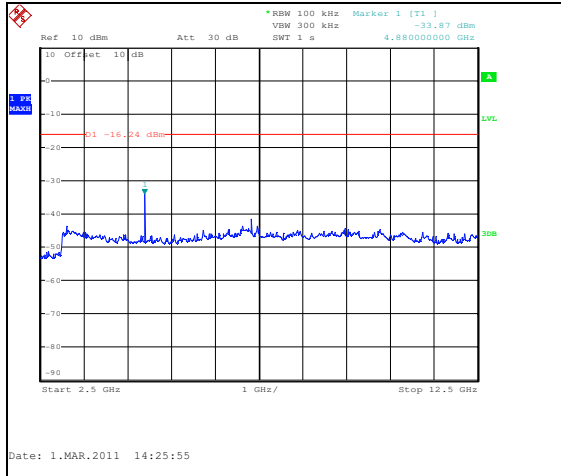

Figure 7.5.2.2-5: 2.5 GHz – 12.5 GHz – 2440MHz

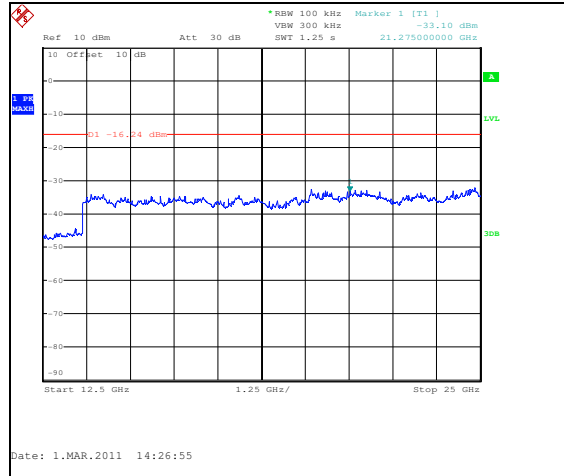

Figure 7.5.2.2-6: 12.5 GHz – 25 GHz – 2440MHz

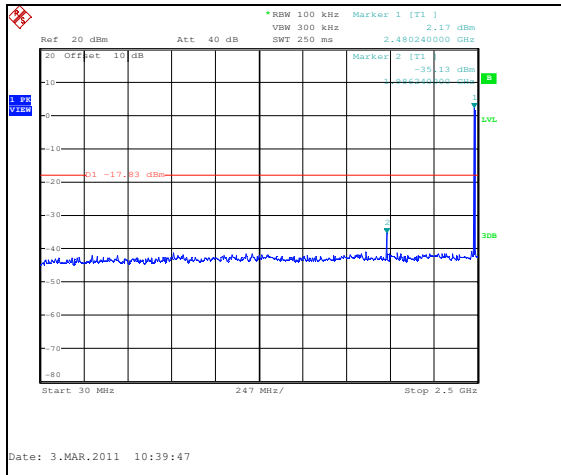

Figure 7.5.2.2-7: 30 MHz – 2.5 GHz – 2480MHz

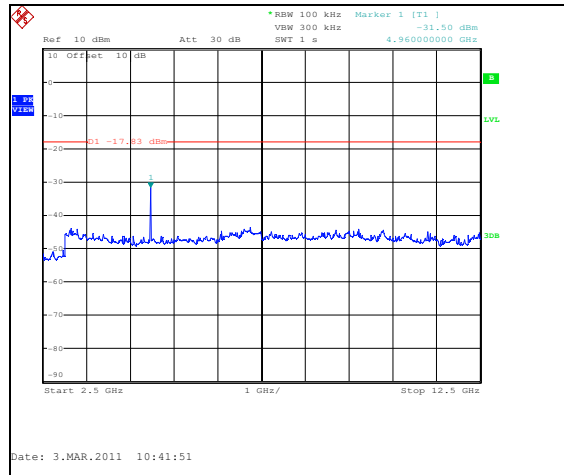

Figure 7.5.2.2-8: 2.5 GHz – 12.5 GHz – 2480MHz

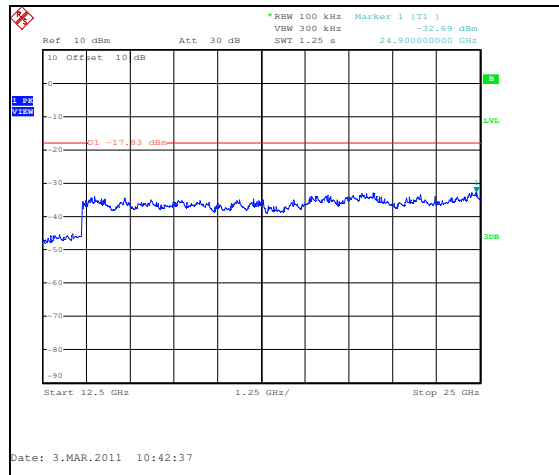

Figure 7.5.2.2-9: 12.5 GHz – 25 GHz – 2480MHz

**7.5.3 Radiated Spurious Emissions (Restricted Bands) - FCC Sec. 15.205 IC: RSS-210 2.6**

**7.5.3.1 Measurement Procedure**

Radiated emissions tests were made over the frequency range of 30MHz to 25 GHz, 10 times the highest fundamental frequency.

The EUT was rotated through 360° and the receive antenna height was varied from 1m to 4m so that the maximum radiated emissions level would be detected. For frequencies below 1000MHz, quasi-peak measurements were made using a resolution bandwidth RBW of 120 kHz and a video bandwidth VBW of 300 kHz. For frequencies above 1000MHz, peak and average measurements were made with RBW and VBW of 1 MHz and 3 MHz respectively. The average emissions were further corrected by applying the duty cycle correction of the EUT for comparison to the average limit.

Each emission found to be in a restricted band as defined by section 15.205 was compared to the radiated emission limits as defined in section 15.209.

**7.5.3.2 Duty Cycle Correction**

For average radiated measurements, using a 4.8% duty cycle, the measured level was reduced by a factor 26.4dB. The duty cycle correction factor is determined using the formula:  $20\log(4.8/100) = -26.4\text{dB}$ .

A detailed analysis of the duty cycle timing is provided in the Theory of Operation accompanying this report.

**7.5.3.3 Measurement Results**

Radiated spurious emissions found in the band of 30MHz to 25GHz are reported in the tables below.

**Table 7.5.3.3-1: Radiated Spurious Emissions Tabulated Data – Dipole Antenna**

Frequency (MHz)	Level (dBuV)		Antenna Polarity (H/V)	Correction Factors (dB)	Corrected Level (dBuV/m)		Limit (dBuV/m)		Margin (dB)	
	pk	Qpk/Avg			pk	Qpk/Avg	pk	Qpk/Avg	pk	Qpk/Avg
<b>Low Channel</b>										
4810	48.77	48.77	H	8.15	56.92	30.55	74.0	54.0	17.1	23.5
4810	57.32	57.32	V	8.15	65.47	39.10	74.0	54.0	8.5	14.9
<b>Middle Channel</b>										
4880	48.16	48.16	H	8.34	56.50	30.13	74.0	54.0	17.5	23.9
4880	57.32	57.32	V	8.34	65.66	39.29	74.0	54.0	8.3	14.7
7320	47.07	47.07	H	13.49	60.56	34.18	74.0	54.0	13.4	19.8
7320	49.91	49.91	V	13.49	63.40	37.02	74.0	54.0	10.6	17.0
<b>High Channel</b>										
4960	49.62	49.62	H	8.56	58.18	31.81	74.0	54.0	15.8	22.2
4960	59.71	59.71	V	8.56	68.27	41.90	74.0	54.0	5.7	12.1

\* Note: All emissions above 7320 MHz were attenuated below the permissible limit.

Table 7.5.3.3-2: Radiated Spurious Emissions Tabulated Data – Patch Antenna

Frequency (MHz)	Level (dBuV)		Antenna Polarity (H/V)	Correction Factors (dB)	Corrected Level (dBuV/m)		Limit (dBuV/m)		Margin (dB)	
	pk	Qpk/Avg			pk	Qpk/Avg	pk	Qpk/Avg	pk	Qpk/Avg
<b>Low Channel</b>										
4810	55.70	55.70	H	8.11	63.81	37.44	74.0	54.0	10.2	16.6
4810	54.00	54.00	V	8.11	62.11	35.74	74.0	54.0	11.9	18.3
<b>Middle Channel</b>										
4880	56.79	56.79	H	8.31	65.10	38.72	74.0	54.0	8.9	15.3
4880	54.18	54.18	V	8.31	62.49	36.11	74.0	54.0	11.5	17.9
7320	46.48	46.48	H	13.54	60.02	33.65	74.0	54.0	14.0	20.4
7320	50.42	50.42	V	13.54	63.96	37.59	74.0	54.0	10.0	16.4
<b>High Channel</b>										
4960	59.51	59.51	H	8.53	68.04	41.66	74.0	54.0	6.0	12.3
4960	61.24	61.24	V	8.53	69.77	43.39	74.0	54.0	4.2	10.6
7440	46.41	46.41	V	13.69	60.10	33.73	74.0	54.0	13.9	20.3

\* Note: All emissions above 7440 MHz were attenuated below the permissible limit.

#### 7.5.3.4 Sample Calculation:

$$R_C = R_U + CF_T$$

Where:

- $CF_T$  = Total Correction Factor (AF+CA+AG)-DC (Average Measurements Only)  
 $R_U$  = Uncorrected Reading  
 $R_C$  = Corrected Level  
 AF = Antenna Factor  
 CA = Cable Attenuation  
 AG = Amplifier Gain  
 DC = Duty Cycle Correction Factor

#### Example Calculation: Peak

Corrected Level:  $48.77 + 8.15 = 56.92\text{dBuV/m}$

Margin:  $74\text{dBuV/m} - 56.92\text{dBuV/m} = 17.1\text{dB}$

#### Example Calculation: Average

Corrected Level:  $48.77 + 8.15 - 26.4 = 30.55\text{dBuV}$

Margin:  $54\text{dBuV} - 30.55\text{dBuV} = 23.5\text{dB}$

7.6 Peak Power Spectral Density- FCC Section 15.247(e) IC: RSS-210 A8.2(b)

7.6.1 Measurement Procedure

The power spectral density was measured in accordance with the FCC KDB Publication No. 558074 "Guidance on Measurements for Digital Transmission Systems (47 CFR 15.247)". The emission peaks within the pass band were located and zoomed in on. The spectrum analyzer RBW was set to 3 kHz and VBW 10 kHz. Span was adjusted to 200 kHz and the sweep time was calculated to be 68s ~ (Span/3 kHz).

7.6.2 Measurement Results

Results are shown below in table 7.6.2-1 and figures 7.6.2-1 – 7.6.2-3:

Table 7.6.2-1: Peak Power Spectral Density

Frequency (MHz)	PSD Level (dBm)
2405	-3.15
2440	-3.98
2480	-5.51

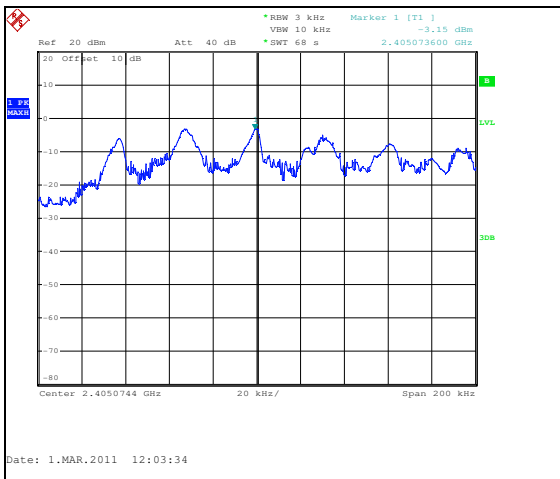

Figure 7.6.2-1: Power Spectral Density Plot – 2405MHz

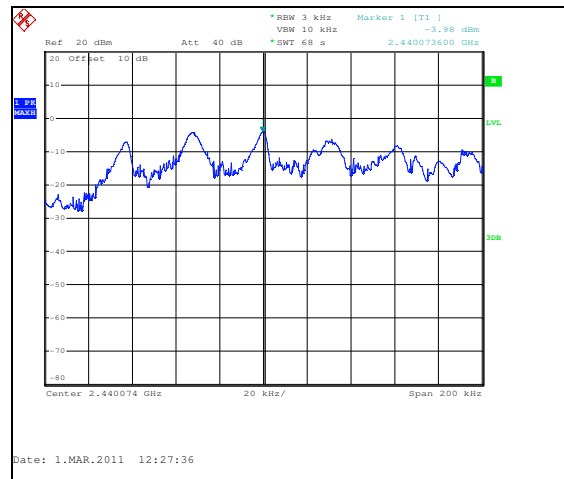

Figure 7.6.2-2: Power Spectral Density Plot – 2440MHz

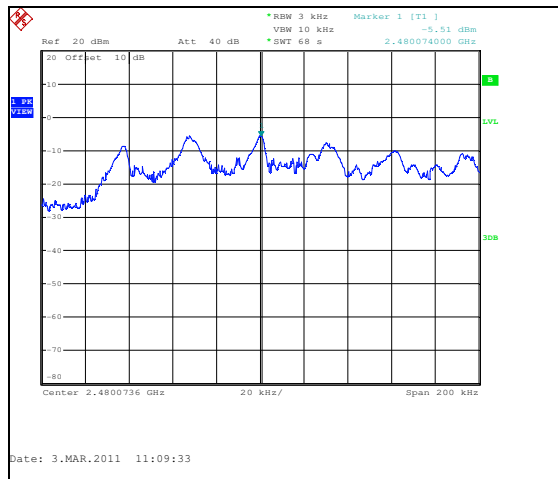

Figure 7.6.2-3: Power Spectral Density Plot – 2480MHz

## **8 CONCLUSION**

In the opinion of ACS, Inc. the XDM2510HP and XDM2510HC, manufactured by RFM/Cirronet meet the requirements of FCC Part 15 subpart C and Industry Canada's Radio Standards Specification RSS-210.

**END REPORT**