

Report Number :TERF2304001037E2
 Operation Mode :CatM1 B71
 Test Mode :Tx
 EUT Pol :E2 Plane
 Test Frequency :688 MHz

Test Site :SAC C
 Test Date :2023-05-24
 Temp./Humi. :25.0°C/60%
 Antenna Pol. :Horizontal
 Engineer :Andy Wang

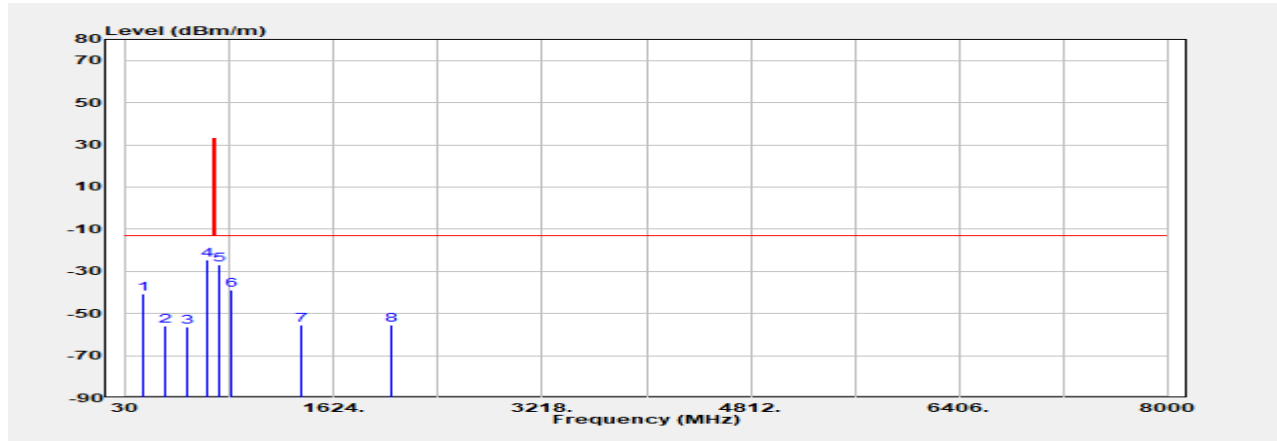

Freq. MHz	EIRP/ERP dBm	SG Output Level dBm	Antenna Gain dBi/dBd	Cable Loss dB	Limit dBm	Margin dB
159.010	-40.66	-38.34	-1.51	-0.81	-13.00	-27.66
326.820	-56.07	-59.00	4.01	-1.08	-13.00	-43.07
498.510	-56.39	-59.57	4.41	-1.23	-13.00	-43.39
649.830	-24.64	-26.95	3.91	-1.60	-13.00	-11.64
744.890	-26.91	-29.02	3.70	-1.59	-13.00	-13.91
838.980	-38.89	-40.89	3.86	-1.86	-13.00	-25.89
1376.000	-55.63	-58.79	7.31	-4.15	-13.00	-42.63
2064.000	-55.46	-60.26	10.12	-5.32	-13.00	-42.46

Unless otherwise stated the results shown in this test report refer only to the sample(s) tested and such sample(s) are retained for 90 days only.

除非另有說明，此報告結果僅對測試之樣品負責，同時此樣品僅保留90天。本報告未經本公司書面許可，不可部份複製。

This document is issued by the Company subject to its General Conditions of Service printed overleaf, available on request or accessible at <http://www.sgs.com.tw/Terms-and-Conditions> and for electronic format documents, subject to Terms and Conditions for Electronic Documents at <http://www.sgs.com.tw/Terms-and-Conditions>. Attention is drawn to the limitation of liability, indemnification and jurisdiction issues defined therein. Any holder of this document is advised that information contained hereon reflects the Company's findings at the time of its intervention only and within the limits of Client's instructions, if any. The Company's sole responsibility is to its Client and this document does not exonerate parties to a transaction from exercising all their rights and obligations under the transaction documents. This document cannot be reproduced except in full, without prior written approval of the Company. Any unauthorized alteration, forgery or falsification of the content or appearance of this document is unlawful and offenders may be prosecuted to the fullest extent of the law.

11 FREQUENCY STABILITY MEASUREMENT

11.1 Standard Applicable

The frequency stability shall be sufficient to ensure that the fundamental emission stays within the authorized frequency block.

11.2 Test Set-up

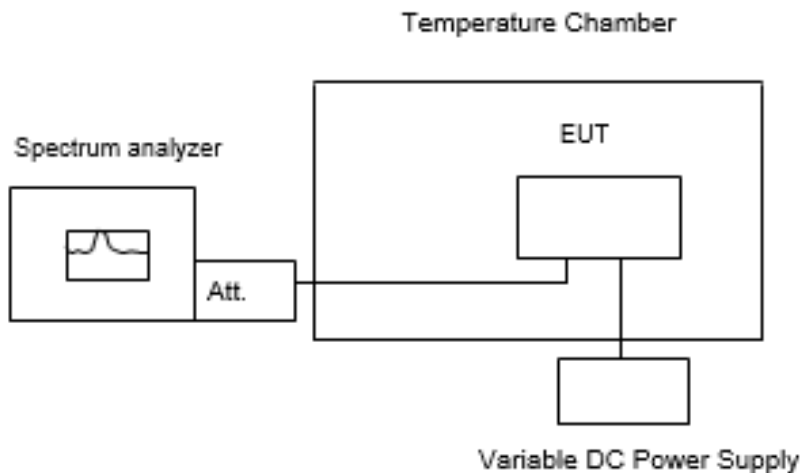

Note: Measurement setup for testing on Antenna connector

11.3 Measurement Procedure

The equipment under test was connected to an external AC or DC power supply and input rated voltage. RF output was connected to a frequency counter or spectrum analyzer via feed through attenuators. The EUT was placed inside the temperature chamber. Set the spectrum analyzer RBW low enough to obtain the desired frequency resolution and measure EUT 25°C operating frequency as reference frequency. Turn EUT off and set the chamber temperature to -30°C. After the temperature stabilized for approximately 30 minutes recorded the frequency. Repeat step measure with 10°C increased per stage until the highest temperature of +50°C reached.

Set chamber temperature to 25°C. Use a variable AC power supply / DC power source to power the EUT and set the voltage to rated voltage. Set the spectrum analyzer RBW low enough to obtain the desired frequency resolution and recorded the frequency.

Reduce the input voltage to specify extreme voltage variation (+/- 15%) and endpoint as declared by the manufacturer, record the maximum frequency change.

11.4 Measurement Result

Note: The power supply is rated 3.6V dc.

Unless otherwise stated the results shown in this test report refer only to the sample(s) tested and such sample(s) are retained for 90 days only.
除非另有說明，此報告結果僅對測試之樣品負責，同時此樣品僅保留90天。本報告未經本公司書面許可，不可部份複製。

This document is issued by the Company subject to its General Conditions of Service printed overleaf, available on request or accessible at <http://www.sgs.com.tw/Terms-and-Conditions> and for electronic format documents, subject to Terms and Conditions for Electronic Documents at <http://www.sgs.com.tw/Terms-and-Conditions>. Attention is drawn to the limitation of liability, indemnification and jurisdiction issues defined therein. Any holder of this document is advised that information contained hereon reflects the Company's findings at the time of its intervention only and within the limits of Client's instructions, if any. The Company's sole responsibility is to its Client and this document does not exonerate parties to a transaction from exercising all their rights and obligations under the transaction documents. This document cannot be reproduced except in full, without prior written approval of the Company. Any unauthorized alteration, forgery or falsification of the content or appearance of this document is unlawful and offenders may be prosecuted to the fullest extent of the law.

11.4.1 Cat M1

Reference Freq.:	Cat-M1 B66 Mid Channel		1745.0000	MHz 10M QPSK CH 132322
Power Supply Vdc	Temp. (°C)	Freq. (MHz)	(ppm)	Limit
Freq. ERROR vs. VOLTAGE				
4.14	25	1745.000002	0.0012	+/- 2.5 ppm
3.6	25	1745.000003	0.0019	
3.06	25	1744.999999	-0.0003	
2.2	25	1745.000002	0.0011	
(End Point)				
Freq. ERROR vs. Temp.				
3.6	-30	1744.999999	-0.0005	+/- 2.5 ppm
3.6	-20	1745.000003	0.0014	
3.6	-10	1745.000004	0.0021	
3.6	0	1745.000006	0.0032	
3.6	10	1744.999995	-0.0027	
3.6	20	1745.000004	0.0022	
3.6	30	1744.999998	-0.0011	
3.6	40	1745.000001	0.0003	
3.6	50	1745.000004	0.0024	
Freq. ERROR vs. Temp.				
Reference Freq.:	Cat-M1 B71 Mid Channel		680.5000	MHz 10M QPSK CH 133297
Power Supply Vdc	Temp. (°C)	Freq. (MHz)	(ppm)	Limit
Freq. ERROR vs. VOLTAGE				
4.14	25	680.500000	0.0000	+/- 2.5 ppm
3.6	25	680.499999	-0.0018	
3.06	25	680.500002	0.0034	
2.2	25	680.500005	0.0075	
(End Point)				
Freq. ERROR vs. Temp.				
3.6	-30	680.500001	0.0013	+/- 2.5 ppm
3.6	-20	680.500004	0.0056	
3.6	-10	680.500004	0.0060	
3.6	0	680.500003	0.0047	
3.6	10	680.500002	0.0028	
3.6	20	680.499998	-0.0035	
3.6	30	680.499998	-0.0026	
3.6	40	680.499999	-0.0016	
3.6	50	680.500004	0.0063	

Unless otherwise stated the results shown in this test report refer only to the sample(s) tested and such sample(s) are retained for 90 days only.

除非另有說明，此報告結果僅對測試之樣品負責，同時此樣品僅保留90天。本報告未經本公司書面許可，不可部份複製。

This document is issued by the Company subject to its General Conditions of Service printed overleaf, available on request or accessible at <http://www.sgs.com.tw/Terms-and-Conditions> and for electronic format documents, subject to Terms and Conditions for Electronic Documents at <http://www.sgs.com.tw/Terms-and-Conditions>. Attention is drawn to the limitation of liability, indemnification and jurisdiction issues defined therein. Any holder of this document is advised that information contained hereon reflects the Company's findings at the time of its intervention only and within the limits of Client's instructions, if any. The Company's sole responsibility is to its Client and this document does not exonerate parties to a transaction from exercising all their rights and obligations under the transaction documents. This document cannot be reproduced except in full, without prior written approval of the Company. Any unauthorized alteration, forgery or falsification of the content or appearance of this document is unlawful and offenders may be prosecuted to the fullest extent of the law.

12 PEAK TO AVERAGE RATIO

12.1 Standard Applicable

The peak-to-average ratio (PAR) of the transmission may not exceed 13dB.

12.2 Test SET-UP

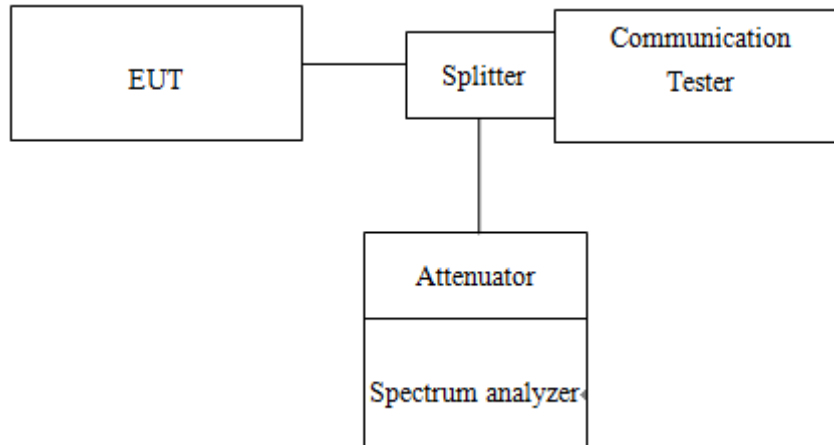

12.3 Measurement Procedure

1. KDB 971168 D01 is employed as the following procedure is proper adjusted accordingly:
2. Set resolution/measurement bandwidth \geq signal's occupied bandwidth; & internal =1ms
3. Set the number of counts to a value that stabilizes the measured CCDF curve.

Unless otherwise stated the results shown in this test report refer only to the sample(s) tested and such sample(s) are retained for 90 days only.
 除非另有說明，此報告結果僅對測試之樣品負責，同時此樣品僅保留90天。本報告未經本公司書面許可，不可部份複製。

This document is issued by the Company subject to its General Conditions of Service printed overleaf, available on request or accessible at <http://www.sgs.com.tw/Terms-and-Conditions> and for electronic format documents, subject to Terms and Conditions for Electronic Documents at <http://www.sgs.com.tw/Terms-and-Conditions>. Attention is drawn to the limitation of liability, indemnification and jurisdiction issues defined therein. Any holder of this document is advised that information contained hereon reflects the Company's findings at the time of its intervention only and within the limits of Client's instructions, if any. The Company's sole responsibility is to its Client and this document does not exonerate parties to a transaction from exercising all their rights and obligations under the transaction documents. This document cannot be reproduced except in full, without prior written approval of the Company. Any unauthorized alteration, forgery or falsification of the content or appearance of this document is unlawful and offenders may be prosecuted to the fullest extent of the law.

12.4 Measurement Result

12.4.1 Cat M1

Cat-M1 BAND 66							
Channel bandwidth: 1.4MHz				Channel bandwidth: 3MHz			
Freq. (MHz)	CH	PAPR (dB)		Freq. (MHz)	CH	PAPR (dB)	
		16QAM	Limit			16QAM	Limit
1710.7	131979	5.93	13	1711.5	131987	6.16	13
1745.0	132322	5.97	13	1745.0	132322	5.45	13
1779.3	132665	7.36	13	1778.5	132657	5.75	13
Cat-M1 BAND 66							
Channel bandwidth: 5MHz				Channel bandwidth: 10MHz			
Freq. (MHz)	CH	PAPR (dB)		Freq. (MHz)	CH	PAPR (dB)	
		16QAM	Limit			16QAM	Limit
1712.5	131997	5.89	13	1715.0	132022	6.19	13
1745.0	132322	5.95	13	1745.0	132322	10.17	13
1777.5	132647	8.30	13	1775.0	132622	6.72	13
Cat-M1 BAND 66							
Channel bandwidth: 15MHz				Channel bandwidth: 20MHz			
Freq. (MHz)	CH	PAPR (dB)		Freq. (MHz)	CH	PAPR (dB)	
		16QAM	Limit			16QAM	Limit
1717.5	132047	5.05	13	1720.0	132072	5.52	13
1745.0	132322	5.63	13	1745.0	132322	4.55	13
1772.5	132597	4.85	13	1770.0	132572	4.48	13
Cat-M1 BAND 71							
Channel bandwidth: 5MHz				Channel bandwidth: 10MHz			
Freq. (MHz)	CH	PAPR (dB)		Freq. (MHz)	CH	PAPR (dB)	
		16QAM	Limit			16QAM	Limit
665.5	133147	7.86	13	668.0	133172	6.98	13
680.5	133297	7.46	13	680.5	133297	6.80	13
695.5	133447	7.46	13	693.0	133422	6.79	13
Cat-M1 BAND 71							
Channel bandwidth: 15MHz				Channel bandwidth: 20MHz			
Freq. (MHz)	CH	PAPR (dB)		Freq. (MHz)	CH	PAPR (dB)	
		16QAM	Limit			16QAM	Limit
670.5	133197	7.06	13	673.0	133222	6.24	13
680.5	133297	6.26	13	680.5	133297	6.27	13
690.5	133397	6.05	13	688.0	133372	6.09	13

Unless otherwise stated the results shown in this test report refer only to the sample(s) tested and such sample(s) are retained for 90 days only.

除非另有說明，此報告結果僅對測試之樣品負責，同時此樣品僅保留90天。本報告未經本公司書面許可，不可部份複製。

This document is issued by the Company subject to its General Conditions of Service printed overleaf, available on request or accessible at <http://www.sgs.com.tw/Terms-and-Conditions>, and for electronic format documents, subject to Terms and Conditions for Electronic Documents at <http://www.sgs.com.tw/Terms-and-Conditions>. Attention is drawn to the limitation of liability, indemnification and jurisdiction issues defined therein. Any holder of this document is advised that information contained hereon reflects the Company's findings at the time of its intervention only and within the limits of Client's instructions, if any. The Company's sole responsibility is to its Client and this document does not exonerate parties to a transaction from exercising all their rights and obligations under the transaction documents. This document cannot be reproduced except in full, without prior written approval of the Company. Any unauthorized alteration, forgery or falsification of the content or appearance of this document is unlawful and offenders may be prosecuted to the fullest extent of the law.

Cat-M1 Band66_1.4MHz_16QAM_RB6_0_CH131979

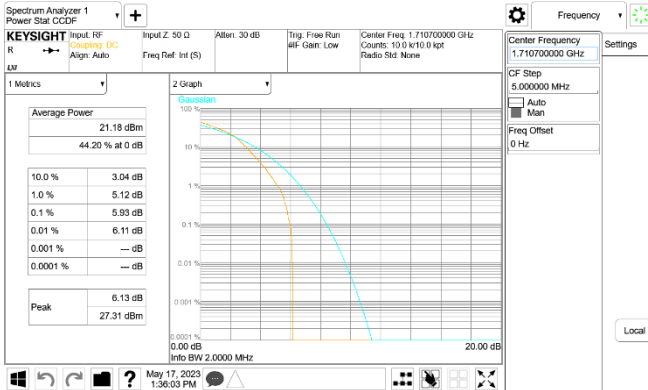

Cat-M1 Band66_3MHz_16QAM_RB6_0_CH131987

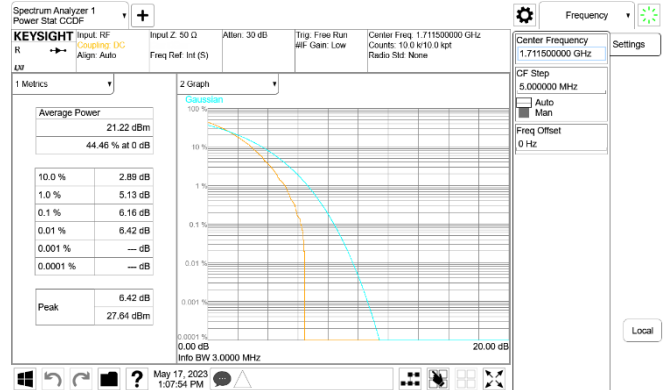

Cat-M1 Band66_1.4MHz_16QAM_RB6_0_CH132322

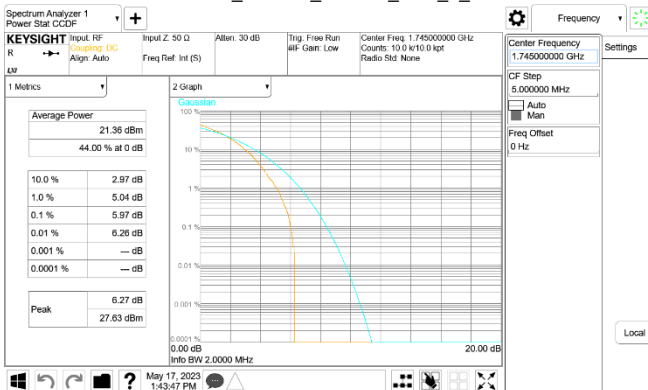

Cat-M1 Band66_3MHz_16QAM_RB6_0_CH132322

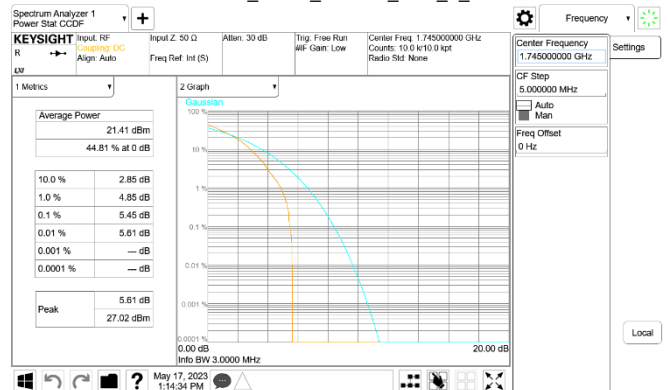

Cat-M1 Band66_1.4MHz_16QAM_RB6_0_CH132665

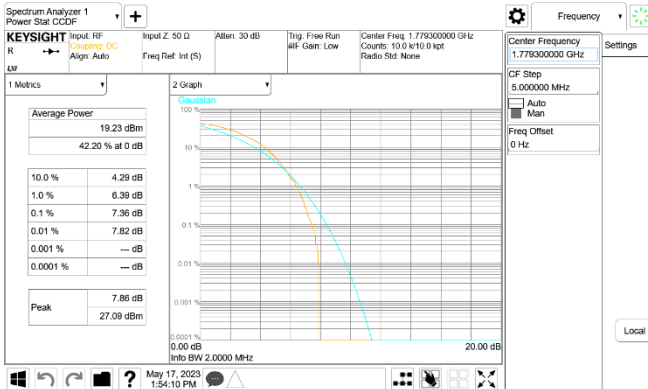

Cat-M1 Band66_3MHz_16QAM_RB6_0_CH132657

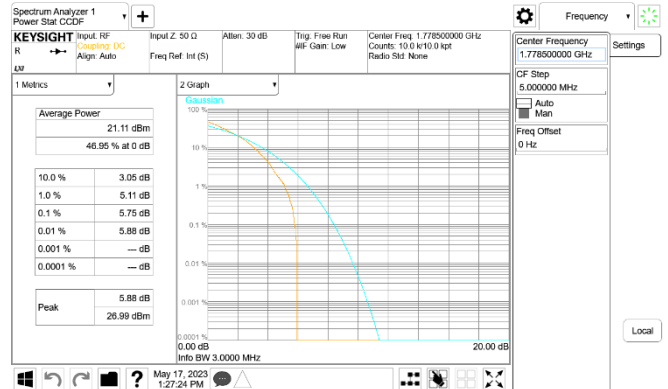

Unless otherwise stated the results shown in this test report refer only to the sample(s) tested and such sample(s) are retained for 90 days only.

除非另有說明，此報告結果僅對測試之樣品負責，同時此樣品僅保留90天。本報告未經本公司書面許可，不可部份複製。

This document is issued by the Company subject to its General Conditions of Service printed overleaf, available on request or accessible at <http://www.sgs.com.tw/Terms-and-Conditions>, and for electronic format documents, subject to Terms and Conditions for Electronic Documents at <http://www.sgs.com.tw/Terms-and-Conditions>. Attention is drawn to the limitation of liability, indemnification and jurisdiction issues defined therein. Any holder of this document is advised that information contained hereon reflects the Company's findings at the time of its intervention only and within the limits of Client's instructions, if any. The Company's sole responsibility is to its Client and this document does not exonerate parties to a transaction from exercising all their rights and obligations under the transaction documents. This document cannot be reproduced except in full, without prior written approval of the Company. Any unauthorized alteration, forgery or falsification of the content or appearance of this document is unlawful and offenders may be prosecuted to the fullest extent of the law.

Cat-M1 Band66_5MHz_16QAM_RB6_0_CH131997

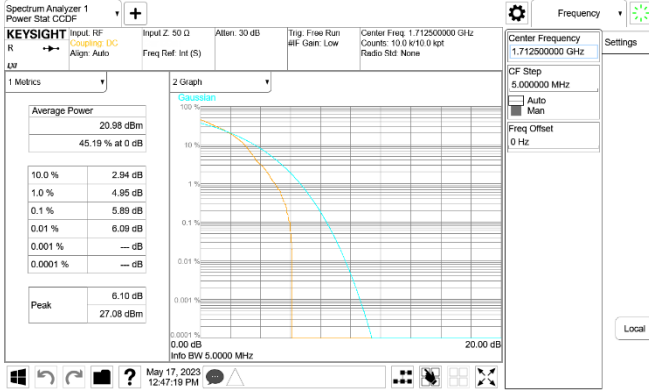

Cat-M1 Band66_10MHz_16QAM_RB6_0_CH132022

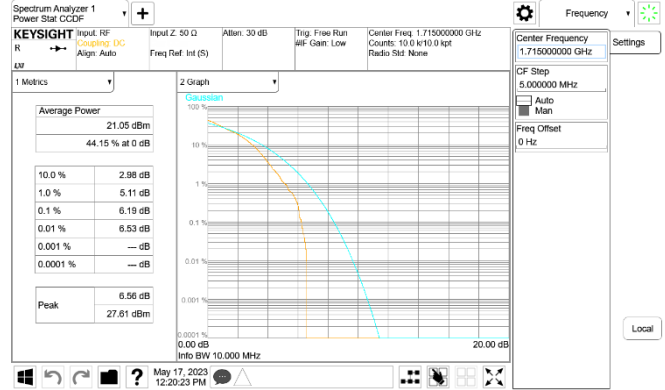

Cat-M1 Band66_5MHz_16QAM_RB6_0_CH132322

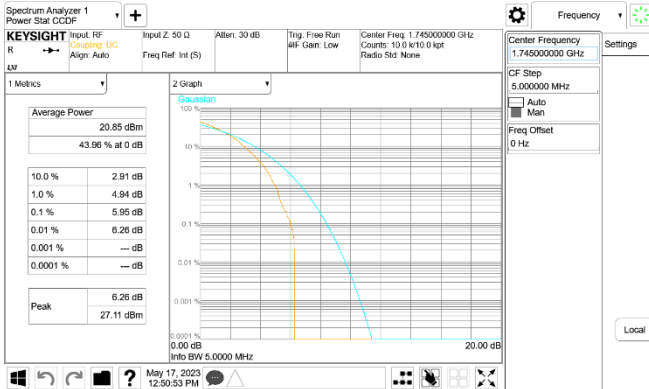

Cat-M1 Band66_10MHz_16QAM_RB6_0_CH132322

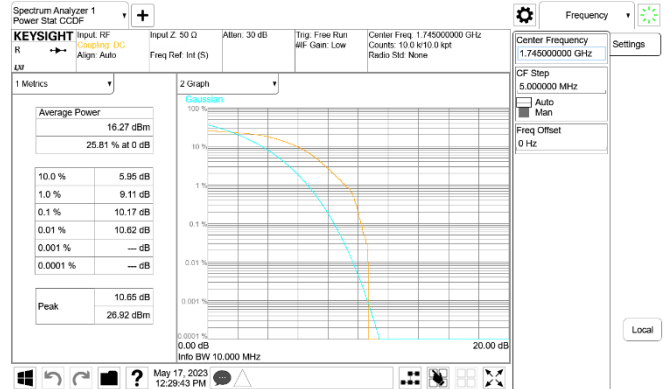

Cat-M1 Band66_5MHz_16QAM_RB6_0_CH132647

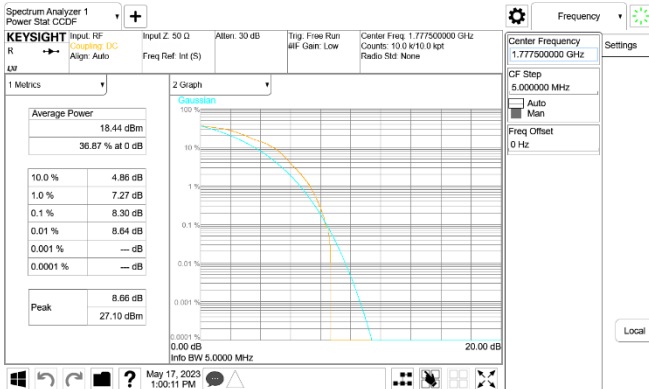

Cat-M1 Band66_10MHz_16QAM_RB6_0_CH132622

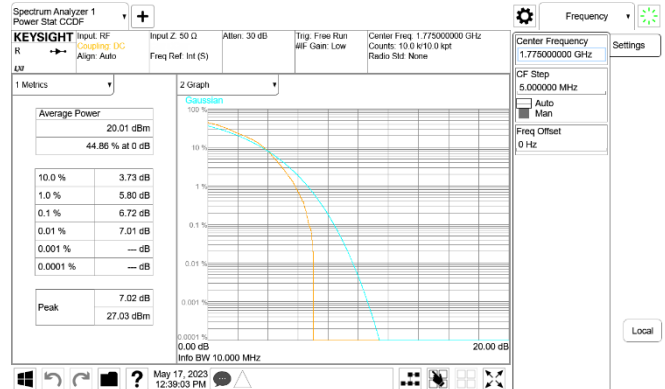

Unless otherwise stated the results shown in this test report refer only to the sample(s) tested and such sample(s) are retained for 90 days only.

除非另有說明，此報告結果僅對測試之樣品負責，同時此樣品僅保留90天。本報告未經本公司書面許可，不可部份複製。

This document is issued by the Company subject to its General Conditions of Service printed overleaf, available on request or accessible at <http://www.sgs.com.tw/Terms-and-Conditions>, and for electronic format documents, subject to Terms and Conditions for Electronic Documents at <http://www.sgs.com.tw/Terms-and-Conditions>. Attention is drawn to the limitation of liability, indemnification and jurisdiction issues defined therein. Any holder of this document is advised that information contained hereon reflects the Company's findings at the time of its intervention only and within the limits of Client's instructions, if any. The Company's sole responsibility is to its Client and this document does not exonerate parties to a transaction from exercising all their rights and obligations under the transaction documents. This document cannot be reproduced except in full, without prior written approval of the Company. Any unauthorized alteration, forgery or falsification of the content or appearance of this document is unlawful and offenders may be prosecuted to the fullest extent of the law.

Cat-M1 Band66_15MHz_16QAM_RB6_0_CH132047

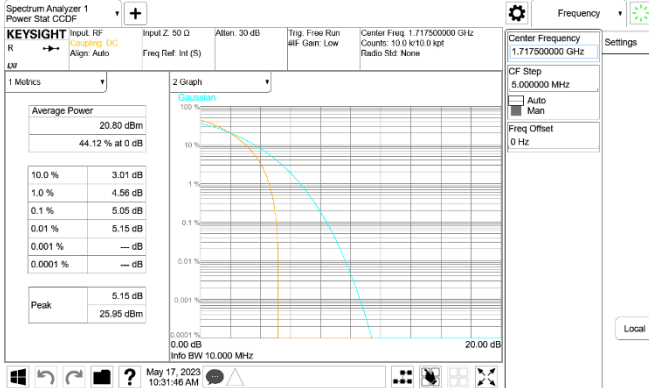

Cat-M1 Band66_20MHz_16QAM_RB6_0_CH132072

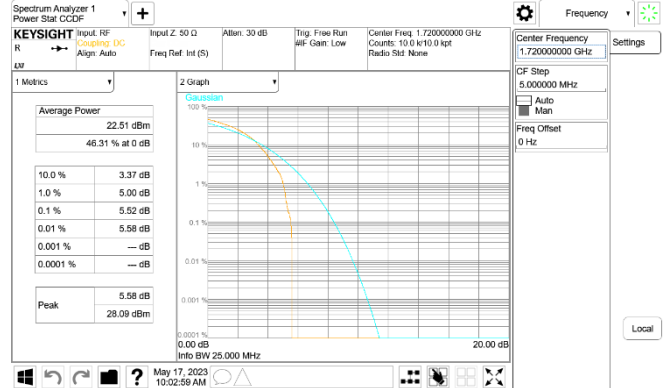

Cat-M1 Band66_15MHz_16QAM_RB6_0_CH132322

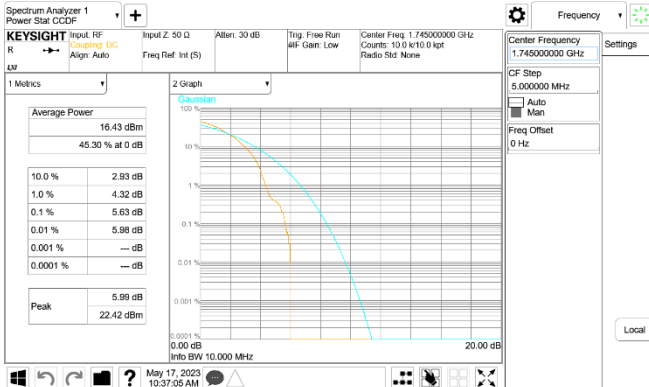

Cat-M1 Band66_20MHz_16QAM_RB6_0_CH132322

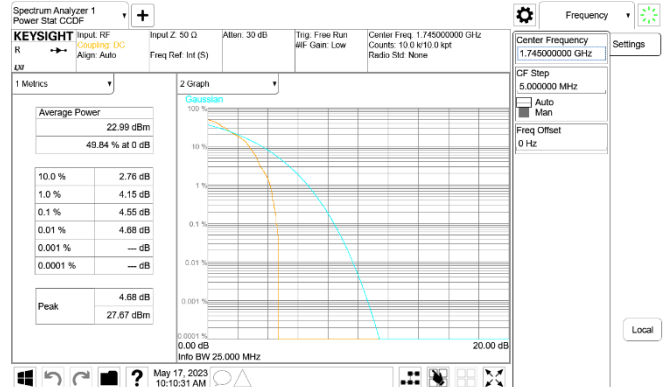

Cat-M1 Band66_15MHz_16QAM_RB6_0_CH132597

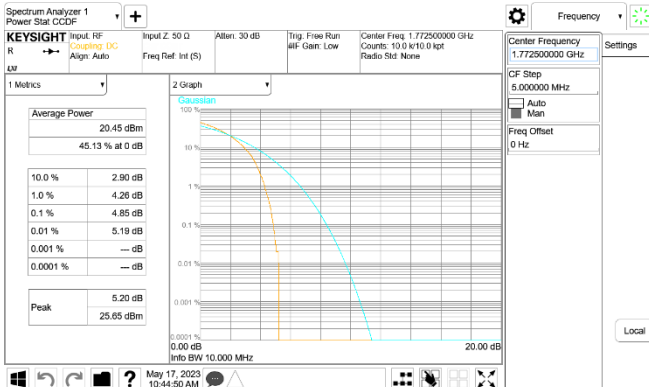

Cat-M1 Band66_20MHz_16QAM_RB6_0_CH132572

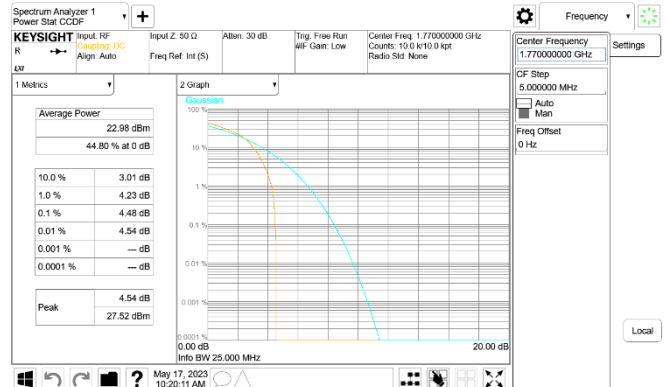

Unless otherwise stated the results shown in this test report refer only to the sample(s) tested and such sample(s) are retained for 90 days only.

除非另有說明，此報告結果僅對測試之樣品負責，同時此樣品僅保留90天。本報告未經本公司書面許可，不可部份複製。

This document is issued by the Company subject to its General Conditions of Service printed overleaf, available on request or accessible at <http://www.sgs.com.tw/Terms-and-Conditions>, and for electronic format documents, subject to Terms and Conditions for Electronic Documents at <http://www.sgs.com.tw/Terms-and-Conditions>. Attention is drawn to the limitation of liability, indemnification and jurisdiction issues defined therein. Any holder of this document is advised that information contained hereon reflects the Company's findings at the time of its intervention only and within the limits of Client's instructions, if any. The Company's sole responsibility is to its Client and this document does not exonerate parties to a transaction from exercising all their rights and obligations under the transaction documents. This document cannot be reproduced except in full, without prior written approval of the Company. Any unauthorized alteration, forgery or falsification of the content or appearance of this document is unlawful and offenders may be prosecuted to the fullest extent of the law.

Cat-M1 Band71_5MHz_16QAM_RB6_0_CH133147

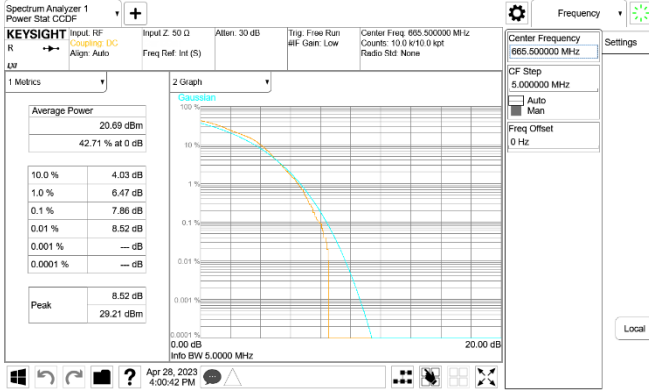

Cat-M1 Band71_10MHz_16QAM_RB6_0_CH133172

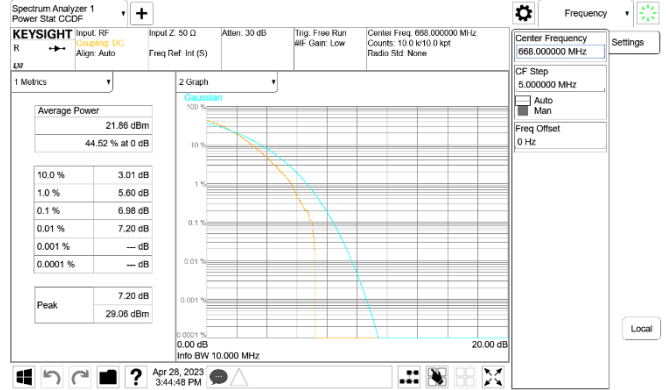

Cat-M1 Band71_5MHz_16QAM_RB6_0_CH133297

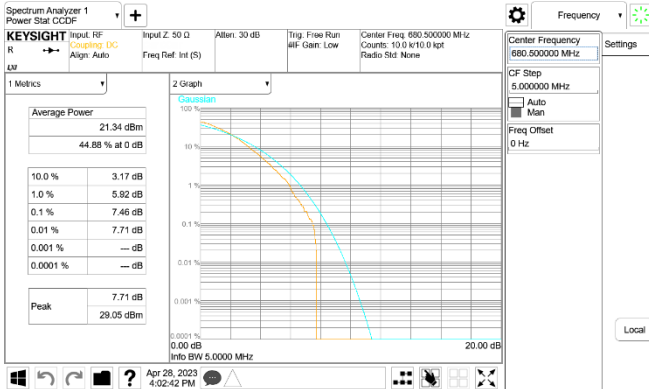

Cat-M1 Band71_10MHz_16QAM_RB6_0_CH133297

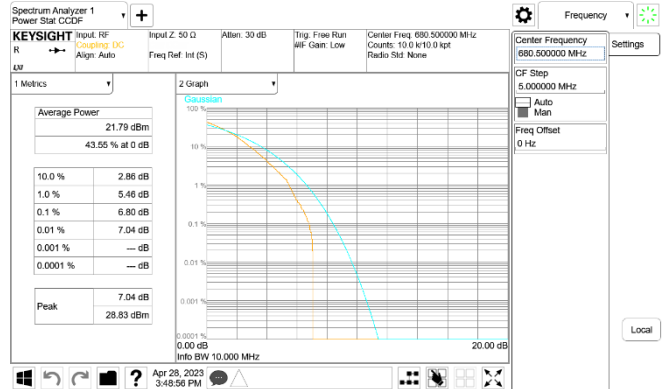

Cat-M1 Band71_5MHz_16QAM_RB6_0_CH133447

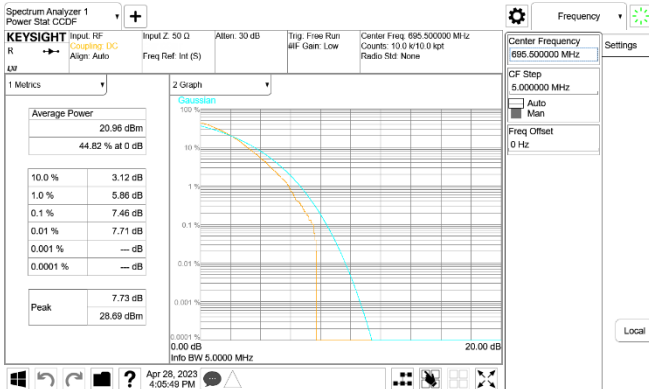

Cat-M1 Band71_10MHz_16QAM_RB6_0_CH133422

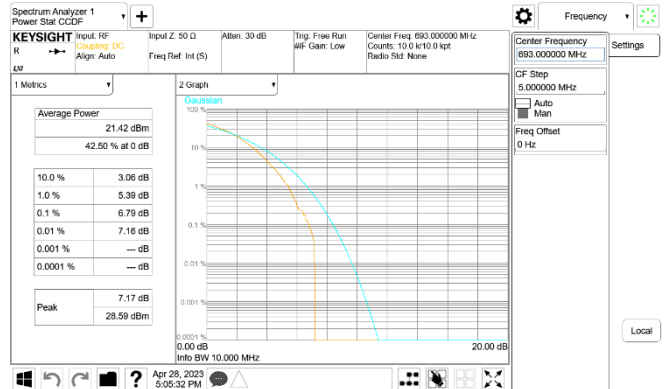

Unless otherwise stated the results shown in this test report refer only to the sample(s) tested and such sample(s) are retained for 90 days only.

除非另有說明，此報告結果僅對測試之樣品負責，同時此樣品僅保留90天。本報告未經本公司書面許可，不可部份複製。

This document is issued by the Company subject to its General Conditions of Service printed overleaf, available on request or accessible at <http://www.sgs.com.tw/Terms-and-Conditions>, and for electronic format documents, subject to Terms and Conditions for Electronic Documents at <http://www.sgs.com.tw/Terms-and-Conditions>. Attention is drawn to the limitation of liability, indemnification and jurisdiction issues defined therein. Any holder of this document is advised that information contained hereon reflects the Company's findings at the time of its intervention only and within the limits of Client's instructions, if any. The Company's sole responsibility is to its Client and this document does not exonerate parties to a transaction from exercising all their rights and obligations under the transaction documents. This document cannot be reproduced except in full, without prior written approval of the Company. Any unauthorized alteration, forgery or falsification of the content or appearance of this document is unlawful and offenders may be prosecuted to the fullest extent of the law.

Cat-M1 Band71_15MHz_16QAM_RB6_0_CH133197

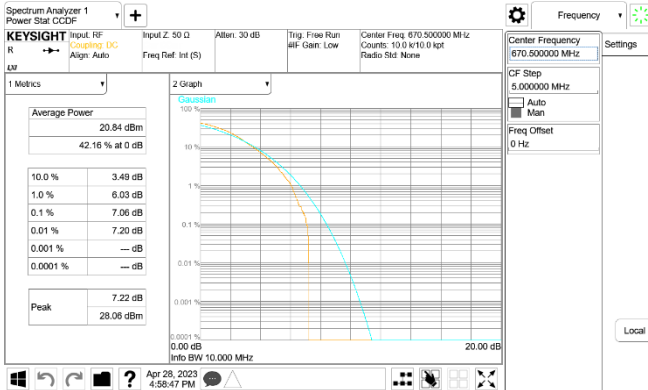

Cat-M1 Band71_20MHz_16QAM_RB6_0_CH133222

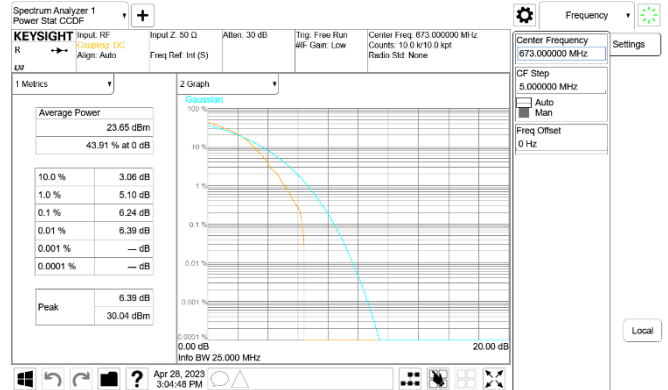

Cat-M1 Band71_15MHz_16QAM_RB6_0_CH133297

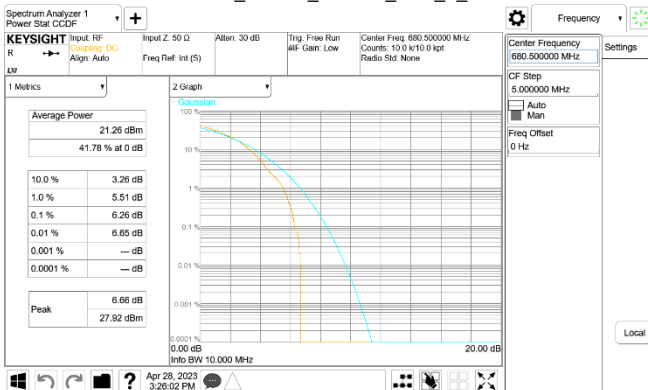

Cat-M1 Band71_20MHz_16QAM_RB6_0_CH133297

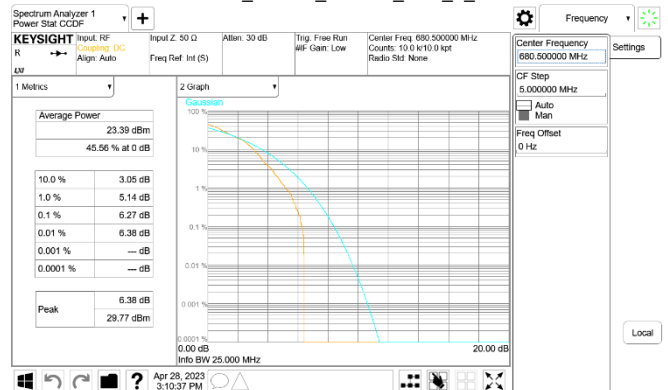

Cat-M1 Band71_15MHz_16QAM_RB6_0_CH133397

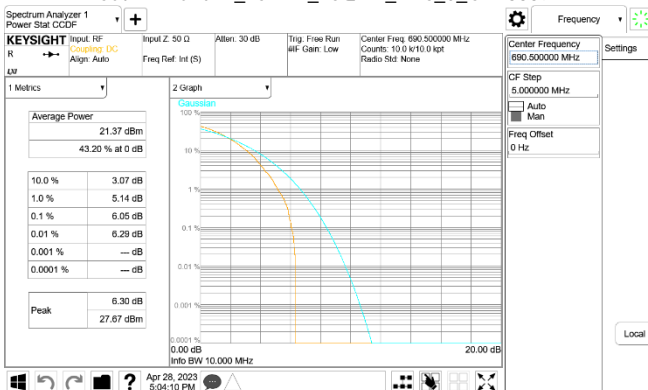

Cat-M1 Band71_20MHz_16QAM_RB6_0_CH133372

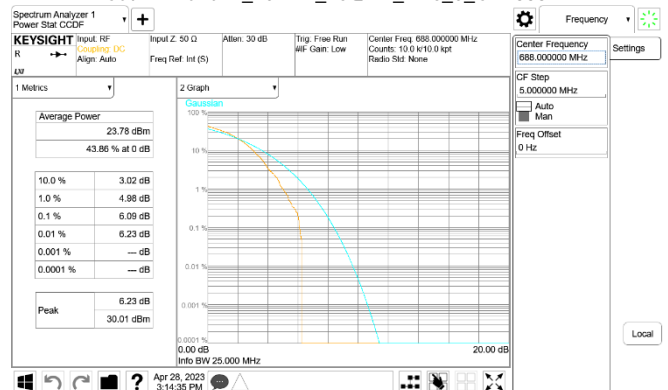

~ End of Report ~

Unless otherwise stated the results shown in this test report refer only to the sample(s) tested and such sample(s) are retained for 90 days only.

除非另有說明，此報告結果僅對測試之樣品負責，同時此樣品僅保留90天。本報告未經本公司書面許可，不可部份複製。

This document is issued by the Company subject to its General Conditions of Service printed overleaf, available on request or accessible at <http://www.sgs.com.tw/Terms-and-Conditions> and for electronic format documents, subject to Terms and Conditions for Electronic Documents at <http://www.sgs.com.tw/Terms-and-Conditions>. Attention is drawn to the limitation of liability, indemnification and jurisdiction issues defined therein. Any holder of this document is advised that information contained hereon reflects the Company's findings at the time of its intervention only and within the limits of Client's instructions, if any. The Company's sole responsibility is to its Client and this document does not exonerate parties to a transaction from exercising all their rights and obligations under the transaction documents. This document cannot be reproduced except in full, without prior written approval of the Company. Any unauthorized alteration, forgery or falsification of the content or appearance of this document is unlawful and offenders may be prosecuted to the fullest extent of the law.