

**DTN**  
**WIRELESS**  
CORPORATION

# HOPNET USER'S GUIDE

## Operational and Safety Notes

---

### FCC Notice, U.S.A.

All HopNet products comply with Part 15 of the FCC Rules. Operation is subject to the following conditions:

- This device may not cause harmful interference, and this device must accept any interference received, including interference that may cause undesired operation.
- This device is specifically designed to be used under Section 15.203 of the FCC Rules and Regulations. Any unauthorized modifications or changes to this device may void the user's authority to operate.
- This device is intended to be used only when professionally installed. Failure to comply with these instructions may also void the user's authority to operate this device.

### European Community Notice

This device complies with ETS 300.328 of the European Community. Operation is subject to the following conditions:

- This device may not cause interference.
- This device must accept interference, including undesired interference that may impede the operation of this device.

### RF Exposure

**WARNING:** End Users of these systems must be informed that RF exposure limits may be exceeded if personnel come closer than 45 cm to the antenna aperture when exceeding 9 dBi of gain in conjunction with the transceiver.

### Repairs

Field repairs of the radio equipment are not recommended by DWC. SMT has been used in the production of the transceiver module, which requires specialized training and equipment for proper servicing. The equipment should be returned to the factory for any repairs.

# Contents

---

Chapter 1 HopNet Family of Products	
Overview .....	1-1
About the HopNet Products.....	1-4
HN-1000 Outdoor Base/Remote Station .....	1-5
HN-1500 Indoor Base/Remote Station.....	1-9
HN-2000 Repeater .....	1-13
HN-3000 Remote .....	1-20
Typical HopNet Applications .....	1-25
Chapter 2 Functional Description	
Overview .....	2-1
Network Communication .....	2-2
Point-To-Point Networks .....	2-4
Multipoint Networks.....	2-6
Multipoint Network Examples .....	2-12
Minimizing Latency .....	2-15
Minimizing Power Consumption .....	2-16
Chapter 3 Configuring the HopNet Network	
Overview .....	3-1
Using the NETCOM Software.....	3-3
Installing the NETCOM Software.....	3-4
Using the NETCOM Configuration Program Window.....	3-5
Configuring the Network Commands.....	3-7
Configuring the Serial Commands.....	3-11
Configuring the ARQ Commands.....	3-13
Configuring the RF Commands.....	3-15
Designing Your System.....	3-17
Testing Your Network Site .....	3-18
Installing the HopNet Products .....	3-19
Chapter 4 Programming Examples	
Overview .....	4-1
Configuring a CSMA Multipoint Network with Four Remotes .....	4-2
Configuring a Point-to-Point Network with a Repeater .....	4-6
HOPNET HN-2000 Repeater Configuration.....	4-10
Chapter 5 Troubleshooting	
Overview .....	5-1
Troubleshooting Table.....	5-2
Guidelines for Reducing Interference .....	5-3
Customer Support.....	5-5

# Chapter 1

## HopNet Family of Products

### Overview

---

#### Introduction

The HopNet family of products provides reliable wireless connectivity for either point-to-point or point-to-multipoint applications. The HopNet products are built around the HopNet radio transceiver, which employs frequency hopping spread spectrum technology. This technology ensures:

- Maximum resistance to noise
- Maximum resistance to multipath fading
- Robustness in the presence of interfering signals

#### HopNet Products

The HopNet family of products is built with rugged enclosures compliant with IP 66 and NEMA 4X standards for outdoor and harsh industrial environments. All HopNet Products are WIT2400 compatible and can be used with the WIT2400 OEM based products. The HopNet family consists of the following products:

##### External Antenna

HN-1000 Outdoor Base/Remote Station

HN-1500 Indoor Base/Remote Station

HN-2000 Repeater

##### Built-In Antenna

HN-3000 Remote Unit

##### Accessories

Antennas

Adapter

Power Supplies

## Overview, Continued

Term	Definition
DTE	Data Terminal Equipment. A device that provides data in the form of digital signals at its output. The computer side of a computer-to-modem connection.
EIRP	Effective Isotropic Radiated Power.
ISM	Industrial, Scientific, or Medical band operating at 2.4 GHz. Allows use of a radio without a license, but the equipment must be immune to interference from other users in the band.
Latency	The delay between when data is received on TX until it is output on RX.
RMA	Return Material Authorization.
RTU	Remote Terminal Unit. A device used in data collection.
TDMA	Time Division Multi Access. A time slot multiplexing protocol for multinode networking.

### In this Chapter

This chapter contains information on the following topics.

Topic	See Page
About the HopNet Products	1-4
HN-1000 Outdoor Base/Remote Station	1-5
HN-1500 Indoor Base/Remote Station	1-9
HN-2000 Repeater	1-13
HN-3000 Remote	1-20
Typical HopNet Applications	1-25

# HN-1000 Outdoor Base/Remote Station

## Introduction

The HopNet Outdoor Base/Remote Station (HN-1000) features a low-cost, rugged, compact, NEMA 4X/IP 66 enclosure for outdoor or harsh industrial environments. You can use the HN-1000 with all HopNet products and with any existing WTT2400 network.

## Data Transmission

The HN-1000 supports up to 255 remotes on a single network. You can operate 16 different networks in the same area without conflicts. The HN-1000 can easily transmit up to 1.0 mile line of sight. You can extend this range by adding a HopNet Repeater (HN-2000) and by using gain antennas.

Automatic repeat requests (ARQ) and acknowledgments inside the radio are transparent to the user equipment. User data rates of 115 Kbps are supported with built-in CRC/ARQ error protocols.

Data throughput is RS-484 differential while flow control signals are single-ended RS-232. The HN-3500 adapter can be used to connect all signals to RS-232 and to provide power. The HN-1000 uses a 9-pin Conxall weatherproof connector for power, data, and control signals. See the illustration below of the 9-pin Conxall connector.

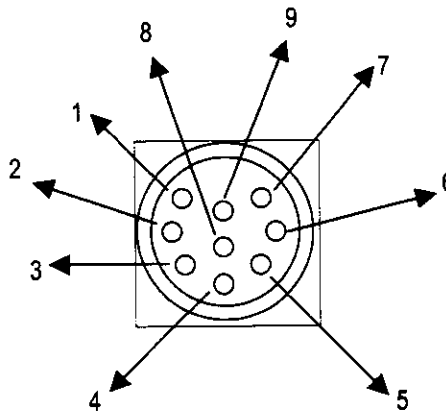

1 Transmit Data (TXD+)	4 Receive Data (RXD-)	7 Data Carrier Detect (DCD)
2 Transmit Data (TXD-)	5 Clear to Send (CTS)	8 VCC
3 Receive Data (RXD+)	6 Data Terminal Ready (DTR)	9 Ground

For more details, see the **Remote Pin-Out** for the HN-3000 later in this document.

## Power Connection

You can operate the HN-1000 from any well-filtered 7.5 to 12 VDC power source. The power supply should be capable of providing 750 mA peak current. Power connects through the 9-pin connector.

A polyfuse on the transceiver board protects against short circuits.

# HN-1000 Outdoor Base/Remote Station, Continued

## Technical Specifications

Refer to the following table for the technical specifications for the HN-1000.

### General

Specification	Value
Frequency Band	<ul style="list-style-type: none"> <li>• 2401-2480 MHz (USA)</li> <li>• 2448-2480 MHz (France)</li> </ul>
Number of Channels	<ul style="list-style-type: none"> <li>• 80</li> </ul>
Approvals	<ul style="list-style-type: none"> <li>• US FCC: Part 15. 203</li> <li>• European Community: ETS 300.328 Compliance</li> </ul>
Data Rate	<ul style="list-style-type: none"> <li>• Up to 115 Kbps Async Throughput</li> </ul>
RF Channel Data Rate	<ul style="list-style-type: none"> <li>• 250 Kbps</li> </ul>
Serial Data Interface	<ul style="list-style-type: none"> <li>• RS-485 Async</li> </ul>
Network Protocol	<ul style="list-style-type: none"> <li>• ARQ: CSMA or TDMA</li> </ul>
Connector	<ul style="list-style-type: none"> <li>• 9-pin Conxall 4282-9PG-300</li> </ul>
Mating Connector	<ul style="list-style-type: none"> <li>• 3282-9SG-Sxx</li> </ul>
TX Power Output	<ul style="list-style-type: none"> <li>• +18 dBm</li> </ul>
Receive Sensitivity	<ul style="list-style-type: none"> <li>• -95 dBm</li> </ul>
RF Bandwidth	<ul style="list-style-type: none"> <li>• 400 KHz</li> </ul>
Modulation Type	<ul style="list-style-type: none"> <li>• GMSK</li> </ul>
Output Impedance	<ul style="list-style-type: none"> <li>• 50 <math>\Omega</math></li> </ul>
Input Power at Connector	<ul style="list-style-type: none"> <li>• 10 VDC Nominal</li> <li>• 7.5-12 VDC Operating</li> <li>• 160 mA Typical (750 mA surge)</li> </ul>

### Mechanical

Specification	Value
Case	<ul style="list-style-type: none"> <li>• Nema 4X Standards</li> </ul>
Antenna Connector	<ul style="list-style-type: none"> <li>• TNC RF</li> </ul>
Size	<ul style="list-style-type: none"> <li>• 5.6 in. x 2.09 in. x 8.39 in.</li> </ul>
Weight	<ul style="list-style-type: none"> <li>• 1.8 lb</li> </ul>

# HN-1500 Indoor Base/Remote Station

---

## Introduction

The HopNet Indoor Base/Remote Station (HN-1500) features a rugged, compact, NEMA 4X enclosure for indoor or harsh industrial environments.

## Data Transmission

The HN-1500 supports up to 255 remotes on a single network, with up to 16 different networks in the same area. The HN-1500 can usually transmit over a range of 500 to 1000 feet indoors with obstructions. You can extend this range by adding a HopNet Repeater (HN-2000).

The automatic repeat requests (ARQ) and multinode protocol are transparent to the user equipment. User data rates of 115 Kbps are supported with built-in CRC/ARQ error protocols. Data signals are EIA RS-232 standard for Data Communications Equipment (DCE) devices.

Data and control of the radio are passed through a standard DB9 connector. See the following illustration for the signal description.

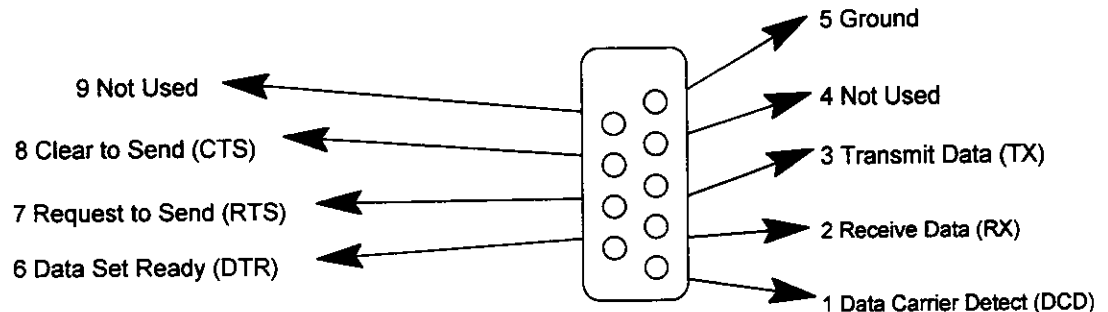



## HN-1500 Indoor Base/Remote Station, Continued

### Technical Specifications

Refer to the following table for the technical specifications for the HN-1500.

#### General

Specification	Value
Frequency Band	<ul style="list-style-type: none"> <li>• 2401- 2480 MHz (USA)</li> <li>• 2448-2480 MHz (France)</li> </ul>
Number of Channels	<ul style="list-style-type: none"> <li>• 80</li> </ul>
Approvals	<ul style="list-style-type: none"> <li>• US FCC: Part 15. 203</li> <li>• European Community: ETS 300.328 Compliance</li> </ul>
Data Rate	<ul style="list-style-type: none"> <li>• Up to 115 Kbps Async Throughput</li> </ul>
Channel Data Rate	<ul style="list-style-type: none"> <li>• 250 Kbps</li> </ul>
Serial Data Interface	<ul style="list-style-type: none"> <li>• RS-232 Async</li> </ul>
Network Protocol	<ul style="list-style-type: none"> <li>• ARQ: CSMA or TDMA</li> </ul>
TX Power Output	<ul style="list-style-type: none"> <li>• + 18 dBm</li> </ul>
Receive Sensitivity	<ul style="list-style-type: none"> <li>• -95 dBm</li> </ul>
RF Bandwidth	<ul style="list-style-type: none"> <li>• 400 KHz</li> </ul>
Modulation Type	<ul style="list-style-type: none"> <li>• GMSK</li> </ul>
Output Impedance	<ul style="list-style-type: none"> <li>• 50 <math>\Omega</math></li> </ul>
Antenna Connector	<ul style="list-style-type: none"> <li>• TNC RF Jack</li> </ul>
Input Power at Connector	<ul style="list-style-type: none"> <li>• 10 VDC Nominal</li> <li>• 7.5-12 VDC Operating</li> <li>• 160 mA Typical (750 mA surge)</li> </ul>

#### Mechanical

Specification	Value
Case	<ul style="list-style-type: none"> <li>• Aluminum</li> </ul>
Size	<ul style="list-style-type: none"> <li>• 7.9 in. x 5.7 in. x 2 in.</li> </ul>
Weight	<ul style="list-style-type: none"> <li>• 1.6 lb</li> </ul>
Data Connector	<ul style="list-style-type: none"> <li>• DB-9 Receptacle</li> </ul>
2-pin Power Connector	<ul style="list-style-type: none"> <li>• Conxall 1728822PG-300</li> </ul>
Mating Connector	<ul style="list-style-type: none"> <li>• Conxall 16282-2SG-3xx</li> </ul>

# HN-2000 Repeater

---

## Introduction

The HopNet Repeater (HN-2000) provides extended range capability between two HopNet networks. This repeater capability allows HopNet networks to be “daisy-chained” in series to send and receive data from remote locations that would otherwise be outside the coverage area of a single network.

If a remote unit is unable to communicate with the Base because of distance or obstruction, you can install a repeater. Repeaters work by re-transmitting the data from the outlying remote to the base and vice versa. The repeater will introduce a small amount of transmission delay.

## Design Features

The HopNet Repeater consists of the following:

- Two modems. One for communicating with out-of-range units. The other re-transmits to the base.
- A backup battery supply (with charging circuitry)

All components of the repeater are located inside a rugged, weatherproof, aluminum enclosure. Connections into and out of the box have been kept to a minimum to reduce the chances of industrial agents getting inside the unit. The enclosure is weatherproof and will resist the normal grime associated with industrial environments.

## HN-2000 Repeater, Continued

---

### Three-Way Switch

A miniature 3-way switch is located inside the back panel of the enclosure. See the illustration below.

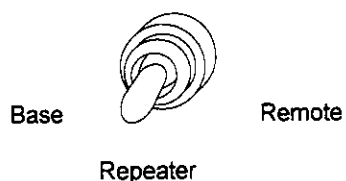

Use this switch to select one of three functions for the repeater:

- Remote configuration
- Base configuration
- Repeater operation (normal setting)

When you select Base or Remote configuration mode, you can program either side of the repeater through the DB-9 connector.

When you select repeater mode, the RX and TX data lines between the modems are tied together so that data is passed back and forth between the remote unit and the base unit.

### LED Status

Three external LEDs are on the front panel to inform you of the status of the repeater. The following illustration shows the three LEDs.



Refer to the following table for a description of the LEDs.

Name	Color	Description
PWR	Green	Continuous DC power is applied
RXD	Amber	Received Data
CD	Amber	Data Carrier Detect

An additional LED is installed inside the unit to help you configure the transceivers. The internal LED indicates whether the transceiver is in Remote configuration, Base configuration, or Repeater mode. This visual indication is redundant and is included for convenience. The switch positions are also marked on the circuit board to show their function.

## HN-2000 Repeater, Continued

---

### Configuring the Repeater

Complete these steps to configure the HN-2000 Repeater to the desired mode:

1. Remove the back panel of the repeater to set the function. Once the panel is removed, you should see the following:
  - A DB-9 connector
  - A 3-way switch
  - An LED
2. Flip the 3-way switch to the Remote position and configure one of the modems as a remote unit.
3. Check the bicolor LED that is directly behind the switch to be sure that it indicates when configuration mode has been selected and which unit is being configured. The LED indicator works with the 3-way switch as follows:
  - The red LED will be on when you configure the modem as a Remote
  - The green LED will be on when you configure the modem as a Base
  - Neither LED will be on when you select repeater operation
4. Flip the 3-way switch to the Base position and configure the other modem as a base unit. Be sure the green LED is on.
5. Once both modems have been configured correctly for repeater mode, set the 3-way switch back to repeater function and the unit should be ready to operate in repeater mode.
6. Verify that the configuration LED is off; then, replace the back panel.

## HN-2000 Repeater, Continued

---

### Mechanical

Specification	Value
Case	<ul style="list-style-type: none"><li>• NEMA 4X, IP 66</li></ul>
Size	<ul style="list-style-type: none"><li>• 8.4 in. x 5.65 in. x 3.0 in. (including mounting flange and connectors)</li></ul>
Weight	<ul style="list-style-type: none"><li>• 3.5 lb</li></ul>
RF Connectors	<ul style="list-style-type: none"><li>• TNC RF Jacks</li></ul>
Data Connector	<ul style="list-style-type: none"><li>• 9-pin, D-Sub type receptacle</li></ul>
Repeater power connector	<ul style="list-style-type: none"><li>• Conxall model number 1728822PG-300</li></ul>
Mating power connector	<ul style="list-style-type: none"><li>• Conxall model number 16282-2SG3XX</li></ul>

### Environmental

Value	
Temperature Range	<ul style="list-style-type: none"><li>• -20 to +70 degrees C</li></ul>
Humidity	<ul style="list-style-type: none"><li>• 95% at +40 degrees C, Non condensing</li></ul>

## HN-3000 Remote, Continued

### Remote Pin-Out

Pin Number	Signal	Type	Description
1	TXD+	Input	<ul style="list-style-type: none"> <li>• Non-inverted TX Data</li> <li>• RS-485 levels</li> <li>• Logic "1" = 5V</li> <li>• Logic "0" = 0V</li> </ul>
2	TXD-	Input	<ul style="list-style-type: none"> <li>• Inverted TX Data</li> <li>• RS-485 levels</li> <li>• Logic "1" = 5V</li> <li>• Logic "0" = 0V</li> </ul>
3	RXD+	Output	<ul style="list-style-type: none"> <li>• Non-inverted RX Data</li> <li>• RS-485 levels</li> <li>• Logic "1" = 5V</li> <li>• Logic "0" = 0V</li> </ul>
4	RXD-	Output	<ul style="list-style-type: none"> <li>• Inverted RX Data</li> <li>• RS-485 levels</li> <li>• Logic "1" = 0V</li> <li>• Logic "0" = 5V</li> </ul>
5	CTS	Output	<ul style="list-style-type: none"> <li>• Clear to Send</li> <li>• RS-232 levels</li> <li>• Buffer Ready = +12V</li> <li>• Buffer Full = -12V</li> </ul>
6	DTR	Input	<ul style="list-style-type: none"> <li>• Data Terminal Ready</li> <li>• RS-232 level</li> <li>• Wake remote = +12V</li> <li>• Sleep remote = -12V</li> </ul>
7	DCD	Output	<ul style="list-style-type: none"> <li>• Data Carrier Detect</li> <li>• RS-232 levels</li> <li>• Carrier Detected = +12</li> <li>• No Carrier Detected = -12V</li> </ul>
8	VCC	-	<ul style="list-style-type: none"> <li>• Positive Supply</li> <li>• +9V minimum</li> <li>• +12V maximum</li> </ul>
9	GND	-	<ul style="list-style-type: none"> <li>• Signal and Chassis Ground</li> </ul>

## HN-3000 Remote, Continued

### Technical Specifications

Refer to the tables below for the technical specifications for the HN-3000 Remote.

#### Electrical

Specification	Value
Transmitter FCC ID	<ul style="list-style-type: none"> <li>• HSW-2400M</li> </ul>
Transmit Power	<ul style="list-style-type: none"> <li>• EIRP: +24 dBm Nominal</li> <li>• +26 dBm Maximum</li> </ul>
Hopping Patterns	<ul style="list-style-type: none"> <li>• User configurable, 16 patterns (networks) available</li> </ul>
Number of Channels	<ul style="list-style-type: none"> <li>• 80</li> </ul>
Line-of-Sight Range	<ul style="list-style-type: none"> <li>• Greater than 1 mile</li> </ul>
Frequency Band	<ul style="list-style-type: none"> <li>• 2401-2480 MHz (USA)</li> <li>• 2448-2480 MHz (France)</li> </ul>
Approvals	<ul style="list-style-type: none"> <li>• US FCC: Part 15. 203</li> <li>• European Community: ETS 300.328 Compliance</li> </ul>
Receiver Sensitivity	<ul style="list-style-type: none"> <li>• -95 dBm (Integrated patch antenna adds 6 dB to the link budget)</li> </ul>
Data Interface	<ul style="list-style-type: none"> <li>• RS-232 for DTR, CTS, and DCD</li> <li>• RS-485 for TXD+, TXD-, RXD+, and RXD-</li> </ul>
Input Power at Connector	<ul style="list-style-type: none"> <li>• 10 VDC Nominal</li> <li>• 7.5-12 VDC Operating</li> <li>• 160 mA Typical (750 mA surge)</li> </ul>

#### Mechanical

Specification	Value
Case	<ul style="list-style-type: none"> <li>• NEMA 4X, IP 66</li> </ul>
Size	<ul style="list-style-type: none"> <li>• 7 in. x 6.25 in. x 2 in. (including mounting flange)</li> </ul>
Weight	<ul style="list-style-type: none"> <li>• 1.25 lb</li> </ul>
Data/Power Connector	<ul style="list-style-type: none"> <li>• Conxall model number: 4282-9PG-300</li> </ul>
Mating Connector	<ul style="list-style-type: none"> <li>• Conxall model number: 3282-9SG-5xx</li> </ul>

# Typical HopNet Applications

---

## Introduction

The illustration below shows a complete network of multiple data sources connected to a central base. Units that are out of range are connected through a repeater. See the illustration of a point-to-point application on the next page.

## Point to Multipoint

This common application consists of a central host and remote terminal units or other data collection devices. The automatic repeat requests (ARQ) and acknowledgments inside the radio are transparent to the computer system.

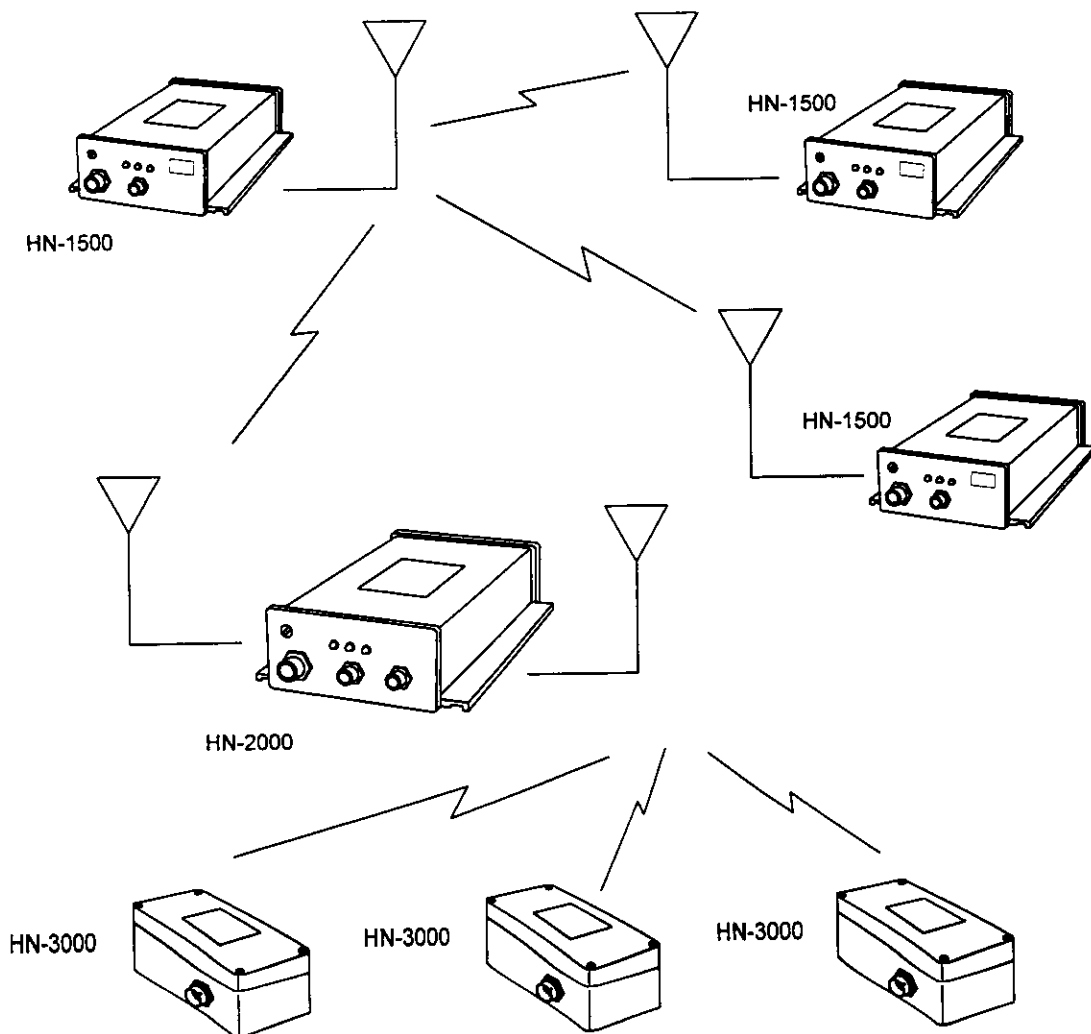



# Chapter 2

## Functional Description

### Overview

---

#### Introduction

The HopNet product line will allow you to create a wide range of wireless networking topologies—everything from simple point-to-point configurations to complex multipoint networks.

HopNet wireless modems transmit and receive serial asynchronous data in either RS-232 or RS-485 format. The data has:

- Eight data bits
- One start bit
- One stop bit
- No parity

The purpose of this chapter is to describe what HopNet can do, especially from a network topology and data throughput standpoint. This chapter also addresses data latency (delays) and power management strategies.

Refer to Chapters 3 and 4 for information on how to configure the various wireless modems in the network. In general, HopNet users can depend on the Windows 95/NT-based NETCOM software tool to make modem configuration a simple procedure.

#### In this Chapter

This chapter contains information on the following topics.

Topic	See Page
Network Communication	2-2
Point-To-Point Networks	2-4
Multipoint Networks	2-6
Multipoint Network Examples	2-12
Minimizing Latency	2-15
Minimizing Power Consumption	2-16

## Network Communication, Continued

---

### Channel Access

When transmitting to the base station, multiple remotes must share the same channel. HopNet products offer two methods for channel access:

- CSMA
- TDMA

Carrier Sense Multiple Access (CSMA) is contention based. Time Division Multiple Access (TDMA) is slotted or scheduled. For more information on these access methods, see **Contention Protocols** later in this chapter.

## Point-To-Point Networks, Continued

---

### Typical Point-to-Point Networks

Refer to the following diagram of a typical point-to-point network:

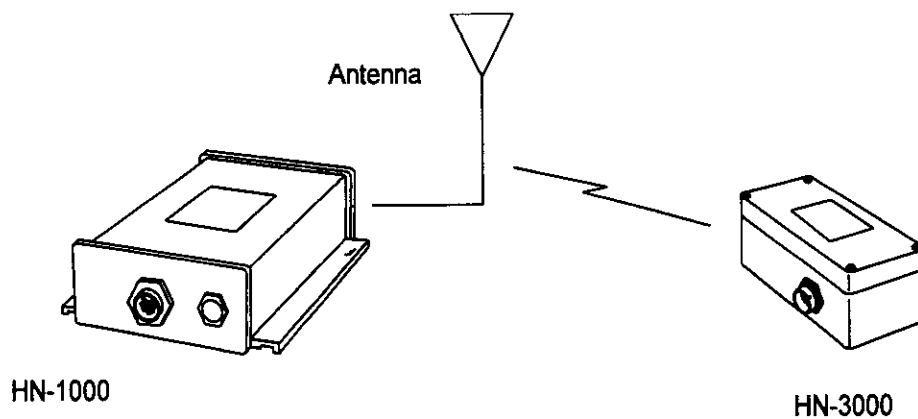

## Multipoint Networks, Continued

Refer to the following table for a description of each part of the multipoint packet format.

Part	Description
STX	Start-of-transmission character. Used to signal the beginning of a packet (02 Hex).
Remote Address	In the case of the base station receiving a packet, this is the source address of the remote that sent the packet.  In the case of the base sending a packet, this is the destination address of the remote unit that will receive the packet.  The remote address FF (hex) is reserved to indicate a broadcast message from the base station received by all the remotes.
Length	Number of data bytes in the packet, 0-255. Only the data section is included in the length count.
Data	The data that is transmitted.
ETX	End of transmission character that signals the end of a packet (03 Hex).

### Guidelines

Use the following guidelines for configuring a multipoint packet network:

- Enable the packet mode on all units in the network.
- Assign a unique address to all remotes.
- Employ either the built-in TDMA or CSMA protocol to handle multipoint network access.
- Enable ARQ to ensure successful data transmission.

Only the base station requires this multipoint format. The remote units may still send and receive data transparently, since they only communicate with the base station and not with one another. Since remote units do not communicate from peer to peer, there is no confusion over source or destination.

Depending on the average packet size in your application, allow as much as 25 percent of extra capacity at the base for the extra four bytes per packet required by the multipoint data format. You can program the minimum packet size parameter to ensure that this buffer capacity is not exceeded.

# Multipoint Networks, Continued

## Contention Protocols

The various remote nodes must share air-time capacity in any multipoint communications network. The HopNet products have two means of doing this:

- CSMA
- TDMA

### CSMA

Carrier-sense multiple access (CSMA) is one contention protocol. The CSMA protocol is very effective with sorting random packets of irregular data from a large number of remote nodes.

One advantage of CSMA is that it does not require special coordination between remotes. When using CSMA, the remotes listen to see if the channel is clear and then transmit. If the channel is busy, the remotes wait for a randomly chosen period of time and re-transmit. CSMA works best with a large or variable number of remotes transmitting infrequent bursts of data. Channel latency in a CSMA access scheme is exponentially distributed.

In CSMA mode, you can define the maximum time that a remote unit will wait before attempting to send the packet again (also called the backoff interval). You can also set the probability that a remote unit will transmit immediately rather than first waiting for a backoff interval. Refer to Chapter 3, **Configuring the Network Commands**, for setting these values.

**Important:** For point-to-point applications, set persistence to 255 for maximum throughput and shortest latency.

The illustration below compares CSMA to TDMA.

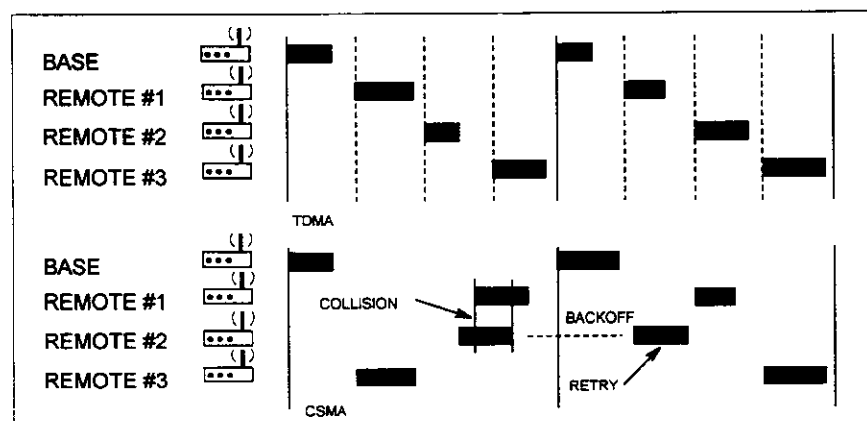

Refer to Chapter 4 for a programming example of using CSMA.

# Multipoint Networks, Continued

---

## Transparent Broadcast Network

One type of multipoint network is a transparent broadcast network, which transmits packets to all remote nodes simultaneously. DTEs at these remote nodes can determine whether the information was intended for that particular node.

Data from any remote node always transmits to only the base station to which the remote unit is dedicated.

Some systems already have data embedded in a proprietary, multipoint packet protocol and only wish to eliminate wires and not to impose any additional protocols. Transparent broadcast networks allow you to use your own established system-level protocol for multipoint communication.

The transparent broadcast approach does not employ ARQ to ensure successful transmissions. HopNet does, however, allow for automatic multiple transmissions of all packets. This can greatly improve the chance of getting data through, in spite of jamming or multipath fades, at a cost of decreased bandwidth.

## Configuration Requirements

To configure your system for a transparent broadcast network, do the following:

- Set all units in the network to the same network number.
- Set the base station destination address to 255 (FF hex). This automatically sends all base station packets to every remote node.
- Set the automatic retransmit setting to 2 to 4 attempts which increases (but does not guarantee) the probability of a successful transmission.

See the illustrations of typical point-to-multipoint networks on the following pages.

# Multipoint Network Examples, Continued

---

## Example 2

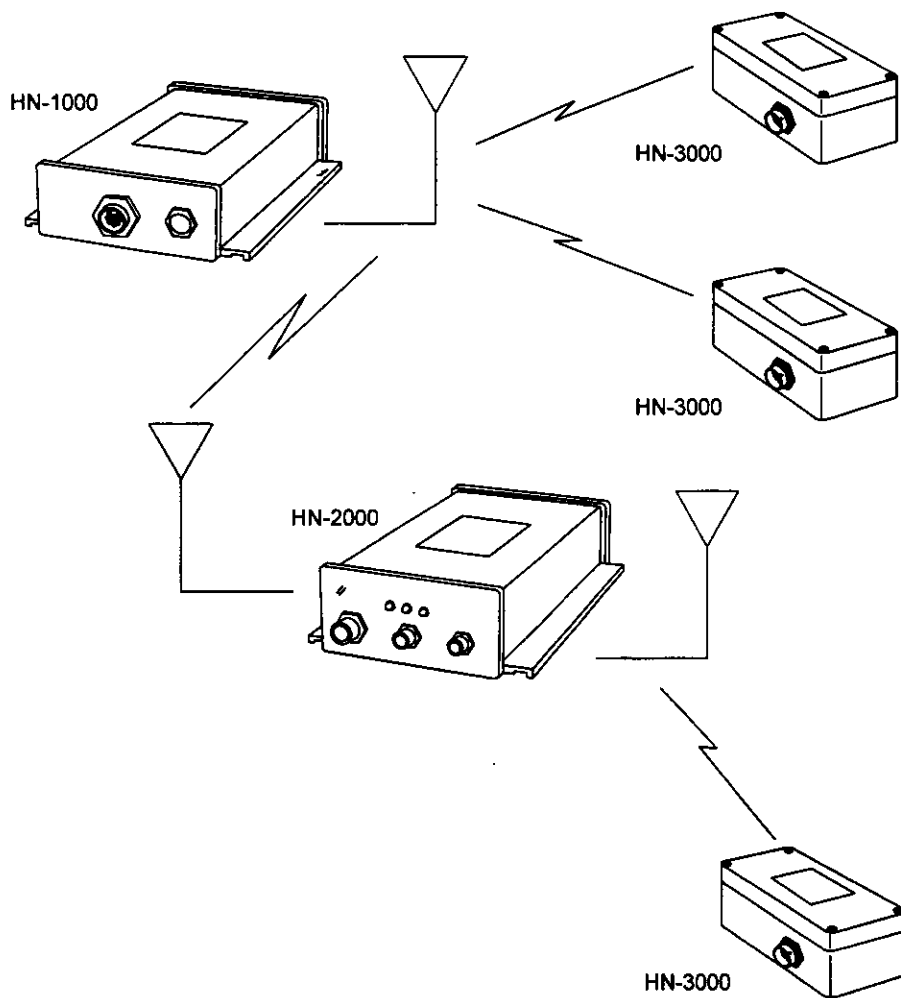

# Minimizing Latency

---

## Introduction

The HopNet system user can choose modem configuration settings that greatly influence the data delays that may be encountered. Many times there is a tradeoff between latency and bandwidth. It is difficult to optimize both parameters.

## Data Rates

The HopNet products all have transmit buffers for storing data prior to transmission. You can configure HopNet modems at a variety of data rates, for example 2400 bps to 115 Kbps. The data rate that you choose affects the time it takes to download a packet into the transmit and receive buffers. A full packet must be buffered before it can be sent so that higher data rates will have less latency.

## Packet Size

Packet size affects latency. The minimum and maximum settings for packet size affect how much data is loaded into the buffer prior to transmission. The smaller the packet size, the faster the data is transmitted from the buffer and the shorter the latency time.

## Dwell Time

Data is always transmitted within a particular interval of time called "dwell time." This is the time the radio stays on a particular frequency channel before hopping to the next channel. If transmission of a packet is unsuccessful on a given hop, the radio may have to wait until the next hop before attempting to re-send the data. In general, reducing dwell time of a network will shorten latency times. We do not recommend dwell times below 10 ms.



# Chapter 3

## Configuring the HopNet Network

### Overview

---

#### Introduction

You can configure the HopNet network using a PC and the NETCOM software provided by Digital Wireless Corporation. NETCOM is a menu-driven software package that runs under Windows 95 or NT and guides you through the necessary steps to configure your application network.

This chapter provides the information you need to configure your HopNet network.

#### Four Command Types

The NETCOM software enables you to configure four types of commands:

- Network Commands
- Serial Interface Commands
- ARQ Commands
- RF Commands

#### In this Chapter

This chapter contains information on the following topics.

Topic	See Page
Using the NETCOM Software	3-3
Installing the NETCOM Software	3-4
Using the NETCOM Configuration Program Window	3-5
Configuring the Network Commands	3-7
Configuring the Serial Commands	3-11
Configuring the ARQ Commands	3-13
Configuring the RF Commands	3-15
Designing Your System	3-17
Testing Your Network Site	3-18
Installing the HopNet Products	3-19

# Using the NETCOM Software

---

## Introduction

The NETCOM software is a Windows 95/NT Program written for PC- compatible computers that you can use to easily configure your HopNet network.

This following information describes the NETCOM software, provides installation instructions for NETCOM, and describes the fields that require user input.

## Purpose

The main purpose for the NETCOM software is to simplify and automate the task of setting up a HopNet network, including specifying of data rate and radio addresses.

The NETCOM software also allows control of low-level parameters, such as transmit power level and internal protocol parameters. However, default settings for these parameters are optimal in most cases.

**Important:** Your settings are saved to nonvolatile memory and are restored at every power-up.

# Using the NETCOM Configuration Program Window

## Introduction

The NETCOM Configuration Program window is illustrated below.

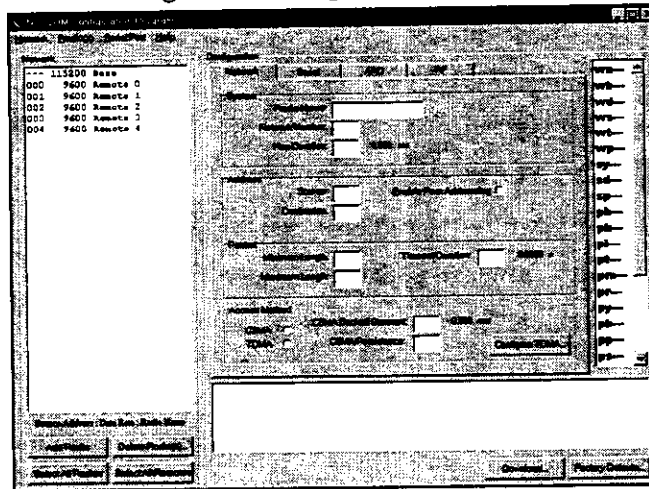

The left part of the window displays the Source Address, Data Rate and Radio Name of all units in the network. You can select a radio by clicking on it. You can also select multiple radios by holding down the CTRL key and clicking on selected radios or by clicking the **Select All Radios** push button.

The center of the window displays the various fields, which require user input.

The right part of the window shows the complete configuration of the radio(s) selected. If more than one radio is selected and their parameters are different, an asterisk will appear in place of the value.

**Example:** If the baud rates are different between the base and remotes and all radio are selected, sd\*\*\* will appear. If just the base unit is selected, 1152000 will appear in the data rate window and sd009 will appear in the configuration window.

The bottom of the window displays text explaining the selected field.

## Communication Parameters

The NETCOM defaults for baud rate are as follows:

- 115 kbps for a Base unit
- 9600 bps for a Remote unit

NETCOM automatically assigns source addresses to the remote units. All other parameters are the default setting.

## Communication Ports

The NETCOM software defaults to COM1. To change the serial port, click **Serial Port** and select the desired port.

# Configuring the Network Commands

## Introduction

This section provides information to help you configure the individual network parameters of the HopNet network.

## Network Commands

The network window contains four sections (see below).

- System
- Address
- Packet
- Access Method

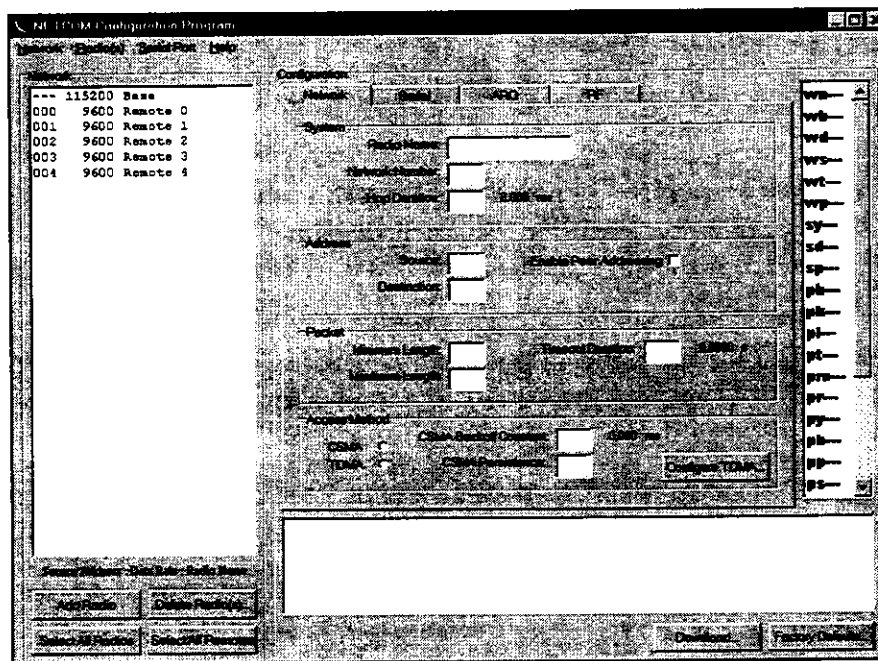

## Radio Name

Allows you to give the network radio a generic name, such as RTU1. This name is not stored in the radio and is only used in the NETCOM software.

## Set Network Number

Sets which network and hopping pattern to follow.

Up to 16 networks may run independently of one another. Each network contains a base unit and from 1 to 255 remotes. A remote must have the same network number as its base in order to synchronize and communicate.

## Configuring the Network Commands, Continued

---

### Set Minimum Packet Length

Defines the smallest packet size (number of bytes) that a remote unit will immediately transmit. The modem input buffer accumulates data until this minimum packet size is reached and then transmits the data.

This parameter only applies to remote units. Since the base station transmits on every hop, it has an effective minimum packet length of 1 byte.

### Set Maximum Packet Length

Defines the largest packet size that a remote unit will transmit. A smaller number may help reduce the number of collisions in a heavily loaded CSMA network.

This parameter also establishes the length of time slots in TDMA mode.

Generally, packet size is a tradeoff between bandwidth and delay as shown below:

- Small packets can result in shorter latency, less capacity, and fewer incorrect packets.
- Large packets can result in longer latency and greater capacity.

### Set Packet Timeout Duration

Sets the timeout for sending packets. When this duration is exceeded, the buffered data is transmitted even if the packet size is less than the minimum packet length. This setting ensures that the end of a message is always sent.

The timeout period equals the hexadecimal operand value multiplied by the hop duration (default 72 ms). Set this parameter as follows:

- For shortest latency, the timeout may be set to zero.
- If you have very large packets and latency is not an issue, a value of 255 sets the packet timeout to infinite duration.

This parameter has no function for the base station since it transmits on every hop.

### Set Channel Access Mode

Selects whether a remote will use either the CSMA or TDMA channel access mode. The same access mode must be used by all the remotes in the network.

The default mode is CSMA, which is adequate for most applications.

CSMA mode has adjustable parameters. For more information, see the protocol commands **Set CSMA Backoff Constant** and **Set CSMA Persistence**. You can also refer to Chapter 4 for a programming example of using CSMA.

For TDMA parameters, see the protocol command **Set TDMA Time Slot** and refer to the NETCOM TDMA worksheet.

# Configuring the Serial Commands

## Introduction

This section provides information for configuring the serial parameters of the HopNet network.

## Serial Commands

The serial window contains three main sections (see below).

- Data Rate
- Data Format
- Power On Options

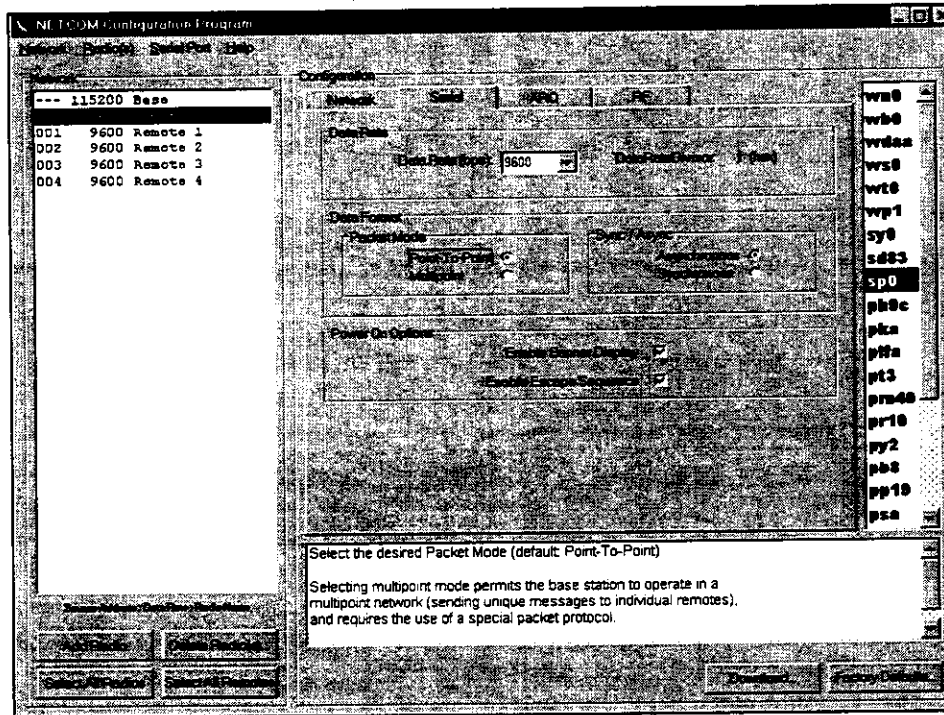

## Set Data Rate

Sets the serial bit rate of the radio. This command takes effect immediately after a download.

Once you set the data rate of the radio, you must set the data rate of the terminal to the same data rate as the radio. Once the data rates are the same, the devices can communicate.

# Configuring the ARQ Commands

## Introduction

This section provides information for configuring the ARQ parameters of the HopNet network.

## ARQ Commands

The ARQ window allows you to set the error correction protocol as shown below.

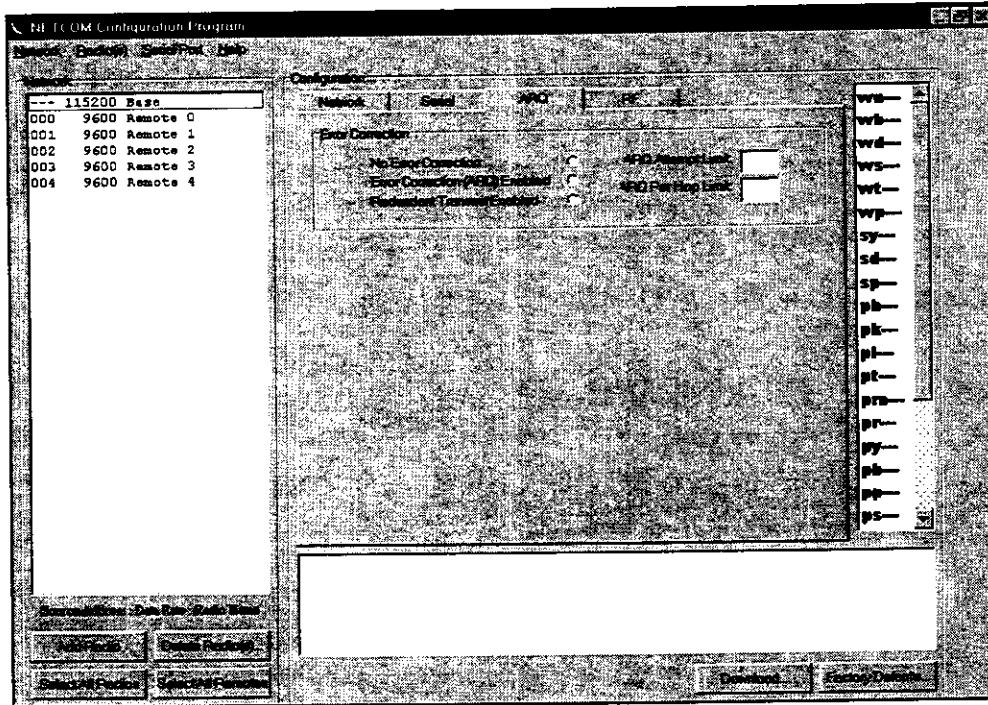

## Error Correction

Enable or disable error correction.

## Enable Redundant Transmit

Overrides reception of ARQ acknowledgements, forcing the radio to transmit packets redundantly.

In this mode, the radio will neither transmit nor receive acknowledgements, but will instead send each packet repeatedly the number of times equal to the ARQ attempt limit (as set by the "pr" command).

Typically, the number of redundant transmissions is kept low (for example, two to four times) because of the directly proportional loss in network capacity.

This mode is rarely used except in the following scenarios:

- For a base station, which transmits only unacknowledged broadcast messages
- When return transmissions are impossible or undesirable
- When very short latency broadcasts are required to improve reliability

# Configuring the RF Commands

---

## Introduction

This section provides information for configuring the RF parameters of the HopNet network.

## RF Commands

The RF window contains three main sections (see below):

- Transmit Power
- Frequency Set
- Options

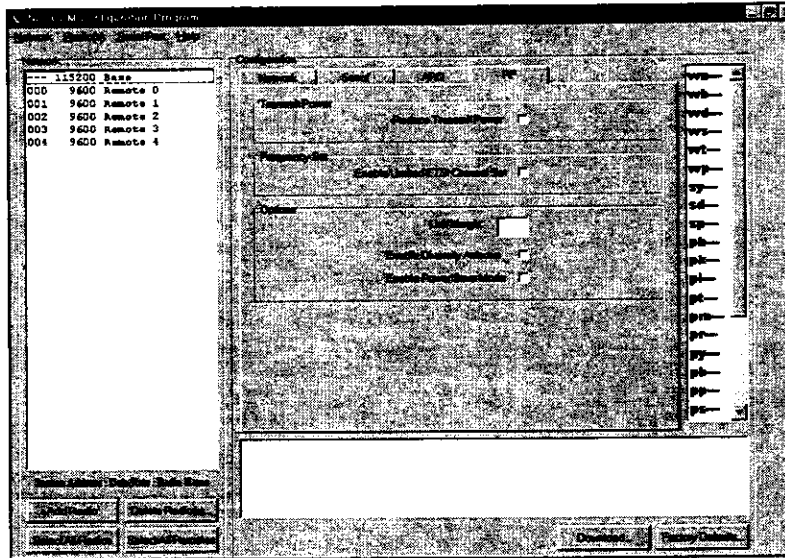

### Set Transmit Power

**Caution:** When using the 10 mW power setting, the antenna port is biased with 5 VDC. Although this is typically not a problem, it may exceed the input limits of some RF test equipment.

Depending on the range required by your application, you may wish to set the radio's transmitter to low power for more efficient operation from a battery. Reduced power can also reduce the size of the coverage/interference zone, which may be desirable for multiple-network applications.

### Enable Limited ETSI Channel Set

(French Only) Limits the operating RF channel set to the 2448 to 2480 MHz frequency band for compliance with French EM standards.

**Important:** Be sure this setting is disabled for FCC-compliant operation inside the US (this is the default).



# Designing Your System

---

## Introduction

The HopNet family offers versatility because you can configure it with an existing WIT2400 network both indoors and outdoors. Consider these three factors when you design your system:

- Operating Margin of system
- Insertion Loss of Cable
- Antenna Selection

All three items are used in the design to determine overall system performance. For indoor applications, fire codes specify the type of cables you can route in certain locations within the building.

## Operating Margin of System

FCC rules allow for a total EIRP of +36dBm and the transceiver is set for 100 mW RF output power.

When figuring operating budgets, keep track of all losses and gains.

**Example:**

HN-1000 (+18 dB) + feedline loss (-4.5 dB) + antenna gain (+17.15 dB) = < +36 dBm

Be sure to consider all possible attenuation sources when calculating the operating margin of the network.

## Insertion Loss of Cable

Insertion loss is a measure of the longitudinal attenuation of the cable. For a given cable size, the insertion loss increases as the frequency of operation increases.

## Antenna Selection

The HopNet products can be used with a number of antennas. The physical layout of your system determines the style of antenna you should use.

At the base station, an omni-directional antenna is normally used to ensure coverage to all of the remote sites. Refer to Appendix C for a listing of antennas available from Digital Wireless Corporation.

# Installing the HopNet Products

---

## Guidelines for Installation

When installing your system, always consider the following points:

- Directional antennas are best for remote unit sites. They may increase the cost, but they confine the transmission path to a narrow lobe and minimize the interference from nearby stations.
- For systems with constant interference present, you may need to change the polarity of the antenna system and reduce data streams. Groups of short data streams are more reliable and have a better chance of success in the presence of interference than do long streams.
- Systems installed in rural areas are least likely to encounter urban interference.
- Multiple HopNet systems can operate in close proximity to each other but require a unique network address.
- Poor quality coaxial cables will seriously degrade system performance. Use low-loss cable that is suitable for 2.4 GHz operation.
- Short cable runs minimize signal loss.

## Guidelines for Placing the Repeater

Follow these guidelines for placing the repeater:

- Be sure to carefully select the geographical location of the repeater station. A site must be chosen that allows good communication with both base station and remote site. This is often on top of a hill, building, or at a firewall for indoor applications.
- Be sure to install two antennas at the repeater station—one for each transceiver. Be sure to take precautions to minimize the chance of interference between these antennas.
- Employ vertical separation to prevent interference with repeater antennas. In this arrangement, mount one antenna directly over the other separated by at least 4 feet.
- Cross-polarize the repeater antennas as another way to reduce interference. Mount one antenna on the vertical plane. Mount the other antenna on the horizontal plane.

## Procedure

To install the HopNet products, complete these steps.

**Important:** Be sure to follow the manufacturer's instructions for installing feedline and the interface instructions. We recommend that you extend the control line rather than the antenna cabling.

1. Mount the transceiver to a stable surface (fasteners/anchors are not provided.) See the illustrations in *Appendix A* for mounting specifications.

# Chapter 4

## Programming Examples

### Overview

---

#### Introduction

This appendix provides examples that you can refer to when you configure your network with the NETCOM software.

#### In this Chapter

This chapter contains information on the following topics.

Topic	See Page
Configuring a CSMA Multipoint Network with Four Remotes	4-2
Configuring a Point-to-Point Network with a Repeater	4-6
HOPNET HN-2000 Repeater Configuration	4-10

## Configuring a CSMA Multipoint Network with Four Remotes, Continued

---

### Configuring the Remote Unit

Follow these steps to configure the remote unit.

1. From the radio listbox, select **Remote 0**.
2. Click on the **Network Tab**.
3. Click on **CSMA Persistence** and enter **192 (.75)**.
4. Click on **Timeout Duration** in the **Packet Box** and enter **0**.
5. Click on **Remote 1** from the Radio listbox .
6. Click on **Timeout Duration** in the **Packet Box** and enter **0**.
7. Click on **CSMA Persistence** and enter **192 (.75)**.
8. Repeat steps 5 through 7 for remotes 2 and 3.  
This completes the configuration of the remote radios. You can now download the new network configuration the radios.
9. Go to **Downloading the Configuration** on the next page.

## Configuring a CSMA Multipoint Network with Four Remotes, Continued

---

### Printing the Network Configuration

Follow these steps to print the network configuration file.

1. Open Wordpad or any word-processing program.
2. Select **Open**.
3. Go to the NETCOM directory.
4. Click on the file name (for example, **Temp4remotes**).
5. Click on the Print icon to print your configuration file.

## Configuring a Point-to-Point Network with a Repeater, Continued

---

### Downloading the Configuration to the Base

Follow these steps to download the configuration to the base side of the network.

1. Remove the back panel of the repeater to set the function. Once the panel is removed, you should see the following:
  - A DB-9 connector
  - A 3-way switch
  - An LED

**Note:** A bicolor LED is directly behind the switch that indicates when configuration mode has been selected and which unit is being configured. The LED indicator works with the 3-way switch as follows:

- The red LED will be illuminated when you configure the transceiver as a Remote.
  - The green LED will be illuminated when you configure the transceiver as a Base.
  - Neither LED will be illuminated when you select repeater operation.
2. Flip the 3-way switch to the right for the remote position to configure one side of the repeater as a remote. Be sure that power is applied to the HN-2000 and that the red LED behind the switch is illuminated.
  3. Connect a serial cable from the PC to the DB-9 connector.
  4. Select **Remote** from the radio listbox and click the **Download...** button.
  5.
    - If the download is successful, the system will prompt you. Click **OK** to return to the NETCOM Configuration Program window.
    - If the download is unsuccessful, identify the error, correct it, and click **Retry**.
  6. Click on **Base Station** from the radio listbox.
  7. Connect the cable to the HN-1000 or HN-1500.
  8.
    - Ensure that power is applied and click the **Download...** button.
  9.
    - If the download is successful, the system will prompt you. Click **OK** to return to the NETCOM Configuration Program window.
    - If the download is unsuccessful, identify the error, correct it, and click **Retry**.
  10. This completes the configuration of Side 1 of the network. Now go to **Saving the Configuration**.

## Configuring a Point-to-Point Network with a Repeater, Continued

---

15.
  - If the download is successful, the system will prompt you. Click **OK** to return to the NETCOM Configuration Program window.
  - If the download is unsuccessful, identify the error, correct it, and click **Retry**.
16. Unplug the serial cable from the HN-2000.
17. Flip the 3-way switch to the center position for repeater mode. Be sure the LED is off.
18. Replace the back panel.
19. **Select Network.**
20. **Select Save As.**

Enter **Remote Station** as the file name and click **Save**.

This completes the configuration of a point-to-point network with a repeater.

## HOPNET HN-2000 Repeater Configuration, Continued

To send the same message through the repeater to a remote in network B, a second packet wrapper must be added. Assuming the repeater has been assigned remote address A3H and the desired remote has been assigned address B1H, the packet would look like:

Start	Addr (rptr)	Len (L+4)	Start	Addr	Len								End	End
STX	A3	11	STX	B1	7	T	E	S	T	1	2	3	ETX	ETX

In this case, the outer packet wrapper with address A3H is stripped off when received by the repeater remote, leaving the inner packet with address B1H to be delivered by the repeater base.

Similarly, packets transmitted by remotes in the second network and relayed through the repeater base will arrive at the original base with an additional wrapper created by the repeater. It is important to note that the outer and inner packet boundaries are not guaranteed in general to be congruent. For example, the same "TEST123" message above sent back from the B remote might arrive at the A base in two pieces:

Start	Addr (rptr)	Len (L+4)	Start	Addr	Len					End
STX	A3	9	STX	B1	7	T	E	S	T	ETX

Start	Addr	Len						End
STX	A3	4	1	2	3	4	ETX	ETX

Earlier in this section is a set of example configuration parameters which should be suitable for most repeater networks. A few settings require further comment. Note that the data rate is set to the maximum rate (115200 bps) for both halves of the repeater. To improve throughput, the CSMA persistence of the repeater remote is also set to maximum (FF). Finally, the hop durations for the two networks are slightly staggered to prevent the possibility of an unintentional lockstep synchronization between halves of the repeater in which one half of the repeater is always transmitting when the other half is trying to receive, which depending on antenna placement could result in reduced receive sensitivity over a portion of the hopping sequence.



# Chapter 5

## Troubleshooting

### Overview

---

#### Introduction

Troubleshooting the HopNet products is not difficult, but it does require a logical approach. It is best to begin troubleshooting at the base station because the rest of the system synchronizes to it. If the base station has problems, the entire network will be compromised.

This chapter provides troubleshooting information for your HopNet products.

#### Transceiver Requirements

For proper operation, all transceivers in the network must meet these basic requirements:

- Adequate and stable power
- Secure connections ( Power, RF, and Data)
- Proper programming especially Hop Duration and Network Address

#### In this Chapter

This chapter contains the following topics.

Topic	See Page
Troubleshooting Table	5-2
Guidelines for Reducing Interference	5-3
Customer Support	5-5

---

# Guidelines for Reducing Interference

---

## Introduction

The transceivers share the same frequency spectrum with other services and other Part 15 devices in the US. Because of this, you may not achieve 100 percent error free communications in a given location. You should also expect some level of interference. However, the flexible design of the radio and the hopping pattern should allow for adequate performance as long as care is taken in choosing station location, configuration parameters of the transceivers, and protocols techniques.

Use the following guidelines to reduce interference in your HopNet system.

## Guidelines for Setting Up the Network

In general, the following points should be followed when setting up a network:

- Systems installed in rural areas are least likely to encounter interference.
- If possible, use directional antennas at remote sites. The directional antennas confine the transmission path and reception pattern to a comparatively narrow lobe, which minimizes interference from stations located outside the pattern.
- Multiple HopNet systems can co-exist in close proximity to each other with very minor interface as long as they are assigned a unique network address. Each network address has a different hop pattern.
- If interference is suspected from a similar operating system, change the antenna polarization. This will provide an additional 20dB of attenuation to interference.
- For indoor applications, set all transceivers for the lowest level necessary for reliable communications. This lessens the chance of interference from nearby systems.

## Guidelines for Selecting Your Site

Use these guidelines to select a proper site for the master remote stations. Suitable sites must provide the following:

- An adequate and stable source of primary power.
- Antenna location that provides an unobstructed transmission path in the direction of the associated units.
- Proper antenna selection, data, and feedline cabling
- A clear line-of-sight. Microwave radio signals travel primarily by line-of-sight, and obstructions between the sending and receiving stations will affect system performance.

# Customer Support

---

## Introduction

Digital Wireless Corporation products are designed for long life and trouble free operation. The following information is provided if servicing becomes necessary.

## Technical Assistance

Technical assistance for DWC products is available from the hours of 9:00 A.M - 5:30 P.M. Eastern Standard Time. When calling, please have available the complete model name, serial number, and a complete description of the problem. Most problems can be resolved without returning the unit to the factory.

The following telephone numbers are available for assistance.

Phone	770 564 5540
Fax	770 564 5541

## Factory Repairs

If return of equipment is necessary, you will be issued a Return Material Authorization number (RMA #). The RMA # will help expedite the repair so that equipment can be returned as quickly as possible. Please be sure to include the RMA number (#) on the outside of the shipping box and on any correspondence relating to the repair. Any equipment returned without an RMA # may be delayed in the repair cycle.

Please be sure to carefully package all items to be returned and address to:

DIGITAL WIRELESS CORPORATION  
One Meca Way  
Norcross, GA 30093

RMA # \*\*\*

# Appendix A

## Mechanical Drawings

### Overview

---

#### Introduction

The following examples are provided to help you install your HopNet products.

#### In this Appendix

This appendix contains the following mechanical drawings.

Drawing
• HN-1000 Outdoor Base/Remote Station
• HN-1500 Indoor Base/Remote Station
• HN-2000 Repeater
• HN-3000 Remote
• HN-3500 Adapter



REVISIONS

REV	CC NO.	DESCRIPTION	DRN	ENGR. CHK.	DATE

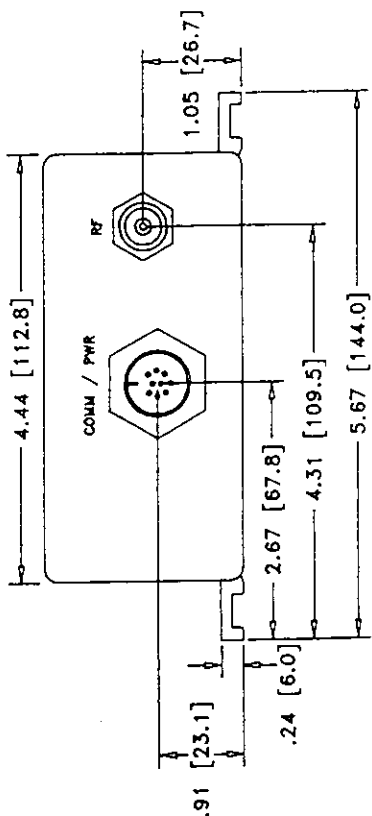

- NOTE:
1. RF CONNECTOR IS A TNC JACK.
  2. COMM/POWER CONNECTOR IS A CONXALL MULTI-CON-X NO. 4 2 82-9 PG-300 MATE: CONXALL NO. 3 2 8X-9 SG-3XX

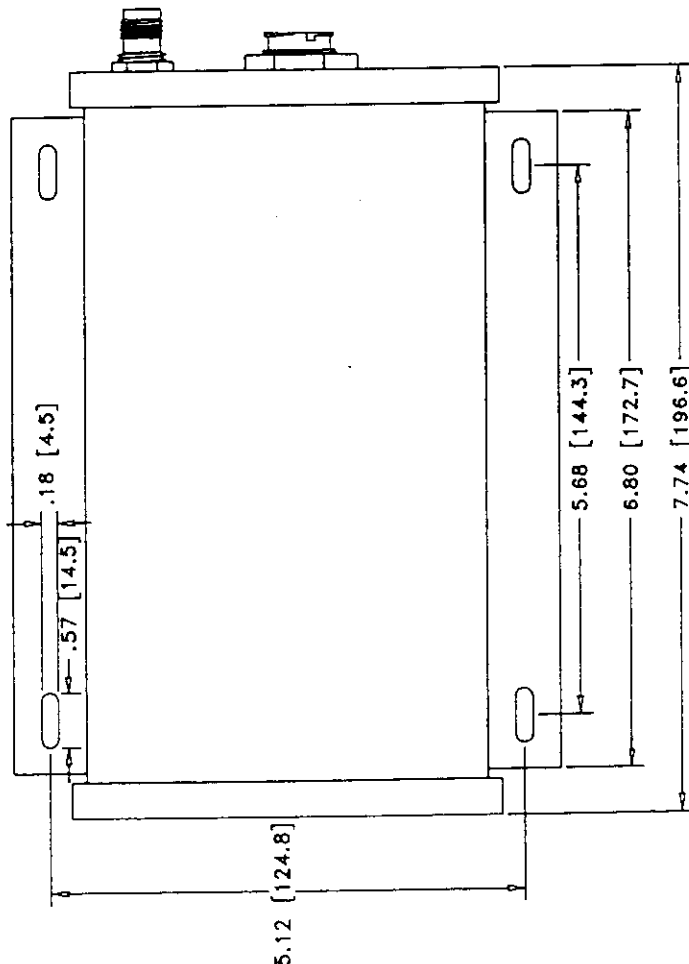
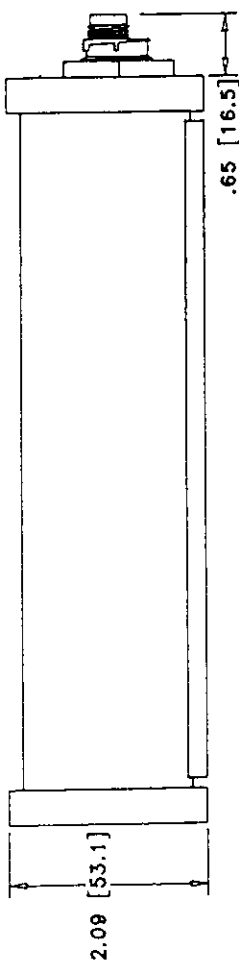

UNLESS OTHERWISE SPECIFIED DIMENSIONS ARE IN INCHES—(MILLIMETERS)	
TOLERANCES	
XX	±.02 INCHES
X	±.05 INCHES
XXX	±.008 INCHES
XX	±.15 MM
XX	±.30 MM
XX	±.15 MM
XX	±.30 MM
THIRD ANGLE PROJECTION	
DATE	17APR98
ENGR.	PM
DATE	17APR98
ENGR. INSP.	MT
DATE	17APR98

DIGITAL WIRELESS CORP.

ONE MECA WAY, NORCROSS, GA 30093 USA  
TEL (770) 664-5640 FAX (770) 664-6641

TITLE DRAWING,  
OUTLINE, BASE,  
WEATHERPROOF, HOPNET

SCALE	1:2	DOC NUMBER	800220	REV.	—
DESCRIPTION THIS DRAWING	—	PART NUMBER	—	SHEET	1 OF 1



REVISIONS

REV	CC NO.	DESCRIPTION	DRN	ENGR. CHK.	DATE

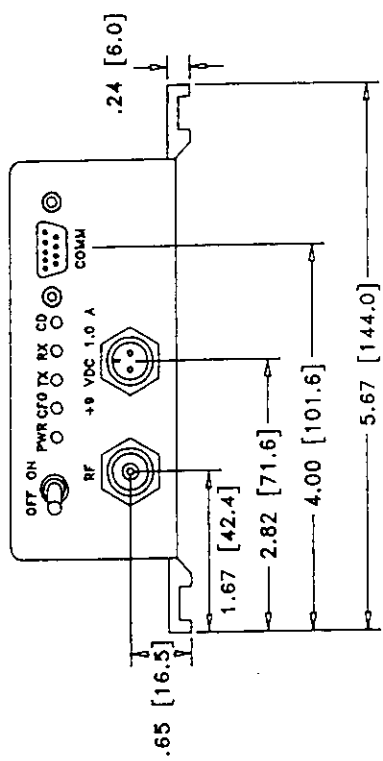

- NOTE:
1. RF CONNECTOR IS A TNC JACK.
  2. POWER CONNECTOR IS CONXALL MICRO-CON-X PART NO. 17 2 82-2PG-300 MATE: CONXALL NO. 16 2 8X-2SG-3XX
  3. COMM CONNECTOR IS DB-9 SOCKET.

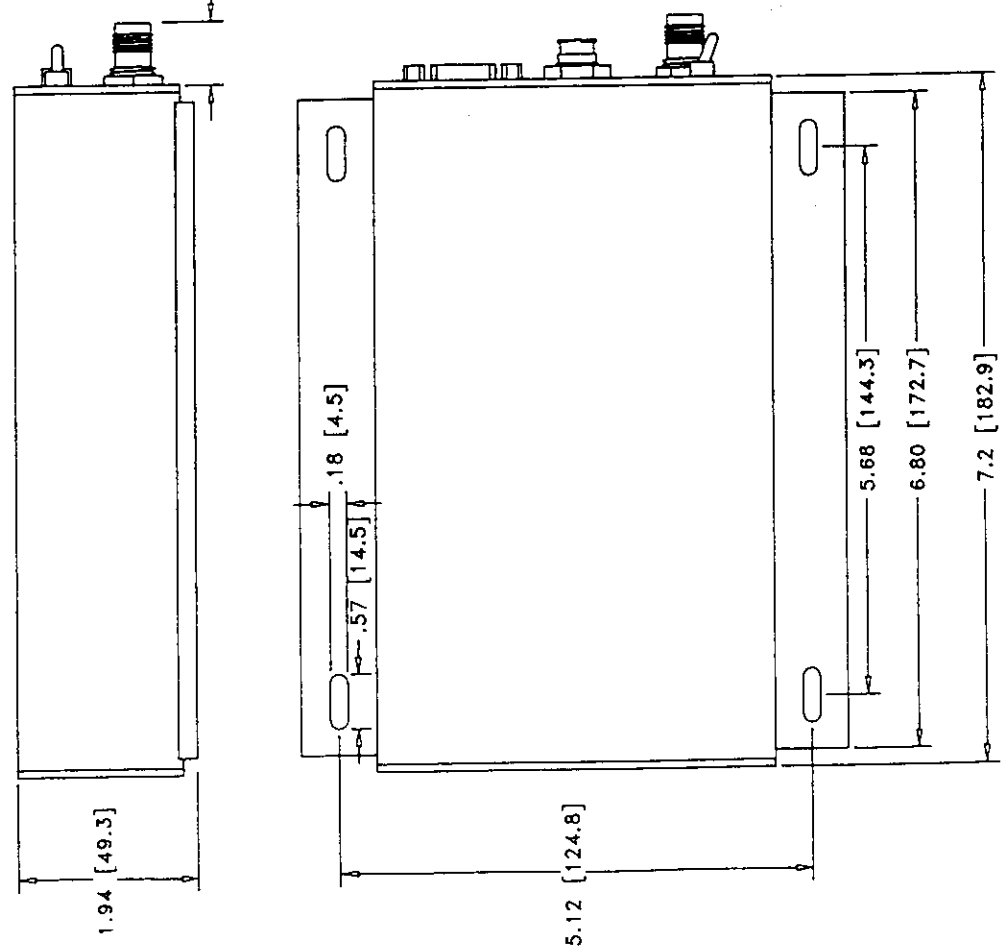

UNLESS OTHERWISE SPECIFIED DIMENSIONS ARE IN INCHES (DIMENSIONS IN PARENTHESES ARE IN MILLIMETERS)	
TOLERANCES	
XX = ±.02 INCHES	
[X] = ±.05 INCHES	
ANGULAR = ±.5	
[XX] = ±.004 INCHES	
[XX] = ±.10 MM	
THIRD ANGLE PROJECTION	
DATE	DATE
17APR88	17APR88
DATE	DATE
17APR88	17APR88
DATE	DATE
17APR88	17APR88
DRN	DATE
PM	17APR88
ENGR.	DATE
PM	17APR88
ENGR. MOD.	DATE
MT	17APR88

DIGITAL WIRELESS CORP.  
 ONE MECA WAY, NORCROSS, GA 30093 USA  
 TEL (770) 584-6640 FAX (770) 584-5541

TITLE DRAWING,  
 OUTLINE, BASE,  
 INDOOR, HOPNET

DESCRIPTION THIS PAGE  
 —

SIZE C  
 SCALE 1:2  
 DOC NUMBER 800221  
 REV. —

PART NUMBER  
 SHEET 1 OF 1





REVISIONS			
REV	CC NO.	DESCRIPTION	DATE

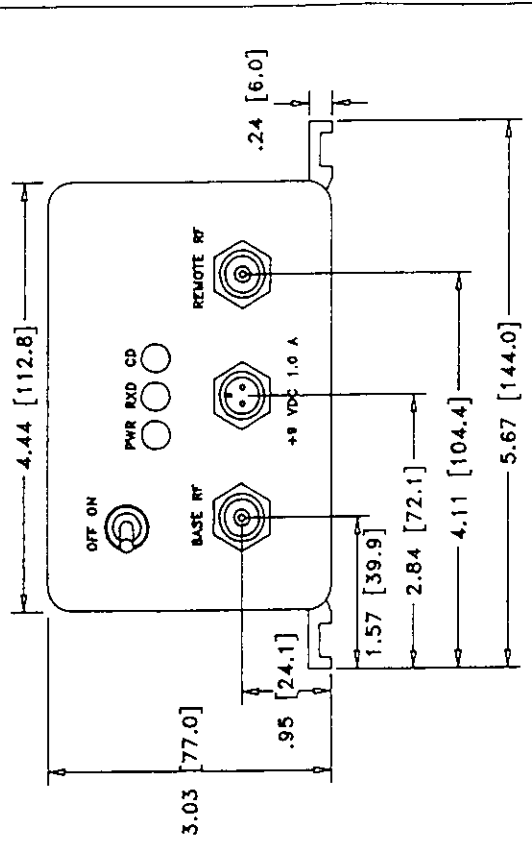

NOTE:  
 1. RF CONNECTORS ARE TNC JACKS.  
 2. POWER CONNECTOR IS CONXALL MICRO-CON-X  
 PART NO. 17 2 82-2PG-300  
 MATE: CONXALL NO. 16 2 8X-2SG-3XX

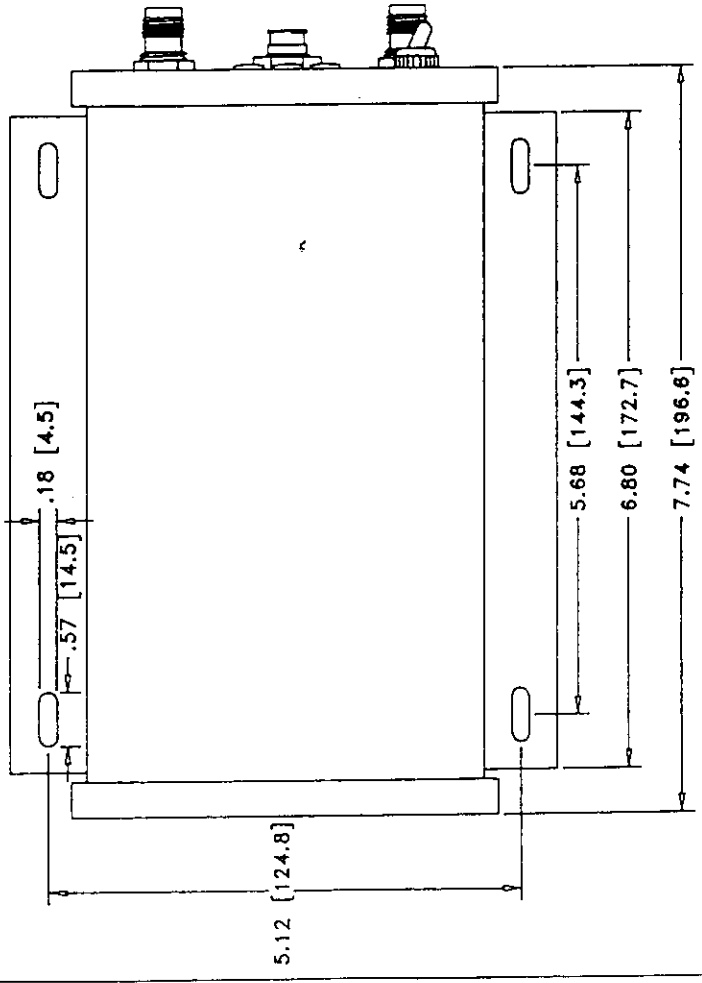
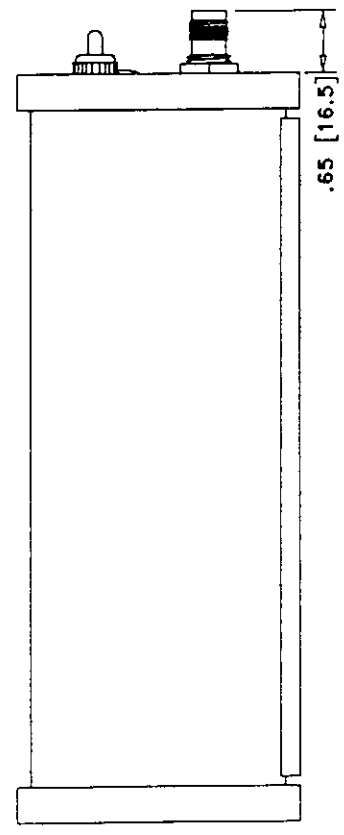

UNLESS OTHERWISE SPECIFIED DIMENSIONS ARE IN INCHES (DIMENSIONS IN PARENTHESES ARE IN MILLIMETERS)  
 TOLERANCES  
 .015 = ±.01 INCHES  
 .030 = ±.015 INCHES  
 .00048 = ±.00024 INCHES  
 .00010 = ±.00005 INCHES

THIRD ANGLE PROJECTION

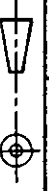

DATE	DATE	DATE	DESCRIPTION THIS FILE
16APR98	16APR98	16APR98	—
PM	PM	MT	—

DIGITAL WIRELESS CORP.  
 ONE MECA WAY, NORCROSS, GA 30083 USA  
 TEL (770) 684-6640 FAX (770) 684-6641

TITLE DRAWING,  
 OUTLINE, REPEATER,  
 HOPNET

SCALE	SCALE NUMBER	REV.
C	800219	---
1:2	800219	---
—	—	---



REVISIONS

REV	CC NO.	DESCRIPTION	DRN	ENGR. CHR.	DATE

NOTE:

1. COMM/POWER CONNECTOR IS A CONXALL MULTI-CON-X NO. 4 2 82-9 PG-300 MATE: CONXALL NO. 3 2 8X-9 SG-3XX
2. PATCH ANTENNA INTEGRATED INSIDE UNIT.

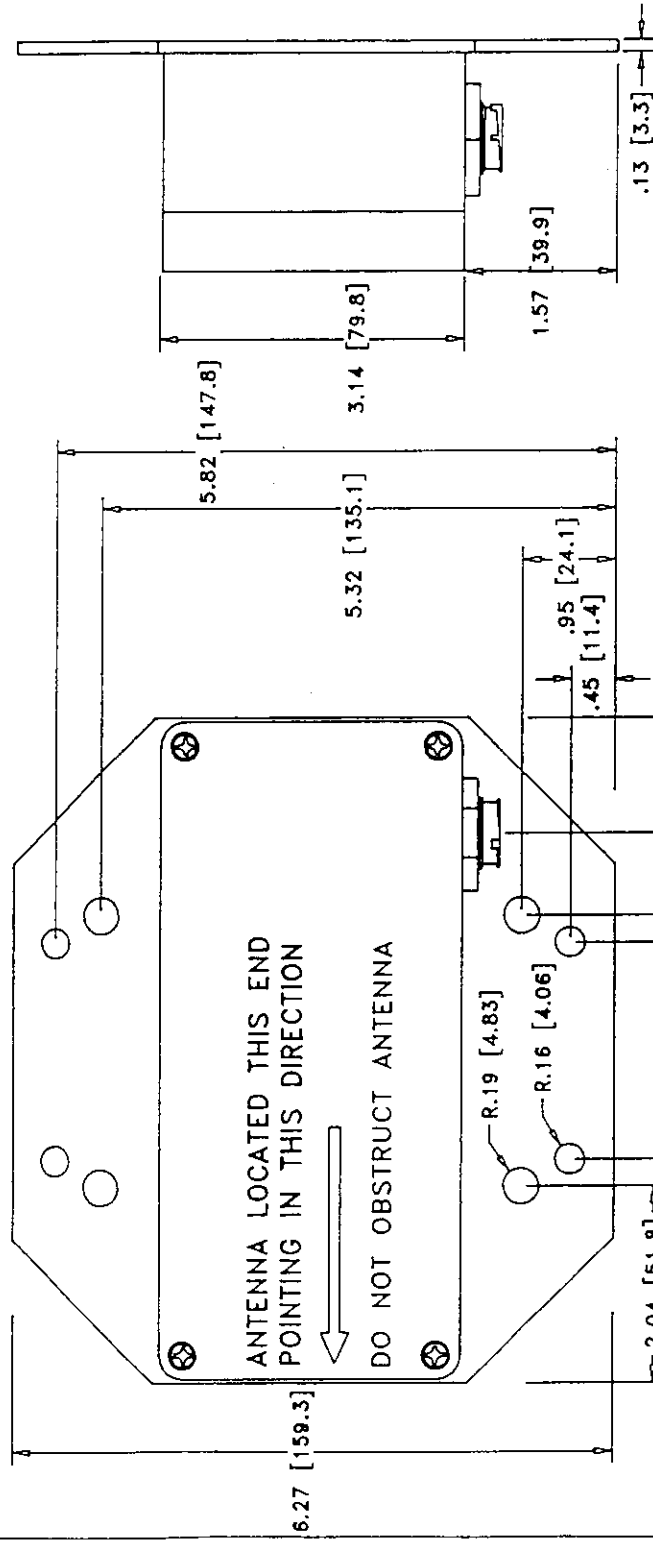
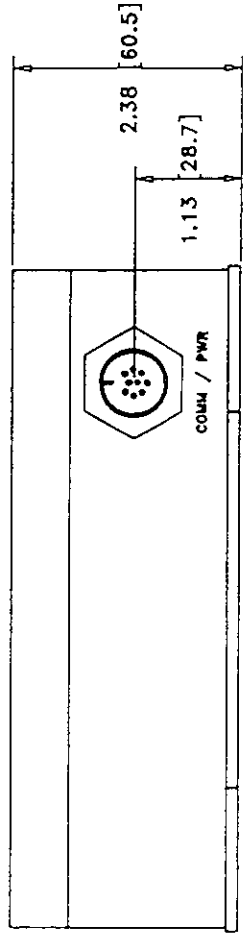

UNLESS OTHERWISE SPECIFIED DIMENSIONS ARE IN INCHES (MILLIMETERS)	
TOLERANCES	
XX = ±.03 INCHES	
[X] = ±.5 MM	
ANGULAR = ±.5 DEG	
[XX] = ±.15 MM	
THIRD ANGLE PROJECTION	
DATE	17APR98
ENGR.	PM
DATE	17APR98
ENGR. WFL	MT
TITLE DRAWING, OUTLINE, TERMINAL, WEATHERPROOF, HOPNET	
DESCRIPTION THIS PAGE	
SCALE	1:2
DWG NUMBER	800222
REV.	---
SHEET 1 OF 1	

DIGITAL WIRELESS CORP.

ONE MECA WAY, NORCROSS, GA 30093 USA  
TEL (770) 664-6640 FAX (770) 664-6641



# REVISIONS

REV	CC NO.	DESCRIPTION	DRN	ENGR. CHK.	DATE

TERMINAL BLOCK TO HOPNET BASE/REMOTE (RS 485)

CABLE MOUNT

DB 9 SOCKET TO DTE (PC; RS 232)

SEE NOTE 1

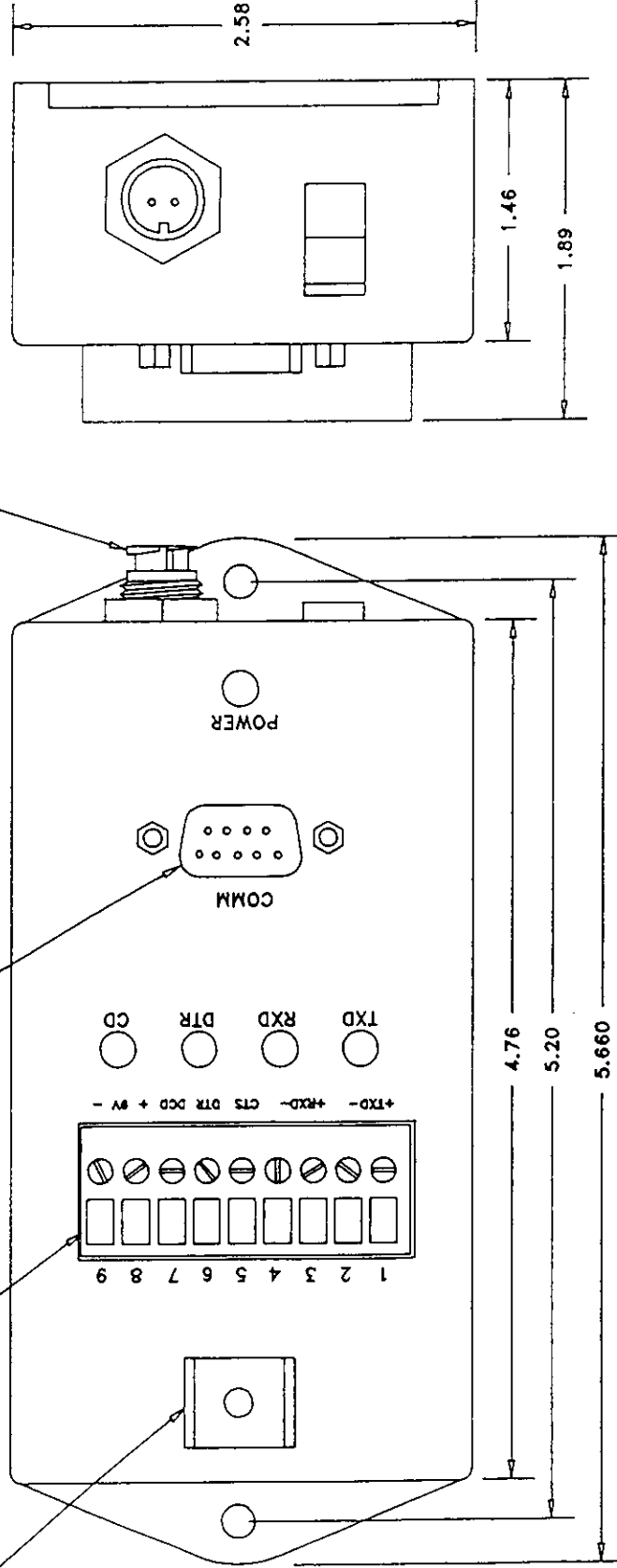

UNLESS OTHERWISE SPECIFIED DIMENSIONS ARE IN INCHES ( ) IN MILLIMETERS

TOLERANCES  
 XX = ±.02 INCHES  
 [X] = ±.5 MM  
 ANGULAR = ±.5 .XXX = ±.008 INCHES  
 [XX] = ±.15 MM

THIRD ANGLE PROJECTION

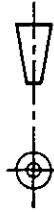

DRAWN: PM	DATE: 14MAY88
ENGR.	DATE
ENGR. MOR.	DATE

**DIGITAL WIRELESS CORP.**  
 ONE MECA WAY, NORCROSS, GA 30093 USA  
 TEL (770) 564-5540 FAX (770) 564-5541

TITLE: DRAWING, OUTLINE,  
 ADAPTOR, RS 232-RS 485,  
 HOPNET

DESCRIPTION THIS PAGE	SIZE: A	SCALE: 1:1	DOC NUMBER: 800227	REV: -
PART NUMBER: N/A	SHEET 1 OF 1			

NOTE:  
 1. POWER CONNECTOR IS CONXALL MICRO-CON-X  
 PART NO. 17 2 82-2PG-300  
 CONXALL NO. 16 2 8X-25G-3XX

# Appendix B

## Modem Command Summary

### Overview

---

#### Introduction

Refer to the following information for a summary of the command list for the HopNet products. These commands are hexadecimal values that you can use to configure the radio instead of using the NETCOM software.

#### Command Conventions

Brackets ([,]) as used here denote a set of optional arguments.

Vertical slashes separate selections. For example, given the string `wn[?|0..f]`, legal commands would be `wn?`, `wn0`, `wn3`, and `wna`.

Most commands which set a parameter also have a `?` option that displays the current parameter setting. For example, `wn?`.

#### In this Appendix

This chapter contains the following topics.

Topic	See Page
Network Commands	B-2
Serial Interface Commands	B-2
Protocol Commands	B-3
Status Commands	B-3
Memory Commands	B-3

## Protocol Commands

---

Command	Description
ph[?   00..ff]	Set Hop Duration
pk[?   00..ff]	Set Minimum Packet Length (remote only)
pl[?   00..ff]	Set Maximum Packet Length (remote only)
pt[?   00..ff]	Set Packet Timeout Duration (remote only)
pm[?   00..ff]	Set Link Margin (remote only)
pr[?   00..ff]	Set ARQ Attempt Limit (remote only)
py[?   00..ff]	Set ARQ Per-Hop Limit (remote only)
pb[?   00..ff]	Set CSMA Backoff Constant (remote only)
pp[?   00..ff]	Set CSMA Persistence (remote only)
ps[?   00..ff]	Set TDMA Time Slot (remote only)
pg[?   0   1]	Enable Peer Addressing (remote only)
px[?   0   1]	Enable Redundant Transmit
pe[?   0   1]	Enable Limited ETSI Channel Set
pd[?   0   1]	Enable Diversity Antenna

## Status Commands

---

Command	Description
zb[?   0   1]	Banner Display Disable
zc[?   0   1]	Escape Sequence Disable
zp[?   0   1]	Power Save Mode
z>	Exit Configuration Mode

## Memory Commands

---

Command	Description
m0	Recall Factory Defaults
m>	Store Memory
m<	Recall Memory



# Appendix C

## Accessories

### Overview

---

#### Introduction

This appendix provides information on the accessories that support the HopNet products.

#### In this Chapter

This chapter contains the following topics.

Topic	See Page
Antennas	C-2
Adapter	C-3
Power Supply	C-5

---

# Adapter

## Introduction

The HN-1000 and HN-3000 can be used with an RS-232 to RS-485 adapter (the HN-3500). The HN-3500 enables you to configure the HN-1000 and HN-3000 outdoor units from an RS-232 controller. The adapter housing is designed for an indoor environment.

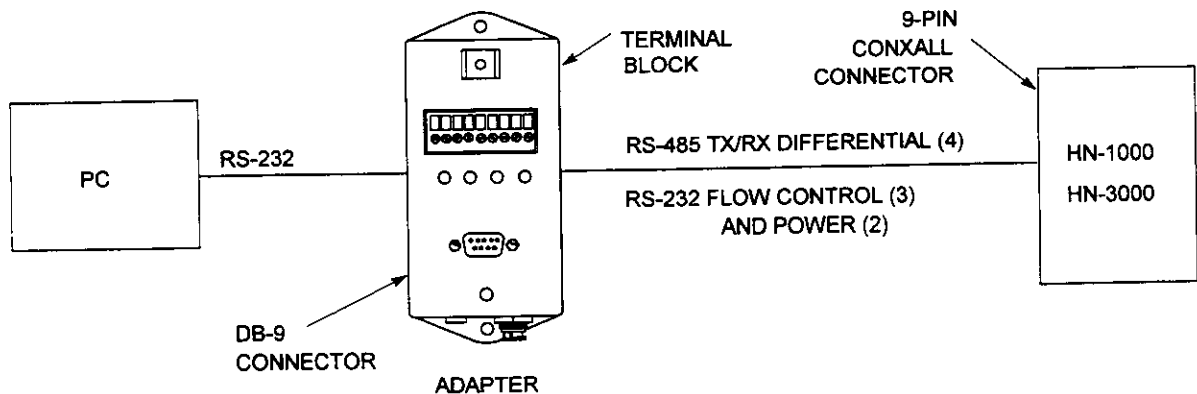

## Flow Control Indicators

The HN-3500 has flow control indicators for testing and as a way to quickly check the operation of the adapter. Refer to the illustration below.

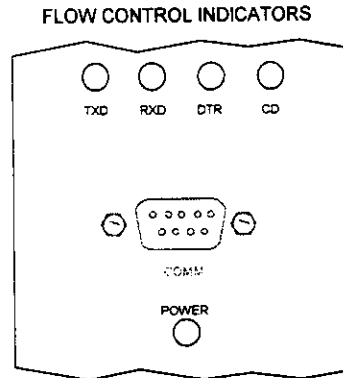

The table below describes the function of each LED.

Name	Color	Description
TXD	Red	Transmit Data
RXD	Red	Receive Data
DTR	Red	Data Terminal Ready
CD	Red	Carrier Detect
PWR	Green	Continuous DC power is applied

# Power Supply

---

## Introduction

The HN-3500 provides the power necessary to operate the HopNet products. This power supply can also power the HN-2000. The power supply is designed for an indoor environment. The part number for this power supply is A-3200-1000.

## AC to DC Conversion

The external power supply connects to a 2-pin Conxall connector on the HN-3500 adapter. The adapter converts 115 AC to +9 VDC.

# Index

---

## #

- 3-Way Switch, HN-2000, 1-15
- 9-Pin Conxall Connector, 1-5, 1-20

## A

- Accessories, C-1
- Adapter, C-3
- Aiming the Antenna, HN-3000, 1-22
- Antennas
  - Corner Reflector, C-2
  - Omni 24-2, C-2
  - Omni 24-9, C-2
  - Omni 24-12, C-2
  - Yagi 24/14, C-2
- Antenna Connection
  - HN-1000, 1-6
  - HN-1500, 1-10
  - HN-2000, 1-14
- Antenna Recommendations, 2-8
- Antenna Selection, 3-17
- Approvals
  - HN-1000, 1-7
  - HN-1500, 1-11
  - HN-2000, 1-18
  - HN-3000, 1-23
- ARQ, 1-2
- ARQ Attempt Limit, 3-14
- ARQ Commands, 3-13
- ARQ Per-Hop Limit, 3-14
- Asynchronous Data Format, 3-12

## B

- Banner Display, 3-12
- Battery Operating Time,
  - HN-2000, 1-18
- bps, 1-2
- Built-In Antenna Units,
  - 1-1

## C

- Cable Interface,
  - HN-3000, 1-22
- Channel Access, 2-3
- Channel Data Rate
  - HN-1500, 1-11
- Communication Parameters, 3-5
- Communication Ports, 3-5
- Configuring
  - ARQ Commands, 3-13
  - Base Stations, 4-2
  - CSMA Multipoint Networks with Four Remotes, 4-2
  - Network Commands, 3-7
  - Point-to-Point Network with a Repeater, 4-6
  - Remote Units, 4-3
  - RF Commands, 3-15
  - Serial Commands, 3-11
- Connector
  - Conxall, 1-5, 1-20
  - DB-9, 1-9, 1-14
- Contention Protocols, 2-9
- Conxall Power Connector, 1-5, 1-20
- Corner Reflector Antenna, C-2
- CSMA, 1-2, 2-9
- CSMA Backoff Constant, 3-10
- CSMA Parameters, 4-2
- CSMA Persistence, 3-10
- Customer Support, 5-5

## D

- Data Interface
  - HN-1000, 1-7
  - HN-1500, 1-11
  - HN-2000, 1-18
  - HN-3000, 1-23
- Data Rate
  - HN-1000, 1-7
  - HN-1500, 1-11
- Data Transmission
  - HN-1000, 1-5
  - HN-1500, 1-9

## **N**

### **NETCOM**

- Installing, 3-4
- Menu Functions, 3-6
- Using, 3-3
- Network Commands, 3-7, B-2
- Network Communication, 2-2
- Network Number, 3-7
- Network Protocol
  - HN-1000, 1-7
  - HN-1500, 1-11
- Number of Channels
  - HN-1000, 1-7
  - HN-1500, 1-11
  - HN-2000, 1-18
  - HN-3000, 1-23

## **O**

- Omni 24-2 Antenna, C-2
- Omni 24-9 Antenna, C-2
- Omni 24-12 Antenna, C-2
- Operating Frequency, 1-4
- Operating Margin of System, 3-17
- Output Impedance
  - HN-1000, 1-7
  - HN-1500, 1-11

## **P**

- Packet Format, 2-6
- Packet Length
  - Maximum, 3-9
  - Minimum, 3-9
- Packet Mode, 3-12
- Packet Timeout Duration, 3-9
- Pin-Out, Conxall Connector, 1-5, 1-20
- Point-to-Multipoint Network, 2-6
- Point-to-Point Networks, 2-4
- Power Connection
  - HN-1000, 1-7
  - HN-1500, 1-11
  - HN-2000, 1-19
  - HN-3000, 1-23
- Power Supply
  - HN-2000, 1-18
  - HN-3500, C-5
- Power Save Mode, 3-16

- Printing the Network Configuration, 4-5
- Programming Examples, 4-1
- Protocol Commands, B-3

## **R**

- Receiver Sensitivity
  - HN-1000, 1-7
  - HN-1500, 1-11
  - HN-2000, 1-18
  - HN-3000, 1-23
- Redundant Transmit, 3-13
- RF Bandwidth
  - HN-1000, 1-7
  - HN-1500, 1-11
- RF Channel Data Rate
  - HN-1000, 1-7
- RF Commands, 3-15
- RF Link Data Flow, 2-2
- RMA, 1-3
- RTU, 1-3

## **S**

- Saving the Network Configuration, 4-4
- Serial Commands, 3-11
- Serial Data Interface
  - HN-1000, 1-7
  - HN-1500, 1-11
- Serial Interface Commands, B-2
- Set ARQ Attempt Limit, 3-14
- Set ARQ Per-Hop Limit, 3-14
- Set Channel Access Mode, 3-9
- Set CSMA Backoff Constant, 3-10
- Set CSMA Persistence, 3-10
- Set Data Rate, 3-11
- Set Destination Address, 3-8
- Set Hop Duration, 3-8
- Set Link Margin, 3-16
- Set Maximum Packet Length, 3-9
- Set Minimum Packet Length, 3-9
- Set Network Number, 3-7
- Set Packet Mode, 3-12
- Set Packet Timeout Duration, 3-9
- Set Source Address, 3-8
- Set Sync/Async, 3-12
- Set TDMA Time Slot, 3-10
- Set Transmit Power, 3-15

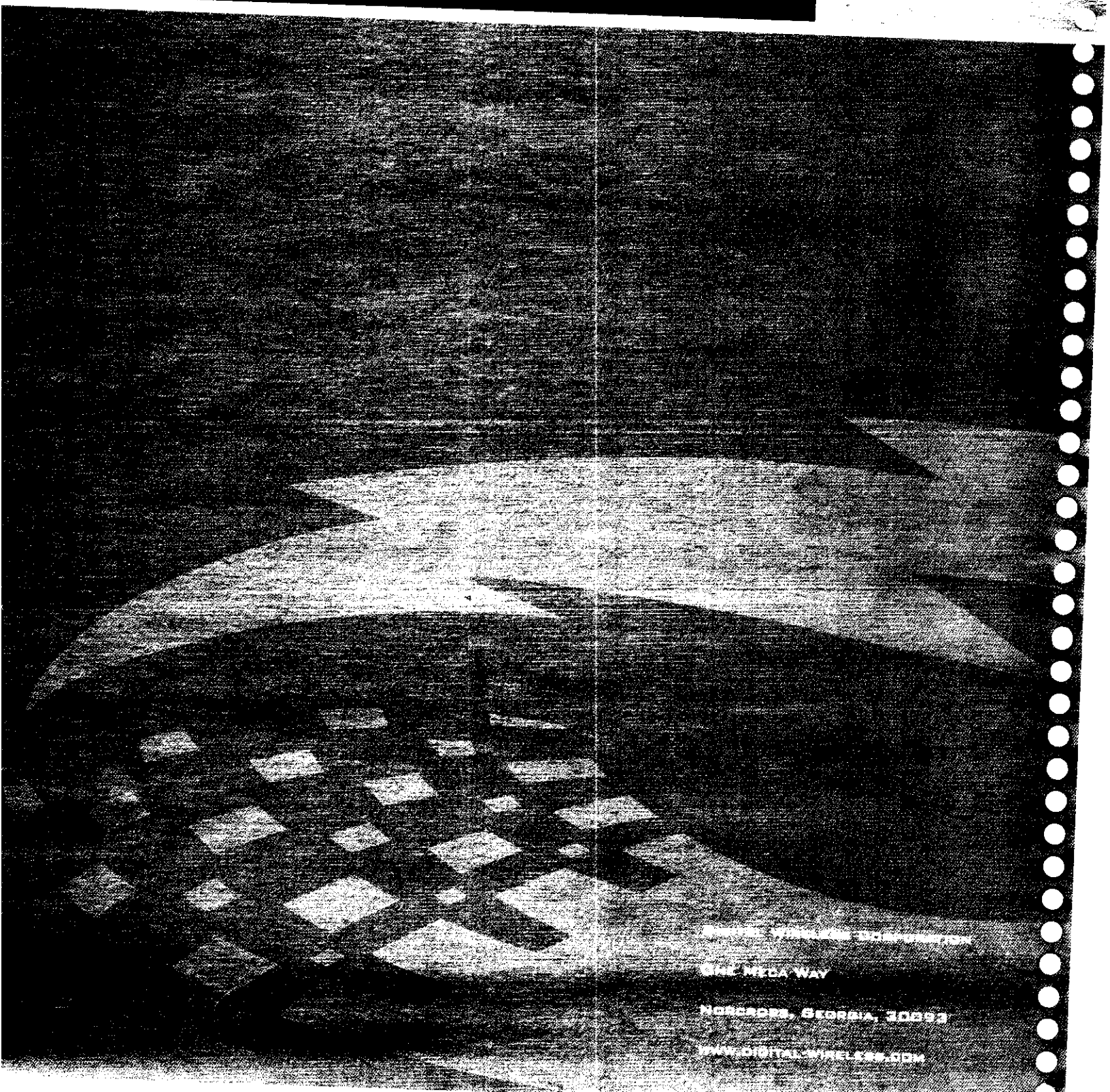
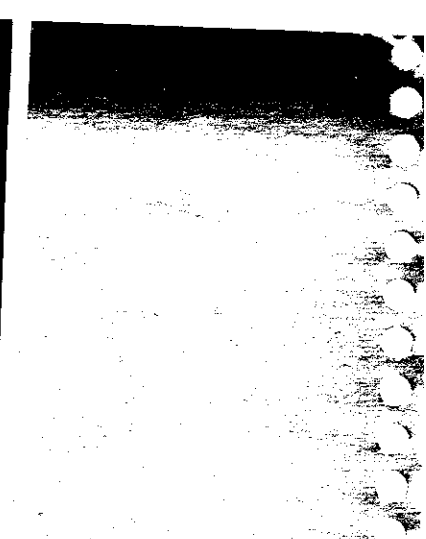
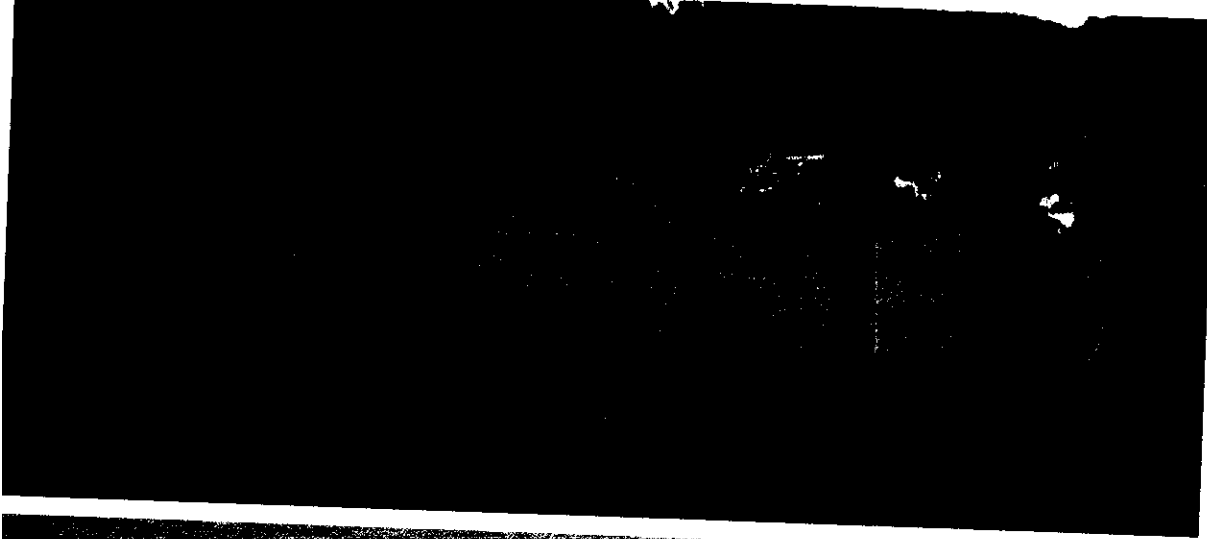

DIGITAL WIRELESS CORPORATION

ONE MEGA WAY

NORCROSS, GEORGIA, 30093

[WWW.DIGITALWIRELESS.COM](http://WWW.DIGITALWIRELESS.COM)

Sleep Mode, 2-16  
Source Address, 3-8  
Status Commands, B-3  
Supply Current  
    HN-2000, 1-18  
Synchronizing the Base with the Remotes,  
    2-2  
Synchronous Data Format, 3-12

## **T**

TDMA, 1-3, 2-10  
Technical Assistance, 5-5  
Terminal Block, HN-3500, C-4  
Testing Your Network Site, 3-18  
Three-Way Switch, HN-2000, 1-15  
Transmit Power  
    HN-2000, 1-18  
    HN-3000, 1-23  
Transmitter FCC ID  
    HN-2000, 1-18  
    HN-3000, 1-23  
Transparent Broadcast Network, 2-11  
TX Power Output  
    HN-1000, 1-7  
    HN-1500, 1-11

## **U-Z**

Yagi Antenna, C-2





# Adapter, Continued

## DB-9 Connector

The HN-3500 is equipped with a DB-9 connector to link the RS-232 interface to a terminal block for the RS-485 interface. See the following illustration for the signal description.

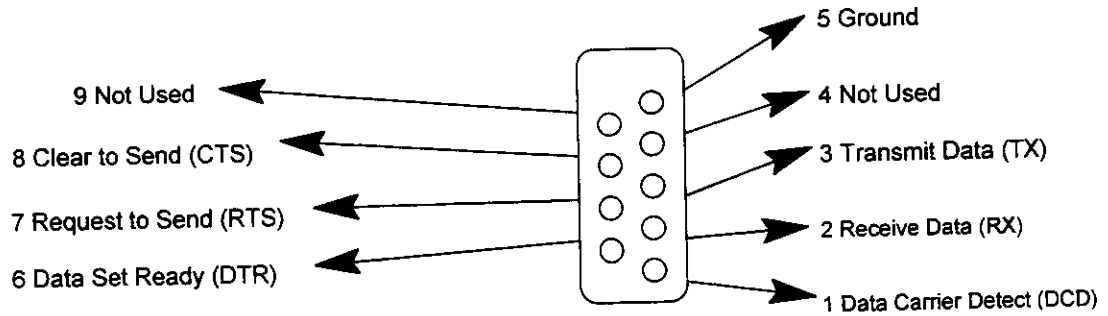

## Terminal Block

The terminal block on the connector converts RX and TX RS-232 signals into RS-485 differential. The terminal block also passes the following signals to the HN-1000 and HN-3000:

- CTS
- DTR
- DCD
- 9 VDC

See the illustration below of the terminal block.

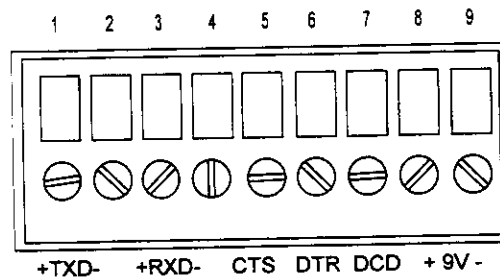

# Antennas

---

## Types of Antennas

The HopNet product line can be used with a number of antennas. The physical layout of your system determines the style of antenna you should use.

At the base station, an omni-directional antenna is normally used to ensure coverage to all of the remote sites.

See the table below for a selection of antennas available from Digital Wireless Corporation.

Description	Gain	Coupling	Part #
Omni 24-2 Omni-directional	2 dB	N	A-7000-0200
Omni 24-9 Omni-directional	9 dB	N	A-7000-0900
Omni 24-12 Omni-directional	14 dB	N	A-7000-1200
Yagi 24/15 Directional	15 dB	N	A-7000-2415
Corner Reflector	14 dB	N	A-7000-1400

## Guidelines

Follow these guidelines for mounting your antenna:

- Be sure that a clear transmission path exists between units. The radio signals travel primarily by line of sight (LOS), and obstructions between stations will degrade the system performance.
- Mount the antenna on a tower or other elevated structure to ensure that you have a clear LOS transmission path between the base and remote unit. This will raise the antenna to a level sufficient to clear surrounding terrain and other obstructions.
- Remember that a clear transmission path is more important for longer range systems than for systems that cover a limited geographical area such as 2 to 4 miles. Limited coverage areas can tolerate some obstruction.



## Network Commands

---

Command	Description
wn[? 0..f]	Set Network Number
wb[? 0 1]	Set Base/Remote
wd[? 00..ff]	Set Destination Address (base only)
ws[? 00..fe]	Set Source Address (remote only)
wt[? 0 1]	Set Channel Access Mode (remote only)
wp[? 0 1]	Set Transmit Power

## Serial Interface Commands

---

Command	Description
sd[? 009..3ff]	Set Data Rate Divisor
sy[? 0 1]	Set Sync/Async
sp[? 0 1]	Set Packet Mode (base only)





## Guidelines for Reducing Interference, Continued

---

### Guidelines for Avoiding Terrain Obstructions

The HopNet transceivers operate in the 2.4GHZ frequency band. While this band offers many advantages over the VHF for data transmission, it is also more prone to signal attenuation from obstructions such as terrain, foliage, buildings and anything in the transmission path.

Use the following guidelines to avoid terrain obstructions:

- A line-of-sight transmission path between the master and the associated remote sites provides for the most reliable transmission path.
- A line-of-sight path can be achieved by mounting the station antenna on a tower or elevated structure that raises it to a sufficient level to clear surrounding terrain and other obstructions.
- The importance of a clear transmission path relates closely to the distance to be covered. If the system is to cover only a limited geographical area such as 1-3 miles, then some obstructions may be tolerated with minimal impact.
- For longer-range systems, any substantial obstruction in the transmission path could compromise the performance of the system.

# Troubleshooting Table

---

## Common System Problems

The following table offers suggestions for resolving some common systems problems that the operator may experience from the radio system. If problems persist, contact the factory for further assistance.

Problem	System Checks
Unit is inoperative	<ol style="list-style-type: none"><li data-bbox="646 495 1347 562">1. Check for proper DC voltage at the power connector.</li><li data-bbox="646 579 1347 611">2. Momentarily remove and reapply power.</li></ol>
No Carrier Detect at remote units or intermittent	<ol style="list-style-type: none"><li data-bbox="646 632 1347 699">1. Check for secure interface connections at the transceiver.</li><li data-bbox="646 716 1347 783">2. Check antenna, feedline, connectors, and reflective power.</li><li data-bbox="646 800 1347 947">3. If remote unit is in synchronization but performance is poor, it may indicate antenna problems. Check for properly aligned antenna headings.</li><li data-bbox="646 963 1347 1031">4. Verify proper programming of the system parameters.</li></ol>
Interference is suspected	<ol style="list-style-type: none"><li data-bbox="646 1052 1347 1157">1. Verify that the system has a unique network address. Nearby systems with same address will cause interference problems.</li><li data-bbox="646 1173 1347 1314">2. If Omni-directional antennas are used with the remote units, consider using a directional type instead. This will often limit interference to and from other stations.</li></ol>





# HOPNET HN-2000 Repeater Configuration

---

## Introduction

The HOPNET HN-2000 repeater acts as a bridge between two HopNet wireless networks to extend range or coverage area. The following information illustrates how messages flow through the network.

## Example

Internally, the repeater essentially consists of two modems with connected data lines - one modem is a "base," the other a "remote." As an example, assume you have a network **A** you wish to extend the range of. The remote half of the repeater is programmed to communicate with network **A**. The base half of the repeater will be programmed to create a second network, **B**. New remotes may then be added to network **B**.

	<i>Original Base ("A")</i>	<i>Repeater Remote ("A")</i>	<i>Repeater Base ("B")</i>	<i>New Remote ("B")</i>
data rate :	sd009	sd009	sd009	sd083
network :	wnA	wnA	wnB	wnB
base/remote :	wb1	wb0	wb1	wb0
hop rate :	ph9A	ph9A	ph9B	ph9B
packet mode :	sp1	sp0	sp1	sp0
CSMA persistence :	---	ppff	---	---
source address :	---	wsA3	---	wsB1

Sample repeater configuration settings (multipoint network).

At this point, all messages from the new remotes in **B** will flow through the repeater to the original base station in network **A**. Further setup is required to send messages from the base back to a remote. If simple point-to-point operation is sufficient, the network can be made completely transparent by setting the source address ('ws') and destination address ('wd') parameters equal for the original base, the repeater remote, the repeater base, and the new remote. For multipoint operation, unique source addresses must be assigned to each remote in the network (including the repeater remote) and packet headers containing addressing information must be applied to all data entering or leaving the base stations, as described in **Multipoint Networks** in Chapter 2. Source addresses for remotes assigned to different networks may overlap if desired, although for most applications it may be simpler to keep them distinct.

For communication with remotes within the original network, no change in protocol is required. To send a packet from the base through the repeater to a remote in the second network, a second packet wrapper is required.

For example, to send the packet "TEST123" to a remote belonging to the original network (**A**) with address 01H, the following packet format would be used:

Start	Addr	Len								End
STX	01	7	T	E	S	T	1	2	3	ETX

## Configuring a Point-to-Point Network with a Repeater, Continued

---

### Saving the Network Configuration

Follow these steps to save the network configuration.

1. Click on the **Network** option.
2. Click on the **Save As** option.
3. Type in **Base Station** as the file name and click **Save**.  
You can now configure side 2 of the network.

### Configuring Side 2 of the Network

Follow these steps to configure side 2 of the network.

1. Select **Network**.
2. Open the **Base Station** configuration file.
3. Select **Base** from the radio listbox.
4. Click on **Network #** and enter 5.
5. Select **Hop Duration** and enter 200.  
**Note:** The network numbers and the hop duration were arbitrarily chosen. It is important to note that these numbers need to be different from side 1 of the network.
6. Select **Remote** from the radio listbox.
7. Click on **Source Address** and enter 170.  
You can now download the configuration to the radio.
8. Connect the cable to the remote unit (HN-1000 or HN-1500/HN-3000).
9. Ensure that power is applied and click the **Download...** button.
10.
  - If the download is successful, the system will prompt you. Click **OK** to return to the NETCOM Configuration Program window.
  - If the download is unsuccessful, identify the error, correct it, and click **Retry**.
11. Select **Base** from the radio listbox.
12. Connect the serial cable to the DB-9 connector of the HN-2000. .
13. Be sure that power is supplied to the repeater and flip the 3-way switch to the left position. Be sure that the green LED is on.
14. Click the **Download...** button.

# Configuring a Point-to-Point Network with a Repeater

## Introduction

In a point-to-point network configuration, you may need to extend the range because of obstruction or because you have reached the line of sight limit. You can add a repeater to the network to extend the range.

The HN-2000 Repeater must be configured as two separate networks. Configure one side as a base and the other side as a remote. See the illustration below.

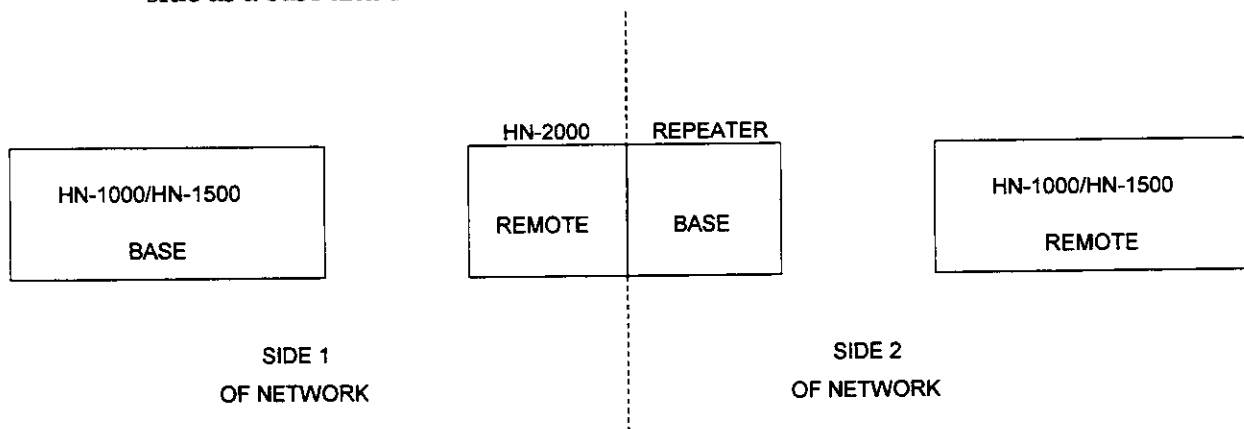

## Programming Side 1 of the Network

Follow these steps to program side 1 of the network.

1. Select the **Network** option and click **New**.
2. Enter **1** remote and click **OK**.
3. Click on the **Base** radio from the radio listbox.
4. Enter **3** for the **Network Number**.
5. Click on the **Serial** tab.
6. Enter a data rate of **38400** bps.
7. Click on the **Remote** radio from the radio listbox.
8. Click on the **Network** tab.
9. Click on **CSMA Persistence** and enter **255**.

This value programs the radio to transmit without waiting, which maximizes throughput for point-to-point operation.

10. Click on **Source** address and enter **170**.
11. Click on the **Serial** tab.
12. Enter a data rate of **38400** bps.

You can now download the configuration to the base station side of the network.

## Configuring a CSMA Multipoint Network with Four Remotes, Continued

---

### Downloading the Configuration

Follow these steps to download radio configuration parameters to selected radios in this multipoint network.

1. Use a straight-thru cable to connect the download radio to the serial port of the terminal.
2. From the listbox on the NETCOM Configuration Program window, highlight the radio to which you wish to download radio configuration parameters.
3. Click the **Download...** button at the bottom right of the window. The system prompts you to confirm the download.
4. Do you wish to download this radio configuration?
  - If yes, select **Yes** to download the configuration parameters. The system prompts you to check the communication port and to be sure that the radio is on.
  - If no, select **No** to return to the NETCOM Configuration Program window.
5. Click **OK** to download the radio configuration.
6.
  - If the download is successful, the system will prompt you. Click **OK** to return to the NETCOM Configuration Program window.
  - If the download is unsuccessful, identify the error, correct it, and click **Retry**.
7. Repeat this procedure for each radio to which you wish to download the radio configuration.
8. Go to **Saving the Network Configuration**.

### Saving the Network Configuration

Follow these steps to save the network configuration.

1. Click on the **Network** option.
2. Click on the **Save As** option.
3. Type in a file name (for example, **Temp4remotes**) and click **Save**.  
This saves your network configuration in the NETCOM directory with an **nwk** extension.

# Configuring a CSMA Multipoint Network with Four Remotes

---

## Introduction

The following is an example of programming a CSMA network with four remotes. In a CSMA network, each remote will be programmed with a distinct address. In multipoint operation, the base must be set for packet mode for sending and receiving data. Packet mode provides a way for the base station to tell the user which remote sent a particular message. This allows the user to send data to a particular remote by transmitting with the proper packet format.

## CSMA Parameters

The two parameters that affect CSMA performance are persistence and backoff constant. The persistence setting is the chance of transmitting on the first attempt. The backoff constant is the setting for telling the unit how long to wait before re-transmitting after a collision.

The default settings for these parameters are based on a network of 32 remote units with a hop duration of 24 milliseconds.

You should increase your persistence if your application has fewer remotes. Refer to the following table.

Number of Remotes	Persistence
2	.90
4	.75
16	0.5

## Configuring the Base Station

Follow these steps to program the base station side of a CSMA network with four remotes.

1. Start the NETCOM software and select **New network**.
2. In the **Number of Remotes** box, select **4** and click **OK**.
3. Highlight the base by clicking on the base radio in the listbox for the radios.
4. Click on **Network Number** and type in **3**.
5. Click on the **Serial** tab.
6. In the **Data Format** box, select **Multipoint**.

This completes the configuration of the base station. You can now download the configuration to the base station or proceed with the remote configuration.

7. If you need to download the configuration to the base station, proceed to **Downloading the Configuration**. Otherwise, go to **Configuring the Remote Unit** on the next page.

## Installing the HopNet Products, Continued

---

2. Measure and install primary power source for the radio. It must be within 7.5 to 12 VDC and capable of furnishing 750 milliamperes.
3. Install the antenna and antenna feedline for the station. The HN-3000 does not require an external antenna or feedline. Preset the directional antenna as required.
4. Connect the data equipment to the interface connection. Most applications only require that you connect TXD, RXD, and signal ground for proper operation.
5. Set and confirm the radio configuration as follows:
  - Network setup
  - Baud rate
  - Protocol commands
  - Memory commands

## Testing Your Network Site

---

If you are in doubt about the suitability of your network site, follow these steps to perform an over-the-air test survey.

1. Install a transceiver at the proposed base station site with the proposed antenna in its final position.
2. Visit each remote unit site with a transceiver and a hand-held antenna and verify carrier detect. This indicates that the remote unit is in range of the base.



## Configuring the RF Commands, Continued

---

### Set Link Margin

Sets the number of consecutive hops on which a remote unit can fail to hear the base station signal before dropping DCD and attempting to reacquire. Smaller values are useful if more rapid indication of signal loss is required. Larger values will prevent DCD from fluctuating excessively at the edge of range. For most applications, a value of 16 is sufficient.

### Enable Diversity Antenna

Allows the radio to operate with a steerable antenna. Each time a packet is received unsuccessfully, the receiving radio switches its antenna.

This provides an alternate, uncorrelated path for the sender to retransmit its message.

The alternate antenna configuration is selected by switching on a 5 VDC bias applied to the RF output. This requires a special antenna capable of being steered by the bias voltage.

### Power Save Mode

Enables smart power management, allowing a remote unit to drop into a lower current standby mode during gaps of time between transmitting and receiving.

Using power save mode increases transmit latency.

## Configuring the ARQ Commands, Continued

---

### Set ARQ Attempt Limit

Sets the number of times the radio will attempt to send an incorrect packet before discarding it. A value of zero disables ARQ.

Setting this parameter to 255 will cause the radio to re-send messages indefinitely until they are acknowledged.

### Set ARQ Per-Hop Limit

Sets the number of times the radio will attempt to send an incorrect packet on a given hop.

In a multipoint application, this setting can prevent a radio that has an obstructed path on a particular hop from taking up bandwidth that could be used by other radios that may have a better chance of transmitting successfully.

**Important:** If you select a short hop duration, set this parameter to a small value.

## Configuring the Serial Commands, Continued

---

### Set Packet Mode

Enables the base station to operate in a multipoint network.

In order for the base station to distinguish data streams from multiple remote units, user data that comes to and from the base station must conform to the packet format.

### Set Sync/Async

Selects the data format as standard asynchronous (8 data bits, 1 stop bit). Refer to the following illustration.

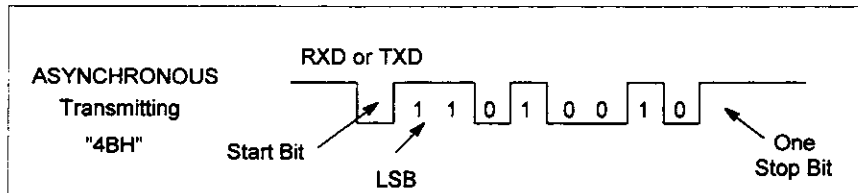

**Important:** HopNet products may only be configured as Async.

### Enable Banner Display

Enables or disables display of the banner string and revision code automatically at power-up.

You can disable the banner display to avoid being mistaken for data by the host.

### Escape Sequence Disable

Allows you to disable the `:wit2400` escape sequence.

In most applications, accessing modem control mode is not necessary during system operation.

Since data is often unpredictable, you can disable the escape sequence to avoid interpreting a possible data sequence of `:wit2400` at power-up as a command to enter control mode.

**Important:** Disabling the escape sequence will prohibit the user from accessing configuration mode.

## Configuring the Network Commands, Continued

---

### Set CSMA Backoff Constant

In CSMA mode, defines the maximum time that a remote unit will wait before attempting to send the packet again (also called the backoff interval).

Enter this value in 153.6  $\mu$ s increments.

### Set CSMA Persistence

In CSMA mode, sets the probability that a remote unit will transmit immediately rather than first waiting for a backoff interval. Use these guidelines for setting this parameter:

- For lightly loaded networks, increase persistence to 128 or higher to reduce latency.
- For heavily loaded networks, reduce persistence to 32 or lower for better throughput.

**Important:** For point-to-point applications, set persistence to 255 for maximum throughput and shortest latency.

### Set TDMA Time Slot

In TDMA mode, sets the beginning of the time slot in which the remote unit will transmit. Enter this value in 153.6  $\mu$ s increments.

## Configuring the Network Commands, Continued

---

### Set Hop Duration

Sets the length of time the transceiver spends on each frequency channel. Enter the values in hexadecimal as follows:

- A smaller value allows the remote unit to lock onto the base signal faster at system startup and will generally decrease packet latency.
- A larger value increases network capacity, due to decreased overhead in channel switching.

The hop duration is specified in 153.6  $\mu$ s increments. The default value of 156 corresponds to a duration of 24 ms. The maximum value of 255 is 40 ms.

**Important:** For best results, do not specify a duration of less than 6 ms.

### Set Source Address/Set Destination Address

Sets the source address for remote units and the destination address for the base station.

You must configure each remote in the network with a distinct source address. To send data to a remote, set the base station's destination address. Since there is only one base unit, it does not require a source address and the remotes do not require a destination address.

If your application is a point-to-point network using only one remote, make the base's destination address the same as the remote's source address (this is the default).

Destination address 155 (FFH) specifies a broadcast message to all remotes. Since broadcast messages may have multiple recipients, the ARQ mechanism is not able to correct for missed or incorrect packets.

### Enable Peer Addressing

Causes a remote unit to report its destination address instead of its source address when transmitting a packet to the base. Ordinarily, remote units do not use the destination address. This mode is rarely used. This mode enables you to set a peer-to-peer connection between a pair of remotes using a looped-back base station as a type of repeater.

## Using the NETCOM Configuration Program Window, Continued

---

### Menu Functions

From the NETCOM Configuration Program window, you can do the following:

- Perform basic file functions:
  - Create a new configuration file
  - Open an existing configuration file
  - Save a NETCOM configuration
  - Save a NETCOM configuration as a new name
- Configure four main areas of a HopNet network:
  - Network
  - Serial
  - ARQ
  - RF
- Configure the radios in your network:
  - Add radios
  - Delete radios
  - Select all radios
  - Select all remotes
  - Download a radio configuration
  - Upload a radio configuration
  - Restore factory defaults

## Installing the NETCOM Software

---

Follow these steps to install the NETCOM software.

1. Be sure that your monitor is set up for 800 by 600 pixels.
2. Insert the NETCOM diskette into the floppy drive of your computer.
3. Click on **Start** from the taskbar and do the following:
  - Highlight **Programs**.
  - Highlight **Window Explorer**.
4. From Explorer, select the **A:** drive
5. Copy the **NETCOM** application to the appropriate directory on your **C:** drive.

The NETCOM software loads onto your computer in the specified directory.

## Overview, Continued

---

### Related Information

See Chapter 4 for programming examples.

See *Appendix B* for a summary of all the modem commands.



# Minimizing Power Consumption

---

## Introduction

HopNet products offer a way to minimize power consumption.

## Power Consumption

HopNet remote units can stay linked to a network while neither transmitting nor receiving data with a typical power consumption of about 30 mA. As network activity increases, this consumption increases as the transmit duty cycle increases.

## Sleep Mode

HopNet units can be put into a reduced power consumption sleep mode via the DTR pin. However, the link time from wakeup for a frequency hopping modem, such as HopNet, can often take 2 to 3 seconds. If this delay time is tolerable, you can greatly reduce power consumption by using sleep mode.

# Multipoint Network Examples, Continued

## Example 3

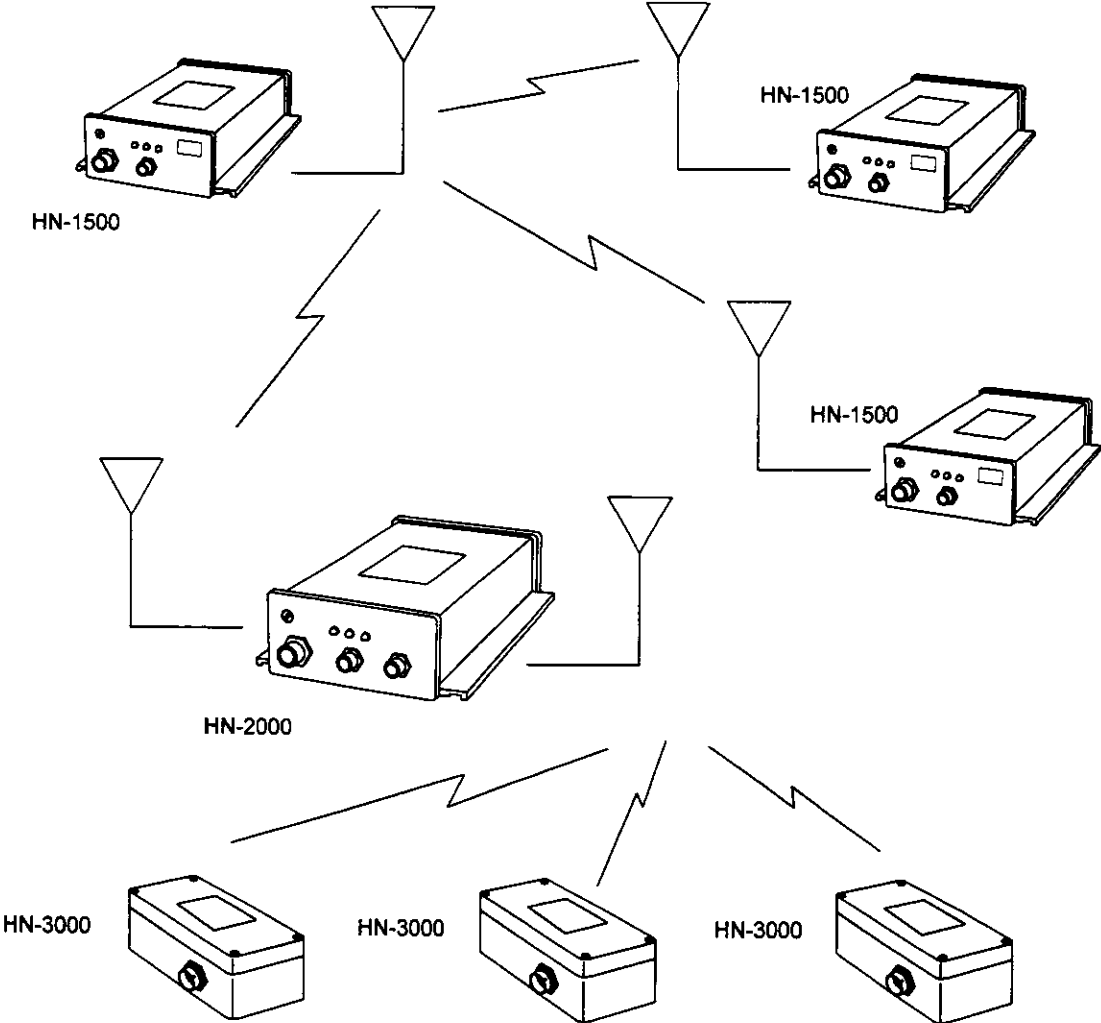

# Multipoint Network Examples

## Typical Point-to-Multipoint Network

Refer to the following examples of typical point-to-multipoint networks:

### Example 1

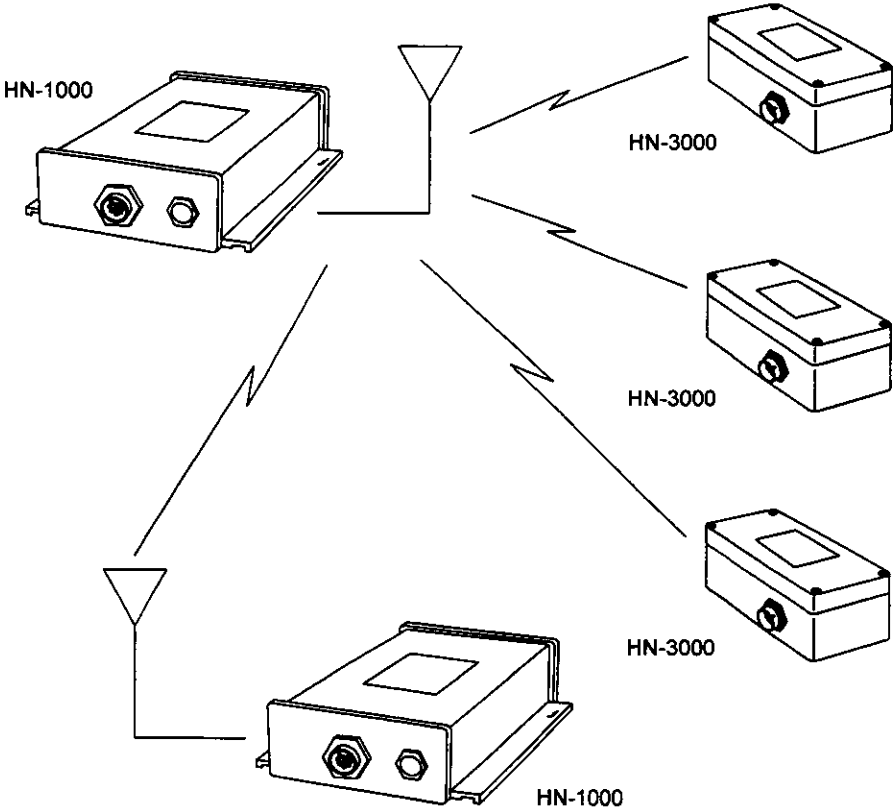

## Multipoint Networks, Continued

### TDMA

Time-division multiple access (TDMA) is the other multipoint protocol built into the HopNet products. The TDMA protocol allocates fixed portions of bandwidth by providing a time slot for transmissions from each remote modem on every frequency hop.

With TDMA, each remote is programmed to transmit during an individual dedicated time slot. Since bandwidth is reserved for each unit in advance, channel availability is more consistent than with CSMA. TDMA results in less overhead in a heavily loaded network. The TDMA mode works best with a fixed number of remote units with consistent, regular bandwidth needs.

The TDMA mode offers several advantages, but requires more planning to set up. The NETCOM software has a worksheet to help you set up the TDMA mode. See the illustration below:

Radio	Frequency	Data Rate	Capacity	Time Slot
Base	115200	0	81	0
Remote 0	9600	23936	81	0
Remote 1	9600	23936	81	28
Remote 2	9600	23936	81	56
Remote 4	9600	23936	81	112
Remote 5	9600	23936	81	140
Remote 6	9600	23936	81	168

The TDMA grid displays the Data Rate and Capacity, Maximum Packet Length and Time Slot values for each radio in the network.

Click on an individual row to select a specific radio. Hold the <Shift> key down and click a second radio to select an entire range of radios.

The worksheet will automatically set the following parameters for the number of units you have selected in your network:

- Data capacity
- Maximum packet length
- Time slot

# Multipoint Networks, Continued

---

## Antenna Recommendations

Maximum range can be achieved by using the 9 dB or 12 dB omni-directional antenna on the base station node and the 15 dB Yagi antenna on the remote nodes of the network. You must take special care to properly aim the highly directional 15 dB Yagi antenna.

## Throughput

The over-the-air rate for the HopNet network is 250 Kbps; however, a practical limit for throughput under typical conditions is approximately 100 Kbps up to 150 Kbps (depending on the network function). This means that the total average traffic level on a HopNet multipoint network must stay within these limits.

For example, a half-duplex network with 10 nodes sending continuous data at 9600 bps to a base station has a total data throughput of 96Kbps. If jamming, multipath fading, and other non-ideal radio conditions result in an average of 20 percent failed packet transmissions, the ARQ protocol may consume an additional 20 percent bandwidth, increasing the total traffic level to about 120 Kbps.

Most network nodes only send data sporadically; therefore, you must account for the duty cycle of network node activity when making these calculations.

For example, if this same 10-remote node network transmitted a 1200 byte packet at 9600 bps, once every second, the average duty cycle for each node is only 10 percent. This would reduce the total average network activity to only 9.6 Kbps.

# Multipoint Networks

---

## Introduction

Most multipoint networks require a base station with omni-directional coverage, such as the HN-1000 (outdoor applications) or the HN-1500 (indoor applications). The wireless base station modem is typically combined with one of the following:

- 2 dB dipole antenna
- 9 dB omni-directional high-gain antenna
- 12 dB omni-directional high-gain antenna

You can use any of the HopNet wireless modems on the remote nodes of the network. Using the HN-3000 wireless modem with the integrated antenna on the remote nodes can minimize cost and effort.

## Packet Format

In a point-to-multipoint situation, the base station must be able to distinguish data streams coming from more than one remote. To distinguish the data streams, the user application uses a special multipoint data format to communicate with the base station.

HopNet modems have built-in addressing capabilities that you can use when setting up multipoint networks. To use these features, you must employ the HopNet "packet protocol." This protocol includes the remote destination address (if it is a transmitted packet) or the remote source address (if it is a received packet) in each base-station data packet. The ARQ protocol can also be used in conjunction with the packet protocol to ensure successful transmission of data.

In order to use the HopNet packet protocol, you need to develop some applications software on the base station DTE that can put transmit data into the proper packet format, or decipher received data arriving at the base station in the packet format. See the illustration below.

STX	Remote Address	Length	< Data >	ETX
1 byte	1 byte	1 byte	0-255 bytes	1 byte

# Point-To-Point Networks

---

## Introduction

For point-to-point operations, communication is bi-directional and the underlying packetization process completely transparent. Multipoint applications, however, require some accommodation for packetization.

Any combination of the HN-1000, HN-1500, or the HN-3000 wireless modems can communicate with each other in a point-to-point configuration. The HN-1000 and HN-1500 each require external antennas. If you use directional gain antennas, take special care to properly orient and aim the antennas in order to maximize range.

The HN-3000, which has an integrated wireless modem and antenna, is especially straightforward in outdoor applications that can require a line of sight range of up to approximately 7-8 miles. The built-in antenna of the HN-3000 eliminates the need to separately mount the antenna. The antenna is somewhat directional, but requires only approximate aiming and is not very sensitive to orientation.

## Optimizing Your Configuration

Point-to-point communications can be easily achieved via the following configuration settings:

- Each unit is programmed to the same source/destination address.
- Packetization mode, the HopNet protocol for incorporating the source or destination address into packets of data in a multipoint network, can be disabled to optimize throughput.
- Each modem must be programmed to the same network number. This means the two modems are each on the same hopping pattern.
- To ensure error-free data, the built-in ARQ protocol should be employed to make certain that unsuccessful transmissions are automatically repeated until they are successful.
- To reflect that only one remote is present in the network, increase CSMA persistence to 100 percent or set TDMA with time slot 0.

## Throughput

The maximum possible data rate for point-to-point transmissions is up to 115 Kbps. A typical point-to-point link should be capable of 115 Kbps half duplex, or up to approximately 70 to 80 Kbps full duplex.

# Network Communication

---

## Introduction

This section provides information on how HopNet products communicate with each other.

## Synchronizing the Base with the Remotes

The base station establishes the network timing by sending out a synchronization pulse at the beginning of each hop. The remotes first scan for this pulse and synchronize to the base hopping pattern before they can communicate. This timing acquisition may take about 5 seconds. Once synchronized, the remote unit will assert DCD to indicate that it has established lock. The base station does not track the remote unit acquisition. Should a remote unit go out of range of the base signal, it will then drop carrier detect after a programmed number of hops and attempt to reacquire the signal.

When not transmitting or receiving, the remote unit automatically drops back to standby current.

## RF Link Data Flow

The HopNet products maintain data integrity over-the-air by using an internal automatic-repeat-request (ARQ) protocol, which retransmits incorrect data until it is received correctly. The radio takes the user data stream and breaks it into packets that can be transmitted at a much higher data rate. Each packet received carries the following:

- An 8-bit address
- A sequence number
- A 24-bit checksum

If the received packet has errors, is a duplicate, or is addressed to another radio, the receiver rejects the packet and the transmitter will attempt to re-send it. The receiver sends a brief acknowledgement back to the transmitter for every valid packet it receives. The HopNet transceivers have 4 KB transmit buffers and 2 KB receive buffers which help to maintain continuous uninterrupted transfer, even in noisy channel situations.

ARQ operation is controlled by a number of user configurable parameters.



## Typical HopNet Applications, Continued

---

### Point-to-Point

A point-to-point application as shown below provides a communication data link between two locations.

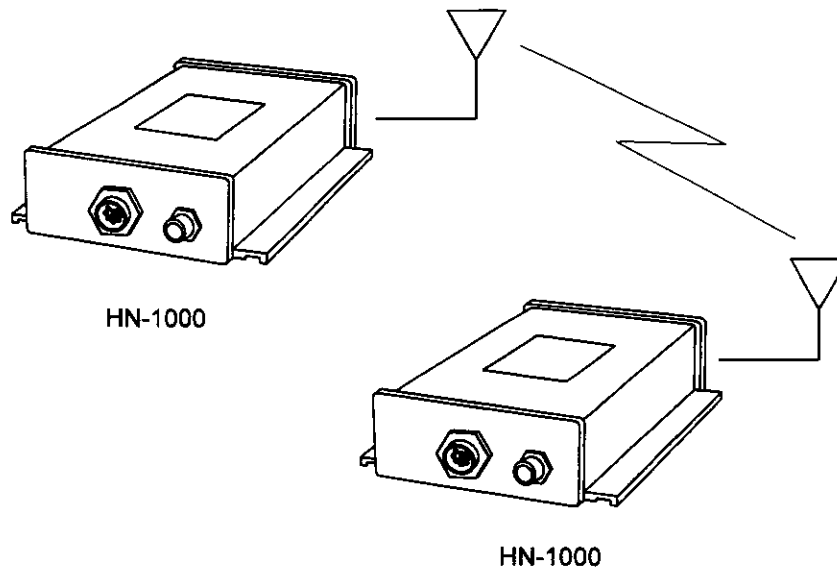

## HN-3000 Remote, Continued

---

### Environmental

Specification	Value
Temperature Range	• 20 to +70 degrees C
Humidity	• 95% at +40 degrees C, Non-condensing

## HN-3000 Remote, Continued

---

### Cable Interface

When you install the cable, check the cable interface for the two power connections VCC and GND to ensure that the supply voltage into the remote never drops below 5.5 V. During initial turn-on, the remote can draw up to 700 mA. This surge current will produce a sizable voltage drop across the combined resistance of the VCC and GND wires in the cable assembly. If the resulting supply voltage into the Remote drops below the 5.5 V limit, the microprocessor in the Remote will fail to reset and the unit will not turn on. The HN-3000 will consistently turn on as long as the combined resistance of the VCC and GND wires in the cable assembly is less than 10 ohms and the supply voltage (at the host end of the cable) is a minimum of 9 V.

The voltage drop across the wiring should not be a problem once the unit has successfully turned on because the maximum operating current of the Remote is much lower during standard operation than it is during the initial surge.

### Aiming the Antenna and Placing the Remote

Use the following guidelines for aiming the antenna and placing the Remote.

- Do not place anything immediately in front of the antenna that could obstruct its radiation pattern. Because the antenna in the HopNet Remote is inside the unit, the antenna must have a clear line of sight.
- Use the sticker on the Remote unit to help you locate and aim the antenna. The sticker indicates which direction the antenna is pointing.
- Be sure the antenna end of the Remote faces the Base or Repeater that it is communicating with. Our tests have found that antenna placement is not critical as long as the patch antenna is facing in the general direction of the other end of the link.
- If possible, place the Remote unit at a higher elevation than the structures surrounding it to increase range and link reliability. Since the Remote will operate with up to 100 meters of cable between it and the Host, you can mount the unit on top of a building or other structure that will provide higher elevation.
- From a propagation standpoint, the mounting orientation of the unit is irrelevant. You can place the mounting plate vertically or horizontally.

### Communication

You can use the escape sequence (:wit2400) to configure the radio inside the Remote since you have no access to the configuration pin. Use DCD to verify the status of the link. Use CTS to determine whether the transmit data buffer is full.

# HN-3000 Remote

## Introduction

The HopNet Remote (HN-3000) is a low-cost, weatherproof version of the HopNet product line. The interface to the HopNet Remote allows the Host to communicate with the Remote unit through an external cable of up to 300 feet (100 meters).

## Design Features

The HN-3000 Remote has an internally mounted 6 dBi patch antenna. The built-in antenna of the HN-3000 case greatly eases outdoor installation since no antenna feedline cable or adapters are needed. The 6 dBi antenna gain increases the radiated EIRP to +24 dBm and the effective receiver sensitivity to -101 dBm.

The user interface to the HN-3000 Remote is a 9-pin Conxall waterproof connector. Nine pins are the minimum number of pins necessary to convey all of the signals needed to communicate with the modem inside the unit as well as to provide power and ground for the unit. See the illustration below.

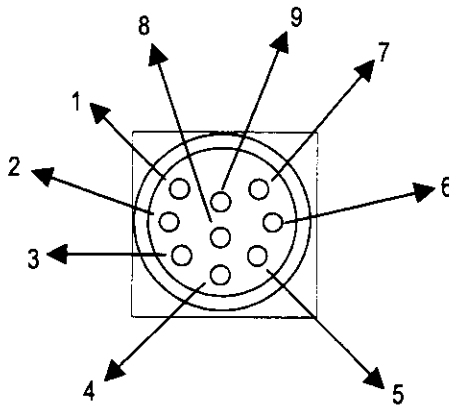

1 Transmit Data (TXD+)	4 Receive Data (RXD-)	7 Data Carrier Detect (DCD)
2 Transmit Data (TXD-)	5 Clear to Send (CTS)	8 VCC
3 Receive Data (RXD+)	6 Data Terminal Ready (DTR)	9 Ground

An RS-485 compatible interface is used for transmit and received data. This interface is used to ensure that the maximum data rate of 115.2 Kbps will pass through a 100-meter section of cable without rise-time problems. The slower-changing control signals DTR, DCD, and CTS use standard RS-232 interface levels. The HN-3500 can be used to connect all signals to RS-232 and to provide power.

## HN-2000 Repeater, Continued

---

### Technical Specifications

Refer to the following tables for the technical specifications for the HN-2000.

#### General

Specification	Value
Transmitter FCC ID	<ul style="list-style-type: none"><li>• HSW-2400M</li></ul>
Transmit Power	<ul style="list-style-type: none"><li>• +18 dBm nominal out of each antenna port</li></ul>
Hopping Patterns	<ul style="list-style-type: none"><li>• User configurable, 16 patterns (networks) available</li></ul>
Number of Channels	<ul style="list-style-type: none"><li>• 80</li></ul>
Line-of-Sight Range	<ul style="list-style-type: none"><li>• Greater than 5 miles with 9 dB omni (per leg of repeater)</li></ul>
Frequency Band	<ul style="list-style-type: none"><li>• 2401-2480 MHz (USA)</li><li>• 2448-2480 MHz (France)</li></ul>
Approvals	<ul style="list-style-type: none"><li>• US FCC: Part 15. 203</li><li>• European Community: ETS 300.328 Compliance</li></ul>
Receiver Sensitivity	<ul style="list-style-type: none"><li>• -95 dBm</li></ul>
Data Interface	<ul style="list-style-type: none"><li>• RS-232</li></ul>
Power Supply	<ul style="list-style-type: none"><li>• 9V +/- 10%, current capability greater than 600 mA</li></ul>
Supply Current	<ul style="list-style-type: none"><li>• 350 mA normal operation (750 mA surge)</li><li>• 500 mA with battery charging</li></ul>
Battery Operating Time	<ul style="list-style-type: none"><li>• Approximately 2 hours</li></ul>

## HN-2000 Repeater, Continued

---

### Power

Power for the repeater is +9 to 12 VDC. The current consumption of the repeater depends on the radio operating mode and the state of battery charge, but is typically 330 mA.

Battery backup is provided to maintain power during outages. Approximate operating time from this battery is 2 hours. A trickle charge is maintained on the battery whenever the unit is externally powered. Lead acid cells are used in the repeater because of their long-term reliability and charge storage characteristics.

Voltage limiting circuits are in place at the connector to ensure that incoming voltage does not exceed +15 VDC. One-amp polyfuses are placed in series with the external power supply and battery to avoid catastrophic current draw in case of an accidental short. In addition, a low voltage lockout circuit is also included to shut off the unit when the voltage-supplied drops lower than 5.5 volts at the connector.

### Antenna Connectors

The external antenna connectors are located on the front panel and are female TNC connectors. See the illustration below.

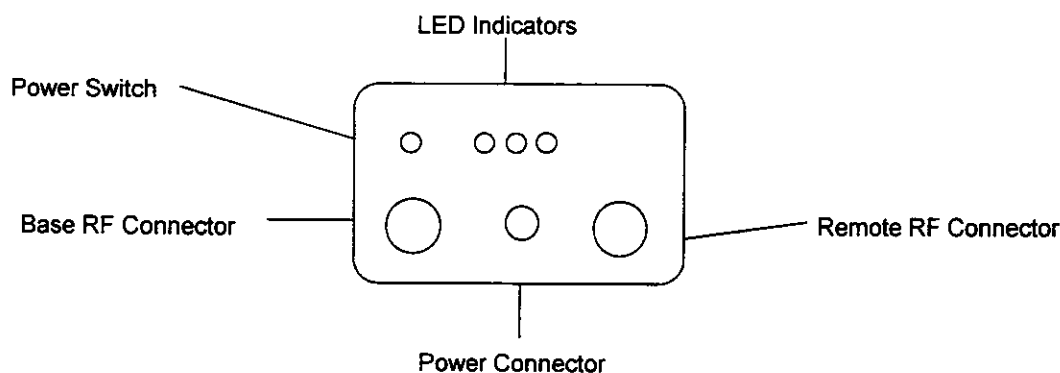

Proper placement of the external antenna is important since two modems inside the HN-2000 will be operating simultaneously. Be sure to physically separate the antennas from each other because the output transmission of one side of the repeater may interfere with the reception of the other. Use a remote cable between the repeater and each antenna, and space the antennas at least 2 meters apart.

# HN-2000 Repeater, Continued

---

## Antenna and Power Connections

There are three external connections going into the repeater enclosure and one internal connection:

- Two RF ports
- A 2-pin Conxall power connector
- An internal DB-9 connector

### RF Antenna Connectors

The two RF antenna connectors are standard TNC. These ports connect to the output of each internal modem. You can attach either remote antenna cables to these connectors.

### Conxall Power Connector

The Conxall power connector is waterproof and ruggedized for industrial use. This connector supplies 9 VDC nominal operating power to the HN-2000 Repeater.

### DB-9 Connector

The DB-9 connector is located inside the back panel of the enclosure and is used to configure the HN-2000. See the illustration below for the pin-out of the DB-9 connector.

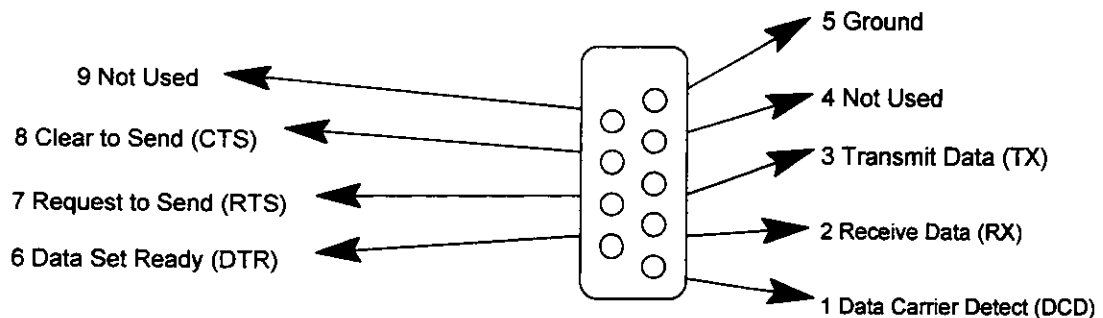

# HN-1500 Indoor Base/Remote Station, Continued

---

## Environmental

Specification	Value
Temperature Range	• -20° to 70° C
Humidity	• 95% at +40°C, Non-condensing



## HN-1500 Indoor Base/Remote Station, Continued

---

### LED Status

The five LED indicators are included on the front panel to provide the status of the HN-1500 Indoor Base/Remote station. See the illustration below. These built-in flow control indicators allow you to quickly check the operational status.

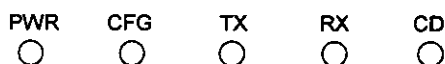

The table below describes the function of each LED.

Name	Color	Description
PWR	Green	Continuous DC power is applied
CFG	Red	Radio is in setup mode
TX	Red	RS-232 signal input
RX	Red	RS-232 signal output
CD	Red	Normal operation is asserted

### Power Connection

You can operate the HN-1500 from any well-filtered 7.5 to 12 VDC power source. The power supply should be capable of providing 500 milliamperes of current.

The indoor base station uses a separate 2-pin power connector that accepts 7.5 to 12 VDC. Power connects to the 2-pin connector on the front panel of the transceiver. A polyfuse is on the transceiver board to protect against short circuits.

### Antenna Connection

The RF signal is brought in on a standard female TNC jack connector located on the front panel.

Use the following guidelines when installing the antenna:

- Strictly follow the antenna manufacturer's installation instructions for proper operation of the antenna.
- Be sure to use proper polarization for any system using a gain type antenna. If you orient the antenna with the wrong polarization, a signal reduction of greater than 20 dB could result.
- Use a low-loss feedline with the HN-1500. Keep the feedline as short as possible to minimize signal loss.
- Use proper care when installing the feedline to prevent damage. Do not twist, stretch, or kink the cable.
- Be sure to securely fasten the cable and only use connectors that have been recommended by the cable manufacturer.

## HN-1000 Outdoor Base/Remote Station, Continued

---

### Environmental

Specification	Value
Temperature	<ul style="list-style-type: none"><li>• -20° to 70° C</li></ul>
Humidity	<ul style="list-style-type: none"><li>• 95% at + 40°C, Non-condensing</li></ul>

## HN-1000 Outdoor Base/Remote Station, Continued

---

### Antenna Connection

The RF signal is brought in on a standard female TNC jack connector located on the front panel. Use the following guidelines when installing the antenna:

- Be sure to strictly follow the antenna manufacturer's installation instructions for proper operation of the antenna.
- Be sure that you use the proper polarization for a gain type antenna. If you orient the antenna with wrong polarization, a signal reduction of greater than 20 dB could result.
- Use a low-loss RF feedline between the antenna and the HN-1000. Make the feedline as short as possible to keep signal loss to a minimum.
- When installing the feedline, do not twist, stretch, or kink the cable.
- Be sure to securely fasten the cable and only use connectors that have been recommended by the cable manufacturer.

# About the HopNet Products

---

## Introduction

This section provides operational information about the HopNet products.

## Operating Frequency

The HopNet family operates in the 2.4 GHz ISM band that allows for license-free use and worldwide compliance.

## HopNet Spread Spectrum Advantages

In the frequency domain, a multipath fade can be described as a frequency selective notch that shifts in location and depth over time. Multipath fades typically occupy five percent of the band. A conventional radio system typically has a five percent chance of signal impairment at any given time due to multipath fading.

Spread Spectrum reduces the vulnerability of a radio system to both interference from jammers and multipath fading by distributing the signal over a larger region of the frequency band.

The fade resistant, HopNet frequency-hopping technology employs 80 channels and switches channels over 40 times a second to achieve high reliability throughput.

## HopNet Data Integrity

An on-board 6 KB buffer and error correcting over-the-air protocol ensure data integrity even in the presence of weak signal or jammers. The serial interface handles both data and control of asynchronous data rates up to 115 Kbps.

## Flexible Power Management

You can set the transmit power at 10 milliwatts or 100 milliwatts. Reduced power can reduce the size of the coverage zone, which may be desirable for multiple network indoor applications. You can also place the transceiver module in a power-save mode, which enables smart power management. Smart power management allows a remote unit to drop into a lower current standby mode during transmission or receiving gaps.

## Overview, Continued

---

### Design Features

The HopNet modems have many advanced features:

- Employ frequency hopping technology with 80 channels in the 2401 to 2480 MHz frequency range
- Support RS-232 interface
- Support digital addressing for up to 16 networks, with 255 remotes per network.
- Use transparent ARQ protocol
- Use same hardware for all supported data rates
- Support up to 115 Kbps asynchronous data rates
- Store setup configuration in nonvolatile memory (NVRAM)
- Provide fast acquisition – less than 2 seconds is the typical time to acquire hopping pattern
- Use smart power management features

### Glossary of Terms

Refer to the following list of terms that may be unfamiliar to you. These terms are used throughout this document.

Term	Definition
ARQ	Automatic Repeat Request. The operation in which the radio will re-send the data until it is received correctly.
bps	Bits-per-second. A measure of information transfer rate of digital data across a channel.
CSMA	Carrier Sense Multi Access. A common multinode contention protocol for sharing an RF channel.
Decibel	A measure of the ratio between two signal levels. Used to express either loss or gain.
dBi	Decibels referenced to an ideal isotropic radiator in free space. Used to express antenna gain.
dBm	Decibels referenced to 1 milliwatt. An absolute unit used to measure signal power. Transmitter power output or received signal strength.
DCE	Data Communications Equipment. A device that receives data in the form of digital signals at its input. The modem side of a computer-to-modem connection.
DCD	Data Carrier Detect.

## Contents, Continued

---

Appendix A Mechanical Drawings	
Overview .....	A-1
HN-1000 Outdoor Base/Remote Station .....	A-2
HN-1500 Indoor Base/Remote Station .....	A-3
HN-2000 Repeater .....	A-4
HN-3000 Remote .....	A-5
HN-3500 Adapter .....	A-6
Appendix B Modem Command Summary	
Overview .....	B-1
Network Commands .....	B-2
Serial Interface Commands.....	B-2
Protocol Commands .....	B-3
Status Commands .....	B-3
Memory Commands.....	B-3
Appendix C Accessories	
Overview .....	C-1
Antennas.....	C-2
Adapter .....	C-3
Power Supply .....	C-5