

Certification Test Report

FCC ID: HSW-DNT90

IC: 4492A-DNT90

FCC Rule Part: 15.247

IC Radio Standards Specification: RSS-210

ACS Report Number: 10-0314.W06.11.A

Manufacturer: RFM/Cirronet

Model(s): DNT90C, DNT90P

Test Begin Date: October 15, 2010

Test End Date: October 27, 2010

Report Issue Date: November 1, 2010



FOR THE SCOPE OF ACCREDITATION UNDER LAB Code 200612-0

This report must not be used by the client to claim product certification, approval, or endorsement by NVLAP, NIST, or any agency of the Federal Government.

Reviewed by: _____

A handwritten signature in black ink, appearing to read 'Kirby Munroe', is written over a horizontal line.

Kirby Munroe

Director, Wireless Certifications

ACS, Inc.

This test report shall not be reproduced except in full. This report may be reproduced in part with prior written consent of ACS, Inc. The results contained in this report are representative of the sample(s) submitted for evaluation.

This report contains 25 pages

TABLE OF CONTENTS

1	GENERAL	3
1.1	PURPOSE	3
1.2	PRODUCT DESCRIPTION	3
1.3	TEST METHODOLOGY AND CONSIDERATIONS	3
2	TEST FACILITIES	4
2.1	LOCATION	4
2.2	LABORATORY ACCREDITATIONS/RECOGNITIONS/CERTIFICATIONS	4
2.3	RADIATED EMISSIONS TEST SITE DESCRIPTION	5
2.3.1	<i>Semi-Anechoic Chamber Test Site</i>	5
2.3.2	<i>Open Area Tests Site (OATS)</i>	6
2.4	CONDUCTED EMISSIONS TEST SITE DESCRIPTION	7
3	APPLICABLE STANDARD REFERENCES	7
4	LIST OF TEST EQUIPMENT	8
5	SUPPORT EQUIPMENT	9
6	EQUIPMENT UNDER TEST SETUP BLOCK DIAGRAM	9
7	SUMMARY OF TESTS	10
7.1	ANTENNA REQUIREMENT – FCC: SECTION 15.203	10
7.2	POWER LINE CONDUCTED EMISSIONS – FCC: SECTION 15.207 IC: RSS-GEN 7.2.2	10
7.2.1	<i>Measurement Procedure</i>	10
7.2.2	<i>Measurement Results</i>	10
7.3	RADIATED EMISSIONS – FCC: SECTION 15.109 (UNINTENTIONAL RADIATION) IC: RSS-210 2.6	13
7.3.1	<i>Measurement Procedure</i>	13
7.3.2	<i>Measurement Results</i>	13
7.4	PEAK OUTPUT POWER - FCC SECTION 15.247(B)(2) IC: RSS-210 A8.4(1)	14
7.4.1	<i>Measurement Procedure (Conducted Method)</i>	14
7.4.2	<i>Measurement Results</i>	14
7.5	CHANNEL USAGE REQUIREMENTS	15
7.5.1	<i>Carrier Frequency Separation – FCC: Section 15.247(a)(1) IC: RSS-210 A8.1(b)</i>	15
7.5.1.1	<i>Measurement Procedure</i>	15
7.5.1.2	<i>Measurement Results</i>	15
7.5.2	<i>Number of Hopping Channels – FCC: Section 15.247(a)(1)(i) IC: RSS-210 A8.1(c)</i>	16
7.5.3	<i>Channel Dwell Time – FCC: Section 15.247(a)(1)(i) IC: RSS-210 A8.1(c)</i>	17
7.5.3.1	<i>Measurement Procedure</i>	17
7.5.3.2	<i>Measurement Results</i>	17
7.5.4	<i>20dB / 99% Bandwidth - FCC: Section 15.247(a)(1)(i) IC: RSS-210 A8.1(c)</i>	18
7.5.4.1	<i>Measurement Procedure</i>	18
7.5.4.2	<i>Measurement Results</i>	18
7.6	BAND-EDGE COMPLIANCE AND SPURIOUS EMISSIONS-FCC 15.247(D) IC: RSS-210 A8.5	20
7.6.1	<i>Band-Edge Compliance of RF Conducted Emissions</i>	20
7.6.1.1	<i>Measurement Procedure</i>	20
7.6.1.2	<i>Measurement Results</i>	20
7.6.2	<i>RF Conducted Spurious Emissions</i>	21
7.6.2.1	<i>Measurement Procedure</i>	21
7.6.2.2	<i>Measurement Results</i>	21
7.6.3	<i>Radiated Spurious Emissions - FCC Section 15.205 IC: RSS-210 2.6</i>	23
7.6.3.1	<i>Measurement Procedure</i>	23
7.6.3.2	<i>Duty Cycle Correction</i>	23
7.6.3.3	<i>Measurement Results</i>	23
7.6.3.4	<i>Sample Calculation:</i>	25
8	CONCLUSION	25

1 GENERAL

1.1 Purpose

The purpose of this report is to demonstrate compliance with Part 15 Subpart C of the FCC's Code of Federal Regulations and Industry Canada's Radio Standards Specification RSS-210 for Certification of a single modular approval.

1.2 Product description

The DNT90 is a frequency hopping spread spectrum (FHSS) transceiver operating in the 902-928MHz frequency band which provide for wireless connectivity for point-to-point, point-to-multipoint and store-and-forward radio applications.

Manufacturer Information:

RFM/CIRRONET
3709 Premiere Parkway
Duluth, GA, 30097
USA

Technical details:

Band of operation:	902-928 MHz
Number of hopping channels:	52
Channel spacing	480 KHz
Output power:	23 dBm
Over the air data rate:	100 Kbps
Modulation format:	Gaussian filtered FSK
User interface rates:	9600 baud up to 230 Kbps
Receiver sensitivity:	-100 dBm at 100 Kbps
Certification sub-type	Frequency Hopper (>50 channels)
Emission Designator:	F1D
Antennas:	5 dBi Omni, 6 dBi Yagi,
RF connector:	UFL

Test Sample Serial Number(s):

7

Test Sample Condition: The test samples were provided in good working order with no visible defects.

1.3 Test Methodology and Considerations

A test evaluation board was utilized to supply power and program the EUT for test modes. See Section 5.0 – 6.0 for additional details.

The DNT90C and DNT90P models are electrically identical and differ only in their mounting option. The DNT90C is a castellated version and the DNT90P is a pin version for socket mounting.

To allow use of a test fixture during testing, the DNT90P model was evaluated.

2 TEST FACILITIES

2.1 Location

The radiated and conducted emissions test sites are located at the following address:

Advanced Compliance Solutions
5015 B.U. Bowman Drive
Buford, GA 30518
Phone: (770) 831-8048
Fax: (770) 831-8598

2.2 Laboratory Accreditations/Recognitions/Certifications

ACS is accredited to ISO/IEC 17025 by the National Institute of Standards and Technology under their National Voluntary Laboratory Accreditation Program (NVLAP), Lab Code 200612-0. Unless otherwise specified, all tests methods described within this report are covered under the ISO/IEC 17025 scope of accreditation.

The Semi-Anechoic Chamber Test Site, Open Area Test Site (OATS) and Conducted Emissions Site have been fully described, submitted to, and accepted by the FCC, Industry Canada and the Japanese Voluntary Control Council for Interference by information technology equipment.

FCC Registration Number: 894540

Industry Canada Lab Code: IC 4175A-1

VCCI Member Number: 1831

- VCCI OATS Registration Number R-1526
- VCCI Conducted Emissions Site Registration Number: C-1608

2.3 Radiated Emissions Test Site Description

2.3.1 Semi-Anechoic Chamber Test Site

The Semi-Anechoic Chamber Test Site consists of a 20' x 30' x 18' shielded enclosure. The chamber is lined with Toyo Ferrite Grid Absorber, model number FFG-1000. The ferrite tile grid is 101 x 101 x 19mm thick and weighs approximately 550 grams. These tiles are mounted on steel panels and installed directly on the inner walls of the chamber.

The turntable is 150cm in diameter and is located 160cm from the back wall of the chamber. The chamber is grounded via 1 - 8' copper ground rod, installed at the center of the back wall, it is bound to the ground plane using 3/4" stainless steel braided cable.

The turntable is all steel, flush mounted table installed in an all steel frame. The table is remotely operated from inside the control room located 25' from the range. The turntable is electrically bonded to the surrounding ground plane via steel fingers installed on the edge of the turn table. The steel fingers make constant contact with the ground plane during operation.

Behind the turntable is a 3' x 6' x 4' deep shielded pit used for support equipment if necessary. The pit is equipped with 1 - 4" PVC chases from the turntable to the pit that allow for cabling to the EUT if necessary. The underside of the turntable can be accessed from the pit so cables can be supplied to the EUT from the pit.

A diagram of the Semi-Anechoic Chamber Test Site is shown in Figure 2.3-1 below:

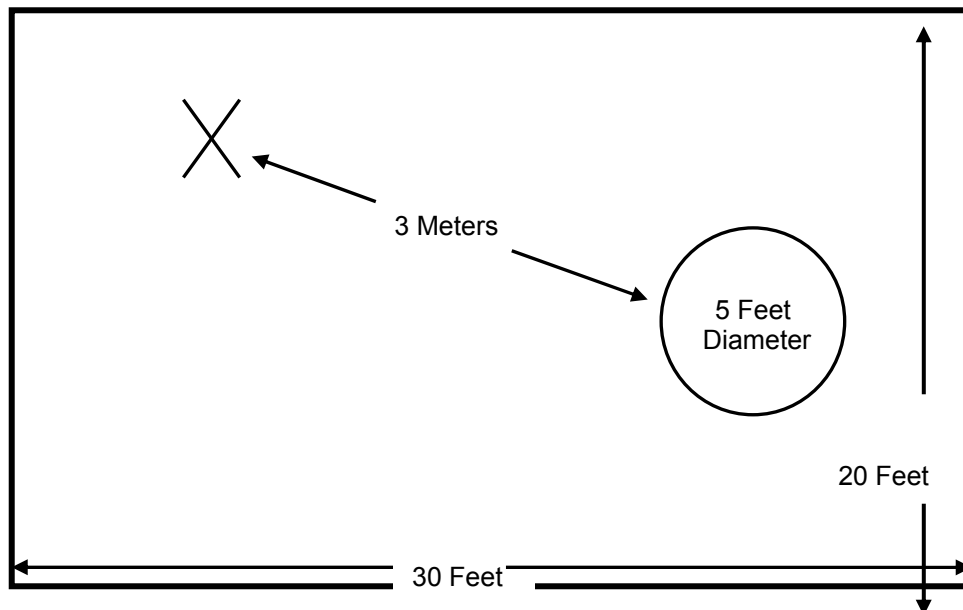

Figure 2.3-1: Semi-Anechoic Chamber Test Site

2.3.2 Open Area Tests Site (OATS)

The open area test site consists of a 40' x 66' concrete pad covered with a perforated electro-plated galvanized sheet metal. The perforations in the sheet metal are 1/8" holes that are staggered every 3/16". The individual sheets are placed to overlap each other by 1/4" and are riveted together to provide a continuous seam. Rivets are spaced every 3" in a 3 x 20 meter perimeter around the antenna mast and EUT area. Rivets in the remaining area are spaced as necessary to properly secure the ground plane and maintain the electrical continuity.

The entire ground plane extends 12' beyond the turntable edge and 16' beyond the antenna mast when set to a 10 meter measurement distance. The ground plane is grounded via 4 - 8' copper ground rods, each installed at a corner of the ground plane and bound to the ground plane using 3/4" stainless steel braided cable.

The turntable is an all aluminum 10' flush mounted table installed in an all aluminum frame. The table is remotely operated from inside the control room located 40' from the range. The turntable is electrically bonded to the surrounding ground plane via steel fingers installed on the edge of the turn table. The steel fingers make constant contact with the ground plane during operation.

Adjacent to the turntable is a 7' x 7' square and 4' deep concrete pit used for support equipment if necessary. The pit is equipped with 5 - 4" PVC chases from the pit to the control room that allow for cabling to the EUT if necessary. The underside of the turntable can be accessed from the pit so cables can be supplied to the EUT from the pit. The pit is covered with 2 sheets of 1/4" diamond style re-enforced steel sheets. The sheets are painted to match the perforated steel ground plane; however the underside edges have been masked off to maintain the electrical continuity of the ground plane. All reflecting objects are located outside of the ellipse defined in ANSI C63.4.

A diagram of the Open Area Test Site is shown in Figure 2.3-2 below:

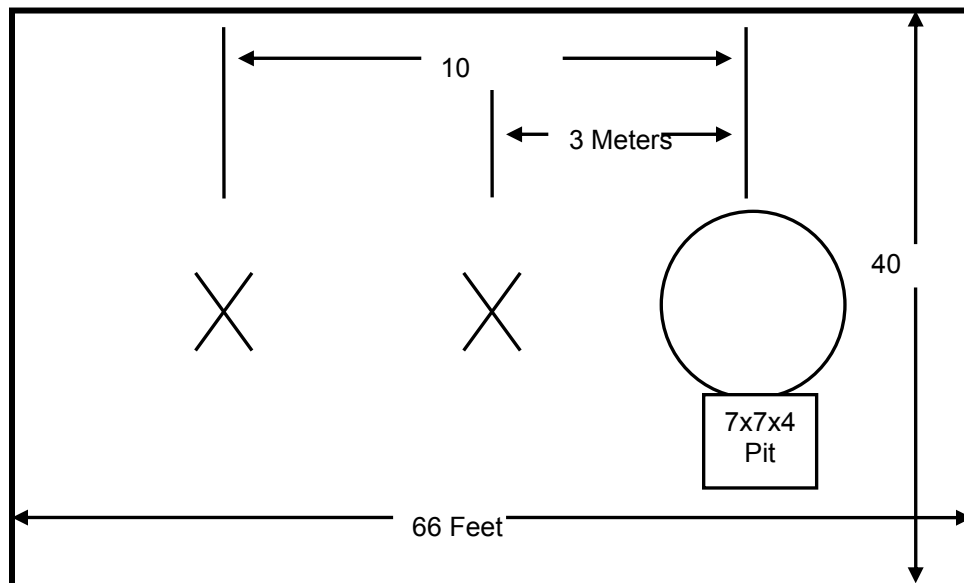

Figure 2.3-2: Open Area Test Site

2.4 Conducted Emissions Test Site Description

The AC mains conducted EMI site is located in the main EMC lab. It consists of an 8' x 8' solid aluminum horizontal ground reference plane (GRP) bonded every 3" to an 8' X 8' vertical ground plane.

The site is of sufficient size to test table top and floor standing equipment in accordance with section 6.1.4 of ANSI C63.4.

A diagram of the room is shown below in figure 4.1.3-1:

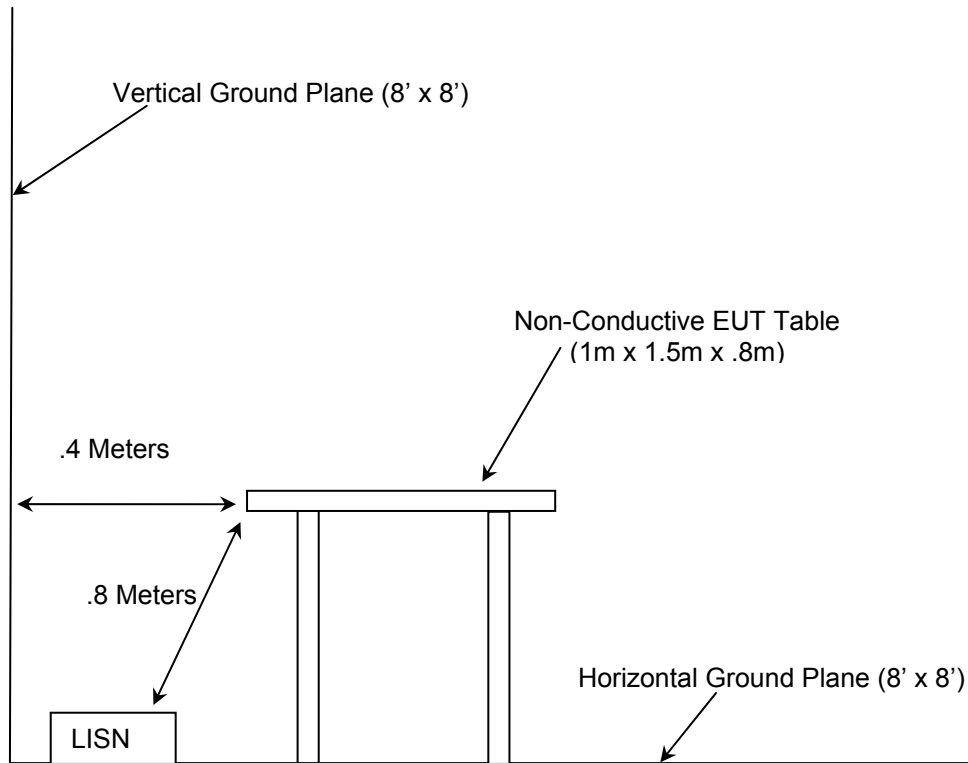

Figure 2.4-1: AC Mains Conducted EMI Site

3 APPLICABLE STANDARD REFERENCES

The following standards were used:

- ❖ ANSI C63.4-2003: Method of Measurements of Radio-Noise Emissions from Low-Voltage Electrical and Electronic Equipment in the 9KHz to 40GHz
- ❖ US Code of Federal Regulations (CFR): Title 47, Part 2, Subpart J: Equipment Authorization Procedures, 2010
- ❖ US Code of Federal Regulations (CFR): Title 47, Part 15, Subpart C: Radio Frequency Devices, Intentional Radiators, 2010
- ❖ FCC Public Notice DA 00-705 - Filing and Measurement Guidelines for Frequency Hopping Spread Spectrum Systems, March 30, 2000
- ❖ Industry Canada Radio Standards Specification: RSS-210 - Low-power License-exempt Radiocommunication Devices (All Frequency Bands): Category I Equipment, Issue 7 June 2007
- ❖ Industry Canada Radio Standards Specification: RSS-GEN - General Requirements and Information for the Certification of Radiocommunication Equipment, Issue2, June 2007.

4 LIST OF TEST EQUIPMENT

The calibration interval of test equipment is annually or the manufacturer's recommendations. Where the calibration interval deviates from the annual cycle based on the instrument manufacturer's recommendations, it shall be stated below.

Table 4-1: Test Equipment

AssetID	Manufacturer	Model #	Equipment Type	Serial #	Cal Due Date	Notes
1	Rohde & Schwarz	ESMI - Display	Spectrum Analyzers	833771/007	9/23/2012	
2	Rohde & Schwarz	ESMI-Receiver	Spectrum Analyzers	839587/003	9/23/2012	
3	Rohde & Schwarz	ESMI - Display	Spectrum Analyzers	839379/011	2/2/2011	
4	Rohde & Schwarz	ESMI - Receiver	Spectrum Analyzers	833827/003	2/2/2011	
22	Agilent	8449B	Amplifiers	3008A00526	8/30/2011	
25	Chase	CBL6111	Antennas	1043	9/13/2012	3
30	Spectrum Technologies	DRH-0118	Antennas	970102	5/8/2011	3
73	Agilent	8447D	Amplifiers	2727A05624	5/26/2011	
153	EMCO	3825/2	LISN	9411-2268	1/11/2011	
167	ACS	Chamber EMI Cable Set	Cable Set	167	1/25/2011	1
168	Hewlett Packard	11947A	Attenuators	44829	2/4/2011	
193	ACS	OATS cable Set	Cable Set	193	1/5/2011	1
211	Eagle	C7RFM3NFNM	Filters	HLC-700	12/21/2010	
213	TEC	PA 102	Amplifiers	44927	12/21/2010	
283	Rohde & Schwarz	FSP40	Spectrum Analyzers	1000033	8/31/2011	
291	Florida RF Cables	SMRE-200W-12.0 SMRE	Cables	None	11/24/2010	1
292	Florida RF Cables	SMR-290AW-480.0-SMR	Cables	None	11/24/2010	1
324	ACS	Belden	Cables	8214	7/9/2011	1
340	Aeroflex/Weinschel	AS-20	Attenuators	7136	10/5/2011	2
343	Florida RF Cables	SMRE-200W-12.0 SMRE	Cables	N/A	4/27/2011	1
422	Florida RF	SMS-200AW-72.0 SMR	Cables	805	1/26/2011	1
430	RF Cables	SMS-290AW-480-SMS	Cables	N/A	4/27/2011	1
432	Microwave Circuits	H3G020G4	Filters	264066	7/16/2011	1

Note1: Items characterized on an annual cycle. The date shown indicates the next characterization due date.

Note2: Items verified on an annual cycle. The date shown indicates the next verification due date.

Notes3: Items calibrated on a 2 year cycle.

5 SUPPORT EQUIPMENT

Table 5-1: Support Equipment

Item	Equipment Type	Manufacturer	Model Number	Serial Number
1	Evaluation Board	RFM	WSN802G	NA
2	AC Adaptor	GlobTek, Inc.	GT-41052-1509	NA

6 EQUIPMENT UNDER TEST SETUP BLOCK DIAGRAM

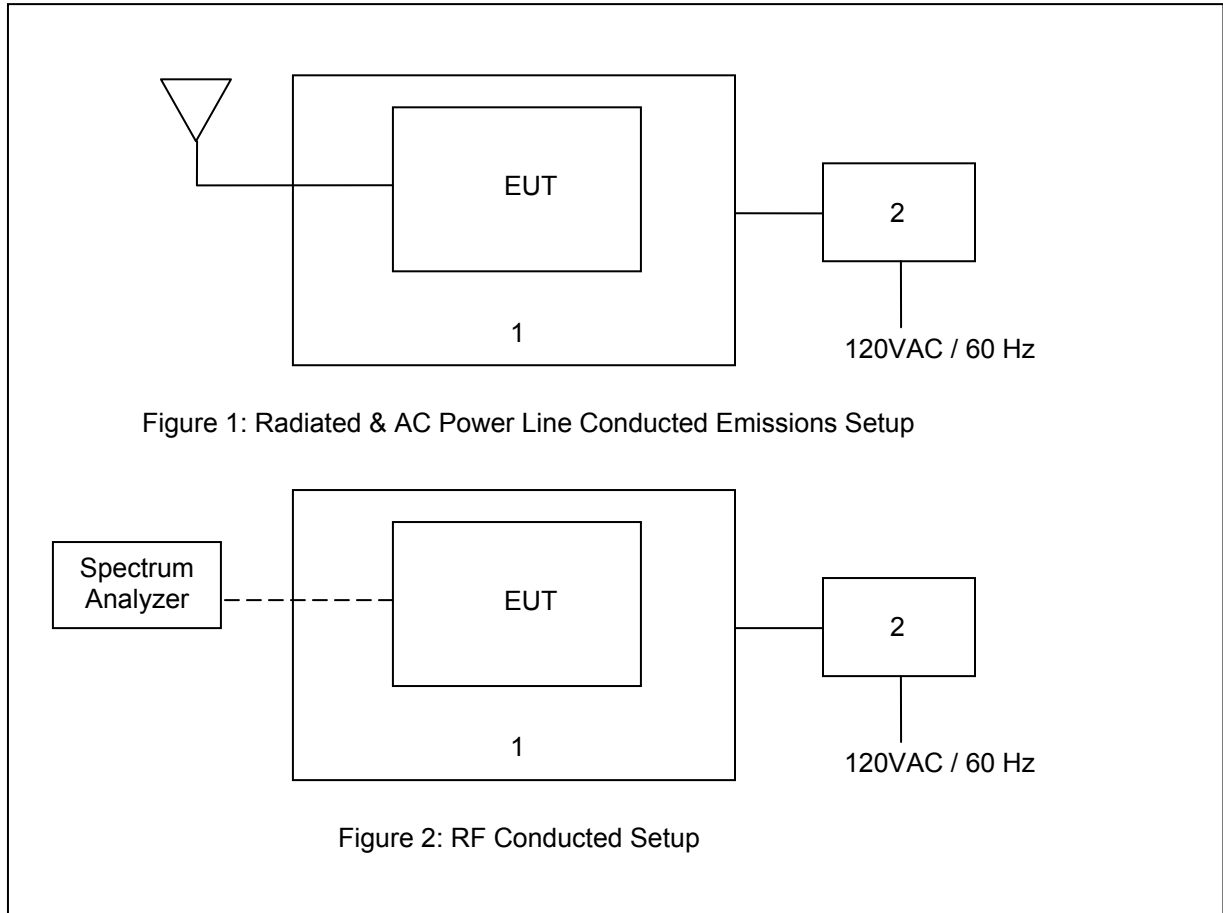

Figure 6-1: EUT Test Setup

7 SUMMARY OF TESTS

Along with the tabular data shown below, plots were taken of all signals deemed important enough to document.

7.1 Antenna Requirement – FCC: Section 15.203

The DNT90 utilizes a UFL connector soldered directly to the PCB board thus satisfying the unique antenna coupling specified in Part 15.203.

7.2 Power Line Conducted Emissions – FCC: Section 15.207 IC: RSS-Gen 7.2.2

7.2.1 Measurement Procedure

ANSI C63.4 sections 6 and 7 were the guiding documents for this evaluation. Conducted emissions were performed from 150kHz to 30MHz with the spectrum analyzer's resolution bandwidth set to 9kHz and the video bandwidth set to 30kHz. The calculation for the conducted emissions is as follows:

$$\text{Corrected Reading} = \text{Analyzer Reading} + \text{LISN Loss} + \text{Cable Loss}$$

$$\text{Margin} = \text{Applicable Limit} - \text{Corrected Reading}$$

7.2.2 Measurement Results

Results of the test are shown below in and Tables 7.2.2-1 to 7.2.2-4.

Table 7.2.2-1: Line 1 Conducted EMI Results – Dipole Antenna

Frequency (MHz)	Level (dBuV)	Transducer (dB)	Limit (dBuV)	Margin (dB)	Line	PE	Detector
0.15	36.5	9.9	66	29.5	L1	FLO	QP
0.456	20.1	10	57	36.6	L1	FLO	QP
0.492	15.6	10	56	40.5	L1	FLO	QP
0.66	17	10	56	39	L1	FLO	QP
0.78	16.1	10.1	56	39.9	L1	FLO	QP
1.008	15.2	10	56	40.8	L1	FLO	QP
1.662	16.8	10	56	39.2	L1	FLO	QP
1.734	17.9	10	56	38.1	L1	FLO	QP
2.076	19.7	10	56	36.3	L1	FLO	QP
2.136	18.7	10	56	37.3	L1	FLO	QP
0.228	16.8	9.9	53	35.7	L1	FLO	AVG
0.456	14.5	10	47	32.3	L1	FLO	AVG
0.486	11.1	10	46	35.1	L1	FLO	AVG
0.708	14.9	10.1	46	31.1	L1	FLO	AVG
0.72	12.4	10.1	46	33.6	L1	FLO	AVG
1.026	11.2	10	46	34.8	L1	FLO	AVG
1.65	11.9	10	46	34.1	L1	FLO	AVG
1.776	13.5	10	46	32.5	L1	FLO	AVG
2.142	13.2	10	46	32.8	L1	FLO	AVG
2.148	12.6	10	46	33.4	L1	FLO	AVG

Table 7.2.2-2: Line 2 Conducted EMI Results – Dipole Antenna

Frequency (MHz)	Level (dBuV)	Transducer (dB)	Limit (dBuV)	Margin (dB)	Line	PE	Detector
0.15	36.6	9.9	66	29.4	L2	FLO	QP
0.396	15.9	10.1	58	42	L2	FLO	QP
0.462	19.9	10	57	36.8	L2	FLO	QP
0.492	13.2	10	56	42.9	L2	FLO	QP
0.72	17.3	10.1	56	38.7	L2	FLO	QP
1.212	18.4	10	56	37.6	L2	FLO	QP
1.542	16.7	10	56	39.3	L2	FLO	QP
1.962	11.3	10	56	44.7	L2	FLO	QP
2.07	17.7	10	56	38.3	L2	FLO	QP
2.184	18.4	10	56	37.6	L2	FLO	QP
0.192	18.1	9.9	54	35.8	L2	FLO	AVG
0.384	8.5	10.1	48	39.7	L2	FLO	AVG
0.45	14.2	10	47	32.7	L2	FLO	AVG
0.492	8.8	10	46	37.4	L2	FLO	AVG
0.69	12.7	10.1	46	33.3	L2	FLO	AVG
1.218	14	10	46	32	L2	FLO	AVG
1.524	12.5	10	46	33.5	L2	FLO	AVG
1.968	8.1	10	46	37.9	L2	FLO	AVG
2.07	12.7	10	46	33.3	L2	FLO	AVG
2.106	13.5	10	46	32.5	L2	FLO	AVG

Table 7.2.2-3: Line 1 Conducted EMI Results – Yagi Antenna

Frequency (MHz)	Level (dBuV)	Transducer (dB)	Limit (dBuV)	Margin (dB)	Line	PE	Detector
0.15	38.4	9.9	66	27.6	L1	FLO	QP
0.33	18.3	10	60	41.2	L1	FLO	QP
0.462	20.7	10	57	36	L1	FLO	QP
0.48	18.1	10	56	38.3	L1	FLO	QP
0.564	18.7	10	56	37.3	L1	FLO	QP
0.708	19.8	10.1	56	36.2	L1	FLO	QP
0.756	19.8	10.1	56	36.2	L1	FLO	QP
1.686	18.1	10	56	37.9	L1	FLO	QP
2.058	20.6	10	56	35.4	L1	FLO	QP
2.094	20.9	10	56	35.1	L1	FLO	QP
0.198	13.2	9.9	54	40.5	L1	FLO	AVG
0.33	11	10	50	38.4	L1	FLO	AVG
0.462	16.3	10	47	30.4	L1	FLO	AVG
0.492	11.5	10	46	34.7	L1	FLO	AVG
0.564	14.3	10	46	31.7	L1	FLO	AVG
0.678	13.8	10	46	32.2	L1	FLO	AVG
0.72	14.2	10.1	46	31.8	L1	FLO	AVG
1.746	14.5	10	46	31.5	L1	FLO	AVG
2.094	15.8	10	46	30.2	L1	FLO	AVG
2.142	14.8	10	46	31.2	L1	FLO	AVG

Table 7.2.2-4: Line 2 Conducted EMI Results – Yagi Antenna

Frequency (MHz)	Level (dBuV)	Transducer (dB)	Limit (dBuV)	Margin (dB)	Line	PE	Detector
0.192	32.2	9.9	64	31.7	L2	FLO	QP
0.36	20.3	10	59	38.4	L2	FLO	QP
0.444	29.1	10	57	27.8	L2	FLO	QP
0.486	16.4	10	56	39.8	L2	FLO	QP
0.726	18.2	10.1	56	37.8	L2	FLO	QP
1.23	19.3	10	56	36.7	L2	FLO	QP
1.506	17.5	10	56	38.5	L2	FLO	QP
1.608	15.9	10	56	40.1	L2	FLO	QP
2.064	18.3	10	56	37.7	L2	FLO	QP
2.28	14.2	10	56	41.8	L2	FLO	QP
0.264	9	10	51	42.3	L2	FLO	AVG
0.36	14	10	49	34.7	L2	FLO	AVG
0.462	17.5	10	47	29.2	L2	FLO	AVG
0.486	11.9	10	46	34.3	L2	FLO	AVG
0.744	12.9	10.1	46	33.1	L2	FLO	AVG
1.212	15.9	10	46	30.1	L2	FLO	AVG
1.506	13.6	10	46	32.4	L2	FLO	AVG
1.542	13.5	10	46	32.5	L2	FLO	AVG
2.124	15.1	10	46	30.9	L2	FLO	AVG
2.232	13.2	10	46	32.8	L2	FLO	AVG

7.3 Radiated Emissions – FCC: Section 15.109 (Unintentional Radiation) IC: RSS-210 2.6

7.3.1 Measurement Procedure

Radiated emissions tests were performed over the frequency range of 30MHz to 12.5GHz. Measurements of the radiated field strength were made at a distance of 3m from the boundary of the equipment under test (EUT) and the receiving antenna. The antenna height was varied from 1m to 4m so that the maximum radiated emissions level would be detected. Radiated measurements above 30MHz and below 1GHz were made with the Spectrum Analyzer’s resolution bandwidth set to 120 KHz using a Quasi-peak detector. Above 1GHz, peak and average measurements are taken with the RBW and VBW were set to 1MHz and 3MHz respectively.

7.3.2 Measurement Results

Results of the test are given in Tables 7.3.2-1 to 7.3.2-2 below:

Table 7.3.2-1: Radiated Emissions Tabulated Data – Dipole Antenna

Frequency (MHz)	Level (dBuV)		Antenna Polarity (H/V)	Correction Factors (dB)	Corrected Level (dBuV/m)		Limit (dBuV/m)		Margin (dB)	
	pk	Qpk/Avg			pk	Qpk/Avg	pk	Qpk/Avg	pk	Qpk/Avg
31.08	-----	21.09	V	-7.38	-----	13.71	-----	40.0	-----	26.3
114.57	-----	35.38	V	-13.44	-----	21.94	-----	43.5	-----	21.6
194.31	-----	36.91	V	-15.69	-----	21.22	-----	43.5	-----	22.3
475.12	-----	20.76	H	-5.74	-----	15.02	-----	46.0	-----	31.0
702.53	-----	20.86	H	-0.95	-----	19.91	-----	46.0	-----	26.1
907.31	-----	20.96	V	1.55	-----	22.51	-----	46.0	-----	23.5
920.24	-----	20.73	V	1.11	-----	21.84	-----	46.0	-----	24.2

* Note: All emissions above 920.24 MHz were attenuated below the permissible limit.

Table 7.3.2-2: Radiated Emissions Tabulated Data – Yagi Antenna

Frequency (MHz)	Level (dBuV)		Antenna Polarity (H/V)	Correction Factors (dB)	Corrected Level (dBuV/m)		Limit (dBuV/m)		Margin (dB)	
	pk	Qpk/Avg			pk	Qpk/Avg	pk	Qpk/Avg	pk	Qpk/Avg
30		20.20	V	-6.80	-----	13.40	-----	40.0	-----	26.6
115.583		37.21	V	-13.40	-----	23.81	-----	43.5	-----	19.7
194.55		38.79	V	-15.69	-----	23.10	-----	43.5	-----	20.4
345.79		19.34	H	-9.33	-----	10.01	-----	46.0	-----	36.0
488.06		20.60	V	-5.56	-----	15.04	-----	46.0	-----	31.0
702.53		20.78	V	-0.95	-----	19.83	-----	46.0	-----	26.2
923.48		25.94	V	1.20	-----	27.14	-----	46.0	-----	18.9

* Note: All emissions above 923.48 MHz were attenuated below the permissible limit.

7.4 Peak Output Power - FCC Section 15.247(b)(2) IC: RSS-210 A8.4(1)

7.4.1 Measurement Procedure (Conducted Method)

The 20dB bandwidth of the EUT was within the resolution bandwidth of spectrum analyzer, therefore the power measurement was made using the spectrum analyzer method. The RF output port of the EUT was directly connected to the input of the spectrum analyzer. The resolution and video bandwidth were set to > 20 dB bandwidth of the emission measured. The device employs >50 channels therefore the power is limited to 1 Watt.

7.4.2 Measurement Results

Results are shown in Table 7.4.2-1 and Figures 7.4.2-1 to 7.4.2-3 below.

Table 7.4.2-1: RF Output Power

Frequency [MHz]	Level [dBm]
902.76	21.63
915.24	21.76
927.24	21.73

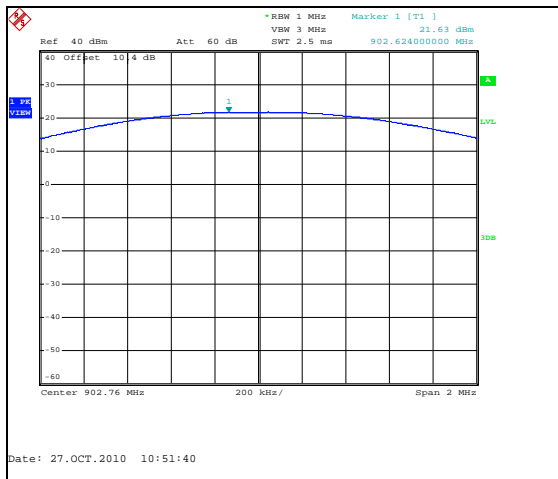

Figure 7.4.2-1: Output Power – LCH

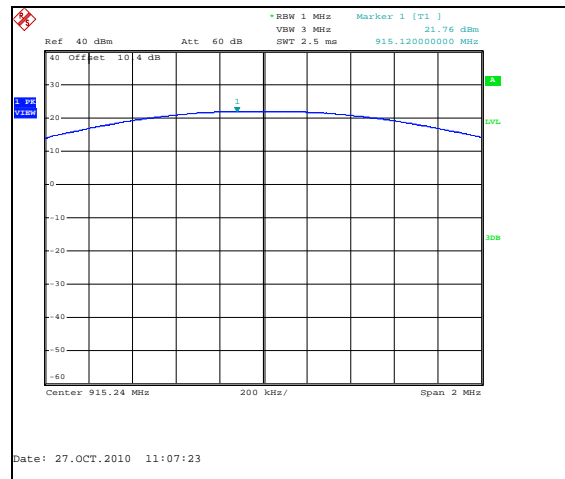

Figure 7.4.2-2: Output Power – MCH

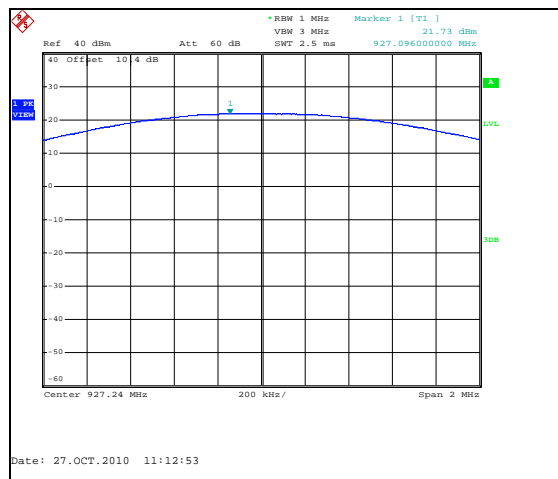

Figure 7.4.2-3: Output Power

7.5 Channel Usage Requirements

7.5.1 Carrier Frequency Separation – FCC: Section 15.247(a)(1) IC: RSS-210 A8.1(b)

7.5.1.1 Measurement Procedure

The RF output port of the EUT was directly connected to the input of the spectrum analyzer. The span of the spectrum analyzer was set wide enough to capture two adjacent peaks and the RBW and VBW were set to $\geq 1\%$ of the span.

7.5.1.2 Measurement Results

The adjacent channel separation was measured to be 480 kHz. Results are shown below in Figure 7.5.1.2-1.

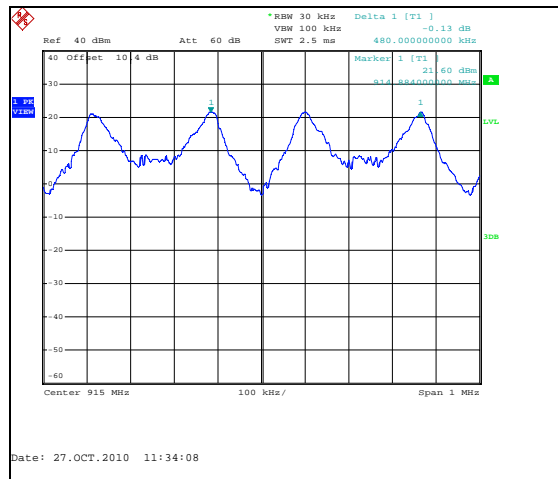

Figure 7.5.1.2-1: Channel Separation

7.5.2 Number of Hopping Channels – FCC: Section 15.247(a)(1)(i) IC: RSS-210 A8.1(c)

The 20dB bandwidth of the device is greater than 250 kHz. The device employs > 25 hopping channels as required. Results are shown below in Figures 7.5.2-1 to 7.5.2-3.

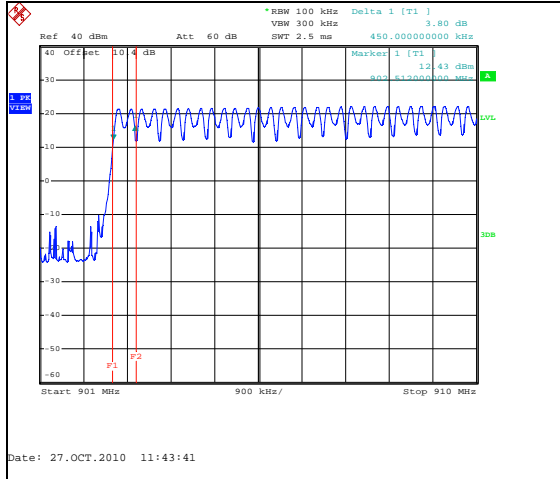

Figure 7.5.2-1: Hopping Channels

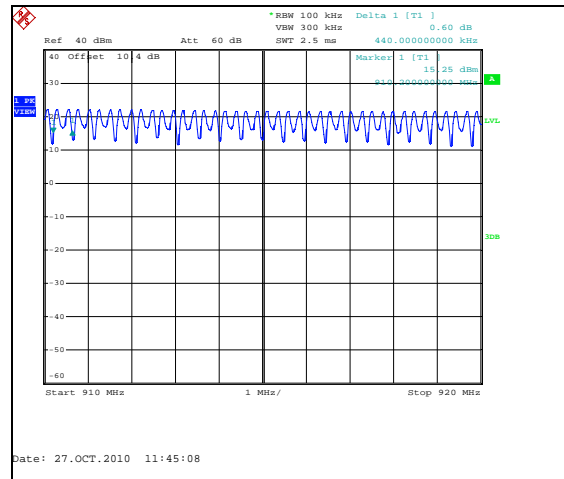

Figure 7.5.2-2: Hopping Channels

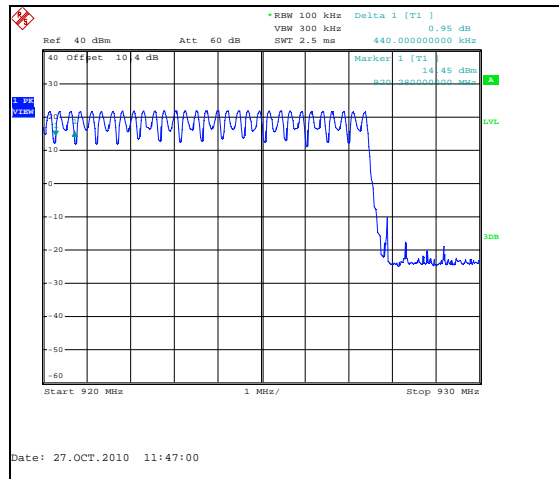

Figure 7.5.2-3: Hopping Channels

7.5.3 Channel Dwell Time – FCC: Section 15.247(a)(1)(i) IC: RSS-210 A8.1(c)

7.5.3.1 Measurement Procedure

The RF output port of the EUT was directly connected to the input of the spectrum analyzer. The hopping channel is centered on the analyzer and the span set to 0 Hz. The RBW was set to 1 MHz and the VBW to 3 MHz. Sweep time was adjusted to capture the burst duration of the emission. The marker-delta function of the analyzer was employed to measure the burst duration and repetition.

7.5.3.2 Measurement Results

The duration of the RF transmission was measured as 10.4 ms. The maximum time of occupancy on any channel in a 10 second period is shown as 104 ms. A single transmission and the transmission repetition are shown in figures 7.5.3.2-1 to 7.5.3.2-3 below.

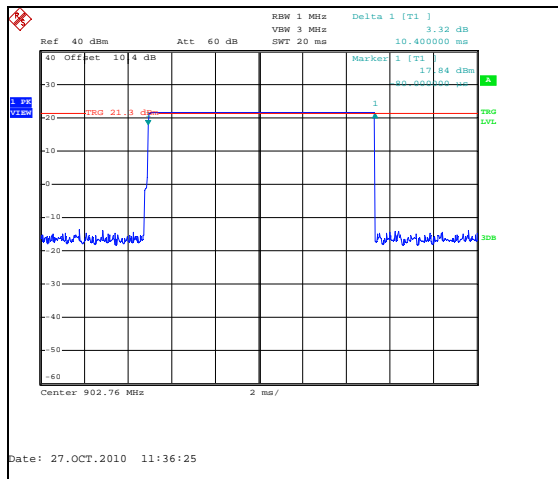

Figure 7.5.3.2-1: Dwell Time

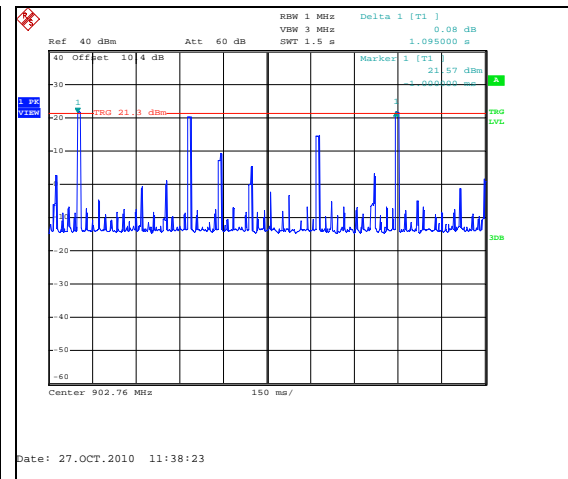

Figure 7.5.3.2-2: Transmission Repetition

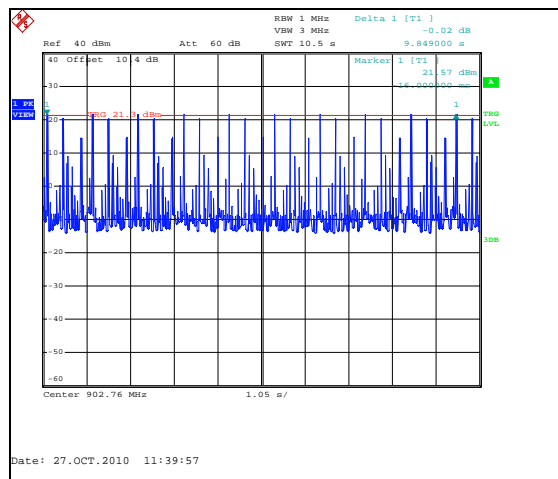

Figure 7.5.3.2-3: Transmission Repetition (10s Period)

7.5.4 20dB / 99% Bandwidth - FCC: Section 15.247(a)(1)(i) IC: RSS-210 A8.1(c)**7.5.4.1 Measurement Procedure**

The RF output port of the EUT was directly connected to the input of the spectrum analyzer. The spectrum analyzer span was set to 2 to 3 times the estimated bandwidth of the emission. The RBW was to $\geq 1\%$ of the estimated emission bandwidth. The trace was set to max hold with a peak detector active. The Delta function of the analyzer was utilized to determine the 20 dB bandwidth of the emission.

The 99% occupied bandwidth was measured with the spectrum analyzer span set to fully display the emission and approximately 20dB below the peak level. The RBW was to 1% to 3% of the approximate emission width. The trace was set to max hold with a peak detector active. The occupied bandwidth measurement function of the analyzer was used for the 99% bandwidth.

7.5.4.2 Measurement Results

Results are shown below in Table 7.5.4.2-1 and Figures 7.5.4.2-1 through 7.5.4.2-6.

Table 7.5.4.2-1: 20dB / 99% Bandwidth

Frequency [MHz]	20dB Bandwidth [kHz]	99% Bandwidth [kHz]
902.76	416.0	405.6
915.24	416.0	405.6
927.24	414.0	405.6

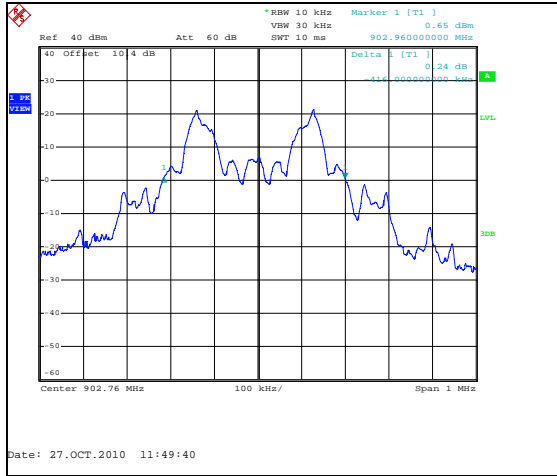

Figure 7.5.4.2-1: 20dB BW LCH

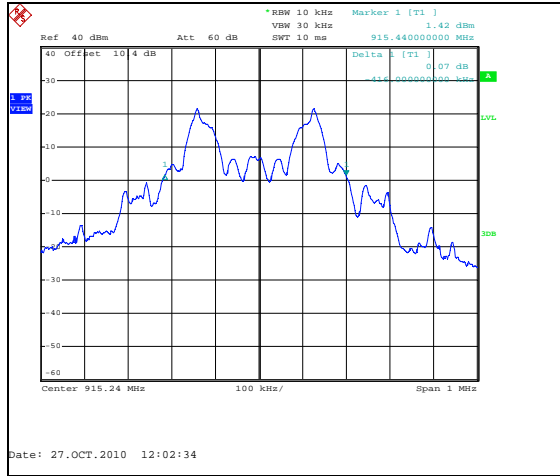

Figure 7.5.4.2-2: 20dB BW MCH

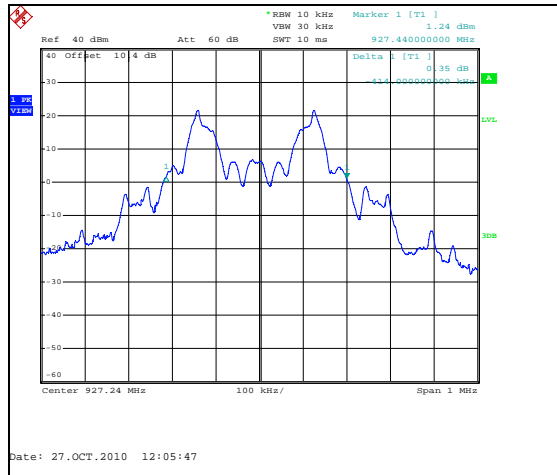

Figure 7.5.4.2-3: 20dB BW HCH

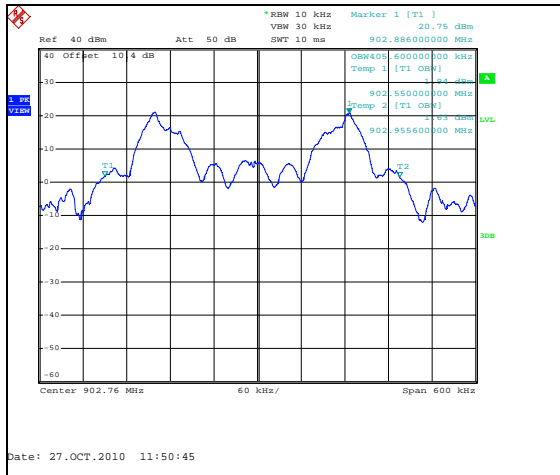

Figure 7.5.4.2-4: 99% BW LCH

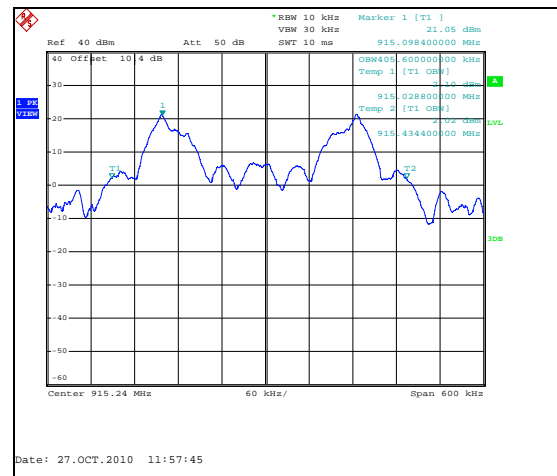

Figure 7.5.4.2-5: 99% BW MCH

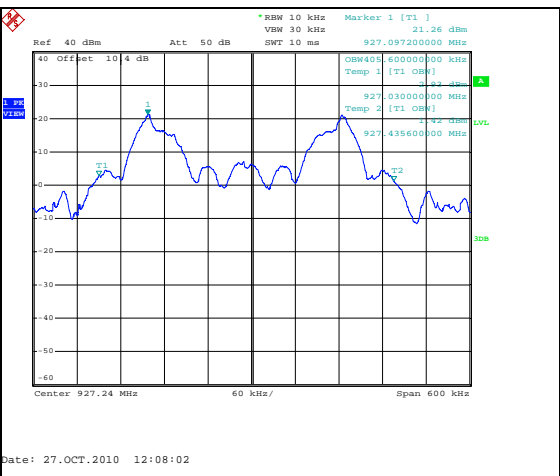

Figure 7.5.4.2-6: 99% BW HCH

7.6 Band-Edge Compliance and Spurious Emissions-FCC 15.247(d) IC: RSS-210 A8.5

7.6.1 Band-Edge Compliance of RF Conducted Emissions

7.6.1.1 Measurement Procedure

The RF output port of the EUT was directly connected to the input of the spectrum analyzer. The EUT was investigated at the lowest and highest channel available to determine band-edge compliance. For each measurement the spectrum analyzer's RBW was set to $\geq 1\%$ of the span, and the VBW was set to ≥ 3 times RBW.

7.6.1.2 Measurement Results

Results are shown in the figures 7.6.1.2-1 to 7.6.1.2.12 below.

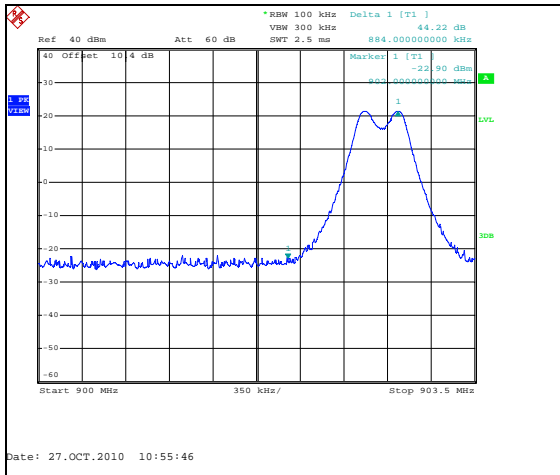

Figure 7.6.1.2-1: Lower Band-edge

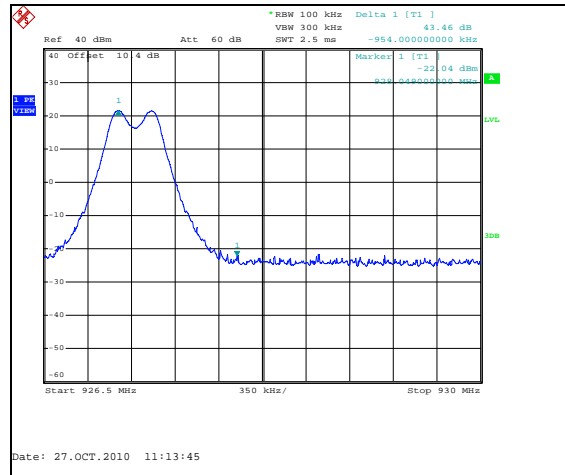

Figure 7.6.1.2-2: Upper Band-edge

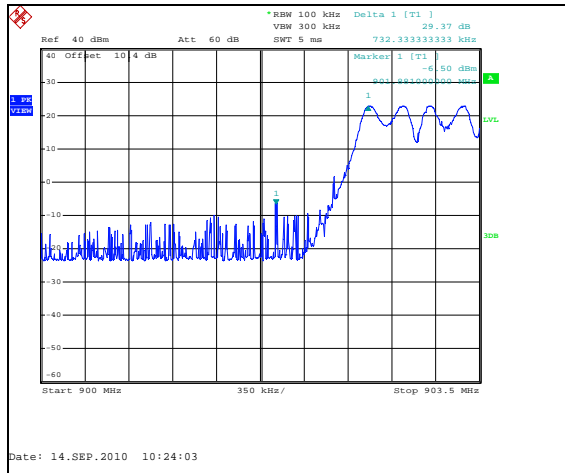

Figure 7.6.1.2-3: Lower Band-edge – Hopping

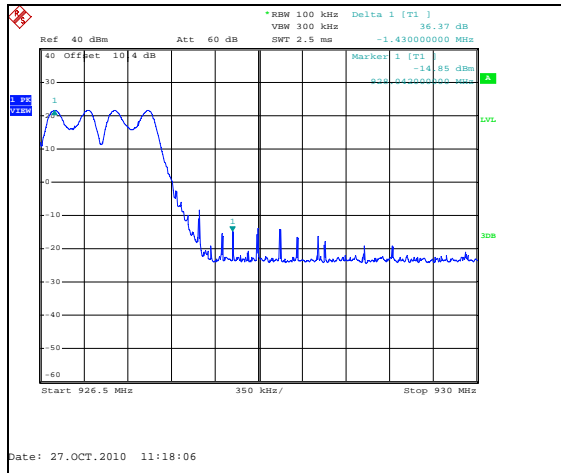

Figure 7.6.1.2-4: Upper Band-edge - Hopping

7.6.2 RF Conducted Spurious Emissions

7.6.2.1 Measurement Procedure

The RF output port of the EUT was directly connected to the input of the spectrum analyzer. The EUT was investigated for conducted spurious emissions from 30MHz to 10GHz, 10 times the highest fundamental frequency. Measurements were made at the low, center and high channels of the EUT. For each measurement, the spectrum analyzer's RBW was set to 100kHz. A peak detector function was used with the trace set to max hold.

RF conducted spurious emissions were evaluated for all combinations of modulations and data rates.

7.6.2.2 Measurement Results

Results are shown below in Figures 7.6.2.2-1 to 7.6.2.2-6:

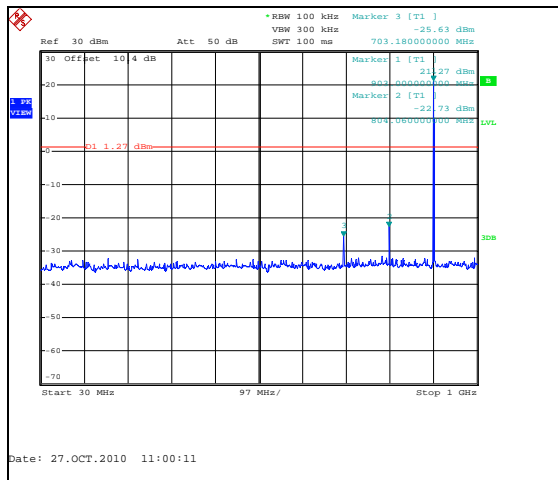

Figure 7.6.2.2-1: Conducted Emissions - LCH

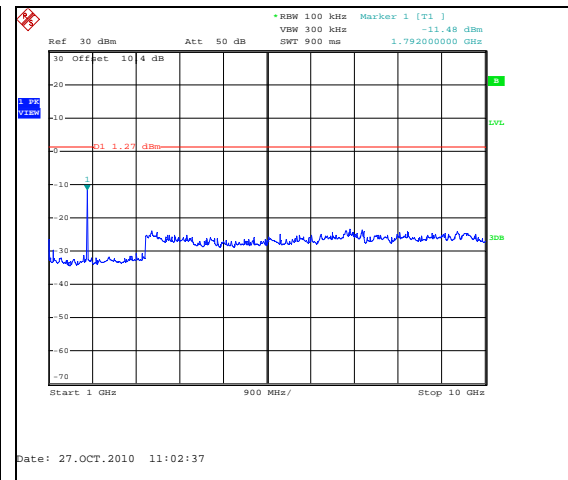

Figure 7.6.2.2-2: Conducted Emissions - LCH

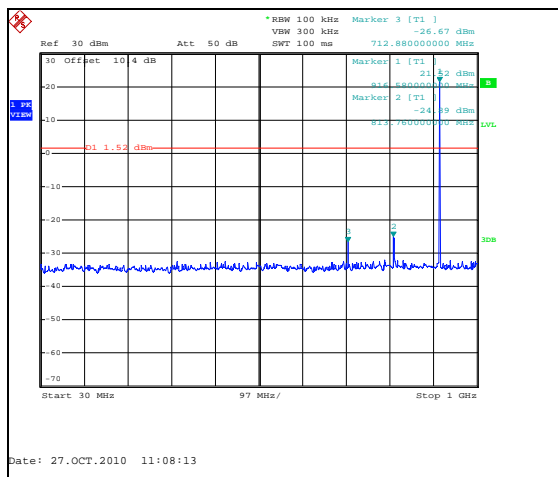

Figure 7.6.2.2-3: Conducted Emissions - MCH

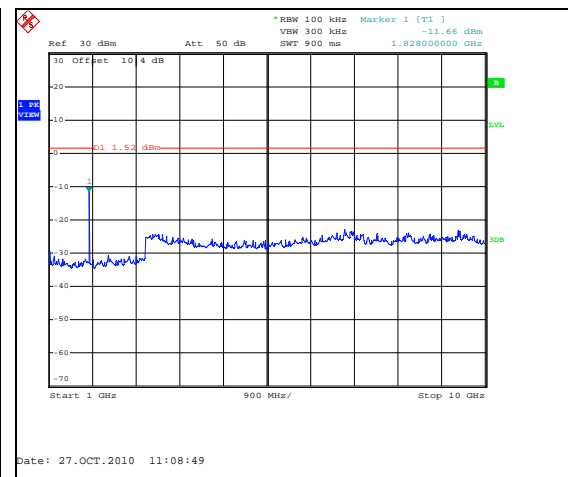

Figure 7.6.2.2-4: Conducted Emissions - MCH

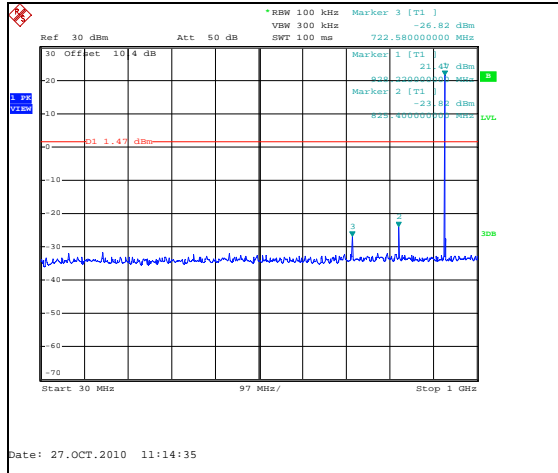

Figure 7.6.2.2-5: Conducted Emissions - HCH

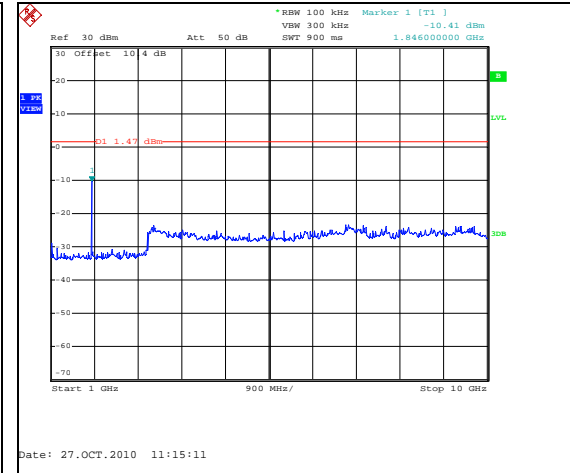

Figure 7.6.2.2-6: Conducted Emissions - HCH

7.6.3 Radiated Spurious Emissions - FCC Section 15.205 IC: RSS-210 2.6

7.6.3.1 Measurement Procedure

Radiated emissions tests were made over the frequency range of 30MHz to 10GHz, 10 times the highest fundamental frequency.

The EUT was rotated through 360° and the receive antenna height was varied from 1m to 4m so that the maximum radiated emissions level would be detected. For frequencies below 1000MHz, quasi-peak measurements were made using a resolution bandwidth RBW of 120 kHz and a video bandwidth VBW of 300 kHz. For frequencies above 1000MHz, peak measurements made with RBW and VBW of 1 MHz and 3MHz respectively.

The EUT was caused to generate a continuous carrier signal on the hopping channel.

7.6.3.2 Duty Cycle Correction

For average radiated measurements, using a 10.4% duty cycle, the measured level was reduced by a factor 19.66dB. The duty cycle correction factor is determined using the formula: $20\log(10.4/100) = 19.66\text{dB}$.

7.6.3.3 Measurement Results

Radiated spurious emissions found in the band of 30MHz to 10GHz are reported in the Tables 7.6.3.2-1 to 7.6.3.2-6 below.

Table 7.6.3.2-1: Radiated Spurious Emissions – Yagi, Low Channel

Frequency (MHz)	Level (dBuV)		Antenna Polarity (H/V)	Correction Factors (dB)	Corrected Level (dBuV/m)		Limit (dBuV/m)		Margin (dB)	
	pk	Qpk/Avg			pk	Qpk/Avg	pk	Qpk/Avg	pk	Qpk/Avg
2708.28	56.08	51.81	H	1.46	57.54	33.61	74.0	54.0	16.5	20.4
2708.28	61.37	57.53	V	1.46	62.83	39.33	74.0	54.0	11.2	14.7
3611.04	63.05	58.43	H	3.67	66.72	42.44	74.0	54.0	7.3	11.6
3611.04	63.59	58.71	V	3.67	67.26	42.72	74.0	54.0	6.7	11.3
4513.8	65.48	59.48	H	5.74	71.22	45.56	74.0	54.0	2.8	8.4
4513.8	64.97	58.95	V	5.74	70.71	45.03	74.0	54.0	3.3	9.0
5416.56	53.33	45.29	H	8.06	61.39	33.69	74.0	54.0	12.6	20.3
5416.56	54.69	46.48	V	8.06	62.75	34.88	74.0	54.0	11.3	19.1
8124.84	51.94	42.71	H	12.12	64.06	35.17	74.0	54.0	9.9	18.8
8124.84	54.28	45.23	V	12.12	66.40	37.69	74.0	54.0	7.6	16.3

Table 7.6.3.2-2: Radiated Spurious Emissions – Dipole, Low Channel

Frequency (MHz)	Level (dBuV)		Antenna Polarity (H/V)	Correction Factors (dB)	Corrected Level (dBuV/m)		Limit (dBuV/m)		Margin (dB)	
	pk	Qpk/Avg			pk	Qpk/Avg	pk	Qpk/Avg	pk	Qpk/Avg
2708.28	59.28	55.80	H	1.46	60.74	37.60	74.0	54.0	13.3	16.4
2708.28	65.42	62.28	V	1.46	66.88	44.08	74.0	54.0	7.1	9.9
3611.04	62.45	58.02	H	3.67	66.12	42.03	74.0	54.0	7.9	12.0
3611.04	65.64	61.18	V	3.67	69.31	45.19	74.0	54.0	4.7	8.8
4513.8	64.00	57.26	H	5.74	69.74	43.34	74.0	54.0	4.3	10.7
4513.8	66.01	60.07	V	5.74	71.75	46.15	74.0	54.0	2.2	7.8
5416.56	55.80	48.18	H	8.06	63.86	36.58	74.0	54.0	10.1	17.4
5416.56	58.53	51.48	V	8.06	66.59	39.88	74.0	54.0	7.4	14.1
8124.84	50.29	39.74	H	12.12	62.41	32.20	74.0	54.0	11.6	21.8
8124.84	56.22	47.61	V	12.12	68.34	40.07	74.0	54.0	5.7	13.9

Table 7.6.3.2-3: Radiated Spurious Emissions – Yagi, Mid Channel

Frequency (MHz)	Level (dBuV)		Antenna Polarity (H/V)	Correction Factors (dB)	Corrected Level (dBuV/m)		Limit (dBuV/m)		Margin (dB)	
	pk	Qpk/Avg			pk	Qpk/Avg	pk	Qpk/Avg	pk	Qpk/Avg
2745.72	60.24	55.24	H	1.55	61.79	37.13	74.0	54.0	12.2	16.9
2745.72	60.66	55.86	V	1.55	62.21	37.75	74.0	54.0	11.8	16.3
3660.96	60.93	54.60	H	3.87	64.80	38.81	74.0	54.0	9.2	15.2
3660.96	61.67	55.58	V	3.87	65.54	39.79	74.0	54.0	8.5	14.2
4576.2	66.68	59.47	H	5.99	72.67	45.80	74.0	54.0	1.3	8.2
4576.2	66.86	59.53	V	5.99	72.85	45.86	74.0	54.0	1.1	8.1
7321.92	51.02	41.36	H	11.29	62.31	32.99	74.0	54.0	11.7	21.0
7321.92	55.89	47.95	V	11.29	67.18	39.58	74.0	54.0	6.8	14.4
8237.16	54.42	45.68	H	12.18	66.60	38.20	74.0	54.0	7.4	15.8
8237.16	55.22	46.53	V	12.18	67.40	39.05	74.0	54.0	6.6	14.9

Table 7.6.3.2-4: Radiated Spurious Emissions – Dipole, Mid Channel

Frequency (MHz)	Level (dBuV)		Antenna Polarity (H/V)	Correction Factors (dB)	Corrected Level (dBuV/m)		Limit (dBuV/m)		Margin (dB)	
	pk	Qpk/Avg			pk	Qpk/Avg	pk	Qpk/Avg	pk	Qpk/Avg
2745.72	52.79	52.79	H	1.55	54.34	34.68	74.0	54.0	19.7	19.3
2745.72	62.86	59.24	V	1.55	64.41	41.13	74.0	54.0	9.6	12.9
3660.96	62.90	58.20	H	3.87	66.77	42.41	74.0	54.0	7.2	11.6
3660.96	64.70	60.26	V	3.87	68.57	44.47	74.0	54.0	5.4	9.5
4576.2	66.26	60.34	H	5.99	72.25	46.67	74.0	54.0	1.7	7.3
4576.2	67.18	60.95	V	5.99	73.17	47.28	74.0	54.0	0.8	6.7
7321.92	56.57	48.48	V	11.29	67.86	40.11	74.0	54.0	6.1	13.9
8237.16	53.04	43.89	H	12.18	65.22	36.41	74.0	54.0	8.8	17.6
8237.16	57.54	48.54	V	12.18	69.72	41.06	74.0	54.0	4.3	12.9

Table 7.6.3.2-5: Radiated Spurious Emissions – Yagi, High Channel

Frequency (MHz)	Level (dBuV)		Antenna Polarity (H/V)	Correction Factors (dB)	Corrected Level (dBuV/m)		Limit (dBuV/m)		Margin (dB)	
	pk	Qpk/Avg			pk	Qpk/Avg	pk	Qpk/Avg	pk	Qpk/Avg
2781.72	58.93	55.54	H	1.63	60.56	37.51	74.0	54.0	13.4	16.5
2781.72	63.29	59.85	V	1.63	64.92	41.82	74.0	54.0	9.1	12.2
3708.96	61.80	56.28	H	4.06	65.86	40.68	74.0	54.0	8.1	13.3
3708.96	64.59	59.87	V	4.06	68.65	44.27	74.0	54.0	5.4	9.7
4636.2	65.96	59.42	H	6.24	72.20	46.00	74.0	54.0	1.8	8.0
4636.2	64.07	57.94	V	6.24	70.31	44.52	74.0	54.0	3.7	9.5
7417.92	51.47	42.27	H	11.30	62.77	33.91	74.0	54.0	11.2	20.1
7417.92	53.74	45.00	V	11.30	65.04	36.64	74.0	54.0	9.0	17.4
8345.16	51.90	42.21	H	12.25	64.15	34.80	74.0	54.0	9.9	19.2
8345.16	51.85	42.07	V	12.25	64.10	34.66	74.0	54.0	9.9	19.3

Table 7.6.3.2-6: Radiated Spurious Emissions – Dipole, High Channel

Frequency (MHz)	Level (dBuV)		Antenna Polarity (H/V)	Correction Factors (dB)	Corrected Level (dBuV/m)		Limit (dBuV/m)		Margin (dB)	
	pk	Qpk/Avg			pk	Qpk/Avg	pk	Qpk/Avg	pk	Qpk/Avg
2781.72	53.43	48.81	H	1.63	55.06	30.78	74.0	54.0	18.9	23.2
2781.72	57.80	54.16	V	1.63	59.43	36.13	74.0	54.0	14.6	17.9
3708.96	64.43	59.46	H	4.06	68.49	43.86	74.0	54.0	5.5	10.1
3708.96	62.44	57.56	V	4.06	66.50	41.96	74.0	54.0	7.5	12.0
4636.2	62.97	56.36	H	6.24	69.21	42.94	74.0	54.0	4.8	11.1
4636.2	63.94	57.07	V	6.24	70.18	43.65	74.0	54.0	3.8	10.4
7417.92	50.35	39.35	H	11.30	61.65	30.99	74.0	54.0	12.4	23.0
7417.92	54.73	46.28	V	11.30	66.03	37.92	74.0	54.0	8.0	16.1
8345.16	55.43	46.19	V	12.25	67.68	38.78	74.0	54.0	6.3	15.2

7.6.3.4 Sample Calculation:

$$R_C = R_U + CF_T$$

Where:

 $CF_T =$ Total Correction Factor (AF+CA+AG)-DC (Average Measurements Only) $R_U =$ Uncorrected Reading $R_C =$ Corrected Level $AF =$ Antenna Factor $CA =$ Cable Attenuation $AG =$ Amplifier Gain $DC =$ Duty Cycle Correction Factor**Example Calculation: Peak**Corrected Level: $56.08 + 1.46 = 57.54\text{dBuV/m}$ Margin: $74\text{dBuV/m} - 57.54\text{dBuV/m} = 16.5\text{dB}$ **Example Calculation: Average**Corrected Level: $51.81 + 1.46 - 19.66 = 33.61\text{dBuV/m}$ Margin: $54\text{dBuV/m} - 33.61\text{dBuV/m} = 20.4\text{dB}$ **8 CONCLUSION**

In the opinion of ACS, Inc. the DNT90C and DNT90P, manufactured by RFM/Cirronet meet the requirements of FCC Part 15 subpart C and Industry Canada's Radio Standards Specification RSS-210.

END REPORT