



Excellence in Compliance Testing

Certification Test Report

FCC ID: HSW-CCT24

IC: 4492A-CCT24

FCC Rule Part: 15.247

IC Radio Standards Specification: RSS-210

ACS Report Number: 14-0204.W06.1C

Manufacturer: RF Monolithics

Model: CCT24

Test Begin Date: May 13, 2014

Test End Date: June 2, 2014

Report Issue Date: September 10, 2014



FOR THE SCOPE OF ACCREDITATION UNDER LAB Code 200612-0

This report must not be used by the client to claim product certification, approval, or endorsement by NVLAP, NIST, or any agency of the Federal Government.

Reviewed by:

Kirby Munroe

Director, Wireless Certifications

ACS, Inc.

This test report shall not be reproduced except in full. This report may be reproduced in part with prior written consent of ACS, Inc. The results contained in this report are representative of the sample(s) submitted for evaluation.

This report contains 31 pages

TABLE OF CONTENTS

1	GENERAL	3
1.1	PURPOSE.....	3
1.2	PRODUCT DESCRIPTION.....	3
1.3	TEST METHODOLOGY AND CONSIDERATIONS	3
2	TEST FACILITIES	4
2.1	LOCATION	4
2.2	LABORATORY ACCREDITATIONS/RECOGNITIONS/CERTIFICATIONS	4
2.3	RADIATED EMISSIONS TEST SITE DESCRIPTION	5
2.3.1	<i>Semi-Anechoic Chamber Test Site</i>	5
2.3.2	<i>Open Area Tests Site (OATS)</i>	6
2.4	CONDUCTED EMISSIONS TEST SITE DESCRIPTION	7
3	APPLICABLE STANDARD REFERENCES	7
4	LIST OF TEST EQUIPMENT	8
5	SUPPORT EQUIPMENT	9
6	EQUIPMENT UNDER TEST SETUP BLOCK DIAGRAM	9
7	SUMMARY OF TESTS	10
7.1	ANTENNA REQUIREMENT – SECTION 15.203.....	10
7.2	POWER LINE CONDUCTED EMISSIONS – FCC 15.207; IC RSS-GEN 7.2.4	10
7.2.1	<i>Measurement Procedure</i>	10
7.2.2	<i>Measurement Results</i>	10
7.2.2.1	Results of the test are shown below in Tables 7.2.2-1 through 7.2.2-2.	10
7.3	6dB / 99% BANDWIDTH – FCC 15.247(A)(2); IC RSS-210 A8.2(A)	11
7.3.1	<i>Measurement Procedure</i>	11
7.3.2	<i>Measurement Results</i>	11
7.4	FUNDAMENTAL EMISSION OUTPUT POWER – FCC 15.247(B)(3), IC: RSS-210 A8.4(4)	15
7.4.1	<i>Measurement Procedure</i>	15
7.4.2	<i>Measurement Results</i>	15
7.5	EMISSION LEVELS – FCC 15.247(D), 15.205, 15.209; IC RSS-210 2.2/A8.5, RSS-GEN 7.2.2.....	16
7.5.1	<i>Emissions into Non-restricted Frequency Bands</i>	16
7.5.1.1	Measurement Procedure	16
7.5.1.2	Measurement Results	16
7.5.2	<i>Emissions into Restricted Frequency Bands</i>	21
7.5.2.1	Measurement Procedure.....	21
7.5.2.2	Duty Cycle Correction	21
7.5.2.3	Measurement Results	21
7.5.2.4	Sample Calculation:	28
7.6	MAXIMUM POWER SPECTRAL DENSITY IN THE FUNDAMENTAL EMISSION – FCC 15.247(E) IC: RSS-210 A8.2(B)	29
7.6.1	<i>Measurement Procedure</i>	29
7.6.2	<i>Measurement Results</i>	29
8	CONCLUSION	31

1 GENERAL

1.1 Purpose

The purpose of this report is to demonstrate compliance with Part 15 Subpart C of the FCC's Code of Federal Regulations and Industry Canada's Radio Standards Specification RSS-210 for Certification for single modular approval.

1.2 Product Description

The CCT24 is a 2.4 GHz frequency hopping transceiver designed for use in industrial and commercial monitoring and control markets. The CCT24 employs a dual carrier transmission.

Technical Information:

Detail	Description
Frequency Range	2409.55 – 2479.85 MHz
Number of Channels	38
Modulation Format	FSK
Data Rate(s)	362kbps
Operating Voltage	3.3VDC – 5.5VDC
Number of Inputs/Outputs	2 (Tx/Rx Diversity)
Antenna Type / Gain	Dipole / 9dBi Corner reflector / 14dBi Patch / 12dBi Yagi / 13.9dBi PIFA / 4dBi CP Beam / 14dBi

Manufacturer Information:

RF Monolithics
4441 Sigma Road
Dallas, TX 75244

Test Sample Serial Number: 24

Test Sample Condition: The test samples were provided in good working order with no visible defects.

1.3 Test Methodology and Considerations

The EUT was evaluated for radiated emissions in multiple orientations and worst case data provided where applicable. Worst case orientation for radiated emissions was Y-position. See test setup photos for additional details.

The EUT provides (2) antenna ports for Tx/Rx diversity, ANT 0/1. Preliminary measurements for radiated emissions were taken for both ports and worst case data provided where applicable. Worst case antenna port for radiated emissions was ANT1. For RF conducted measurements, both antenna ports were evaluated in full.

Power settings utilized during testing are as follows:

LCH (2409.55 MHz) Power Setting: 21

MCH (2443.75 MHz) Power Setting: 21

HCH (2479.85 MHz) Power Setting: 21

2 TEST FACILITIES

2.1 Location

The radiated and conducted emissions test sites are located at the following address:

Advanced Compliance Solutions
5015 B.U. Bowman Drive
Buford, GA 30518
Phone: (770) 831-8048
Fax: (770) 831-8598

2.2 Laboratory Accreditations/Recognitions/Certifications

ACS is accredited to ISO/IEC 17025 by the National Institute of Standards and Technology under their National Voluntary Laboratory Accreditation Program (NVLAP), Lab Code 200612-0. Unless otherwise specified, all tests methods described within this report are covered under the ISO/IEC 17025 scope of accreditation.

The Semi-Anechoic Chamber Test Site, Open Area Test Site (OATS) and Conducted Emissions Site have been fully described, submitted to, and accepted by the FCC, Industry Canada and the Japanese Voluntary Control Council for Interference by information technology equipment.

FCC Registration Number: 511277

Industry Canada Lab Code: IC 4175A

VCCI Member Number: 1831

- VCCI OATS Registration Number R-1526
- VCCI Conducted Emissions Site Registration Number: C-1608

2.3 Radiated Emissions Test Site Description

2.3.1 Semi-Anechoic Chamber Test Site

The Semi-Anechoic Chamber Test Site consists of a 20' x 30' x 18' shielded enclosure. The chamber is lined with Toyo Ferrite Grid Absorber, model number FFG-1000. The ferrite tile grid is 101 x 101 x 19mm thick and weighs approximately 550 grams. These tiles are mounted on steel panels and installed directly on the inner walls of the chamber.

The turntable is 150cm in diameter and is located 160cm from the back wall of the chamber. The chamber is grounded via 1 - 8' copper ground rod, installed at the center of the back wall, it is bound to the ground plane using 3/4" stainless steel braided cable.

The turntable is all steel, flush mounted table installed in an all steel frame. The table is remotely operated from inside the control room located 25' from the range. The turntable is electrically bonded to the surrounding ground plane via steel fingers installed on the edge of the turn table. The steel fingers make constant contact with the ground plane during operation.

Behind the turntable is a 3' x 6' x 4' deep shielded pit used for support equipment if necessary. The pit is equipped with 1 - 4" PVC chases from the turntable to the pit that allow for cabling to the EUT if necessary. The underside of the turntable can be accessed from the pit so cables can be supplied to the EUT from the pit.

A diagram of the Semi-Anechoic Chamber Test Site is shown in Figure 2.3-1 below:

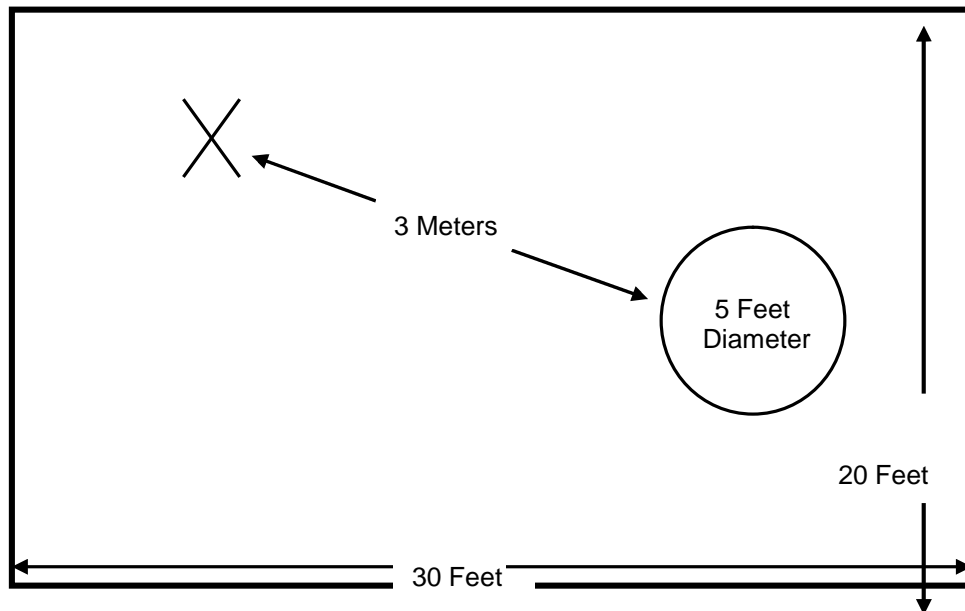

Figure 2.3-1: Semi-Anechoic Chamber Test Site

2.3.2 Open Area Tests Site (OATS)

The open area test site consists of a 40' x 66' concrete pad covered with a perforated electro-plated galvanized sheet metal. The perforations in the sheet metal are 1/8" holes that are staggered every 3/16". The individual sheets are placed to overlap each other by 1/4" and are riveted together to provide a continuous seam. Rivets are spaced every 3" in a 3 x 20 meter perimeter around the antenna mast and EUT area. Rivets in the remaining area are spaced as necessary to properly secure the ground plane and maintain the electrical continuity.

The entire ground plane extends 12' beyond the turntable edge and 16' beyond the antenna mast when set to a 10 meter measurement distance. The ground plane is grounded via 4 - 8' copper ground rods, each installed at a corner of the ground plane and bound to the ground plane using 3/4" stainless steel braided cable.

The turntable is an all aluminum 10' flush mounted table installed in an all aluminum frame. The table is remotely operated from inside the control room located 40' from the range. The turntable is electrically bonded to the surrounding ground plane via steel fingers installed on the edge of the turn table. The steel fingers make constant contact with the ground plane during operation.

Adjacent to the turntable is a 7' x 7' square and 4' deep concrete pit used for support equipment if necessary. The pit is equipped with 5 - 4" PVC chases from the pit to the control room that allow for cabling to the EUT if necessary. The underside of the turntable can be accessed from the pit so cables can be supplied to the EUT from the pit. The pit is covered with 2 sheets of 1/4" diamond style re-enforced steel sheets. The sheets are painted to match the perforated steel ground plane; however the underside edges have been masked off to maintain the electrical continuity of the ground plane. All reflecting objects are located outside of the ellipse defined in ANSI C63.4.

A diagram of the Open Area Test Site is shown in Figure 2.3-2 below:

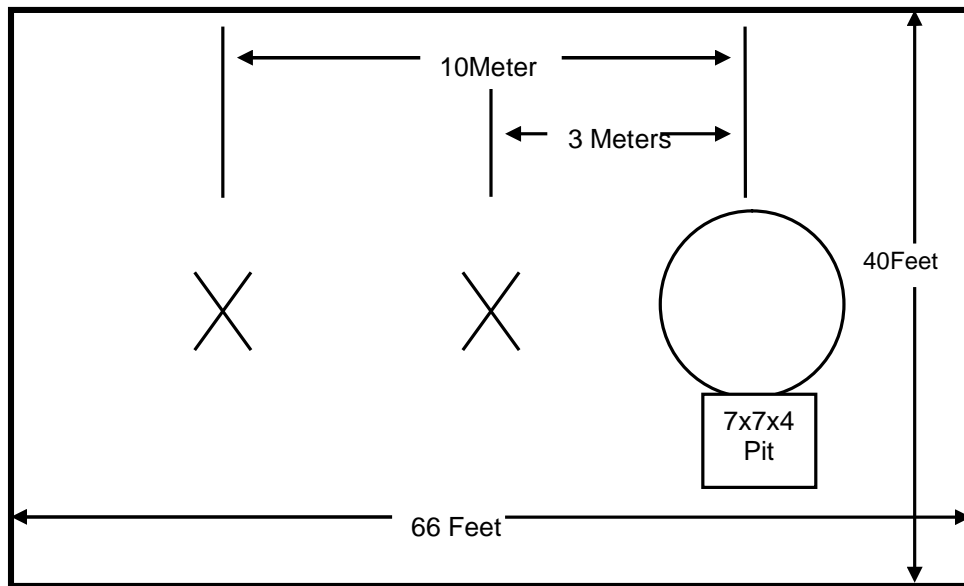

Figure 2.3-2: Open Area Test Site

2.4 Conducted Emissions Test Site Description

The AC mains conducted EMI site is located in the main EMC lab. It consists of an 8' x 8' solid aluminum horizontal ground reference plane (GRP) bonded every 3" to an 8' X 8' vertical ground plane.

The site is of sufficient size to test table top and floor standing equipment in accordance with section 6.1.4 of ANSI C63.4.

A diagram of the room is shown below in figure 4.1.3-1:

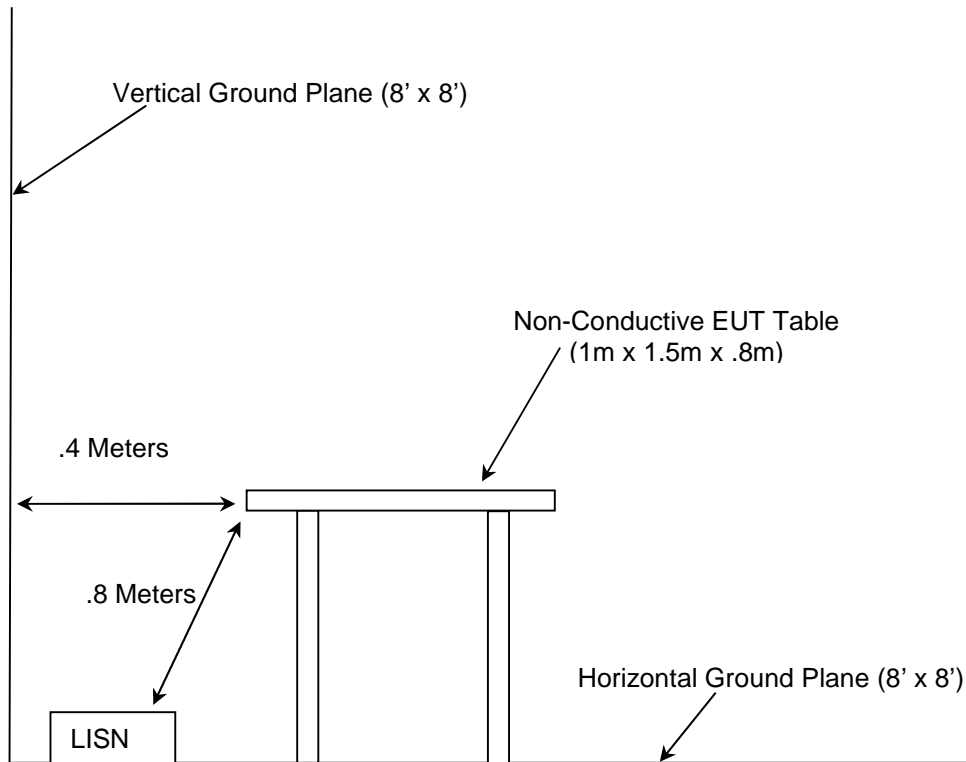

Figure 2.4-1: AC Mains Conducted EMI Site

3 APPLICABLE STANDARD REFERENCES

The following standards were used:

- ❖ ANSI C63.4-2009: Method of Measurements of Radio-Noise Emissions from Low-Voltage Electrical and Electronic Equipment in the 9KHz to 40GHz
- ❖ ANSI C63.10-2009: American National Standard for Testing Unlicensed Wireless Devices
- ❖ US Code of Federal Regulations (CFR): Title 47, Part 2, Subpart J: Equipment Authorization Procedures, 2014
- ❖ US Code of Federal Regulations (CFR): Title 47, Part 15, Subpart C: Radio Frequency Devices, Intentional Radiators, 2014
- ❖ FCC KDB 558074 D01 DTS Meas Guidance v03r01 - Guidance for Performing Compliance Measurements on Digital Transmission Systems (DTS) Operating Under §15.247, April 9, 2013
- ❖ Industry Canada Radio Standards Specification: RSS-210 - Low-power License-exempt Radiocommunication Devices (All Frequency Bands): Category I Equipment, Issue 8, Dec 2010
- ❖ Industry Canada Radio Standards Specification: RSS-GEN – General Requirements and Information for the Certification of Radiocommunication Equipment, Issue 3, Dec 2010.

4 LIST OF TEST EQUIPMENT

The calibration interval of test equipment is annually or the manufacturer's recommendations. Where the calibration interval deviates from the annual cycle based on the instrument manufacturer's recommendations, it shall be stated below.

Table 4-1: Test Equipment

AssetID	Manufacturer	Model #	Equipment Type	Serial #	Last Calibration Date	Calibration Due Date
1	Rohde & Schwarz	ESMI - Display	Spectrum Analyzers	833771/007	8/2/2012	8/2/2014
2	Rohde & Schwarz	ESMI-Receiver	Spectrum Analyzers	839587/003	8/2/2012	8/2/2014
30	Spectrum Technologies	DRH-0118	Antennas	970102	4/23/2013	4/23/2015
40	EMCO	3104	Antennas	3211	2/14/2013	2/14/2015
73	Agilent	8447D	Amplifiers	2727A05624	7/16/2013	7/16/2014
167	ACS	Chamber EMI Cable Set	Cable Set	167	11/7/2013	11/7/2014
267	Agilent	N1911A	Meters	MY45100129	7/30/2013	7/30/2015
268	Agilent	N1921A	Sensors	MY45240184	7/30/2013	7/30/2015
292	Florida RF Cables	SMR-290AW-480.0-SMR	Cables	None	3/17/2014	3/17/2015
334	Rohde&Schwarz	3160-09	Antennas	49404	11/4/2010	NCR
335	Suhner	SF-102A	Cables	882/2A	7/29/2013	7/29/2014
338	Hewlett Packard	8449B	Amplifiers	3008A01111	7/30/2013	7/30/2015
340	Aeroflex/Weinschel	AS-20	Attenuators	7136	7/30/2013	7/30/2014
345	Suhner Sucoflex	102A	Cables	1077/2A	7/29/2013	7/29/2014
412	Electro Metrics	LPA-25	Antennas	1241	7/27/2012	7/27/2014
422	Florida RF	SMS-200AW-72.0-SMR	Cables	805	11/7/2013	11/7/2014
432	Microwave Circuits	H3G020G4	Filters	264066	6/19/2013	6/19/2014
616	Florida RF Cables	SMRE-200W-12.0-SMRE	Cables	N/A	9/26/2013	9/26/2014
622	Rohde & Schwarz	FSV40	Analyzers	101338	11/19/2013	11/19/2014

5 SUPPORT EQUIPMENT

Table 5-1: Support Equipment

Item	Equipment Type (Host)	Manufacturer	Model Number	Serial Number
1	Evaluation Board	Murata	Dual Carrier 2.4GHz Eval Board	EVB21
2	DC Power Supply	GlobTek, Inc.	GT-21088-0909-W2	02106248/03

6 EQUIPMENT UNDER TEST SETUP BLOCK DIAGRAM

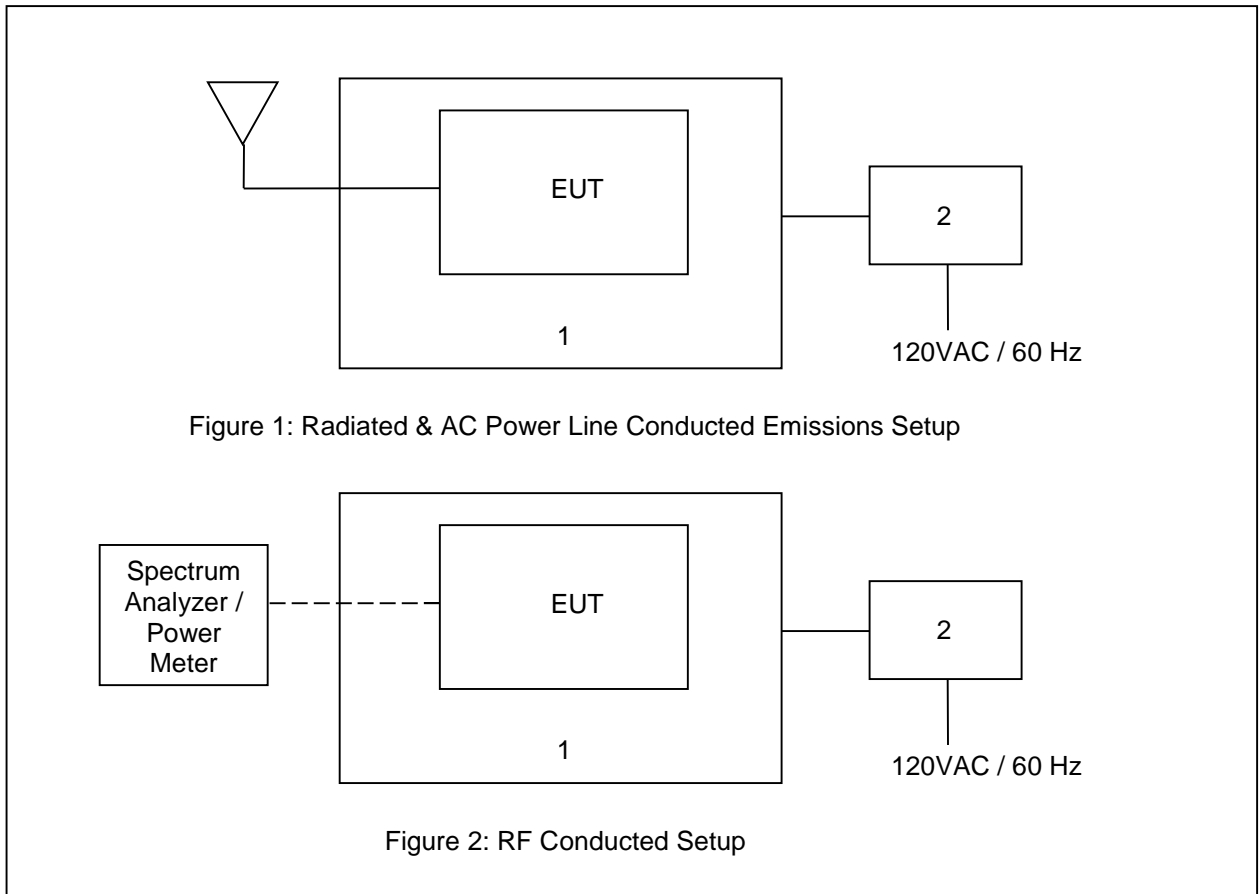

Figure 6-1: EUT Test Setup

7 SUMMARY OF TESTS

Along with the tabular data shown below, plots were taken of all signals deemed important enough to document.

7.1 Antenna Requirement – Section 15.203

A U.FL miniature coaxial connector is provided by the EUT thus satisfying the requirements of Part 15.203 for unique antenna coupling.

7.2 Power Line Conducted Emissions – FCC 15.207; IC RSS-Gen 7.2.4

7.2.1 Measurement Procedure

ANSI C63.4 sections 6 and 7 were the guiding documents for this evaluation. Conducted emissions were performed from 150kHz to 30MHz with the spectrum analyzer's resolution bandwidth set to 9kHz and the video bandwidth set to 30kHz. The calculation for the conducted emissions is as follows:

Corrected Reading = Analyzer Reading + LISN Loss + Cable Loss

Margin = Applicable Limit - Corrected Reading

7.2.2 Measurement Results

7.2.2.1 Results of the test are shown below in Tables 7.2.2-1 through 7.2.2-2.

Table 7.2.2-1: Conducted EMI Results Line 1

Frequency (MHz)	Uncorrected Reading		Total Correction Factor (dB)	Corrected Level		Limit		Margin (dB)	
	Quasi-Peak	Average		Quasi-Peak	Average	Quasi-Peak	Average	Quasi-Peak	Average
5.65677	17.746	14.296	10.362	28.108	24.658	60	50	31.892	25.342
5.13275	20.928	18.957	10.35	31.278	29.307	60	50	28.722	20.693
4.60902	21.313	20.694	10.34	31.652	31.034	56	46	24.348	14.966
4.50452	20.359	19.354	10.338	30.697	29.692	56	46	25.303	16.308
3.87497	18.681	17.8	10.327	29.008	28.127	56	46	26.992	17.873
0.2092	27.943	21.007	10.298	38.24	31.305	64.309	54.309	26.068	23.003

Table 7.2.2-2: Conducted EMI Results Line 2

Frequency (MHz)	Uncorrected Reading		Total Correction Factor (dB)	Corrected Level		Limit		Margin (dB)	
	Quasi-Peak	Average		Quasi-Peak	Average	Quasi-Peak	Average	Quasi-Peak	Average
4.9801	4.231	0.009	10.346	14.577	10.355	56	46	41.423	35.645
4.98	4.212	-0.288	10.346	14.558	10.058	56	46	41.442	35.942
4.92325	22.587	22.366	10.345	32.932	32.711	56	46	23.068	13.289
4.81789	22.298	21.862	10.343	32.641	32.205	56	46	23.359	13.795
4.19084	22.468	21.903	10.332	32.8	32.235	56	46	23.2	13.765
2.19974	23.573	19.186	10.222	33.794	29.407	56	46	22.206	16.593

7.3 6dB / 99% Bandwidth – FCC 15.247(a)(2); IC RSS-210 A8.2(a)

7.3.1 Measurement Procedure

The 6dB bandwidth was measured in accordance with the FCC KDB 558074 D01 DTS Meas Guidance v03r01. The Resolution Bandwidth (RBW) of the spectrum analyzer was set to 100 kHz. The Video Bandwidth (VBW) was set to ≥ 3 times the RBW. The trace was set to max hold with a peak detector active. The marker-delta function of the spectrum analyzer was utilized to determine the 6 dB bandwidth of the emission.

The occupied bandwidth measurement function of the spectrum analyzer was used to measure the 99% bandwidth. The span of the analyzer was set to capture all products of the modulation process, including the emission sidebands. The resolution bandwidth was set to as close to 1% of the selected span as is possible without being below 1%. The video bandwidth was set to 3 times the resolution bandwidth. A sampling detector was used.

7.3.2 Measurement Results

Results are shown below in tables 7.3.2-1 to 7.3.2-2 and figures 7.3.2-1 to 7.3.2-12:

Table 7.3.2-1: 6dB / 99% Bandwidth – ANT0

Frequency [MHz]	6dB Bandwidth [MHz]	99% Bandwidth [MHz]
2409.55	1.218	1.391
2443.75	1.221	1.388
2479.85	1.219	1.387

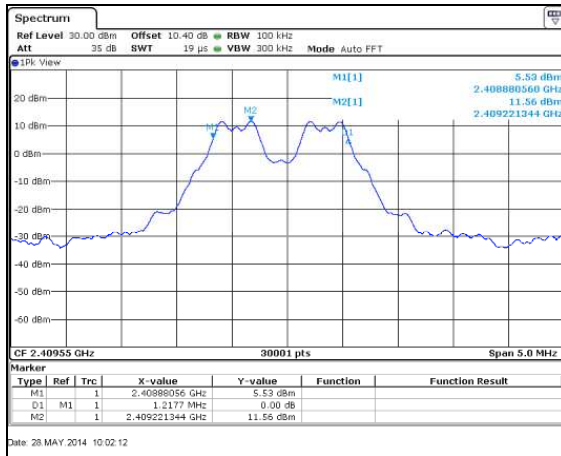

Figure 7.3.2-1: 6dB Bandwidth Plot – LCH



Figure 7.3.2-2: 6dB Bandwidth Plot – MCH



Figure 7.3.2-3: 6dB Bandwidth Plot – HCH

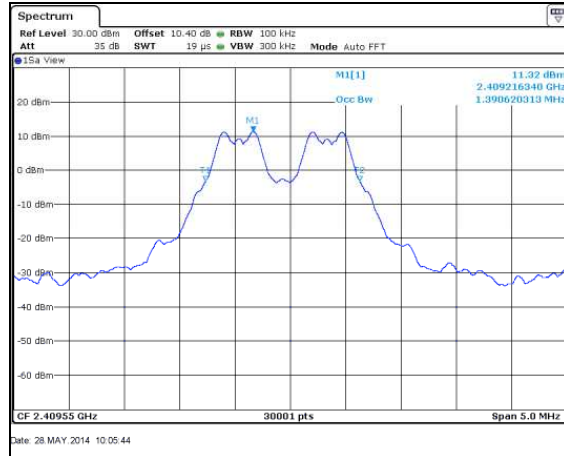

Figure 7.3.2-4: 99% Bandwidth Plot – LCH



Figure 7.3.2-5: 99% Bandwidth Plot – MCH



Figure 7.3.2-6: 99% Bandwidth Plot – HCH

Table 7.3.2-2: 6dB / 99% Bandwidth – ANT1

Frequency [MHz]	6dB Bandwidth [MHz]	99% Bandwidth [MHz]
2409.55	1.218	1.379
2443.75	1.218	1.384
2479.85	1.217	1.388



Figure 7.3.2-7: 6dB Bandwidth Plot – LCH

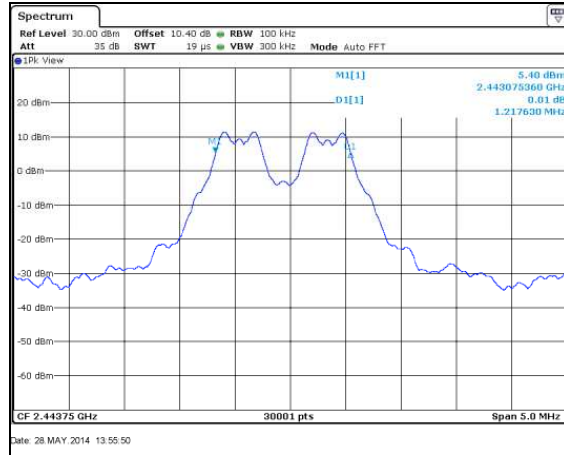

Figure 7.3.2-8: 6dB Bandwidth Plot – MCH



Figure 7.3.2-9: 6dB Bandwidth Plot – HCH



Figure 7.3.2-10: 99% Bandwidth Plot – LCH

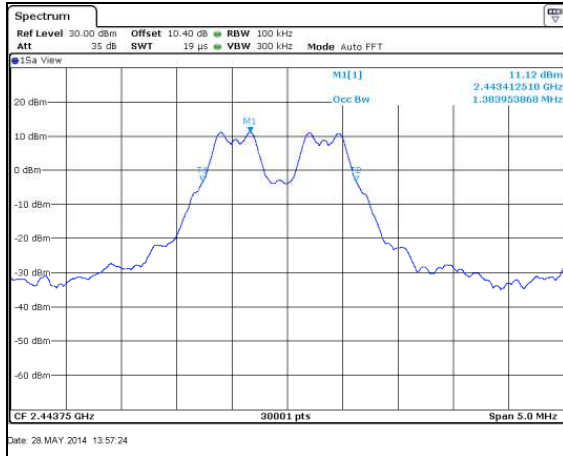

Figure 7.3.2-11: 99% Bandwidth Plot – MCH



Figure 7.3.2-12: 99% Bandwidth Plot – HCH

7.4 Fundamental Emission Output Power – FCC 15.247(b)(3), IC: RSS-210 A8.4(4)**7.4.1 Measurement Procedure**

The maximum peak conducted output power was measured in accordance with FCC KDB 558074 D01 DTS Meas Guidance v03r01 utilizing the PKPM1 Peak power meter method. The RF output of the equipment under test was directly connected to the input of the peak power meter applying suitable attenuation.

7.4.2 Measurement Results

Results are shown below in Tables 7.4.2-1 to 7.4.2-2.

Table 7.4.2-1: Maximum Peak Conducted Output Power – ANT0

Frequency (MHz)	Output Power (dBm)
2409.55	18.48
2443.75	18.52
2479.85	17.62

Table 7.4.2-2: Maximum Peak Conducted Output Power – ANT1

Frequency (MHz)	Output Power (dBm)
2409.55	18.49
2443.75	18.47
2479.85	17.30

7.5 Emission Levels – FCC 15.247(d), 15.205, 15.209; IC RSS-210 2.2/A8.5, RSS-Gen 7.2.2

7.5.1 Emissions into Non-restricted Frequency Bands

7.5.1.1 Measurement Procedure

The unwanted emissions into non-restricted bands were measured conducted in accordance with FCC KDB 558074 D01 DTS Meas Guidance v03r01. The RF output of the equipment under test was directly connected to the input of the spectrum analyzer applying suitable attenuation. The Resolution Bandwidth (RBW) of the spectrum analyzer was set to 100 kHz. The Video Bandwidth (VBW) was set to ≥ 300 kHz. Span was set to 1.5 times the DTS bandwidth. The trace was set to max hold with a peak detector active. The resulting spectrum analyzer peak level was used to determine the reference level with respect to the 20 dBc limit. The spectrum span was then adjusted for the measurement of spurious emissions from 30MHz to 25GHz, 10 times the highest fundamental frequency.

Band-edge compliance was determined using the conducted marker-delta method in which the radio frequency power that is produced by the EUT is at least 20 dB below that in the 100 kHz bandwidth within the band that contains the highest level of desired power.

7.5.1.2 Measurement Results

RF Conducted Emissions are displayed in Figures 7.5.1.2-1 through 7.5.1.2-22.

ANT0

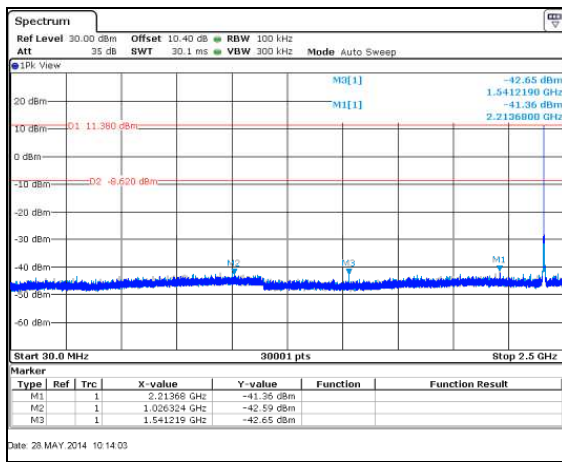

Figure 7.5.1.2-1: 30 MHz – 2.5 GHz – LCH

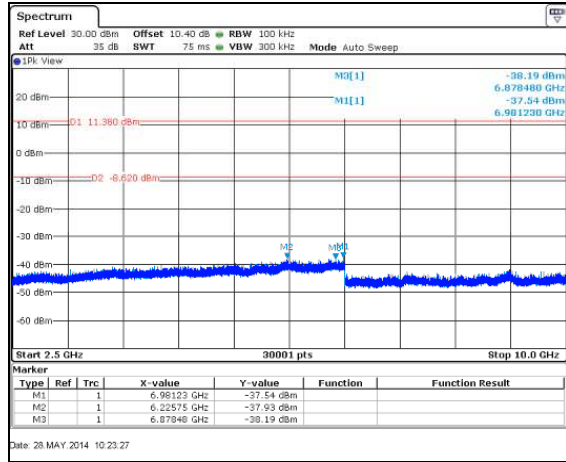

Figure 7.5.1.2-2: 2.5 GHz – 10 GHz – LCH

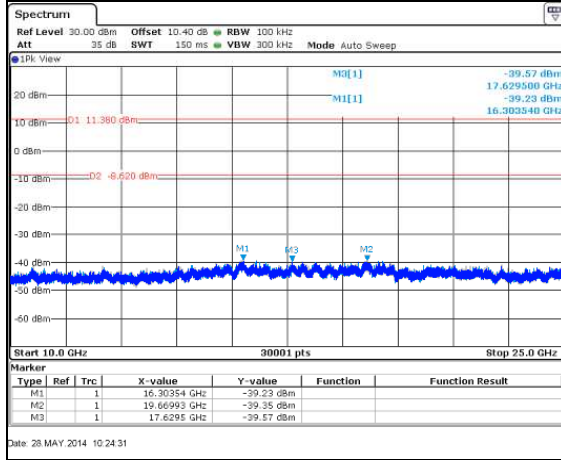

Figure 7.5.1.2-3: 10 GHz – 25 GHz – LCH

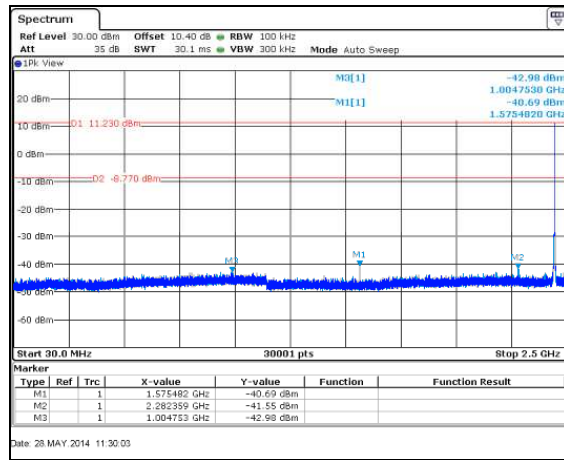

Figure 7.5.1.2-4: 30 MHz – 2.5 GHz – MCH

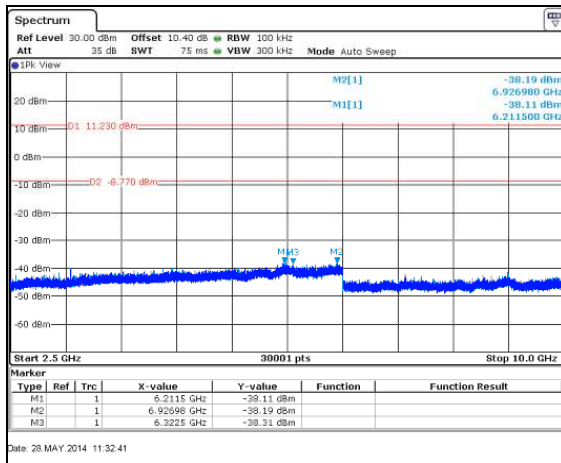

Figure 7.5.1.2-5: 2.5 GHz – 10 GHz – MCH

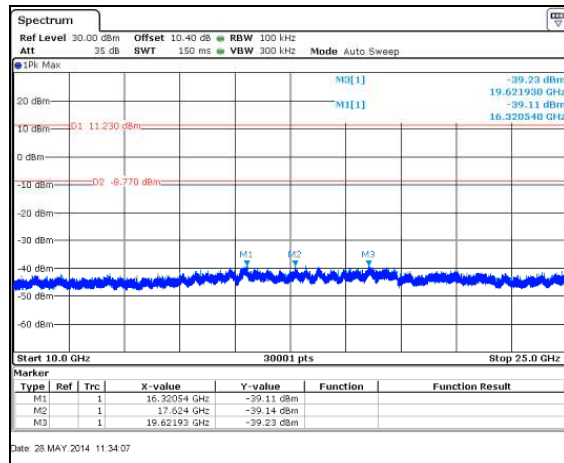

Figure 7.5.1.2-6: 10 GHz – 25 GHz – MCH

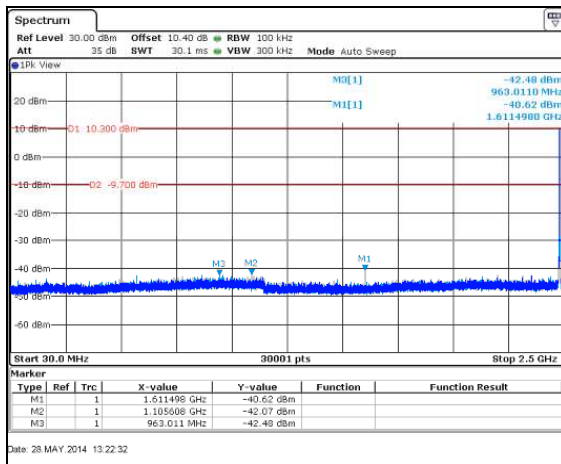

Figure 7.5.1.2-7: 30 MHz – 2.5 GHz – HCH

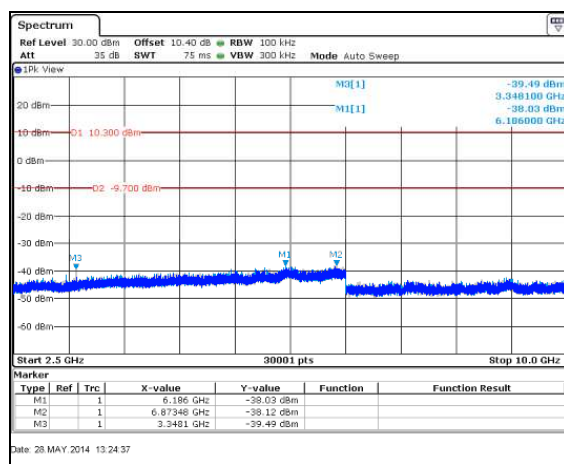

Figure 7.5.1.2-8: 2.5 GHz – 10 GHz – HCH

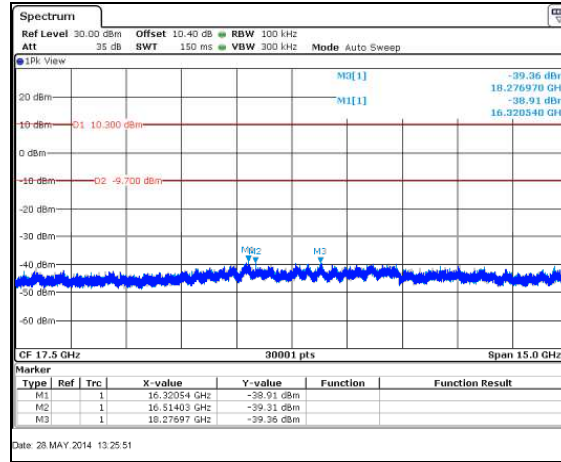

Figure 7.5.1.2-9: 10 GHz – 25 GHz – HCH

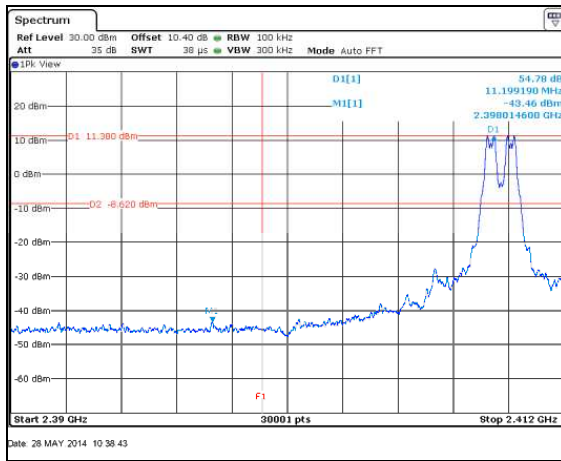

Figure 7.5.1.2-10: Lower Band-edge - LCH

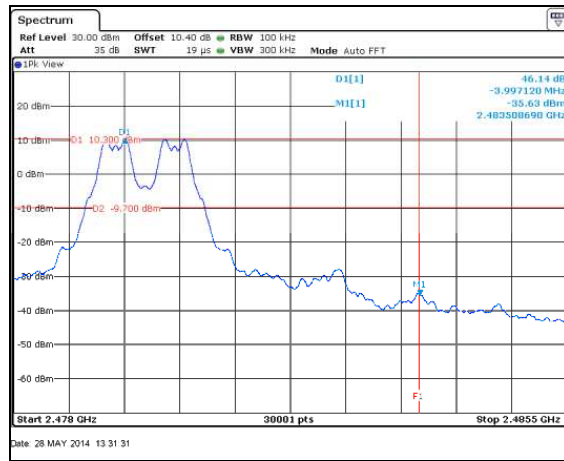

Figure 7.5.1.2-11: Upper Band-edge - HCH

ANT1

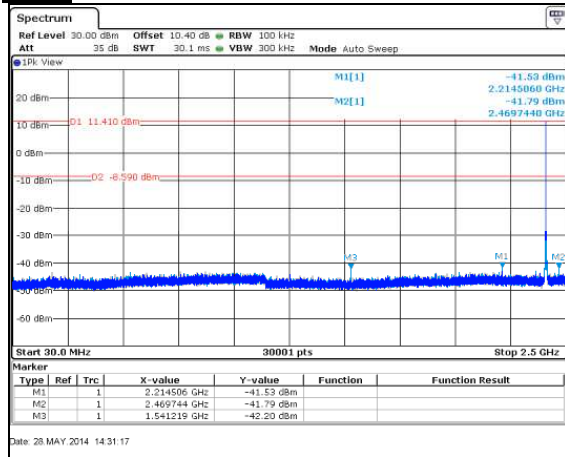

Figure 7.5.1.2-12: 30 MHz – 2.5 GHz – LCH

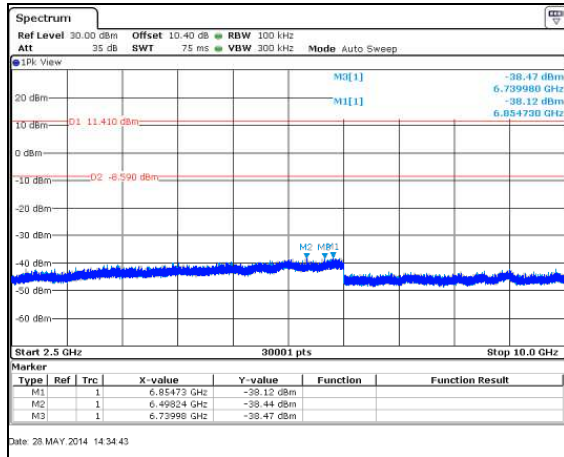

Figure 7.5.1.2-13: 2.5 GHz – 10 GHz – LCH

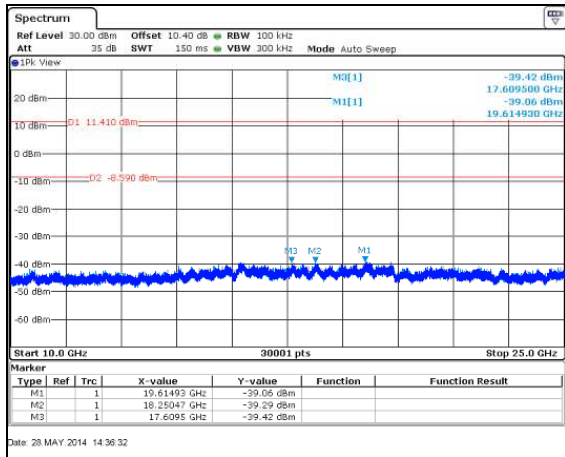

Figure 7.5.1.2-14: 10 GHz – 25 GHz – LCH

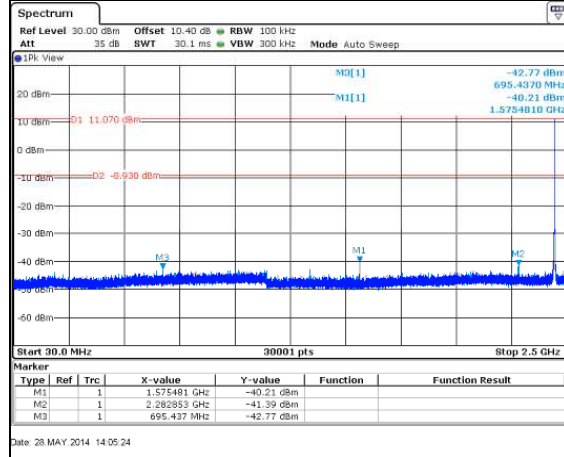

Figure 7.5.1.2-15: 30 MHz – 2.5 GHz – MCH

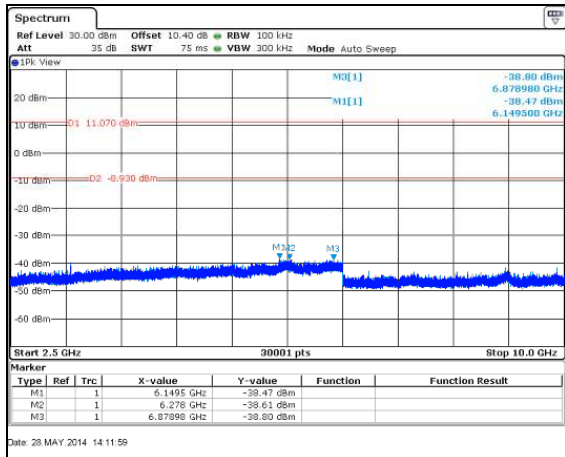

Figure 7.5.1.2-16: 2.5 GHz – 10 GHz – MCH

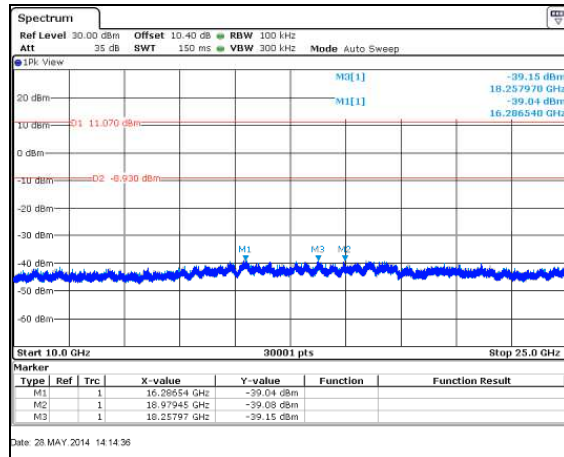

Figure 7.5.1.2-17: 10 GHz – 25 GHz – MCH

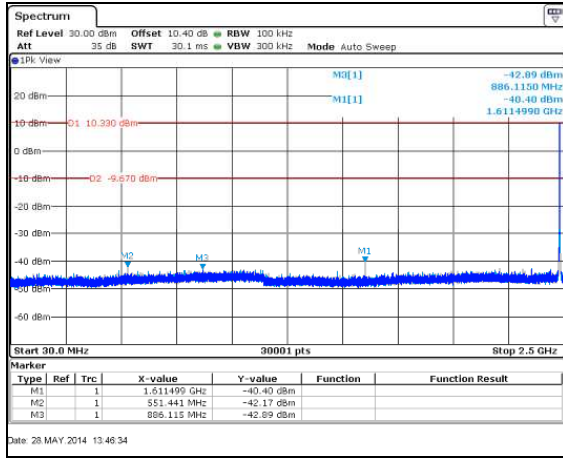

Figure 7.5.1.2-18: 30 MHz – 2.5 GHz – HCH

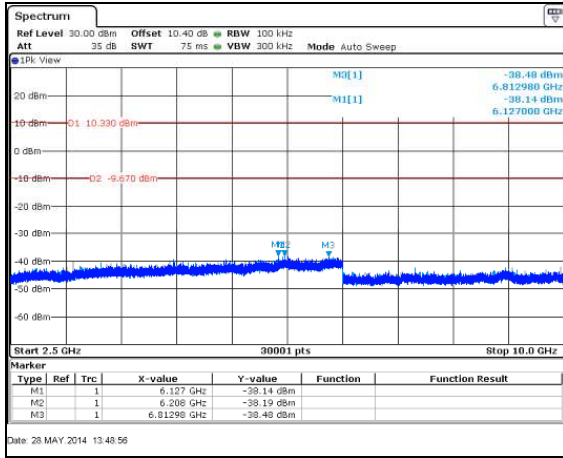

Figure 7.5.1.2-19: 2.5 GHz – 10 GHz – HCH

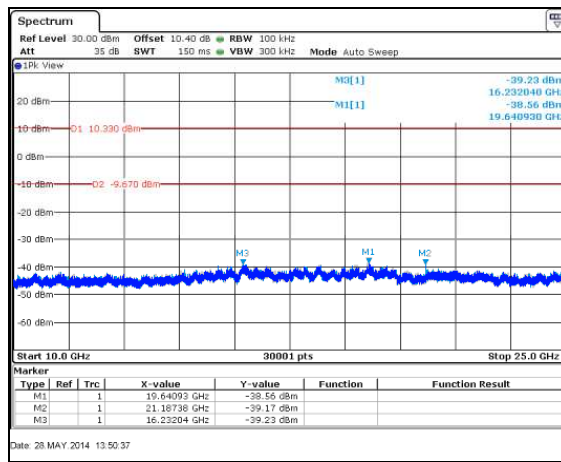

Figure 7.5.1.2-20: 10 GHz – 25 GHz – HCH

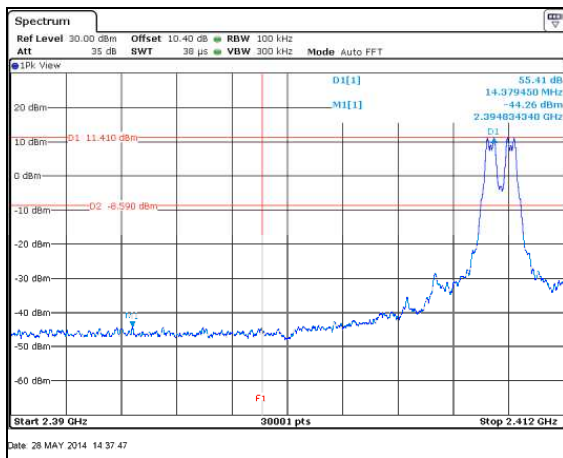

Figure 7.5.1.2-21: Lower Band-edge - LCH

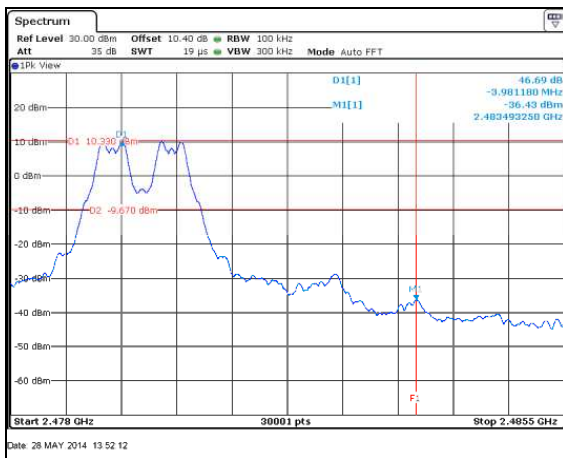

Figure 7.5.1.2-22: Upper Band-edge - HCH

7.5.2 Emissions into Restricted Frequency Bands

7.5.2.1 Measurement Procedure

The unwanted emissions into restricted bands were measured radiated over the frequency range of 30MHz to 25GHz, 10 times the highest fundamental frequency.

The EUT was rotated through 360° and the receive antenna height was varied from 1m to 4m so that the maximum radiated emissions level would be detected. For frequencies below 1000MHz, quasi-peak measurements were made using a resolution bandwidth RBW of 120 kHz and a video bandwidth VBW of 300 kHz. For frequencies above 1000MHz, peak and average measurements were made with RBW and VBW of 1 MHz and 3 MHz respectively. The average emissions were further corrected by applying the duty cycle correction of the EUT for comparison to the average limit.

Each emission found to be in a restricted band as defined by section 15.205, including any emission at the operational band-edge, was compared to the radiated emission limits as defined in section 15.209.

7.5.2.2 Duty Cycle Correction

For average radiated measurements, using a 5.083% duty cycle, the measured level was reduced by a factor -25.88dB. The duty cycle correction factor is determined using the formula: $20\log(5.083/100) = -25.88\text{dB}$.

A detailed analysis of the duty cycle timing is provided in the Theory of Operation accompanying the original application for certification.

7.5.2.3 Measurement Results

Radiated spurious emissions found in the band of 30MHz to 25GHz are reported in the tables 7.5.2.3-1 to 7.5.2.3-6 below.

Table 7.5.2.3-1: Radiated Spurious Emissions Tabulated Data – Dipole Antenna

Frequency (MHz)	Level (dBuV)		Antenna Polarity (H/V)	Correction Factors (dB)	Corrected Level (dBuV/m)		Limit (dBuV/m)		Margin (dB)	
	pk	Qpk/Avg			pk	Qpk/Avg	pk	Qpk/Avg	pk	Qpk/Avg
2409.55 MHz										
4819.1	51.53	44.02	H	1.50	53.03	19.64	74.0	54.0	21.0	34.4
4819.1	47.74	37.82	V	1.50	49.24	13.44	74.0	54.0	24.8	40.6
2390	49.87	38.08	V	-6.39	43.48	5.82	74.0	54.0	30.5	48.2
3755.34	49.11	37.70	H	-0.51	48.60	11.31	74.0	54.0	25.4	42.7
3755.34	51.15	42.67	V	-0.51	50.64	16.28	74.0	54.0	23.4	37.7
2214.13	54.19	52.48	H	-7.34	46.85	19.26	74.0	54.0	27.2	34.7
2214.13	62.43	57.35	V	-7.34	55.09	24.13	74.0	54.0	18.9	29.9
1063.3	51.44	41.48	H	-13.17	38.27	2.44	74.0	54.0	35.7	51.6
1063.3	55.09	47.4	V	-13.17	41.92	8.36	74.0	54.0	32.1	45.6
1345.88	56.21	49.96	H	-11.85	44.36	12.23	74.0	54.0	29.6	41.8
1345.88	59.76	54.63	V	-11.85	47.91	16.90	74.0	54.0	26.1	37.1
1541.15	52.36	45.87	H	-10.92	41.44	9.07	74.0	54.0	32.6	44.9
1541.15	56.33	53.11	V	-10.92	45.41	16.31	74.0	54.0	28.6	37.7
12329.8	52.57	47.09	H	16.35	68.92	37.56	83.5	63.5	14.6	26.0
12329.8	54.3	50.72	V	16.35	70.65	41.19	83.5	63.5	12.9	22.4
2443.75 MHz										
4887.5	51.13	44.48	H	1.62	52.75	20.22	74.0	54.0	21.3	33.8
4887.5	48.25	39.02	V	1.62	49.87	14.76	74.0	54.0	24.1	39.2
12603.35	49.20	42.83	H	18.10	67.30	35.05	83.5	63.5	16.2	28.5
12603.35	50.61	44.20	V	18.10	68.71	36.42	83.5	63.5	14.8	27.1
9452.2	56.64	54.20	H	8.94	65.58	37.26	74.0	54.0	8.4	16.7
9452.2	55.3	51.36	V	8.94	64.24	34.42	74.0	54.0	9.8	19.6
3857.94	49.41	38.43	H	-0.04	49.37	12.51	74.0	54.0	24.6	41.5
3857.94	51.51	42.39	V	-0.04	51.47	16.47	74.0	54.0	22.5	37.5
2282.51	54.08	47.12	H	-6.97	47.11	14.27	74.0	54.0	26.9	39.7
2282.51	64.97	60.04	V	-6.97	58.00	27.19	74.0	54.0	16.0	26.8
1414.2	55.66	48.69	H	-11.53	44.13	11.28	74.0	54.0	29.9	42.7
1414.2	60.07	55.02	V	-11.53	48.54	17.61	74.0	54.0	25.5	36.4
1575.38	54.1	50.37	H	-10.74	43.36	13.75	74.0	54.0	30.6	40.2
1575.38	59.1	56.79	V	-10.74	48.36	20.17	74.0	54.0	25.6	33.8
2479.85 MHz										
4959.7	53.29	46.76	H	1.74	55.03	22.62	74.0	54.0	19.0	31.4
4959.7	50.35	41.33	V	1.74	52.09	17.19	74.0	54.0	21.9	36.8
2483.5	62.73	51.46	H	-5.88	56.85	19.71	74.0	54.0	17.1	34.3
2483.5	75.91	64.74	V	-5.88	70.03	32.99	74.0	54.0	4.0	21.0
3348	49.24	39.93	H	-2.12	47.12	11.94	74.0	54.0	26.9	42.1
3348	56.19	50.45	V	-2.12	54.07	22.46	74.0	54.0	19.9	31.5
2354.7	52.13	43.82	H	-6.58	45.55	11.36	74.0	54.0	28.4	42.6
2354.7	63.07	58.12	V	-6.58	56.49	25.66	74.0	54.0	17.5	28.3
2230.6	55.63	47.83	V	-7.25	48.38	14.70	74.0	54.0	25.6	39.3
1611.44	52.54	45.42	H	-10.55	41.99	8.99	74.0	54.0	32.0	45.0
1611.44	58.04	55.25	V	-10.55	47.49	18.82	74.0	54.0	26.5	35.2
1486.47	56.21	49.71	H	-11.20	45.01	12.63	74.0	54.0	29.0	41.4
1486.47	62.64	57.94	V	-11.20	51.44	20.86	74.0	54.0	22.6	33.1

Table 7.5.2.3-2: Radiated Spurious Emissions Tabulated Data – Corner Reflector Antenna

Frequency (MHz)	Level (dBuV)		Antenna Polarity (H/V)	Correction Factors (dB)	Corrected Level (dBuV/m)		Limit (dBuV/m)		Margin (dB)	
	pk	Qpk/Avg			pk	Qpk/Avg	pk	Qpk/Avg	pk	Qpk/Avg
2409.55 MHz										
4819.1	50.12	41.61	H	1.50	51.62	17.23	74.0	54.0	22.4	36.8
2390	50.91	38.51	V	-6.39	44.52	6.25	74.0	54.0	29.5	47.8
2214.13	62.61	57.51	V	-7.34	55.27	24.29	74.0	54.0	18.7	29.7
1541.13	51.37	44.17	H	-10.92	40.45	7.37	74.0	54.0	33.5	46.6
1541.13	56.23	52.99	V	-10.92	45.31	16.19	74.0	54.0	28.7	37.8
3755.34	54.48	47.28	V	-0.51	53.97	20.89	74.0	54.0	20.0	33.1
12329.8	51.22	44.56	H	16.35	67.57	35.03	83.5	63.5	15.9	28.5
12329.8	54.2	50.83	V	16.35	70.55	41.30	83.5	63.5	13.0	22.2
2443.75 MHz										
4887.5	52.83	46.13	H	1.62	54.45	21.87	74.0	54.0	19.6	32.1
4887.5	50.85	43.16	V	1.62	52.47	18.90	74.0	54.0	21.5	35.1
12603.35	49.54	42.37	H	18.10	67.64	34.59	83.5	63.5	15.9	29.0
12603.35	50.22	44.68	V	18.10	68.32	36.90	83.5	63.5	15.2	26.6
9452.52	57.40	55.02	H	8.94	66.34	38.08	74.0	54.0	7.7	15.9
9452.52	52.15	47.86	V	8.94	61.09	30.92	74.0	54.0	12.9	23.1
4019.07	53.11	45.75	V	0.62	53.73	20.49	74.0	54.0	20.3	33.5
3857.94	55.32	48.36	V	-0.04	55.28	22.44	74.0	54.0	18.7	31.6
2282.51	65.04	60.07	V	-6.97	58.07	27.22	74.0	54.0	15.9	26.8
1575.38	52.31	45.93	H	-10.74	41.57	9.31	74.0	54.0	32.4	44.7
1575.38	57.18	54.31	V	-10.74	46.44	17.69	74.0	54.0	27.6	36.3
2479.85 MHz										
4959.7	53.06	46.26	H	1.74	54.80	22.12	74.0	54.0	19.2	31.9
4959.7	49.19	39.60	V	1.74	50.93	15.46	74.0	54.0	23.1	38.5
2483.5	58.41	47.20	H	-5.88	52.53	15.45	74.0	54.0	21.5	38.6
2483.5	78.18	66.57	V	-5.88	72.30	34.82	74.0	54.0	1.7	19.2
3348	51.12	42.83	H	-2.12	49.00	14.84	74.0	54.0	25.0	39.2
3348	64.31	60.55	V	-2.12	62.19	32.56	74.0	54.0	11.8	21.4
3966.23	52.05	43.01	V	0.45	52.50	17.58	74.0	54.0	21.5	36.4
4091.26	51.71	43.03	V	0.67	52.38	17.82	74.0	54.0	21.6	36.2
2354.7	64.84	60.04	V	-6.58	58.26	27.58	74.0	54.0	15.7	26.4
1486.47	54.56	47.7	V	-11.20	43.36	10.62	74.0	54.0	30.6	43.4
1611.44	51.8	44.86	H	-10.55	41.25	8.43	74.0	54.0	32.8	45.6
1611.44	57.33	54.54	V	-10.55	46.78	18.11	74.0	54.0	27.2	35.9

Table 7.5.2.3-3: Radiated Spurious Emissions Tabulated Data – Patch Antenna

Frequency (MHz)	Level (dBuV)		Antenna Polarity (H/V)	Correction Factors (dB)	Corrected Level (dBuV/m)		Limit (dBuV/m)		Margin (dB)	
	pk	Qpk/Avg			pk	Qpk/Avg	pk	Qpk/Avg	pk	Qpk/Avg
2409.55 MHz										
4819.1	51.74	44.61	H	1.50	53.24	20.23	74.0	54.0	20.8	33.8
4819.1	48.06	38.05	V	1.50	49.56	13.67	74.0	54.0	24.4	40.3
2390	50.84	38.38	V	-6.39	44.45	6.12	74.0	54.0	29.5	47.9
12329.8	51.32	45.22	H	16.35	67.67	35.69	83.5	63.5	15.8	27.9
12329.8	55.64	52.63	V	16.35	71.99	43.10	83.5	63.5	11.5	20.4
1345.88	52.01	43.53	H	-11.85	40.16	5.80	74.0	54.0	33.8	48.2
1345.88	54.2	47.88	V	-11.85	42.35	10.15	74.0	54.0	31.7	43.8
2214.13	50.41	40.52	H	-7.34	43.07	7.30	74.0	54.0	30.9	46.7
2214.13	63.12	58.17	V	-7.34	55.78	24.95	74.0	54.0	18.2	29.1
3755.34	55.88	48.82	H	-0.51	55.37	22.43	74.0	54.0	18.6	31.6
3755.34	53.11	45.37	V	-0.51	52.60	18.98	74.0	54.0	21.4	35.0
2443.75 MHz										
4887.5	52.02	45.49	H	1.62	53.64	21.23	74.0	54.0	20.4	32.8
4887.5	47.36	37.90	V	1.62	48.98	13.64	74.0	54.0	25.0	40.4
9452.2	56.79	54.31	H	8.94	65.73	37.37	74.0	54.0	8.3	16.6
9452.2	54.60	51.00	V	8.94	63.54	34.06	74.0	54.0	10.5	19.9
4019.07	52.96	44.38	H	0.62	53.58	19.12	74.0	54.0	20.4	34.9
4019.07	50.28	40.03	V	0.62	50.90	14.77	74.0	54.0	23.1	39.2
3857.94	57.56	50.04	H	-0.04	57.52	24.12	74.0	54.0	16.5	29.9
3857.94	53.21	45.47	V	-0.04	53.17	19.55	74.0	54.0	20.8	34.5
2282.51	61.19	55.96	V	-6.97	54.22	23.11	74.0	54.0	19.8	30.9
1575.38	50.56	41.96	V	-10.74	39.82	5.34	74.0	54.0	34.2	48.7
12603.35	50.32	44.02	H	18.10	68.42	36.24	83.5	63.5	15.1	27.3
12603.35	50.57	45.65	V	18.10	68.67	37.87	83.5	63.5	14.8	25.7
2479.85 MHz										
4959.7	53.75	47.30	H	1.74	55.49	23.16	74.0	54.0	18.5	30.8
4959.7	50.19	41.51	V	1.74	51.93	17.37	74.0	54.0	22.1	36.6
2483.5	58.28	47.39	H	-5.88	52.40	15.64	74.0	54.0	21.6	38.4
2483.5	78.18	66.79	V	-5.88	72.30	35.04	74.0	54.0	1.7	19.0
1486.47	52.66	44.78	V	-11.20	41.46	7.70	74.0	54.0	32.5	46.3
1611.44	52.11	45.27	H	-10.55	41.56	8.84	74.0	54.0	32.4	45.2
1611.44	52.71	47.42	V	-10.55	42.16	10.99	74.0	54.0	31.8	43.0
2354.7	51.39	43.06	H	-6.58	44.81	10.60	74.0	54.0	29.2	43.4
2354.7	64.59	59.64	V	-6.58	58.01	27.18	74.0	54.0	16.0	26.8
3348	50.81	42.52	H	-2.12	48.69	14.53	74.0	54.0	25.3	39.5
3348	61.39	57.28	V	-2.12	59.27	29.29	74.0	54.0	14.7	24.7
3966.23	55.67	48.34	H	0.45	56.12	22.91	74.0	54.0	17.9	31.1
3966.23	51.16	42.24	V	0.45	51.61	16.81	74.0	54.0	22.4	37.2

Table 7.5.2.3-4: Radiated Spurious Emissions Tabulated Data – Yagi Antenna

Frequency (MHz)	Level (dBuV)		Antenna Polarity (H/V)	Correction Factors (dB)	Corrected Level (dBuV/m)		Limit (dBuV/m)		Margin (dB)	
	pk	Qpk/Avg			pk	Qpk/Avg	pk	Qpk/Avg	pk	Qpk/Avg
2409.55 MHz										
4819.1	51.24	43.89	H	1.50	52.74	19.51	74.0	54.0	21.3	34.5
12329.8	52.56	47.02	H	16.35	68.91	37.49	83.5	63.5	14.6	26.1
12329.8	56.21	53.42	V	16.35	72.56	43.89	83.5	63.5	10.9	19.7
2214.13	49.71	39.37	H	-7.34	42.37	6.15	74.0	54.0	31.6	47.9
2214.13	65.43	59.76	V	-7.34	58.09	26.54	74.0	54.0	15.9	27.5
1345.88	54.89	47.73	H	-11.85	43.04	10.00	74.0	54.0	31.0	44.0
1345.88	52.76	45.39	V	-11.85	40.91	7.66	74.0	54.0	33.1	46.3
1541.15	53.08	47.7	H	-10.92	42.16	10.90	74.0	54.0	31.8	43.1
1541.15	58.78	55.6	V	-10.92	47.86	18.80	74.0	54.0	26.1	35.2
2443.75 MHz										
4887.5	52.41	45.37	H	1.62	54.03	21.11	74.0	54.0	20.0	32.9
2282.51	51.22	41.13	H	-6.97	44.25	8.28	74.0	54.0	29.8	45.7
2282.51	66.77	60.96	V	-6.97	59.80	28.11	74.0	54.0	14.2	25.9
1414.2	58.17	52.68	H	-11.53	46.64	15.27	74.0	54.0	27.4	38.7
1414.2	59.86	54.46	V	-11.53	48.33	17.05	74.0	54.0	25.7	37.0
1575.38	56.21	52.68	H	-10.74	45.47	16.06	74.0	54.0	28.5	37.9
1575.38	58.34	55.42	V	-10.74	47.60	18.80	74.0	54.0	26.4	35.2
9452.2	57.33	54.89	H	8.94	66.27	37.95	74.0	54.0	7.7	16.0
9452.2	55.29	52.17	V	8.94	64.23	35.23	74.0	54.0	9.8	18.8
12603.35	50.39	44.38	H	18.10	68.49	36.60	83.5	63.5	15.0	26.9
12603.35	50.64	45.65	V	18.10	68.74	37.87	83.5	63.5	14.8	25.7
2479.85 MHz										
4959.7	53.96	47.40	H	1.74	55.70	23.26	74.0	54.0	18.3	30.7
2483.5	55.86	44.27	H	-5.88	49.98	12.52	74.0	54.0	24.0	41.5
2483.5	78.17	66.49	V	-5.88	72.29	34.74	74.0	54.0	1.7	19.3
1486.47	54.38	47.96	H	-11.20	43.18	10.88	74.0	54.0	30.8	43.1
1486.47	60.07	54.79	V	-11.20	48.87	17.71	74.0	54.0	25.1	36.3
1611.44	56.56	53.54	H	-10.55	46.01	17.11	74.0	54.0	28.0	36.9
1611.44	62.79	61.34	V	-10.55	52.24	24.91	74.0	54.0	21.8	29.1
2354.7	62.53	56.51	V	-6.58	55.95	24.05	74.0	54.0	18.0	29.9

Table 7.5.2.3-5: Radiated Spurious Emissions Tabulated Data – PIFA Antenna

Frequency (MHz)	Level (dBuV)		Antenna Polarity (H/V)	Correction Factors (dB)	Corrected Level (dBuV/m)		Limit (dBuV/m)		Margin (dB)	
	pk	Qpk/Avg			pk	Qpk/Avg	pk	Qpk/Avg	pk	Qpk/Avg
2409.55 MHz										
4819.1	51.74	44.75	H	1.50	53.24	20.37	74.0	54.0	20.8	33.6
4819.1	48.52	39.37	V	1.50	50.02	14.99	74.0	54.0	24.0	39.0
2390	47.37	35.99	V	-6.39	40.98	3.73	74.0	54.0	33.0	50.3
12329.8	50.74	44.83	H	16.35	67.09	35.30	83.5	63.5	16.4	28.2
12329.8	53.86	50.08	V	16.35	70.21	40.55	83.5	63.5	13.3	23.0
3755.34	51.49	41.40	H	-0.51	50.98	15.01	74.0	54.0	23.0	39.0
3755.34	51.13	42.57	V	-0.51	50.62	16.18	74.0	54.0	23.4	37.8
2214.13	53.64	46.03	H	-7.34	46.30	12.81	74.0	54.0	27.7	41.2
2214.13	59.3	53.03	V	-7.34	51.96	19.81	74.0	54.0	22.0	34.2
1345.88	51.02	42.49	V	-11.85	39.17	4.76	74.0	54.0	34.8	49.2
1541.12	52.45	46.63	H	-10.92	41.53	9.83	74.0	54.0	32.5	44.2
1541.12	56.56	53.79	V	-10.92	45.64	16.99	74.0	54.0	28.4	37.0
2443.75 MHz										
4887.5	51.66	45.01	H	1.62	53.28	20.75	74.0	54.0	20.7	33.3
4887.5	49.93	42.52	V	1.62	51.55	18.26	74.0	54.0	22.5	35.7
1575.38	58.02	54.48	H	-10.74	47.28	17.86	74.0	54.0	26.7	36.1
1575.38	62.78	61.28	V	-10.74	52.04	24.66	74.0	54.0	22.0	29.3
2282.51	58.31	51.76	H	-6.97	51.34	18.91	74.0	54.0	22.7	35.1
2282.51	63.21	57.3	V	-6.97	56.24	24.45	74.0	54.0	17.8	29.5
3857.94	50.82	41.32	H	-0.04	50.78	15.40	74.0	54.0	23.2	38.6
3857.94	52.61	42.75	V	-0.04	52.57	16.83	74.0	54.0	21.4	37.2
9452.2	57.61	54.43	H	8.94	66.55	37.49	74.0	54.0	7.4	16.5
9452.2	51.46	46.38	V	8.94	60.40	29.44	74.0	54.0	13.6	24.6
12603.35	48.51	41.83	H	18.10	66.61	34.05	83.5	63.5	16.9	29.5
12603.35	50.44	45.18	V	18.10	68.54	37.40	83.5	63.5	15.0	26.1
2479.85 MHz										
4959.7	52.15	45.29	H	1.74	53.89	21.15	74.0	54.0	20.1	32.8
4959.7	49.26	39.89	V	1.74	51.00	15.75	74.0	54.0	23.0	38.2
2483.5	68.26	56.41	H	-5.88	62.38	24.66	74.0	54.0	11.6	29.3
2483.5	71.22	59.58	V	-5.88	65.34	27.83	74.0	54.0	8.7	26.2
2229.69	53.58	44.48	V	-7.26	46.32	11.34	74.0	54.0	27.7	42.7
2354.7	56.41	49.66	H	-6.58	49.83	17.20	74.0	54.0	24.2	36.8
2354.7	61.11	54.89	V	-6.58	54.53	22.43	74.0	54.0	19.5	31.6
1486.47	54.36	48.06	V	-11.20	43.16	10.98	74.0	54.0	30.8	43.0
1611.44	56.76	53.26	H	-10.55	46.21	16.83	74.0	54.0	27.8	37.2
1611.44	61.24	59.43	V	-10.55	50.69	23.00	74.0	54.0	23.3	31.0
3348.8	52.36	44.71	H	-2.11	50.25	16.72	74.0	54.0	23.8	37.3
3348.8	50.77	42.9	V	-2.11	48.66	14.91	74.0	54.0	25.3	39.1

Table 7.5.2.3-6: Radiated Spurious Emissions Tabulated Data – CP Beam Antenna

Frequency (MHz)	Level (dBuV)		Antenna Polarity (H/V)	Correction Factors (dB)	Corrected Level (dBuV/m)		Limit (dBuV/m)		Margin (dB)	
	pk	Qpk/Avg			pk	Qpk/Avg	pk	Qpk/Avg	pk	Qpk/Avg
2409.55 MHz										
4819.1	53.36	47.04	H	1.50	54.86	22.66	74.0	54.0	19.1	31.3
4819.1	48.40	39.22	V	1.50	49.90	14.84	74.0	54.0	24.1	39.2
2390	47.45	36.15	H	-6.39	41.06	3.89	74.0	54.0	32.9	50.1
2390	50.78	38.38	V	-6.39	44.39	6.12	74.0	54.0	29.6	47.9
12329.8	51.18	45.80	H	16.35	67.53	36.27	83.5	63.5	16.0	27.3
12329.8	55.13	51.64	V	16.35	71.48	42.11	83.5	63.5	12.0	21.4
2214.13	64.84	59.05	H	-7.34	57.50	25.83	74.0	54.0	16.5	28.2
2214.13	64.54	58.67	V	-7.34	57.20	25.45	74.0	54.0	16.8	28.6
1345.88	56.39	50.32	H	-11.85	44.54	12.59	74.0	54.0	29.5	41.4
1345.88	61.44	56.44	V	-11.85	49.59	18.71	74.0	54.0	24.4	35.3
1541.15	64.05	62.81	H	-10.92	53.13	26.01	74.0	54.0	20.9	28.0
1541.15	56.84	53.9	V	-10.92	45.92	17.10	74.0	54.0	28.1	36.9
3755.34	57.15	50.27	H	-0.51	56.64	23.88	74.0	54.0	17.4	30.1
3755.34	56.74	49.58	V	-0.51	56.23	23.19	74.0	54.0	17.8	30.8
2443.75 MHz										
4887.5	55.17	49.48	H	1.62	56.79	25.22	74.0	54.0	17.2	28.8
4887.5	53.34	46.53	V	1.62	54.96	22.27	74.0	54.0	19.0	31.7
3857.94	58.42	51.49	H	-0.04	58.38	25.57	74.0	54.0	15.6	28.4
3857.94	58.24	51.49	V	-0.04	58.20	25.57	74.0	54.0	15.8	28.4
4019.06	53.72	45.85	H	0.62	54.34	20.59	74.0	54.0	19.7	33.4
4019.06	53.22	44.73	V	0.62	53.84	19.47	74.0	54.0	20.2	34.5
9452.2	56.76	54.05	H	8.94	65.70	37.11	74.0	54.0	8.3	16.9
9452.2	54.08	50.52	V	8.94	63.02	33.58	74.0	54.0	11.0	20.4
2282.51	63.29	57.38	H	-6.97	56.32	24.53	74.0	54.0	17.7	29.5
2282.51	64.16	58.24	V	-6.97	57.19	25.39	74.0	54.0	16.8	28.6
1414.2	65.15	60.68	H	-11.53	53.62	23.27	74.0	54.0	20.4	30.7
1414.2	57.05	51.31	V	-11.53	45.52	13.90	74.0	54.0	28.5	40.1
1575.38	65.35	64.28	H	-10.74	54.61	27.66	74.0	54.0	19.4	26.3
1575.38	60.78	58.93	V	-10.74	50.04	22.31	74.0	54.0	24.0	31.7
12603.35	51.93	46.74	H	18.10	70.03	38.96	83.5	63.5	13.5	24.6
12603.35	50.42	45.11	V	18.10	68.52	37.33	83.5	63.5	15.0	26.2
2479.85 MHz										
4959.7	54.18	48.51	H	1.74	55.92	24.37	74.0	54.0	18.1	29.6
4959.7	50.37	42.39	V	1.74	52.11	18.25	74.0	54.0	21.9	35.7
2483.5	68.32	57.30	H	-5.88	62.44	25.55	74.0	54.0	11.6	28.5
2483.5	73.81	62.02	V	-5.88	67.93	30.27	74.0	54.0	6.1	23.7
3966.24	55.12	47.88	H	0.45	55.57	22.45	74.0	54.0	18.4	31.5
3966.24	54.13	46.64	V	0.45	54.58	21.21	74.0	54.0	19.4	32.8
3348	63.95	60.20	H	-2.12	61.83	32.21	74.0	54.0	12.2	21.8
3348	60.38	56.34	V	-2.12	58.26	28.35	74.0	54.0	15.7	25.7
2354.7	58.57	52.86	H	-6.58	51.99	20.40	74.0	54.0	22.0	33.6
2354.7	61.59	56.16	V	-6.58	55.01	23.70	74.0	54.0	19.0	30.3
2229.69	56.03	48.39	H	-7.26	48.77	15.25	74.0	54.0	25.2	38.7
2229.69	56.2	48.21	V	-7.26	48.94	15.07	74.0	54.0	25.1	38.9
1611.44	66.19	65.15	H	-10.55	55.64	28.72	74.0	54.0	18.4	25.3
1611.44	64.94	63.98	V	-10.55	54.39	27.55	74.0	54.0	19.6	26.4
1486.47	60.37	55.22	H	-11.20	49.17	18.14	74.0	54.0	24.8	35.9
1486.47	65.45	61.03	V	-11.20	54.25	23.95	74.0	54.0	19.7	30.0

7.5.2.4 Sample Calculation:

$$R_C = R_U + CF_T$$

Where:

CF_T	=	Total Correction Factor (AF+CA+AG)-DC (Average Measurements Only)
R_U	=	Uncorrected Reading
R_C	=	Corrected Level
AF	=	Antenna Factor
CA	=	Cable Attenuation
AG	=	Amplifier Gain
DC	=	Duty Cycle Correction Factor

Example Calculation: PeakCorrected Level: $51.53 + 1.50 = 53.03\text{dBuV/m}$ Margin: $74\text{dBuV/m} - 53.03\text{dBuV/m} = 21.0\text{dB}$ **Example Calculation: Average**Corrected Level: $44.02 + 1.50 - 25.88 = 19.64\text{dBuV}$ Margin: $54\text{dBuV} - 19.64\text{dBuV} = 34.4\text{dB}$

7.6 Maximum Power Spectral Density in the Fundamental Emission – FCC 15.247(e) IC: RSS-210 A8.2(b)

7.6.1 Measurement Procedure

The power spectral density was measured in accordance with the FCC KDB 558074 D01 DTS Meas Guidance v03r01 utilizing the PKPSD (peak PSD) method. The RF output of the equipment under test was directly connected to the input of the spectrum analyzer applying suitable attenuation. The Resolution Bandwidth (RBW) of the spectrum analyzer was set to 3 kHz. The Video Bandwidth (VBW) was set to 10 kHz. Span was set to 1.5 times the DTS bandwidth. The trace was set to max hold with a peak detector active.

7.6.2 Measurement Results

Results are shown below in tables 7.6.2-1 to 7.6.2-2 and figures 7.6.2-1 to 7.6.2-6.

Table 7.6.2-1: Peak Power Spectral Density – ANT0

Frequency (MHz)	PSD Level (dBm)
2409.55	2.71
2443.75	2.78
2479.85	2.55

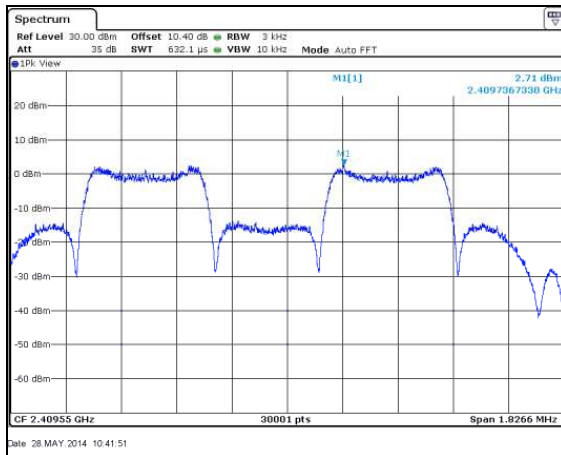

Figure 7.6.2-1: PSD Plot – LCH

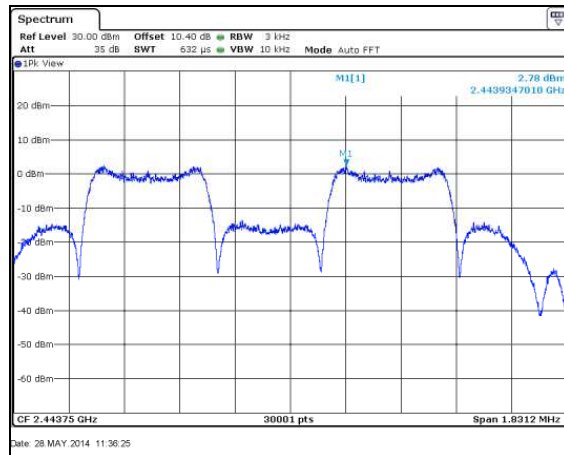

Figure 7.6.2-2: PSD Plot – MCH

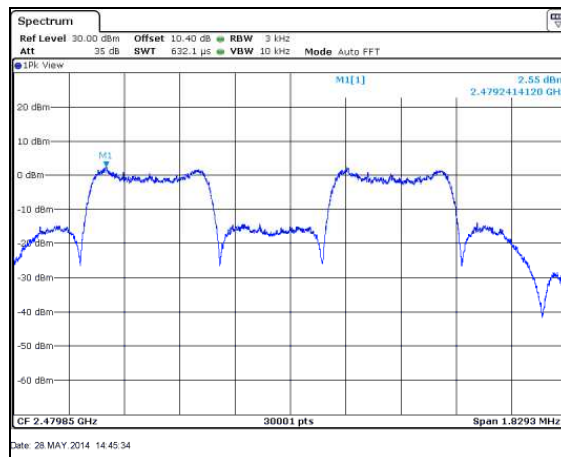

Figure 7.6.2-3: PSD Plot – HCH

Table 7.6.2-2: Peak Power Spectral Density – ANT1

Frequency (MHz)	PSD Level (dBm)
2409.55	2.81
2443.75	2.74
2479.85	2.71

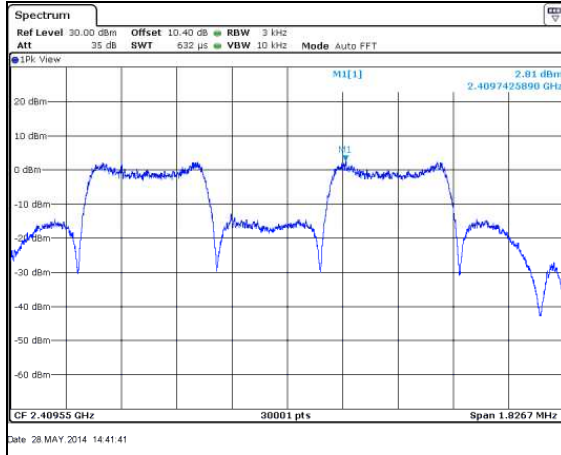

Figure 7.6.2-4: PSD Plot – LCH

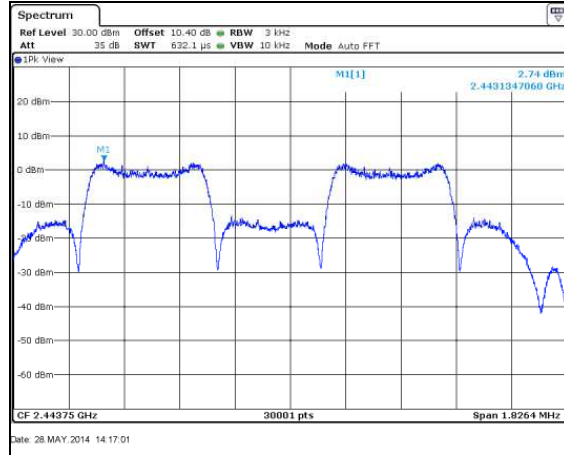

Figure 7.6.2-5: PSD Plot – MCH

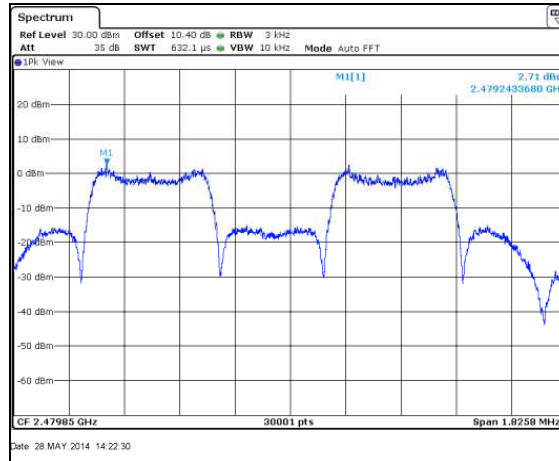

Figure 7.6.2-6: PSD Plot – HCH

8 CONCLUSION

In the opinion of ACS, Inc. the CCT24, manufactured by RF Monolithics meets the requirements of FCC Part 15 subpart C and Industry Canada's Radio Standards Specification RSS-210.

END REPORT