



<b>Prüfbericht-Nr.:</b> <i>Test report no.:</i>	CN22ZR4D (P15C-WiFi) 002	<b>Auftrags-Nr.:</b> <i>Order no.:</i>	48217198	Seite 1 von 29 Page 1 of 29
<b>Kunden-Referenz-Nr.:</b> <i>Client reference no.:</i>	N/A	<b>Auftragsdatum:</b> <i>Order date:</i>	2023-03-22	
<b>Auftraggeber:</b> <i>Client:</i>	Ademco Inc 1985 Douglas Drive N, Golden Valley, USA			
<b>Prüfgegenstand:</b> <i>Test item:</i>	L2 WiFi Water Sensor and Switch			
<b>Bezeichnung / Typ-Nr.:</b> <i>Identification / Type no.:</i>	TWLD3005-001			
<b>Auftrags-Inhalt:</b> <i>Order content:</i>	FCC Part 15C Test report (WiFi 2.4GHz)			
<b>Prüfgrundlage:</b> <i>Test specification:</i>	FCC 47CFR Part 15: Subpart C Section 15.247			
<b>Wareneingangsdatum:</b> <i>Date of sample receipt:</i>	2023-02-23			
<b>Prüfmuster-Nr.:</b> <i>Test sample no.:</i>	A003420561-018 A003420561-014			
<b>Prüfzeitraum:</b> <i>Testing period:</i>	2023-03-31 - 2023-04-12			
<b>Ort der Prüfung:</b> <i>Place of testing:</i>	EMC/RF Taipei Testing Site			
<b>Prüflaboratorium:</b> <i>Testing laboratory:</i>	Taipei Testing Laboratories			
<b>Prüfergebnis*:</b> <i>Test result*:</i>	Pass			
<b>überprüft von:</b> <i>compiled by:</i>	 Ryan Chen	<b>genehmigt von:</b> <i>authorized by:</i>	 Brenda Chen	
<b>Datum:</b> <i>Date:</i>	2023-04-27	<b>Ausstellungsdatum:</b> <i>Issue date:</i>	2023-04-27	
<b>Stellung / Position:</b>	Senior Project Manager	<b>Stellung / Position:</b>	Senior Project Manager	
<b>Sonstiges / Other:</b>	This report is to change the design of antenna.			
<b>Zustand des Prüfgegenstandes bei Anlieferung:</b> <i>Condition of the test item at delivery:</i>	Prüfmuster vollständig und unbeschädigt <i>Test item complete and undamaged</i>			
* Legende:	1 = sehr gut P(ass) = entspricht o.g. Prüfgrundlage(n)	2 = gut F(ail) = entspricht nicht o.g. Prüfgrundlage(n)	3 = befriedigend N/A = nicht anwendbar	4 = ausreichend N/T = nicht getestet
* Legend:	1 = very good P(ass) = passed a.m. test specification(s)	2 = good F(ail) = failed a.m. test specification(s)	3 = satisfactory N/A = not applicable	4 = sufficient N/T = not tested
<b>Dieser Prüfbericht bezieht sich nur auf das o.g. Prüfmuster und darf ohne Genehmigung der Prüfstelle nicht auszugsweise vervielfältigt werden. Dieser Bericht berechtigt nicht zur Verwendung eines Prüfzeichens.</b> <i>This test report only relates to the a. m. test sample. Without permission of the test center this test report is not permitted to be duplicated in extracts. This test report does not entitle to carry any test mark.</i>				

V05

## TEST SUMMARY

Report Section	FCC Clause	Test Item	Result
5.1.1	15.247(b) & 15.203	Antenna Requirement	Pass
5.1.2	15.247(b)(3)	Peak Output Power	Pass
5.1.3	15.247(a)(2)	6 dB Bandwidth	Pass
5.1.3	2.1049	99% Occupied Bandwidth	Pass
5.1.4	15.247(e)	Power Spectral Density	Pass
5.1.5	15.247(d)	Conducted Spurious Emissions and Band Edges	Pass
5.1.6	15.247(d) & 15.205 & 15.209	Radiated Spurious Emissions and Band Edges	Pass
5.2.1	15.207	Mains Conducted Emission	Pass

**Note:** Determining compliance based on the results of the compliance measurement, not taking into account measurement instrumentation uncertainty.

## Contents

<b>HISTORY OF THIS TEST REPORT .....</b>	<b>5</b>
<b>1. GENERAL REMARKS .....</b>	<b>6</b>
<b>1.1 COMPLEMENTARY MATERIALS.....</b>	<b>6</b>
<b>1.2 DECISION RULE OF CONFORMITY .....</b>	<b>6</b>
<b>2. TEST SITES .....</b>	<b>7</b>
<b>2.1 TEST LABORATORY .....</b>	<b>7</b>
<b>2.2 TEST FACILITY.....</b>	<b>7</b>
<b>2.3 TRACEABILITY .....</b>	<b>8</b>
<b>2.4 CALIBRATION .....</b>	<b>8</b>
<b>2.5 MEASUREMENT UNCERTAINTY .....</b>	<b>8</b>
<b>3. GENERAL PRODUCT INFORMATION.....</b>	<b>9</b>
<b>3.1 PRODUCT FUNCTION AND INTENDED USE .....</b>	<b>9</b>
<b>3.2 SYSTEM DETAILS AND RATINGS.....</b>	<b>9</b>
<b>3.3 NOISE GENERATING AND NOISE SUPPRESSING PARTS .....</b>	<b>10</b>
<b>3.4 SUBMITTED DOCUMENTS.....</b>	<b>10</b>
<b>4. TEST SET-UP AND OPERATION MODES.....</b>	<b>11</b>
<b>4.1 PRINCIPLE OF CONFIGURATION SELECTION .....</b>	<b>11</b>
<b>4.2 CARRIER FREQUENCY AND CHANNEL.....</b>	<b>11</b>
<b>4.3 TEST OPERATION AND TEST SOFTWARE.....</b>	<b>12</b>
<b>4.4 SPECIAL ACCESSORIES AND AUXILIARY EQUIPMENT .....</b>	<b>13</b>
<b>4.5 TEST SETUP DIAGRAM .....</b>	<b>13</b>
<b>4.6 DUTY CYCLE OF TEST SIGNAL .....</b>	<b>15</b>
<b>5. TEST RESULTS .....</b>	<b>16</b>
<b>5.1 TRANSMITTER REQUIREMENT &amp; TEST SUITES.....</b>	<b>16</b>
5.1.1 <i>Antenna Requirement .....</i>	<i>16</i>
5.1.2 <i>Peak Output Power .....</i>	<i>17</i>
5.1.3 <i>6 dB Bandwidth and 99% Occupied Bandwidth.....</i>	<i>20</i>
5.1.4 <i>Power Spectral Density.....</i>	<i>21</i>
5.1.5 <i>Conducted Spurious Emissions and Frequency Band Edges Measured in 100 kHz Bandwidth.....</i>	<i>22</i>
5.1.6 <i>Radiated Spurious Emissions and Band Edges .....</i>	<i>23</i>
<b>5.2 MAINS EMISSION .....</b>	<b>28</b>
5.2.1 <i>Mains Conducted Emission.....</i>	<i>28</i>

**Prüfbericht - Nr.: CN22ZR4D (P15C-WiFi) 002**  
Test Report No.

Seite 4 von 29  
Page 4 of 29

**APPENDIX A - TEST RESULT OF CONDUCTED**

**APPENDIX B - TEST RESULT OF RADIATED EMISSIONS & MAINS CONDUCTED EMISSION**

**APPENDIX SP - PHOTOGRAPHS OF TEST SETUP**

**APPENDIX EP - PHOTOGRAPHS OF EUT**

## HISTORY OF THIS TEST REPORT

Report No.	Description	Date Issued
CN22ZR4D (P15C-WiFi) 002	Original Release	2023-04-27

## 1. General Remarks

### 1.1 Complementary Materials

All attachments are integral parts of this test report. This applies especially to the following appendix:

**Appendix A - Test Result of Conducted**

**Appendix B - Test Result of Radiated Emissions & Mains Conducted Emission**

**Appendix SP - Photographs of Test Setup**

**Appendix EP - Photographs of EUT**

### Applied Standard and Test Levels

Radio
FCC 47CFR Part 15: Subpart C Section 15.247
FCC 47CFR Part 2: Subpart J Section 2.1049
ANSI C63.10:2013
KDB 558074 D01 15.247 Meas Guidance v05r02

### 1.2 Decision Rule of Conformity

The decision rule of conformity of this test report is following the requirements of the requested standard in the quotation, and agreed among testing laboratory and manufacturer (applicant) to exclude the consideration of Measurement Uncertainty, unless it is required by the specific standard.

## 2. Test Sites

### 2.1 Test Laboratory

Taipei Testing Laboratories

11F. No.758, Sec. 4, Bade Rd., Songshan Dist.  
Taipei City 105  
Taiwan (R.O.C.)

### 2.2 Test Facility

Taipei Testing Laboratories

No.458-18, Sec. 2, Fenliao Rd., Linkou Dist.,  
New Taipei City 244  
Taiwan (R.O.C.)  
FCC Registration No.: 180491  
ISED Registration No.: 25563

## 2.3 Traceability

All measurement equipment calibrations are traceable to NML(Taiwan)/NIST(USA) or where calibration is performed outside Taiwan, to equivalent nationally recognized standards organizations.

## 2.4 Calibration

Equipment requiring calibration is calibrated periodically in a suitably accredited Calibration Lab. Additionally all equipment is verified for proper performance on a regular basis using in house standards or comparisons.

## 2.5 Measurement Uncertainty

All measurement uncertainty values are shown with a coverage factor of  $k=2$  to indicate a 95% level of confidence.

### Emission Measurement Uncertainty

Parameter	Uncertainty
Radiated Emission (9 kHz ~ 30 MHz)	$\pm 1.15$ dB
Radiated Emission (30 MHz ~ 200 MHz)	$\pm 1.30$ dB
Radiated Emission (200 MHz ~ 1 GHz)	$\pm 1.30$ dB
Radiated Emission (1 GHz ~ 18 GHz)	$\pm 1.54$ dB
Radiated Emission (18 GHz ~ 40 GHz)	$\pm 2.52$ dB
Mains Conducted Emission	$\pm 1.65$ dB



### 3. General Product Information

#### 3.1 Product Function and Intended Use

The EUT is a L2 WiFi Water Sensor and Switch. It contains a WLAN compatible module enabling the user to communicate data through a Wireless interface.

For details refer to the User Guide, Data Sheet and Circuit Diagram.

#### 3.2 System Details and Ratings

##### Basic Information of EUT

Item	EUT information
Kind of Equipment/Test Item	L2 WiFi Water Sensor and Switch
Type Identification	TWLD3005-001
Trademark	Resideo
FCC ID	HS9-TWLD3L1

##### Technical Specification of EUT

Item	EUT information
Operating Frequency	2412 MHz ~ 2462 MHz
Channel Number	802.11b/g/n HT20: 11 802.11n HT40: 7
Data Rate	802.11b: 11.0 / 5.5 / 2.0 / 1.0 Mbps 802.11g: 54.0 / 48.0 / 36.0 / 24.0 / 18.0 / 12.0 / 9.0 / 6.0 Mbps 802.11n: up to MCS7
Operation Voltage	24 VAC/DC (test for 24 Vdc)
Modulation	DSSS (DBPSK, DQPSK, CCK) OFDM (BPSK, QPSK, 16QAM, 64QAM)
Maximum Output Power (mW)	802.11b: 187.07 802.11g: 339.63 802.11n HT20: 334.97 802.11n HT40: 331.13
Antenna Information	Refer to 5.1.1
Accessory Device	Refer to 4.4

### 3.3 Noise Generating and Noise Suppressing Parts

Refer to the Circuit Diagram.

### 3.4 Submitted Documents

- Circuit Diagram
- Instruction Manual
- Rating Label
- Technical Description

## 4. Test Set-up and Operation Modes

### 4.1 Principle of Configuration Selection

The test modes were adapted accordingly in reference to the instructions for use.

During testing, Channel and Power Controlling Software provided by the customer was used to control the operating channel as well as the output power level. The RF output power selection is for the setting of RF output expected by the customer and is going to be fixed on the firmware of the final end product.

**Table for Parameters of Test Software Setting**

802.11b		802.11g		802.11n HT20		802.11n HT40	
Channel	Power Setting	Channel	Power Setting	Channel	Power Setting	Channel	Power Setting
1	111	1	94	1	93	3	92
2	88	6	102	6	103	6	100
6	89	11	95	11	90	9	88
11	86						

### 4.2 Carrier Frequency and Channel

802.11b, 802.11g and 802.11n HT20:

Channel	Frequency (MHz)	Channel	Frequency (MHz)
1	2412	8	2447
2	2417	9	2452
3	2422	10	2457
4	2427	11	2462
5	2432		
6	2437		
7	2442		

802.11n HT40:

Channel	Frequency (MHz)	Channel	Frequency (MHz)
3	2422	7	2442
4	2427	8	2447
5	2432	9	2452
6	2437		

### 4.3 Test Operation and Test Software

Setup for testing: Test samples are provided with a USB interface which makes it possible to control them through a test software installed on a notebook computer.

This software was running on the laptop computer connected to the EUT. It was used to enable the operation modes listed as below.

Test Software	AmebaD_mptool_2V0
---------------	-------------------

The samples were used as follows:

A003420561-018

A003420561-014

Full test was applied on all test modes, but only worst case was shown.

EUT Configure Mode	Applicable To			Description	
	Antenna Port Conducted Measurement	Radiated Spurious Emissions above 1 GHz	Radiated Spurious Emissions below 1 GHz		Mains Conducted Emission
-	√	√	√	√	-

Note:

1. The EUT had been pre-tested on the positioned of each 3 axis. The worst case was found when position on **Y-plane**.
2. "-" means no effect.

#### Antenna Port Conducted Measurement

Pre-Scan full test was applied on all test modes, but only worst case was shown.

Following channel(s) was (were) selected for the final test as listed below.

EUT Configure Mode	Mode	Available Channel	Tested Channel	Date Rate (Mbps)
-	802.11b	1 to 11	1, 2, 6, 11	1.0
-	802.11g	1 to 11	1, 6, 11	6.0
-	802.11n HT20	1 to 11	1, 6, 11	MCS0
-	802.11n HT40	3 to 9	3, 6, 9	MCS0

#### Radiated Spurious Emissions (Above 1 GHz)

Pre-Scan full test was applied on all test modes, but only worst case was shown.

Following channel(s) was (were) selected for the final test as listed below.

EUT Configure Mode	Mode	Available Channel	Tested Channel	Date Rate (Mbps)
-	802.11b	1 to 11	1, 6, 11	1.0
-	802.11g	1 to 11	1, 6, 11	6.0
-	802.11n HT20	1 to 11	1, 6, 11	MCS0
-	802.11n HT40	3 to 9	3, 6, 9	MCS0

#### Radiated Spurious Emissions (Below 1 GHz)

Pre-Scan full test was applied on all test modes, but only worst case was shown.

Following channel(s) was (were) selected for the final test as listed below.

EUT Configure Mode	Mode	Available Channel	Tested Channel	Date Rate (Mbps)
-	802.11n HT20	1 to 11	11	MCS0

**Mains Conducted Emission**

- Pre-Scan full test was applied on all test modes, but only worst case was shown.
- Following channel(s) was (were) selected for the final test as listed below.

EUT Configure Mode	Mode	Available Channel	Tested Channel	Date Rate (Mbps)
-	802.11n HT20	1 to 11	11	MCS0

**Test Condition**

Test Item	Ambient Temperature	Relative Humidity	Tested by
Conducted Measurement	23.5-24.3 °C	66-68 %	Blake Wang & Nick Guan
Radiated Spurious Emissions above 1 GHz	21.1-21.9 °C	60-64 %	Chuan Chu
Radiated Spurious Emissions below 1 GHz	21.1-21.9 °C	60-64 %	Chuan Chu
Mains Conducted Emission	21.1-24.9 °C	51.7-54.9 %	Ray Huang

## 4.4 Special Accessories and Auxiliary Equipment

The product has been tested together with the following additional accessories:

**Accessory of EUT**

No.	Product	Brand	Model	Description
B	Cable Sensor	ININ	11LDT-A06-0001	--

**Support Unit**

Support Unit								
No	Description	Brand	Model	S/N	Shielded	Ferrite Core (Qty)	Length (cm)	Remark
A	Adapter	Dexatek	SAW30-240-1250U	N/A	NO	NO	180	--
-	Notebook	DELL	E7450	HKYHR32	-	-	-	--

## 4.5 Test Setup Diagram

<Radiated Spurious Emissions mode>

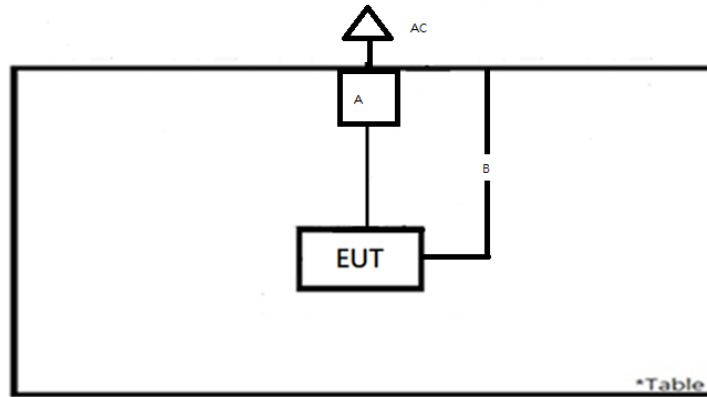

<Mains Conducted Emission mode>

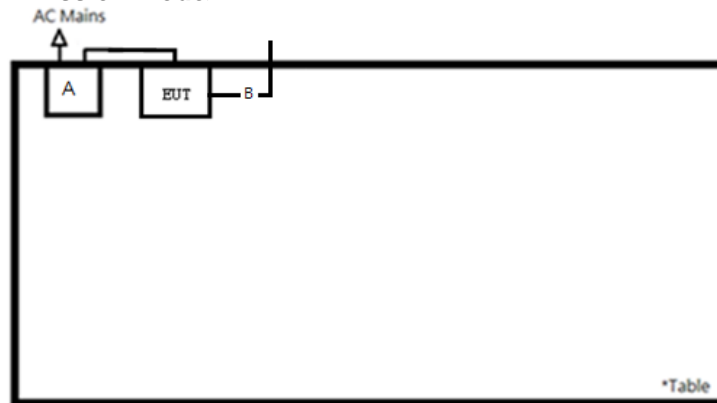

## 4.6 Duty Cycle of Test Signal

Mode	On + Off Time (ms)	On Time (ms)	Duty Cycle (%)	Duty Factor (dB)
802.11b	12.60	12.45	98.81	0.05
802.11g	2.20	2.05	93.18	0.31
802.11n HT20	2.07	1.92	92.75	0.33
802.11n HT40	1.08	0.95	87.91	0.56

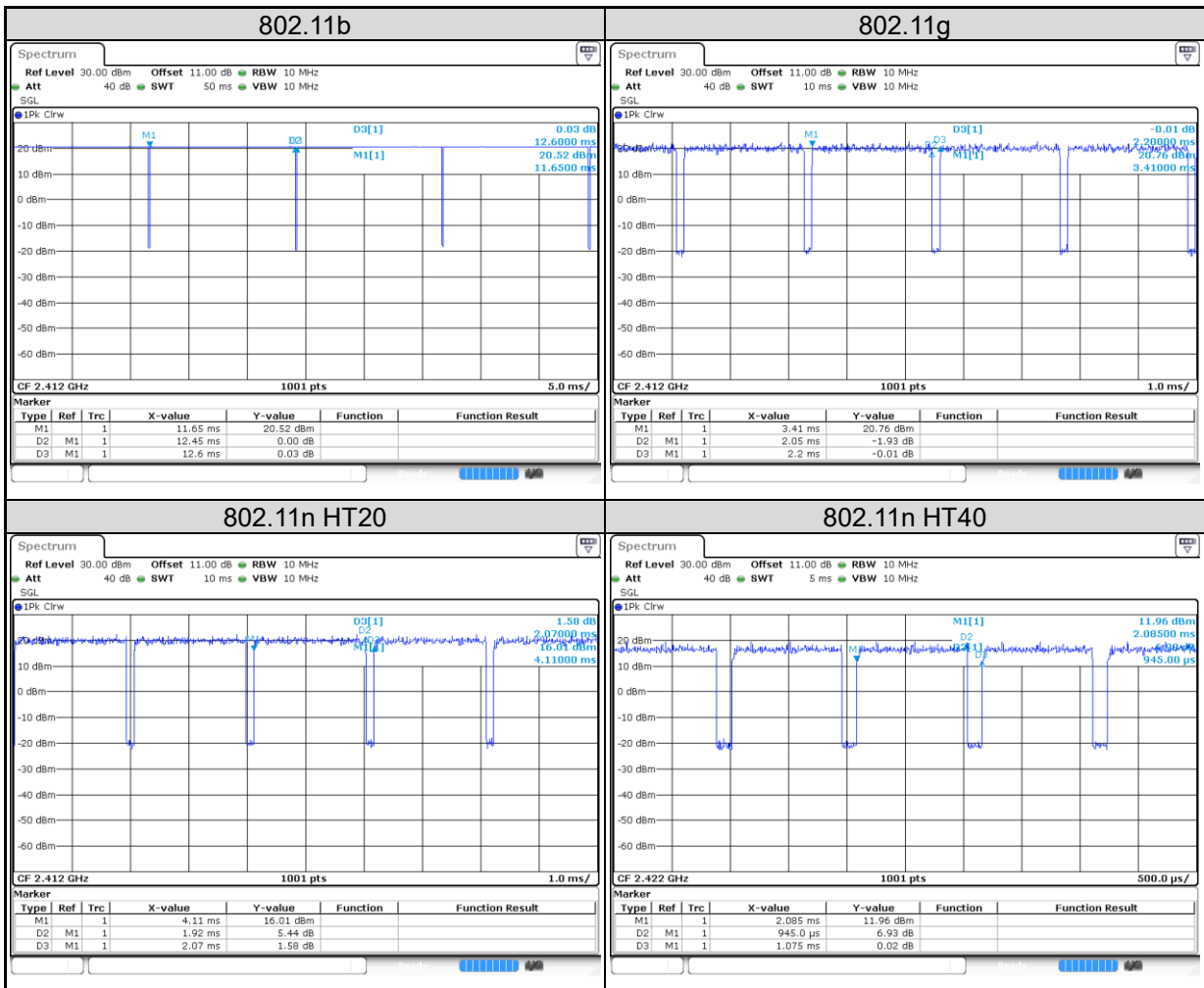

## 5. Test Results

### 5.1 Transmitter Requirement & Test Suites

#### 5.1.1 Antenna Requirement

**Requirement** Use of approved antennas only

According to the manufacturer declaration, the EUT has an antenna with a directional gain of 2.99 dBi. The antenna is a PCB antenna with no possibility of replacement with a non-approved antenna by the end-user. Therefore, the EUT is considered to comply with this provision.

Refer to EUT photo for details.



### 5.1.2 Peak Output Power

**Limit** 1 watt (30 dBm)

**Kind of Test Site** Shielded room

#### Test Setup



#### Test Instruments

Kind of Equipment	Manufacturer	Type	S/N	Calibration Date	Calibration Due Date	Test Date	
						From	Until
Power Meter	Anritsu	ML2495A	1901008	2023/3/17	2024/3/15	2023/4/10	2023/4/10
Power Sensor	Anritsu	MA2411B	1725269	2023/3/17	2024/3/15	2023/4/10	2023/4/10

#### Test Procedures

A peak power sensor was used on the output port of the EUT. A power meter was used to read the response of the peak power sensor. Record the power level.

Average power sensor was used to perform output power measurement, trigger and gating function of wide band power meter is enabled to measure max output power of TX on burst. Duty factor is not added to measured value.

**Test Result**
**Peak Output Power**
**<802.11b>**

Channel	Channel Frequency (MHz)	Peak Output Power		Limit (dBm)
		(dBm)	(mW)	
1	2412	22.72	187.07	30
2	2417	17.67	58.48	30
6	2437	18.48	70.47	30
11	2462	17.75	59.57	30

**<802.11g>**

Channel	Channel Frequency (MHz)	Peak Output Power		Limit (dBm)
		(dBm)	(mW)	
1	2412	24.30	269.15	30
6	2437	25.31	339.63	30
11	2462	24.88	307.61	30

**<802.11n HT20>**

Channel	Channel Frequency (MHz)	Peak Output Power		Limit (dBm)
		(dBm)	(mW)	
1	2412	24.57	286.42	30
6	2437	25.25	334.97	30
11	2462	24.03	252.93	30

**<802.11n HT40>**

Channel	Channel Frequency (MHz)	Peak Output Power		Limit (dBm)
		(dBm)	(mW)	
3	2422	24.62	289.73	30
6	2437	25.20	331.13	30
9	2452	24.11	257.63	30

**Average Power (For Reference)**
**<802.11b>**

Channel	Channel Frequency (MHz)	Average Power	
		(dBm)	(mW)
1	2412	20.57	114.02
2	2417	15.48	35.32
6	2437	16.18	41.50
11	2462	15.33	34.12

**<802.11g>**

Channel	Channel Frequency (MHz)	Average Power	
		(dBm)	(mW)
1	2412	16.75	47.32
6	2437	19.26	84.33
11	2462	17.67	58.48

**<802.11n HT20>**

Channel	Channel Frequency (MHz)	Average Power	
		(dBm)	(mW)
1	2412	16.52	44.87
6	2437	19.23	83.75
11	2462	16.34	43.05

**<802.11n HT40>**

Channel	Channel Frequency (MHz)	Average Power	
		(dBm)	(mW)
3	2422	16.06	40.36
6	2437	18.62	72.78
9	2452	15.93	39.17

### 5.1.3 6 dB Bandwidth and 99% Occupied Bandwidth

**Limit** The minimum 6 dB bandwidth shall be at least 500 kHz.

**Kind of Test Site** Shielded room

#### Test Setup

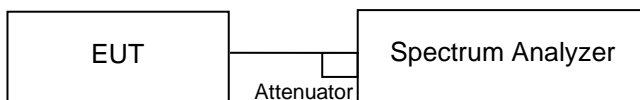

#### Test Instruments

Kind of Equipment	Manufacturer	Type	S/N	Calibration Date	Calibration Due Date	Test Date	
						From	Until
Spectrum Analyzer	R&S	FSV	101513	2022/5/11	2023/5/10	2023/4/10	2023/4/10

#### Test Procedure

- a. Set resolution bandwidth (RBW) = 100 kHz
- b. Set the video bandwidth (VBW)  $\geq 3 \times$  RBW, Detector = Peak.
- c. Trace mode = max hold.
- d. Sweep = auto couple.
- e. Measure the maximum width of the emission that is constrained by the frequencies associated with the two amplitude points (upper and lower) that are attenuated by 6 dB relative to the maximum level measured in the fundamental emission.
- f. For 99% occupied bandwidth measurement, the transmitter output was connected to the spectrum analyzer through an attenuator. The bandwidth of the fundamental frequency was measured by spectrum analyzer with resolution bandwidth in the range of 1% to 5% of the anticipated emission bandwidth, and a video bandwidth at least 3x the resolution bandwidth and set the detector to PEAK. The width of a frequency band such that, below the lower and above the upper frequency limits, the mean powers emitted are each equal to a specified percentage 0.5% of the total mean power of a given emission.

#### Test Results

Please refer to Appendix A.

### 5.1.4 Power Spectral Density

**Limit**

The power spectral density shall not be greater than 8 dBm in any 3 kHz band.

**Kind of Test Site**                      Shielded room

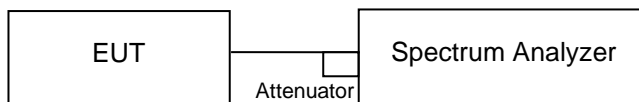
**Test Setup**

**Test Instruments**

Kind of Equipment	Manufacturer	Type	S/N	Calibration Date	Calibration Due Date	Test Date	
						From	Until
Spectrum Analyzer	R&S	FSV	101513	2022/5/11	2023/5/10	2023/4/10	2023/4/10

**Test Procedure**

- a. Set analyzer center frequency to DTS channel center frequency.
- b. Set the span to 1.5 times the DTS bandwidth.
- c. Set the RBW to:  $3 \text{ kHz} \leq \text{RBW} \leq 100 \text{ kHz}$ .
- d. Set the VBW  $\geq 3 \times \text{RBW}$ .
- e. Detector = peak.
- f. Sweep time = auto couple.
- g. Trace mode = max hold.
- h. Allow trace to fully stabilize.
- i. Use the peak marker function to determine the maximum amplitude level within the RBW.

**Test Results**

Please refer to Appendix A.

## 5.1.5 Conducted Spurious Emissions and Frequency Band Edges Measured in 100 kHz Bandwidth

### Limit

20 dB (below that in the 100 kHz bandwidth within the band that contains the highest level of the desired power.)

**Kind of Test Site**                      Shielded room

### Test Setup

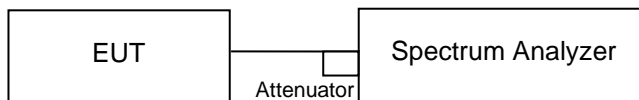

### Test Instruments

Kind of Equipment	Manufacturer	Type	S/N	Calibration Date	Calibration Due Date	Test Date	
						From	Until
Spectrum Analyzer	R&S	FSV	101513	2022/5/11	2023/5/10	2023/4/10	2023/4/10

### Test Procedure

Measurement procedure REF

1. Set the RBW = 100 kHz.
2. Set the VBW  $\geq$  300 kHz.
3. Detector = peak.
4. Sweep time = auto couple.
5. Trace mode = max hold.
6. Allow trace to fully stabilize.
7. Use the peak marker function to determine the maximum power level in any 100 kHz band segment within the fundamental EBW.

Measurement procedure OOBE

1. Set RBW = 100 kHz.
2. Set VBW  $\geq$  300 kHz.
3. Detector = peak.
4. Sweep = auto couple.
5. Trace Mode = max hold.
6. Allow trace to fully stabilize.
7. Use the peak marker function to determine the maximum amplitude level.

### Test Results

Please refer to Appendix A.

### 5.1.6 Radiated Spurious Emissions and Band Edges

#### Limit

Radiated emissions which fall in the restricted bands, as defined in §15.205(a), must comply with the radiated emission limits specified in §15.209(a).

Emissions radiated outside the restricted and authorized frequency bands must either comply with the radiated emission limits specified for the restricted bands or in §15.247(d).

**Kind of Test Site**                      3m Semi-Anechoic Chamber

#### Test Setup

<Radiated Emissions below 30 MHz>

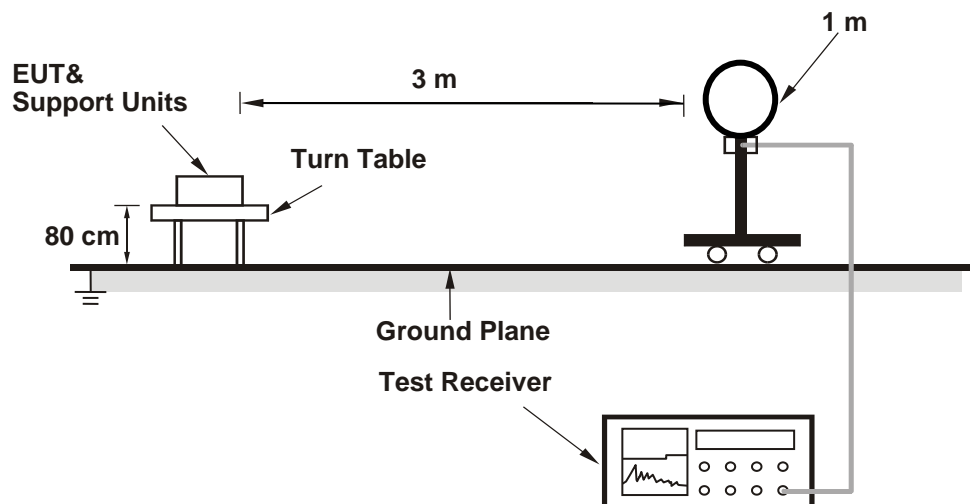

<Radiated Emissions 30 MHz to 1 GHz>

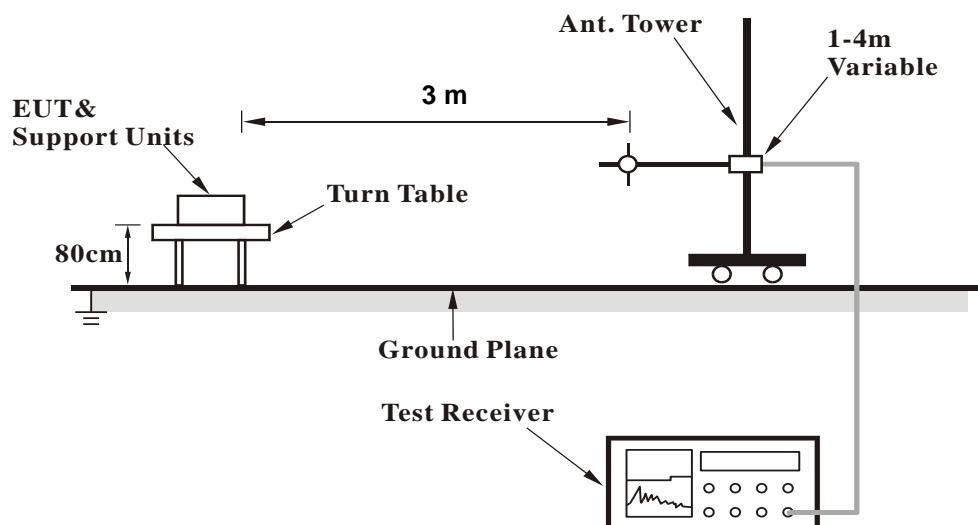

## &lt;Radiated Emissions above 1 GHz&gt;

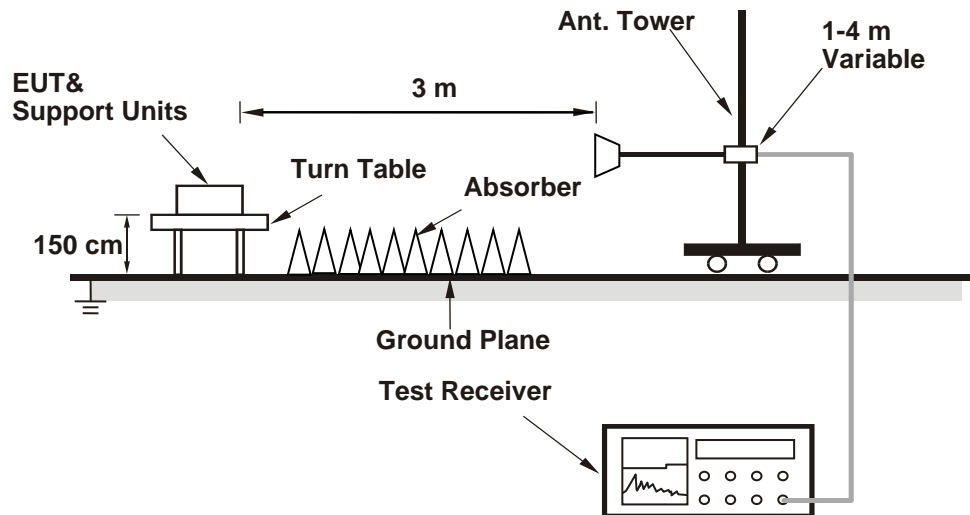

For the actual test configuration, please refer to the attached file (Test Setup Photo).



**Test Instruments**

Kind of Equipment	Manufacturer	Type	S/N	Calibration Date	Calibration Due Date
<b>Above 1 GHz</b>					
Signal Analyzer	R&S	FSV40	101509	2022/4/22	2023/4/21
Horn Antenna	ETS-Lindgren	3117	00218929	2022/12/8	2023/12/7
HF-AMP + AC source	EMCI	EMC051845SE	980633	2023/2/22	2024/2/21
HF-AMP + AC source	EMCI	EMC184045SE	980657	2023/2/16	2024/2/15
Horn Antenna	SCHWARZBECK	BBHA 9170	00890	2022/5/6	2023/5/5
Test Software	Audix E3	15914a_20191106 tuv	PK-001087	N/A	N/A
<b>30 MHz ~ 1 GHz</b>					
Receiver	R&S	ESR7	102109	2023/2/24	2024/2/23
Bilog Antenna	SCHWARZBECK	VULB-9168	00949	2022/5/29	2023/5/28
LF-AMP	Agilent	8447D	2944A107722	2023/3/22	2024/3/20
Test Software	Audix E3	15914a_20191106 tuv	PK-001087	N/A	N/A
<b>Below 30 MHz</b>					
Receiver	R&S	ESR7	102109	2023/2/24	2024/2/23
Loop Antenna	SCHWARZBECK	FMZB 1519B	00215	2023/1/4	2024/1/3
Test Software	Audix E3	15914a_20191106 tuv	PK-001087	N/A	N/A

**Test Procedures****For Radiated Emissions below 30 MHz**

- a. The EUT was placed on the top of a rotating table 0.8 meters above the ground at a 3 meter chamber room. The table was rotated 360 degrees to determine the position of the highest radiation.
- b. The EUT was set 3 meters away from the interference-receiving antenna, which was mounted on the top of a variable-height antenna tower.
- c. Parallel (OPEN), perpendicular (CLOSE), and ground-parallel (GROUND) orientations of the antenna are set to make the measurement.
- d. For each suspected emission, the EUT was arranged to its worst case and the rotatable table was turned from 0 degrees to 360 degrees to find the maximum reading.
- e. The test-receiver system was set to Quasi-Peak Detect Function and Specified Bandwidth with Maximum Hold Mode.

## Note:

1. The resolution bandwidth and video bandwidth of test receiver/spectrum analyzer is 9 kHz at frequency below 30 MHz.
2. All modes of operation were investigated and the worst-case emissions are reported.

**For Radiated Emissions above 30 MHz**

- a. The EUT was placed on the top of a rotating table 0.8 meters (for 30 MHz ~ 1 GHz) / 1.5 meters (for above 1 GHz) above the ground at 3 meter chamber room for test. The table was rotated 360 degrees to determine the position of the highest radiation.
- b. The EUT was set 3 meters away from the interference-receiving antenna, which was mounted on the top of a variable-height antenna tower.
- c. The height of antenna is varied from one meter to four meters above the ground to determine the maximum value of the field strength. Both horizontal and vertical polarizations of the antenna are set to make the measurement.
- d. For each suspected emission, the EUT was arranged to its worst case and then the antenna was tuned to heights from 1 meter to 4 meters and the rotatable table was turned from 0 degrees to 360 degrees to find the maximum reading.
- e. The test-receiver system was set to quasi-peak detect function and specified bandwidth with maximum hold mode when the test frequency is below 1 GHz.
- f. The test-receiver system was set to peak and average detected function and specified bandwidth with maximum hold mode when the test frequency is above 1 GHz. If the peak reading value also meets average limit, measurement with the average detector is unnecessary.

## Note:

1. The resolution bandwidth and video bandwidth of test receiver/spectrum analyzer is 120 kHz for Quasi-peak detection (QP) or Peak detection (PK) at frequency below 1 GHz.
2. The resolution bandwidth of test receiver/spectrum analyzer is 1 MHz and the video bandwidth is 3 MHz for Peak detection (PK) at frequency above 1 GHz.
3. The resolution bandwidth of test receiver/spectrum analyzer is 1 MHz and the video bandwidth is  $\geq 1/T$  (Duty cycle < 98 %) or 10 Hz (Duty cycle  $\geq 98$  %) for Average detection (AV) at frequency above 1 GHz.
4. All modes of operation were investigated and the worst-case emissions are reported.
5. The Radiated Emissions testing was performed in the X(E1), Y(H) and Z(E2) axis orientation. The worst-case Axis orientation is recorded in this test report.

**Prüfbericht - Nr.:**      **CN22ZR4D (P15C-WiFi) 002**  
*Test Report No.*

**Seite 27 von 29**  
*Page 27 of 29*

**Test Results**

Factor (dB/m) = Antenna Factor (dB/m) + Cable Loss (dB)  
Level (dBuV/m) = Reading (dBuV) + Factor (dB/m)

Please refer to Appendix B.

## 5.2 Mains Emission

### 5.2.1 Mains Conducted Emission

#### Limit

Mains Conducted Emission as defined in §15.207 must comply with the mains conducted emission limits.

**Kind of Test Site**                      Shielded room

#### Test Setup

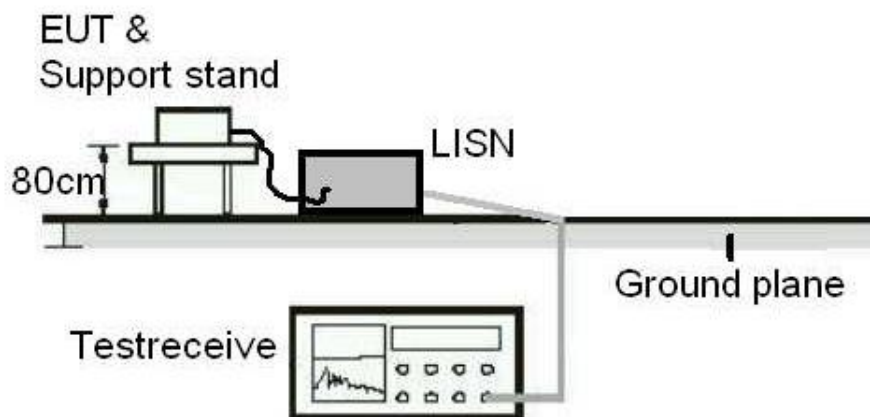

#### Test Instruments

Kind of Equipment	Manufacturer	Type	S/N	Calibration Date	Calibration Due Date
Two-Line V-Network	Rohde & Schwarz	ENV216	101938	2022/9/22	2023/9/21
EMI Test Receiver	R&S	ESCI	100797	2022/6/19	2023/6/18

#### **Test Procedures**

- a. The EUT was placed 0.4 meters from the conducting wall of the shielded room with EUT being connected to the power mains through a line impedance stabilization network (LISN). Other support units were connected to the power mains through another LISN. The two LISNs provide 50 ohm/50 uH of coupling impedance for the measuring instrument.
- b. Both lines of the power mains connected to the EUT were checked for maximum conducted interference.
- c. The frequency range from 150 kHz to 30 MHz was searched. Emission levels under (Limit – 20 dB) was not recorded.

Note: The resolution bandwidth and video bandwidth of test receiver is 9 kHz for quasi-peak detection (QP) and average detection (AV) at frequency 0.15 MHz – 30 MHz.

#### **Test Results**

Please refer to Appendix B.

## Appendix A: Test Results of Conducted Test

### Test Result of 6 dB Bandwidth

#### 802.11b

Channel	Channel Frequency (MHz)	6 dB Bandwidth (MHz)	Limit (MHz)	Result
CH01	2412	9.11	> 0.5	Pass
CH02	2417	9.15	> 0.5	Pass
CH06	2437	9.03	> 0.5	Pass
CH11	2462	10.03	> 0.5	Pass

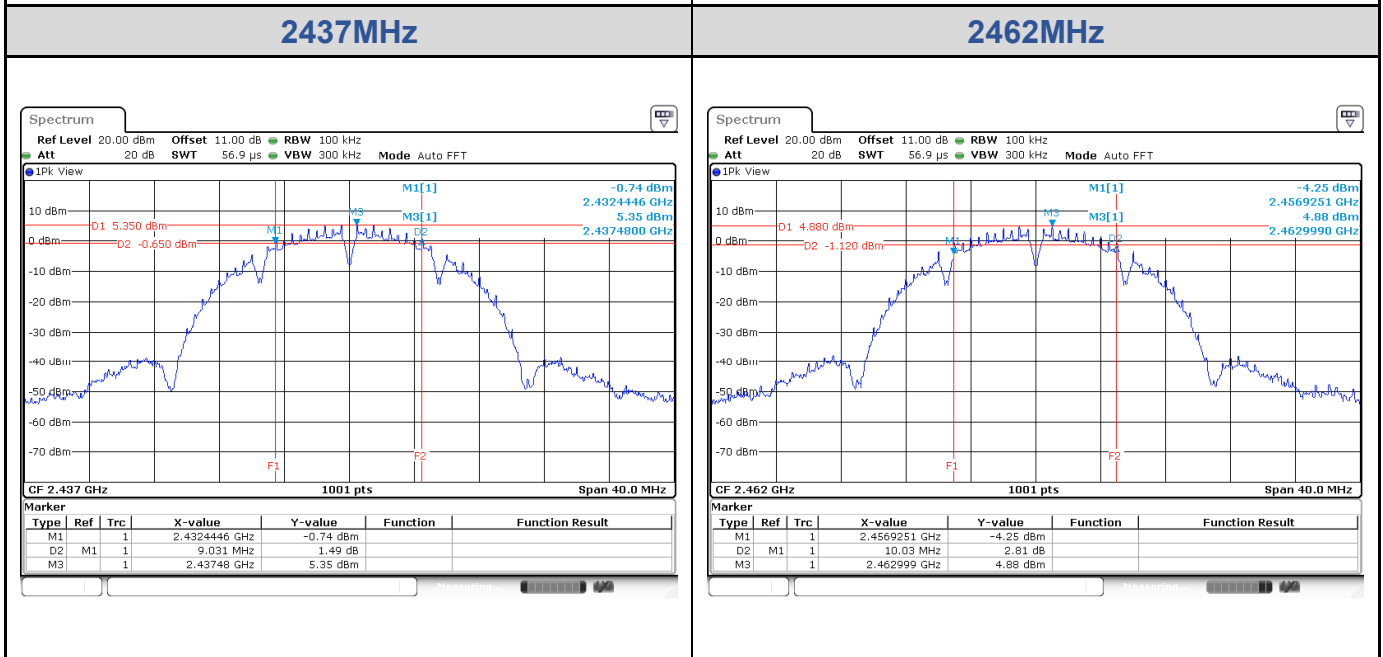
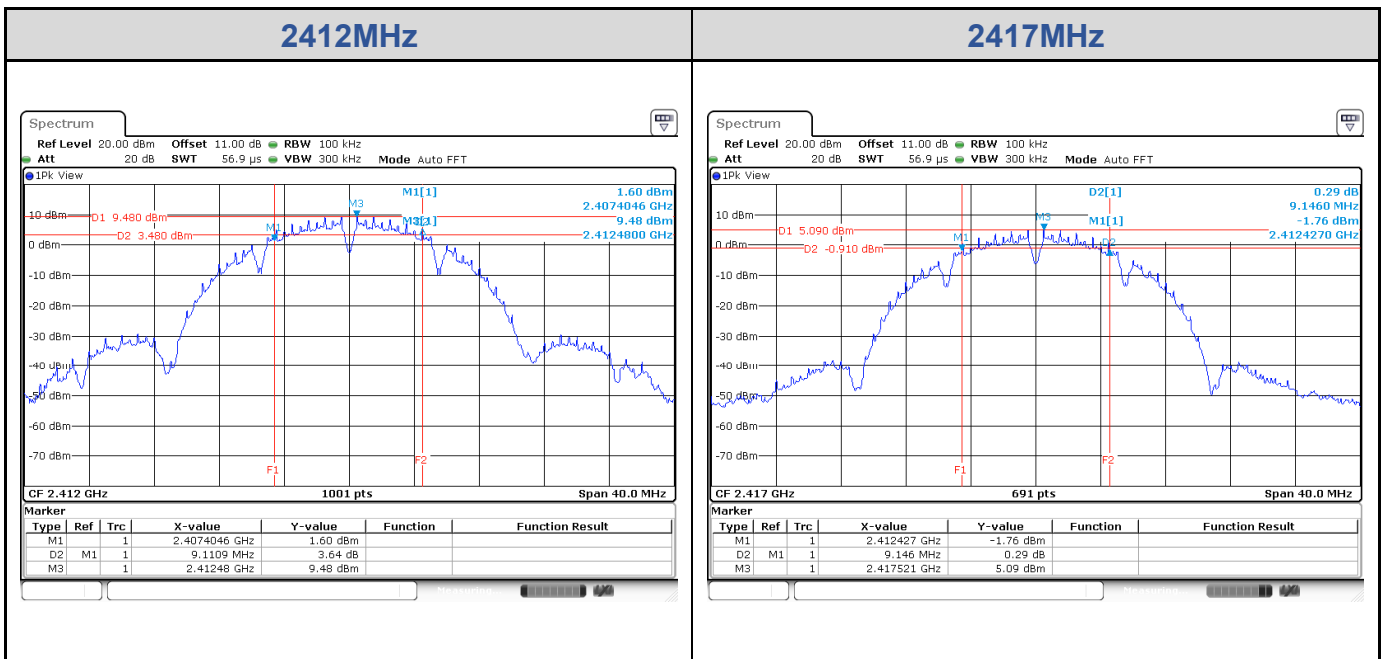

**802.11g**

Channel	Channel Frequency (MHz)	6 dB Bandwidth (MHz)	Limit (MHz)	Result
CH01	2412	16.38	> 0.5	Pass
CH06	2437	16.30	> 0.5	Pass
CH11	2462	16.30	> 0.5	Pass

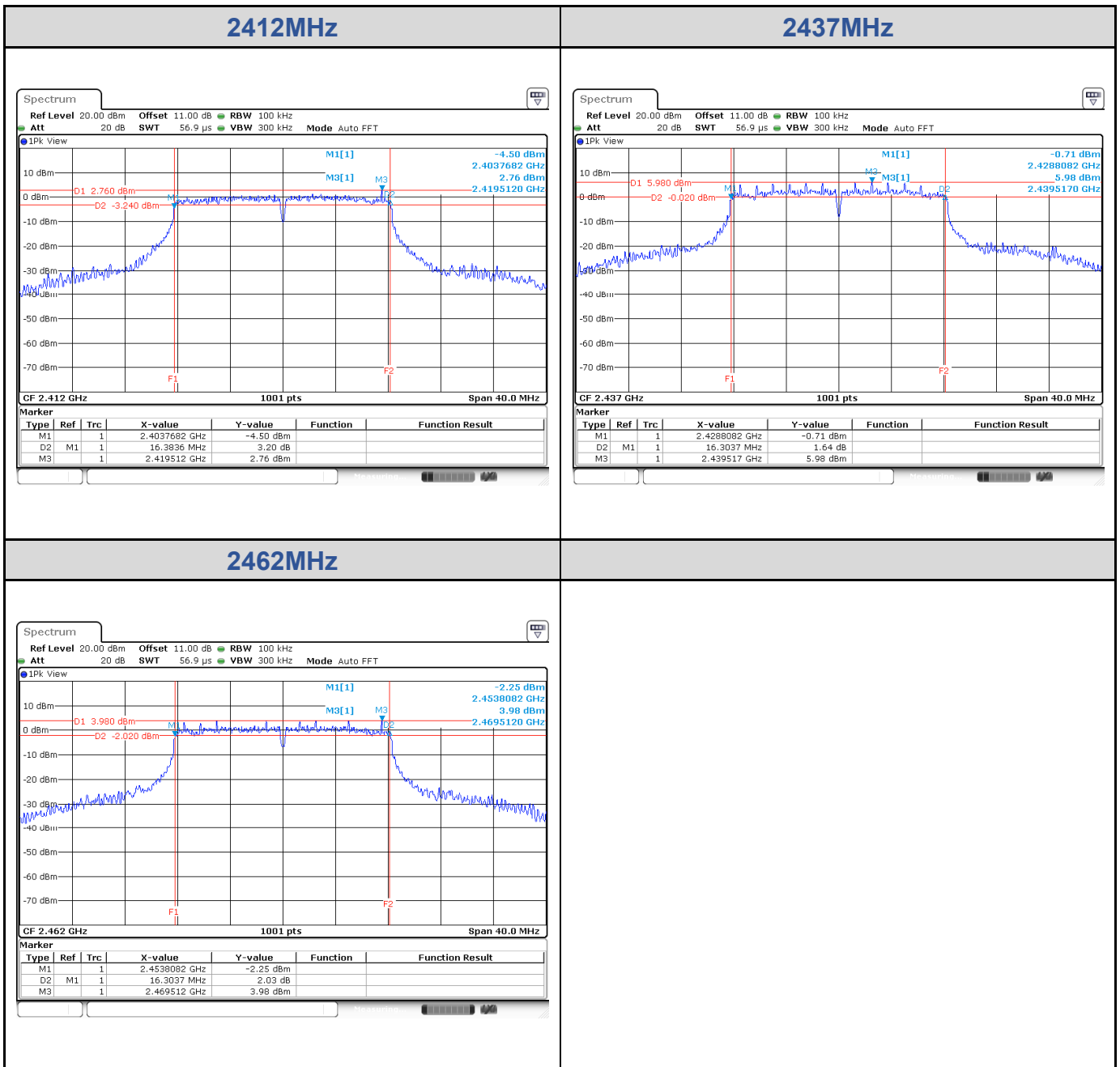

**802.11n HT20**

Channel	Channel Frequency (MHz)	6 dB Bandwidth (MHz)	Limit (MHz)	Result
CH01	2412	17.58	> 0.5	Pass
CH06	2437	17.54	> 0.5	Pass
CH11	2462	17.50	> 0.5	Pass

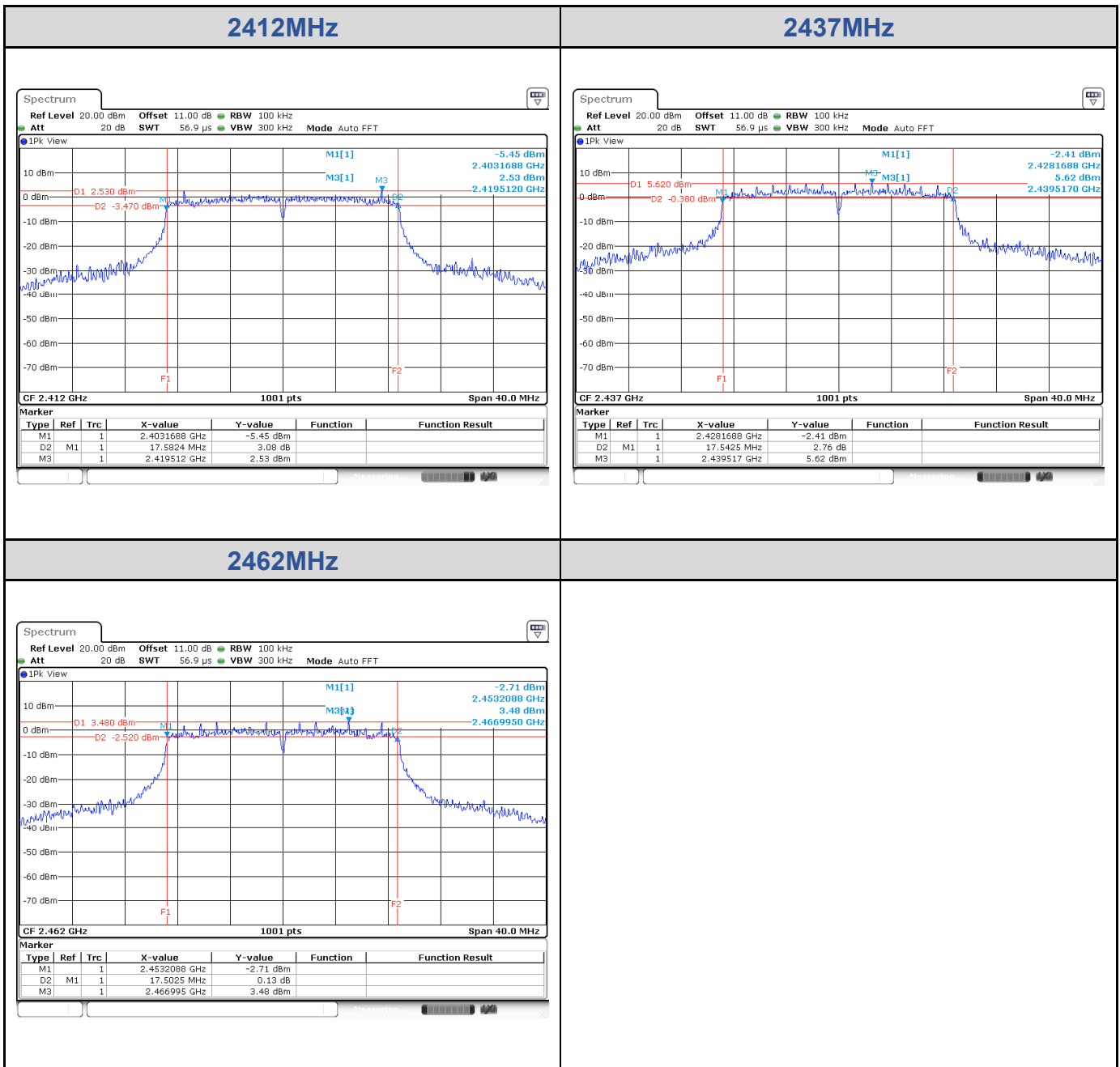



**802.11n HT40**

Channel	Channel Frequency (MHz)	6 dB Bandwidth (MHz)	Limit (MHz)	Result
CH03	2422	35.32	> 0.5	Pass
CH06	2437	34.05	> 0.5	Pass
CH09	2452	35.16	> 0.5	Pass

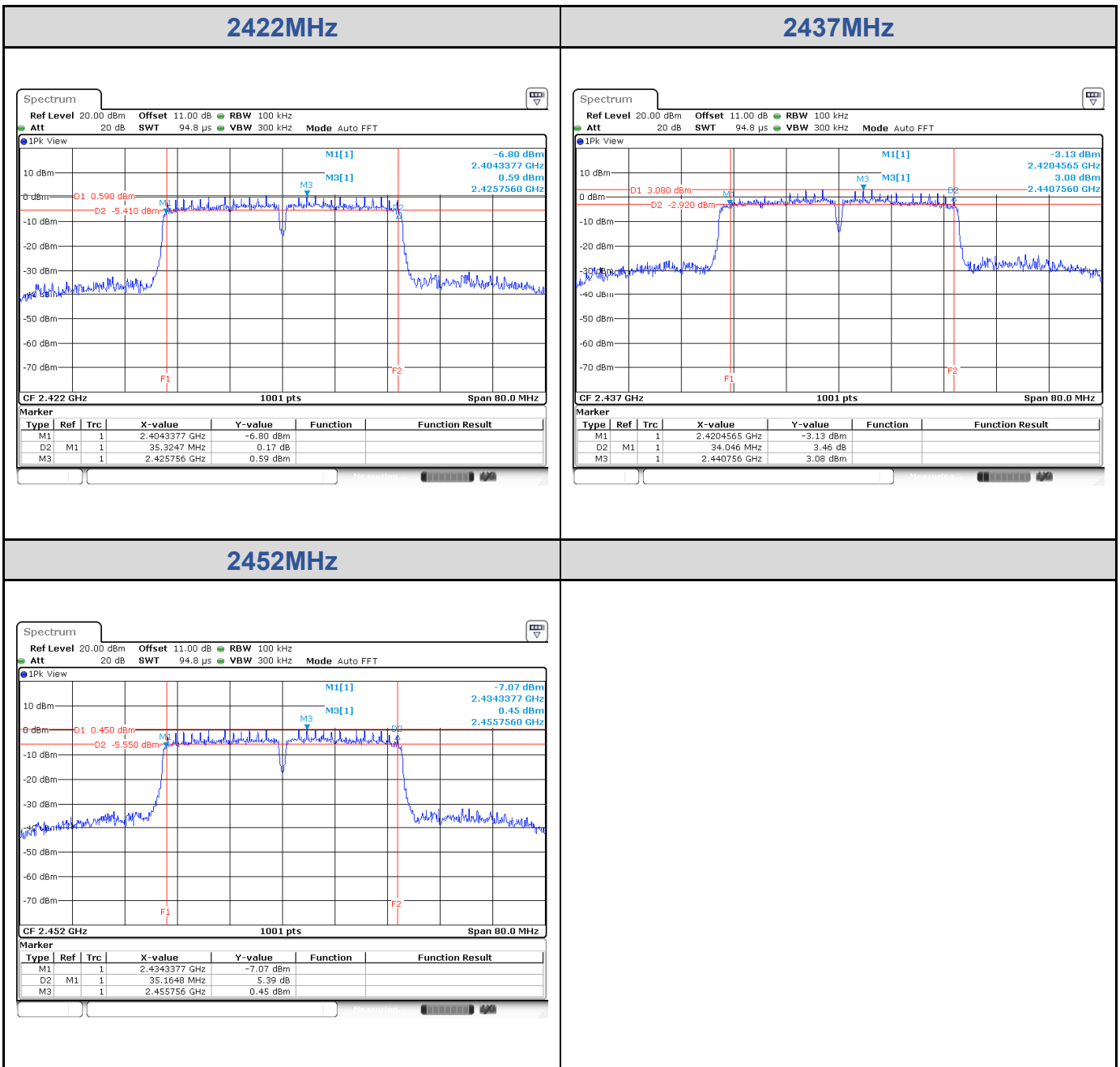

## Test Result of 99% Occupied Bandwidth

### 802.11b

Channel	Channel Frequency (MHz)	99% Bandwidth (MHz)
CH01	2412	14.91
CH02	2417	14.70
CH06	2437	14.71
CH11	2462	14.71

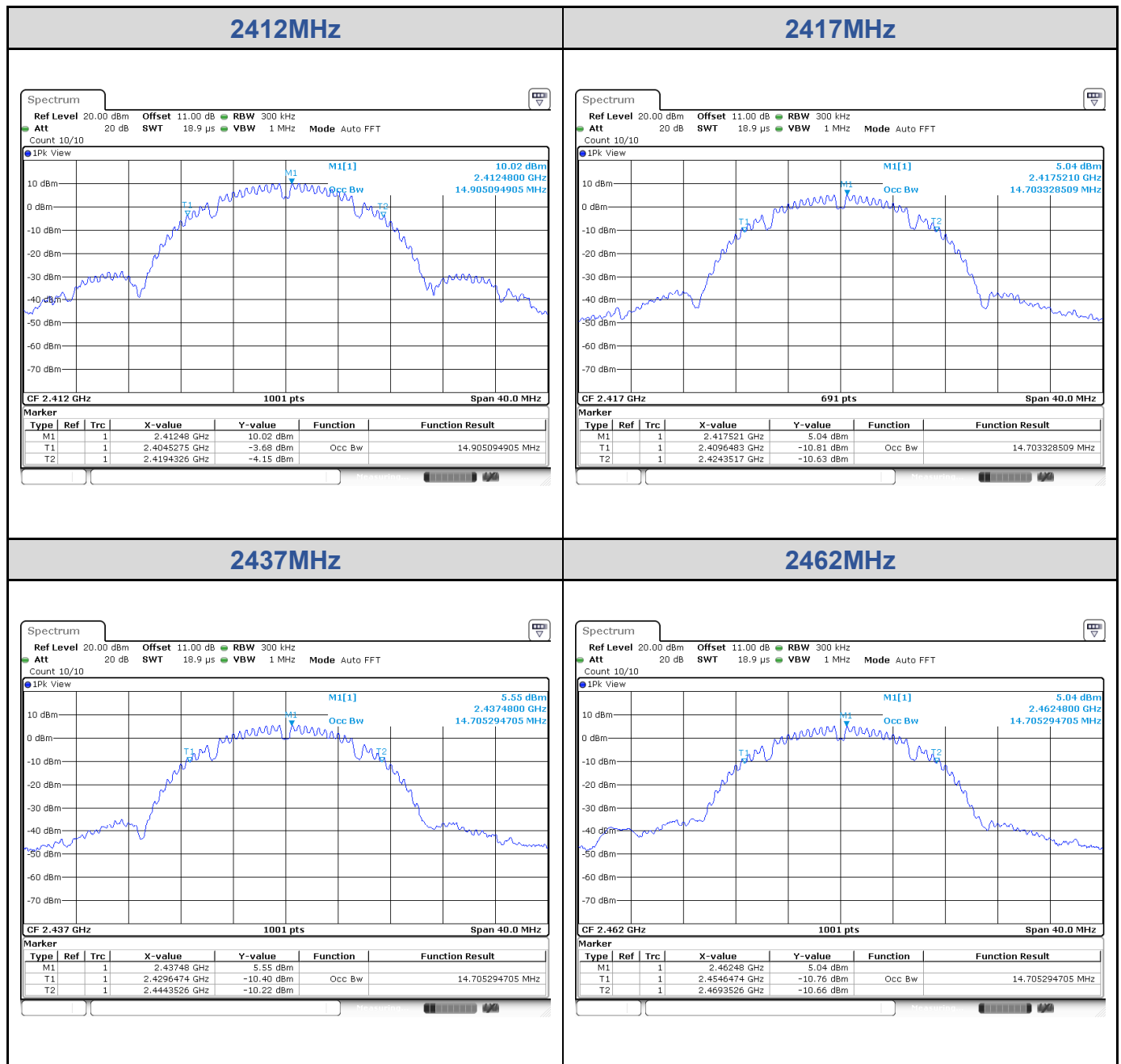

**802.11g**

Channel	Channel Frequency (MHz)	99% Bandwidth (MHz)
CH01	2412	16.78
CH06	2437	17.06
CH11	2462	16.90

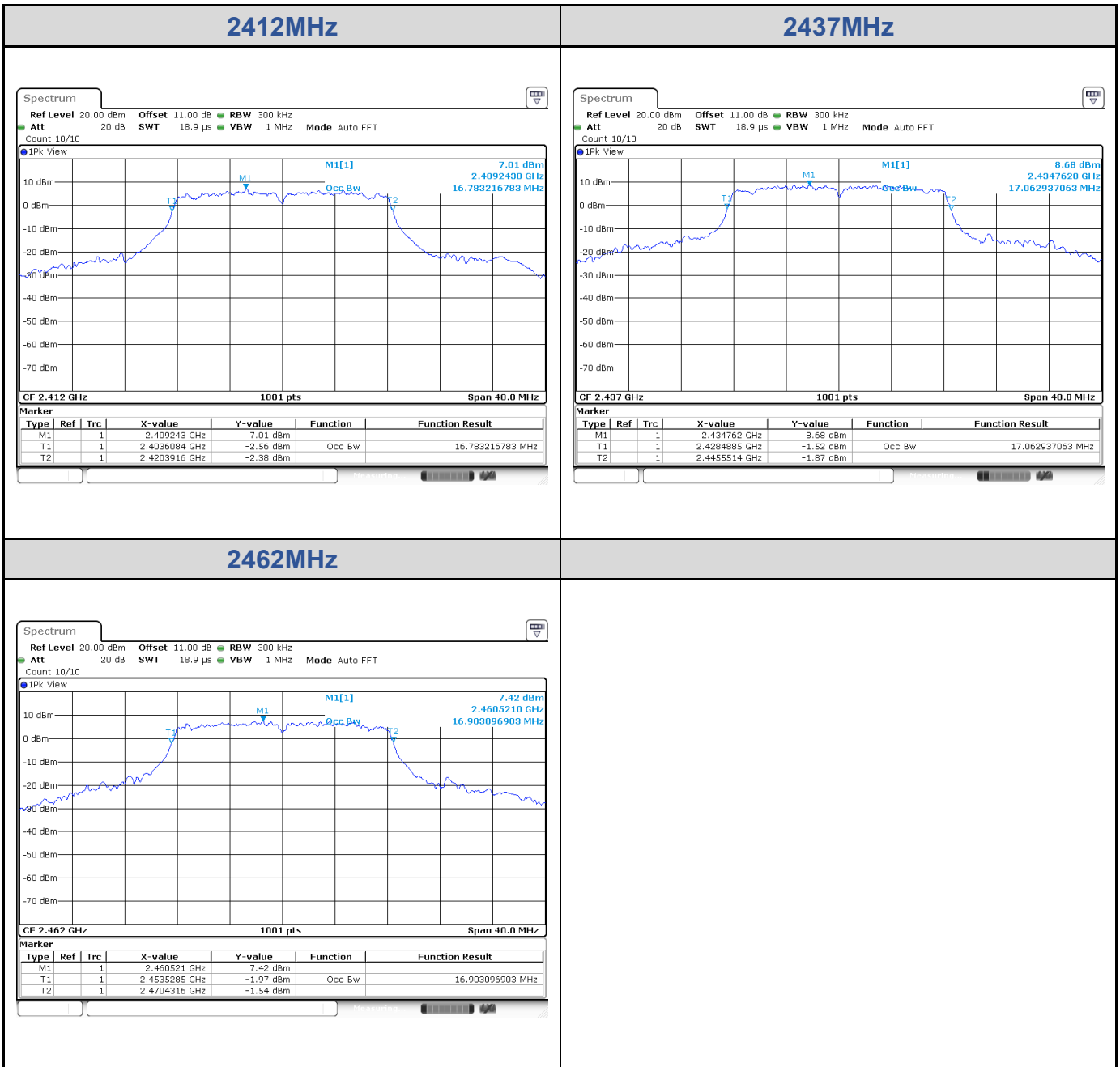

**802.11n HT20**

Channel	Channel Frequency (MHz)	99% Bandwidth (MHz)
CH01	2412	17.90
CH06	2437	18.46
CH11	2462	17.94

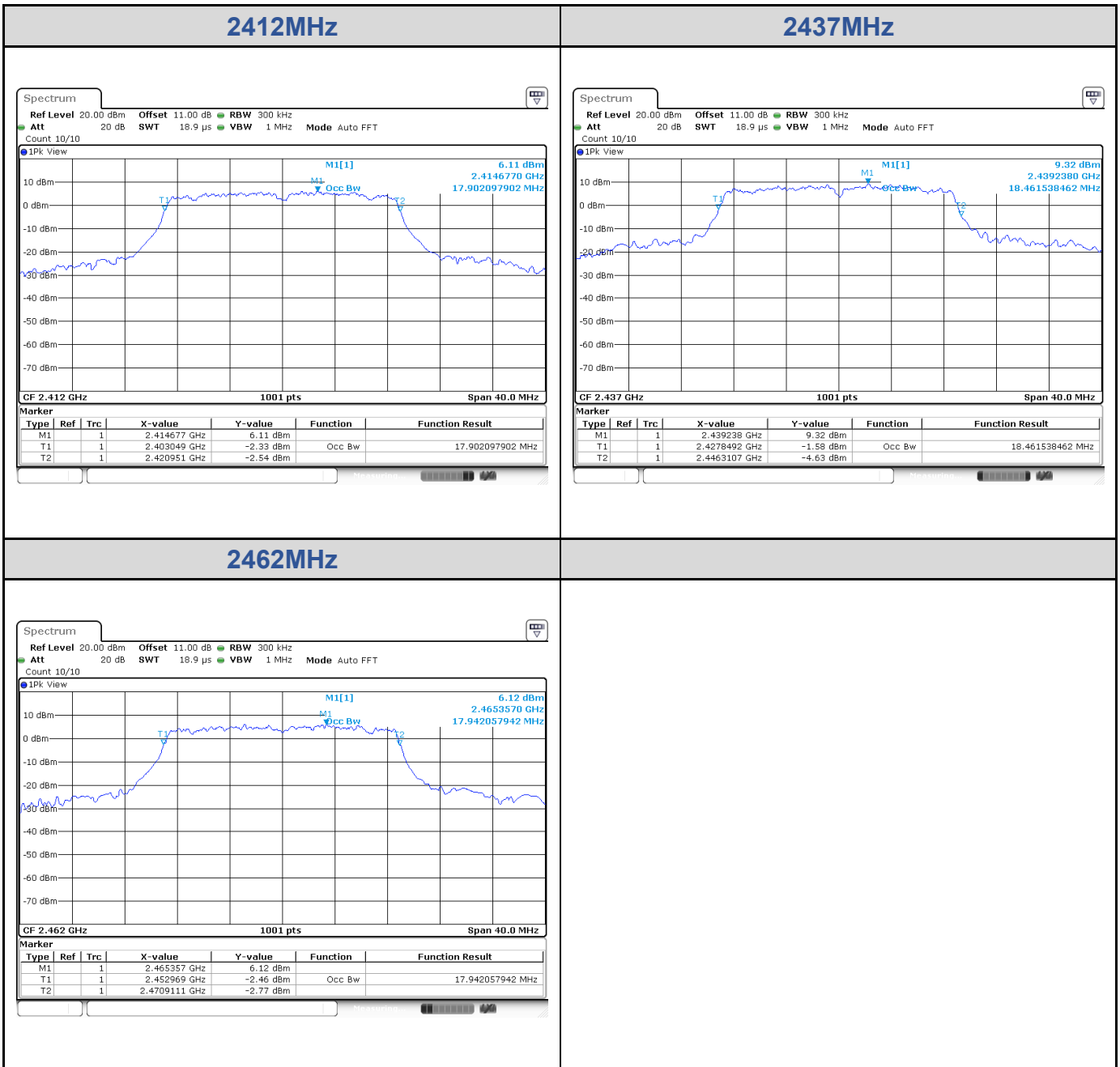

**802.11n HT40**

Channel	Channel Frequency (MHz)	99% Bandwidth (MHz)
CH03	2422	35.96
CH06	2437	36.04
CH09	2452	35.96

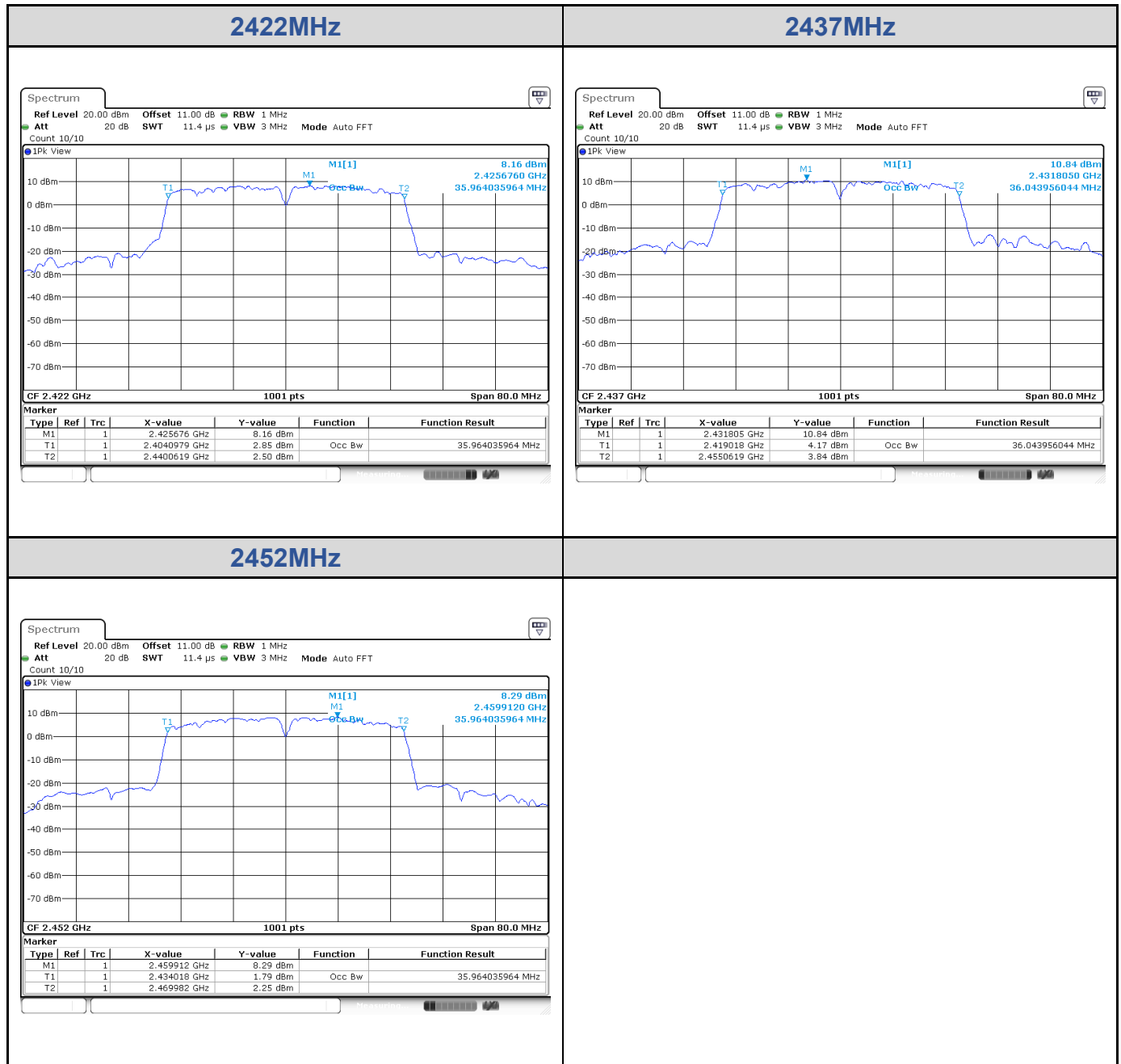

## Test Result of Power Spectral Density

### 802.11b

Channel	Channel Frequency (MHz)	Power Density (dBm/10kHz)	Limit (dBm/3kHz)
CH01	2412	-4.13	8
CH02	2417	-8.59	8
CH06	2437	-8.19	8
CH11	2462	-8.94	8

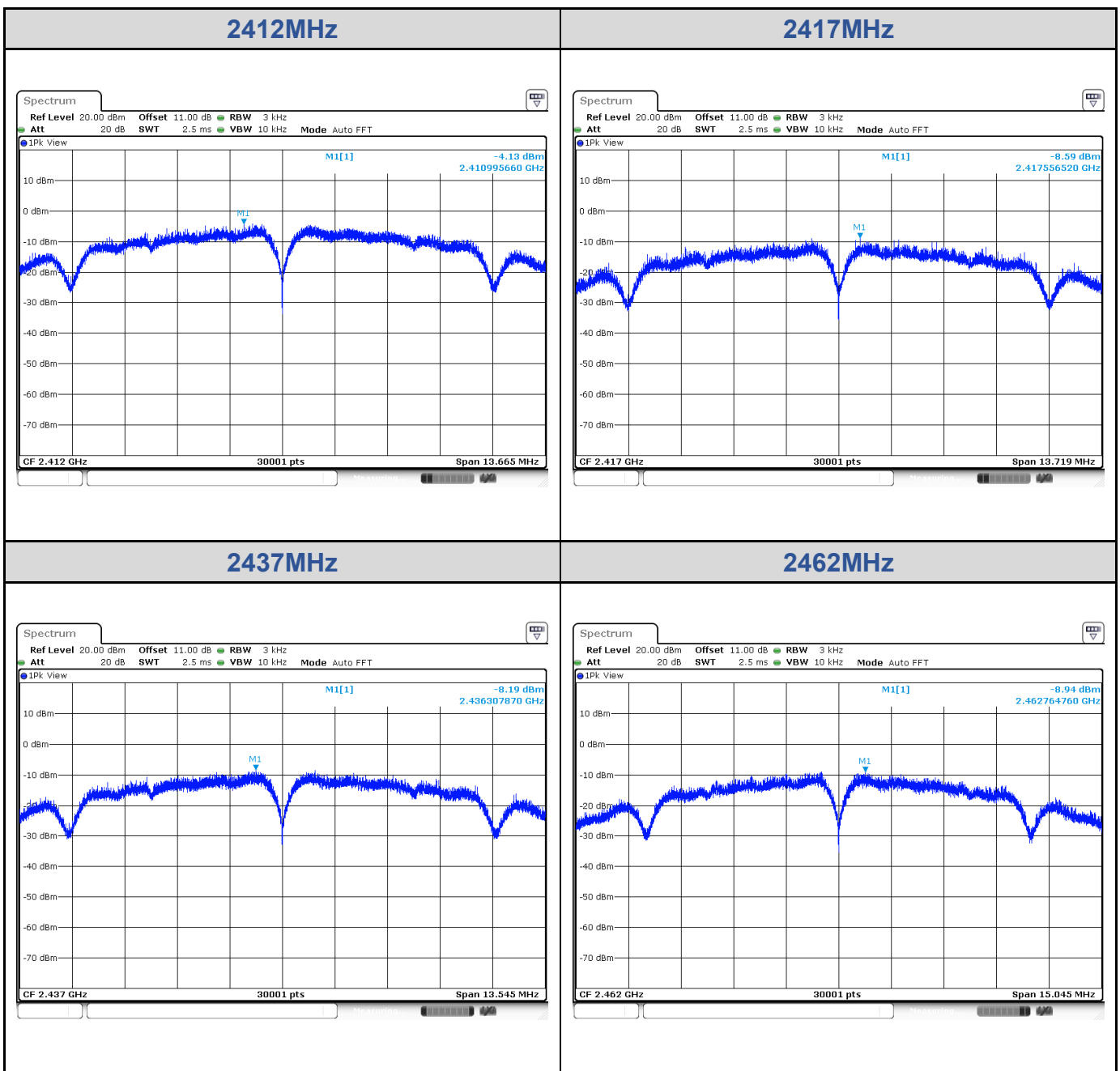

**802.11g**

Channel	Channel Frequency (MHz)	Power Density (dBm/10kHz)	Limit (dBm/3kHz)
CH01	2412	-10.33	8
CH06	2437	-7.16	8
CH11	2462	-8.84	8

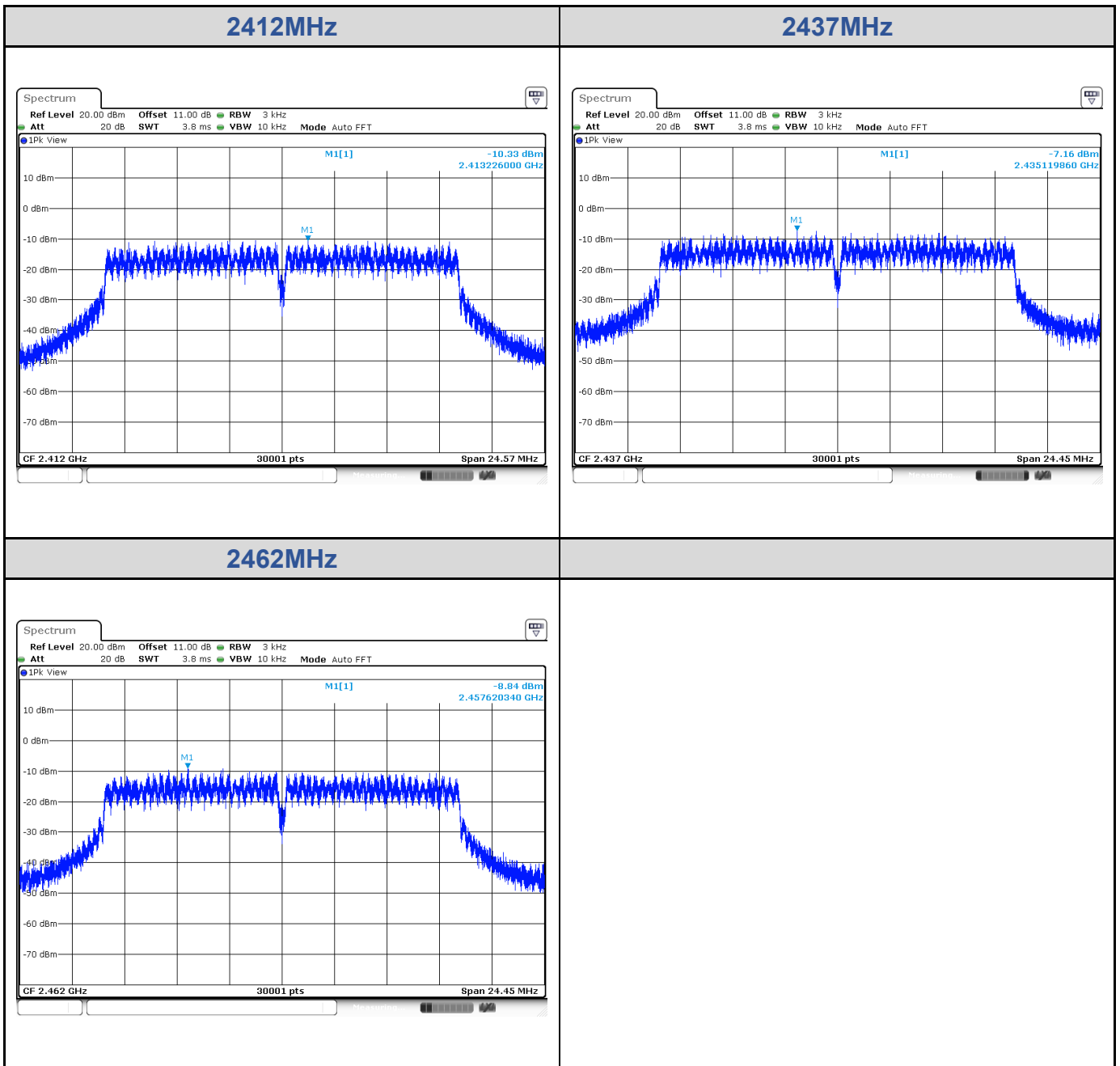

**802.11n HT20**

Channel	Channel Frequency (MHz)	Power Density (dBm/10kHz)	Limit (dBm/3kHz)
CH01	2412	-9.20	8
CH06	2437	-7.06	8
CH11	2462	-10.89	8

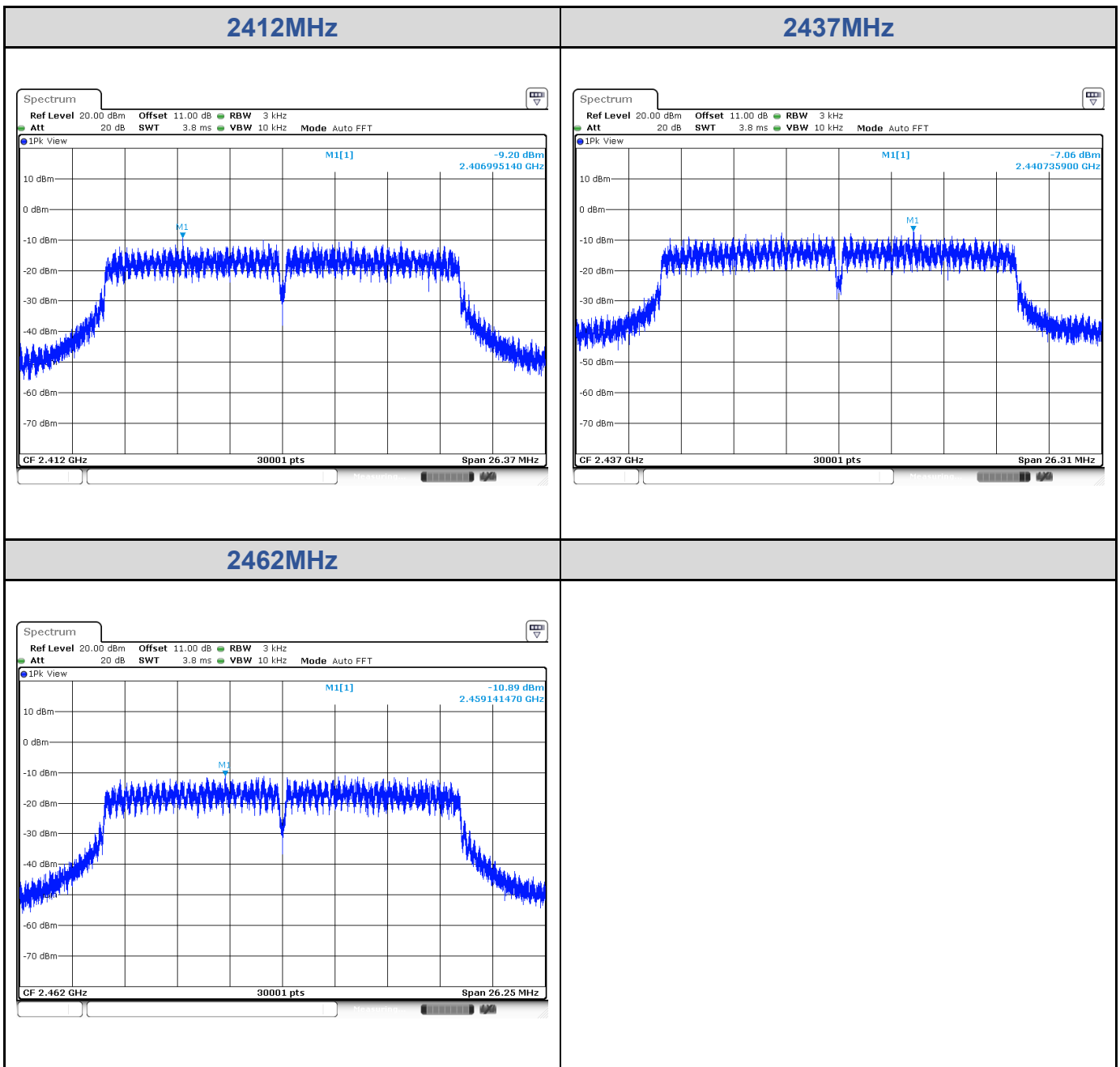



**802.11n HT40**

Channel	Channel Frequency (MHz)	Power Density (dBm/10kHz)	Limit (dBm/3kHz)
CH03	2422	-14.05	8
CH06	2437	-11.09	8
CH09	2452	-13.85	8

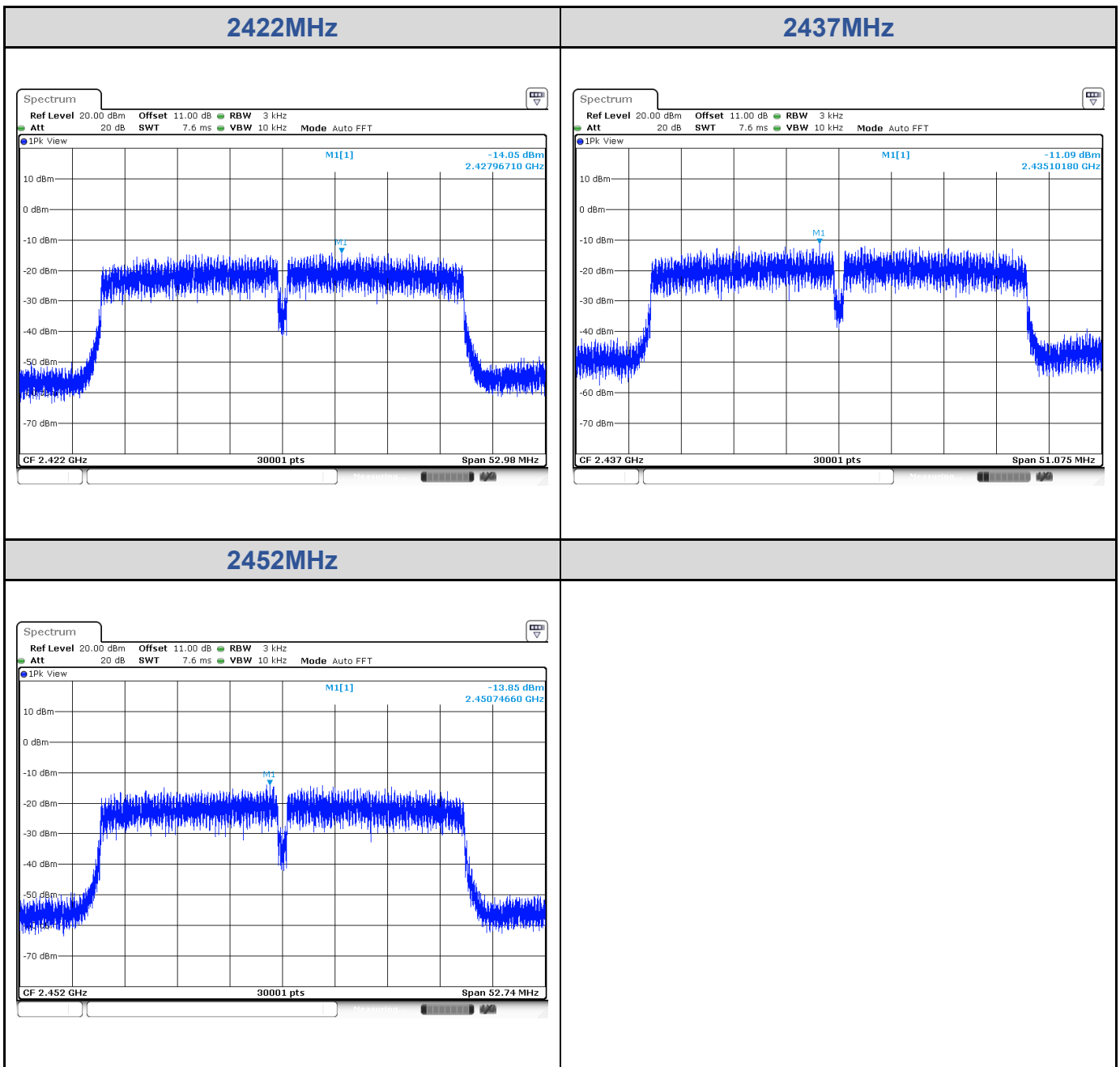

## Test Result of Conducted Spurious Emissions

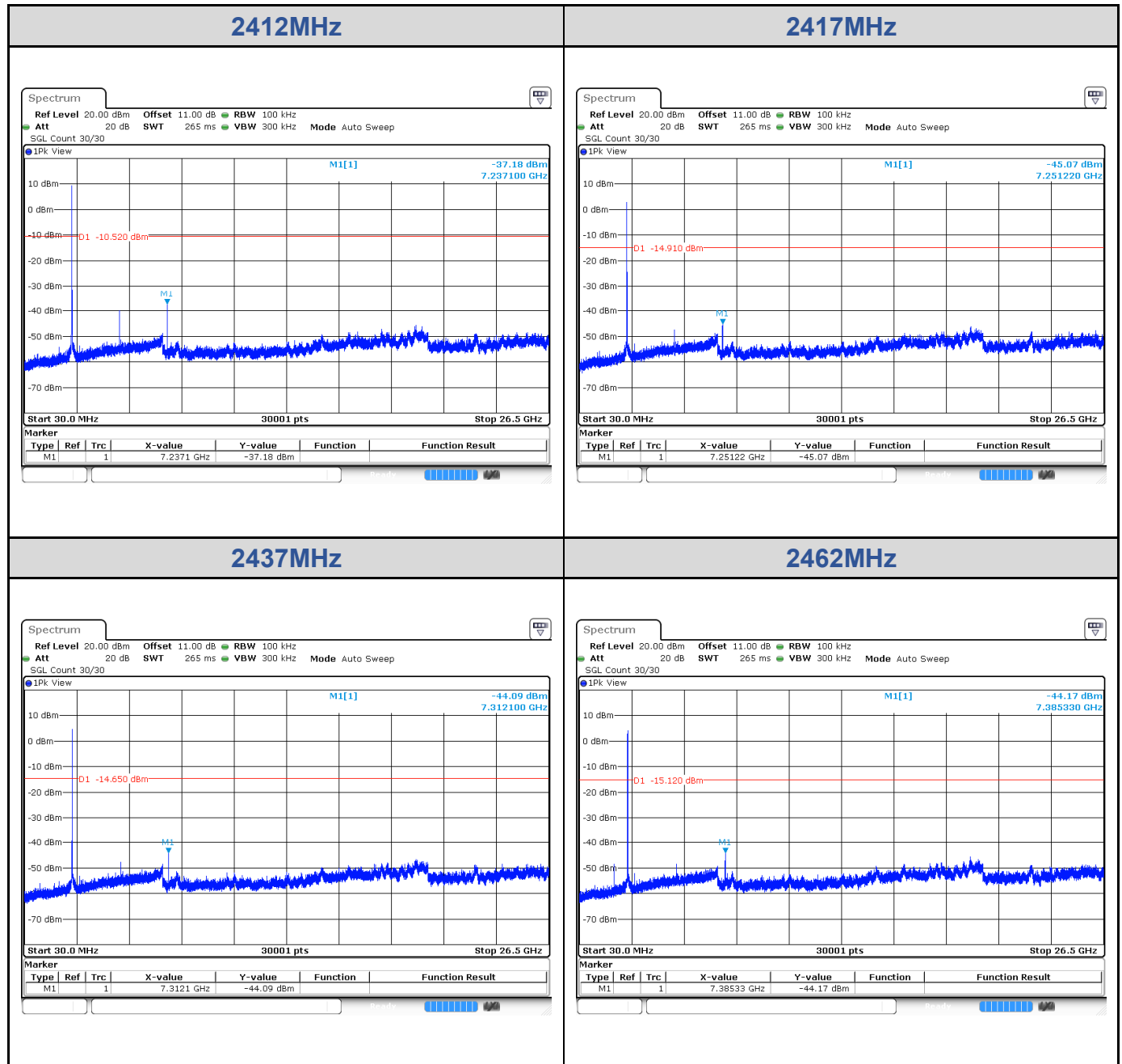
**802.11b**

802.11g

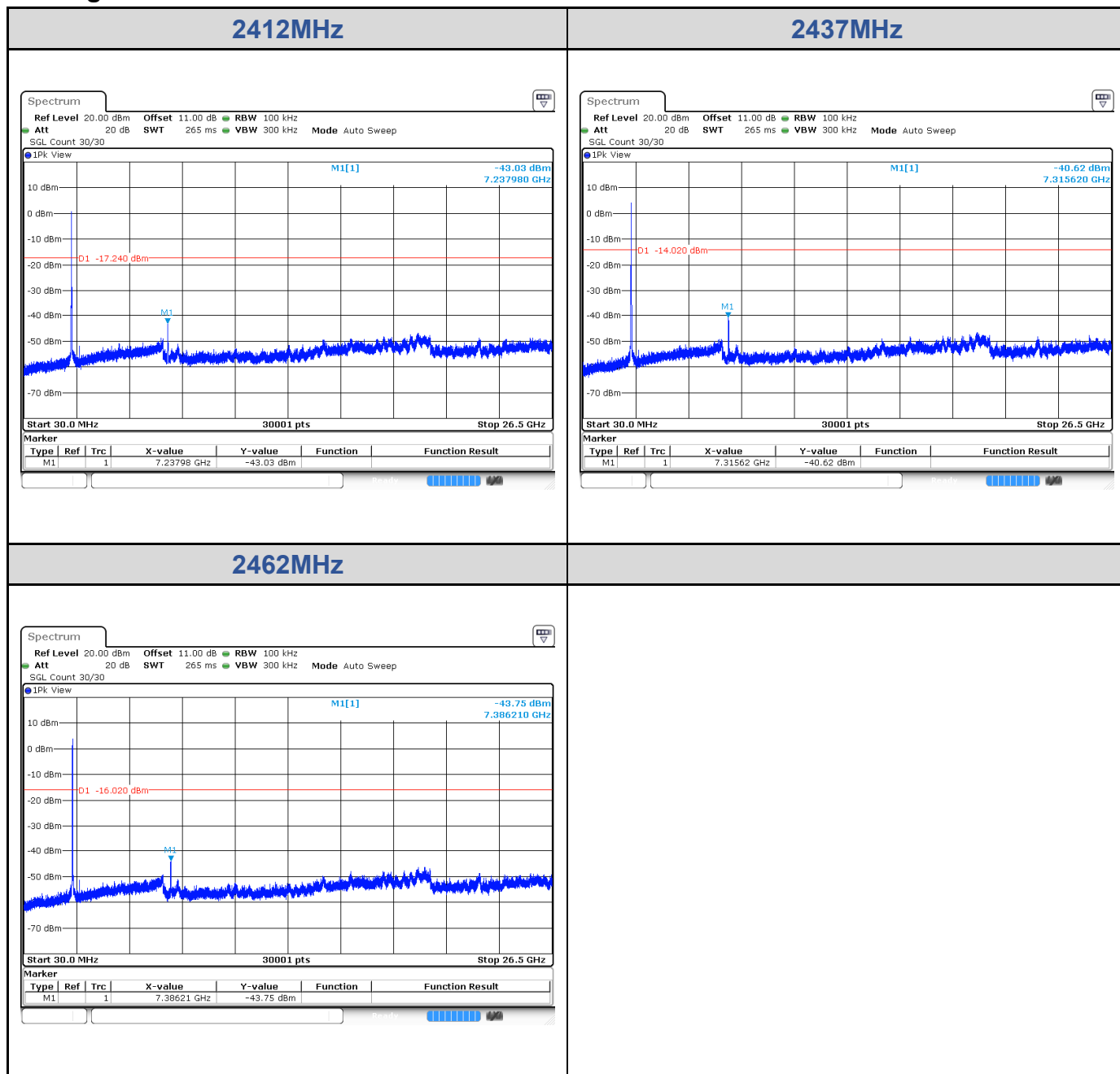

802.11n HT20

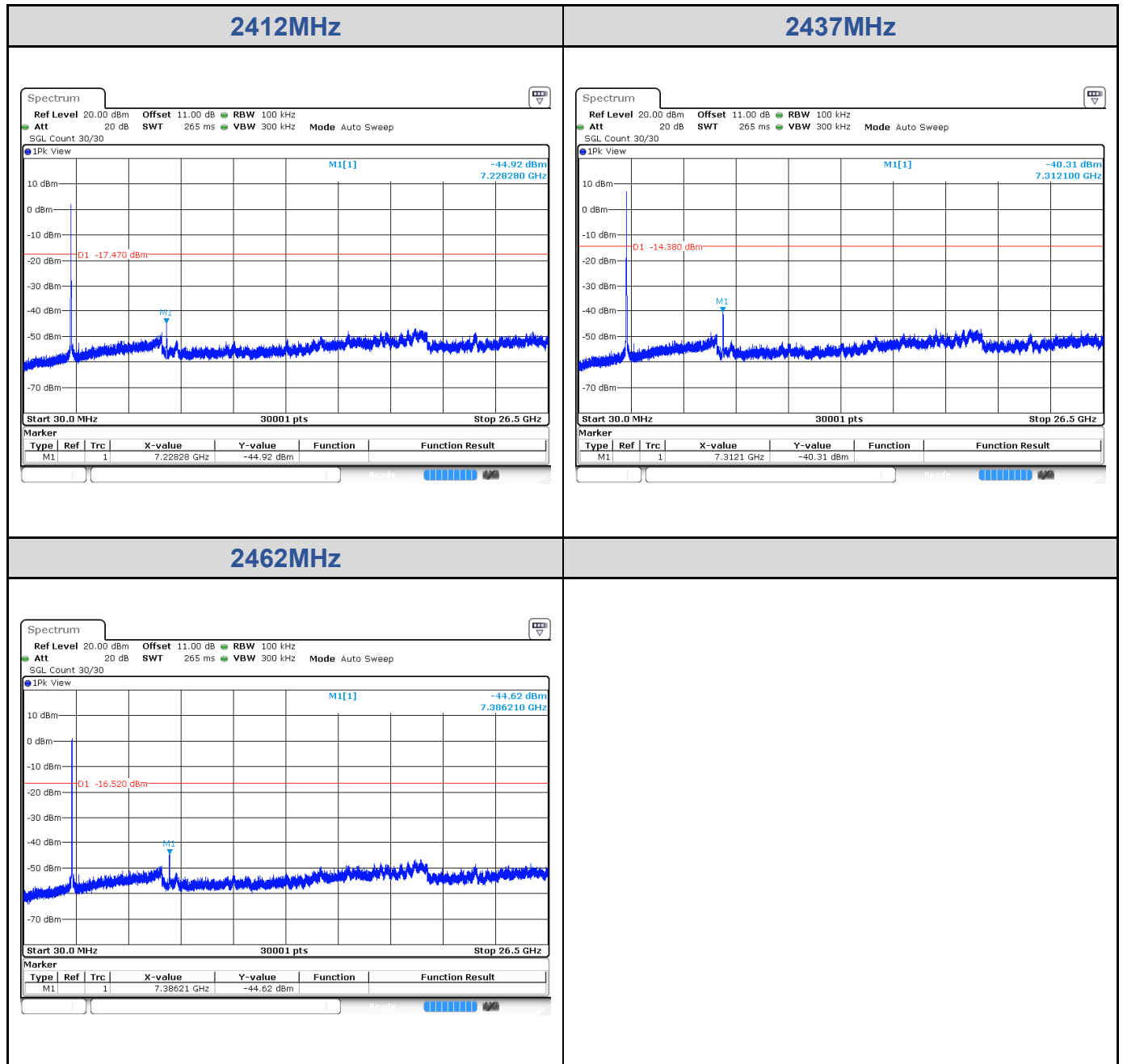

802.11n HT40

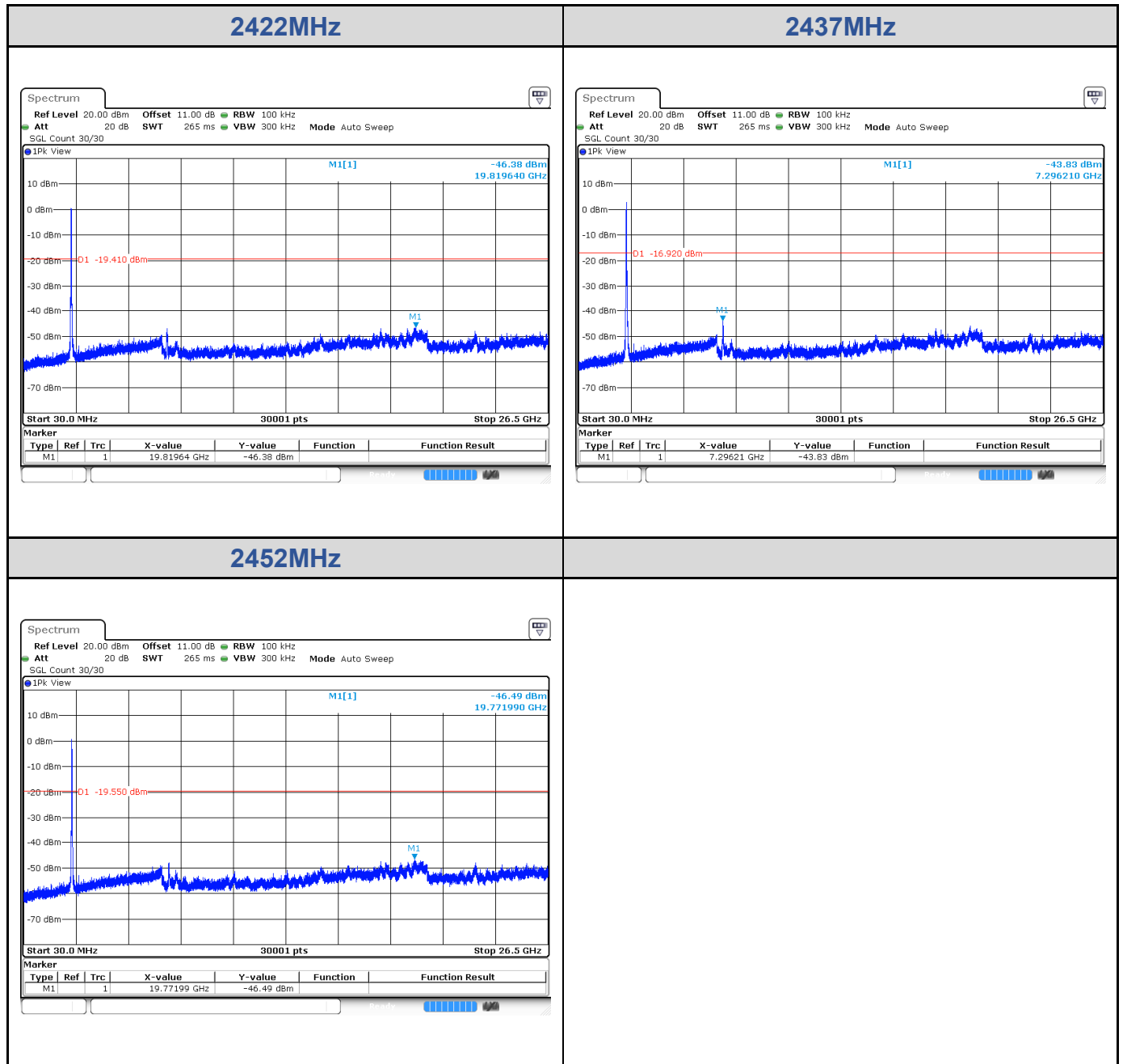

Test Result of Conducted Bandedge, Tx Mode  
802.11b

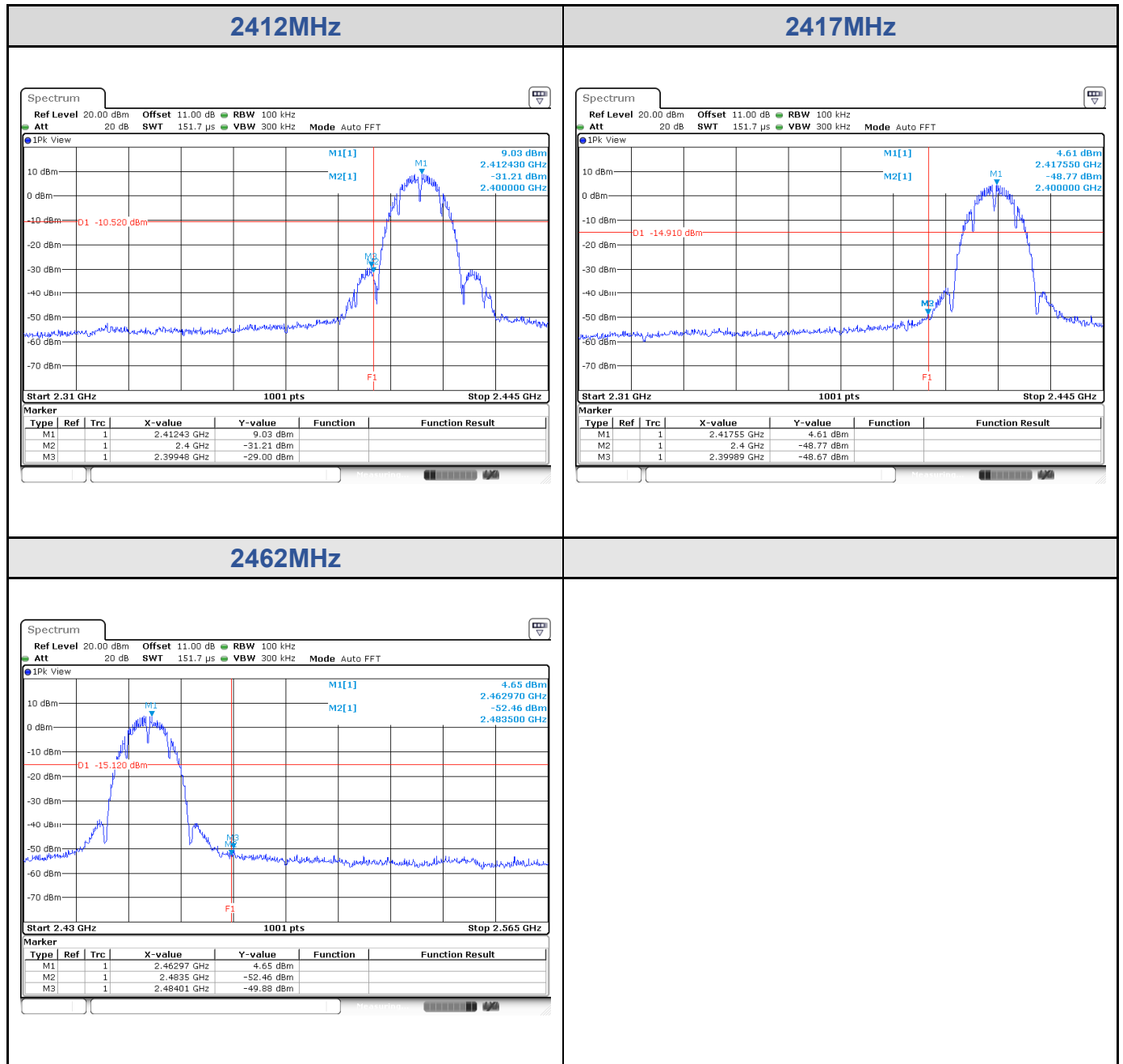

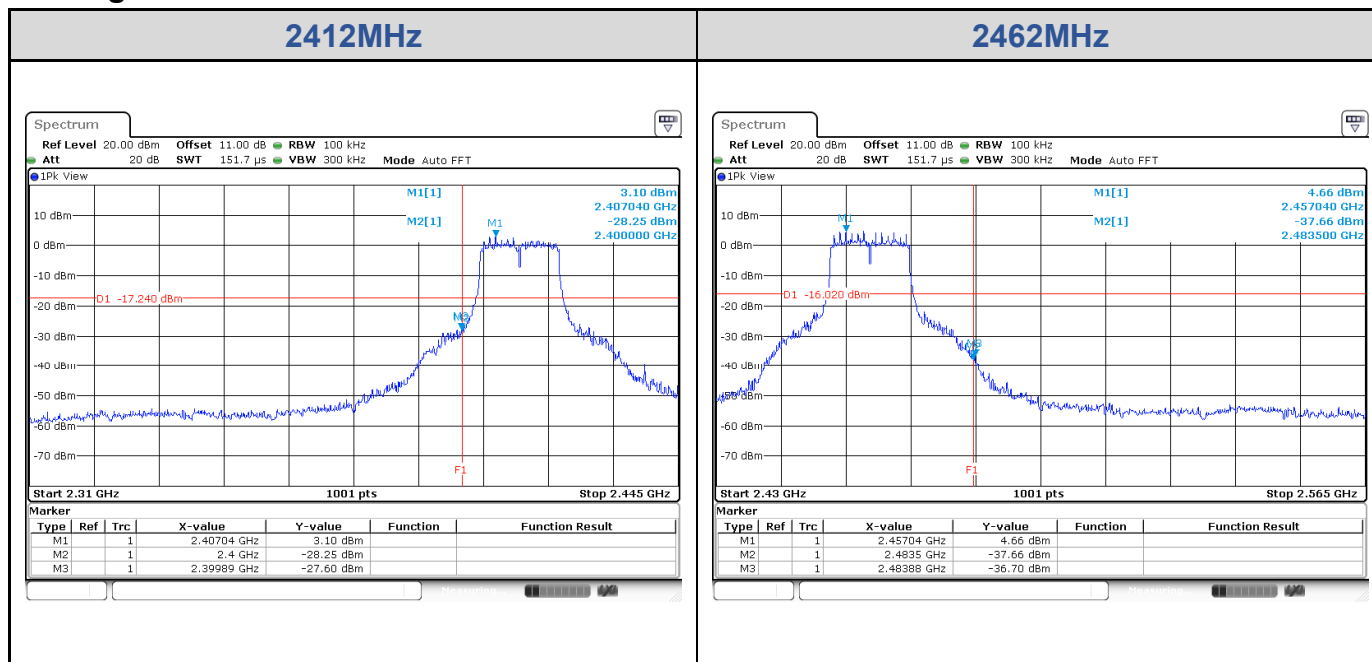
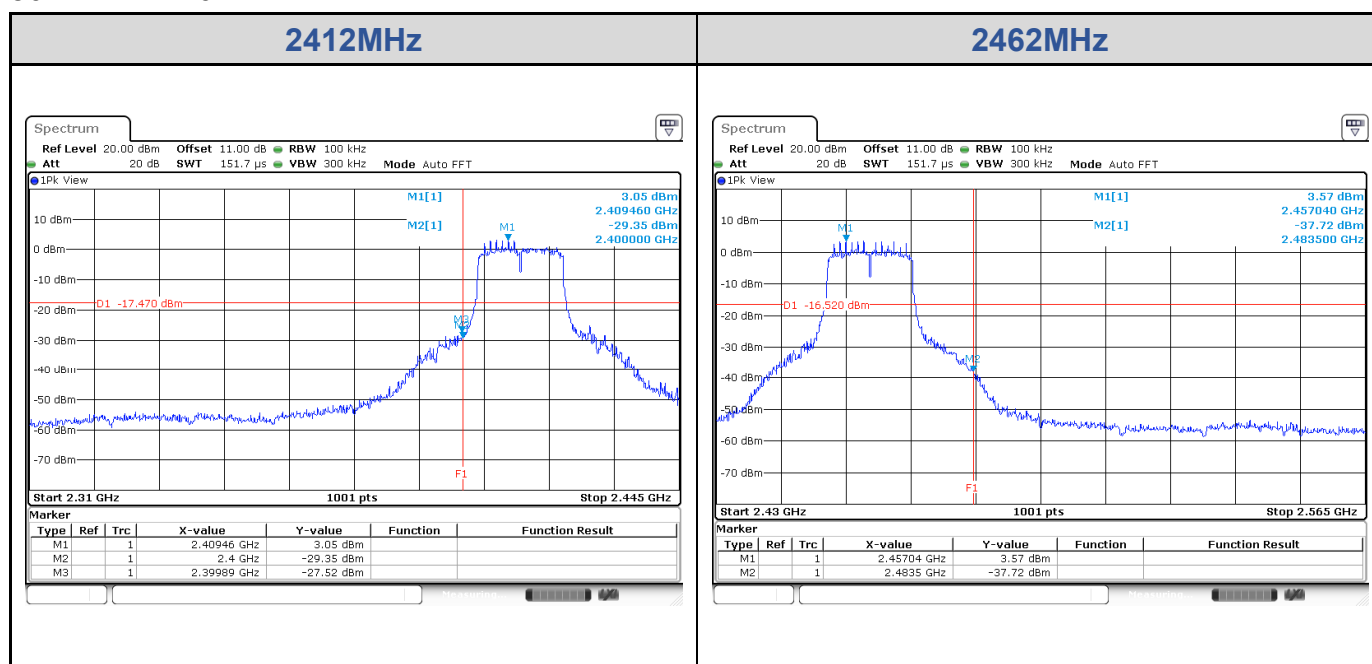
**802.11g**

**802.11n HT20**

802.11n HT40

