



SETUP PHOTOS EXHIBIT

Report Number: R13708588-EP1

Applicant : Ademco Inc.
251 Little Falls Dr.
Wilmington, DE, 19808, U.S.A

Model : TH6220WF2006

FCC ID : HS9-TH6220WF01

IC : 573R-TH6220WF01

EUT Description : Wifi Thermostat

Test Standard(s) : FCC 47 CFR PART 15 SUBPART C: 2021
ISED RSS-247 ISSUE 2: 2017
ISED RSS-GEN ISSUE 5 + A2: 2021

Date Of Issue:
2021-10-01

Prepared by:
UL LLC
12 Laboratory Dr.
Research Triangle Park, NC 27709 U.S.A.
TEL: (919) 549-1400



REPORT REVISION HISTORY

Rev.	Issue Date	Revisions	Revised By
V1	2021-05-27	Initial Issue	Haley Ackun
V2	2021-10-01	Updated FCC/IC IDs	Haley Ackun

TABLE OF CONTENTS

REPORT REVISION HISTORY	2
TABLE OF CONTENTS	3
1. SETUP DIAGRAMS	4
2. SETUP PHOTOS.....	5
END OF TEST REPORT	13

1. SETUP DIAGRAMS

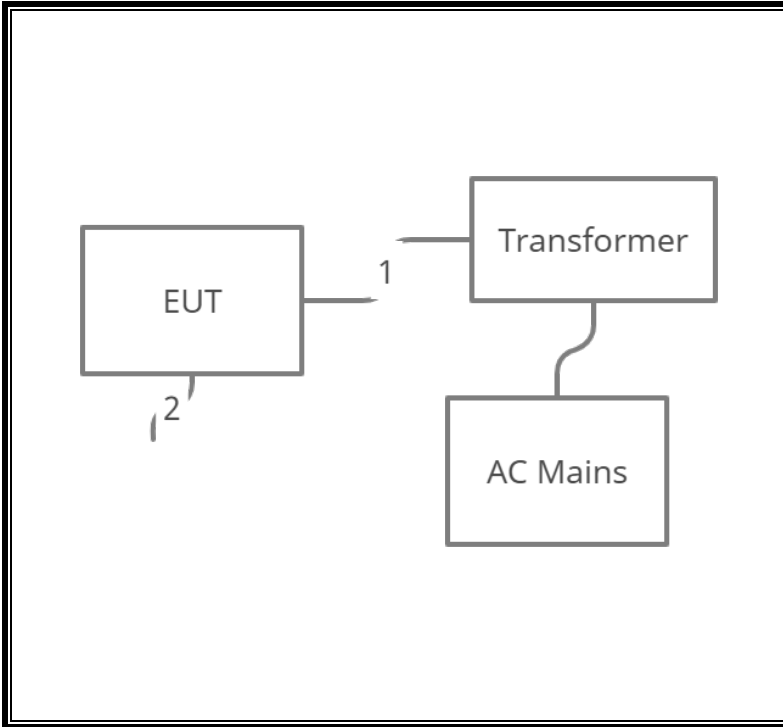

Note: Cable 2 is a UART cable used for configuration only. This cable was not populated during testing.

2. SETUP PHOTOS

CONDUCTED MEASUREMENT SETUP

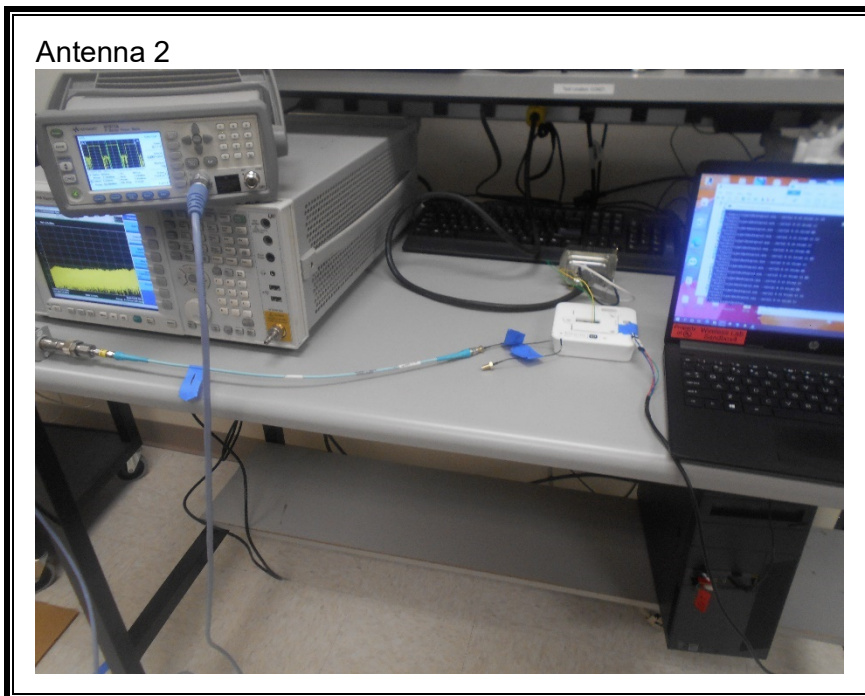
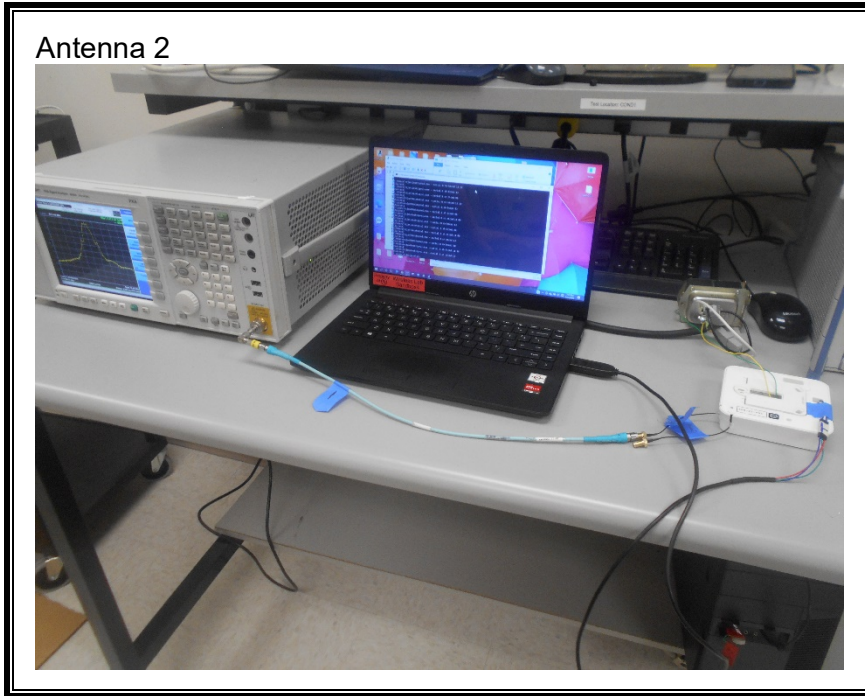

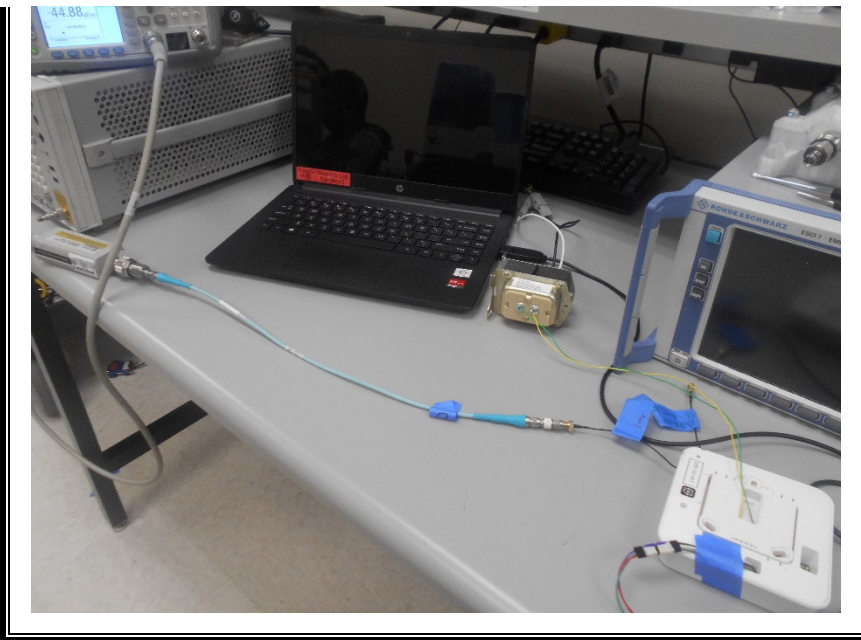
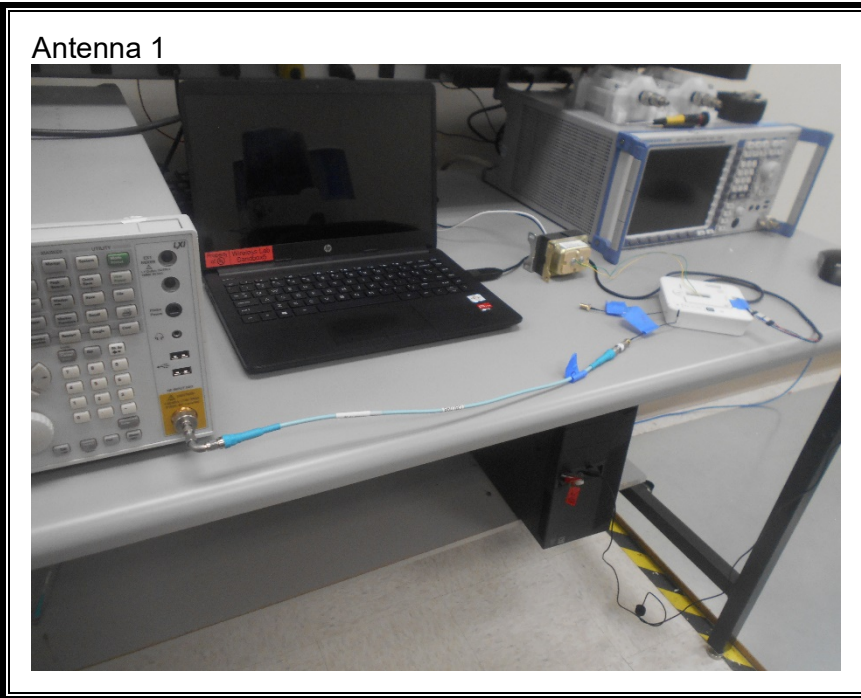

RADIATED RF MEASUREMENT SETUP

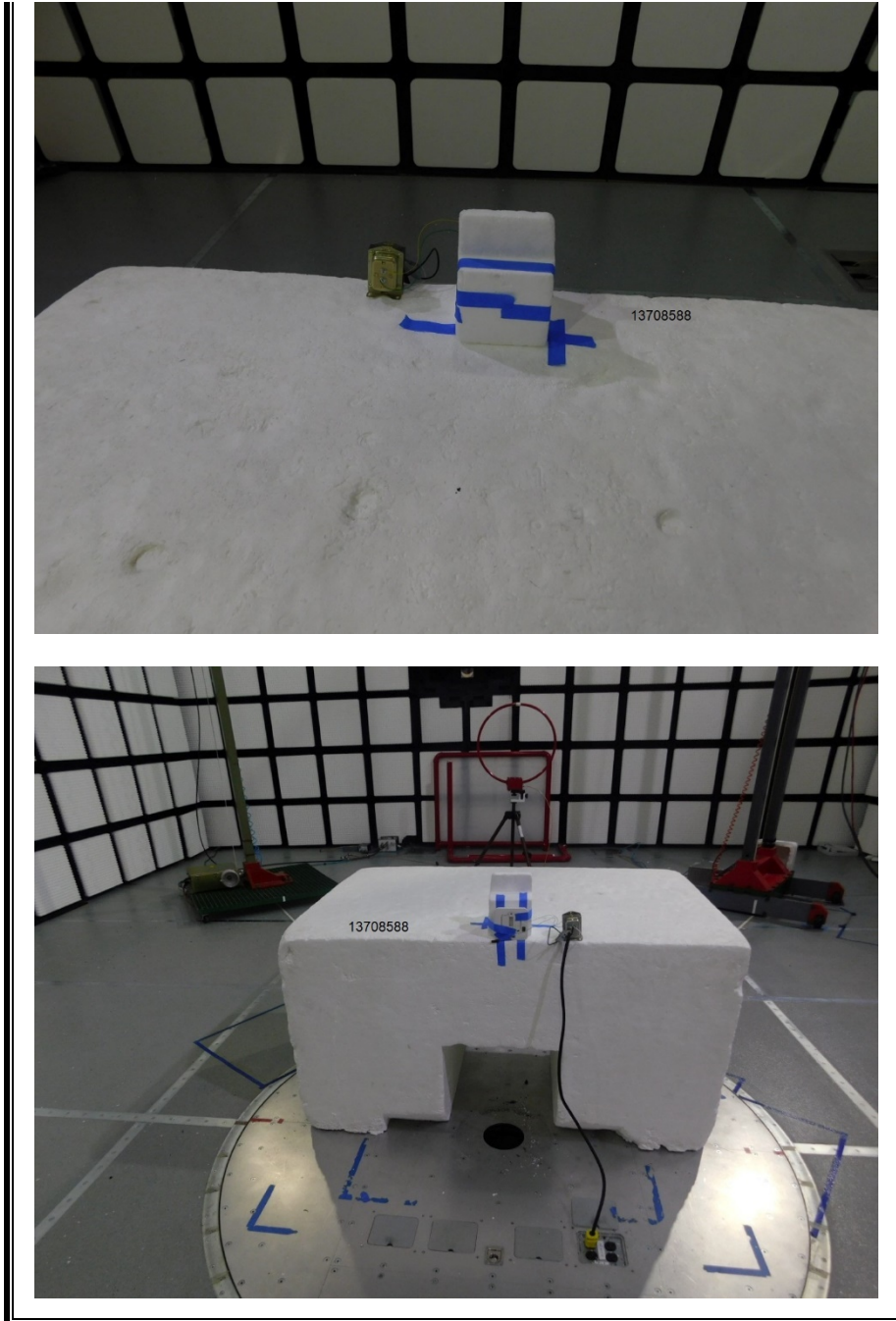

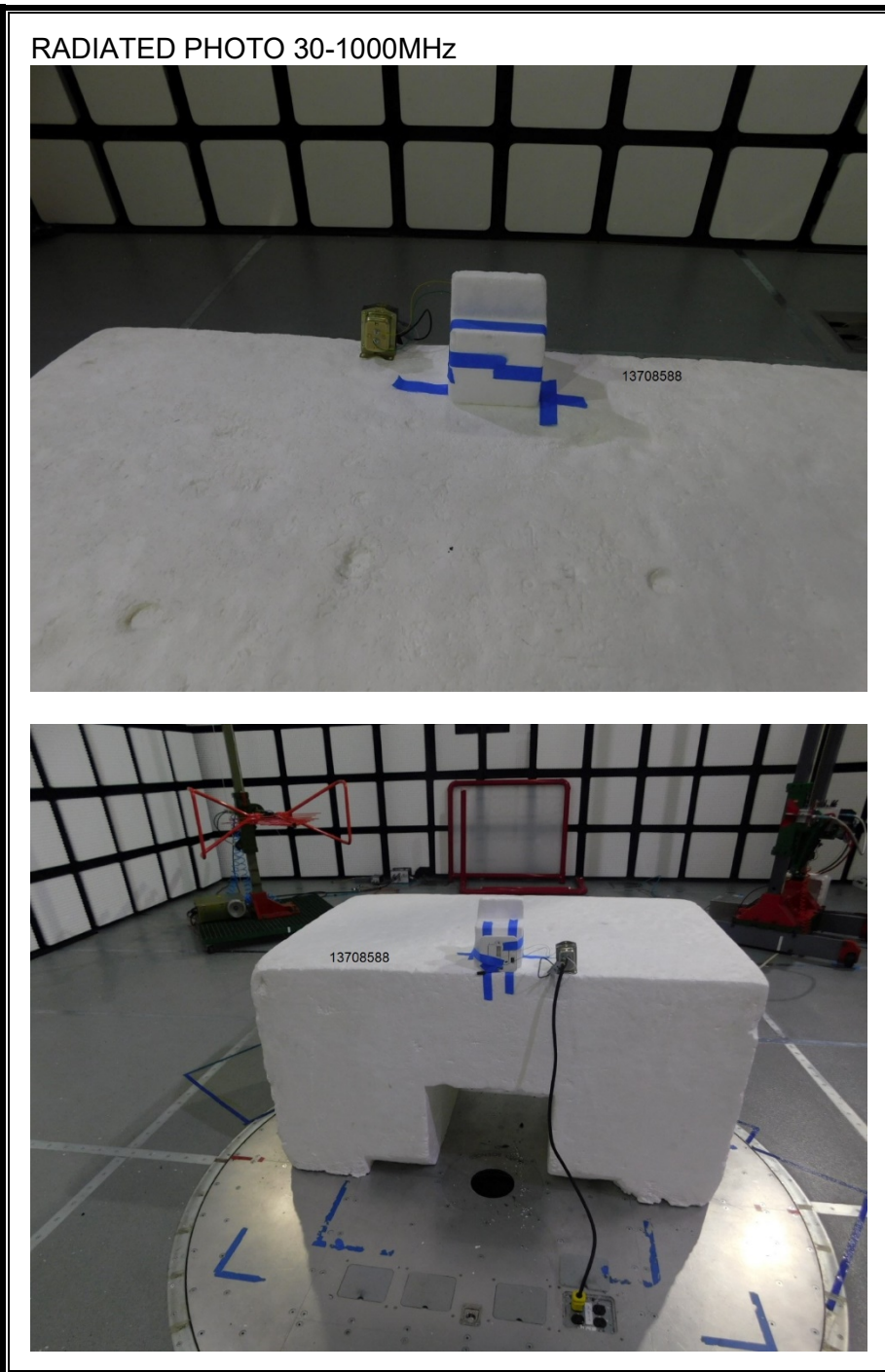

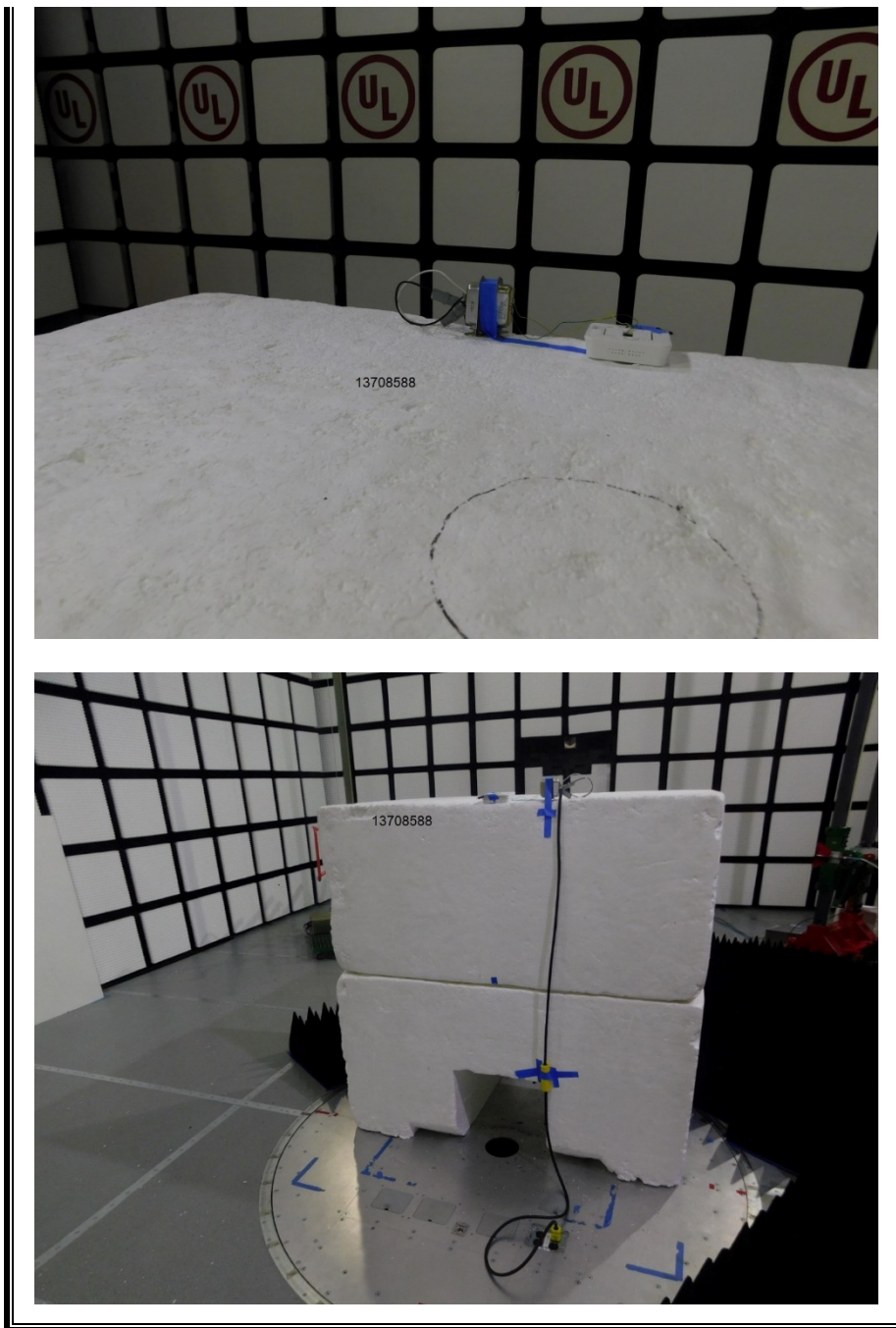

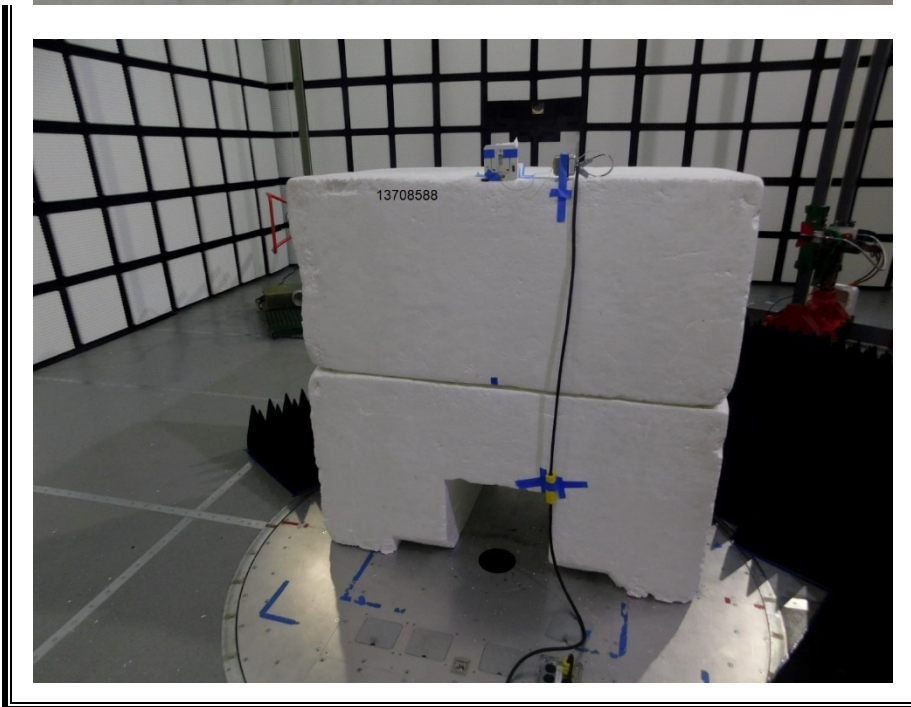
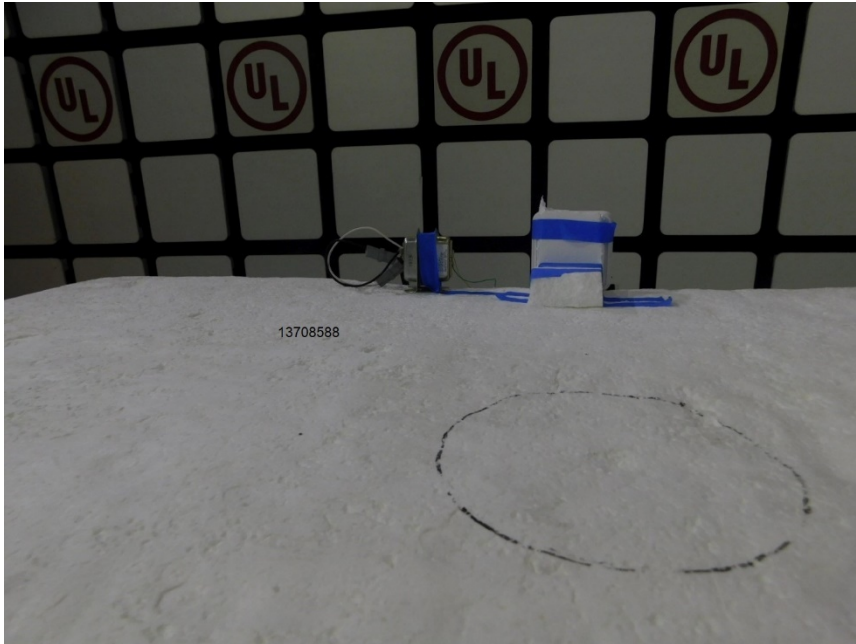

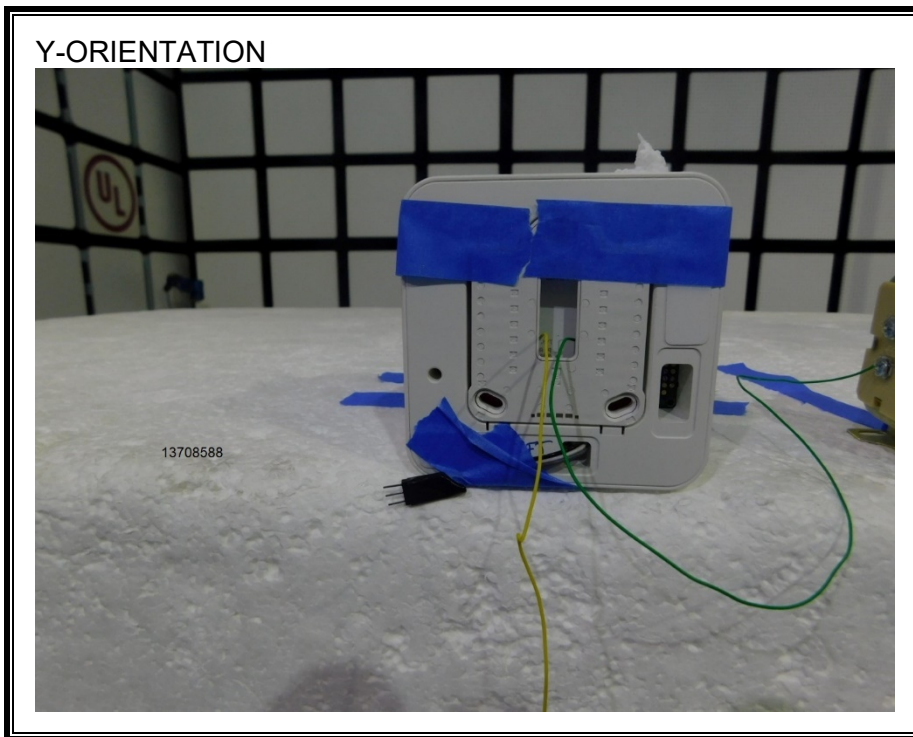
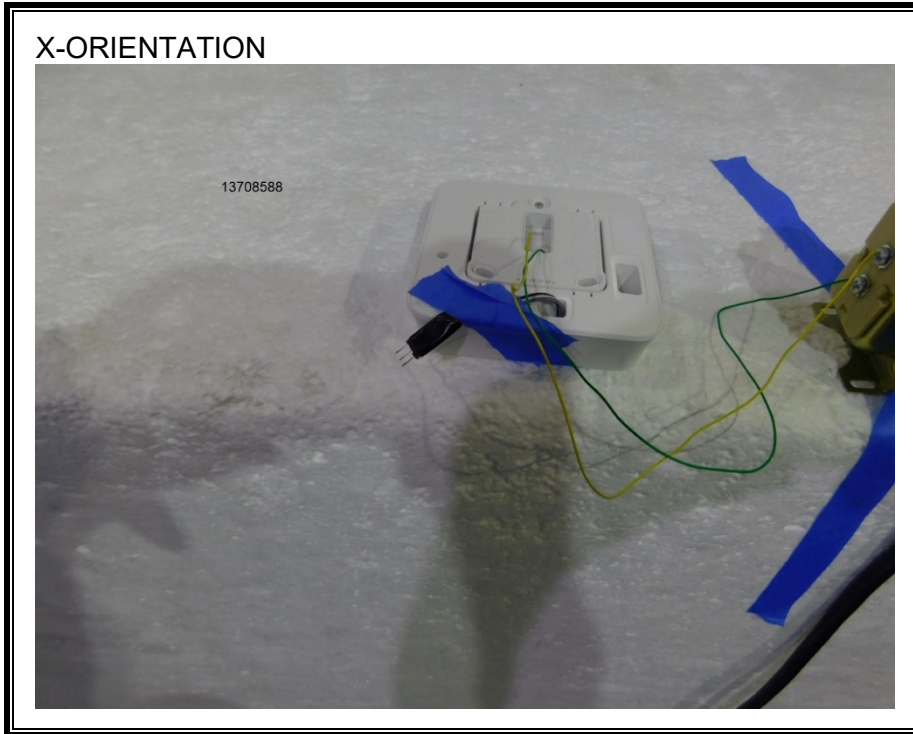

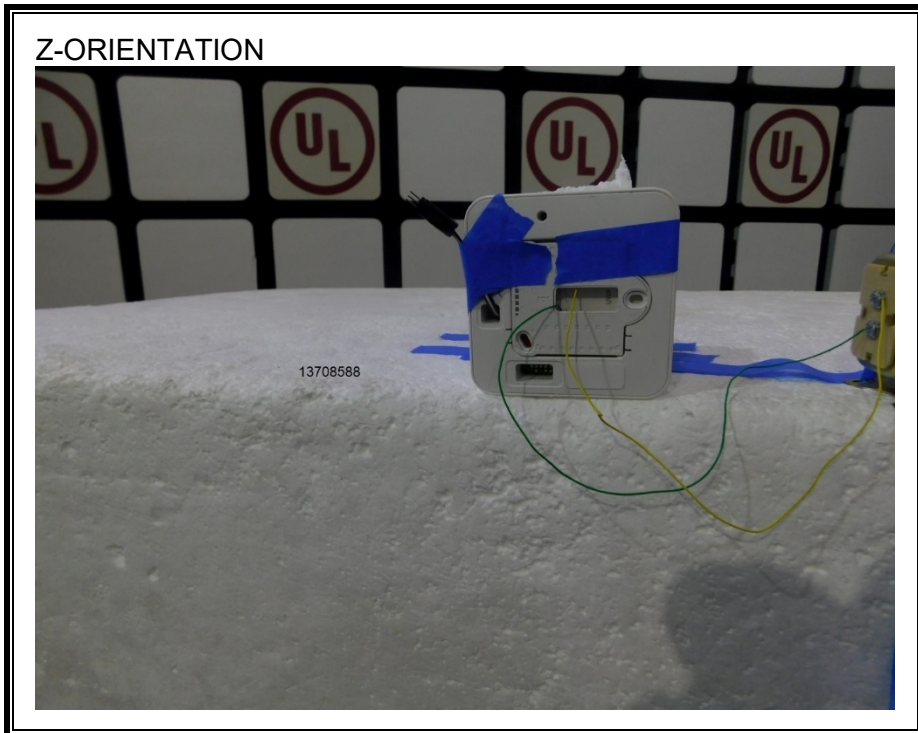

AC MAINS LINE CONDUCTED MEASUREMENT SETUP

