



RF TEST REPORT

Applicant Ademco Inc.
FCC ID HS9-C7189W00
Product C7189WS1000
Model C7189WS1000
Marketing C7189WS1000,MSENSOR,
Smart Room Sensor
Report No. R1911A0662-R1V2
Issue Date July 21, 2020

TA Technology (Shanghai) Co., Ltd. tested the above equipment in accordance with the requirements in **FCC CFR47 Part 15C (2019)**. The test results show that the equipment tested is capable of demonstrating compliance with the requirements as documented in this report.

Performed by: Peng Tao

Approved by: Kai Xu

TA Technology (Shanghai) Co., Ltd.

No.145, Jintang Rd, Tangzhen Industry Park, Pudong Shanghai, China

TEL: +86-021-50791141/2/3

FAX: +86-021-50791141/2/3-8000



TABLE OF CONTENT

1. Test Laboratory	4
1.1. Notes of the test report.....	4
1.2. Test facility	4
1.3. Testing Location.....	4
2. General Description of Equipment under Test.....	5
3. Applied Standards	6
4. Test Configuration	7
5. Test Case Results	8
5.1. Maximum output power	8
5.2. 99% Bandwidth and 6dB Bandwidth	12
5.3. Band Edge	23
5.4. Power Spectral Density	26
5.5. Spurious RF Conducted Emissions.....	33
5.6. Unwanted Emission	40
6. Main Test Instruments.....	53



Summary of measurement results

Number	Test Case	Clause in FCC rules	Verdict
1	Maximum conducted output power	15.247(b)(3)	PASS
2	6 dB bandwidth	15.247(a)(2)	Refer to the report(Report No.: R1908A0486-R1V1)
3	Power spectral density	15.247(e)	Refer to the report(Report No.: R1908A0486-R1V1)
4	Band Edge	15.247(d)	Refer to the report(Report No.: R1908A0486-R1V1)
5	Spurious RF Conducted Emissions	15.247(d)	Refer to the report(Report No.: R1908A0486-R1V1)
6	Unwanted Emissions	15.247(d),15.205,15.209	PASS
7	Conducted Emissions	15.207	NA
Date of Testing: August 27, 2019 ~October 18, 2019 and January 13, 2020 ~ June 23, 2020			
<p>Note: NA=Not Applicable</p> <p>All indications of Pass/Fail in this report are opinions expressed by TA Technology (Shanghai) Co., Ltd. based on interpretations and/or observations of test results. Measurement Uncertainties were not taken into account and are published for informational purposes only.</p>			

Note: This revised report (Report No.: R1911A0662-R1V2) supersedes and replaces the previously issued report (Report No.: R1911A0662-R1V1). Please discard or destroy the previously issued report and dispose of it accordingly.

There is only tested Conducted Power(FEM HIGH EFFICIENCY MODE) and Unwanted Emissions in this report. For other Conducted test results, please refers to the module report(Report No.: R1908A0486-R1V1).



1. Test Laboratory

1.1. Notes of the test report

This report shall not be reproduced in full or partial, without the written approval of **TA technology (shanghai) co., Ltd.** The results documented in this report apply only to the tested sample, under the conditions and modes of operation as described herein .Measurement Uncertainties were not taken into account and are published for informational purposes only. This report is written to support regulatory compliance of the applicable standards stated above.

1.2. Test facility

FCC (Designation number: CN1179, Test Firm Registration Number: 446626)

TA Technology (Shanghai) Co., Ltd. has been listed on the US Federal Communications Commission list of test facilities recognized to perform electromagnetic emissions measurements.

A2LA (Certificate Number: 3857.01)

TA Technology (Shanghai) Co., Ltd. has been listed by American Association for Laboratory Accreditation to perform electromagnetic emission measurement.

1.3. Testing Location

Company: TA Technology (Shanghai) Co., Ltd.
Address: No.145, Jintang Rd, Tangzhen Industry Park, Pudong
City: Shanghai
Post code: 201201
Country: P. R. China
Contact: Xu Kai
Telephone: +86-021-50791141/2/3
Fax: +86-021-50791141/2/3-8000
Website: <http://www.ta-shanghai.com>
E-mail: xukai@ta-shanghai.com

2. General Description of Equipment under Test

Client Information

Applicant	Ademco Inc.
Applicant address	1985 Douglas Drive, Golden, Minnesota, United States
Manufacturer	Ademco Inc.
Manufacturer address	1985 Douglas Drive, Golden, Minnesota, United States

General information

EUT Description	
Model	C7189WS1000
SN	1#
Hardware Version	R32346043-001
Software Version	V0.0.18.0
Power Supply	External Power Supply
Antenna Type	Internal Antenna
Antenna Connector	connect spec
Antenna Gain	2.3dBi
Test Mode	Bluetooth V5.0 LE
Modulation Type	BLE :GFSK
Max. Conducted Power	BLE : 20.21dBm
Operating Frequency Range(s)	BLE: 2402 ~2480 MHz
Note: The information of the EUT is declared by the manufacturer.	

3. Applied Standards

According to the specifications of the manufacturer, it must comply with the requirements of the following standards:

Test standards

- **FCC CFR47 Part 15C (2019) Radio Frequency Devices**
- **ANSI C63.10 (2013)**
- **KDB 558074 D01 15.247 Meas Guidance v05r02**

4. Test Configuration

Test Mode

The EUT has been associated with peripherals and configuration operated in a manner tended to maximize its emission characteristics in a typical application.

The radiated emission was measured in the following position: EUT stand-up position (Z axis), lie-down position (X, Y axis). The worst emission was found in lie-down position (X axis) and the loop antenna is vertical, the others are vertical and horizontal. and the worst case was recorded.

In order to find the worst case condition, Pre-tests are needed at the presence of different data rate. Preliminary tests have been done on all the configuration for confirming worst case. Data rate below means worst-case rate of each test item.

Worst-case data rates are shown as following table.

Band	Data Rate
Bluetooth(Low Energy) V5.0	2Mbps
Bluetooth(Low Energy) V5.0	1Mbps
Bluetooth(Low Energy) V5.0	125Kbps

5. Test Case Results

5.1. Maximum output power

Ambient condition

Temperature	Relative humidity	Pressure
23°C ~25°C	45%~50%	101.5kPa

Methods of Measurement

During the process of the testing, The EUT was connected to Power meter with a known loss. The EUT is max power transmission with proper modulation. The signal transmission is continuous.

Test Setup

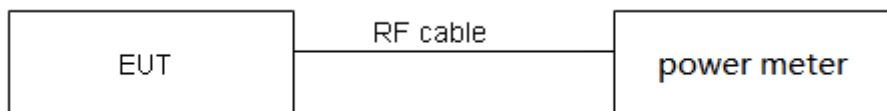

Limits

Rule Part 15.247 (b) (3) specifies that " For systems using digital modulation in the 902–928 MHz, 2400–2483.5 MHz: 1 Watt."

Average Output Power	$\leq 1W$ (30dBm)
----------------------	-------------------

Measurement Uncertainty

The assessed measurement uncertainty to ensure 95% confidence level for the normal distribution is with the coverage factor $k = 2$, $U = 0.44$ dB.

Test Results

Antenna 1

(BLE V5.0-1M FEM HIGH EFFICIENCY MODE)

Band	T _{on} (ms)	T _(on+off) (ms)	Duty cycle	Duty cycle correction Factor(dB)
BLE	0.35	1.55	0.226	6.463
Note: when Duty cycle>0.98, Duty cycle correction Factor not required.				

Network Standards	Carrier frequency (MHz)	Average Power Measured (dBm)	Average Power with duty factor (dBm)	Limit (dBm)	Conclusion
Bluetooth (Low Energy)	2402	12.06	18.52	30	PASS
	2440	12.95	19.41	30	PASS
	2480	12.30	18.76	30	PASS
Note: Average Power with duty factor = Average Power Measured +Duty cycle correction factor					

(BLE V5.0-2M FEM HIGH EFFICIENCY MODE)

Band	T _{on} (ms)	T _(on+off) (ms)	Duty cycle	Duty cycle correction Factor(dB)
BLE	0.18	1.38	0.132	8.784
Note: when Duty cycle>0.98, Duty cycle correction Factor not required.				

Network Standards	Carrier frequency (MHz)	Average Power Measured (dBm)	Average Power with duty factor (dBm)	Limit (dBm)	Conclusion
Bluetooth (Low Energy)	2402	10.77	19.55	30	PASS
	2440	11.43	20.21	30	PASS
	2480	10.86	19.64	30	PASS
Note: Average Power with duty factor = Average Power Measured +Duty cycle correction factor					

(BLE V5.0-125K FEM HIGH EFFICIENCY MODE)

Band	T _{on} (ms)	T _(on+off) (ms)	Duty cycle	Duty cycle correction Factor(dB)
BLE	2.65	3.97	0.668	1.752
Note: when Duty cycle>0.98, Duty cycle correction Factor not required.				

Network Standards	Carrier frequency (MHz)	Average Power Measured (dBm)	Average Power with duty factor (dBm)	Limit (dBm)	Conclusion
Bluetooth (Low Energy)	2402	11.59	13.34	30	PASS
	2440	12.52	14.27	30	PASS
	2480	12.17	13.92	30	PASS
Note: Average Power with duty factor = Average Power Measured +Duty cycle correction factor					

Antenna 2
(BLE V5.0-1M FEM HIGH EFFICIENCY MODE)

Band	T _{on} (ms)	T _(on+off) (ms)	Duty cycle	Duty cycle correction Factor(dB)
BLE	0.35	1.55	0.226	6.463
Note: when Duty cycle>0.98, Duty cycle correction Factor not required.				

Network Standards	Carrier frequency (MHz)	Average Power Measured (dBm)	Average Power with duty factor (dBm)	Limit (dBm)	Conclusion
Bluetooth (Low Energy)	2402	12.92	19.38	30	PASS
	2440	13.30	19.76	30	PASS
	2480	13.16	19.62	30	PASS
Note: Average Power with duty factor = Average Power Measured +Duty cycle correction factor					

(BLE V5.0-2M FEM HIGH EFFICIENCY MODE)

Band	T _{on} (ms)	T _(on+off) (ms)	Duty cycle	Duty cycle correction Factor(dB)
BLE	0.18	1.38	0.132	8.784
Note: when Duty cycle>0.98, Duty cycle correction Factor not required.				

Network Standards	Carrier frequency (MHz)	Average Power Measured (dBm)	Average Power with duty factor (dBm)	Limit (dBm)	Conclusion
Bluetooth (Low Energy)	2402	11.36	20.14	30	PASS
	2440	11.23	20.01	30	PASS
	2480	11.19	19.97	30	PASS
Note: Average Power with duty factor = Average Power Measured +Duty cycle correction factor					

(BLE V5.0-125K FEM HIGH EFFICIENCY MODE)

Band	T _{on} (ms)	T _(on+off) (ms)	Duty cycle	Duty cycle correction Factor(dB)
BLE	2.65	3.97	0.668	1.752
Note: when Duty cycle>0.98, Duty cycle correction Factor not required.				

Network Standards	Carrier frequency (MHz)	Average Power Measured (dBm)	Average Power with duty factor (dBm)	Limit (dBm)	Conclusion
Bluetooth (Low Energy)	2402	12.35	14.10	30	PASS
	2440	13.28	15.03	30	PASS
	2480	13.37	15.12	30	PASS
Note: Average Power with duty factor = Average Power Measured +Duty cycle correction factor					

5.2. 99% Bandwidth and 6dB Bandwidth

Ambient condition

Temperature	Relative humidity	Pressure
23°C ~25°C	45%~50%	101.5kPa

Method of Measurement

The EUT was connected to the spectrum analyzer through an external attenuator (20dB) and a known loss cable. RBW is set to 100 kHz; VBW is set to 300 kHz on spectrum analyzer. Dector=Peak, Trace mode=max hold.

Test Setup

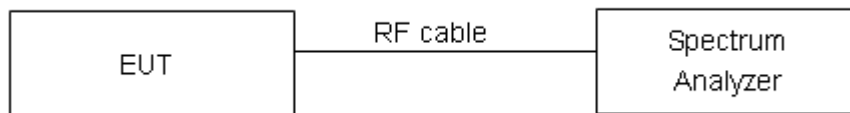

Limits

Rule Part 15.247 (a) (2) specifies that “Systems using digital modulation techniques may operate in the 902–928 MHz, 2400–2483.5 MHz bands. The minimum 6 dB bandwidth shall be at least 500 kHz.”

minimum 6 dB bandwidth	≥ 500 kHz
------------------------	-----------

Measurement Uncertainty

The assessed measurement uncertainty to ensure 95% confidence level for the normal distribution is with the coverage factor $k = 2$, $U = 936$ Hz.

Test Results:
Antenna 1
(BLE V5.0-1M FEM HIGH EFFICIENCY MODE)

Network Standards	Carrier frequency (MHz)	99% bandwidth (MHz)	Minimum 6 dB bandwidth (MHz)	Limit (kHz)	Conclusion
Bluetooth (Low Energy)	2402	1.0493	0.6717	500	PASS
	2440	1.0447	0.6837	500	PASS
	2480	1.0241	0.7031	500	PASS

(BLE V5.0-2M FEM HIGH EFFICIENCY MODE)

Network Standards	Carrier frequency (MHz)	99% bandwidth (MHz)	Minimum 6 dB bandwidth (MHz)	Limit (kHz)	Conclusion
Bluetooth (Low Energy)	2402	2.0475	1.049	500	PASS
	2440	2.0351	1.113	500	PASS
	2480	2.0117	1.192	500	PASS

(BLE V5.0-125K FEM HIGH EFFICIENCY MODE)

Network Standards	Carrier frequency (MHz)	99% bandwidth (MHz)	Minimum 6 dB bandwidth (MHz)	Limit (kHz)	Conclusion
Bluetooth (Low Energy)	2402	1.0653	0.6069	500	PASS
	2440	1.0527	0.6054	500	PASS
	2480	1.0614	0.6087	500	PASS

Antenna 2
(BLE V5.0-1M FEM HIGH EFFICIENCY MODE)

Network Standards	Carrier frequency (MHz)	99% bandwidth (MHz)	Minimum 6 dB bandwidth (MHz)	Limit (kHz)	Conclusion
Bluetooth (Low Energy)	2402	1.0476	0.6643	500	PASS
	2440	1.0342	0.6823	500	PASS
	2480	1.0303	0.6853	500	PASS

(BLE V5.0-2M FEM HIGH EFFICIENCY MODE)

Network Standards	Carrier frequency (MHz)	99% bandwidth (MHz)	Minimum 6 dB bandwidth (MHz)	Limit (kHz)	Conclusion
Bluetooth (Low Energy)	2402	2.0563	1.169	500	PASS
	2440	2.0462	1.087	500	PASS
	2480	2.0069	1.186	500	PASS

(BLE V5.0-125K FEM HIGH EFFICIENCY MODE)

Network Standards	Carrier frequency (MHz)	99% bandwidth (MHz)	Minimum 6 dB bandwidth (MHz)	Limit (kHz)	Conclusion
Bluetooth (Low Energy)	2402	1.0607	0.6035	500	PASS
	2440	1.0500	0.6048	500	PASS
	2480	1.0556	0.6079	500	PASS



Antenna 1
(BLE V5.0- FEM HIGH EFFICIENCY MODE)
99% bandwidth

BLE V5.0-1M Carrier frequency (MHz): 2402



BLE V5.0-2M Carrier frequency (MHz): 2402



BLE V5.0-1M Carrier frequency (MHz): 2440



BLE V5.0-2M Carrier frequency (MHz): 2440



BLE V5.0-1M Carrier frequency (MHz): 2480



BLE V5.0-2M Carrier frequency (MHz): 2480



BLE V5.0-125K Carrier frequency (MHz): 2402



BLE V5.0-125K Carrier frequency (MHz): 2440



BLE V5.0-125K Carrier frequency (MHz): 2480





Minimum 6 dB bandwidth

BLE V5.0-1M Carrier frequency (MHz): 2402



BLE V5.0-2M Carrier frequency (MHz): 2402



BLE V5.0-1M Carrier frequency (MHz): 2440



BLE V5.0-2M Carrier frequency (MHz): 2440



BLE V5.0-1M Carrier frequency (MHz): 2480



BLE V5.0-2M Carrier frequency (MHz): 2480



BLE V5.0-125K Carrier frequency (MHz): 2402



BLE V5.0-125K Carrier frequency (MHz): 2440



BLE V5.0-125K Carrier frequency (MHz): 2480





Antenna 2
(BLE V5.0- FEM HIGH EFFICIENCY MODE)
99% bandwidth

BLE V5.0-1M Carrier frequency (MHz): 2402



BLE V5.0-2M Carrier frequency (MHz): 2402



BLE V5.0-1M Carrier frequency (MHz): 2440



BLE V5.0-2M Carrier frequency (MHz): 2440



BLE V5.0-1M Carrier frequency (MHz): 2480



BLE V5.0-2M Carrier frequency (MHz): 2480



BLE V5.0-125K Carrier frequency (MHz): 2402



BLE V5.0-125K Carrier frequency (MHz): 2440



BLE V5.0-125K Carrier frequency (MHz): 2480





Minimum 6 dB bandwidth

BLE V5.0-1M Carrier frequency (MHz): 2402



BLE V5.0-2M Carrier frequency (MHz): 2402



BLE V5.0-1M Carrier frequency (MHz): 2440



BLE V5.0-2M Carrier frequency (MHz): 2440



BLE V5.0-1M Carrier frequency (MHz): 2480



BLE V5.0-2M Carrier frequency (MHz): 2480



BLE V5.0-125K Carrier frequency (MHz): 2402



BLE V5.0-125K Carrier frequency (MHz): 2440



BLE V5.0-125K Carrier frequency (MHz): 2480



5.3. Band Edge

Ambient condition

Temperature	Relative humidity	Pressure
23°C ~25°C	45%~50%	101.5kPa

Method of Measurement

The EUT was connected to the spectrum analyzer through an external attenuator (20dB) and a known loss cable the band edge of the lowest and highest channels were measured. The peak detector is used and RBW is set to 100 kHz and VBW is set to 300 kHz on spectrum analyzer. Spectrum analyzer plots are included on the following pages.

Test Setup

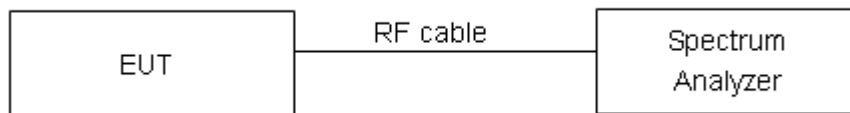

Limits

Rule Part 15.247(d) specifies that “In any 100 kHz bandwidth outside the frequency band in which the spread spectrum or digitally modulated intentional radiator is operating, the radio frequency power that is produced by the intentional radiator shall be at least 20 dB below that in the 100 kHz bandwidth within the band that contains the highest level of the desired power, based on either an RF conducted or a radiated measurement, provided the transmitter demonstrates compliance with the peak conducted power limits.” If the transmitter complies with the conducted power limits based on the use of RMS averaging over a time interval, as permitted under paragraph (b)(3) of this section, the attenuation required under this paragraph shall be 30 dB instead of 20 dB.”

Measurement Uncertainty

The assessed measurement uncertainty to ensure 95% confidence level for the normal distribution is with the coverage factor $k = 1.96$.

Frequency	Uncertainty
2GHz-3GHz	1.407 dB



Test Results: PASS

Antenna 1

(BLE V5.0- FEM HIGH EFFICIENCY MODE)

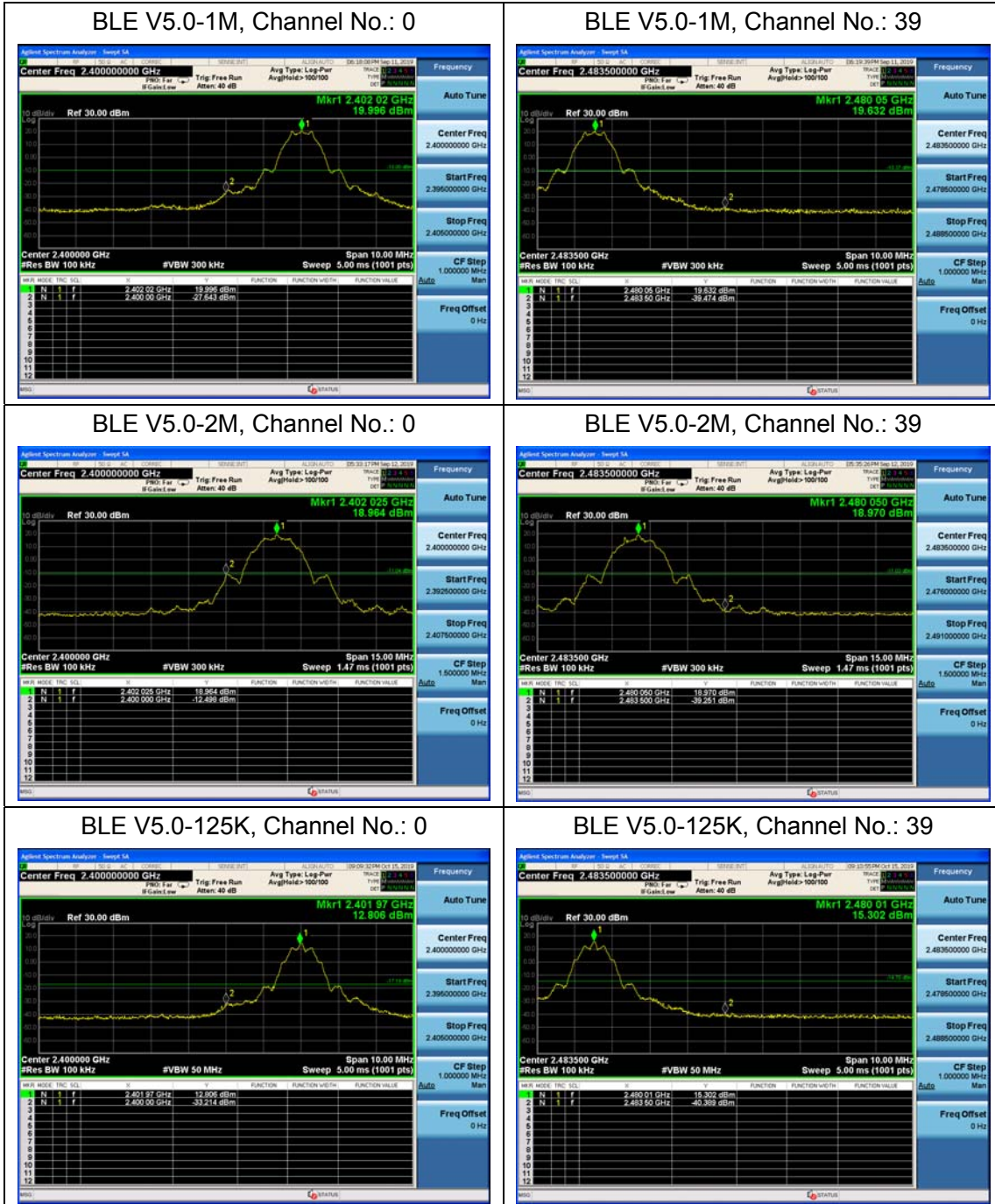



Antenna 2 (BLE V5.0- FEM HIGH EFFICIENCY MODE)

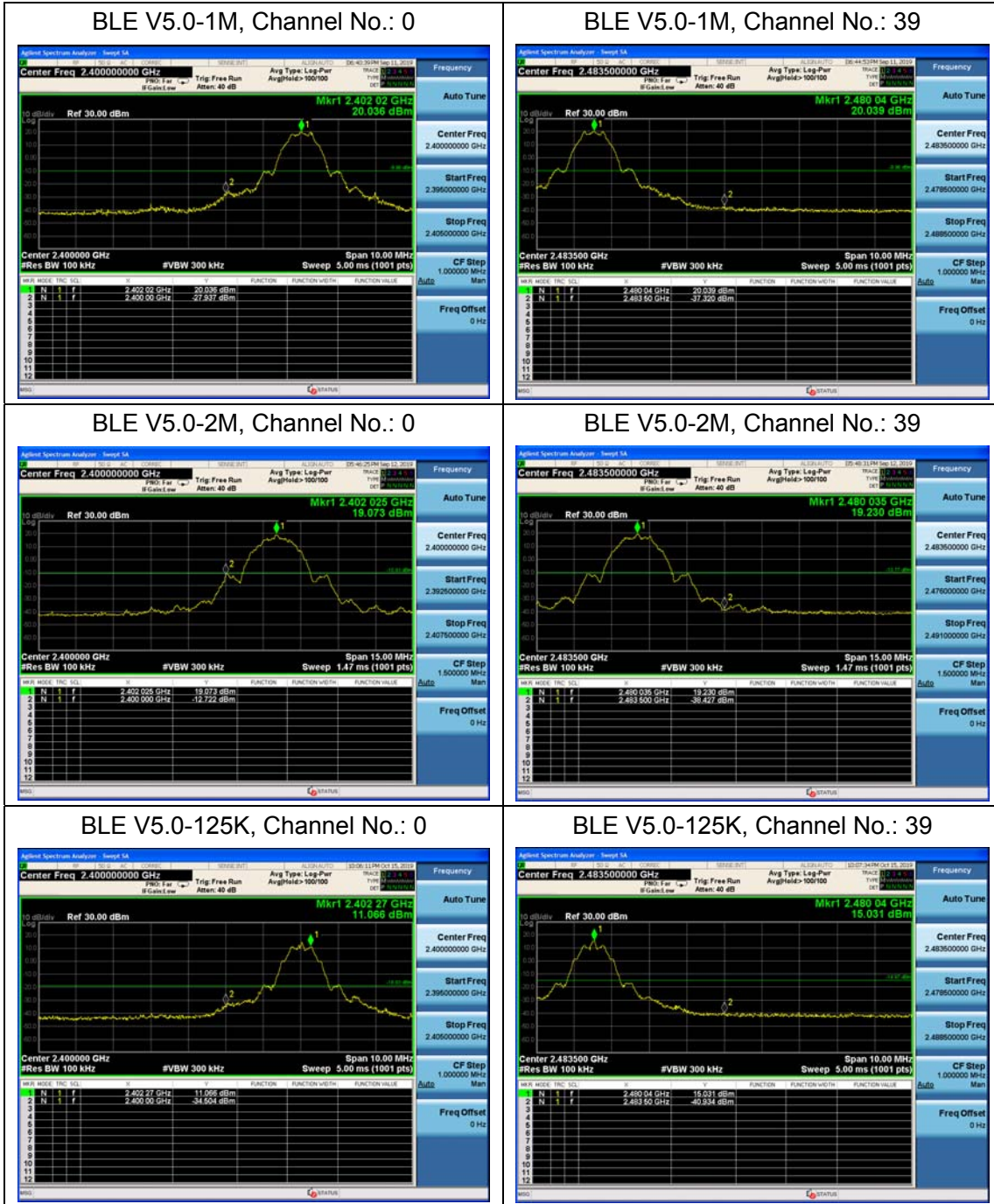

5.4. Power Spectral Density

Ambient condition

Temperature	Relative humidity	Pressure
23°C ~25°C	45%~50%	101.5kPa

Method of Measurement

During the process of the testing, The EUT was connected to Spectrum Analyzer with a known loss. The EUT is max power transmission with proper modulation. Method AVGPSD-2 in KDB558074 D01 was used for this test.

Test setup

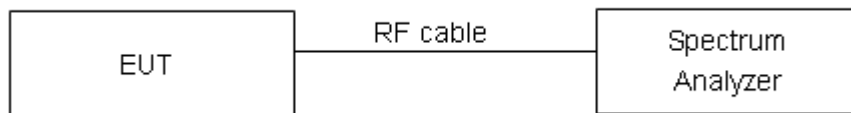

Limits

Rule Part 15.247(e) specifies that” For digitally modulated systems, the power spectral density conducted from the intentional radiator to the antenna shall not be greater than 8 dBm in any 3 kHz band during any time interval of continuous transmission. ”

Limits	$\leq 8 \text{ dBm} / 3\text{kHz}$
--------	------------------------------------

Measurement Uncertainty

The assessed measurement uncertainty to ensure 95% confidence level for the normal distribution is with the coverage factor $k = 2$, $U = 0.75\text{dB}$.

**Test Results:****Antenna 1****(BLE V5.0-1M FEM HIGH EFFICIENCY MODE)**

Network Standards	Channel Number	Read Value (dBm / 3kHz)	Power Spectral Density (dBm / 3kHz)	Limit (dBm / 3kHz)	Conclusion
Bluetooth (Low Energy)	0	-3.97	2.67	8	PASS
	19	-3.45	3.20	8	PASS
	39	-2.87	3.78	8	PASS

Note: Power Spectral Density =Read Value+Duty cycle correction factor

(BLE V5.0-2M FEM HIGH EFFICIENCY MODE)

Network Standards	Channel Number	Read Value (dBm / 3kHz)	Power Spectral Density (dBm / 3kHz)	Limit (dBm / 3kHz)	Conclusion
Bluetooth (Low Energy)	0	-8.78	0.09	8	PASS
	19	-9.07	-0.19	8	PASS
	39	-9.45	-0.57	8	PASS

Note: Power Spectral Density =Read Value+Duty cycle correction factor

(BLE V5.0-125K FEM HIGH EFFICIENCY MODE)

Network Standards	Channel Number	Read Value (dBm / 3kHz)	Power Spectral Density (dBm / 3kHz)	Limit (dBm / 3kHz)	Conclusion
Bluetooth (Low Energy)	0	5.95	7.60	8	PASS
	19	6.29	7.94	8	PASS
	39	6.32	7.98	8	PASS

Note: Power Spectral Density =Read Value+Duty cycle correction factor

Antenna 2

(BLE V5.0-1M FEM HIGH EFFICIENCY MODE)

Network Standards	Channel Number	Read Value (dBm / 3kHz)	Power Spectral Density (dBm / 3kHz)	Limit (dBm / 3kHz)	Conclusion
Bluetooth (Low Energy)	0	-4.75	1.90	8	PASS
	19	-3.00	3.65	8	PASS
	39	-3.40	3.25	8	PASS

Note: Power Spectral Density =Read Value+Duty cycle correction factor

(BLE V5.0-2M FEM HIGH EFFICIENCY MODE)

Network Standards	Channel Number	Read Value (dBm / 3kHz)	Power Spectral Density (dBm / 3kHz)	Limit (dBm / 3kHz)	Conclusion
Bluetooth (Low Energy)	0	-8.70	0.18	8	PASS
	19	-8.46	0.42	8	PASS
	39	-9.82	-0.94	8	PASS

Note: Power Spectral Density =Read Value+Duty cycle correction factor

(BLE V5.0-125K FEM HIGH EFFICIENCY MODE)

Network Standards	Channel Number	Read Value (dBm / 3kHz)	Power Spectral Density (dBm / 3kHz)	Limit (dBm / 3kHz)	Conclusion
Bluetooth (Low Energy)	0	5.88	7.50	8	PASS
	19	6.30	7.92	8	PASS
	39	6.26	7.89	8	PASS

Note: Power Spectral Density =Read Value+Duty cycle correction factor

Antenna 1
(BLE V5.0- FEM HIGH EFFICIENCY MODE)

BLE V5.0-1M, Channel No.: 0



BLE V5.0-2M, Channel No.: 0

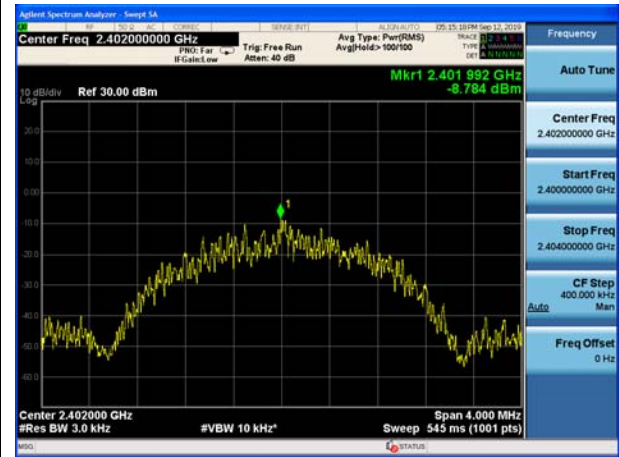

BLE V5.0-1M, Channel No.: 19



BLE V5.0-2M, Channel No.: 19

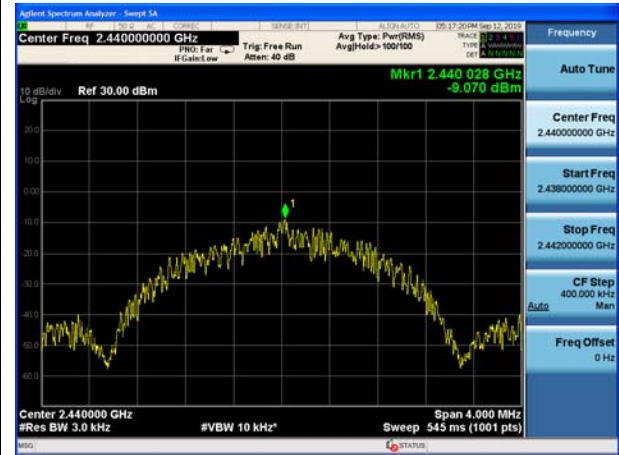

BLE V5.0-1M, Channel No.: 39



BLE V5.0-2M, Channel No.: 39



BLE V5.0-125K, Channel No.: 0



BLE V5.0-125K, Channel No.: 19

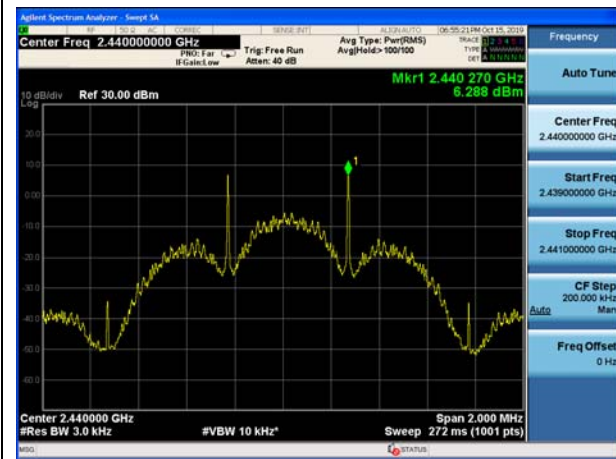

BLE V5.0-125K, Channel No.: 39





Antenna 2 (BLE V5.0- FEM HIGH EFFICIENCY MODE)

BLE V5.0-1M, Channel No.: 0



BLE V5.0-2M, Channel No.: 0

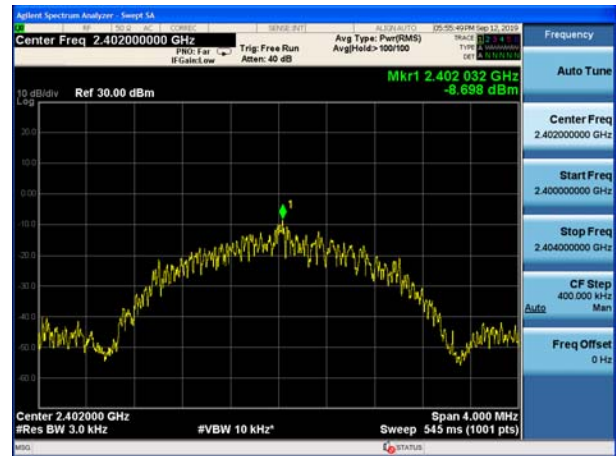

BLE V5.0-1M, Channel No.: 19

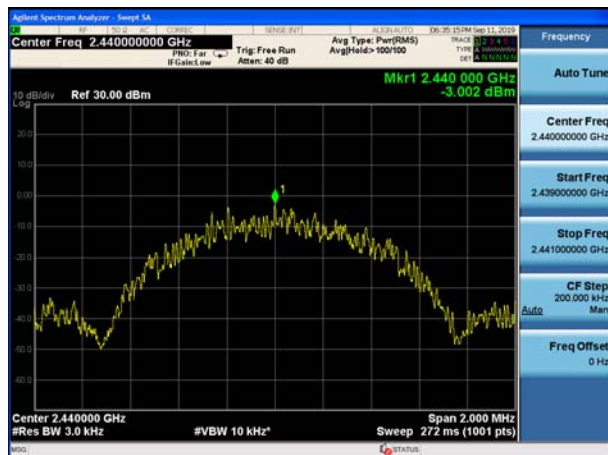

BLE V5.0-2M, Channel No.: 19

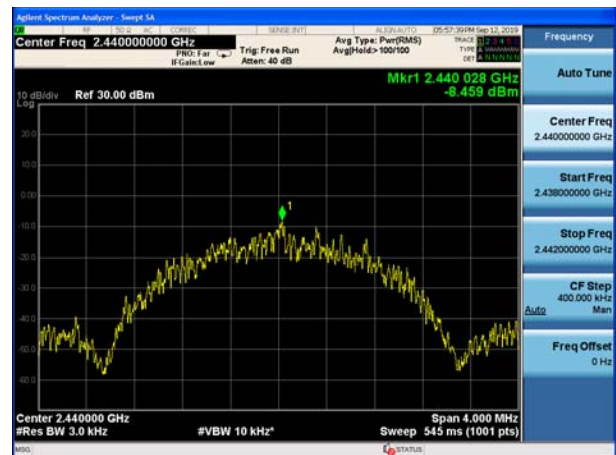

BLE V5.0-1M, Channel No.: 39

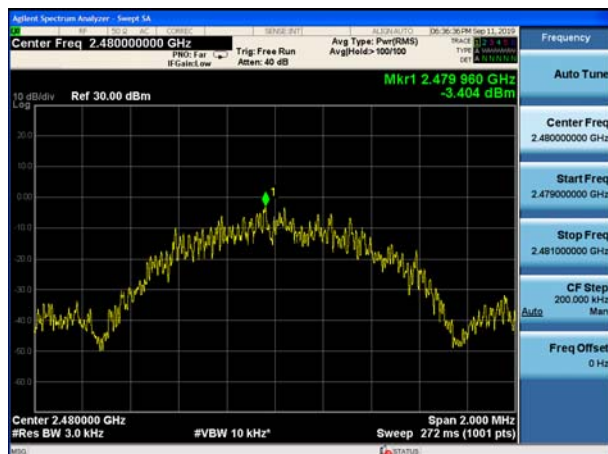

BLE V5.0-2M, Channel No.: 39

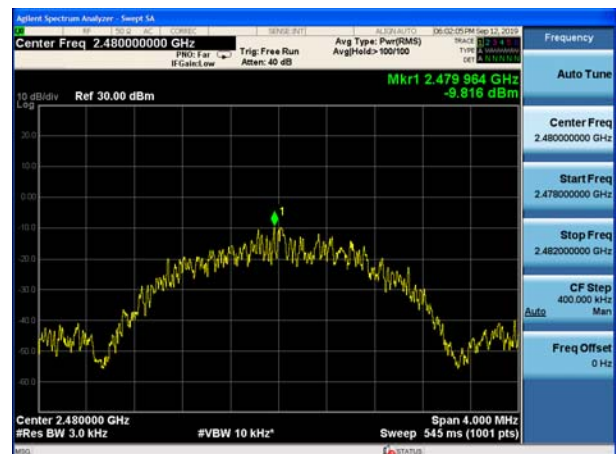

BLE V5.0-125K, Channel No.: 0

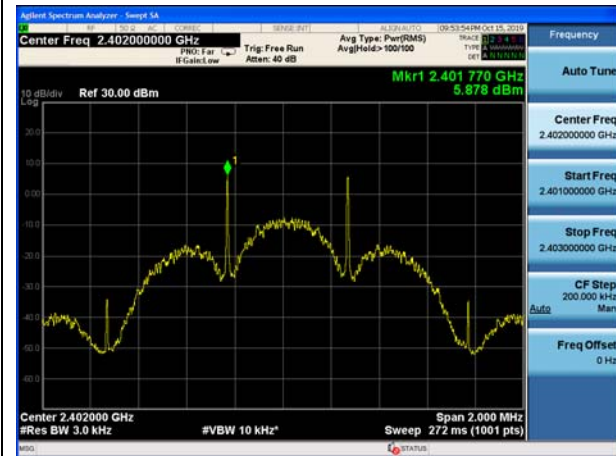

BLE V5.0-125K, Channel No.: 19

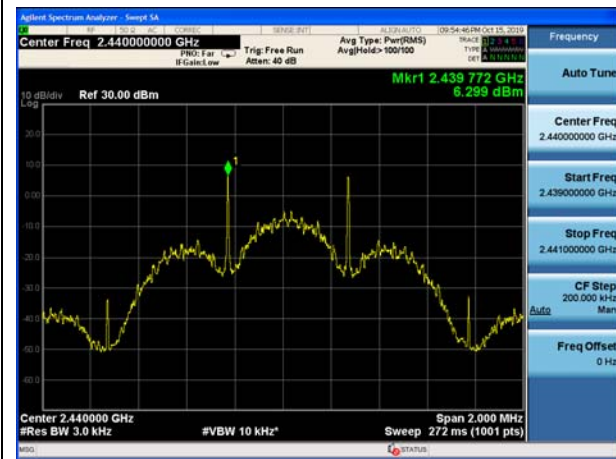

BLE V5.0-125K, Channel No.: 39

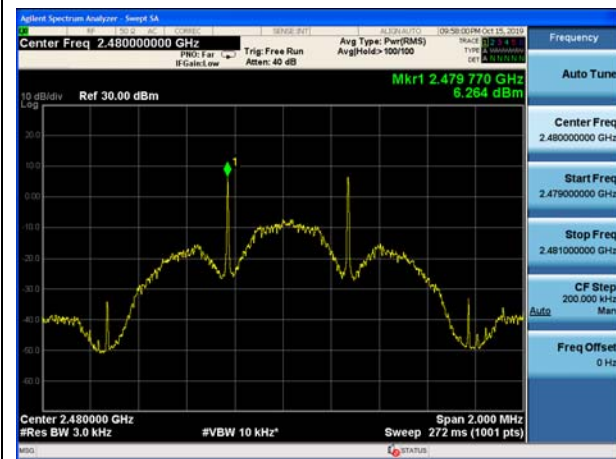

5.5. Spurious RF Conducted Emissions

Ambient condition

Temperature	Relative humidity	Pressure
23°C ~25°C	45%~50%	101.5kPa

Method of Measurement

The EUT was connected to the spectrum analyzer with a known loss. The spectrum analyzer scans from 30MHz to the 10th harmonic of the carrier. The peak detector is used. Set RBW to 100 kHz and VBW to 300 kHz, Sweep is set to ATUO.

The test is in transmitting mode.

Test setup



Limits

Rule Part 15.247(d) pacifies that “In any 100 kHz bandwidth outside the frequency band in which the spread spectrum or digitally modulated intentional radiator is operating, the radio frequency power that is produced by the intentional radiator shall be at least 20 dB below that in the 100 kHz bandwidth within the band that contains the highest level of the desired power, based on either an RF conducted or a radiated measurement, provided the transmitter demonstrates compliance with the peak conducted power limits. If the transmitter complies with the conducted power limits based on the use of RMS averaging over a time interval, as permitted under paragraph (b)(3) of this section, the attenuation required under this paragraph shall be 30 dB instead of 20 dB. ”

Antenna 1

(BLE V5.0- FEM HIGH EFFICIENCY MODE)

Network Standards	Carrier frequency (MHz)	Reference value (dBm)	Limit
Bluetooth V5.0-1M (Low Energy)	2402	20.36	-9.64
	2440	20.40	-9.60
	2480	20.73	-9.27
Network Standards	Carrier frequency (MHz)	Reference value (dBm)	Limit
Bluetooth V5.0-2M (Low Energy)	2402	20.44	-9.56
	2440	19.82	-10.18
	2480	20.93	-9.07
Network Standards	Carrier frequency (MHz)	Reference value (dBm)	Limit



Bluetooth V5.0-125K (Low Energy)	2402	15.06	-14.94
	2440	12.27	-17.73
	2480	15.02	-14.98

Antenna 2**(BLE V5.0- FEM HIGH EFFICIENCY MODE)**

Network Standards	Carrier frequency (MHz)	Reference value (dBm)	Limit
Bluetooth V5.0-1M (Low Energy)	2402	19.81	-10.19
	2440	20.15	-9.85
	2480	20.80	-9.20
Network Standards	Carrier frequency (MHz)	Reference value (dBm)	Limit
Bluetooth V5.0-2M (Low Energy)	2402	20.54	-9.46
	2440	19.53	-10.47
	2480	21.01	-8.99
Network Standards	Carrier frequency (MHz)	Reference value (dBm)	Limit
Bluetooth V5.0-125K (Low Energy)	2402	14.85	-15.15
	2440	15.07	-14.93
	2480	15.00	-15.00

**Measurement Uncertainty**

The assessed measurement uncertainty to ensure 95% confidence level for the normal distribution is with the coverage factor $k = 1.96$.

Frequency	Uncertainty
100kHz-2GHz	0.684 dB
2GHz-26GHz	1.407 dB



Test Results:

Antenna 1

(BLE V5.0- FEM HIGH EFFICIENCY MODE)

BLE V5.0-1M, Channel No.: 0

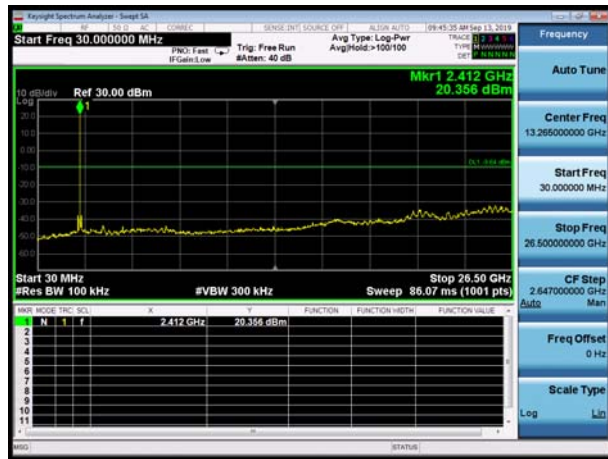

BLE V5.0-2M, Channel No.: 0

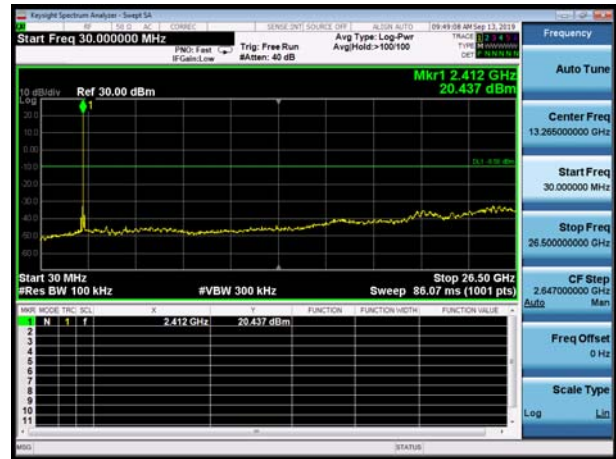

BLE V5.0-1M, Channel No.: 19

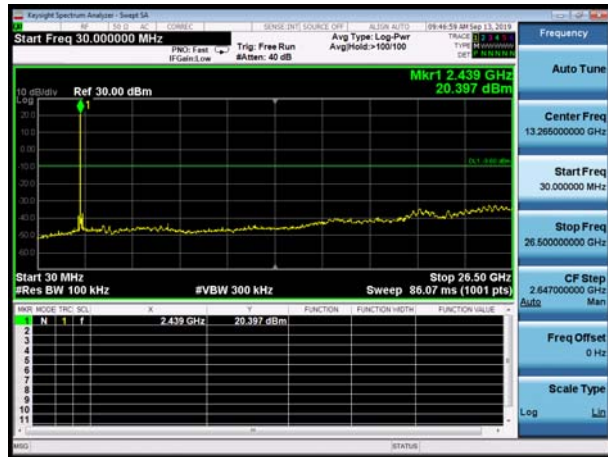

BLE V5.0-2M, Channel No.: 19

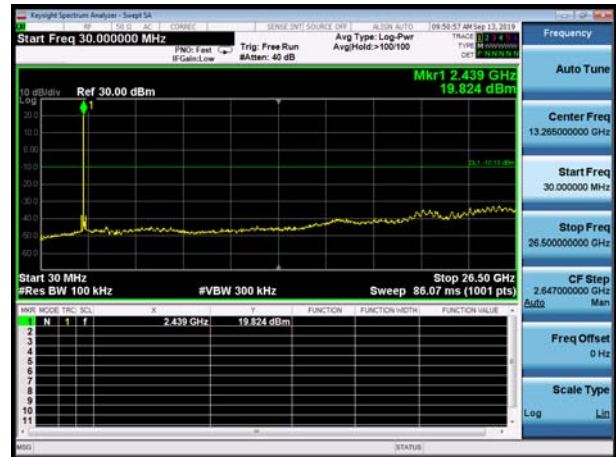

BLE V5.0-1M, Channel No.: 39

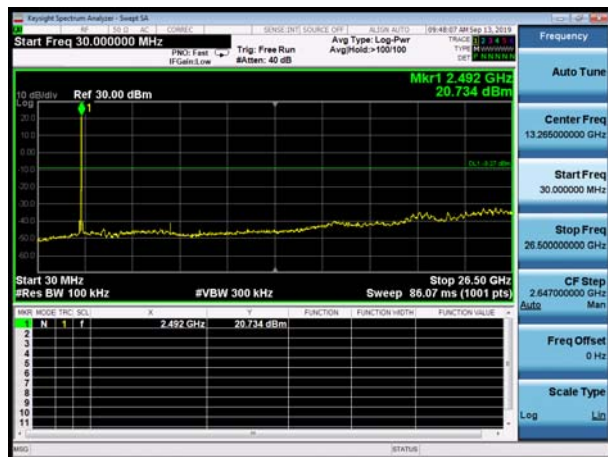

BLE V5.0-2M, Channel No.: 39

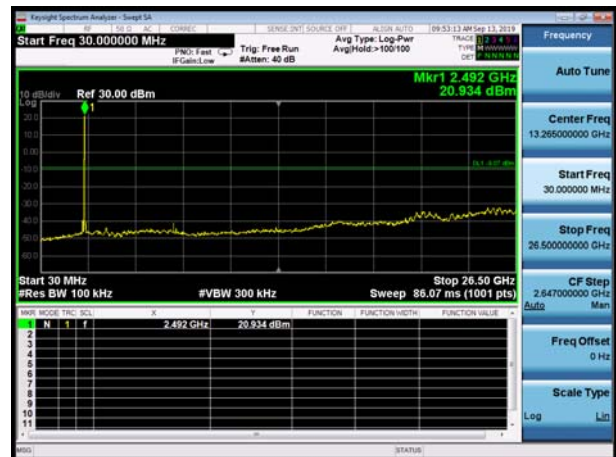

BLE V5.0-125K, Channel No.: 0

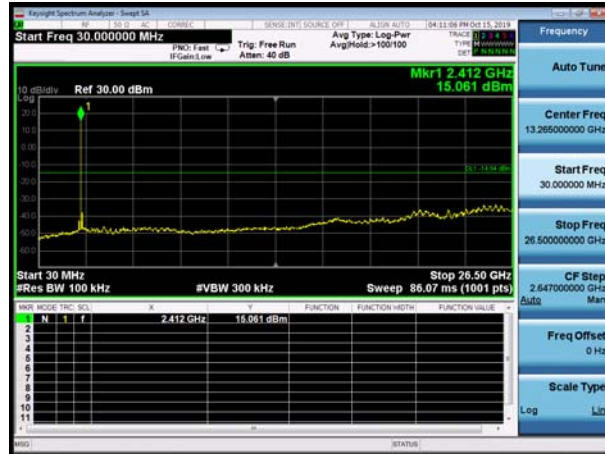

BLE V5.0-125K, Channel No.: 19

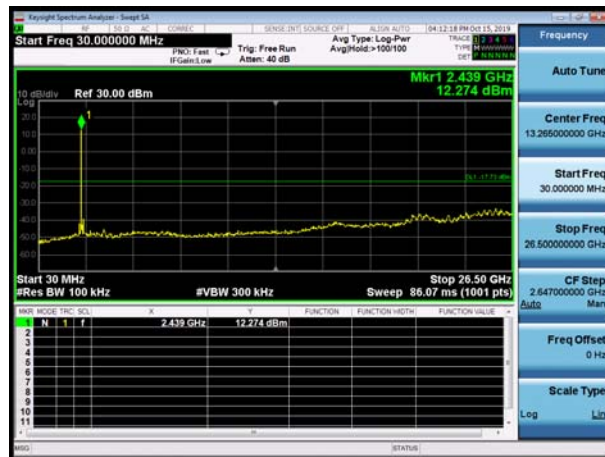

BLE V5.0-125K, Channel No.: 39

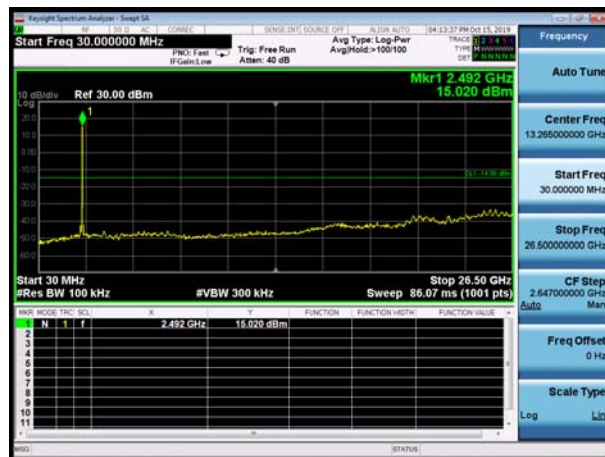



Antenna 2 (BLE V5.0- FEM HIGH EFFICIENCY MODE)

BLE V5.0-1M, Channel No.: 0

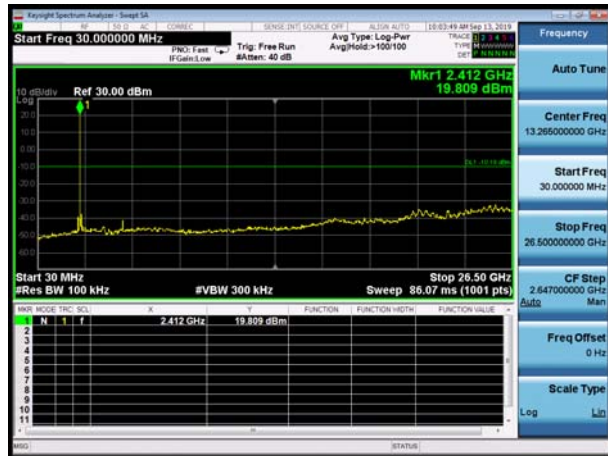

BLE V5.0-2M, Channel No.: 0

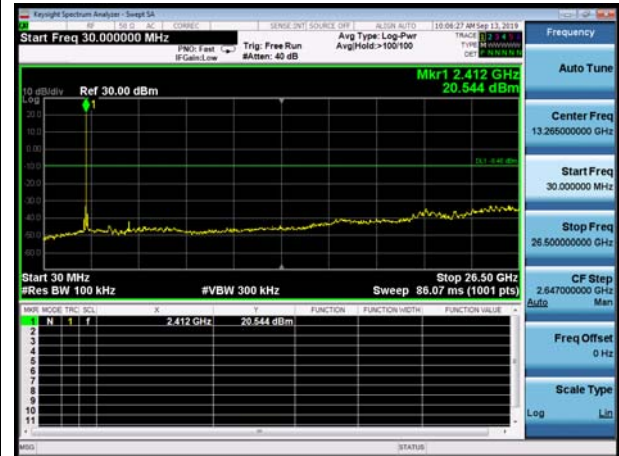

BLE V5.0-1M, Channel No.: 19

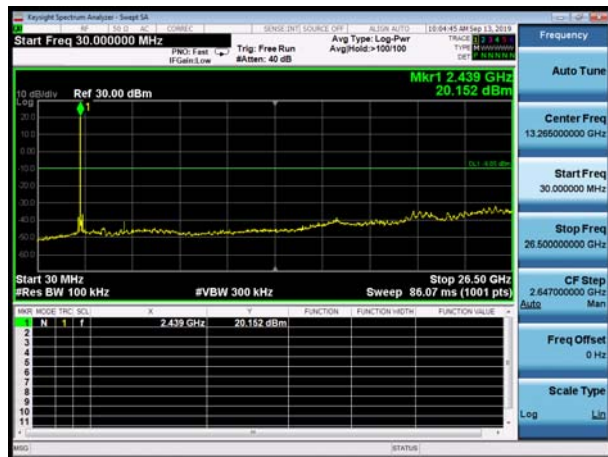

BLE V5.0-2M, Channel No.: 19

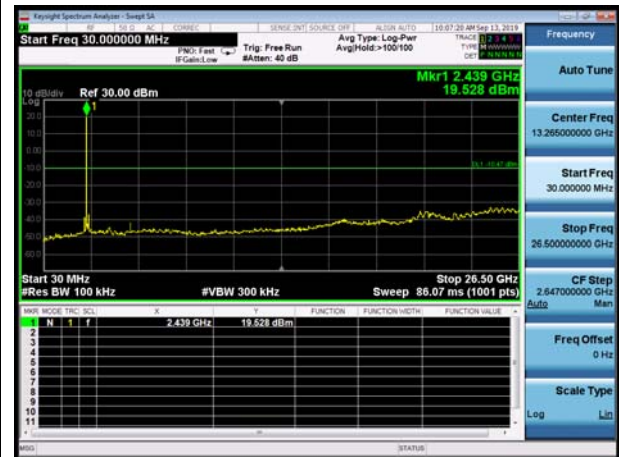

BLE V5.0-1M, Channel No.: 39

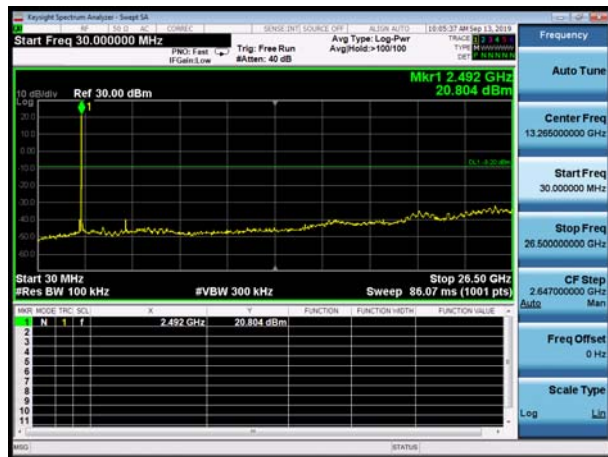

BLE V5.0-2M, Channel No.: 39

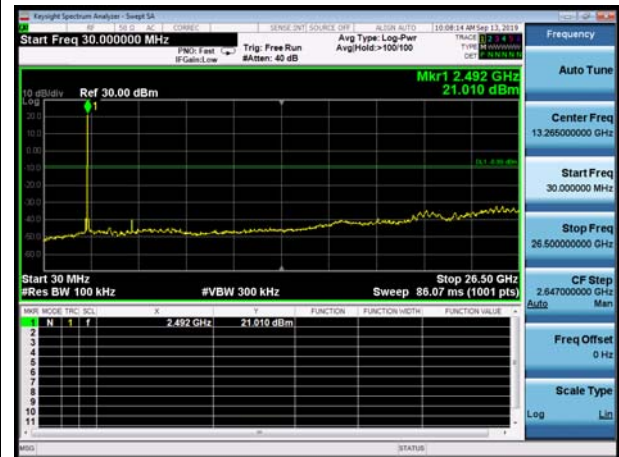

BLE V5.0-125K, Channel No.: 0

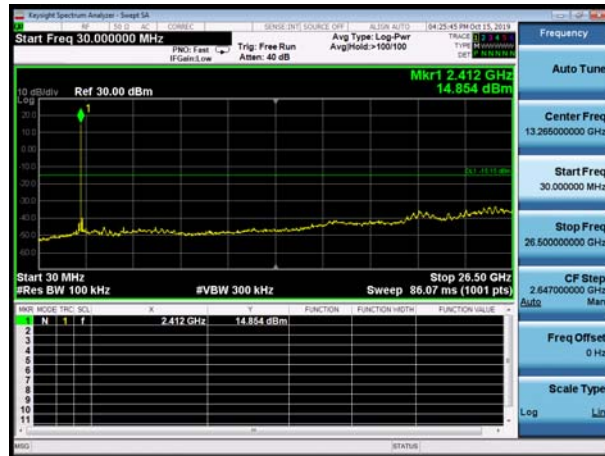

BLE V5.0-125K, Channel No.: 19

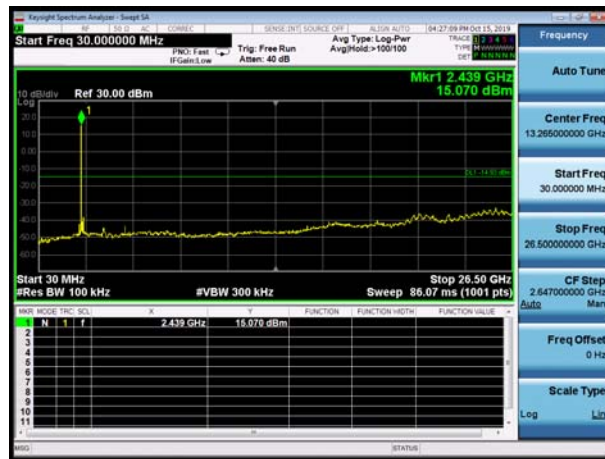

BLE V5.0-125K, Channel No.: 39

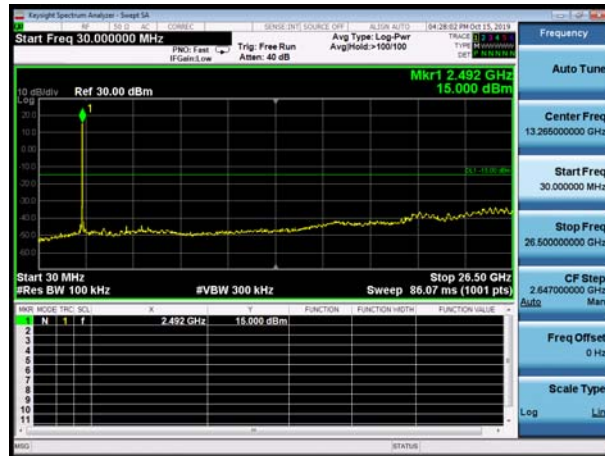

5.6. Unwanted Emission

Ambient condition

Temperature	Relative humidity	Pressure
23°C ~25°C	45%~50%	102.5kPa

Method of Measurement

The test set-up was made in accordance to the general provisions of ANSI C63.10-2013.

The Equipment Under Test (EUT) was set up on a non-conductive table in the semi-anechoic chamber. The test was performed at the distance of 3 m between the EUT and the receiving antenna.

The turntable shall be rotated from 0 to 360 degrees for detecting the maximum of radiated spurious signal level. The measurements shall be repeated with orthogonal polarization of the test antenna. The data of cable loss and antenna factor has been calibrated in full testing frequency range before the testing. Sweep the Restricted Band and the emissions less than 20 dB below the permissible value are reported.

The radiated emissions measurements were made in a typical installation configuration.

Sweep the whole frequency band through the range from 9 kHz to the 10th harmonic of the carrier, and the emissions less than 20 dB below the permissible value are reported.

This method refer to ANSI C63.10-2013.

The procedure for peak unwanted emissions measurements above 1000 MHz is as follows:

I) Peak emission levels are measured by setting the instrument as follows:

- 1) RBW = 1 MHz.
- 2) VBW \geq [3 \times RBW]
- 3) Detector = peak.
- 4) Sweep time = auto.
- 5) Trace mode = max hold.
- 6) Allow sweeps to continue until the trace stabilizes. Note that if the transmission is not continuous, then the time required for the trace to stabilize will increase by a factor of approximately 1 / D, where D is the duty cycle.

II) Average emission levels are measured by setting the instrument as follows:

- a) RBW = 1 MHz.
- b) VBW \geq [3 \times RBW].
- c) Detector = RMS (power averaging), if [span / (# of points in sweep)] \leq RBW / 2. Satisfying this condition can require increasing the number of points in the sweep or reducing the span. If the condition is not satisfied, then the detector mode shall be set to peak.
- d) Averaging type = power (i.e., rms) (As an alternative, the detector and averaging type may be set for linear voltage averaging. Some instruments require linear display mode to use linear voltage



averaging. Log or dB averaging shall not be used.)

e) Sweep time = auto.

f) Perform a trace average of at least 100 traces if the transmission is continuous. If the transmission is not continuous, then the number of traces shall be increased by a factor of $1 / D$, where D is the duty cycle. For example, with 50% duty cycle, at least 200 traces shall be averaged. (If a specific emission is demonstrated to be continuous—i.e., 100% duty cycle—then rather than turning ON and OFF with the transmit cycle, at least 100 traces shall be averaged.)

g) If tests are performed with the EUT transmitting at a duty cycle less than 98%, then a correction factor shall be added to the measurement results prior to comparing with the emission limit, to compute the emission level that would have been measured had the test been performed at 100% duty cycle. The correction factor is computed as follows:

1) If power averaging (rms) mode was used in the preceding step e), then the correction factor is $[10 \log (1 / D)]$, where D is the duty cycle. For example, if the transmit duty cycle was 50%, then 3 dB shall be added to the measured emission levels.

2) If linear voltage averaging mode was used in the preceding step e), then the correction factor is $[20 \log (1 / D)]$, where D is the duty cycle. For example, if the transmit duty cycle was 50%, then 6 dB shall be added to the measured emission levels.

3) If a specific emission is demonstrated to be continuous (100% duty cycle) rather than turning ON and OFF with the transmit cycle, then no duty cycle correction is required for that emission.

The test is in transmitting mode.

Test setup

9KHz ~ 30MHz

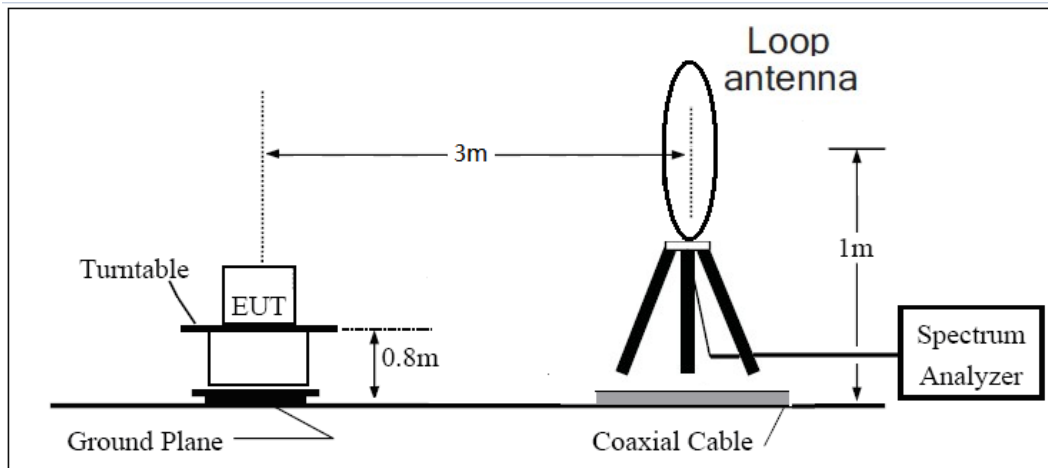

30MHz ~ 1GHz

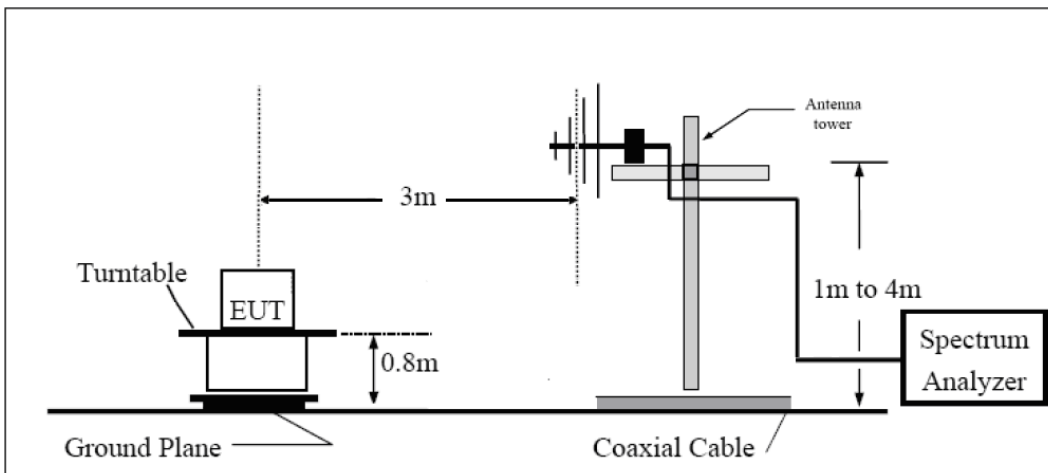

Above 1GHz

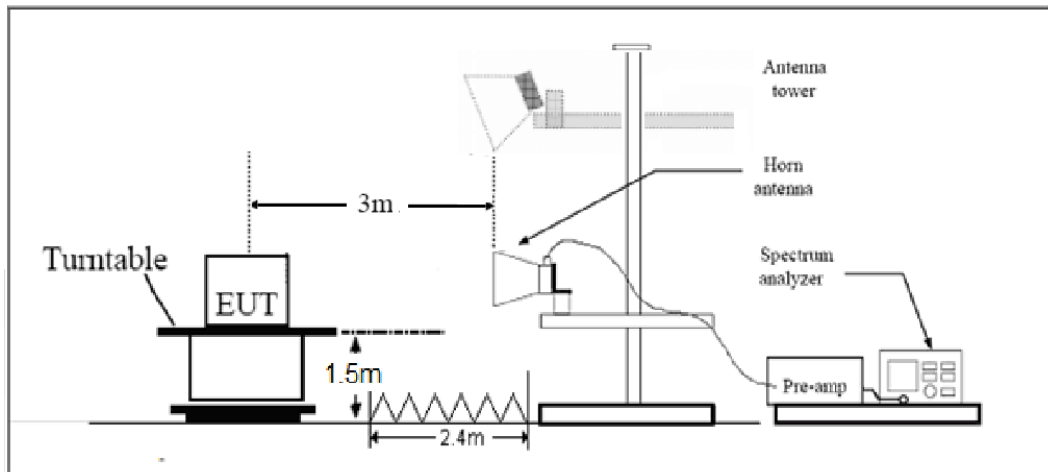

Note: Area side:2.4mX3.6m

**Limits**

Rule Part 15.247(d) specifies that "In addition, radiated emissions which fall in the restricted bands, as defined in § 15.205(a), must also comply with the radiated emission limits specified in § 15.209(a) (see § 15.205(c))."

Limit in restricted band

Frequency of emission (MHz)	Field strength(uV/m)	Field strength(dBuV/m)
0.009–0.490	2400/F(kHz)	/
0.490–1.705	24000/F(kHz)	/
1.705–30.0	30	/
30-88	100	40
88-216	150	43.5
216-960	200	46
Above960	500	54

§15.35(b)

There is also a limit on the radio frequency emissions, as measured using instrumentation with a peak detector function, corresponding to 20 dB above the maximum permitted average limit.

Peak Limit=74 dBuV/m

Average Limit=54 dBuV/m

Spurious Radiated Emissions are permitted in any of the frequency bands listed below:

MHz	MHz	MHz	GHz
0.090 - 0.110	16.42 - 16.423	399.9 - 410	4.5 - 5.15
¹ 0.495 - 0.505	16.69475 - 16.69525	608 - 614	5.35 - 5.46
2.1735 - 2.1905	16.80425 - 16.80475	960 - 1240	7.25 - 7.75
4.125 - 4.128	25.5 - 25.67	1300 - 1427	8.025 - 8.5
4.17725 - 4.17775	37.5 - 38.25	1435 - 1626.5	9.0 - 9.2
4.20725 - 4.20775	73 - 74.6	1645.5 - 1646.5	9.3 - 9.5
6.215 - 6.218	74.8 - 75.2	1660 - 1710	10.6 - 12.7
6.26775 - 6.26825	108 - 121.94	1718.8 - 1722.2	13.25 - 13.4
6.31175 - 6.31225	123 - 138	2200 - 2300	14.47 - 14.5
8.291 - 8.294	149.9 - 150.05	2310 - 2390	15.35 - 16.2
8.362 - 8.366	156.52475 - 156.52525	2483.5 - 2500	17.7 - 21.4
8.37625 - 8.38675	156.7 - 156.9	2690 - 2900	22.01 - 23.12
8.41425 - 8.41475	162.0125 - 167.17	3260 - 3267	23.6 - 24.0
12.29 - 12.293	167.72 - 173.2	3332 - 3339	31.2 - 31.8
12.51975 - 12.52025	240 - 285	3345.8 - 3358	36.43 - 36.5
12.57675 - 12.57725	322 - 335.4	3600 - 4400	(²)
13.36 - 13.41			

**Measurement Uncertainty**

The assessed measurement uncertainty to ensure 95% confidence level for the normal distribution is with the coverage factor $k = 1.96$.

Frequency	Uncertainty
9KHz-30MHz	3.55 dB
30MHz-200MHz	4.02 dB
200MHz-1GHz	3.28 dB
1-18GHz	3.70 dB
18-26.5GHz	5.78 dB



Test Results:

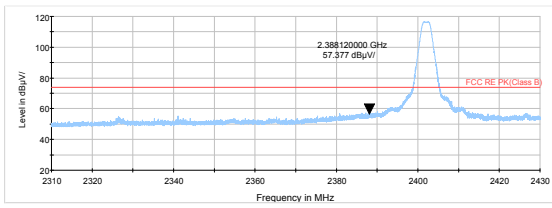

BLE Channel 0 Peak

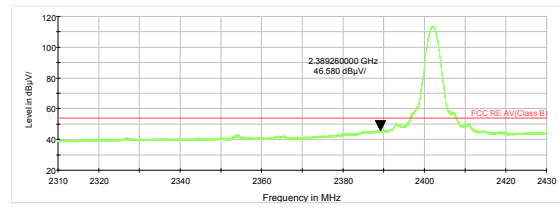

BLE Channel 0 Average

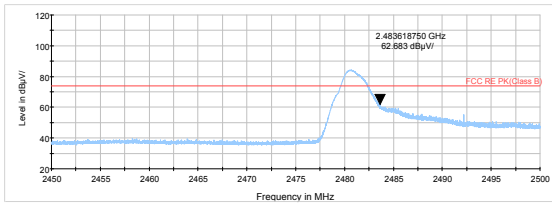

BLE Channel 39 Peak

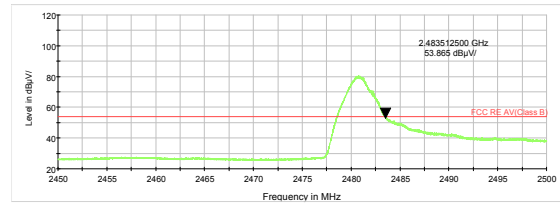

BLE Channel 39 Average

Result of RE

Test result

Sweep the whole frequency band through the range from 9kHz to the 10th harmonic of the carrier, the Emissions in the frequency band 9kHz-30MHz and 18GHz-26.5GHz are more than 20dB below the limit are not reported.

The following graphs display the maximum values of horizontal and vertical by software. For above 1GHz, Blue trace uses the peak detection, Green trace uses the average detection.

After the pretest ,Antenna 2 was selected as the worst Antenna.

During the test, the Radiates Emission from 30MHz to 1GHz was performed in all modes with all channels, BLE-Channel 19 are selected as the worst condition. The test data of the worst-case condition was recorded in this report.

Continuous TX mode:

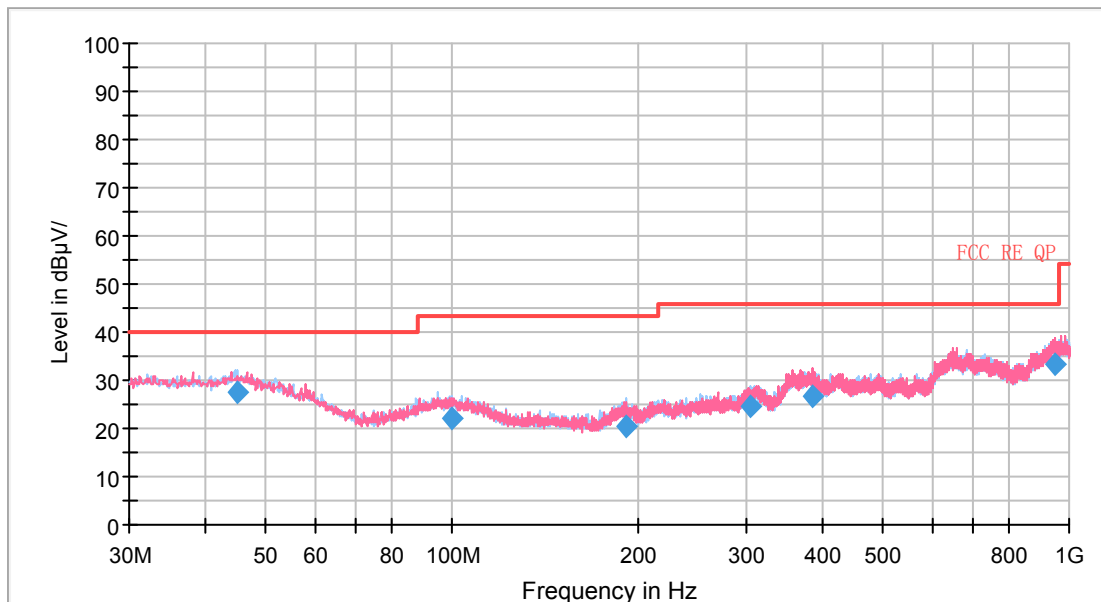

Radiates Emission from 30MHz to 1GHz

Frequency (MHz)	Quasi-Peak (dBuV/m)	Height (cm)	Polarization	Azimuth (deg)	Correct Factor (dB)	Margin (dB)	Limit (dBuV/m)
44.881466	27.40	225.0	H	142.0	3.3	12.60	40.00
99.912294	21.96	122.0	H	0.0	-3.2	21.54	43.50
191.146238	20.38	109.0	H	236.0	-4.6	23.12	43.50
304.865750	24.65	123.0	H	104.0	-1.6	21.35	46.00
382.767250	26.83	109.0	V	18.0	1.2	19.17	46.00
945.689000	33.49	184.0	V	166.0	8.9	12.51	46.00

Remark: 1. Correction Factor = Antenna factor+ Insertion loss(cable loss+amplifier gain)

2. Margin = Limit – Quasi-Peak



During the test, the Radiates Emission from 1GHz to 18GHz was performed in all modes, BLE V5.0-2M was selected as the worst condition. The test data of the worst-case condition was recorded in this report.

BLE-Channel 0

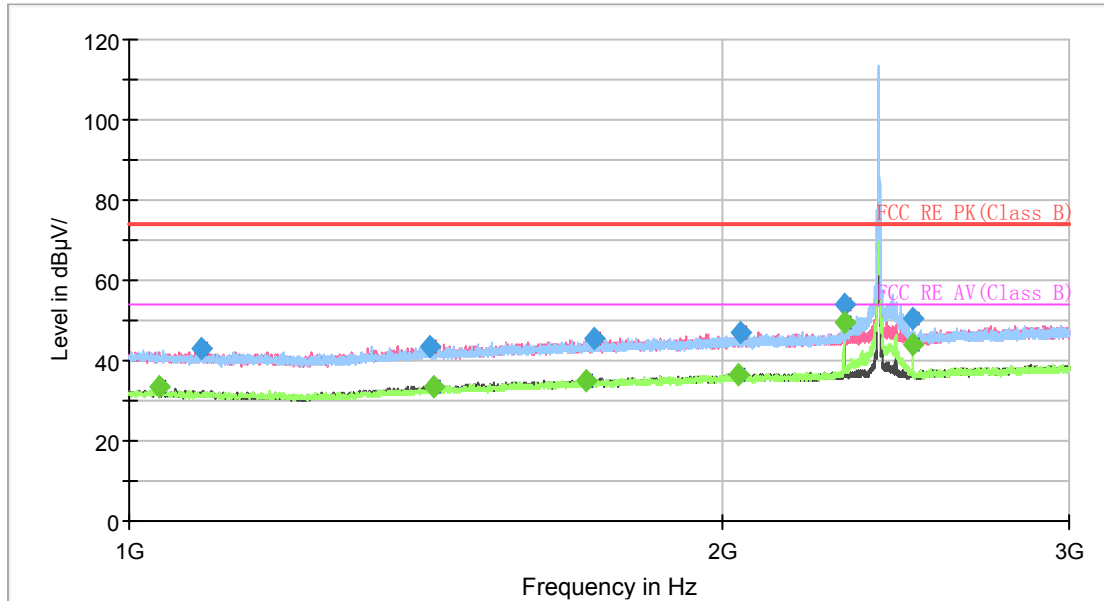

Note: The signal beyond the limit is carrier.
Radiates Emission from 1GHz to 3GHz

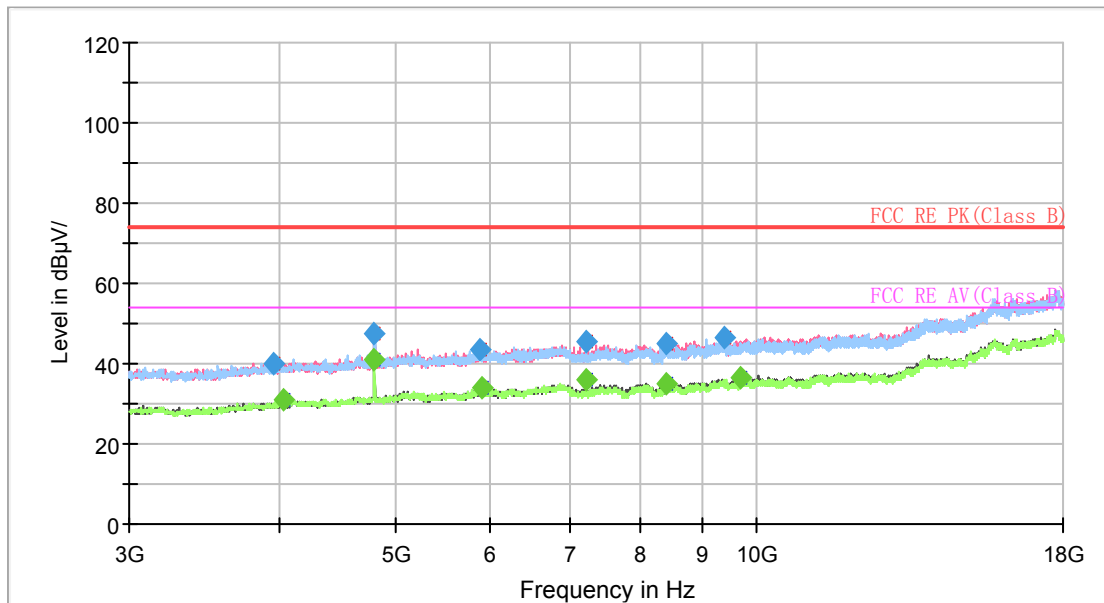

Radiates Emission from 3GHz to 18GHz



Frequency (MHz)	Peak (dBuV/m)	Average (dBuV/m)	Limit (dBuV/m)	Margin (dB)	Meas. Time (ms)	Height (cm)	Pol	Azimuth (deg)	Corr. (dB/m)
1035.750000	---	33.37	54.00	20.63	200.0	100.0	H	0.0	-1.0
1089.000000	42.77	---	74.00	31.23	200.0	200.0	V	0.0	-0.7
1422.000000	43.69	---	74.00	30.31	200.0	200.0	V	33.0	1.0
1426.750000	---	33.72	54.00	20.28	200.0	200.0	H	292.0	1.0
1704.750000	---	35.15	54.00	18.85	200.0	100.0	V	349.0	2.6
1723.250000	45.44	---	74.00	28.56	200.0	200.0	H	140.0	2.5
2036.500000	---	36.75	54.00	17.25	200.0	200.0	V	282.0	4.0
2044.750000	46.90	---	74.00	27.10	200.0	200.0	H	0.0	4.0
2306.250000	---	49.60	54.00	4.40	200.0	200.0	H	192.0	4.9
2306.500000	54.01	---	74.00	19.99	200.0	100.0	H	83.0	4.9
2497.500000	50.58	---	74.00	23.42	200.0	100.0	H	95.0	5.6
2498.250000	---	44.02	54.00	9.98	200.0	200.0	H	299.0	5.6

Remark: 1. Correction Factor = Antenna factor+ Insertion loss (cable loss + amplifier gain)

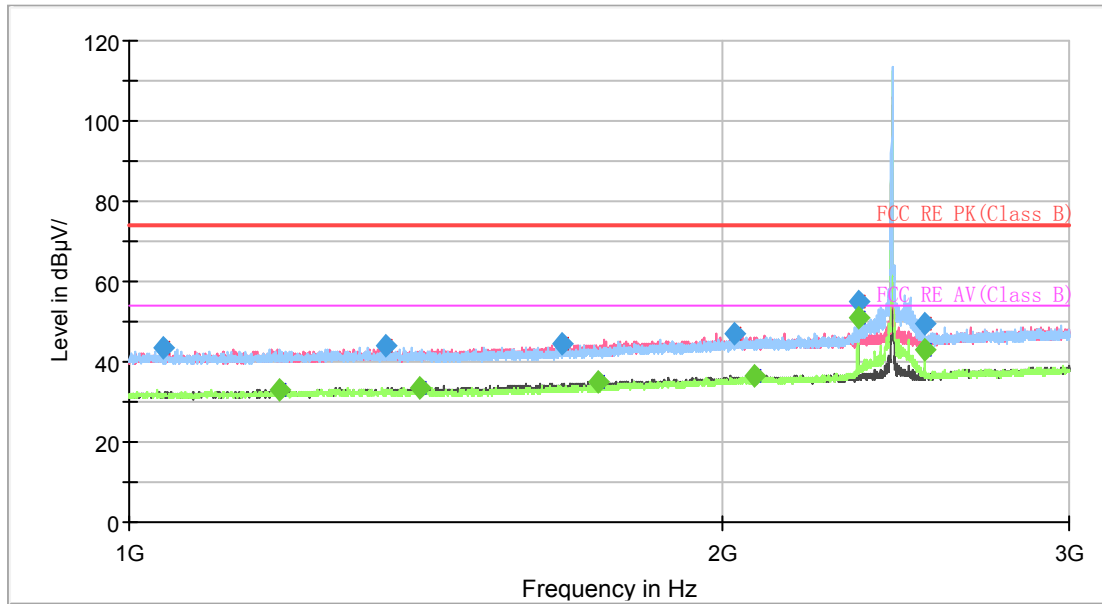
BLE-Channel 19

Note: The signal beyond the limit is carrier.
Radiates Emission from 1GHz to 3GHz

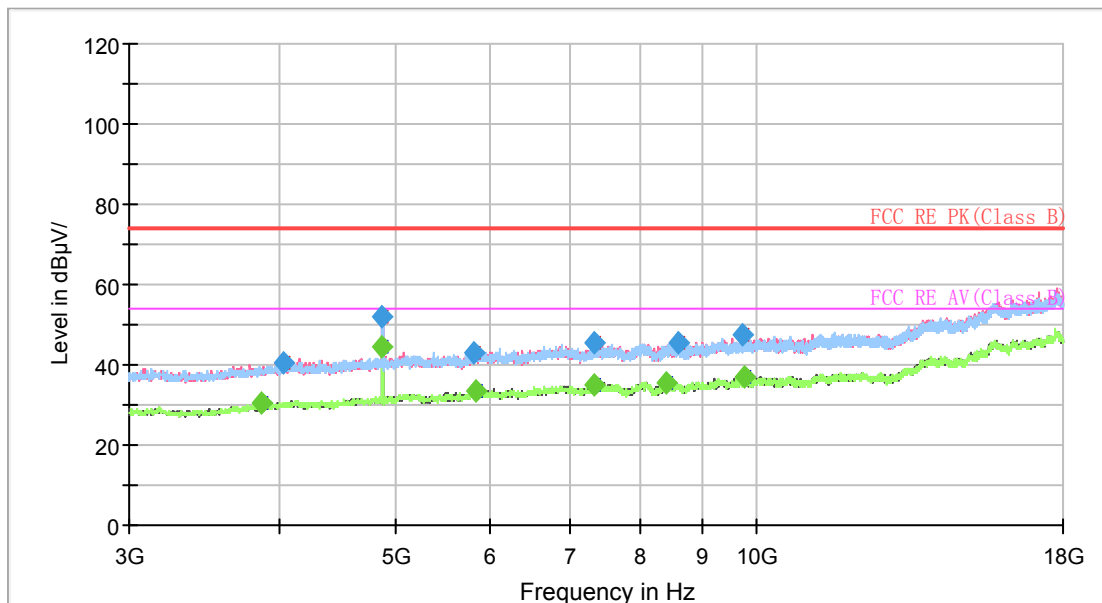

Radiates Emission from 3GHz to 18GHz



Frequency (MHz)	Peak (dBuV/m)	Average (dBuV/m)	Limit (dBuV/m)	Margin (dB)	Meas. Time (ms)	Height (cm)	Pol	Azimuth (deg)	Corr. (dB/m)
1040.000000	43.26	---	74.00	30.74	200.0	200.0	H	350.0	-1.0
1193.000000	---	33.19	54.00	20.81	200.0	100.0	V	293.0	0.1
1348.250000	43.86	---	74.00	30.14	200.0	200.0	H	282.0	0.7
1405.500000	---	33.69	54.00	20.31	200.0	100.0	V	351.0	1.0
1659.250000	44.31	---	74.00	29.69	200.0	100.0	V	280.0	2.2
1730.500000	---	34.98	54.00	19.02	200.0	100.0	V	0.0	2.5
2028.500000	46.92	---	74.00	27.08	200.0	200.0	V	90.0	4.0
2076.250000	---	36.53	54.00	17.47	200.0	100.0	H	0.0	4.0
2344.000000	---	51.21	54.00	2.79	200.0	200.0	H	86.0	5.1
2344.500000	55.07	---	74.00	18.93	200.0	200.0	H	79.0	5.1
2536.250000	---	43.01	54.00	10.99	200.0	200.0	H	89.0	5.5
2536.500000	49.71	---	74.00	24.29	200.0	200.0	H	271.0	5.5

Remark: 1. Correction Factor = Antenna factor+ Insertion loss (cable loss + amplifier gain)

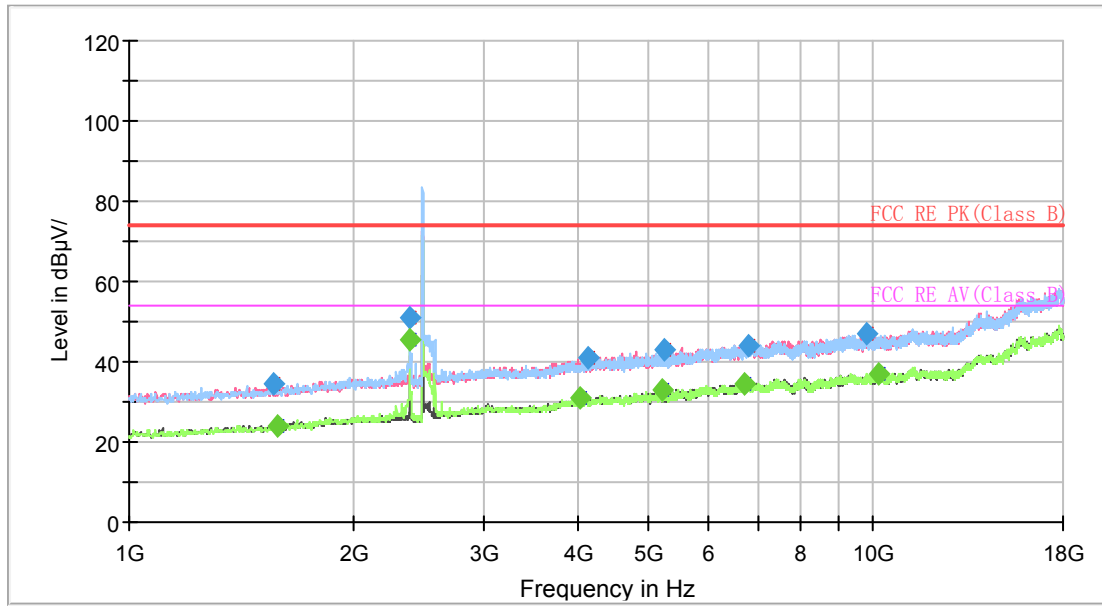
BLE-Channel 39

Note: The signal beyond the limit is carrier.
Radiates Emission from 1GHz to 18GHz



Frequency (MHz)	Peak (dBuV/m)	Average (dBuV/m)	Limit (dBuV/m)	Margin (dB)	Meas. Time (ms)	Height (cm)	Pol	Azimuth (deg)	Corr. (dB/m)
1563.125000	34.41	---	74.00	39.59	200.0	200.0	H	309.0	-8.1
1580.125000	---	24.25	54.00	29.75	200.0	100.0	H	316.0	-8.2
2383.375000	---	45.29	54.00	8.71	200.0	200.0	H	74.0	-4.9
2383.375000	51.04	---	74.00	22.96	200.0	200.0	H	74.0	-4.9
4028.125000	---	31.05	54.00	22.95	200.0	200.0	V	95.0	0.8
4130.125000	40.92	---	74.00	33.08	200.0	100.0	H	357.0	1.0
5207.500000	---	32.75	54.00	21.25	200.0	100.0	V	102.0	3.6
5245.750000	42.87	---	74.00	31.13	200.0	200.0	V	170.0	3.4
6722.625000	---	34.37	54.00	19.63	200.0	200.0	V	170.0	6.0
6794.875000	43.86	---	74.00	30.14	200.0	200.0	H	65.0	6.0
9823.000000	46.89	---	74.00	27.11	200.0	200.0	V	331.0	10.1
10171.500000	---	37.09	54.00	16.91	200.0	200.0	H	78.0	9.8

Remark: 1. Correction Factor = Antenna factor+ Insertion loss (cable loss + amplifier gain)



6. Main Test Instruments

Name	Manufacturer	Type	Serial Number	Calibration Date	Expiration Date
Spectrum Analyzer	R&S	FSV30	100815	2018-12-16	2019-12-15
Spectrum Analyzer	R&S	FSV30	100815	2019-12-15	2020-12-14
EMI Test Receiver	R&S	ESCI	100948	2019-05-19	2020-05-18
EMI Test Receiver	R&S	ESCI	100948	2020-05-18	2021-05-17
Loop Antenna	SCHWARZBECK	FMZB1519	1519-047	2017-09-26	2020-09-25
TRILOG Broadband Antenna	Schwarzbeck	VULB 9163	9163-201	2017-11-18	2020-11-17
Horn Antenna	R&S	HF907	102723	2018-08-11	2021-08-10
Horn Antenna	ETS-Lindgren	3160-09	00102643	2018-06-20	2021-06-19
EMI Test Receiver	R&S	ESR	101667	2019-05-19	2020-05-18
EMI Test Receiver	R&S	ESR	101667	2020-05-18	2021-05-17
LISN	R&S	ENV216	101171	2018-12-15	2021-12-14
Spectrum Analyzer	Agilent	N9010A	MY47191109	2019-05-19	2020-05-18
Spectrum Analyzer	Agilent	N9010A	MY47191109	2020-05-18	2021-05-17
Power Meter	R&S	NRP	104306	2019-05-19	2020-05-18
Power Meter	R&S	NRP	104306	2020-05-18	2021-05-17
Power Sensor	R&S	NRP-Z21	104799	2019-05-19	2020-05-18
Power Sensor	R&S	NRP-Z21	104799	2020-05-18	2021-05-17
20dB Attenuator	Star River Highlight	UCL-TS2S-20	18013001	2018-12-16	2019-12-15
20dB Attenuator	Star River Highlight	UCL-TS2S-20	18013001	2019-12-15	2020-12-14
RF Cable	Agilent	SMA 15cm	0001	2019-09-14	2019-12-13
RF Cable	Agilent	SMA 15cm	0001	2019-12-13	2020-06-12
RF Cable	Agilent	SMA 15cm	0001	2020-06-12	2020-12-11
Software	R&S	EMC32	9.26.0	/	/

*****END OF REPORT *****