



FCC Radio Test Report

FCC ID: HQXR07-M

This report concerns (check one) : Original Grant Class II Change

Issued Date : Apr. 20, 2010
Project No. : 1003C232
Equipment : 2.4G Wireless Receiver
Model Name : R07-M
Applicant : Sysgration Ltd.
Address : 10Fl., NO.868-3, Chung Cheng Rd., Chung Ho, Taipei, Taiwan, R.O.C.
Manufacturer : Sysgration(Shenzhen) Ltd.
Address : Egongling Village, Pinghu Town, Longgang Dist. Shenzhen City. China.

Tested by:
Neutron Engineering Inc. EMC Laboratory
Date of Receipt: Mar. 25, 2010
Date of Test:
Mar. 25, 2010 ~ Apr. 10, 2010

Testing Engineer : Jeff Yang
(Jeff Yang)
Technical Manager : Vic Chiu
(Vic Chiu)
Authorized Signatory : Steven Lu
(Steven Lu)

NEUTRON ENGINEERING INC.

B1, No.37, Lane 365, Yang Guang St., NeiHu District 114., Taipei, Taiwan
TEL : (02) 2657-3299 FAX : (02) 2657-3331



Declaration

Neutron represents to the client that testing is done in accordance with standard procedures as applicable and that test instruments used has been calibrated with the standards traceable to National Measurement Laboratory (**NML**) of **R.O.C.**, or National Institute of Standards and Technology (**NIST**) of **U.S.A.**

Neutron's reports apply only to the specific samples tested under conditions. It is manufacture's responsibility to ensure that additional production units of this model are manufactured with the identical electrical and mechanical components. **Neutron** shall have no liability for any declarations, inferences or generalizations drawn by the client or others from **Neutron** issued reports.

Neutron's reports must not be used by the client to claim product endorsement by the authorities or any agency of the Government.

This report is the confidential property of the client. As a mutual protection to the clients, the public and **Neutron-self**, extracts from the test report shall not be reproduced except in full with **Neutron's** authorized written approval.

Neutron's laboratory quality assurance procedures are in compliance with the **ISO Guide 17025** requirements, and accredited by the conformity assessment authorities listed in this test report.

Limitation

For the use of the authority's logo is limited unless the Test Standard(s)/Scope(s)/Item(s) mentioned in this test report is (are) included in the conformity assessment authorities acceptance respective.



Table of Contents	Page
1 . CERTIFICATION	6
2 . SUMMARY OF TEST RESULTS	7
2.1 TEST FACILITY	8
2.2 MEASUREMENT UNCERTAINTY	8
3 . GENERAL INFORMATION	9
3.1 GENERAL DESCRIPTION OF EUT	9
3.2 DESCRIPTION OF TEST MODES	11
3.3 TABLE OF PARAMETERS OF TEXT SOFTWARE SETTING	11
3.4 BLOCK DIGRAM SHOWING THE CONFIGURATION OF SYSTEM TESTED	12
3.5 DESCRIPTION OF SUPPORT UNITS(CONDUCTED MODE)	13
4 . EMC EMISSION TEST	14
4.1 CONDUCTED EMISSION MEASUREMENT	14
4.1.1 POWER LINE CONDUCTED EMISSION LIMITS	14
4.1.2 MEASUREMENT INSTRUMENTS LIST AND SETTING	14
4.1.3 TEST PROCEDURE	15
4.1.4 DEVIATION FROM TEST STANDARD	15
4.1.5 TEST SETUP	15
4.1.6 EUT OPERATING CONDITIONS	16
4.1.7 TEST RESULTS	17
4.2 RADIATED EMISSION MEASUREMENT	19
4.2.1 RADIATED EMISSION LIMITS	19
4.2.2 MEASUREMENT INSTRUMENTS LIST ANS SETTING	20
4.2.3 TEST PROCEDURE	22
4.2.4 DEVIATION FROM TEST STANDARD	22
4.2.5 TEST SETUP	23
4.2.6 EUT OPERATING CONDITIONS	23
4.2.7 TEST RESULTS (BETWEEN30 – 1000 MHZ)	24
4.2.8 TEST RESULTS (ABOVE 1000 MHZ)	26
4.2.9 TEST RESULTS (RESTRICTED BANDS REQUIREMENTS)	38
5 . NUMBER OF HOPPING CHANNEL	42
5.1 APPLIED PROCEDURES / LIMIT	42
5.1.1 MEASUREMENT INSTRUMENTS LIST AND SETTING	42
5.1.2 TEST PROCEDURE	42
5.1.3 DEVIATION FROM STANDARD	42
5.1.4 TEST SETUP	42
5.1.5 EUT OPERATION CONDITIONS	42



Table of Contents	Page
5.1.6 TEST RESULTS	43
6 . AVERAGE TIME OF OCCUPANCY	44
6.1 APPLIED PROCEDURES / LIMIT	44
6.1.1 MEASUREMENT INSTRUMENTS LIST	44
6.1.2. TEST PROCEDURES	44
6.1.3. TEST SETUP LAYOUT	44
6.1.4. TEST DEVIATION	44
6.1.5. EUT OPERATION DURING TEST	44
6.1.6. RESULTS OF OCCUPIED BANDWIDTH AND SPREAD-SPECTRUM BANDWIDTH	45
7 . HOPPING CHANNEL SEPARATION MEASUREMENT	47
7.1 APPLIED PROCEDURES / LIMIT	47
7.1.1 MEASUREMENT INSTRUMENTS LIST AND SETTING	47
7.1.2 TEST PROCEDURE	47
7.1.3 DEVIATION FROM STANDARD	47
7.1.4 TEST SETUP	47
7.1.5 EUT OPERATION CONDITIONS	47
7.1.6 TEST RESULTS	48
8 . BANDWIDTH TEST	50
8.1 APPLIED PROCEDURES / LIMIT	50
8.1.1 MEASUREMENT INSTRUMENTS LIST AND SETTING	50
8.1.2 TEST PROCEDURE	50
8.1.3 DEVIATION FROM STANDARD	50
8.1.4 TEST SETUP	50
8.1.5 EUT OPERATION CONDITIONS	50
8.1.6 TEST RESULTS	51
9 . PEAK OUTPUT POWER TEST	53
9.1 APPLIED PROCEDURES / LIMIT	53
9.1.1 MEASUREMENT INSTRUMENTS LIST AND SETTING	53
9.1.2 TEST PROCEDURE	53
9.1.3 DEVIATION FROM STANDARD	53
9.1.4 TEST SETUP	53
9.1.5 EUT OPERATION CONDITIONS	53
9.1.6 TEST RESULTS	54
10 . ANTENNA CONDUCTED SPURIOUS EMISSION	56
10.1 APPLIED PROCEDURES / LIMIT	56
10.1.1 MEASUREMENT INSTRUMENTS LIST AND SETTING	56
10.1.2 TEST PROCEDURE	56
10.1.3 DEVIATION FROM STANDARD	56



1. CERTIFICATION

Equipment : 2.4G Wireless Receiver
Brand Name : Sysgration
Model Name : R07-M
Applicant : Sysgration Ltd.
Factory : Sysgration(Shenzhen) Ltd.
Address : Egongling Village, Pinghu Town, Longgang Dist. Shenzhen City. China.
Test Item : ENGINEERING SAMPLE
Date of Test : Mar. 25, 2010 ~ Apr. 10, 2010
Standards : FCC Part15, Subpart C(15.247) / ANSI C63.4 : 2003

The above equipment has been tested and found compliance with the requirement of the relative standards by Neutron Engineering Inc. EMC Laboratory.

The test data, data evaluation, and equipment configuration contained in our test report (Ref No. NEI-FCCP-1-1003C232) were obtained utilizing the test procedures, test instruments, test sites that has been accredited by the Authority of NVLAP and TAF according to the ISO-17025 quality assessment standard and technical standard(s).



2. SUMMARY OF TEST RESULTS

Test procedures according to the technical standards:

FCC Part15 (15.247) , Subpart C			
Standard Section	Test Item	Judgment	Remark
15.207	Conducted Emission	N/A	Note(1)
15.247 (c)	Antenna conducted Spurious Emission	PASS	
15.247 (a)(1)	Hopping Channel Separation	PASS	
15.247 (b)(1)	Peak Output Power	PASS	
15.247 (c)	Radiated Spurious Emission	PASS	
15.247 (b)(1)	Number of Hopping Frequency	PASS	
15.247 (a)(1)	Dwell Time	PASS	
15.205	Restricted Bands	PASS	
15.203	Antenna Requirement	PASS	
1.1307 1.1310 2.1091 2.1093	RF Exposure Compliance	PASS	

NOTE:

- (1) " N/A " denotes test is not applicable in this Test Report
- (2) The EUT used new battery.



2.1 TEST FACILITY

The test facilities used to collect the test data in this report is **DG-C03/CB03** at the location of No.3,Jinshagang 1st Road, ShiXia, Dalang Town, Dong Guan, China.523792
 Neutron's test firm number is 319330

2.2 MEASUREMENT UNCERTAINTY

The reported uncertainty of measurement $y \pm U$, where expanded uncertainty **U** is based on a standard uncertainty multiplied by a coverage factor of **k=2**, providing a level of confidence of approximately **95 %**.

A. Conducted Measurement :

Test Site	Method	Measurement Frequency Range	U , (dB)	NOTE
DG-C03	ANSI	150 KHz ~ 30MHz	1.94	

B. Radiated Measurement :

Test Site	Method	Measurement Frequency Range	Ant. H / V	U , (dB)	NOTE
CB03	ANSI	30MHz ~ 200MHz	V	3.82	
		30MHz ~ 200MHz	H	3.60	
		200MHz ~ 1,000MHz	V	3.86	
		200MHz ~ 1,000MHz	H	3.94	



3. GENERAL INFORMATION

3.1 GENERAL DESCRIPTION OF EUT

Equipment	2.4G Wireless Receiver	
Trade Name	Sysgration	
Model Name	R07-M	
OEM Brand/Model Name	GE / 99905	
Model Difference	N/A	
Product Description	The EUT is a 2.4G Wireless Receiver	
	Operation Frequency:	2418~2464 MHz
	Modulation Type:	FHSS
	Bit Rate of Transmitter	GFSK(1Mbps)
	Number Of Channel	46 CH
	Antenna Designation:	Please see Note 3.
	Antenna Gain(Peak)	Please see Note 3.
	Output Power:	-15.84 dBm
	Based on the application, features, or specification exhibited in User's Manual, the EUT is considered as an ITE/Computing Device. More details of EUT technical specification, please refer to the User's Manual.	
Channel List	Please refer to the Note 2.	
Power Source	DC Voltage supplied from PC system	
Power Rating	AC 120V/60Hz	
Connecting I/O Port(s)	Please refer to the User's Manual	
Products Covered	N/A	
EUT Modification(s)	N/A	

Note:

1. For a more detailed features description, please refer to the manufacturer's specifications or the User's Manual.



2.

Channel	Frequency (MHz)	Channel	Frequency (MHz)
1	2418	28	2446
2	2419	29	2447
3	2420	30	2448
4	2421	31	2449
5	2422	32	2450
6	2423	33	2451
7	2424	34	2452
8	2425	35	2453
9	2426	36	2454
10	2427	37	2455
11	2428	38	2456
12	2429	39	2457
13	2430	40	2458
14	2431	41	2459
15	2432	42	2460
16	2433	43	2461
17	2434	44	2462
18	2435	45	2463
19	2436	46	2464
20	2437		
21	2438		
22	2440		
23	2441		
24	2442		
25	2443		
26	2444		
27	2445		

3. Table for Filed Antenna

Ant.	Brand	Model Name	Antenna Type	Connector	Gain (dBi)
1	N/A	N/A	Printed Antenna	N/A	2.12



3.2 DESCRIPTION OF TEST MODES

To investigate the maximum EMI emission characteristics generates from EUT, the test system was pre-scanning tested base on the consideration of following EUT operation mode or test configuration mode which possible have effect on EMI emission level. Each of these EUT operation mode(s) or test configuration mode(s) mentioned above was evaluated respectively.

Pretest Mode	Description
Mode 1	CH01
Mode 2	CH22
Mode 3	CH46

For Conducted Emission	
Final Test Mode	Description
-	“N/A” denotes test is not applicable in this Test Report

For Radiated Emission	
Final Test Mode	Description
Mode 1	CH01
Mode 2	CH22
Mode 3	CH46

Note:

- (1) The measurements are performed at the highest, middle, lowest available channels.
- (2) The EUT use new battery.

3.3 TABLE OF PARAMETERS OF TEXT SOFTWARE SETTING

During testing channel & power controlling software provided by the customer was used to control the operating channel as well as the output power level. The RF output power selection is for the setting of RF output power expected by the customer and is going to be fixed on the firmware of the final end product power parameters of FHSS

Test software Version	Test program: Hardware control		
Frequency	2418 MHz	2440 MHz	2464 MHz
Parameters(1Mbps)	N/A	N/A	N/A

3.4 BLOCK DIGRAM SHOWING THE CONFIGURATION OF SYSTEM TESTED

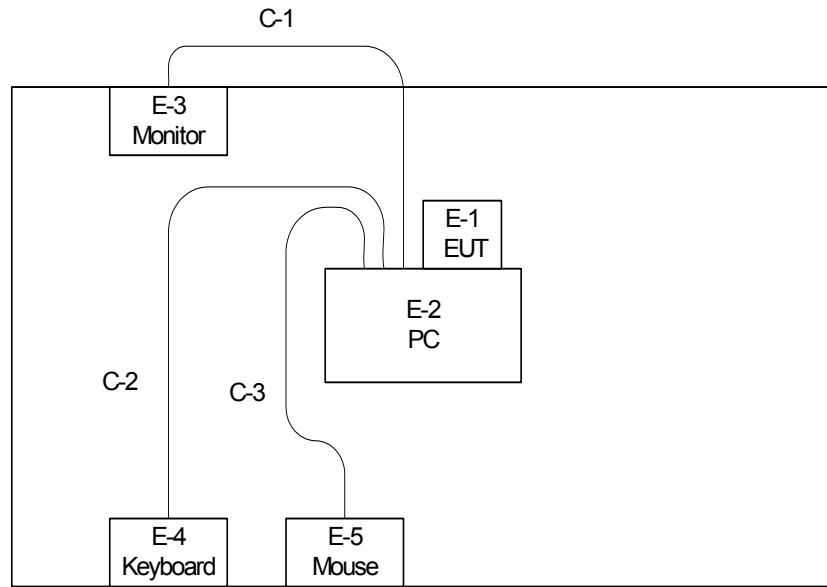

C-1: D-Sub Cable
C-2: USB Cable
C-3: USB Cable



3.5 DESCRIPTION OF SUPPORT UNITS(CONDUCTED MODE)

The EUT has been tested as an independent unit together with other necessary accessories or support units. The following support units or accessories were used to form a representative test configuration during the tests.

Item	Equipment	Mfr/Brand	Model/Type No.	FCC ID	Series No.	Note
E-1	2.4G Wireless Receiver	Sysgration	R07-M	HQXR07-M	N/A	EUT
E-2	PC	Lenovo	M4600V	DOC	SS0840636	
E-3	LCD monitor	Dell	E177FPc	DOC	CNOFJ179-64180-6AG-1WNS	
E-4	USB Keyboard	Lenovo	SK-8815(L)	DOC	00975811	
E-5	USB Mouse	Lenovo	MO28UOL	DOC	23-122591	

Item	Shielded Type	Ferrite Core	Length	Note
C-1	YES	YES	1.5M	
C-2	YES	YES	1.8M	
C-3	YES	YES	1.8M	

Note:

- (1) The support equipment was authorized by Declaration of Confirmation.
- (2) For detachable type I/O cable should be specified the length in cm in 『Length』 column.



4. EMC EMISSION TEST

4.1 CONDUCTED EMISSION MEASUREMENT

4.1.1 POWER LINE CONDUCTED EMISSION Limits (Frequency Range 150KHz-30MHz)

FREQUENCY (MHz)	Class A (dBuV)		Class B (dBuV)		Standard
	Quasi-peak	Average	Quasi-peak	Average	
0.15 -0.5	79.00	66.00	66 - 56 *	56 - 46 *	CISPR
0.50 -5.0	73.00	60.00	56.00	46.00	CISPR
5.0 -30.0	73.00	60.00	60.00	50.00	CISPR

0.15 -0.5	79.00	66.00	66 - 56 *	56 - 46 *	FCC
0.50 -5.0	73.00	60.00	56.00	46.00	FCC
5.0 -30.0	73.00	60.00	60.00	50.00	FCC

Note:

- (1) The tighter limit applies at the band edges.
- (2) The limit of " * " marked band means the limitation decreases linearly with the logarithm of the frequency in the range.

4.1.2 MEASUREMENT INSTRUMENTS LIST AND SETTING

Item	Kind of Equipment	Manufacturer	Type No.	Serial No.	Calibrated until
1	LISN	EMCO	3816/2	00052765	Jun.01.2010
2	LISN	Rolf Heine	NNB-2-16Z	99044	Jun.01.2010
3	50Ω Terminator	SHX	TF2-3G-A	08122901	Jun.01.2010
4	Transient Limiter	Agilent	11947A	3107A03668	Jun.01.2010
5	Test Cable	N/A	C-06_C03	N/A	Nov.16.2010
6	EMI TEST RECEIVER	R&S	ESCS30	8333641017	Jun.02.2010

Remark: " N/A" denotes No Model No. , Serial No. or No Calibration specified.

The following table is the setting of the receiver

Receiver Parameters	Setting
Attenuation	10 dB
Start Frequency	0.15 MHz
Stop Frequency	30 MHz
IF Bandwidth	9 kHz

4.1.3 TEST PROCEDURE

- a. The EUT was placed 0.4 meters from the horizontal ground plane with EUT being connected to the power mains through a line impedance stabilization network (LISN). All other support equipments powered from additional LISN(s). The LISN provide 50 Ohm/ 50uH of coupling impedance for the measuring instrument.
- b. Interconnecting cables that hang closer than 40 cm to the ground plane shall be folded back and forth in the center forming a bundle 30 to 40 cm long.
- c. I/O cables that are not connected to a peripheral shall be bundled in the center. The end of the cable may be terminated, if required, using the correct terminating impedance. The overall length shall not exceed 1 m.
- d. LISN at least 80 cm from nearest part of EUT chassis.
- e. For the actual test configuration, please refer to the related Item –EUT Test Photos.

4.1.4 DEVIATION FROM TEST STANDARD

No deviation

4.1.5 TEST SETUP

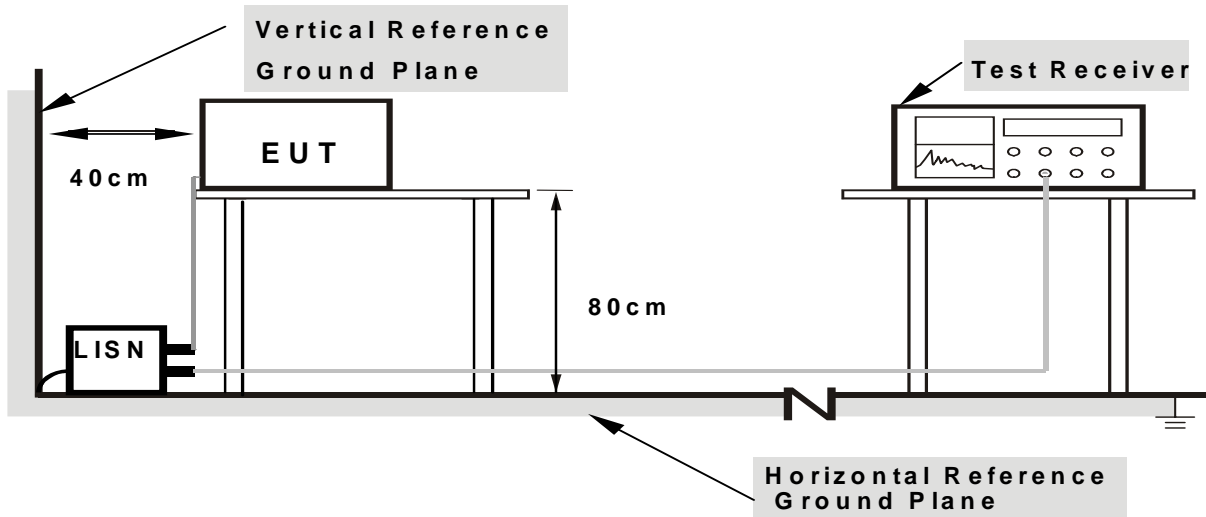

- Note: 1. Support units were connected to second LISN.**
2. Both of LISNs (AMN) are 80 cm from EUT and at least 80 cm from other units and other metal planes



4.1.6 EUT OPERATING CONDITIONS

The EUT was configured for testing in a typical fashion (as a customer would normally use it). The EUT has been programmed to continuously transmit during test. This operating condition was tested and used to collect the included data.



4.1.7 TEST RESULTS

EUT :	2.4G Wireless Receiver	Model Name :	R07-M
Temperature :	26 °C	Relative Humidity :	49%
Pressure :	1010hPa	Test Power :	AC 120V/60Hz
Test Mode :	Normal Link		

Freq. (MHz)	Terminal L/N	Measured(dBuV)		Limits(dBuV)		Margin (dB)	Note
		QP-Mode	AV-Mode	QP-Mode	AV-Mode		
0.20	Line	44.48	*	63.81	53.81	-19.33	(QP)
0.26	Line	36.95	*	61.46	51.46	-24.51	(QP)
0.33	Line	33.87	*	59.54	49.54	-25.67	(QP)
0.39	Line	30.20	*	58.04	48.04	-27.84	(QP)
0.70	Line	31.59	*	56.00	46.00	-24.41	(QP)
17.56	Line	31.18	*	60.00	50.00	-28.82	(QP)

Remark

- (1) All readings are QP Mode value unless otherwise stated AVG in column of Note. If the QP Mode Measured value compliance with the QP Limits and lower than AVG Limits, the EUT shall be deemed to meet both QP & AVG Limits and then only QP Mode was measured, but AVG Mode didn't perform. In this case, a "*" marked in AVG Mode column of Interference Voltage Measured.
- (2) Measuring frequency range from 150KHz to 30MHz.

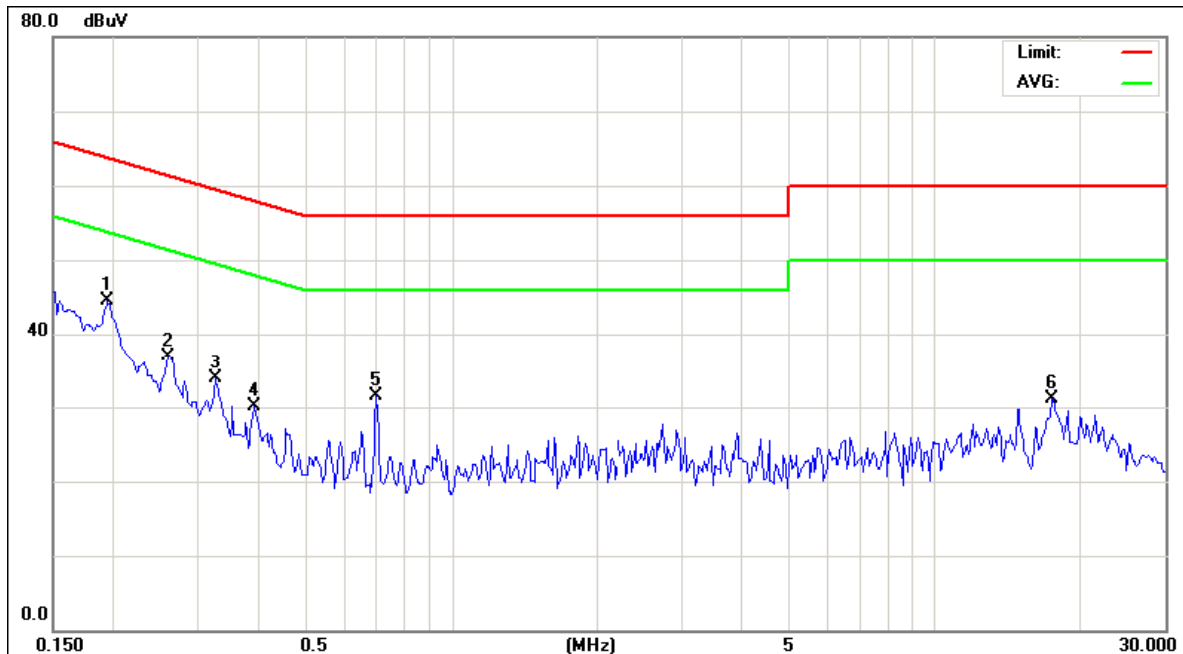



EUT :	2.4G Wireless Receiver	Model Name :	R07-M
Temperature :	26 °C	Relative Humidity :	49%
Pressure :	1010hPa	Test Power :	AC 120V/60Hz
Test Mode :	Normal Link		

Freq. (MHz)	Terminal L/N	Measured(dBuV)		Limits(dBuV)		Margin (dB)	Note
		QP-Mode	AV-Mode	QP-Mode	AV-Mode		
0.20	Neutral	44.47	*	63.81	53.81	-19.34	(QP)
0.26	Neutral	37.32	*	61.49	51.49	-24.17	(QP)
0.33	Neutral	34.60	*	59.54	49.54	-24.94	(QP)
0.70	Neutral	30.01	*	56.00	46.00	-25.99	(QP)
2.41	Neutral	30.84	*	56.00	46.00	-25.16	(QP)
21.52	Neutral	30.89	*	60.00	50.00	-29.11	(QP)

Remark

- (1) Reading in which marked as QP means measurements by using are Quasi-Peak Mode with Detector BW=9KHz; SPA setting in RBW=10KHz,VBW =10KHz, Swp. Time = 0.2 sec./MHz. Reading in which marked as AV means measurements by using are Average Mode with instrument setting in RBW=10KHz,VBW=10KHz, Swp. Time =0.2 sec./MHz.
- (2) All readings are QP Mode value unless otherwise stated AVG in column of Note. If the QP Mode Measured value compliance with the QP Limits and lower than AVG Limits, the EUT shall be deemed to meet both QP & AVG Limits and then only QP Mode was measured, but AVG Mode didn't perform. In this case, a " * " marked in AVG Mode column of Interference Voltage Measured.
- (3) Measuring frequency range from 150KHz to 30MHz.

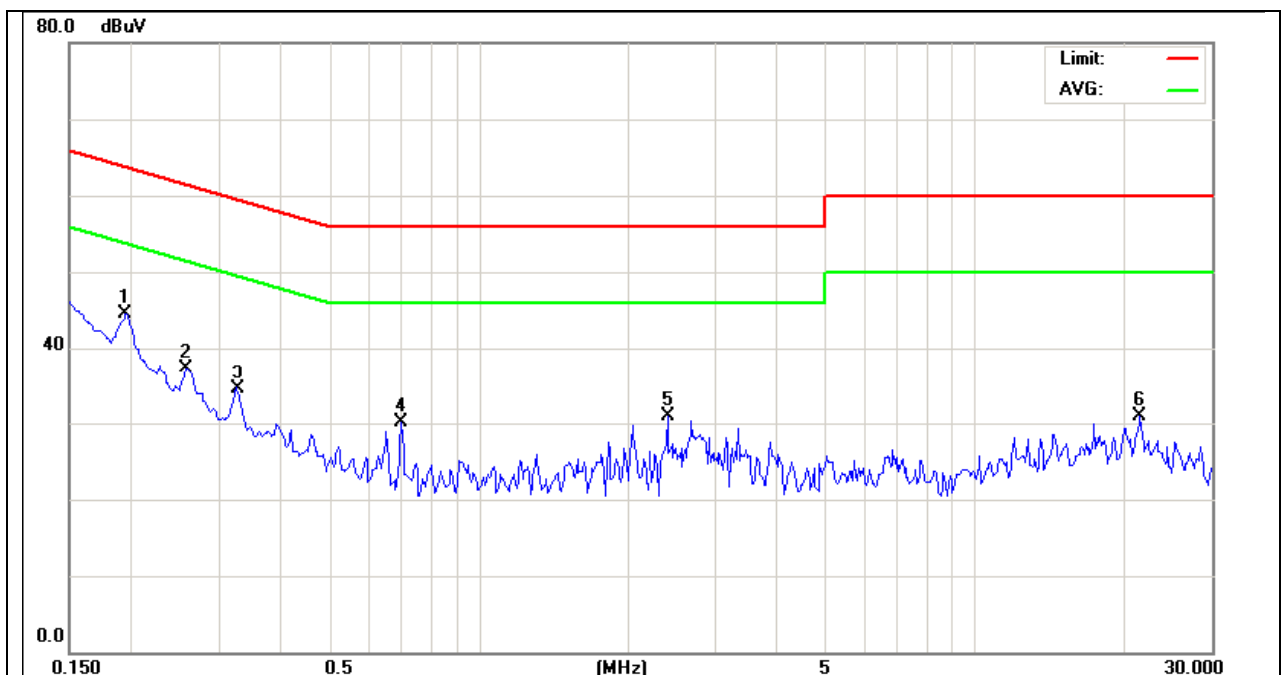



4.2 RADIATED EMISSION MEASUREMENT

4.2.1 RADIATED EMISSION LIMITS (Frequency Range 9kHz-1000MHz)

20dBc in any 100 kHz bandwidth outside the operating frequency band. In case the emission fall within the restricted band specified on 15.205(a), then the 15.209(a) limit in the table below has to be followed.

Frequencies (MHz)	Field Strength (micorvolts/meter)	Measurement Distance (meters)
0.009~0.490	2400/F(KHz)	300
0.490~1.705	24000/F(KHz)	30
1.705~30.0	30	30
30~88	100	3
88~216	150	3
216~960	200	3
Above 960	500	3

LIMITS OF RADIATED EMISSION MEASUREMENT (Above 1000MHz)

FREQUENCY (MHz)	Class A (dBuV/m) (at 3M)		Class B (dBuV/m) (at 3M)	
	PEAK	AVERAGE	PEAK	AVERAGE
Above 1000	80	60	74	54

Notes:

- (1) The limit for radiated test was performed according to FCC PART 15C.
- (2) The tighter limit applies at the band edges.
- (3) Emission level (dBuV/m)=20log Emission level (uV/m).

FREQUENCY RANGE OF RADIATED MEASUREMENT (For unintentional radiators)

Highest frequency generated or Upper frequency of measurement used in the device or on which the device operates or tunes (MHz)	Range (MHz)
Below 1.705	30
1.705 – 108	1000
108 – 500	2000
500 – 1000	5000
Above 1000	5 th harmonic of the highest frequency or 40 GHz, whichever is lower



4.2.2 MEASUREMENT INSTRUMENTS LIST AND SETTING

Item	Kind of Equipment	Manufacturer	Type No.	Serial No.	Calibrated until
1	Antenna	ETS	3115	00075789	May.13.2010
2	Amplifier	Agilent	8449B	3008A02274	Jun.01.2010
3	Spectrum	Agilent	E4408B	US39240143	Nov.16.2010
4	Test Cable	HUBER+SUHNER	CB03 High Fre	N/A	May.04.2010
5	Antenna	Schwarbeck	VULB9160	9160-3232	Jun.01.2010
6	Amplifier	HP	8447D	2944A09673	Jun.01.2010
7	Test Receiver	R&S	ESCI	100895	Jun.02.2010
8	Test Cable	N/A	C-01_CB03	N/A	Jul.06.2010
9	Controller	CT	SC100	N/A	N/A

Remark: " N/A" denotes No Model Name / Serial No. and No Calibration specified.

Spectrum Parameter	Setting
Attenuation	Auto
Start Frequency	1000 MHz
Stop Frequency	10th carrier harmonic
RB / VB (emission in restricted band)	1 MHz / 1 MHz for Peak, Average=PK-dycty cycle

Receiver Parameter	Setting
Attenuation	Auto
Start ~ Stop Frequency	9kHz~150kHz / RB 200Hz for QP
Start ~ Stop Frequency	150kHz~30MHz / RB 9kHz for QP
Start ~ Stop Frequency	30MHz~1000MHz / RB 120kHz for QP



Neutron Engineering Inc.

DUTY CYCLE : TX 2418MHz (1Mbps)

Dwell time=ON/ON+OFF

ON:4.8msec

ON+OFF:(total time):48msec

Dwell time:10%

AV=PK+20 log(Dwell time)

AV=PK-20

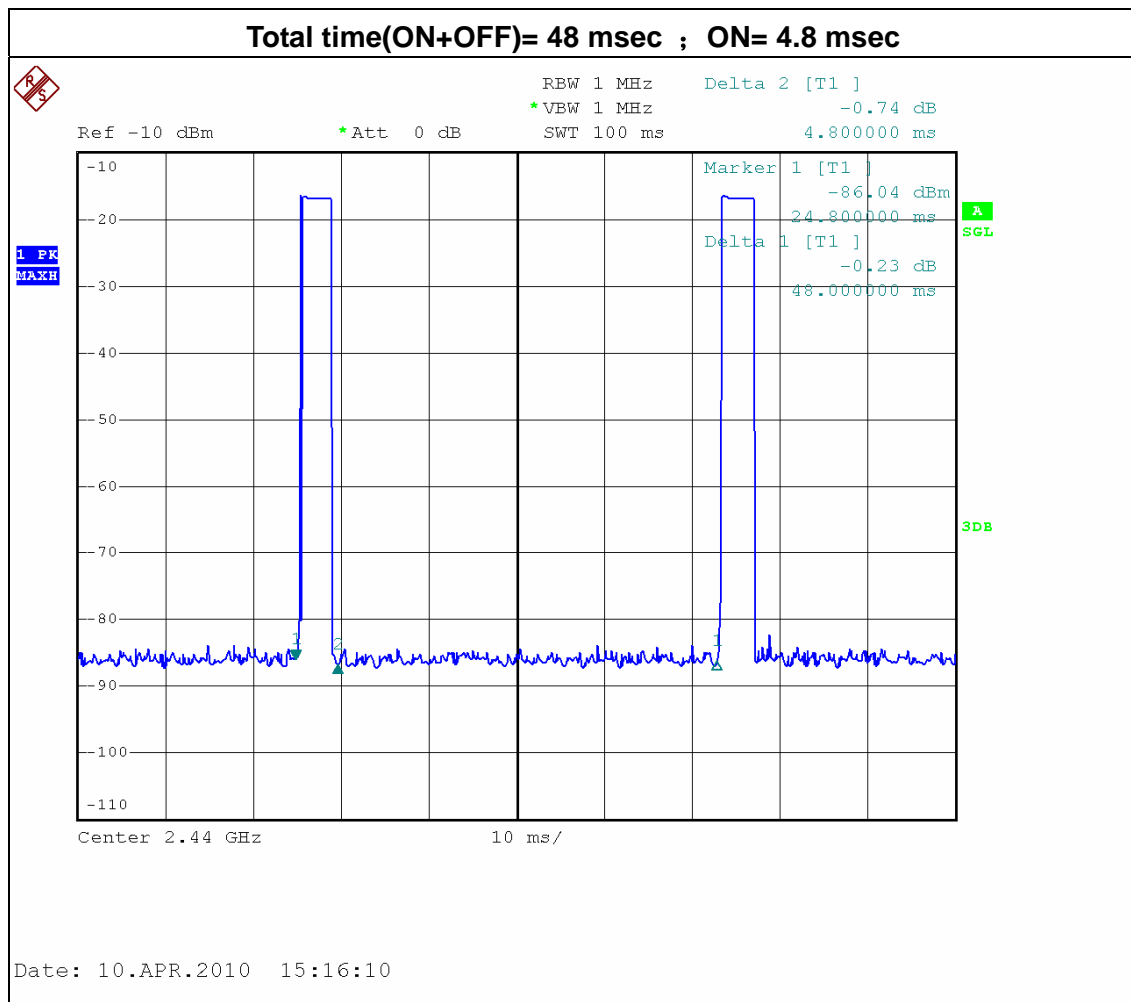



4.2.3 TEST PROCEDURE

- a. The measuring distance of at 3 m shall be used for measurements at frequency up to 1GHz. For frequencies above 1GHz, any suitable measuring distance may be used.
- b. The EUT was placed on the top of a rotating table 0.8 meters above the ground at a 3 meter open area test site. The table was rotated 360 degrees to determine the position of the highest radiation.
- c. The height of the equipment or of the substitution antenna shall be 0.8 m; the height of the test antenna shall vary between 1 m to 4 m. Both horizontal and vertical polarizations of the antenna are set to make the measurement.
- d. The initial step in collecting conducted emission data is a spectrum analyzer peak detector mode pre-scanning the measurement frequency range. Significant peaks are then marked and then Quasi Peak detector mode re-measured.
- e. If the Peak Mode measured value compliance with and lower than Quasi Peak Mode Limit, the EUT shall be deemed to meet QP Limits and then no additional QP Mode measurement performed.
- f. For the actual test configuration, please refer to the related Item –EUT Test Photos.

4.2.4 DEVIATION FROM TEST STANDARD

No deviation

4.2.5 TEST SETUP

(A) Radiated Emission Test Set-Up Frequency Below 1 GHz

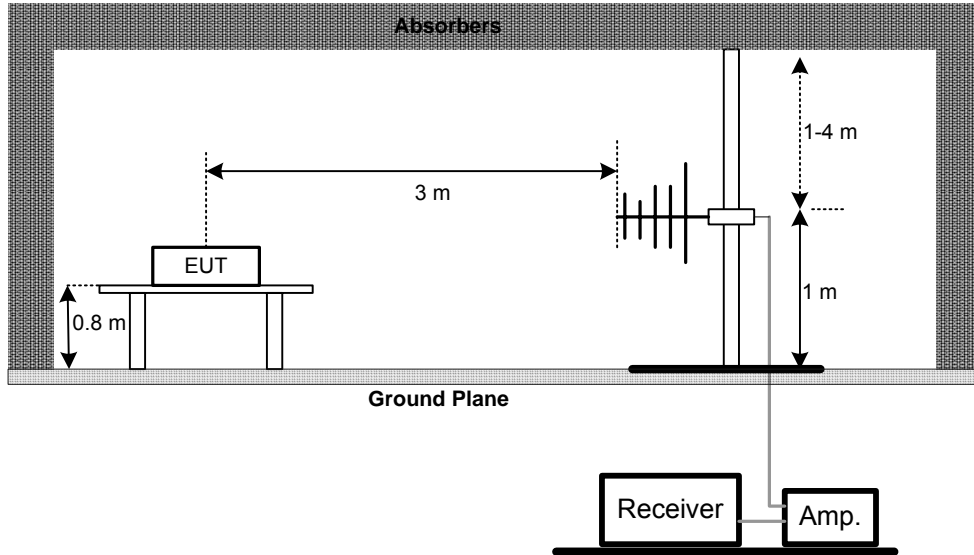

(B) Radiated Emission Test Set-Up Frequency Above 1 GHz

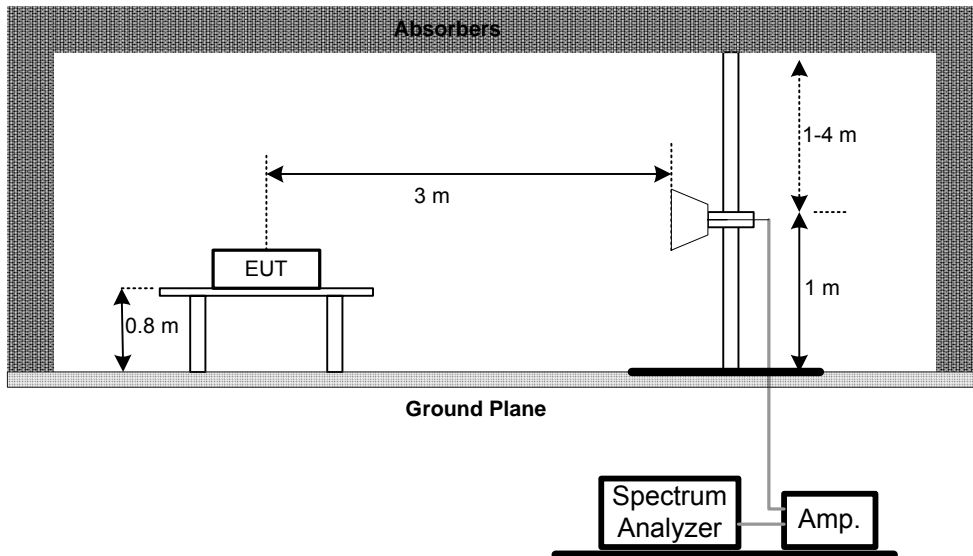

4.2.6 EUT OPERATING CONDITIONS

The EUT tested system was configured as the statements of 4.1.6 Unless otherwise a special operating condition is specified in the follows during the testing.



4.2.7 TEST RESULTS (BETWEEN 30 – 1000 MHZ)

EUT :	2.4G Wireless Receiver	Model Name :	R07-M
Temperature :	27 °C	Relative Humidity :	50 %
Pressure :	1010 hPa	Test Voltage :	AC 120V/60Hz
Test Mode :	TX Mode 2418MHz		

Freq. (MHz)	Ant. H/V	Reading(RA) (dBuV)	Corr.Factor(CF) (dB)	Measured(FS) (dBuV/m)	Limits(QP) (dBuV/m)	Margin (dB)	Note
167.33	V	47.97	-17.07	30.90	43.50	- 12.60	
267.94	V	48.75	-12.96	35.79	46.00	- 10.21	
437.53	V	44.68	-7.63	37.05	46.00	- 8.95	
534.84	V	40.70	-5.28	35.42	46.00	- 10.58	
660.21	V	38.76	-2.25	36.51	46.00	- 9.49	
810.56	V	38.77	-0.47	38.30	46.00	- 7.70	

Remark :

- (1) Reading in which marked as QP or Peak means measurements by using are Quasi-Peak Mode or Peak Mode with Detector BW=120KHz ; SPA setting in RBW=120KHz, VBW =120KHz, Swp. Time = 0.3 sec./MHz .
- (2) All readings are Peak unless otherwise stated QP in column of 『 Note 』 . Peak denotes that the Peak reading compliance with the QP Limits and then QP Mode measurement didn't perform .
- (3) Measuring frequency range from 30MHz to 1000MHz .
- (4) If the peak scan value lower limit more than 20dB, then this signal data does not show in table .

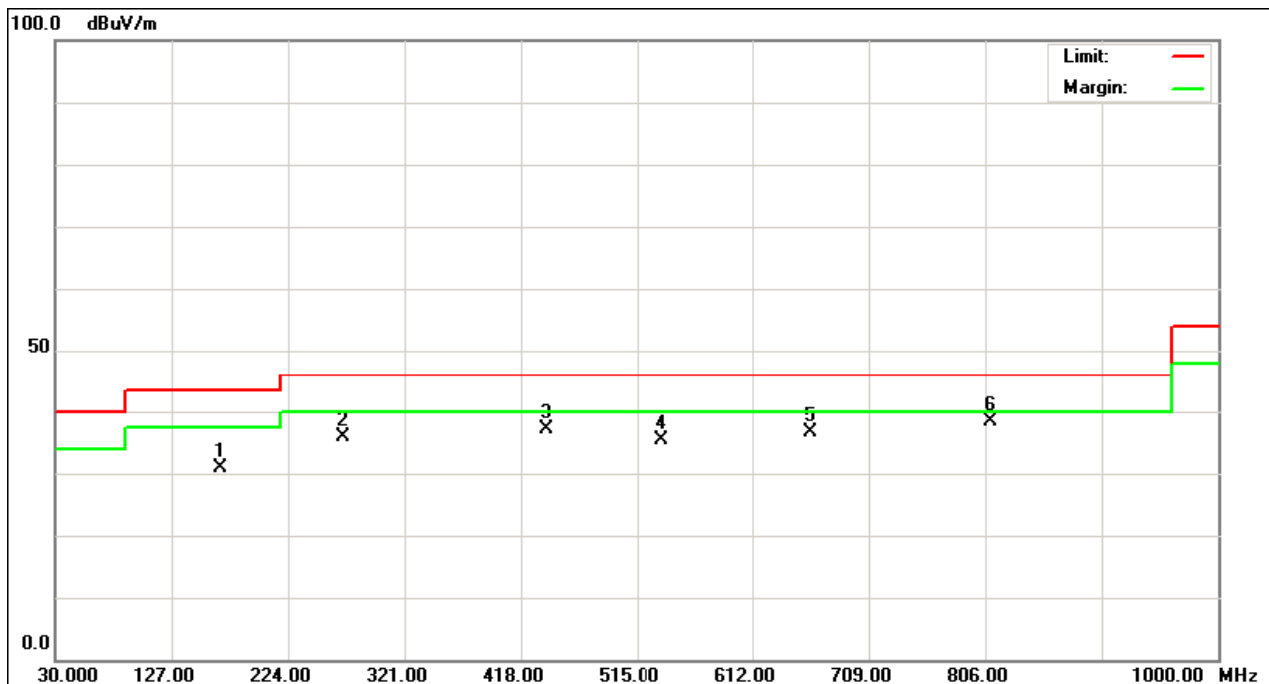



EUT :	2.4G Wireless Receiver	Model Name :	R07-M
Temperature :	27 °C	Relative Humidity :	50 %
Pressure :	1010 hPa	Test Voltage :	AC 120V/60Hz
Test Mode :	TX Mode 2418MHz		

Freq. (MHz)	Ant. H/V	Reading(RA) (dBuV)	Corr.Factor(CF) (dB)	Measured(FS) (dBuV/m)	Limits(QP) (dBuV/m)	Margin (dB)	Note
160.56	H	48.56	-17.32	31.24	43.50	- 12.26	
325.72	H	47.23	-10.92	36.31	46.00	- 9.69	
404.32	H	45.36	-8.31	37.05	46.00	- 8.95	
489.11	H	43.33	-6.79	36.54	46.00	- 9.46	
617.53	H	38.74	-3.01	35.73	46.00	- 10.27	
813.64	H	37.08	-0.42	36.66	46.00	- 9.34	

Remark :

- (1) Reading in which marked as QP or Peak means measurements by using are Quasi-Peak Mode or Peak Mode with Detector BW=120KHz ; SPA setting in RBW=120KHz, VBW =120KHz, Swp. Time = 0.3 sec./MHz ◦
- (2) All readings are Peak unless otherwise stated QP in column of 『 Note 』 . Peak denotes that the Peak reading compliance with the QP Limits and then QP Mode measurement didn't perform ◦
- (3) Measuring frequency range from 30MHz to 1000MHz ◦
- (4) If the peak scan value lower limit more than 20dB, then this signal data does not show in table ◦

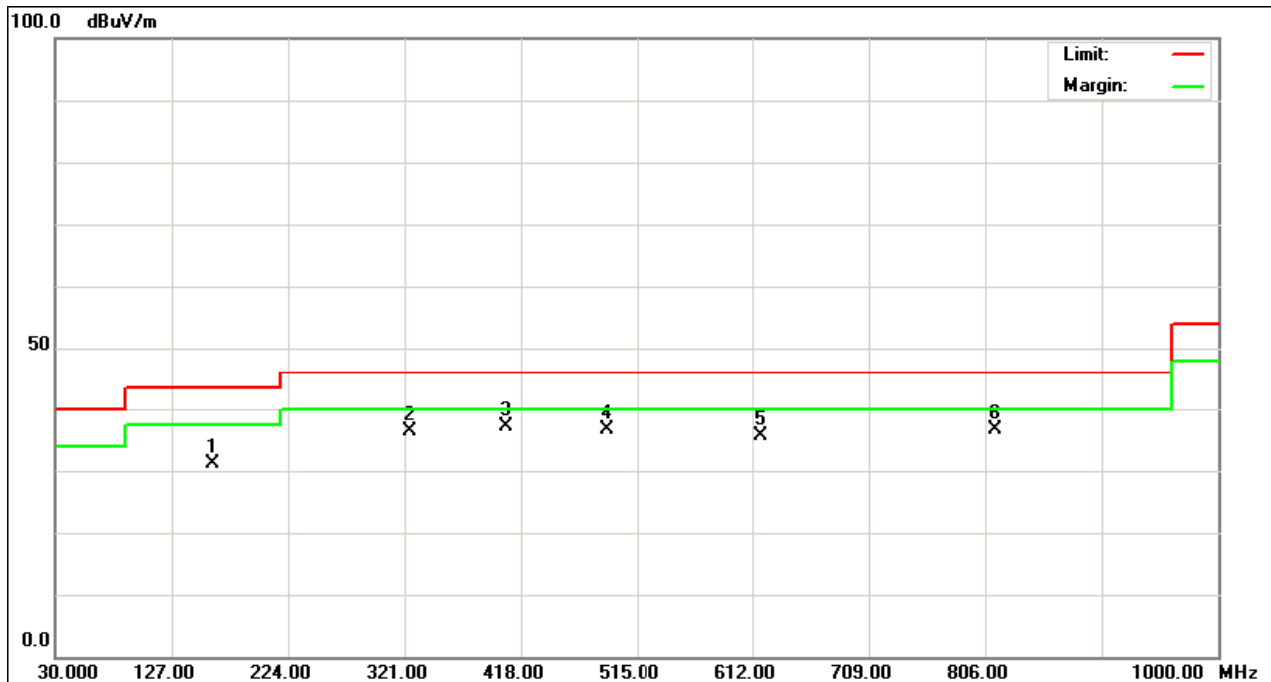



4.2.8 TEST RESULTS (ABOVE 1000 MHZ)

EUT :	2.4G Wireless Receiver	Model Name :	R07-M
Temperature :	27 °C	Relative Humidity :	50 %
Pressure :	1010 hPa	Test Voltage :	AC 120V/60Hz
Test Mode :	TX 2418MHz		

Freq. (MHz)	Ant.Pol. H/V	Reading		Ant./CF CF(dB)	Act.		Limit		Note
		Peak (dBuV)	AV (dBuV)		Peak (dBuV/m)	AV (dBuV/m)	Peak (dBuV/m)	AV (dBuV/m)	
2390.00	V	18.72	-1.28	31.10	49.82	29.82	74.00	54.00	X/E
2418.24	V	40.76	20.76	31.06	71.82	51.82			X/F
4836.81	V	46.05	26.05	4.34	50.39	30.39	74.00	54.00	X/H

Remark :

- (1) All readings are Peak unless otherwise stated QP in column of 『Note』 . Peak denotes that the Peak reading compliance with the QP Limits and then QP Mode measurement didn't perform .
- (2) Measuring frequency range from 30MHz to 1000MHz or the 10th harmonic of highest fundamental frequency . "F" denotes fundamental frequency; "H" denotes spurious frequency. "E" denotes band edge frequency. (This judgment method includes the Band Edge Requirement.)
- (3) Radiated emissions measured in frequency range above 1000MHz were made with an instrument using Peak detector mode and AV detector mode of the emission .
- (4) Data of measurement within this frequency range shown " * " in the table above means the reading of emissions are attenuated more than 20dB below the permissible limits or the field strength is too small to be measured.
- (5) A preamp and high pass filter were used for this test in order to provide sufficient measurement sensitivity.
- (6) EUT Orthogonal Axis :
 "X" - denotes Laid on Table ; "Y" - denotes Vertical Stand ; "Z" - denotes Side Stand
- (7) During the measurements above 1 GHz it is taken care of that the EUT is always within the 3 dB cone of radiation BW of the used antenna
- (8) The average value of fundamental frequency is:
 Average = Peak value + 20log(Duty cycle) · Final AV=PK-20



TX CH01(Above 1000 MHz, Vertical)

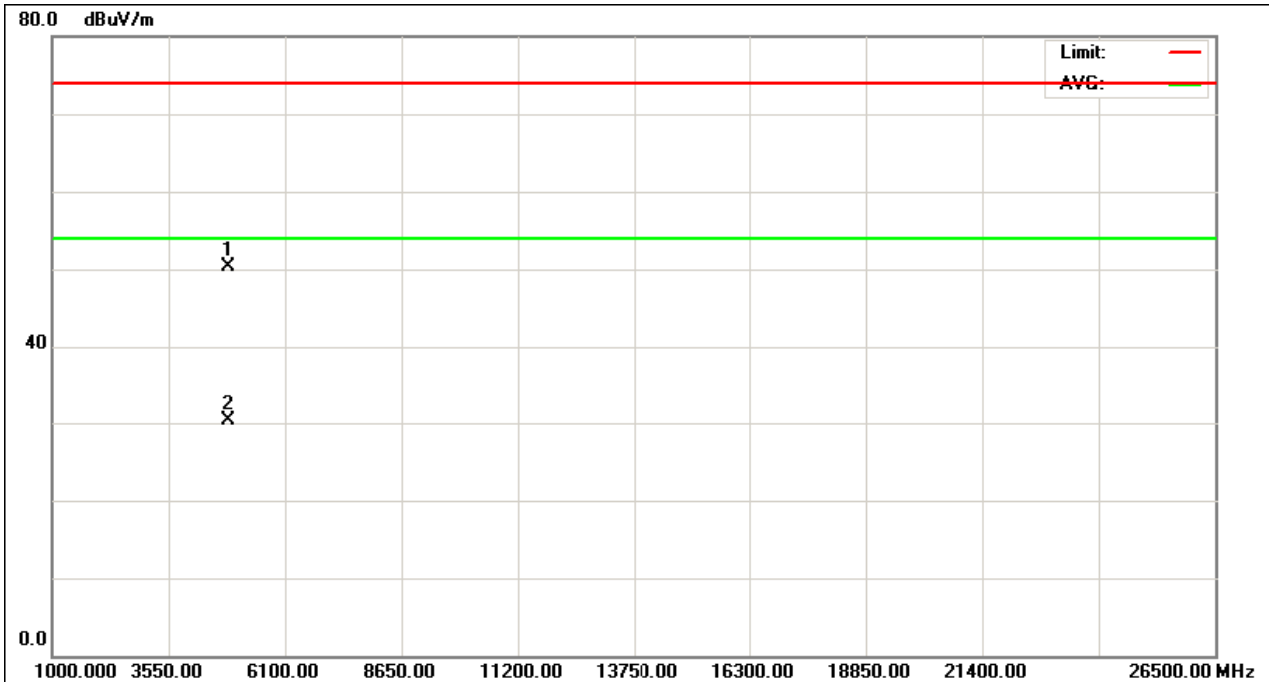
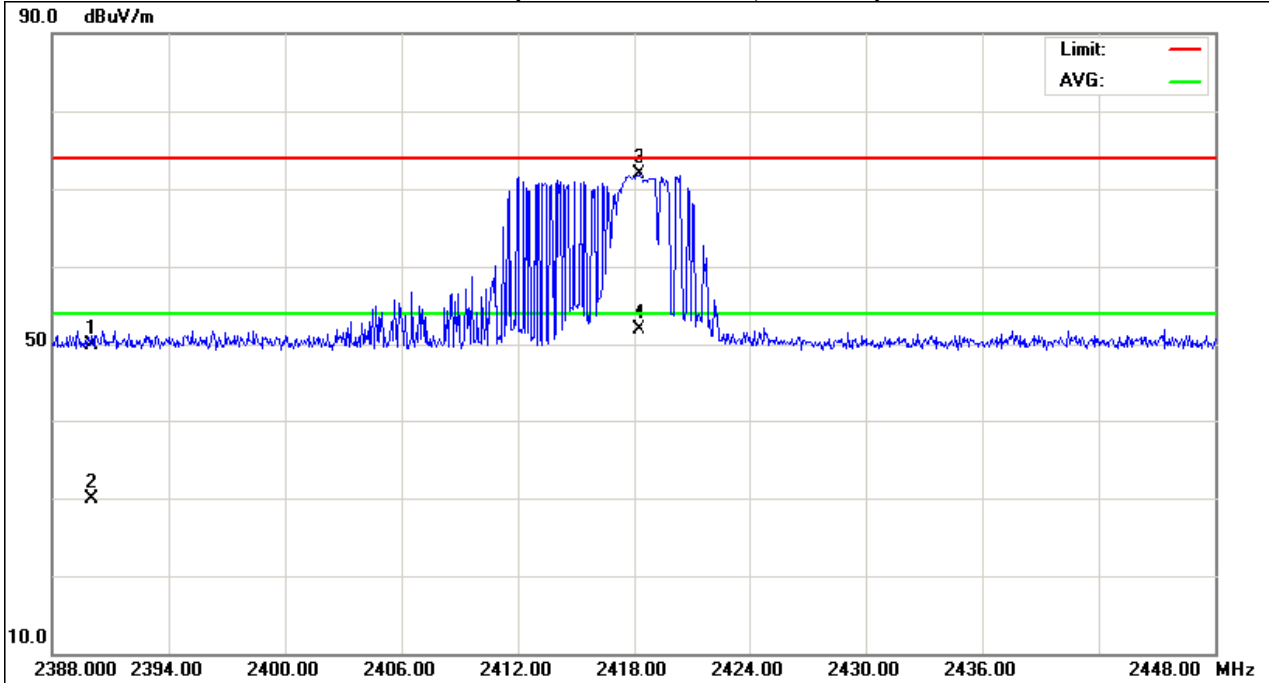



EUT :	2.4G Wireless Receiver	Model Name :	R07-M
Temperature :	27 °C	Relative Humidity :	50 %
Pressure :	1010hPa	Test Voltage :	AC 120V/60Hz
Test Mode :	TX 2418MHz		

Freq. (MHz)	Ant.Pol. H/V	Reading		Ant./CF CF(dB)	Act.		Limit		Note
		Peak (dBuV)	AV (dBuV)		Peak (dBuV/m)	AV (dBuV/m)	Peak (dBuV/m)	AV (dBuV/m)	
2390.00	H	18.39	-1.61	31.10	49.49	29.49	74.00	54.00	X/E
2418.24	H	36.20	11.06	31.06	67.26	42.12			X/F
4836.74	H	45.05	25.05	4.34	49.39	29.39	74.00	54.00	X/H

Remark :

- (1) All readings are Peak unless otherwise stated QP in column of 『Note』 . Peak denotes that the Peak reading compliance with the QP Limits and then QP Mode measurement didn't perform .
- (2) Measuring frequency range from 30MHz to 1000MHz or the 10th harmonic of highest fundamental frequency . "F" denotes fundamental frequency; "H" denotes spurious frequency. "E" denotes band edge frequency. (This judgment method includes the Band Edge Requirement.)
- (3) Radiated emissions measured in frequency range above 1000MHz were made with an instrument using Peak detector mode and AV detector mode of the emission .
- (4) Data of measurement within this frequency range shown " * " in the table above means the reading of emissions are attenuated more than 20dB below the permissible limits or the field strength is too small to be measured.
- (5) A preamp and high pass filter were used for this test in order to provide sufficient measurement sensitivity.
- (6) EUT Orthogonal Axis :
"X" - denotes Laid on Table ; "Y" - denotes Vertical Stand ; "Z" - denotes Side Stand
- (7) During the measurements above 1 GHz it is taken care of that the EUT is always within the 3 dB cone of radiation BW of the used antenna
- (8) The average value of fundamental frequency is:
Average = Peak value + 20log(Duty cycle) · Final AV=PK-20



TX CH01(Above 1000 MHz, Horizontal)

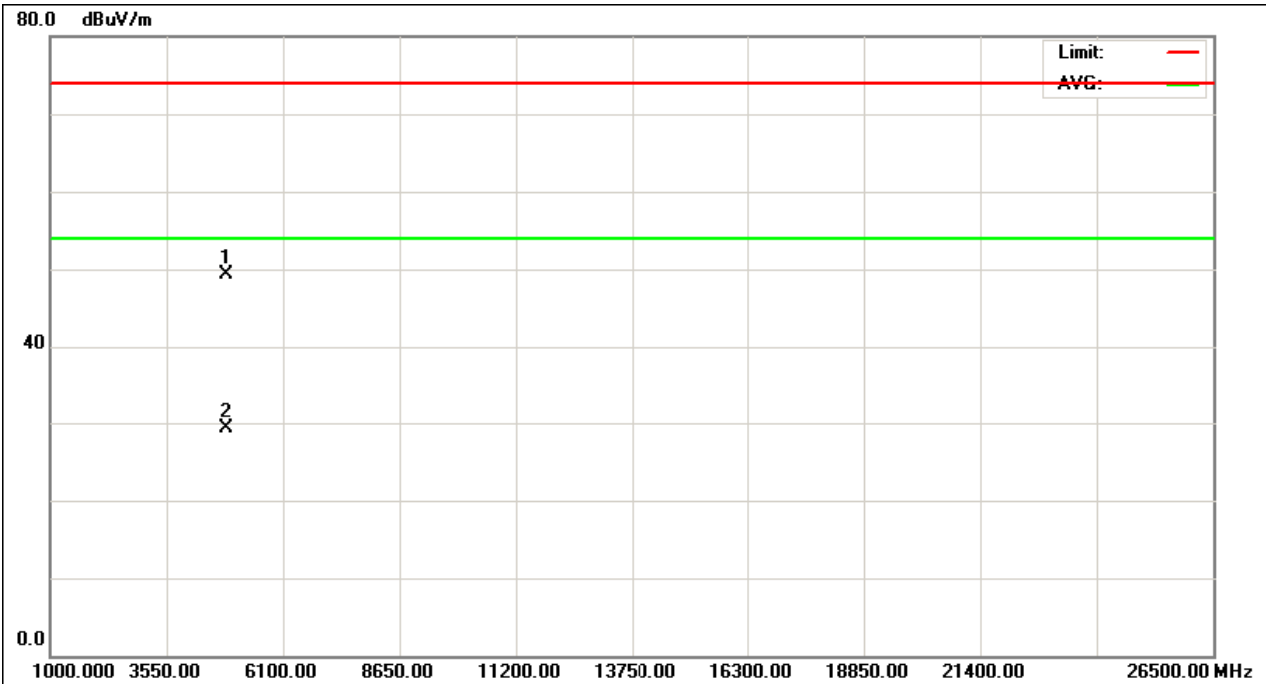
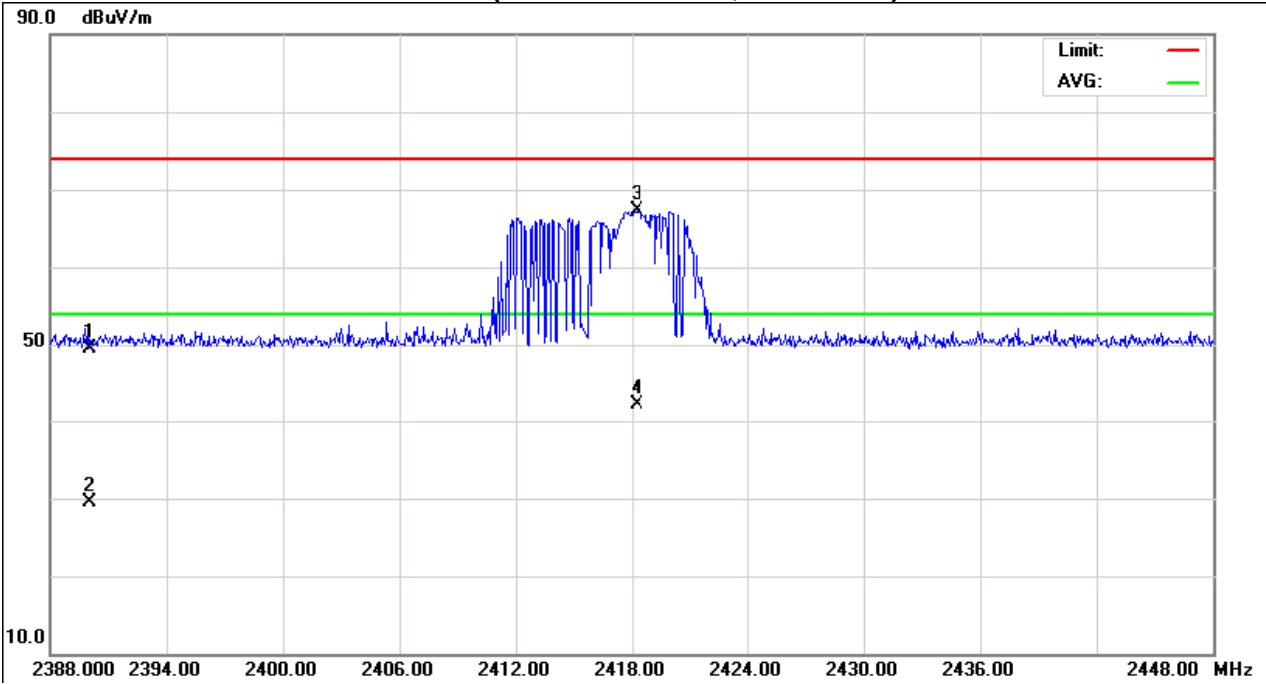



EUT :	2.4G Wireless Receiver	Model Name :	R07-M
Temperature :	27 °C	Relative Humidity :	50 %
Pressure :	1010 hPa	Test Voltage :	AC 120V/60Hz
Test Mode :	TX 2440MHz		

Freq.	Ant.Pol.	Reading		Ant./CF	Act.		Limit		Note
		Peak	AV		Peak	AV	Peak	AV	
(MHz)	H/V	(dBuV)	(dBuV)	CF(dB)	(dBuV/m)	(dBuV/m)	(dBuV/m)	(dBuV/m)	
2440.24	V	42.67	22.67	31.03	73.70	53.70			X/F
4880.13	V	47.54	27.54	4.50	52.04	32.04	74.00	54.00	X/H

Remark :

- (1) All readings are Peak unless otherwise stated QP in column of 『Note』 . Peak denotes that the Peak reading compliance with the QP Limits and then QP Mode measurement didn't perform ◦
- (2) Measuring frequency range from 30MHz to 1000MHz or the 10th harmonic of highest fundamental frequency ◦ "F" denotes fundamental frequency; "H" denotes spurious frequency. "E" denotes band edge frequency. (This judgment method includes the Band Edge Requirement.)
- (3) Radiated emissions measured in frequency range above 1000MHz were made with an instrument using Peak detector mode and AV detector mode of the emission ◦
- (4) Data of measurement within this frequency range shown " * " in the table above means the reading of emissions are attenuated more than 20dB below the permissible limits or the field strength is too small to be measured.
- (5) A preamp and high pass filter were used for this test in order to provide sufficient measurement sensitivity.
- (6) EUT Orthogonal Axis :
 "X" - denotes Laid on Table ; "Y" - denotes Vertical Stand ; "Z" - denotes Side Stand
- (7) During the measurements above 1 GHz it is taken care of that the EUT is always within the 3 dB cone of radiation BW of the used antenna
- (8) The average value of fundamental frequency is:
 Average = Peak value + 20log(Duty cycle) ◦ Final AV=PK-20



TX CH22 (Above 1000 MHz, Vertical)

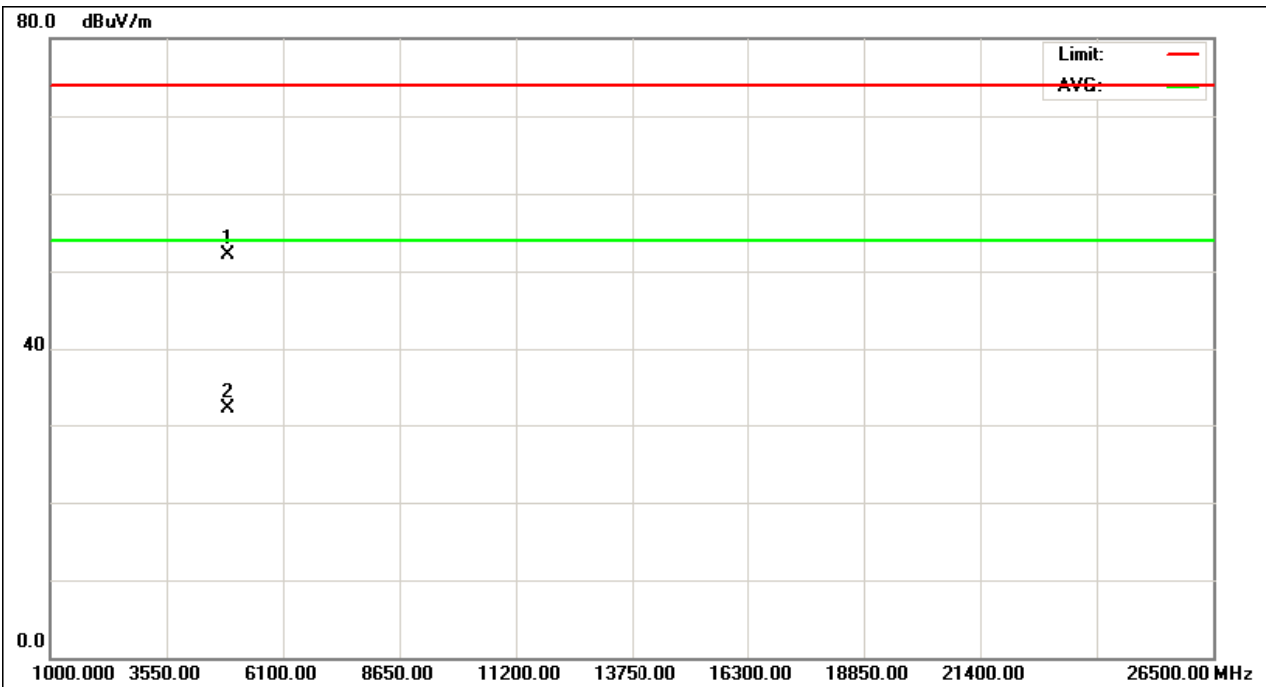
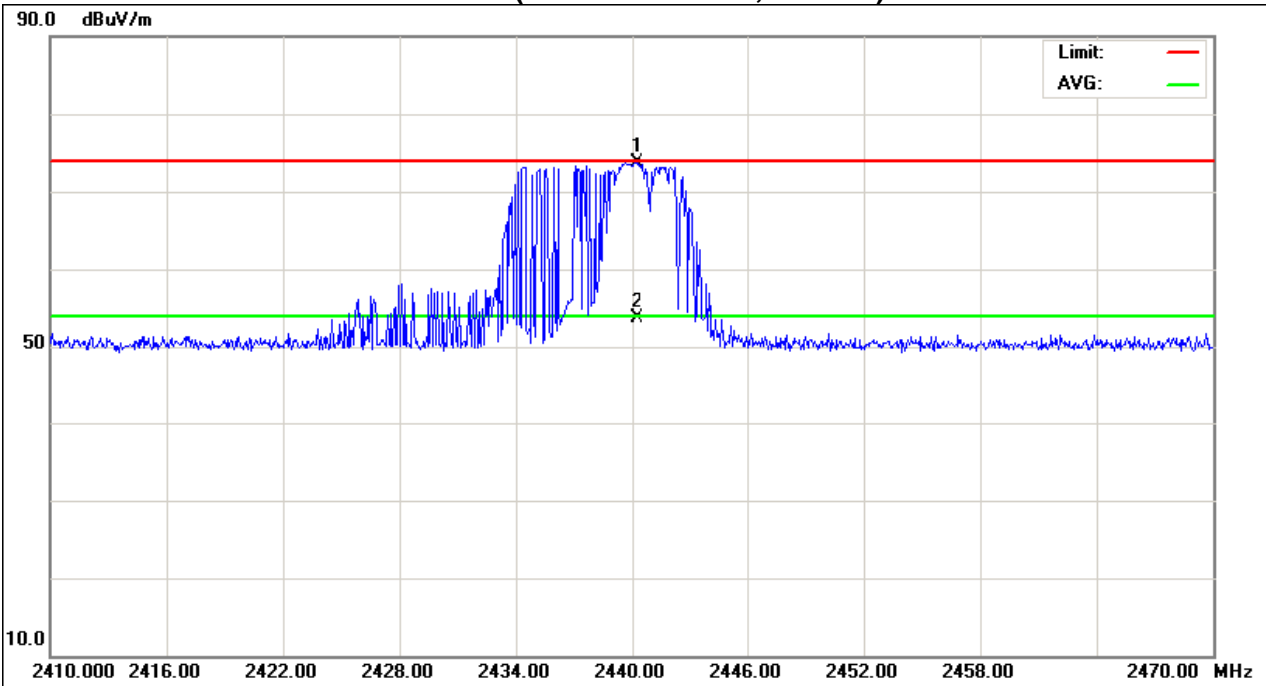



EUT :	2.4G Wireless Receiver	Model Name :	R07-M
Temperature :	27 °C	Relative Humidity :	50 %
Pressure :	1010 hPa	Test Voltage :	AC 120V/60Hz
Test Mode :	TX 2440MHz		

Freq.	Ant.Pol.	Reading		Ant./CF	Act.		Limit		Note
		Peak	AV		Peak	AV	Peak	AV	
(MHz)	H/V	(dBuV)	(dBuV)	CF(dB)	(dBuV/m)	(dBuV/m)	(dBuV/m)	(dBuV/m)	
2439.70	H	39.37	19.37	31.03	70.40	50.40			X/F
4880.80	H	46.15	26.15	4.50	50.65	30.65	74.00	54.00	X/H

Remark :

- (1) All readings are Peak unless otherwise stated QP in column of 『Note』 . Peak denotes that the Peak reading compliance with the QP Limits and then QP Mode measurement didn't perform ◦
- (2) Measuring frequency range from 30MHz to 1000MHz or the 10th harmonic of highest fundamental frequency ◦ “F” denotes fundamental frequency; “H” denotes spurious frequency. “E” denotes band edge frequency. (This judgment method includes the Band Edge Requirement.)
- (3) Radiated emissions measured in frequency range above 1000MHz were made with an instrument using Peak detector mode and AV detector mode of the emission ◦
- (4) Data of measurement within this frequency range shown “ * ” in the table above means the reading of emissions are attenuated more than 20dB below the permissible limits or the field strength is too small to be measured.
- (5) A preamp and high pass filter were used for this test in order to provide sufficient measurement sensitivity.
- (6) EUT Orthogonal Axis :
 “X” - denotes Laid on Table ; “Y” - denotes Vertical Stand ; “Z” - denotes Side Stand
- (7) During the measurements above 1 GHz it is taken care of that the EUT is always within the 3 dB cone of radiation BW of the used antenna
- (8) The average value of fundamental frequency is:
 Average = Peak value + 20log(Duty cycle) ◦ Final AV=PK-20



TX CH22 (Above 1000 MHz, Horizontal)

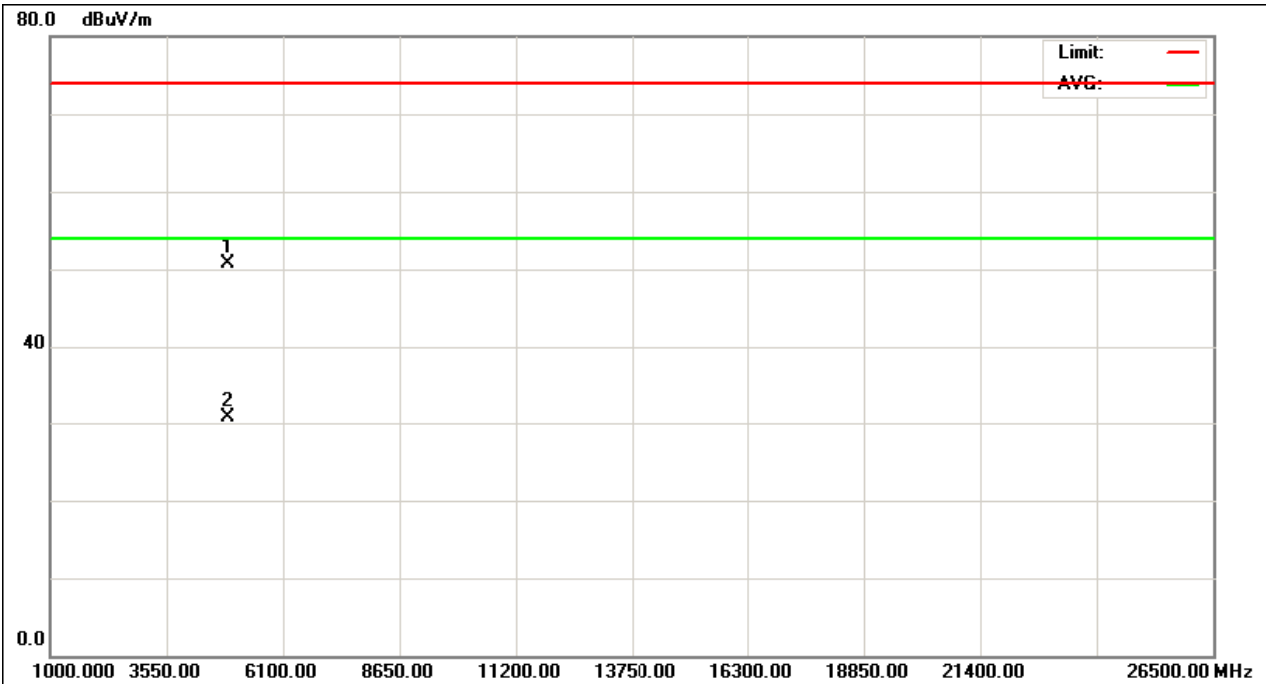
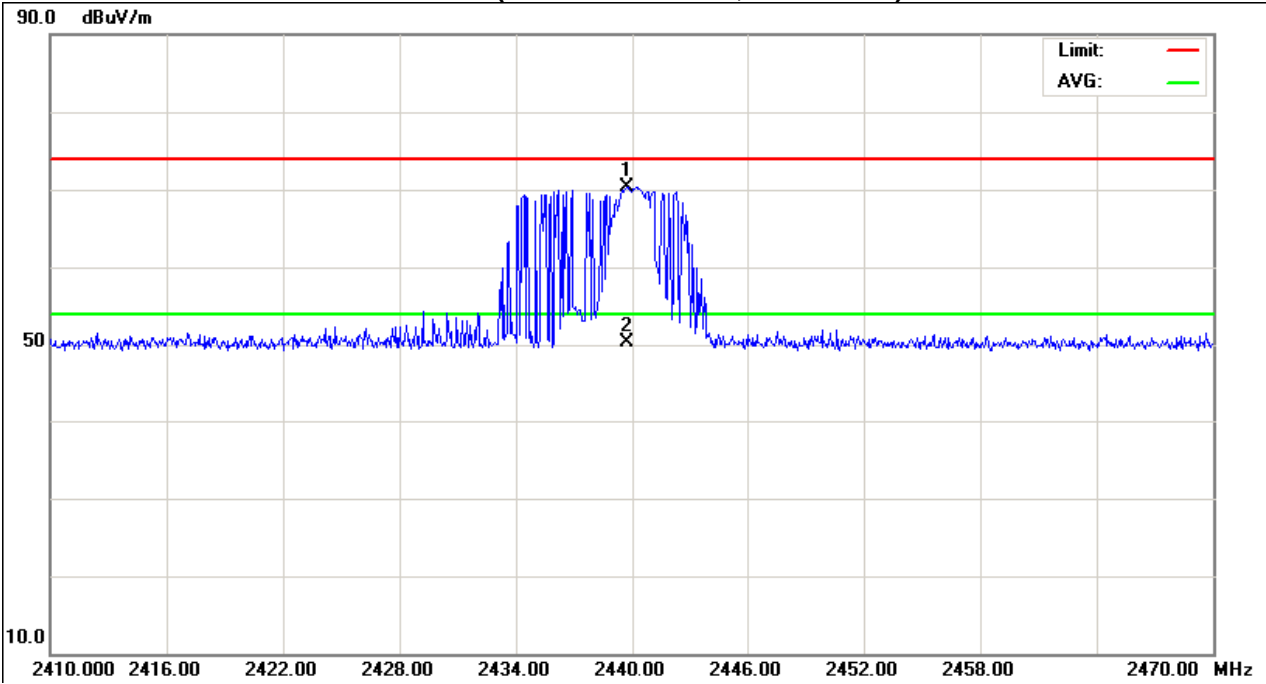



EUT :	2.4G Wireless Receiver	Model Name :	R07-M
Temperature :	27 °C	Relative Humidity :	50 %
Pressure :	1010hPa	Test Voltage :	AC 120V/60Hz
Test Mode :	TX 2464MHz		

Freq.	Ant.Pol.	Reading		Ant./CF	Act.		Limit		Note
		Peak	AV		Peak	AV	Peak	AV	
(MHz)	H/V	(dBuV)	(dBuV)	CF(dB)	(dBuV/m)	(dBuV/m)	(dBuV/m)	(dBuV/m)	
2464.18	V	43.05	23.05	31.00	74.05	54.05			X/F
2483.50	V	18.98	-1.02	30.97	49.95	29.95	74.00	54.00	X/E
4928.35	V	47.82	27.82	4.69	52.51	32.51	74.00	54.00	X/H

Remark :

- (1) All readings are Peak unless otherwise stated QP in column of 『Note』 . Peak denotes that the Peak reading compliance with the QP Limits and then QP Mode measurement didn't perform .
- (2) Measuring frequency range from 30MHz to 1000MHz or the 10th harmonic of highest fundamental frequency . "F" denotes fundamental frequency; "H" denotes spurious frequency. "E" denotes band edge frequency. (This judgment method includes the Band Edge Requirement.)
- (3) Radiated emissions measured in frequency range above 1000MHz were made with an instrument using Peak detector mode and AV detector mode of the emission .
- (4) Data of measurement within this frequency range shown " * " in the table above means the reading of emissions are attenuated more than 20dB below the permissible limits or the field strength is too small to be measured.
- (5) A preamp and high pass filter were used for this test in order to provide sufficient measurement sensitivity.
- (6) EUT Orthogonal Axis :
 "X" - denotes Laid on Table ; "Y" - denotes Vertical Stand ; "Z" - denotes Side Stand
- (7) During the measurements above 1 GHz it is taken care of that the EUT is always within the 3 dB cone of radiation BW of the used antenna
- (8) The average value of fundamental frequency is:
 Average = Peak value + 20log(Duty cycle) · Final AV=PK-20



TX CH46 (Above 1000 MHz, Vertical)

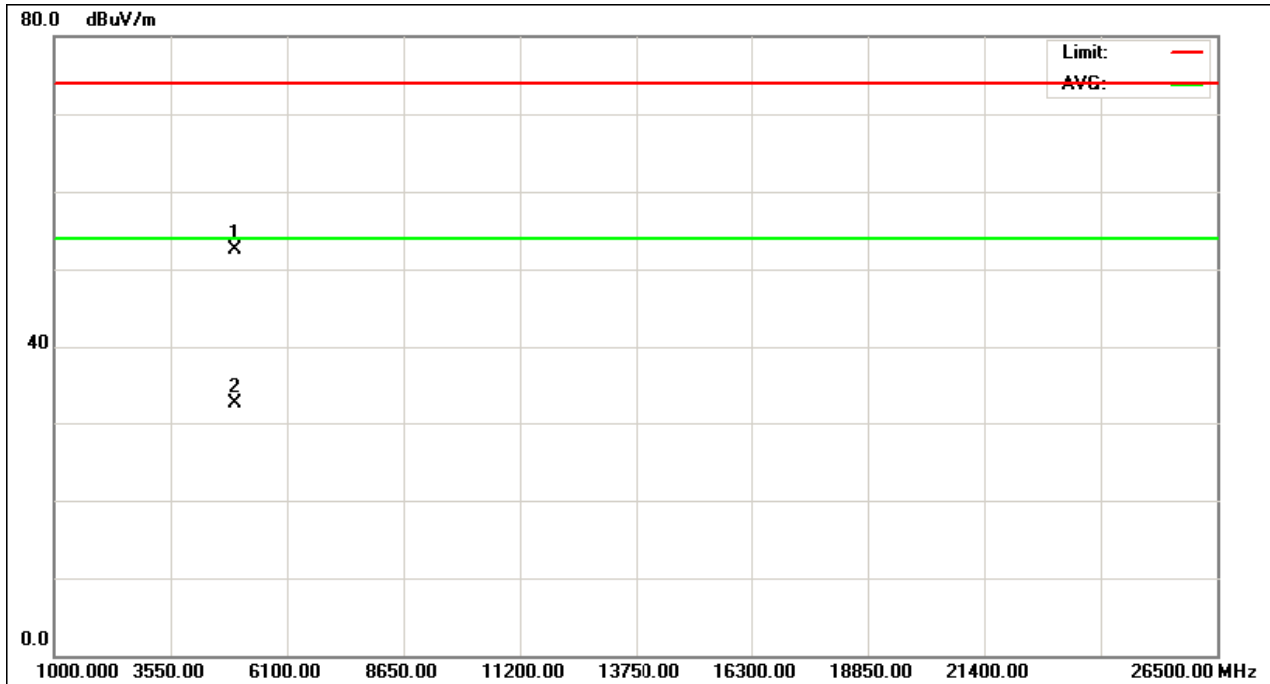
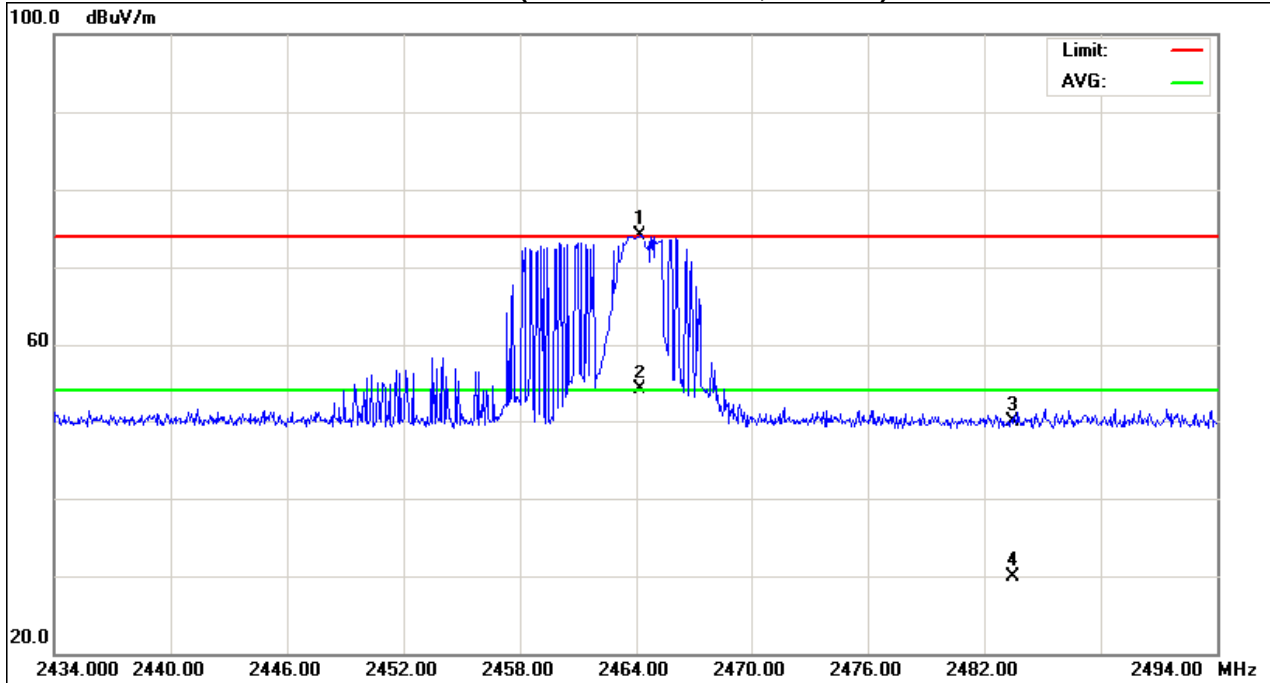



EUT :	2.4G Wireless Receiver	Model Name :	R07-M
Temperature :	27 °C	Relative Humidity :	50 %
Pressure :	1010 hPa	Test Voltage :	AC 120V/60Hz
Test Mode :	TX 2464MHz		

Freq.	Ant.Pol.	Reading		Ant./CF	Act.		Limit		Note
		Peak	AV		Peak	AV	Peak	AV	
(MHz)	H/V	(dBuV)	(dBuV)	CF(dB)	(dBuV/m)	(dBuV/m)	(dBuV/m)	(dBuV/m)	
2464.90	H	40.98	20.98	31.00	71.98	51.98			X/F
2483.50	H	20.62	0.62	30.97	51.59	31.59	74.00	54.00	X/E
4928.76	H	46.14	26.14	4.69	50.83	30.83	74.00	54.00	X/H

Remark :

- (1) All readings are Peak unless otherwise stated QP in column of 『Note』 . Peak denotes that the Peak reading compliance with the QP Limits and then QP Mode measurement didn't perform .
- (2) Measuring frequency range from 30MHz to 1000MHz or the 10th harmonic of highest fundamental frequency .“F” denotes fundamental frequency; “H” denotes spurious frequency. “E” denotes band edge frequency. (This judgment method includes the Band Edge Requirement.)
- (3) Radiated emissions measured in frequency range above 1000MHz were made with an instrument using Peak detector mode and AV detector mode of the emission .
- (4) Data of measurement within this frequency range shown “ * ” in the table above means the reading of emissions are attenuated more than 20dB below the permissible limits or the field strength is too small to be measured.
- (5) A preamp and high pass filter were used for this test in order to provide sufficient measurement sensitivity.
- (6) EUT Orthogonal Axis :
“X” - denotes Laid on Table ; “Y” - denotes Vertical Stand ; “Z” - denotes Side Stand
- (7) During the measurements above 1 GHz it is taken care of that the EUT is always within the 3 dB cone of radiation BW of the used antenna
- (8) The average value of fundamental frequency is:
Average = Peak value + 20log(Duty cycle) · Final AV=PK-20



TX CH46 (Above 1000 MHz, Horizontal)

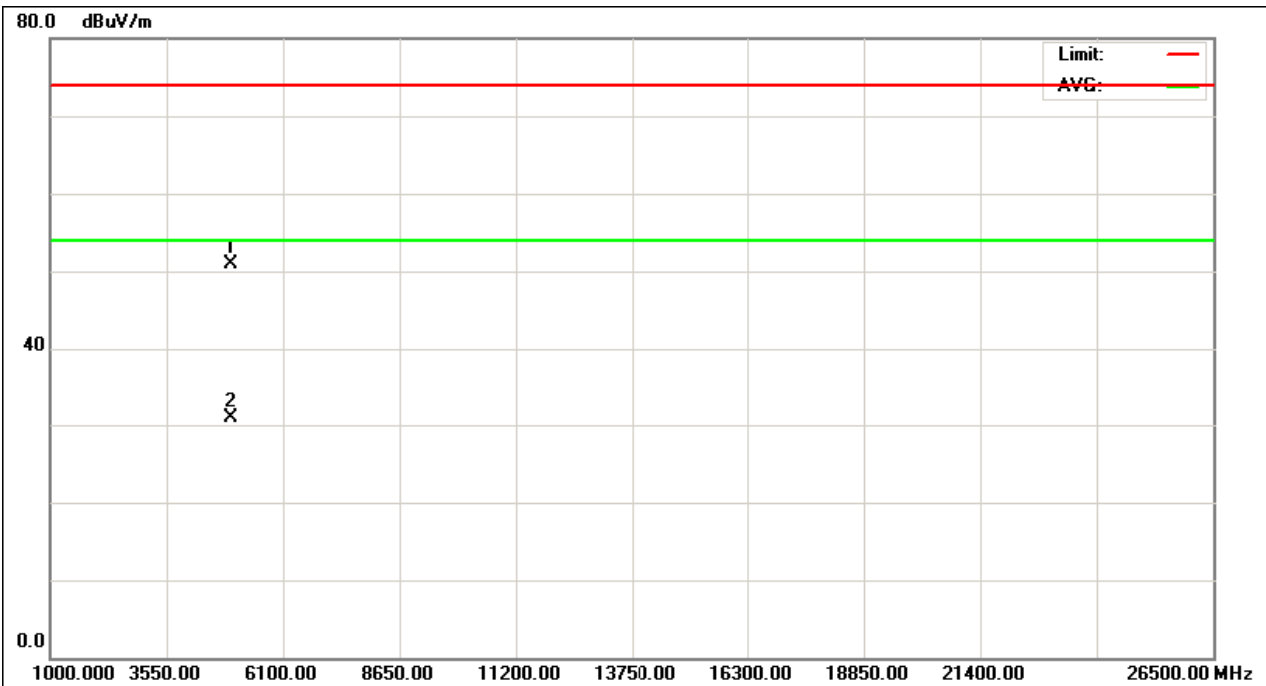
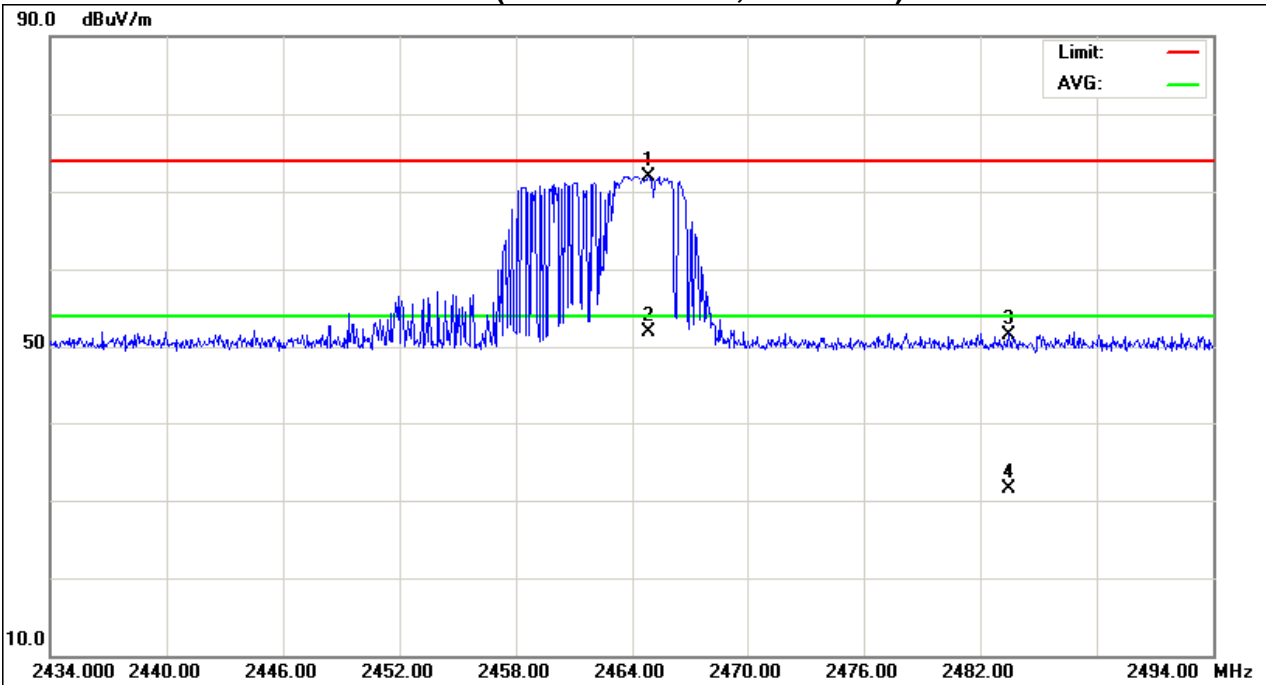



4.2.9 TEST RESULTS (RESTRICTED BANDS REQUIREMENTS)

EUT :	2.4G Wireless Receiver	Model Name :	R07-M
Temperature :	27 °C	Relative Humidity :	50 %
Pressure :	1010 hPa	Test Voltage :	AC 120V/60Hz
Test Mode :	TX 2418MHz/2464MHz		
Note :	1. The transmitter was setup to transmit at the lowest channel (CH01). Then the field strength was measured at 2310-2390 MHz. 2. The transmitter was setup to transmit at the highest channel (CH46). Then the field strength was measured at 2483.5-2500 MHz.		

Freq. (MHz)	Ant.Pol. H/V	Reading		Ant./CF CF(dB)	Act.		Limit		Note
		Peak (dBuV)	AV (dBuV)		Peak (dBuV/m)	AV (dBuV/m)	Peak (dBuV/m)	AV (dBuV/m)	
2390.00	V	18.72	-1.28	31.10	49.82	29.82	74.00	54.00	CH01
2483.50	V	18.98	-1.02	30.97	49.95	29.95	74.00	54.00	CH32

Remark :

- (1) Radiated emissions measured in frequency range above 1000MHz were made with an instrument using Peak detector mode and AV detector mode of the emission .
- (2) EUT Orthogonal Axis :
 "X" - denotes Laid on Table ; "Y" - denotes Vertical Stand ; "Z" - denotes Side Stand
- (3) During the measurements above 1 GHz it is taken care of that the EUT is always within the 3 dB cone of radiation BW of the used antenna
- (4) The average value of fundamental frequency is:
 Average = Peak value + 20log(Duty cycle) · Final AV=PK-20



Restricted Bands Requirements, Vertical CH01

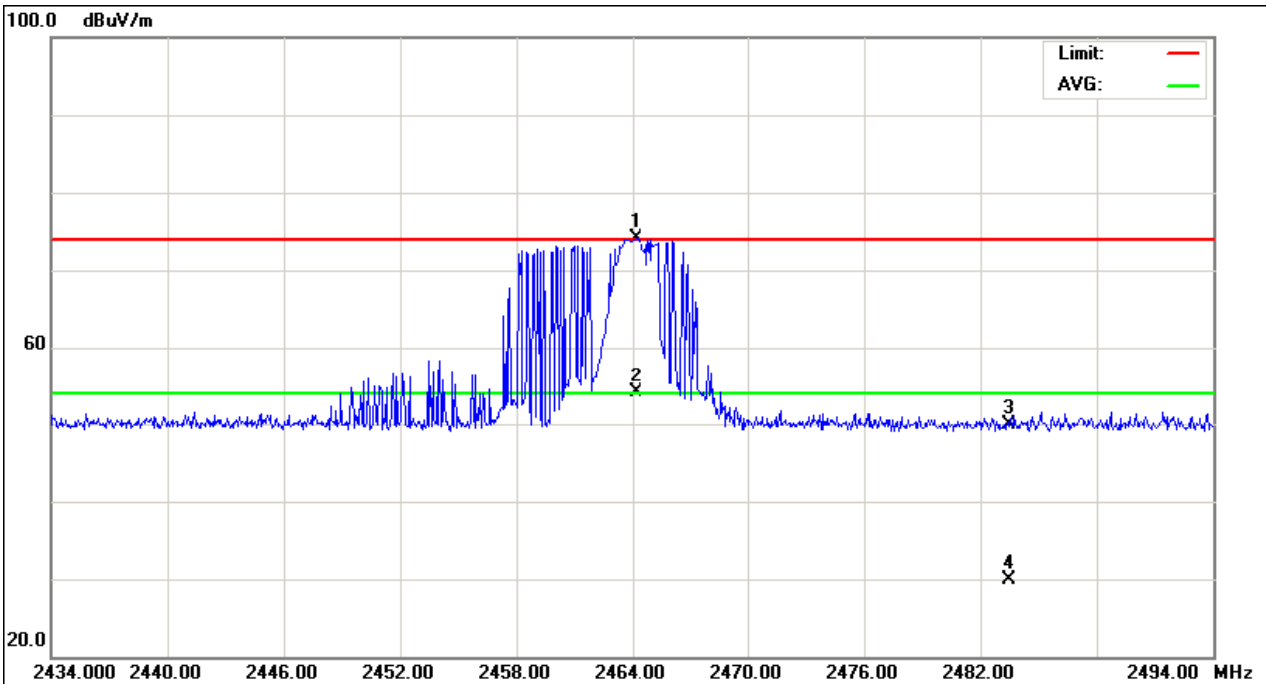
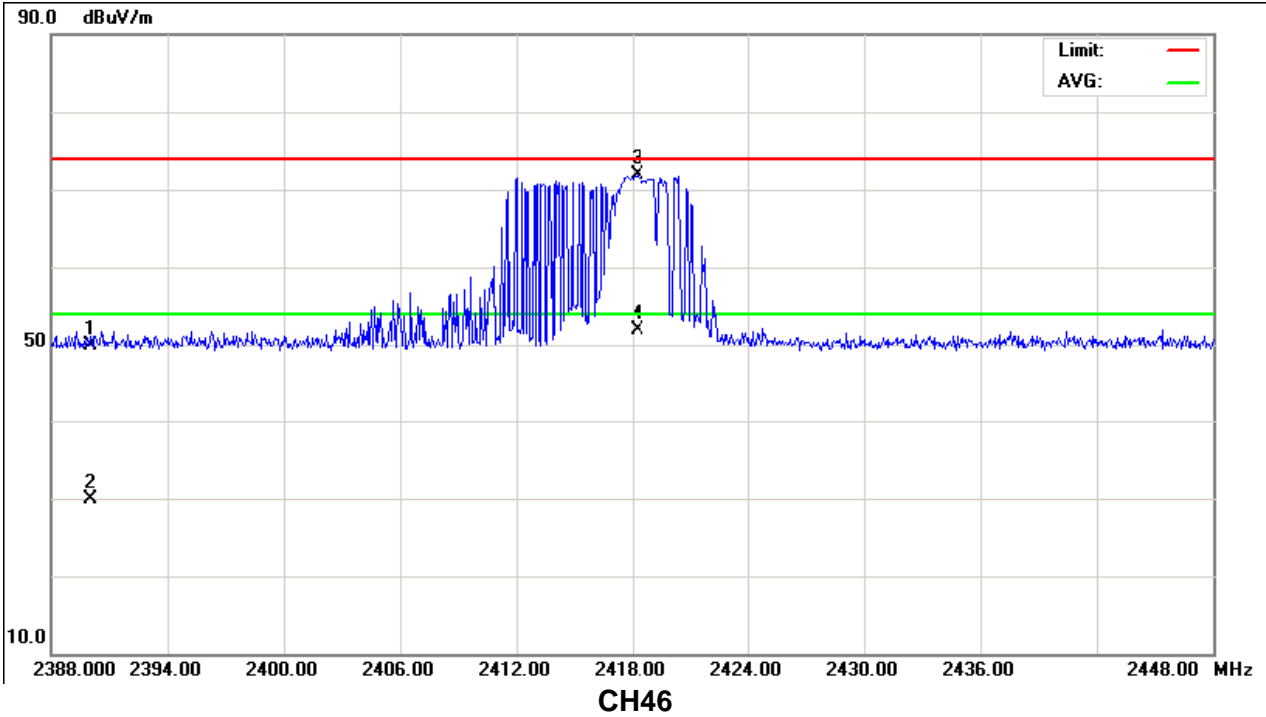



EUT :	2.4G Wireless Receiver	Model Name :	R07-M
Temperature :	27 °C	Relative Humidity :	50 %
Pressure :	1010 hPa	Test Voltage :	AC 120V/60Hz
Test Mode :	TX 2418MHz/2464MHz		
Note :	1. The transmitter was setup to transmit at the lowest channel (CH01). Then the field strength was measured at 2310-2390 MHz. 2. The transmitter was setup to transmit at the highest channel (CH46). Then the field strength was measured at 2483.5-2500 MHz.		

Freq.	Ant.Pol.	Reading		Ant./CF	Act.		Limit		Note
		Peak	AV		Peak	AV	Peak	AV	
(MHz)	H/V	(dBuV)	(dBuV)	CF(dB)	(dBuV/m)	(dBuV/m)	(dBuV/m)	(dBuV/m)	
2390.00	H	18.39	-1.61	31.10	49.49	29.49	74.00	54.00	CH01
2483.50	H	20.62	0.62	30.97	51.59	31.59	74.00	54.00	CH32

Remark :

- (1) Radiated emissions measured in frequency range above 1000MHz were made with an instrument using Peak detector mode and AV detector mode of the emission .
- (2) EUT Orthogonal Axis :
 "X" - denotes Laid on Table ; "Y" - denotes Vertical Stand ; "Z" - denotes Side Stand
- (3) During the measurements above 1 GHz it is taken care of that the EUT is always within the 3 dB cone of radiation BW of the used antenna
- (4) The average value of fundamental frequency is:
 Average = Peak value + 20log(Duty cycle) · Final AV=PK-20



Restricted Bands Requirements, Horizontal
CH01

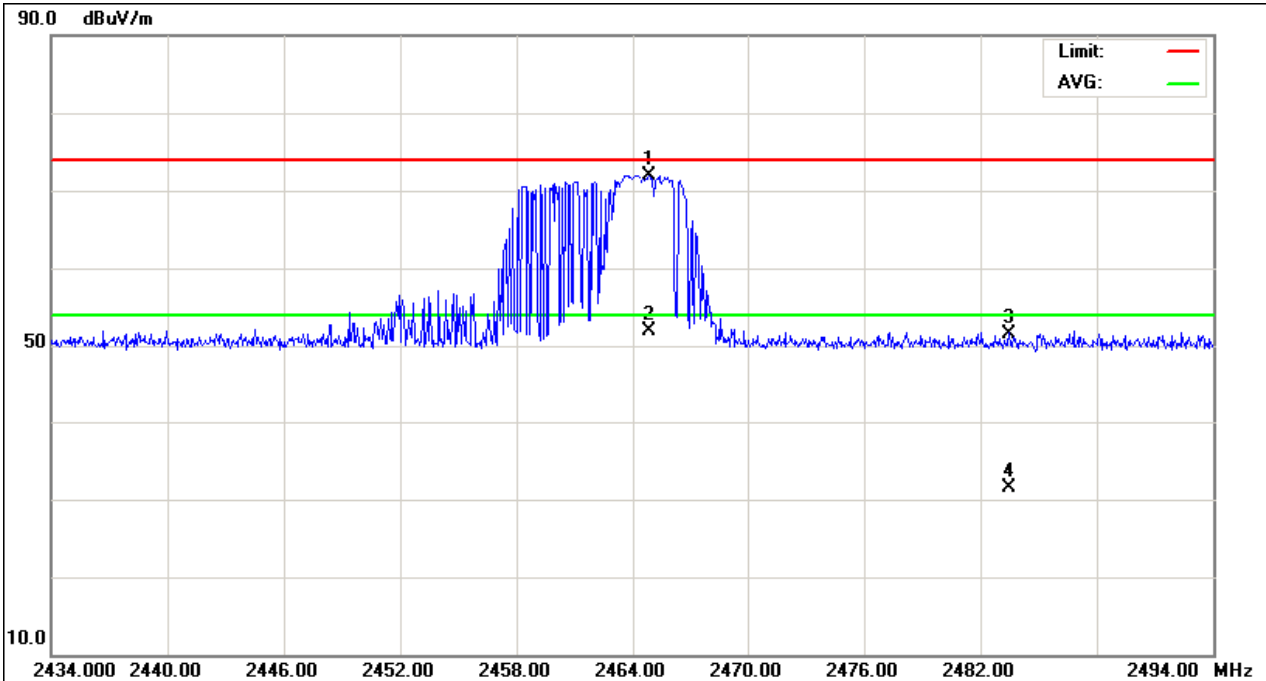
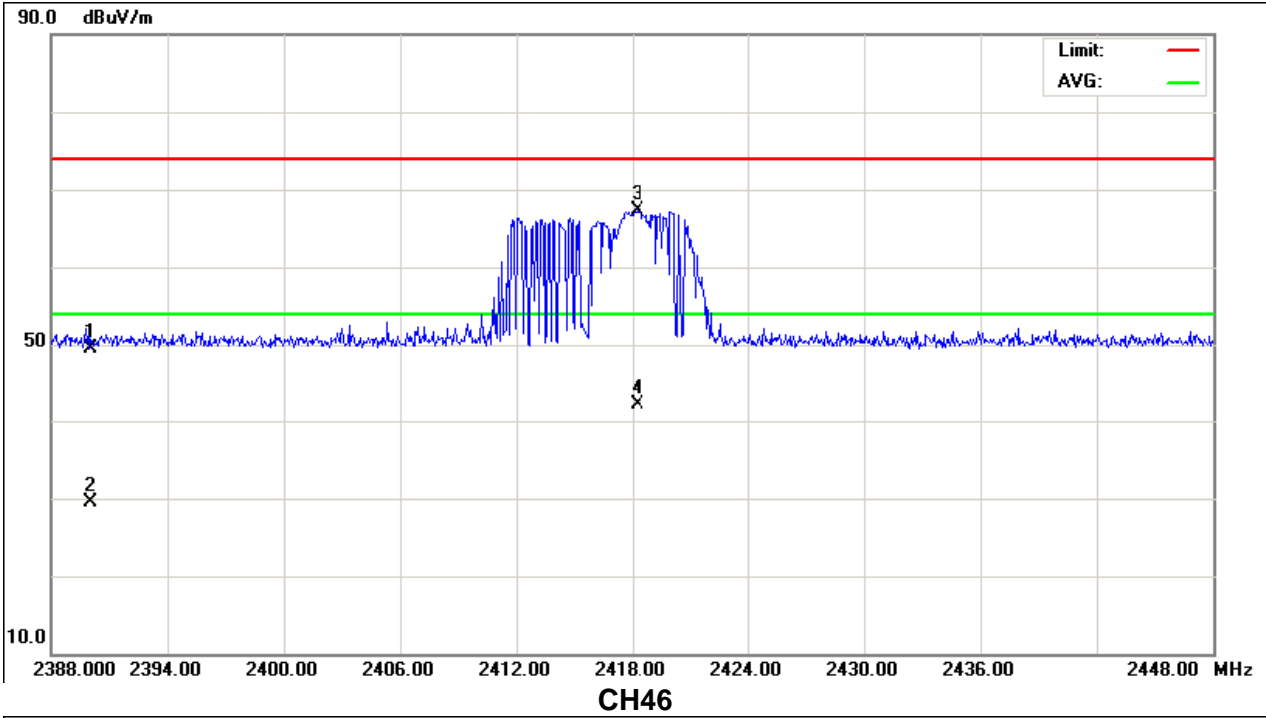



5. NUMBER OF HOPPING CHANNEL

5.1 APPLIED PROCEDURES / LIMIT

FCC Part15 (15.247) , Subpart C			
Section	Test Item	Frequency Range (MHz)	Result
15.247 (a)(1)(ii)	Number of Hopping Channel	2400-2483.5	PASS

5.1.1 MEASUREMENT INSTRUMENTS LIST AND SETTING

Item	Kind of Equipment	Manufacturer	Type No.	Serial No.	Calibrated until
1	Spectrum Analyzer	R&S	FSP 40	100185	Nov.27.2010

Remark: " N/A" denotes No Model Name , Serial No. or No Calibration specified.

Spectrum Parameters	Setting
Attenuation	Auto
Span Frequency	> Operating Frequency Range
RB	100 kHz
VB	100 kHz
Detector	Peak
Trace	Max Hold
Sweep Time	Auto

5.1.2 TEST PROCEDURE

- a. The EUT was directly connected to the spectrum analyzer and antenna output port as show in the block diagram below,
- b. Spectrum Setting : RBW= 100KHz, VBW=100KHz, Sweep time = Auto.

5.1.3 DEVIATION FROM STANDARD

No deviation.

5.1.4 TEST SETUP



5.1.5 EUT OPERATION CONDITIONS

The EUT tested system was configured as the statements of 4.1.6 Unless otherwise a special operating condition is specified in the follows during the testing.



5.1.6 TEST RESULTS

EUT :	2.4G Wireless Receiver	Model Name :	R07-M
Temperature :	25 °C	Relative Humidity :	60%
Pressure :	1015 hPa	Test Voltage :	AC 120V/60Hz
Test Mode :	Hopping Mode		

Number of Hopping Channel	46
---------------------------	----

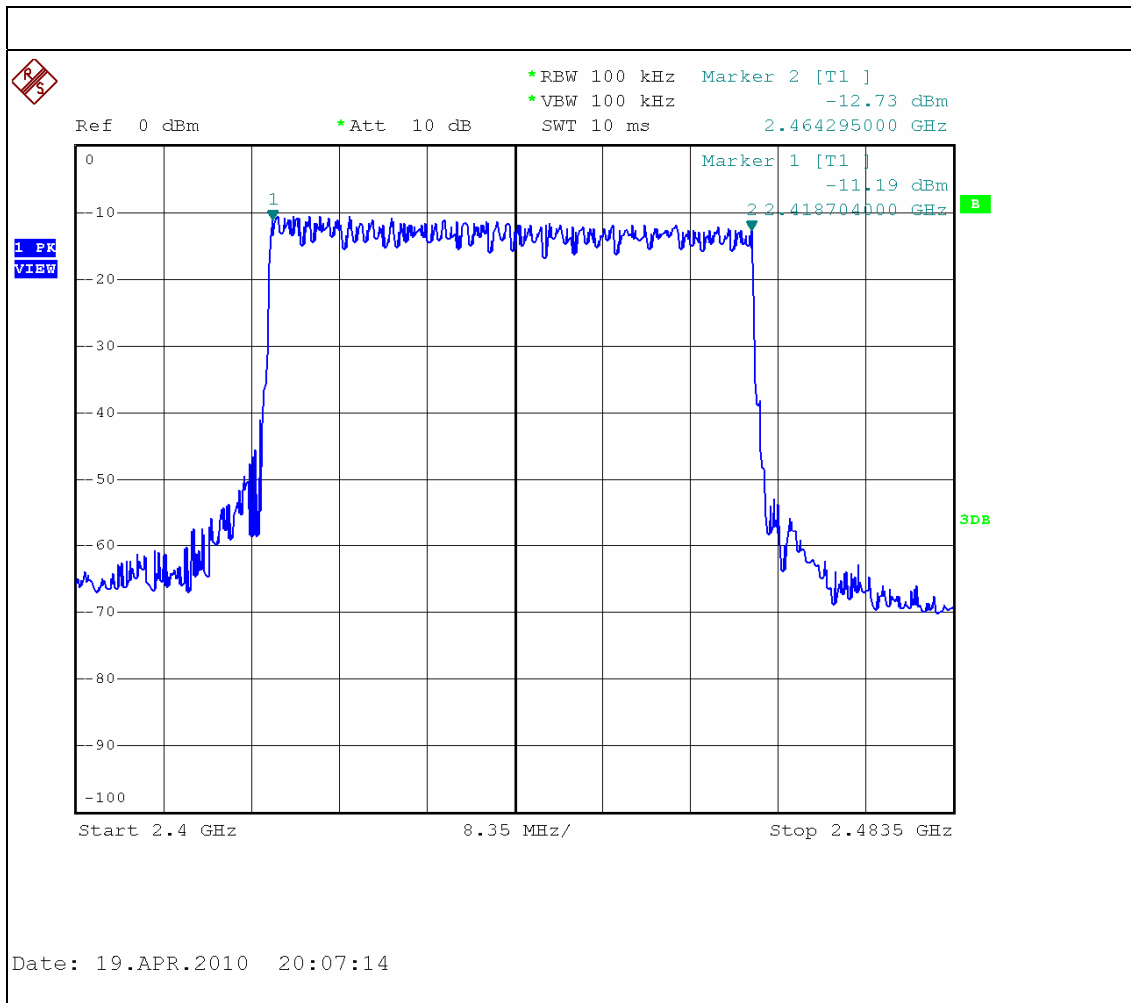

6. AVERAGE TIME OF OCCUPANCY

6.1 APPLIED PROCEDURES / LIMIT

FCC Part15 (15.247) , Subpart C				
Section	Test Item	Limit	Frequency Range (MHz)	Result
15.247 (a)(1)(ii)	Average Time of Occupancy	0.4sec	2400-2483.5	PASS

6.1.1 MEASUREMENT INSTRUMENTS LIST

Item	Kind of Equipment	Manufacturer	Type No.	Serial No.	Calibrated until
1	Spectrum Analyzer	R&S	FSP 40	100185	Nov.27.2010

Remark: " N/A" denotes No Model Name , Serial No. or No Calibration specified.

6.1.2. TEST PROCEDURES

- The transmitter output (antenna port) was connected to the spectrum analyzer
- Set RBW of spectrum analyzer to 1MHz and VBW to 1MHz.
- Use a video trigger with the trigger level set to enable triggering only on full pulses.
- Sweep Time is more than once pulse time.
- Set the center frequency on any frequency would be measure and set the frequency span to zero span.
- Measure the maximum time duration of one single pulse.
- Set the EUT for packet transmitting.
- Measure the maximum time duration of one single pulse.

6.1.3. TEST SETUP LAYOUT

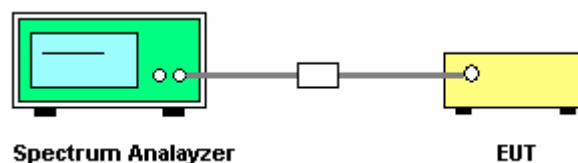

6.1.4. TEST DEVIATION

There is no deviation with the original standard.

6.1.5. EUT OPERATION DURING TEST

The EUT was programmed to be in continuously transmitting/Hopping mode.



6.1.6. RESULTS OF OCCUPIED BANDWIDTH AND SPREAD-SPECTRUM BANDWIDTH

EUT :	2.4G Wireless Receiver	Model Name :	R07-M
Temperature :	25 °C	Relative Humidity :	60%
Pressure :	1015 hPa	Test Voltage :	AC 120V/60Hz
Test Mode :	Hopping Mode		

Mode	Number of transmission in a 18.4 (46Hopping*0.4)	Length of transmission time (msec)	Result (msec)	Limit (msec)
2440 MHz	$(8/2) * 18.4 = 73.6$ times Note1	0.96	70.656	400

Note1: 8 times of occupied channels per 2 second

	Results
Measured cycle (sec)	$46 \text{ CH} * 0.4 = 18.4$
The total number of frequency-hopping per second	$((8/2) * 46) = 184$
The number of occupied channels per second	$184 / 46 = 4$ (number/sec)
occupied time for each channel(1)	0.96ms
The total number of channels occupied within one cycle (2)	$(8/2) * 18.4 = 73.6$ times
The average time of occupancy within one cycle(1)*(2)	70.656msec
LIMIT (msec)	400msec

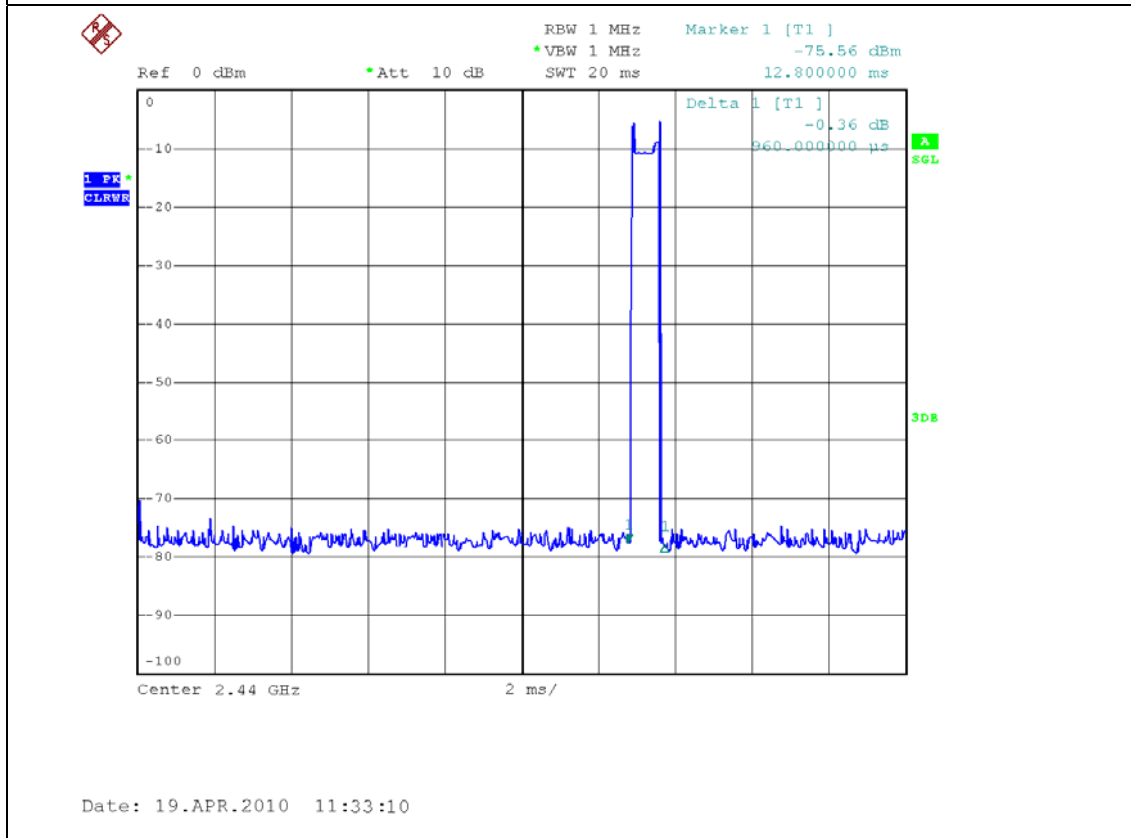
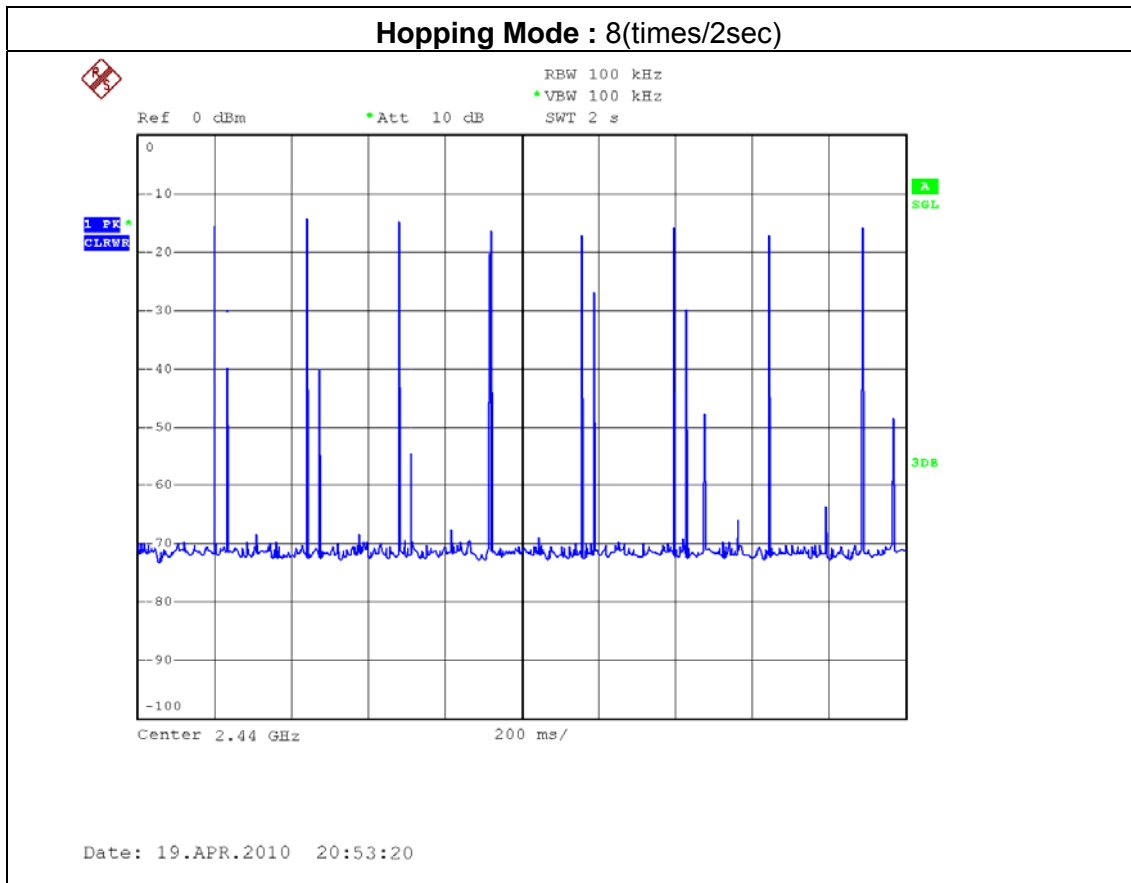

7. HOPPING CHANNEL SEPARATION MEASUREMENT

7.1 APPLIED PROCEDURES / LIMIT

Frequency hopping systems operating in the 2400-2483.5 MHz band may have hopping channel carrier frequencies that are separated by 25 kHz or two-thirds of the 20 dB bandwidth of the hopping channel, whichever is greater.

7.1.1 MEASUREMENT INSTRUMENTS LIST AND SETTING

Item	Kind of Equipment	Manufacturer	Type No.	Serial No.	Calibrated until
1	Spectrum Analyzer	R&S	FSP 40	100185	Nov.27.2010

Remark: " N/A" denotes No Model Name , Serial No. or No Calibration specified.

Spectrum Parameter	Setting
Attenuation	Auto
Span Frequency	> Measurement Bandwidth or Channel Separation
RB	30 kHz (20dB Bandwidth) / 100 kHz (Channel Separation)
VB	100 kHz (20dB Bandwidth) / 300 kHz (Channel Separation)
Detector	Peak
Trace	Max Hold
Sweep Time	Auto

7.1.2 TEST PROCEDURE

- The transmitter output (antenna port) was connected to the spectrum analyser in peak hold mode.
- The resolution bandwidth of 30 kHz and the video bandwidth of 100 kHz were utilised for 20 dB bandwidth measurement.
- The resolution bandwidth of 100 kHz and the video bandwidth of 300 kHz were utilised for channel separation measurement.

7.1.3 DEVIATION FROM STANDARD

No deviation.

7.1.4 TEST SETUP

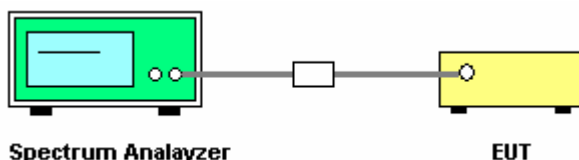

7.1.5 EUT OPERATION CONDITIONS

The EUT was programmed to be in continuously transmitting mode.



7.1.6 TEST RESULTS

EUT :	2.4G Wireless Receiver	Model Name :	R07-M
Temperature :	25 °C	Relative Humidity :	60%
Pressure :	1012 hPa	Test Voltage :	AC 120V/60Hz
Test Mode :	CH01 / CH22 / CH46		

Frequency	Ch. Separation (MHz)	20d Bandwidth B (MHz)	Result
2418 MHz	1	0.64	Complies
2440 MHz	1	0.72	Complies
2464 MHz	1	0.68	Complies

Ch. Separation Limits: >20dB bandwidth or >2/3 of 20dB bandwidth

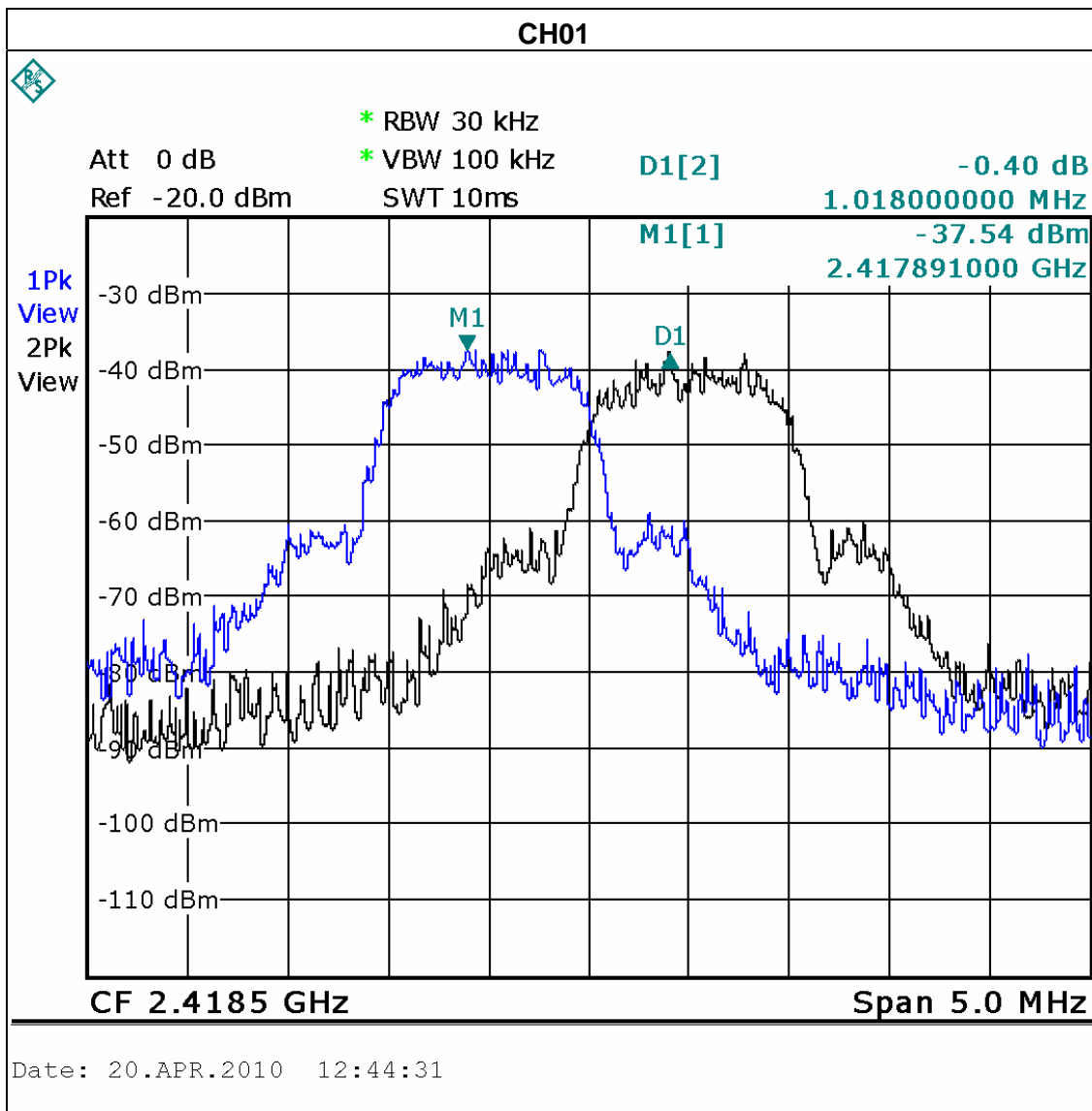

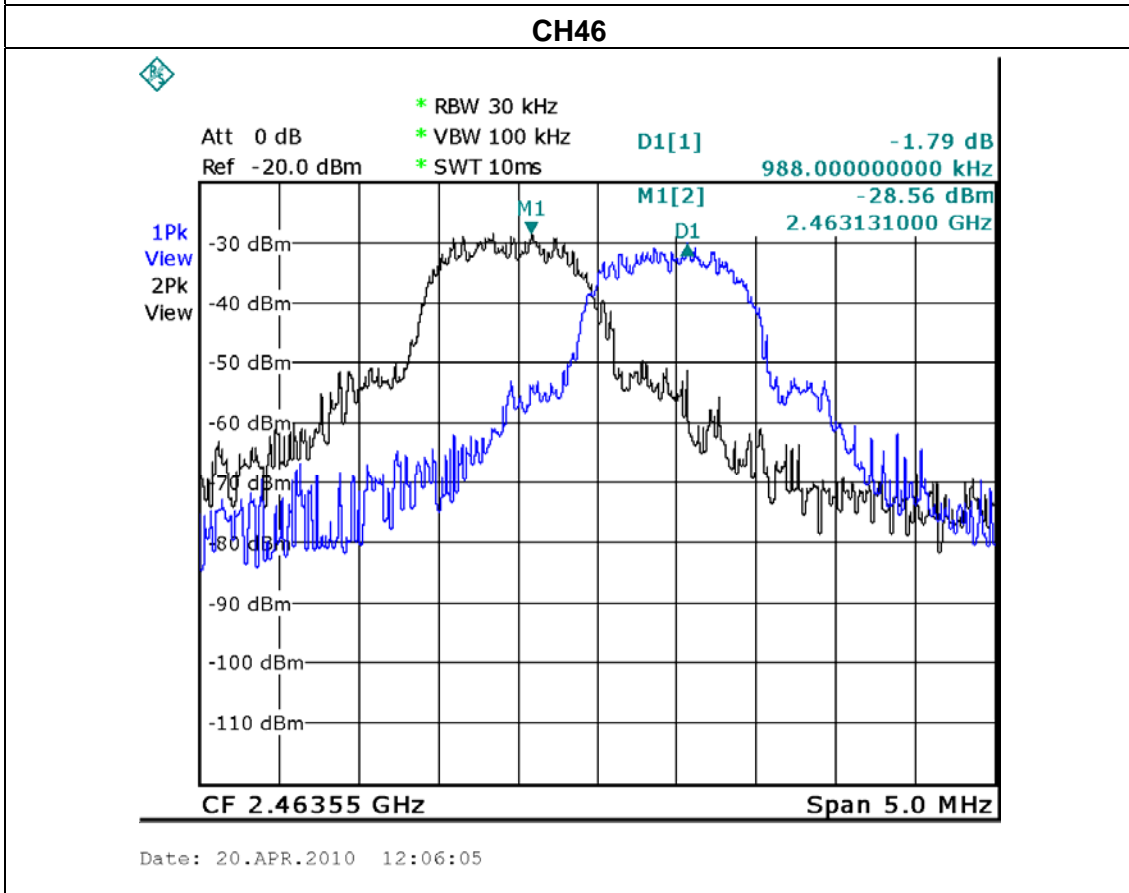
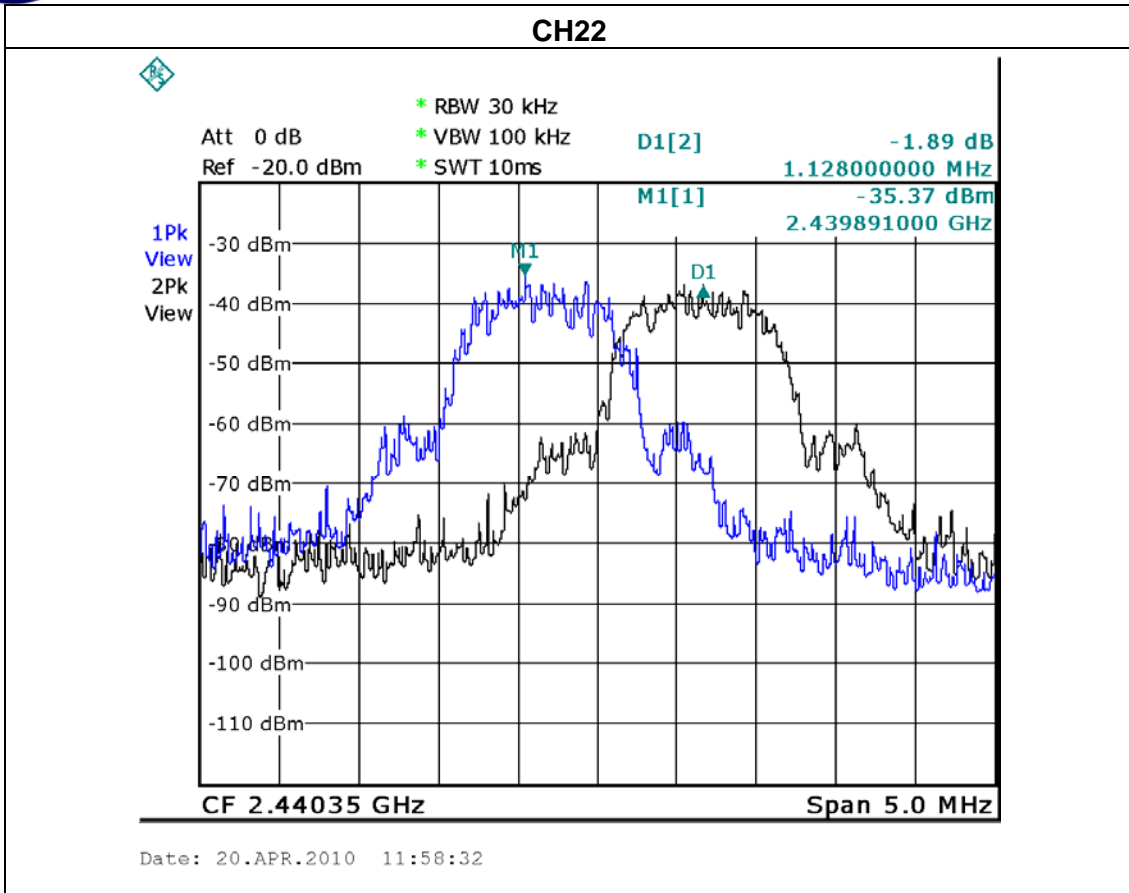



8. BANDWIDTH TEST

8.1 APPLIED PROCEDURES / LIMIT

FCC Part15 (15.247) , Subpart C				
Section	Test Item	Limit	Frequency Range (MHz)	Result
15.247 (a)(2)	Bandwidth	<= 1 MHz (20dB bandwidth)	2400-2483.5	PASS

8.1.1 MEASUREMENT INSTRUMENTS LIST AND SETTING

Item	Kind of Equipment	Manufacturer	Type No.	Serial No.	Calibrated until
1	Spectrum Analyzer	R&S	FSP 40	100185	Nov.27.2010

Remark: " N/A" denotes No Model Name , Serial No. or No Calibration specified.

Spectrum Parameter	Setting
Attenuation	Auto
Span Frequency	> Measurement Bandwidth or Channel Separation
RB	30 kHz (20dB Bandwidth) / 100 kHz (Channel Separation)
VB	100 kHz (20dB Bandwidth) / 300 kHz (Channel Separation)
Detector	Peak
Trace	Max Hold
Sweep Time	Auto

8.1.2 TEST PROCEDURE

- a. The EUT was directly connected to the spectrum analyzer and antenna output port as show in the block diagram below,
- b. Spectrum Setting : RBW= 10KHz, VBW=100KHz, Sweep time = Auto.

8.1.3 DEVIATION FROM STANDARD

No deviation.

8.1.4 TEST SETUP



8.1.5 EUT OPERATION CONDITIONS

The EUT tested system was configured as the statements of 4.1.6 Unless otherwise a special operating condition is specified in the follows during the testing.



8.1.6 TEST RESULTS

EUT :	2.4G Wireless Receiver	Model Name :	R07-M
Temperature :	25 °C	Relative Humidity :	60%
Pressure :	1012 hPa	Test Voltage :	AC 120V/60Hz
Test Mode :	CH01 / CH22 /CH46		

Frequency	20dB Bandwidth (MHz)	Channel Separation (MHz)	Result
2418 MHz	0.64	<= 1MHz	PASS
2440 MHz	0.72	<= 1MHz	PASS
2464 MHz	0.68	<= 1MHz	PASS

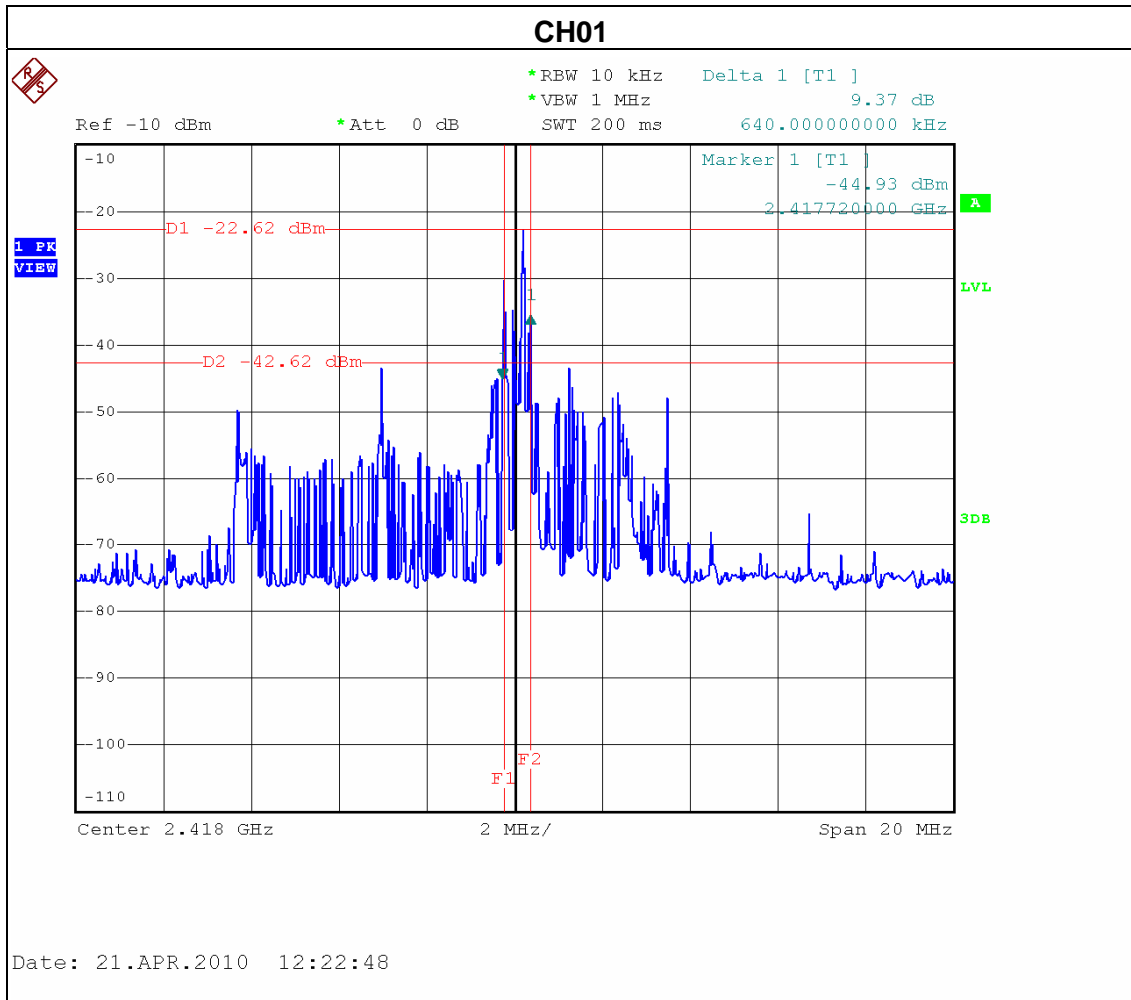

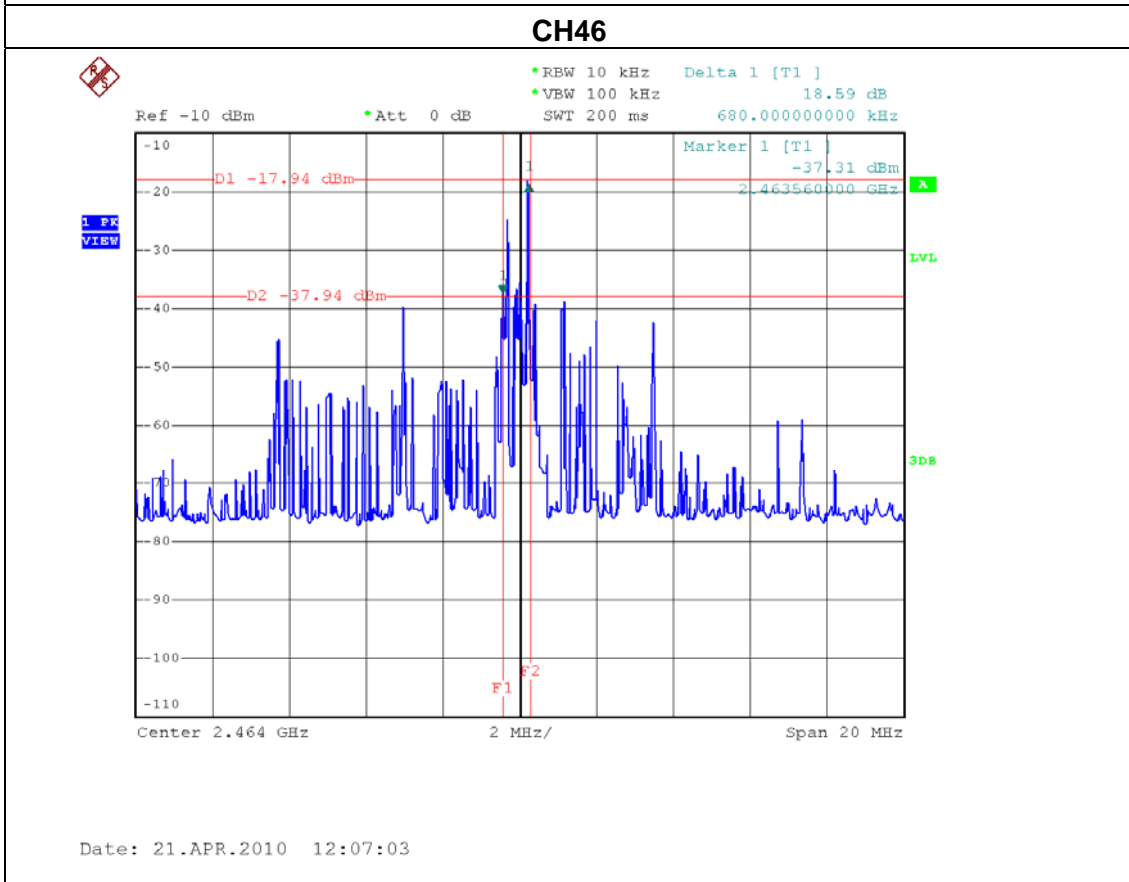
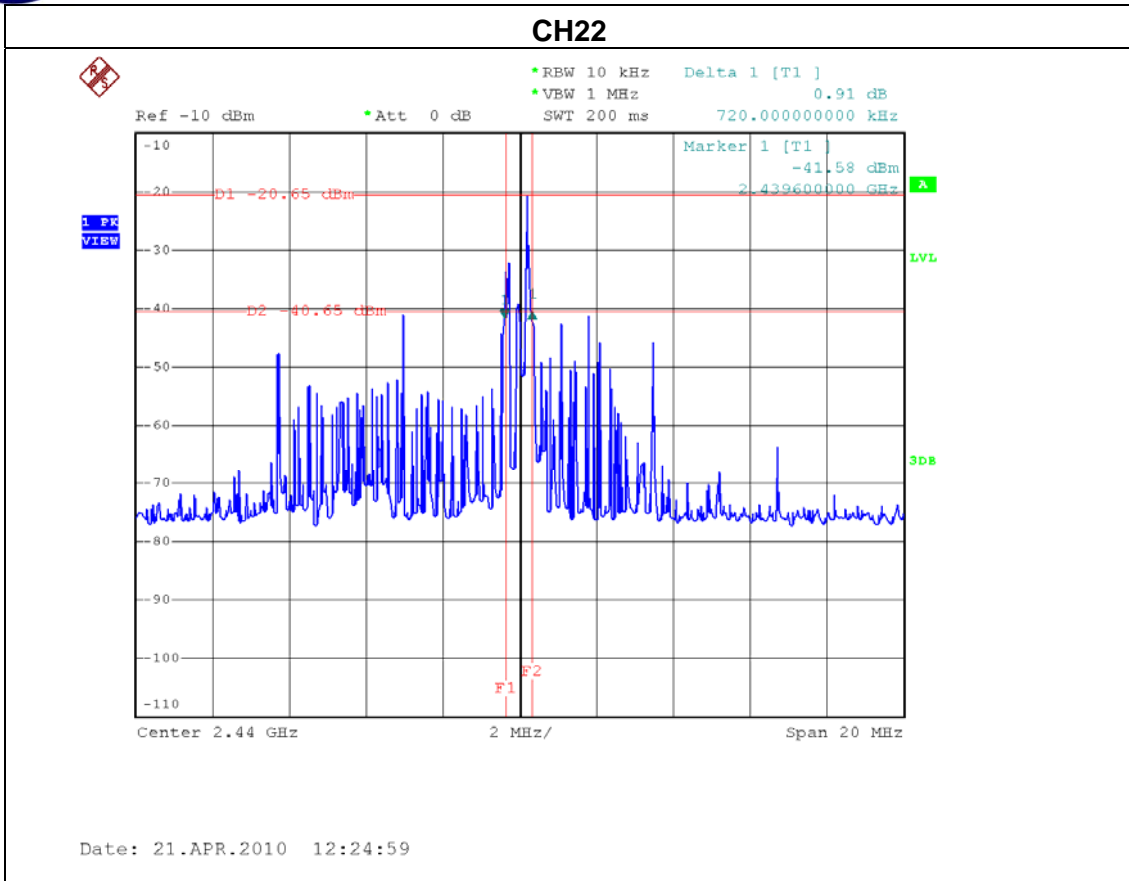



9. PEAK OUTPUT POWER TEST

9.1 APPLIED PROCEDURES / LIMIT

FCC Part15 (15.247) , Subpart C				
Section	Test Item	Limit	Frequency Range (MHz)	Result
15.247 (b)(1)	Peak Output Power	1 watt or 30dBm	2400-2483.5	PASS

9.1.1 MEASUREMENT INSTRUMENTS LIST AND SETTING

Item	Kind of Equipment	Manufacturer	Type No.	Serial No.	Calibrated until
1	Spectrum Analyzer	R&S	FSP 40	100185	Nov.27.2010

Remark: " N/A" denotes No Model Name , Serial No. or No Calibration specified.

9.1.2 TEST PROCEDURE

- a. The EUT was directly connected to the spectrum analyzer and antenna output port as show in the block diagram below,
- b. Spectrum Setting : RBW= 1MHz, VBW= 1MHz, Sweep time = Auto.

9.1.3 DEVIATION FROM STANDARD

No deviation.

9.1.4 TEST SETUP



9.1.5 EUT OPERATION CONDITIONS

The EUT tested system was configured as the statements of 4.1.6 Unless otherwise a special operating condition is specified in the follows during the testing.



9.1.6 TEST RESULTS

EUT :	2.4G Wireless Receiver	Model Name :	R07-M
Temperature :	25 °C	Relative Humidity :	60%
Pressure :	1012 hPa	Test Voltage :	AC 120V/60Hz
Test Mode :	CH01/ CH22 /CH46		

Test Channel	Frequency (MHz)	Peak Output Power (dBm)	LIMIT (dBm)	LIMIT (W)
CH01	2418	-15.84	30	1
CH22	2440	-16.41	30	1
CH46	2464	-16.01	30	1

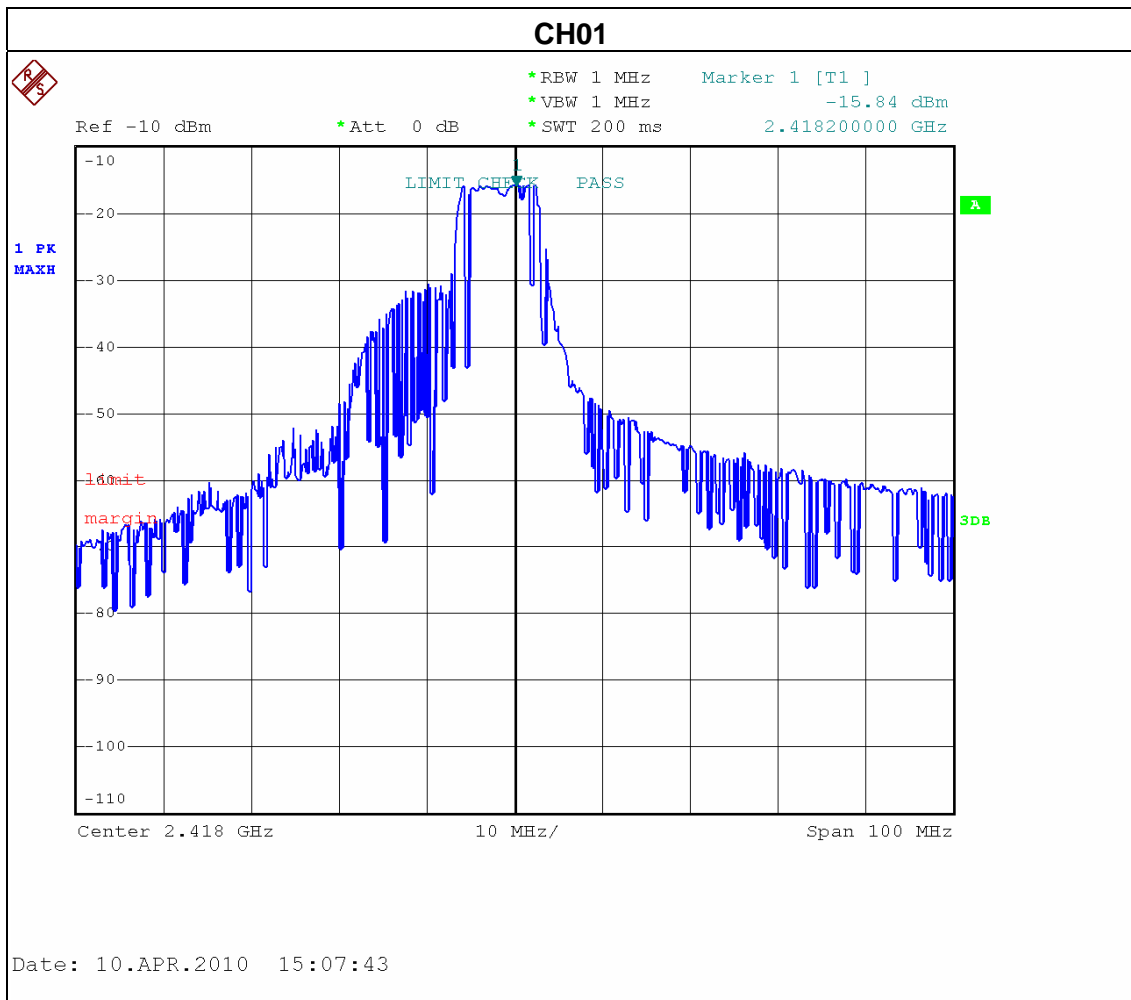

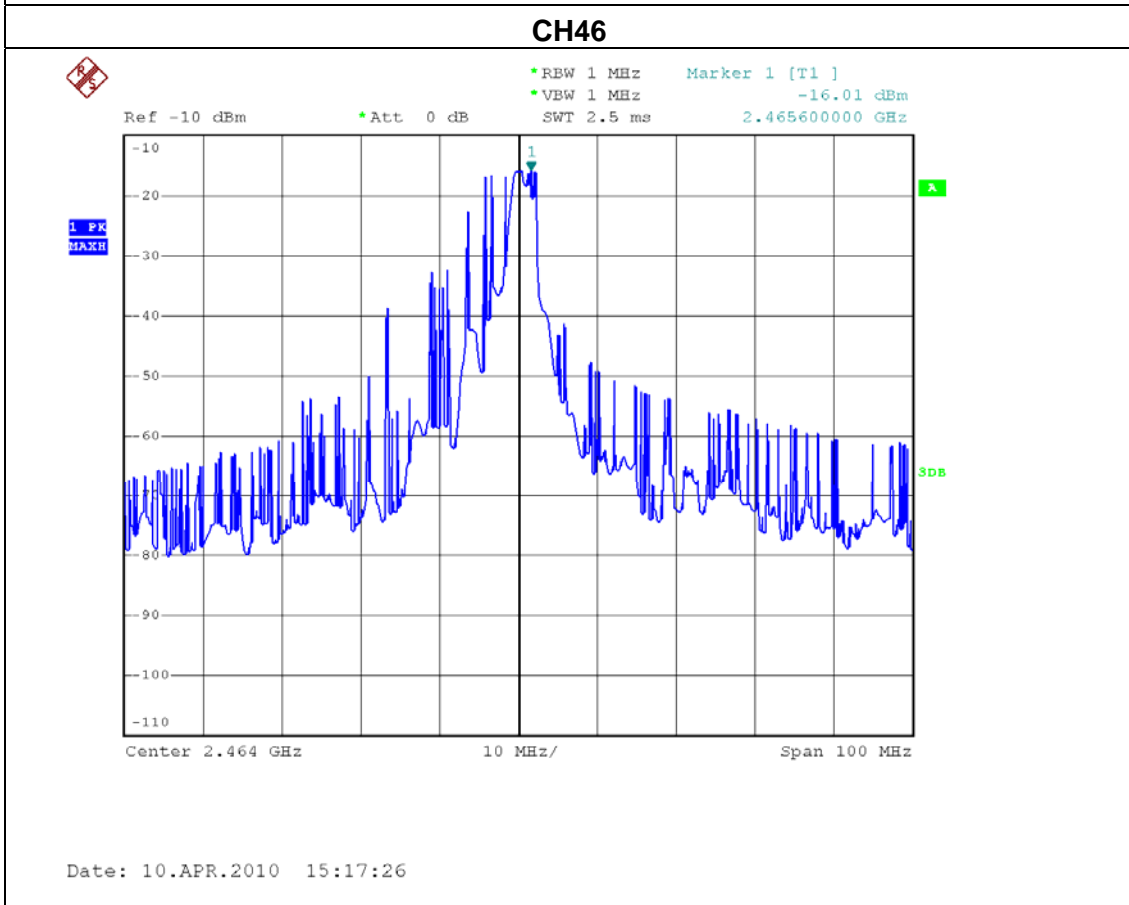
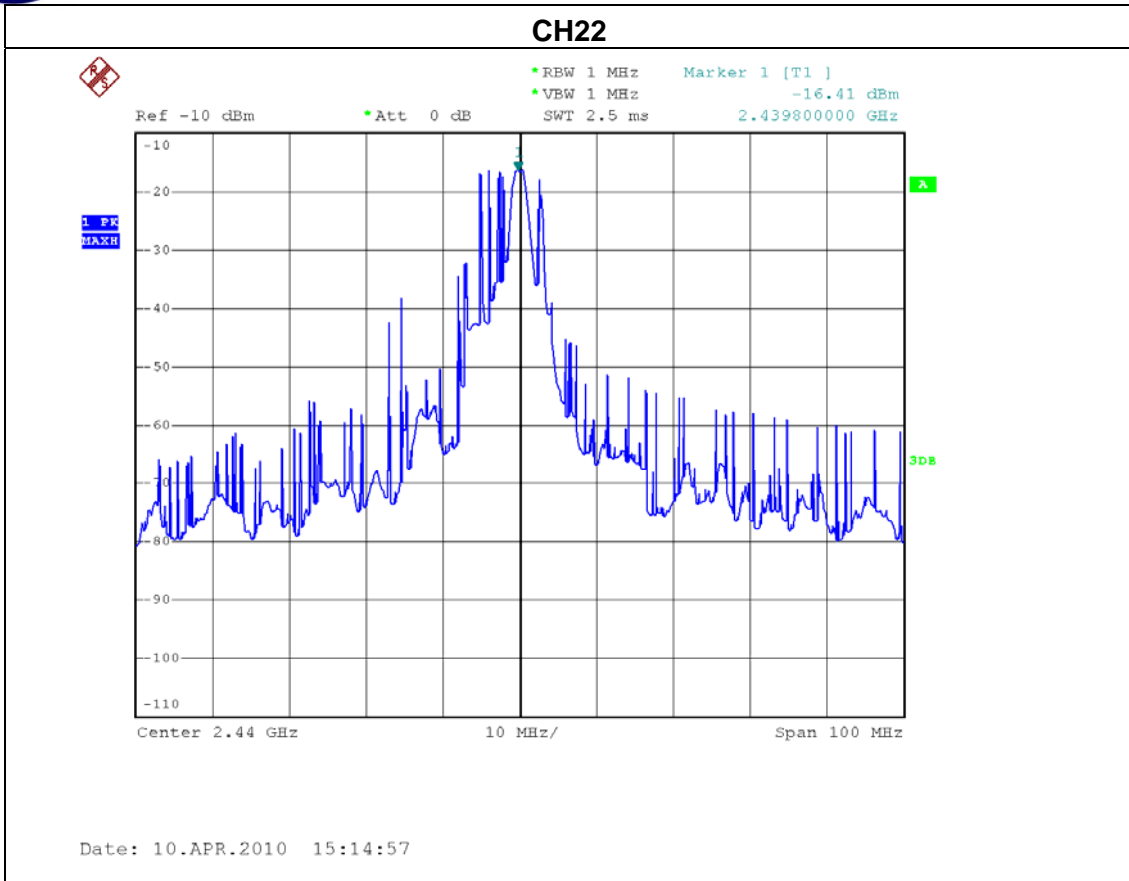



10. ANTENNA CONDUCTED SPURIOUS EMISSION

10.1 APPLIED PROCEDURES / LIMIT

20dBc in any 100 kHz bandwidth outside the operating frequency band. In case the emission fall within the restricted band specified on 15.205(a), then the 15.209(a) limit in the table below has to be followed.

Frequencies (MHz)	Field Strength (micorvolts/meter)	Measurement Distance (meters)
0.009~0.490	2400/F(KHz)	300
0.490~1.705	24000/F(KHz)	30
1.705~30.0	30	30
30~88	100	3
88~216	150	3
216~960	200	3
Above 960	500	3

10.1.1 MEASUREMENT INSTRUMENTS LIST AND SETTING

Item	Kind of Equipment	Manufacturer	Type No.	Serial No.	Calibrated until
1	Spectrum Analyzer	R&S	FSP 40	100185	Nov.27.2010

Remark: " N/A" denotes No Model Name , Serial No. or No Calibration specified.

The following table is the setting of the spectrum analyzer.

Spectrum Parameter	Setting
Attenuation	Auto
Span Frequency	100 MHz
RB / VB (emission in restricted band)	1MHz / 1MHz for Peak, 1 MHz / 10Hz for Average
RB / VB (other emission)	100 KHz /100 KHz for Peak

10.1.2 TEST PROCEDURE

- a. The EUT was directly connected to the spectrum analyzer and antenna output port as show in the block diagram below,
- b. Spectrum Setting : RBW= 100KHz, VBW=100KHz, Sweep time = Auto.

10.1.3 DEVIATION FROM STANDARD

No deviation.



10.1.4 TEST SETUP



10.1.5 EUT OPERATION CONDITIONS

The EUT tested system was configured as the statements of 4.1.6 Unless otherwise a special operating condition is specified in the follows during the testing.



10.1.6 TEST RESULTS

EUT :	2.4G Wireless Receiver	Model Name :	R07-M
Temperature :	25 °C	Relative Humidity :	60%
Pressure :	1012 hPa	Test Voltage :	AC 120V/60Hz
Test Mode :	CH01 / CH46		

The max. radio frequency power in any 100kHz bandwidth outside the frequency band		The max. radio frequency power in any 100 kHz bandwidth within the frequency band.	
FREQUENCY(MHz)	POWER(dBm)	FREQUENCY(MHz)	POWER(dBm)
2376.00	-67.48	2490.20	-65.61

Result

In any 100kHz bandwidth outside the frequency band, the radio frequency power is at least 20dB below that in the 100kHz bandwidth within the band that contains the highest level of the desired power.



CH01 (Lower)

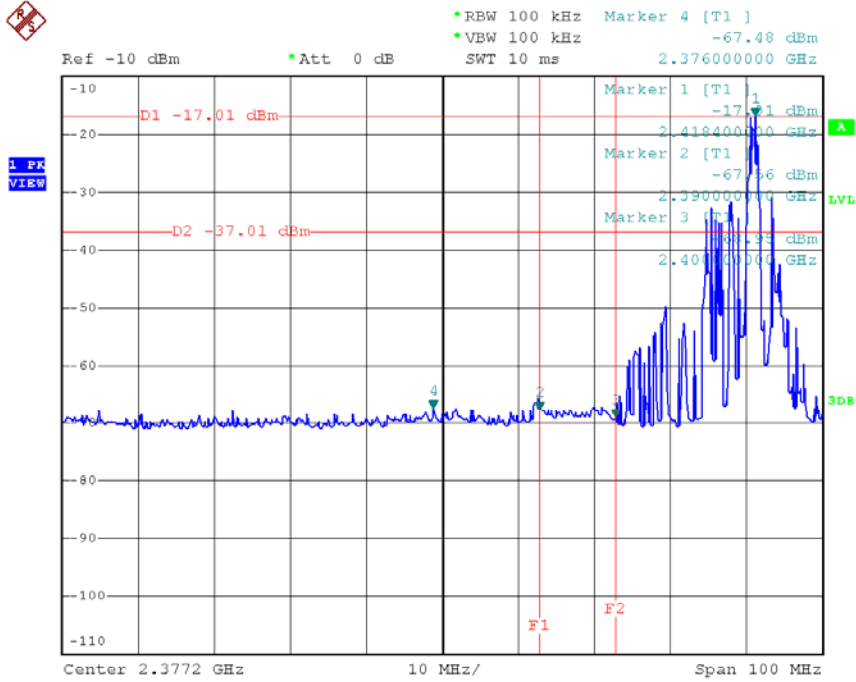

Date: 20.APR.2010 11:58:34

CH 78 (Upper)

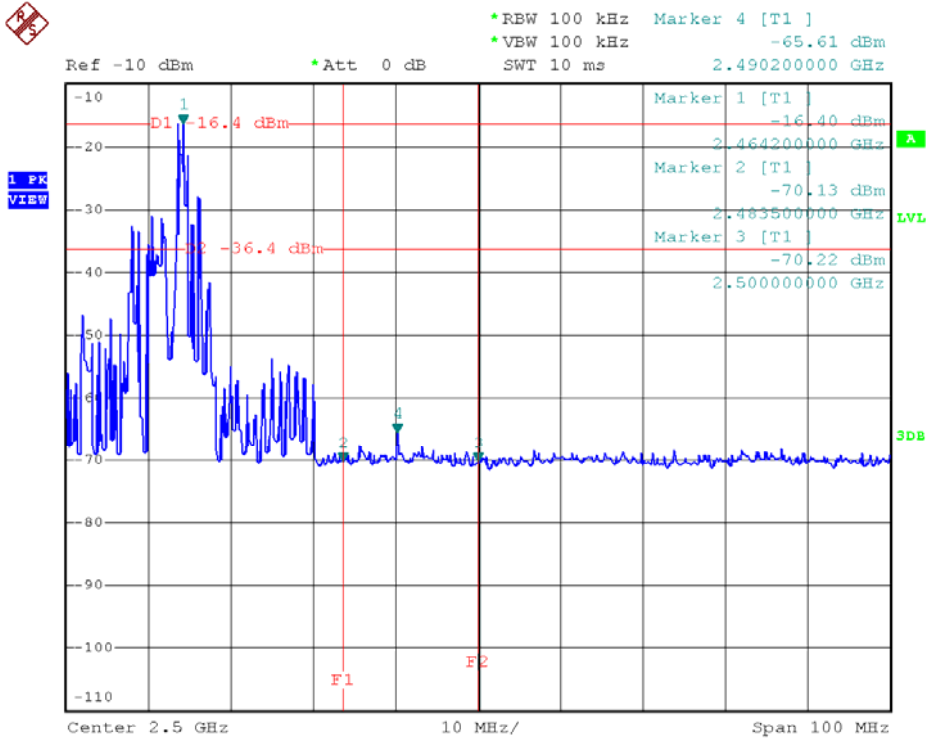

Date: 20.APR.2010 12:11:49



11. EUT TEST PHOTO

Conducted Measurement Photos





Radiated Measurement Photos

