



**LABORATORIUM VOOR OMGEVINGSMETINGEN
LABORATOIRE D'ESSAIS D'ENVIRONNEMENT
ENVIRONMENTAL TEST LABORATORIA**

NOTIFIED BODY UNDER CEC-DIRECTIVE 2004/108/CE NOTIFIED BODY UNDER CEC-DIRECTIVE 2006/95/CE	 041-T - ISO17025
ACCREDITED FOR NBN EN ISO 17025 BY BELAC 041-T - ISO17025	
RECOGNISED TESTING AUTHORITY FOR AUSTRALIA	
CONFORMITY ASSESSMENT BODY MRA US-EU SECTORAL ANNEX EMC (FCC)	

EMC TESTREPORT

Product	NFC module for Direct Radiology equipment
Standard	FCC part 15 subpart c
Test Report	PCC-RAD-4932
LDN Number	LDN3977
Date of issue	2019-05-17
Edition	01



Contents

SECTION 1: IDENTIFICATION OF THE TEST LABORATORIA	3
SECTION 2: CUSTOMER INFORMATION AND DATES	4
SECTION 3: EQUIPMENT UNDER TEST (E.U.T.).....	5
SECTION 4: TEST SPECIFICATIONS AND TEST METHODS.....	8
SECTION 5: OPERATION OF EUT DURING TESTING	9
SECTION 6: SUMMARY OF TEST RESULTS	10
SECTION 7: DETAILED TEST RESULTS.....	11
SECTION 8: MEASUREMENT UNCERTAINTIES	37
SECTION 9: ADDITIONAL INFORMATION GIVEN BY THE CUSTOMER.....	38
SECTION 10: MODIFICATIONS OF EUT.....	39
SECTION 11: HISTORY OF THE TEST REPORT	40
SECTION 12: ACCREDITATION CERTIFICATE	41

This Test Report contains 42 pages

SECTION 1: IDENTIFICATION OF THE TEST LABORATORIA

LABORATORIA DE NAYER <u>Product Certification Centre (PCC)</u>	
J.De Nayerlaan 9 B-2860 St.-Katelijne-Waver Belgium Tel: +32 (0) 15 30 54 00 Fax: +32 (0) 15 32 1212	Direct phone numbers and e-mail address: (Test engineer) J. De Vos +32(0)15 30 54 04 j.de.vos@labodenayer.be

TEST LABORATORY RESPONSIBILITIES			
Function	Name(s)	Date	Signature
Test Operator	Jan De Vos	2019-05-17	
Author Report	Jan De Vos	2019-05-17	
Technical Expert	dr.ir. Dirk Van Troyen	2019-05-17	



041-T – ISO17025

The test report may not be reproduced, unless as a complete packet, without written agreement of Laboratoria De Nayer v.z.w.

The results refer to the described sample or equipment under test only.

Neither the accredited status of Laboratoria De Nayer v.z.w., nor this test report implies that the sample or equipment under test is approved by BELAC or any other establishment.

In case the customer wants to refer to his appeal to our accredited laboratories, he will use the following orequivalent sentence: "Tested by Laboratoria De Nayer, E.M.C.department, accredited by BELAC for EMC-immunity and EMC-emission under registration number 041-T".

SECTION 2: CUSTOMER INFORMATION AND DATES

CUSTOMER INFORMATION

Company name: Agfa HealthCare
Address: Septestraat 27
2640 Mortsel Belgium
Contact person: Jan Vercammen
Telephone nr: +32 3 444.62.33
E-mail: jan.vercammen1@agfa.com

DATES

Receipt of the EUT: 2019-04-08
Start of tests: 2019-04-08
End of tests: 2019-04-11

SECTION 3: EQUIPMENT UNDER TEST (E.U.T.)

The correctness of the description and identification of the equipment under test, its operating conditions, possible modifications and monitoring of its behaviour during and/ or after the test conditions generated by the De Nayer Environmental Test Laboratory are under the responsibility of the customer.

IDENTIFICATION OF THE E.U.T.

Intended use:	short range RF tag identification (NFC)
Manufacturer:	Agfa NV
Model / Type:	A813168.xx, where xx is revision, current revision is 01
Software Version:	none, the module can not be programmed
used frequency range:	13.56MHz band
Used modulation types :	ISO/IEC 14443 type A
Used antenna:	fixed (printed circuit board) loop antenna
PSU :	+5V
Serial Number:	PS191100003
FCC-ID number:	HPL-DR100SRFID

Illustrations: (Equipment under test)

Photo : EUT top (antenna on PCB)



Photo : top

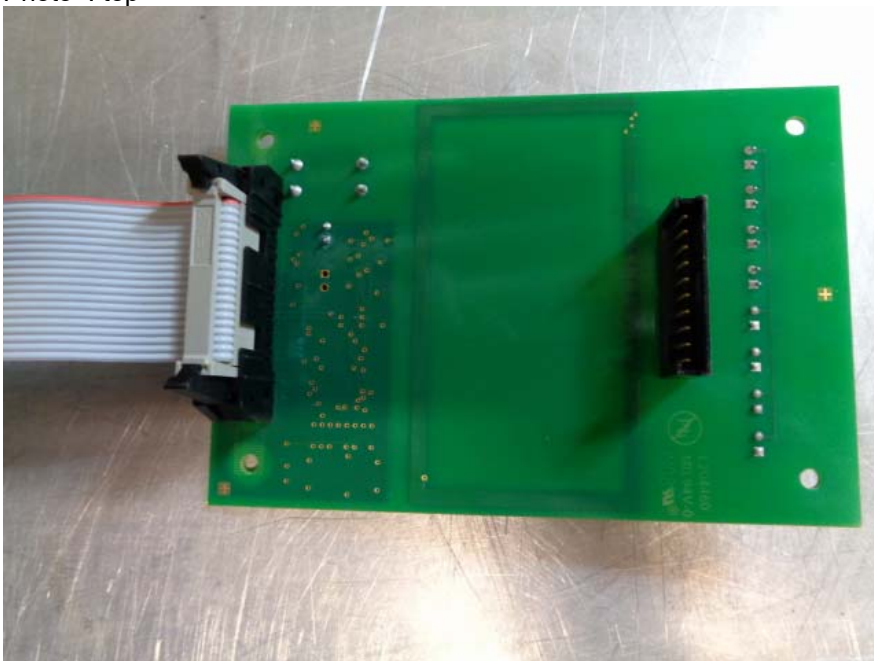

photo ID on PCB :

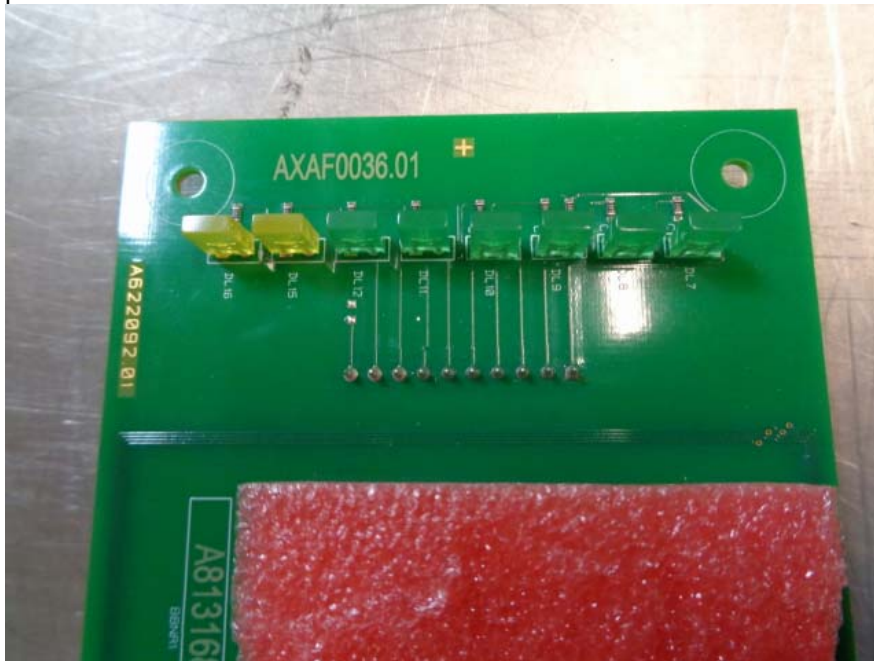
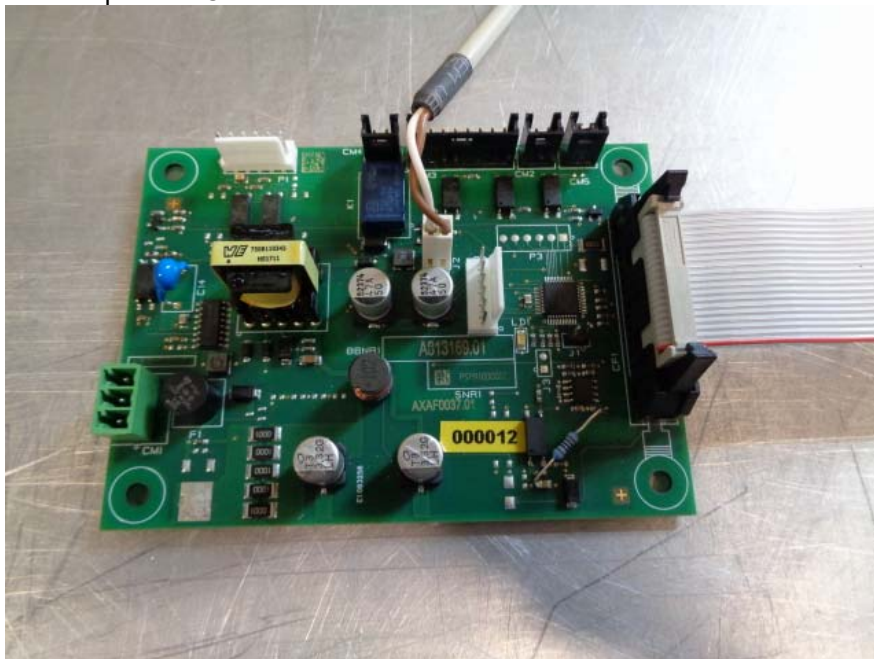



Photo : power PCB



SECTION 4: TEST SPECIFICATIONS AND TEST METHODS

Applied Tests or Technical Standards		
Emission:		
Test or Technical Standard	Title	
FCC CFR47 part 15	Code of Federal Regulations , part 15 , Subpart C , intentional Radiators	
ANSI C63.10 (2013)	American National Standard of Procedures for Compliance Testing of Unlicensed Wireless Devices	

(*) if the log  is mentioned, the measurement is under accreditation : 041-T – ISO17025

MRA : between E.C. and USA : CAB (EMC) [designation number BE0002] date of validation 15.01.2002

Equipment Classifications

Field Strength Calculation.

The field strength is calculated in the receiver , for conducted emission on the mains LISN-2line is selected , for spurious radiated emission the LDNRE_band-CD (30-1000MHz) and LDNRE_FCChigh(>1GHz) is selected

LISN-2line is the Transducer Factor for the LISN (combination of the attenuation of the LISN and cable in the range 150kHz-30MHz)

EMCO6511uV and EMCO6502v are the Transducer factor for the H-field antenna (combination of the AF of the antenna , pre-amplifier and cables in the range 9k-30MHz) .

LDNRE_band-CD is the Transducer factor for the bicon or log antenna (combination of the AF of the R&S antenna , pre-amplifier and cables in the range 30MHz-1GHz) .

SECTION 5: OPERATION OF EUT DURING TESTING

The following performance criteria are described in the standard .

Operating modes during emission testing

Two modes were used during emission testing: (a) carrier without modulation and (b) carrier with modulation during 100ms and period 1second (data stream is generated using internal random data sequencer of PN7150). The test modes used are identical to test modes used in FCC ID OWROM5578-PN7150S.

SECTION 6: SUMMARY OF TEST RESULTS

6.1 Test results of the tests.

emission measurement according to : FCC part 15		
Test §	The EUT complies limits	remarks
§ 15.207 : AC power conducted emissions	yes	1
§ 15.225 radiated emissions 9k-1GHz	yes	
§ 15.225 Operation within the band	yes	
§ 15.225 frequency tolerance	yes	
§ 15.225 Occupied bandwidth	yes	

Remark 1 : tested with +5Vdc power

Section 15.19 Labelling requirements.

(3) All other devices shall bear the following statement in a conspicuous location on the device:

This device complies with Part 15 of the FCC Rules.
 Operation is subject to the following two conditions:
 (1) this device may not cause harmful interference,
 and (2) this device must accept any interference received, including
 interference that may cause undesired operation.

(b) Products subject to authorization under a Declaration of Conformity shall be labeled as follows:

(1) The label shall be located in a conspicuous location on the device and shall contain the unique identification described in Section 2.1074 of this chapter and the following logo:

(i) If the product is authorized based on testing of the product or system; or

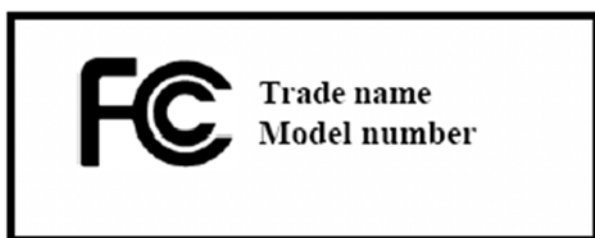

SECTION 7: DETAILED TEST RESULTS

7.1. EMISSION TEST

The test has been performed according to the standard: CFR 47 part15 Subpart c.

7.1 CONDUCTED EMISSION TEST : power

CONDITIONS
<p>The equipment was placed at ± 40cm above the floor. The test has been performed in a shielded room. The conducted emission level was measured with a LISN according to CISPR16/ANSI C63.4 (0.15 MHz-30 MHz). Test voltage : 5Vdc Test specification : ANSI C63.10 section 6.2 Specification reference :C.F.R.47 part 15.207 The upper limit line is the quasi-peak limit line . The lower limit line is the average limit line. Test date :2019-04-10</p>
<p>Test equipment : Receiver: R&S ESU40 , MN20112350 Limiter : R&S ESH3Z2 , MN : 2006150 LISN : R&S ESH2-Z5 , MN149028 Cables : IR07 , 192 , 194</p>

Hardware Setup:	LISN-2line
Receiver:	[ESU 40]
Level Unit:	dB μ V
LISN TDF :	Correction Table (Line 0): ESH2-Z5-16A-N
	Correction Table (Line 1): ESH2-Z5-16A-L

Subrange	Step Size	Detectors	IF BW	Meas. Time	Preamp
150 kHz - 30 MHz	5 kHz	PK+; AVG	9 kHz	0,02 s	0 dB

Setup

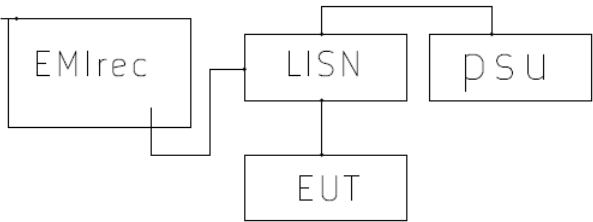

Mode : RF_ON

Conducted emission L1-PE

Frequency (MHz)	QuasiPeak (dBµV)	Limit (dBµV)	Margin (dB)	Frequency (MHz)	Average (dBµV)	Limit (dBµV)	Margin (dB)
13.560000	57.03	60.00		13.560000	57.19	50.00	
27.120000	46.25	60.00	13.75	27.120000	46.38	50.00	3.62

fig1 : plot results L1- PE

Conducted emission N-PE

Frequency (MHz)	QuasiPeak (dBµV)	Limit (dBµV)	Margin (dB)	Frequency (MHz)	Average (dBµV)	Limit (dBµV)	Margin (dB)
13.560000	57.50	60.00		13.560000	57.55	50.00	
27.120000	47.45	60.00	12.55	27.120000	47.42	50.00	2.58

fig2: plot results N- PE

Mode : MOD

Conducted emission L1-PE

Frequency (MHz)	QuasiPeak (dBµV)	Limit (dBµV)	Margin (dB)	Frequency (MHz)	Average (dBµV)	Limit (dBµV)	Margin (dB)
0.150000	40.69	66.00	25.31	0.190000	29.64	53.82	24.18
13.455000	33.51	60.00	26.49	0.245000	30.11	51.76	21.65
13.475000	30.07	60.00	29.93	12.965000	32.15	50.00	17.85
13.660000	29.06	60.00	30.94	13.470000	26.90	50.00	20.10

Fig3 : plot results L1- PE

Conducted emission N-PE

Frequency (MHz)	QuasiPeak (dBµV)	Limit (dBµV)	Margin (dB)	Frequency (MHz)	Average (dBµV)	Limit (dBµV)	Margin (dB)
0.185000	34.70	64.26	29.56	0.150000	34.85	56.00	21.15
0.210000	39.74	63.21	23.46	0.210000	31.33	53.61	22.28
13.555000	39.75	60.00	20.25	13.640000	30.60	50.00	19.40
13.670000	29.44	60.00	30.56	13.755000	31.92	50.00	18.08

Fig4: plot results N- PE

Remark : 13.56MHz is the part of the intentional generator frequency

Test result	pass
-------------	------

Mode : RF_ON
 fig1 Conducted emission L1-PE

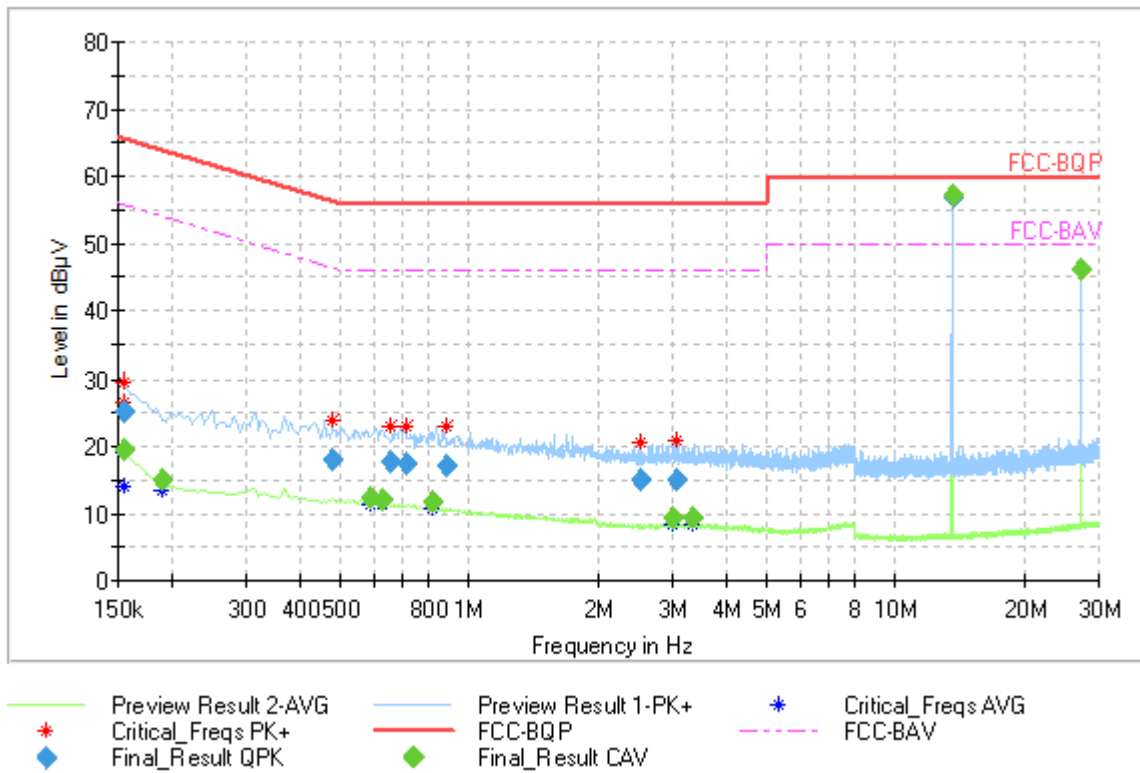
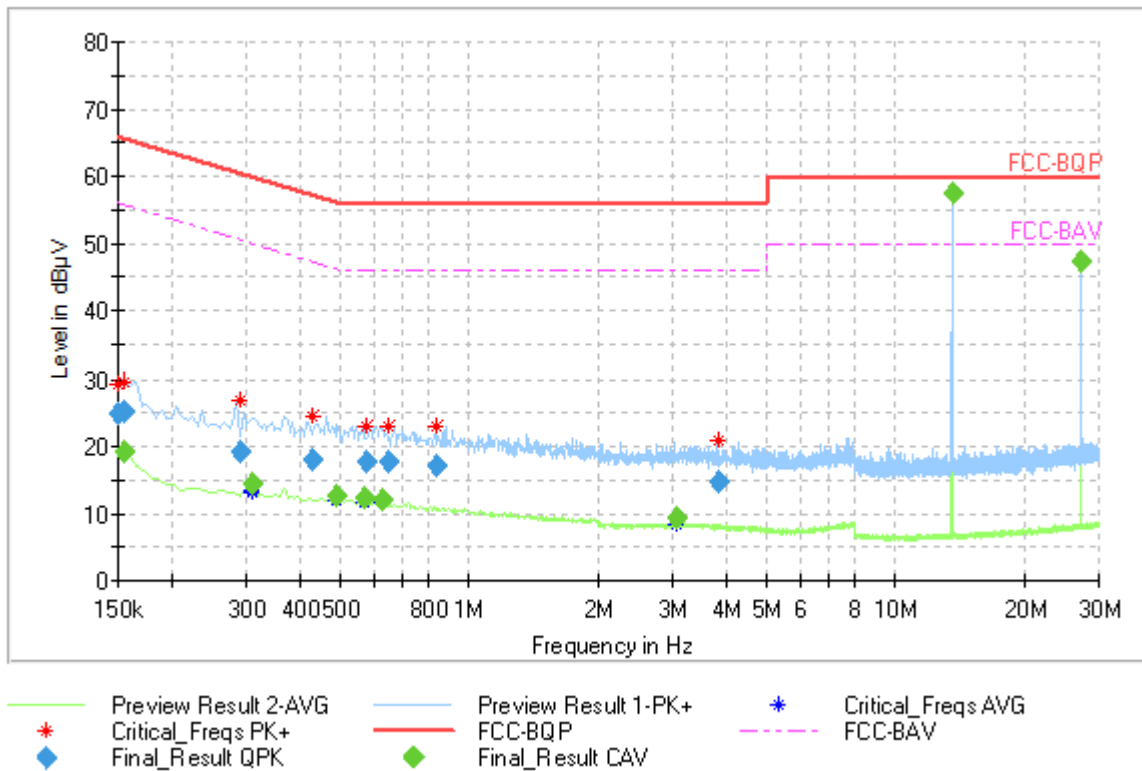

fig2 Conducted emission N-PE



Mode : Mod
 fig3 Conducted emission L1-PE

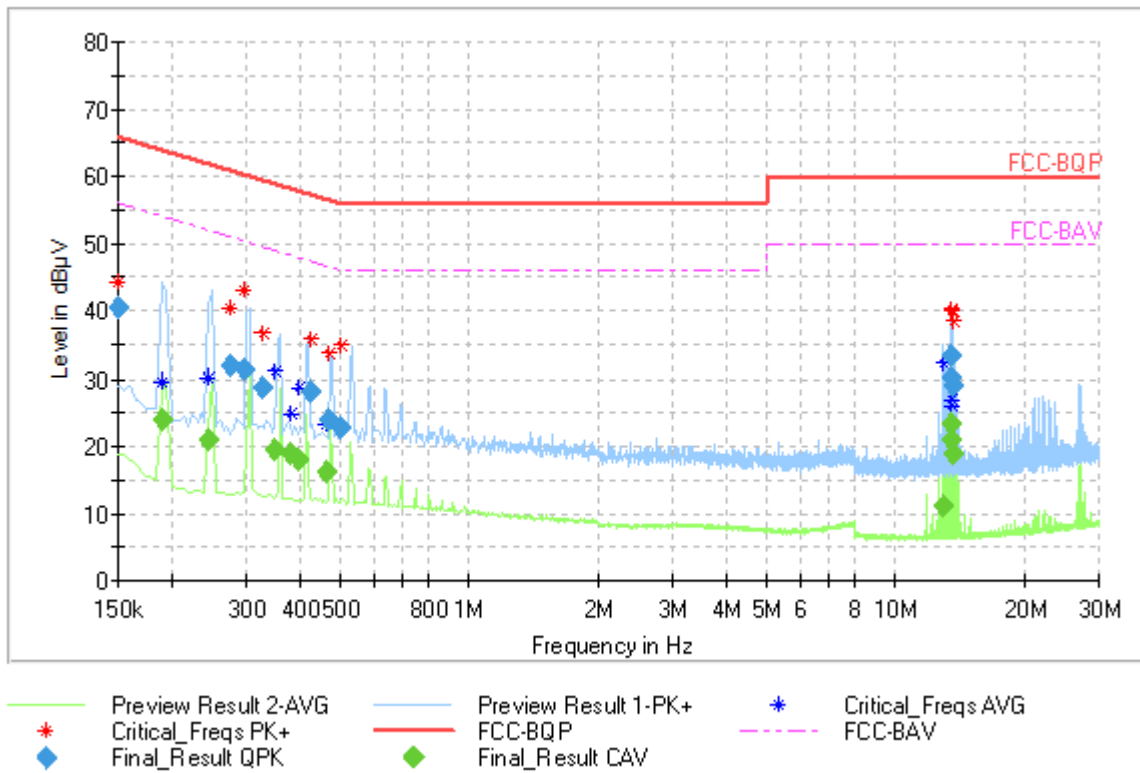
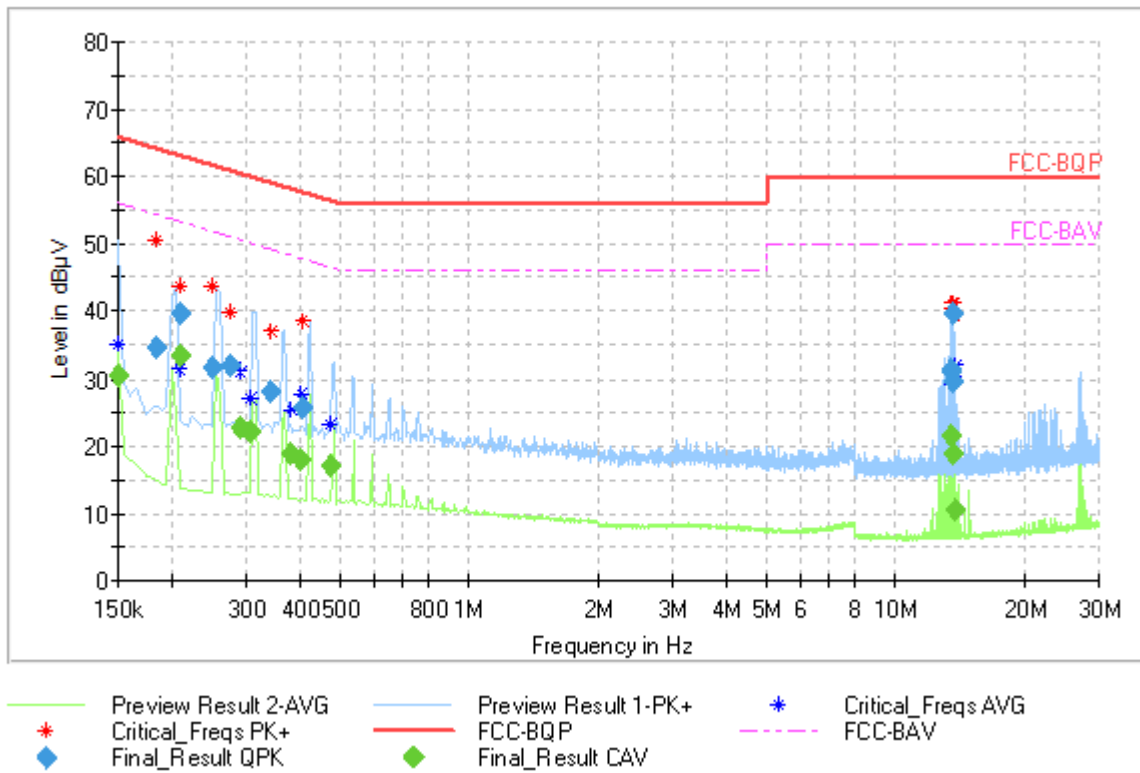

fig4 Conducted emission N-PE



7.2.1 Radiated emissions (9k-30MHz)

CONDITIONS
The equipment was placed at ± 80 cm above the floor. The test has been performed in a shielded room. The radiated emission level was measured with a shielded loop according to CISPR16 Test voltage : +5Vdc Test specification : ANSI C63.10 section 6.4 and 6.5 Specification reference :C.F.R.47 part 15.225 The upper limit line is the quasi-peak limit line . Test date :2019-04-10 and 12
Test equipment : Receiver: R&S ESU40 , MN : 20112350 Antenna : EMCO6511 , MN: 459574 Antenna : EMCO6502 , MN:20112384 Preamp : hp8447A , MN : 475041 Turntable : RST 073 Controller : RSC 02

Range 9k-30kHz

Hardware Setup:	FCC-Efield-low1
Receiver:	[ESU 40]
Level Unit:	dB μ V/m
TDF :	Correction Table (vertical): EMCO6511uV Correction Table (horizontal): EMCO6511uV

Range 30k-30MHz

Hardware Setup:	FCC-Efield-low
Receiver:	[ESU 40]
Level Unit:	dB μ V/m
TDF :	Correction Table (vertical): EMCO6502v Correction Table (horizontal): EMCO6502v

Subrange	Step Size	Detectors	IF BW
9 kHz - 90 kHz	100 Hz	AVG	200 Hz
90 kHz - 110 kHz	100 Hz	QPK	200 Hz
110 kHz - 150 kHz	100 Hz	AVG	200 Hz
150 kHz - 490 kHz	4,5 kHz	AVG	9 kHz
490 kHz - 30 MHz	4,5 kHz	QPK	9 kHz

RF_ON

Frequency (MHz)	QuasiPeak (dB μ V/m)	Limit (dB μ V/m)	Margin (dB)	Meas. Time (ms)	Bandwidth (kHz)	Height (cm)	Azimuth (deg)
13.560000	54.35	49.5		1000	9.000	100.0	180.0

RF_ON

Frequency (MHz)	QuasiPeak (dB μ V/m)	Limit (dB μ V/m)	Margin (dB)	Meas. Time (ms)	Bandwidth (kHz)	Height (cm)	Azimuth (deg)
13.560000	42.57	49.5		1000	9.000	100.0	180.0
13.663500	24.46	49.5	25.04	1000	9.000	100.0	225.0

Remark : 13.56MHz is the part of the intentional generator frequency

Setup

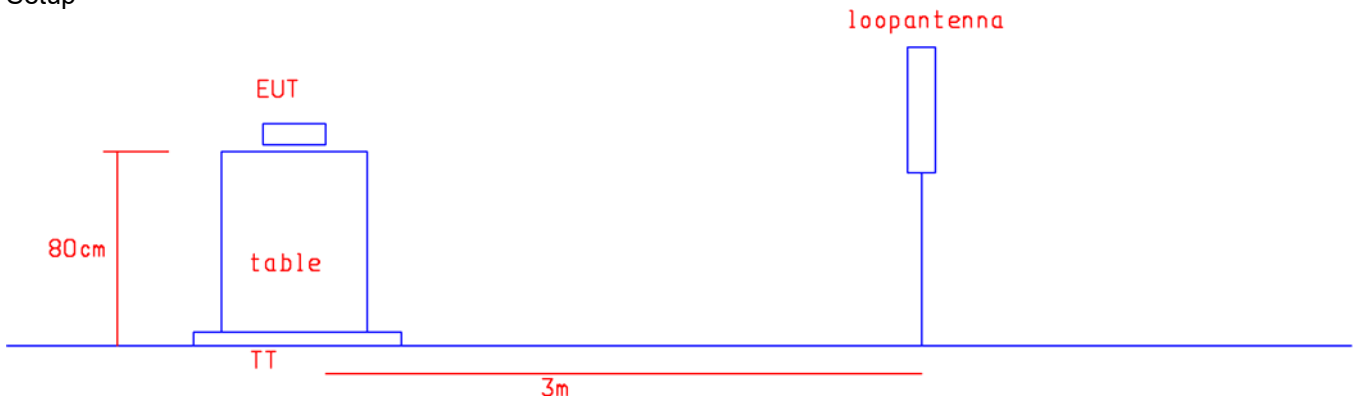

Test result	pass
-------------	------

Mode : RF_ON
 Plot 9k-30kHz

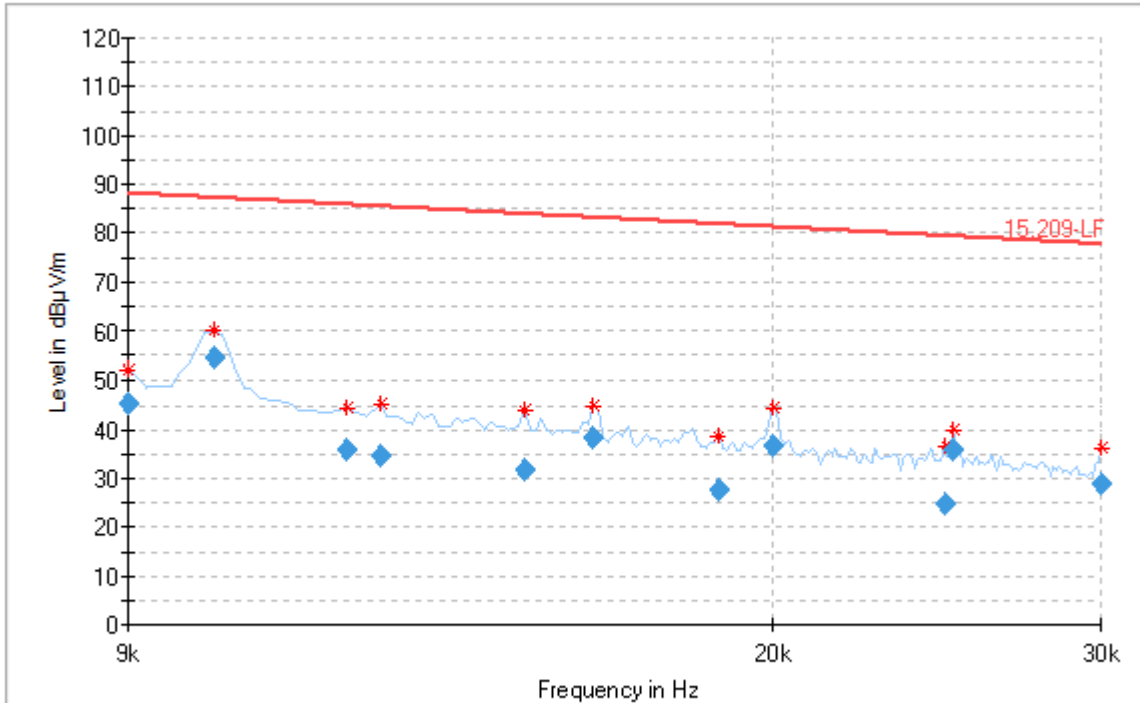

— Preview Result 1-PK+
 * Critical_Freqs PK+
 — 15.209-LF
 ◆ Final_Result C

Plot 30k-30MHz

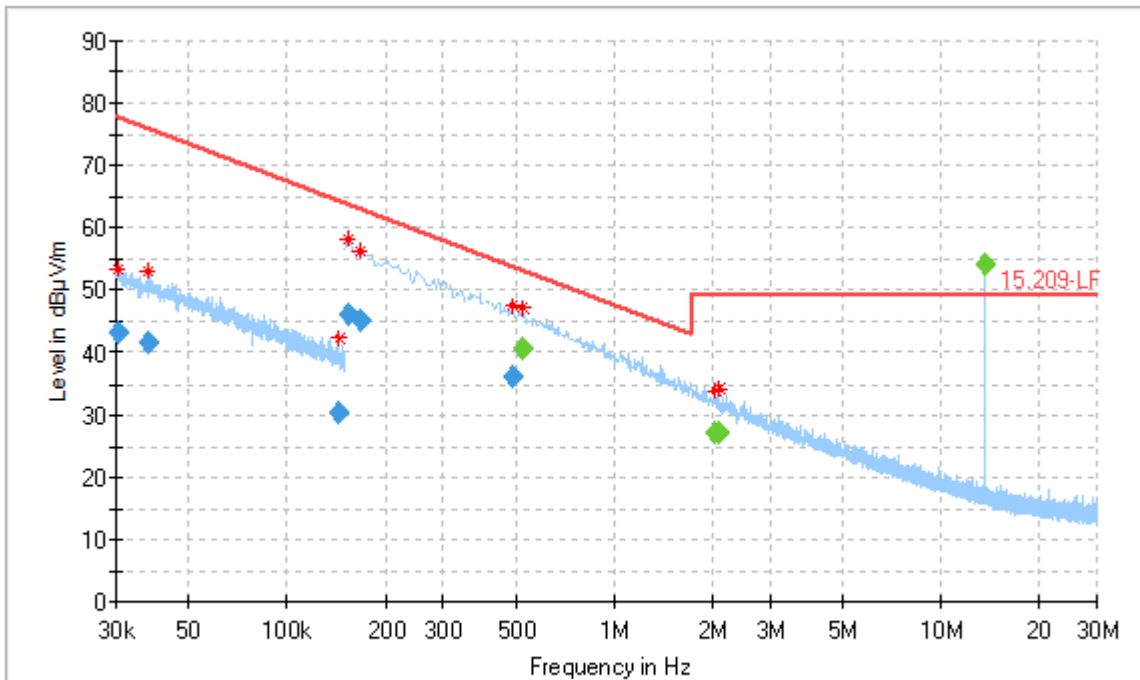

— Preview Result 1-PK+
 * Critical_Freqs PK+
 — 15.209-LF
◆ Final_Result CAV
◆ Final_Result QPK

Mode : Mod
 Plot 9k-30kHz

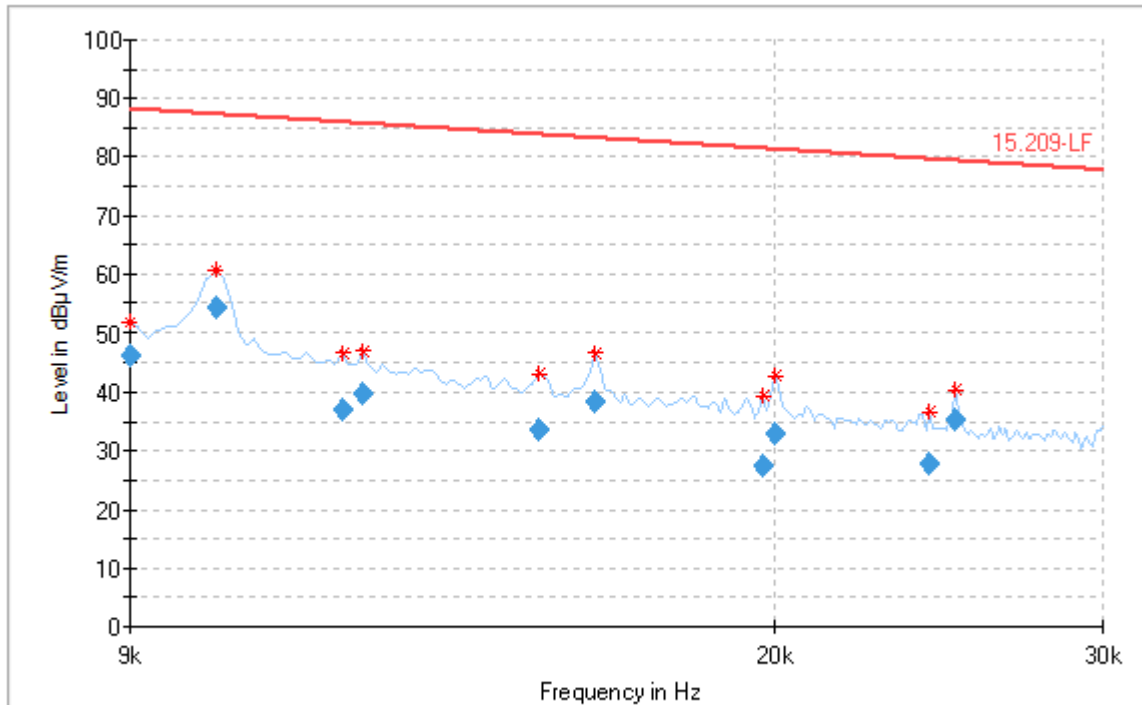

Preview Result 1-PK+ * Critical_Freqs PK+ 15.209-LF Final_Result C

Plot 3k-30MHz

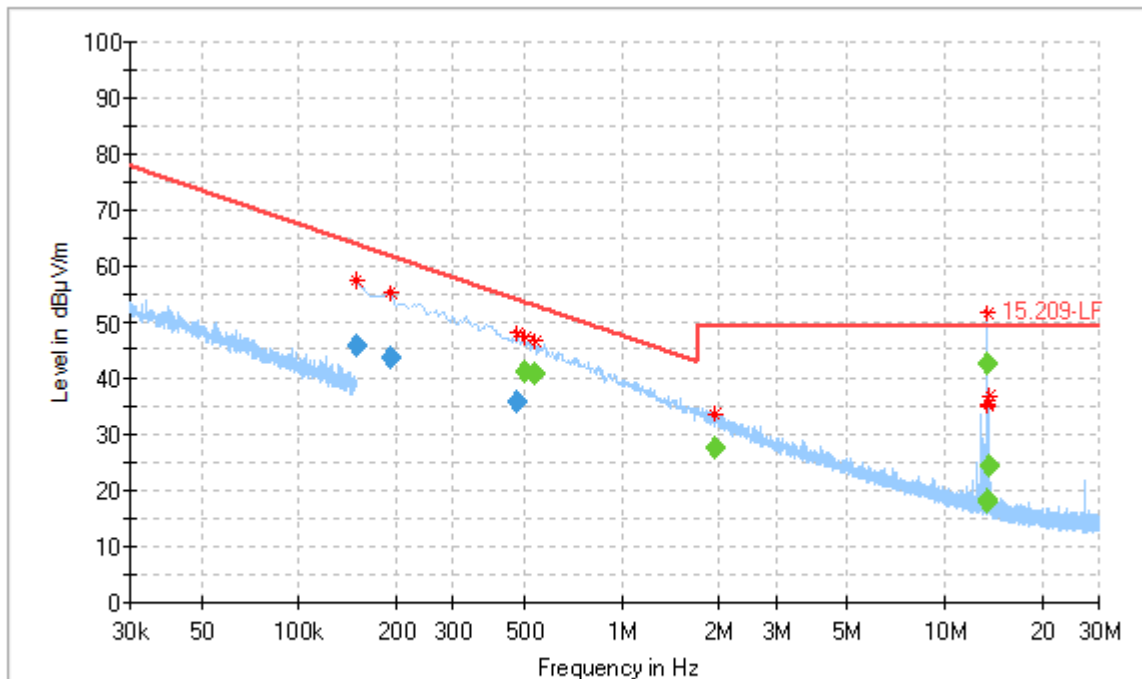

Preview Result 1-PK+ * Critical_Freqs PK+ 15.209-LF
 Final_Result CAV Final_Result QPK

7.2.2 Radiated emissions (30-1000MHz)

CONDITIONS
<p>The equipment was placed at ± 80cm above the floor. The test has been performed in a shielded room. The radiated emission level was measured with a bicon antenna (30-200MHz) and a log antenna (200-1000MHz) Specification reference :C.F.R.47 part 15.225 Test specification : ANSI C63.10 section 6.3 and 6.5 (f <1GHz) Test voltage : +5Vdc The upper limit line is the quasi-peak limit line Test date :2019-04-08 and 11</p>
<p>Test equipment : Receiver: R&S ESU40 , MN : 20112350 Antenna : R&S HK116 , MN : 2006057 Antenna : R&S HL562 , MN :2006052 Antenna mast : RSM 010 Turntable : RST 073 Controller : RSC 02</p>

Range 30-200MHz

Hardware Setup:	LDNRE band-CD
Receiver:	[ESU 40]
Level Unit:	dB μ V/m
TDF :	Correction Table (vertical): HK116
	Correction Table (horizontal): HK116

Range 200-1000MHz

Hardware Setup:	LDNRE band-CD
Receiver:	[ESU 40]
Level Unit:	dB μ V/m
TDF :	Correction Table (vertical): HL562ANSIJAN
	Correction Table (horizontal): HL562ANSIJAN

Subrange	Step Size	Detectors	IF BW
30 MHz - 1 GHz	62.5 kHz	PK/QP	120 kHz

Setup 30-200MHz

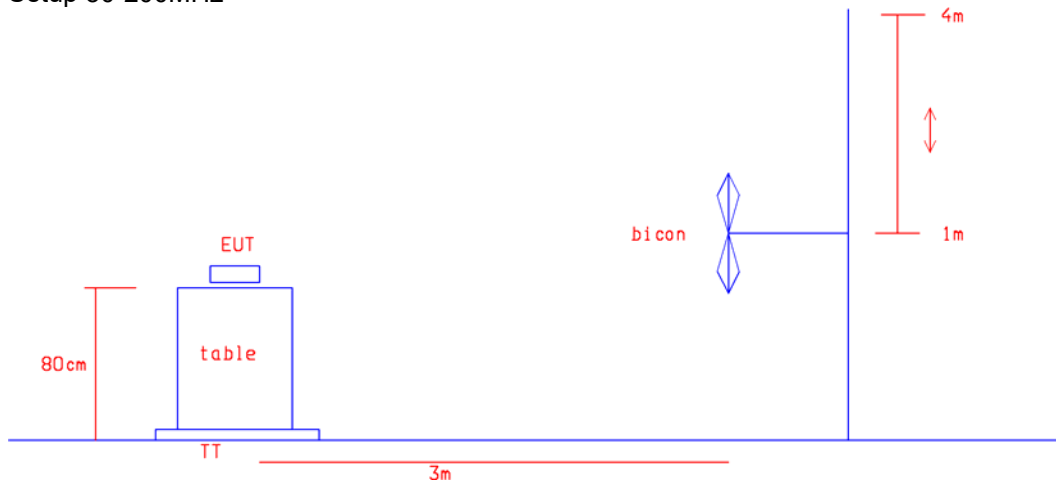

Setup 200-1000MHz

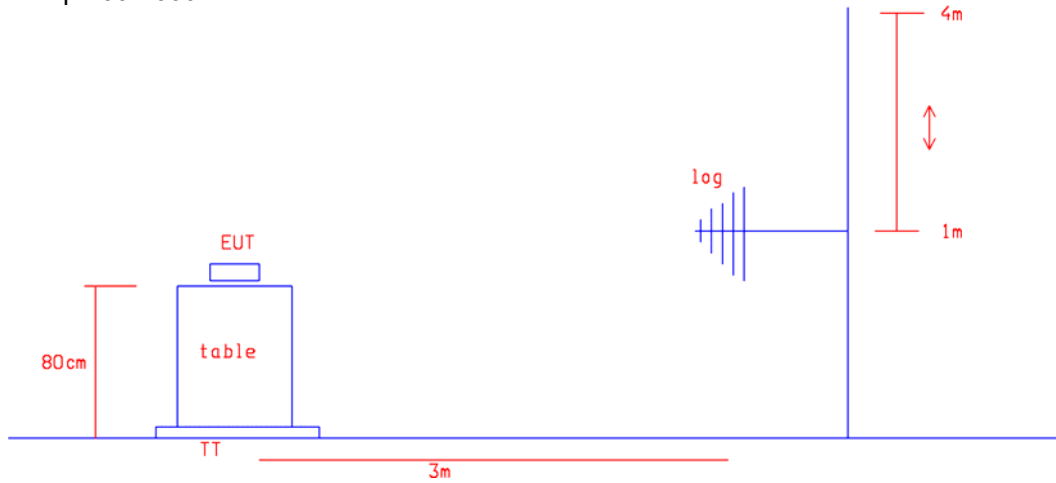

Test result	pass
-------------	------

Results : RF_ON

Frequency (MHz)	QuasiPeak (dBµV/m)	Limit (dBµV/m)	Margin (dB)	Meas. Time (ms)	Bandwidth (kHz)	Height (cm)	Pol	Azimuth (deg)
40.720000	21.24	40.00	18.76	1000.0	120.000	125.0	V	90.0
54.240000	29.79	40.00	10.21	1000.0	120.000	100.0	V	270.0
135.600000	37.93	43.50	5.57	1000.0	120.000	150.0	H	270.0
189.840000	34.84	43.50	8.66	1000.0	120.000	100.0	H	225.0
191.840000	34.03	43.50	9.47	1000.0	120.000	175.0	H	270.0
216.960000	43.63	46.00	2.37	1000.0	120.000	150.0	H	270.0
244.080000	39.26	46.00	6.74	1000.0	120.000	150.0	H	270.0
271.200000	41.20	46.00	4.80	1000.0	120.000	125.0	H	225.0
298.320000	42.19	46.00	3.81	1000.0	120.000	100.0	H	225.0
325.440000	34.79	46.00	11.21	1000.0	120.000	100.0	H	225.0
352.560000	33.35	46.00	12.65	1000.0	120.000	100.0	H	225.0

Mod

Frequency (MHz)	QuasiPeak (dBµV/m)	Limit (dBµV/m)	Margin (dB)	Meas. Time (ms)	Bandwidth (kHz)	Height (cm)	Pol	Azimuth (deg)
108.480000	27.58	43.50	15.92	1000.0	120.000	225.0	H	90.0
135.600000	33.67	43.50	9.83	1000.0	120.000	175.0	H	90.0
162.720000	31.38	43.50	12.12	1000.0	120.000	125.0	H	270.0
189.840000	29.19	43.50	14.31	1000.0	120.000	225.0	H	225.0
216.960000	35.53	46.00	10.47	1000.0	120.000	150.0	H	135.0
244.080000	37.13	46.00	8.87	1000.0	120.000	125.0	H	225.0
271.200000	32.49	46.00	13.51	1000.0	120.000	200.0	H	225.0
287.440000	27.91	46.00	18.09	1000.0	120.000	100.0	H	225.0
298.320000	36.86	46.00	9.14	1000.0	120.000	150.0	H	315.0
325.440000	32.54	46.00	13.46	1000.0	120.000	125.0	H	315.0

RF_ON
 Plot 30-200MHz

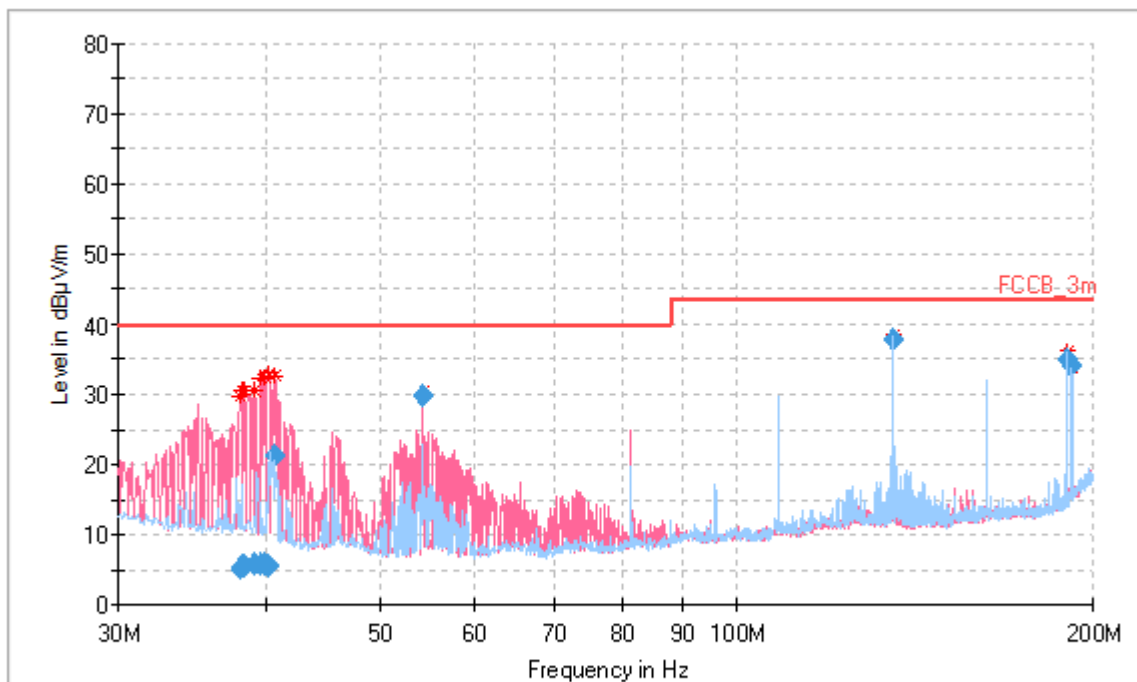

— Preview Result 1V-PK+ * Critical_Freqs PK+ — FCCB_3m
◆ Final_Result QPK — Preview Result 1H-PK+

Plot 200-1000MHz

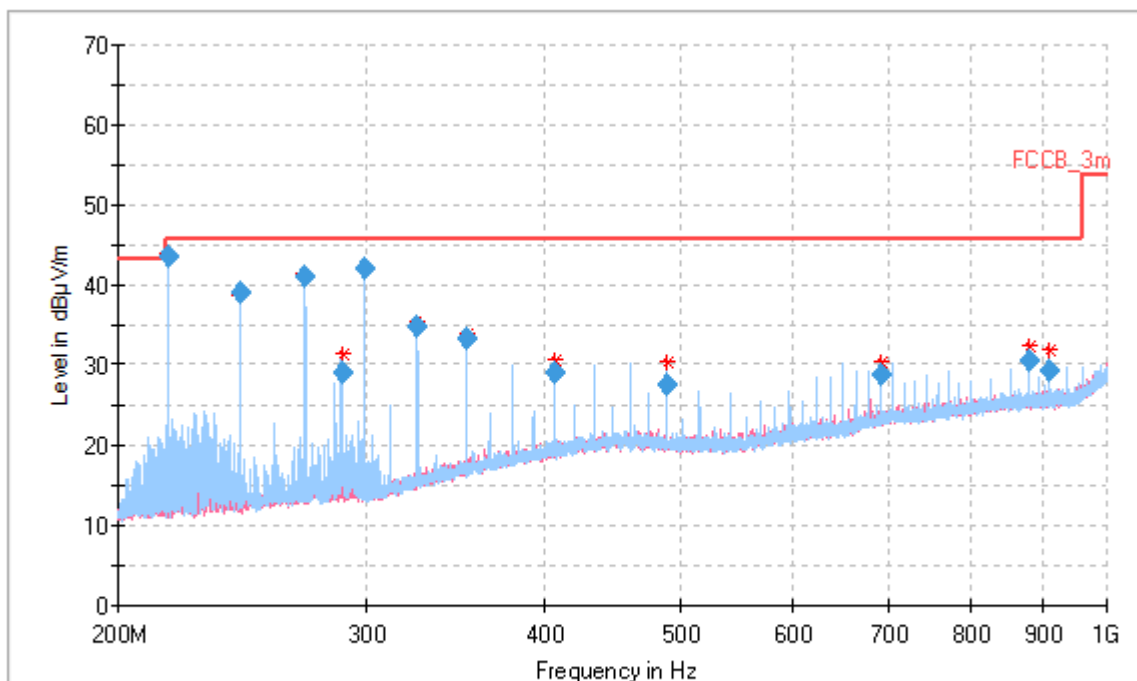

— Preview Result 1V-PK+ — Preview Result 1H-PK+ * Critical_Freqs PK+
— FCCB_3m ◆ Final_Result QPK

Mod
 Plot 30-200MHz

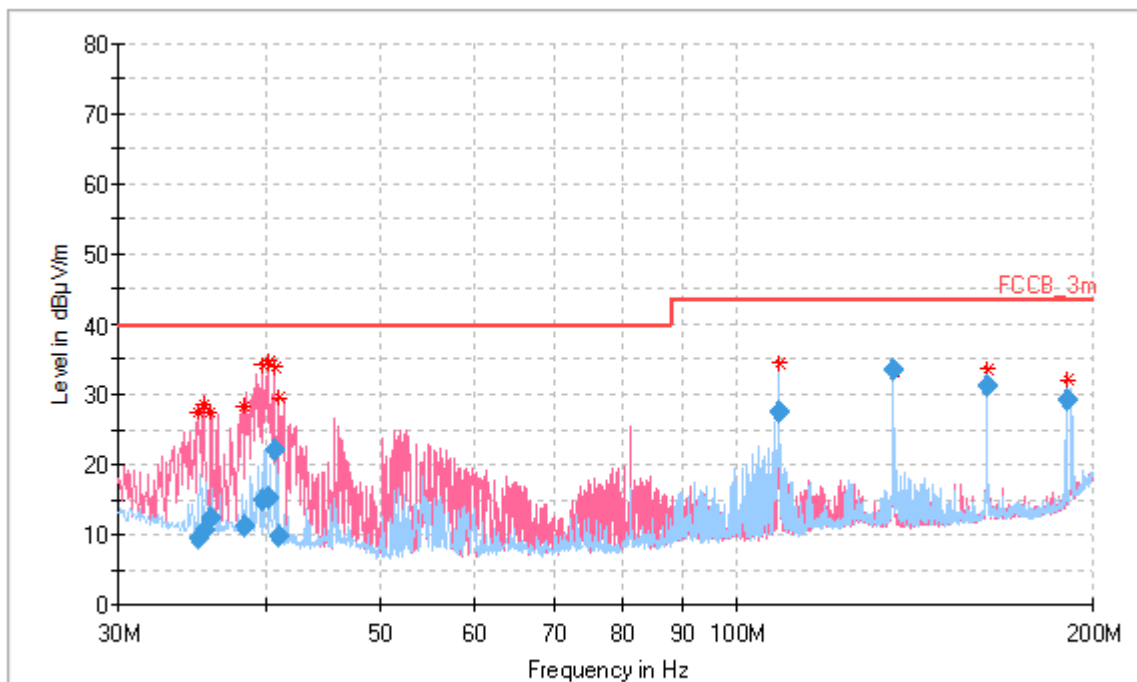

Preview Result 1V-PK+ Preview Result 1H-PK+ * Critical_Freqs PK+
 FCCB_3m ◆ Final_Result QPK

Plot 200-1000MHz

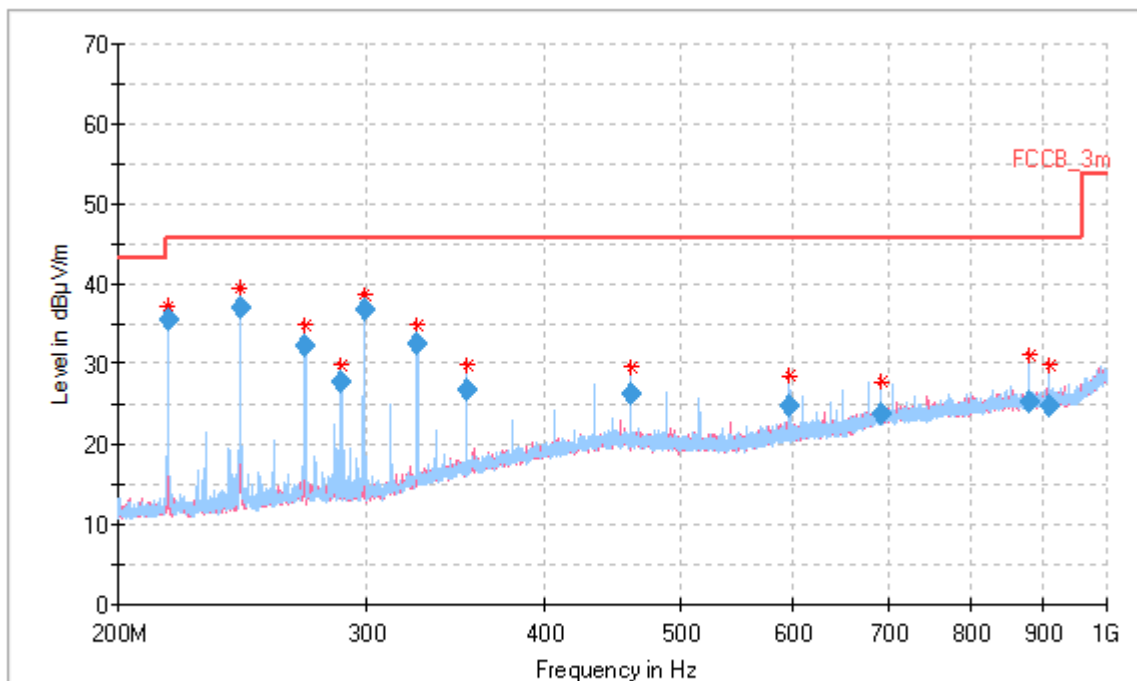

Preview Result 1V-PK+ Preview Result 1H-PK+ * Critical_Freqs PK+
 FCCB_3m ◆ Final_Result QPK

7.3 Field strength within band

CONDITIONS
Specification reference : C.F.R.47 part 15.225(a,b,c) (a) The field strength of any emissions within the band 13.553-13.567 MHz shall not exceed 15,848 microvolts/meter at 30 meters. (b) Within the bands 13.410-13.553 MHz and 13.567-13.710 MHz, the field strength of any emissions shall not exceed 334 microvolts/meter at 30 meters. (c) Within the bands 13.110-13.410 MHz and 13.710-14.010 MHz the field strength of any emissions shall not exceed 106 microvolts/meter at 30 meters. Used test distance : 1m and 1m limit line Used Test voltage : +5Vdc The limit line 1 is the quasi-peak limit line Test date : 2019-04-10
Receiver: R&S ESU40 , MN : 20112350 Antenna : EMCO6502 , MN:20112384 Turntable : RST 073 Controller : RSC 02

Calculation limits : limits in standard @30m : 15,848 μ V/m is 84dB μ V/m @30m
 Distance correction factor (refer 15.31) : by using the square of an inverse linear distance extrapolation factor (40 dB/decade). In case of a measurement distance of 3m : 40*log(30/1) = 59dB

Hardware Setup:	FCC-Efield-1356
Receiver:	[ESU 40]
Level Unit:	dB μ V/m

Subrange	Step Size	Detectors	IF BW
13,11 MHz - 14,01 MHz	4 kHz	QP	9 kHz

setup

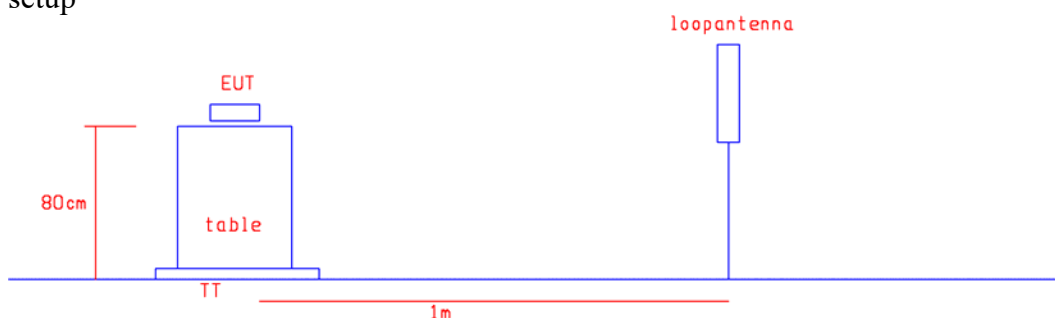

Modulation on

Frequency (MHz)	QuasiPeak (dB μ V/m)	Limit (dB μ V/m)	Margin (dB)
13.560	68.7	143.0	74.3

CW

Frequency (MHz)	QuasiPeak (dB μ V/m)	Limit (dB μ V/m)	Margin (dB)
13.560	82.39	143.0	60.61

Test result	pass
-------------	------

Plot : mod

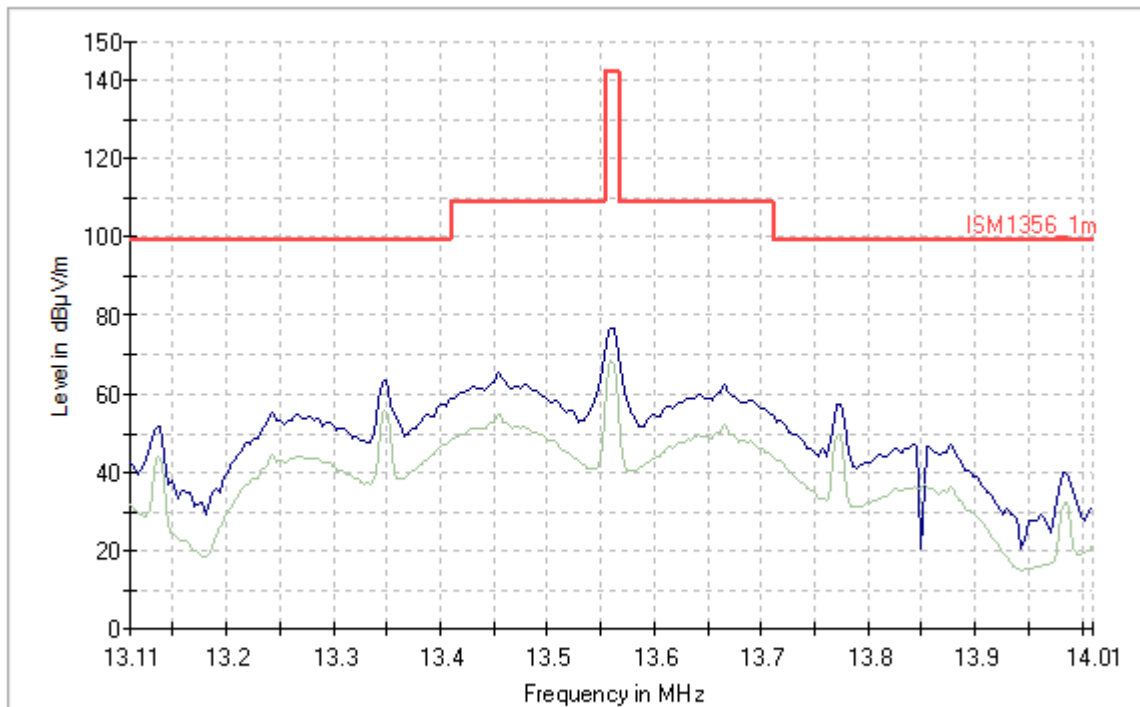

— PK+_MAXH — QP — ISM1356_1m

Plot : RF_ON

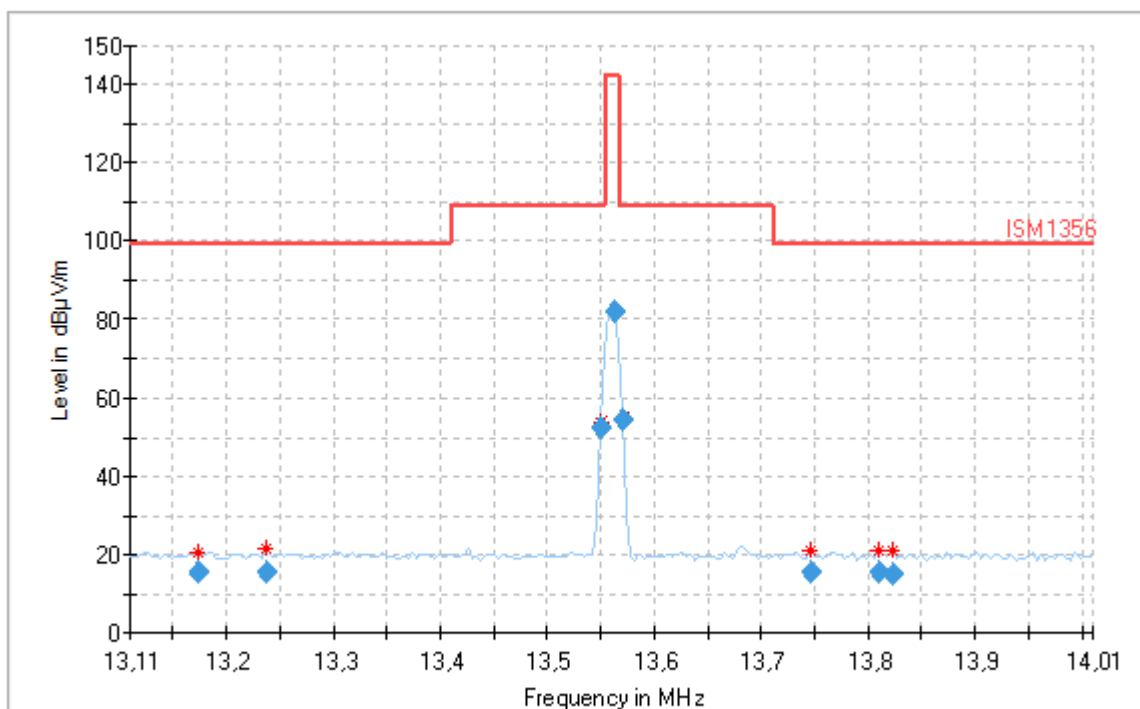

— Preview Result 1-PK+ * Critical_Freqs PK+ — ISM1356 ◆ Final_Result QP

CONDITIONS

§15.215 Additional provisions to the general radiated emission limitations.

(a) The regulations in §§15.217 through 15.257 provide alternatives to the general radiated emission limits for intentional radiators operating in specified frequency bands. Unless otherwise stated, there are no restrictions as to the types of operation permitted under these sections.

(b) In most cases, unwanted emissions outside of the frequency bands shown in these alternative provisions must be attenuated to the emission limits shown in §15.209. In no case shall the level of the unwanted emissions from an intentional radiator operating under these additional provisions exceed the field strength of the fundamental emission.

(c) Intentional radiators operating under the alternative provisions to the general emission limits, as contained in §§15.217 through 15.257 and in subpart E of this part, must be designed to ensure that the 20 dB bandwidth of the emission, or whatever bandwidth may otherwise be specified in the specific rule section under which the equipment operates, is contained within the frequency band designated in the rule section under which the equipment is operated. In the case of intentional radiators operating under the provisions of subpart E, the emission bandwidth may span across multiple contiguous frequency bands identified in that subpart. The requirement to contain the designated bandwidth of the emission within the specified frequency band includes the effects from frequency sweeping, frequency hopping and other modulation techniques that may be employed as well as the frequency stability of the transmitter over expected variations in temperature and supply voltage. If a frequency stability is not specified in the regulations, it is recommended that the fundamental emission be kept within at least the central 80% of the permitted band in order to minimize the possibility of out-of-band operation.

Test : ANSI 63.10 Clause 6.9.2.

Test date : 2019-04-10

Receiver: R&S ESU40 , MN : 20112350

Antenna : EMCO6502 , MN:20112384

Turntable : RST 073

Controller : RSC 02

setup

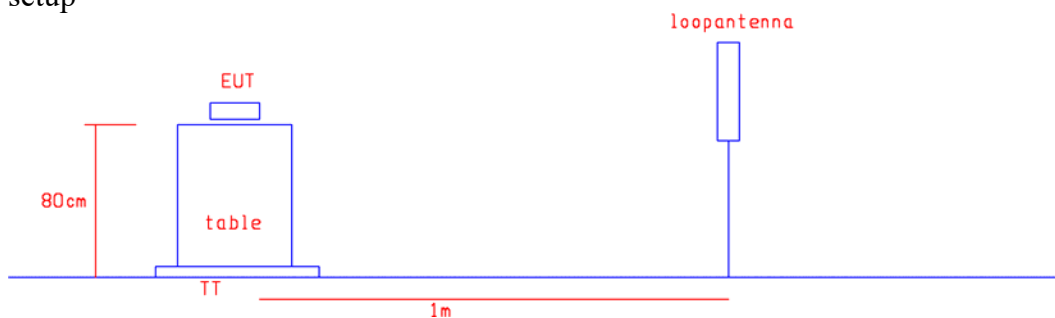

Test result	pass
-------------	------

plot



Controlled by EMC32

*RBW 10 Hz Delta 3 [T1]
 *VBW 1 kHz -20.31 dB
 SWT 20 s -41.666666681 Hz

Ref 87 dBµV *Att 10 dB

1 RM*
 MAXH

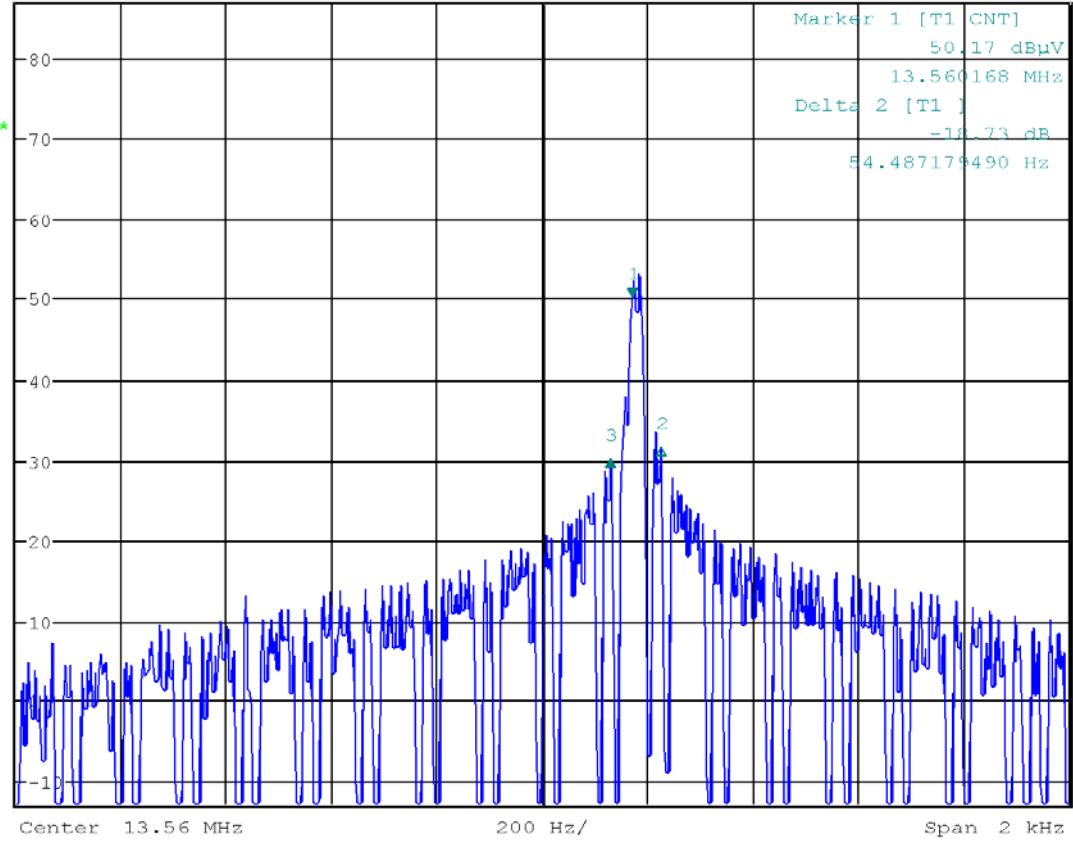

Date: 10.APR.2019 12:23:44

7.5 frequency tolerance

CONDITIONS
Specification reference :C.F.R.47 part 15.225(e) (e) The frequency tolerance of the carrier signal shall be maintained within $\pm 0.01\%$ of the operating frequency over a temperature variation of -20 degrees to $+ 50$ degrees C at normal supply voltage, and for a variation in the primary supply voltage from 85% to 115% of the rated supply voltage at a temperature of 20 degrees C. For battery operated equipment, the equipment tests shall be performed using a new battery. Test voltage : +5Vdc Test date : 2019-04-11
Test equipment : Near field probe R&S DC power supply : HP E3631 , MN : 462043 DVM : Fluke 73III , MN :2006126 Climate chamber : K7 Frequency counter hp5315 , MN: 2006225

Test procedure temperature :

The EUT is placed in an climate chamber . The voltage to the EUT is the nominal voltage and the carrier is in CW (no modulation) . A near field probe is used to measure the carrier .

Before the measurement there is sufficient time to allow the EUT to stabilize at the temperature .

Maximum allowed frequency deviation is $\pm 0.01\%$ or 100ppm

Test : temperature test : -20 to $+50^{\circ}\text{C}$

Temperature $^{\circ}\text{C}$	Frequency (kHz)	Tolerance (ppm)	result
-20	13560,232	17	pass
+25	13560,182	13	pass
+50	13560,109	8	pass

The EUT is placed in an climate chamber . The voltage to the EUT is the nominal voltage and the carrier is in CW (no modulation) . A near field probe is used to measure the carrier .

Before the measurement there is sufficient time to allow the EUT to stabilize at the temperature .

Maximum allowed frequency deviation is $\pm 0.01\%$ or 100ppm , fixed temperature : $+20^{\circ}\text{C}$

Test : voltage test : to $\pm 10\%$, $V_{\text{nom}} = 5\text{V}$

Voltage	frequency	Tolerance	result
4.5V	13560,164	12	pass
5.0V	13560,166	12.2	pass
5.5V	13560,164	12	pass

setup

thermal chamber

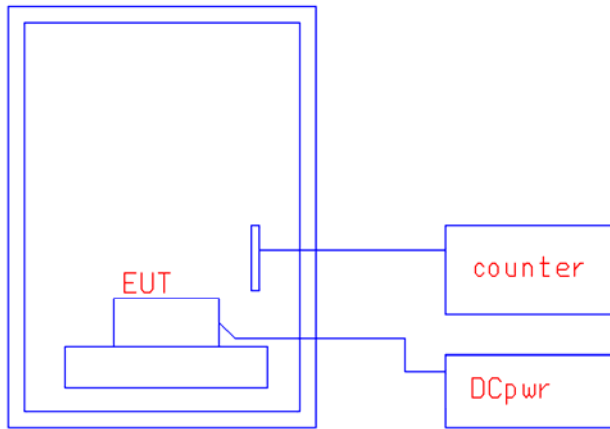

7.5. limits

Table : CE on mains (class)

frequency (MHz)	QP (dB μ V)	AV (dB μ V)
0.15-0.50	66	56
0.50-5.0	56	46
5.0-30	60	50

Table : spurious 9k-30MHz , 3m distance

Frequency Limit
 MHz dBuV/m

0,009000	128,5
0,490000	94,0
0,490000	73,8
1,705000	63,0
1,705000	69,5
13,110000	69,5
13,110000	80,5
13,410000	80,5
13,410000	90,5
13,553000	90,5
13,553000	124,0
13,567000	124,0
13,567000	90,5
13,710000	90,5
13,710000	80,5
14,010000	80,5
14,010000	69,5
30,000000	69,5

Table : RE @ 3m

Frequency (MHz)	QP (dB μ V/m)	AV (dB μ V/m)	Peak (dB μ V/m)
30-88	40,0	--	--
88-216	43,5	--	--
216-960	46,0	--	--
960-1000	54,0	--	--
1000-18000	--	54,0	

Table : 13,56MHz
distance 1m

MHz	dB μ V/m
13,410000	99,5
13,553000	109,5
13,553000	143,0
13,567000	143,0
13,567000	109,5
13,710000	109,5
13,710000	99,5
14,010000	99,5

distance 3m

MHz	dB μ V/m
13,110000	80,5
13,410000	90,5
13,553000	90,5
13,553000	124,0
13,567000	124,0
13,567000	90,5
13,710000	90,5
13,710000	80,5
14,010000	80,5

7.6. Test equipment due dates

type	MN	Cal due
ESU40	20112350	2019-11-30
ESH2-Z5	149028	2019-11-30
ESH3-Z2	2006150	2019-10-31
EMCO6502	20112384	2020-12-31
EMCO6511	459574	2020-05-31
HK116	2006057	2020-09-30
HL562	2006052	2021-03-31
HF906	2006053	2021-02-28
PAM-1	20111408	2019-08-31
PAM-2	201112549	2019-08-31
EMC32 V10.x	---	N.A.

7.7 Test dates and Climate conditions.

date	2019-04-08 , 10 ,11 and 12
ambient temperature	20/22/22/23°C
relative humidity	50/48/49/47%
atmospheric pressure	1010/1013/1022/1024 hPa

SECTION 8: MEASUREMENT UNCERTAINTIES

item	uncertainty
RF frequency	$\pm 1 \times 10^{-8}$
RF field radiated	$\pm 5.0\text{dB}$
Temperature	$\pm 1^\circ\text{C}$
Humidity	$\pm 5\%$
CE mains 150k-30M	$\pm 2.4\text{dB}$

SECTION 9: ADDITIONAL INFORMATION GIVEN BY THE CUSTOMER

Applicant's role during testing

Connecting and brings the EUT in operating mode.
Witness testing

EUT information given by the customer

Auxiliary equipment connected during testing

Connected to the RFID module over a 20-pin flat cable is RFIDCONTROL. The operation mode for the FCC testing is configured using the button switch on RFID, the button toggles between carrier-only and carrier with modulation. We use an external DC power supply to supply the digital controller part and the radio part.

Cables

There are no external control or signal cables
a DC power supply cable (2 wires) l=1m

SECTION 10: MODIFICATIONS OF EUT

MODIFICATIONS OF EUT : none

SECTION 11: History of the test Report

HISTORY OF THE TEST REPORT (EDITION)

Edition	Adjustment (reason for up-grade)
PCC-RAD-4932_ed.0	Draft
PCC-RAD-4932_ed.1	Original

SECTION 12: ACCREDITATION CERTIFICATE

**Organisme belge d'Accréditation**
Belgische Accreditatieinstelling
Belgische Akkreditierungsstelle
Belgian Accreditation Body

Signatory to EA, ILAC and IAF
Multilateral Agreements

Accreditation Certificate No. 041-TEST

In compliance with the provisions of the Royal Decree of 31 January 2006 setting up BELAC, the Accreditation Board hereby declares, that the test laboratory

LABORATORIA DE NAYER VZW
J.P De Nayerlaan, 9
2860 SINT-KATELIJNE-WAVER - Belgium

has the competence to perform the tests as described in the annex which is an integral part of the present certificate, in accordance with the requirements of the standard EN ISO/IEC 17025:2005. The present accreditation is the subject of regular surveillance in order to confirm the compliance with the accreditation conditions.

The Chair of the Accreditation Board BELAC,



Issue date : 2018-12-13
Validity date : 2024-01-07
Original version of this certificate is in Dutch.

Nicole MEURÉE-VANLAETHEM



FCC :

FEDERAL COMMUNICATIONS COMMISSION
Laboratory Division
7435 Oakland Mills Road
Columbia, MD 21046

To: Tina Vounasi
SPF Economie, PME, Classes moyennes et Energie
GROW-NANDO-ADMINISTRATOR@ec.europa.eu
From: George Tannahill
George.Tannahill@fcc.gov
Date: May 10, 2018

Test Firm Name: Laboratoria De Nayer
Designation Number: BE0002
Test Firm Registration Number: 963303

Subject: FCC recognition of accreditation for Laboratoria De Nayer

We have been notified by SPF Economie, PME, Classes moyennes et Energie that Laboratoria De Nayer has been accredited as a testing laboratory.

At this time Laboratoria De Nayer is hereby recognized to perform compliance testing on equipment subject to the Commission's Declaration Of Conformity (DOC) and Certification rules for the following scope(s):

Unintentional Radiators - FCC Part15, Subpart B
Industrial, Scientific, and Medical Equipment - FCC Part 18
Intentional Radiators - FCC Part 15 Subpart C

This recognition will expire upon expiration of the accreditation or notification of withdrawal of Commission's recognition.

Any questions about this recognition should be submitted as an inquiry to the FCC Knowledge Database at www.fcc.gov/kdb.