

The Intermec logo is displayed in a bold, blue, sans-serif font. It is positioned to the left of a large, light blue graphic consisting of several overlapping circles and lines, resembling a stylized network or orbital diagram. A vertical red line extends downwards from the right side of this graphic.

User's Manual



700 Series Color Mobile Computer

Intermec Technologies Corporation

Corporate Headquarters	Technical Communications Department
6001 36th Ave. W.	550 Second Street SE
Everett, WA 98203	Cedar Rapids, IA 52401
U.S.A.	U.S.A.

www.intermec.com

The information contained herein is proprietary and is provided solely for the purpose of allowing customers to operate and service Intermec-manufactured equipment and is not to be released, reproduced, or used for any other purpose without written permission of Intermec.

Information and specifications contained in this document are subject to change without prior notice and do not represent a commitment on the part of Intermec Technologies Corporation.

© 2002 by Intermec Technologies Corporation. All rights reserved.

The word Intermec, the Intermec logo, Norand, ArciTech, CrossBar, Data Collection Browser, dcBrowser, Duratherm, EasyCoder, EasyLAN, Enterprise Wireless LAN, EZBuilder, Fingerprint, i-gistics, INCA (under license), InterDriver, Intermec Printer Network Manager, IRL, JANUS, LabelShop, Mobile Framework, MobileLAN, Nor*Ware, Pen*Key, Precision Print, PrintSet, RoutePower, TE 2000, Trakker Antares, UAP, Universal Access Point, and Virtual Wedge are either trademarks or registered trademarks of Intermec Technologies Corporation.

Throughout this manual, trademarked names may be used. Rather than put a trademark (™ or ®) symbol in every occurrence of a trademarked name, we state that we are using the names only in an editorial fashion, and to the benefit of the trademark owner, with no intention of infringement.

There are U.S. and foreign patents pending.

Microsoft, Windows, and the Windows logo are registered trademarks of Microsoft Corporation in the United States and/or other countries.

Bluetooth is a trademark of Bluetooth SIG, Inc., U.S.A.

This product includes software developed by the OpenSSL Project for use in the OpenSSL Toolkit (<http://www.openssl.org/>).

This product includes cryptographic software written by Eric Young (EAY@cryptsoft.com).

Document Change Record

This page records changes to this document. The document was originally released as Revision A.

Revision	Date	Description of Change
B	11/2002	Added information about the Siemens MC45 radio module, the tethered scanner, CAB extraction, FTP Server parameters, and Data Collection control panel applet imager options.
C	04/2003	Added information about the ambient light sensor, the beeper, keypad sequences, the alphanumeric keypad, the vibrator, an accessories list, programming notifications, the MaxiCode symbology, the Utilities control panel applet, and the Wireless Network control panel applet.
D	08/2003	Upgraded Pocket PC 2002 information to Windows Mobile 2003, upgraded all illustrations to gray-scale, added new Imager functions, moved the Automatic Data Collection COM Interface material to the SDK User's Manual.
E	01/2004	Added Model 730 information, revised CDMA Setup information, and revised Wireless Area Network Printing information.
F	04/2004	Updated 802.11 security supplicant information. Added new network selection APIs. Incorporated information about the Intermec Settings control panel applet for PSM Builds 3.00 or newer. Added information about the PhoneUtility application. Revised Chapter 4, "Network Support." Added tethered scanner and internal scanner configuration and troubleshooting information to Chapter 6, "Scanner Support."

Contents

Before You Begin	xvii
Safety Summary	xvii
Do not repair or adjust alone	xvii
First aid	xvii
Resuscitation	xvii
Energized equipment	xvii
Safety Icons	xviii
Global Services and Support	xix
Warranty Information	xix
Web Support	xix
Telephone Support	xix
Who Should Read this Manual?	xx
Related Documents	xx

1 Introduction	1
Ambient Light Sensor	2
Audio System	3
Speaker	3
Microphone	4
External Headset Jack	4
Battery	5
Beeper	7
Enable the Beeper	7
Disable the Scanner Mute	8
Select a Beeper Volume	9
Disable the Beeper	10
Keypad	11
Backlight for Keypad	11
Key Sequences	12
[Gold] or [Gold/White] Plane Keys	12
Alpha (Blue) Plane Keys	14
Modem Support	16
PSM Build Version	16
Software Build Version	17

Contents

Storage Media	18
CompactFlash Cards	18
Secure Digital Cards	18
Vibrator	19
Wireless Network Support	20
Accessories	21
What's New	22
2 Windows Mobile 2003	23
Software Builds	24
Where to Find Information	25
Basic Skills	26
Today Screen	26
Programs	27
Navigation Bar and Command Bar	28
Pop-up Menus	29
Notifications	29
Entering Information	30
Typing With the Onscreen Keyboard	31
Using Block Recognizer	32
Using Letter Recognizer	33
Using Transcriber	33
Selecting Typed Text	33
Writing on the Screen	34
Selecting the Writing	34
Converting Writing to Text	35
Drawing on the Screen	37
Creating a Drawing	37
Selecting a Drawing	37
Recording a Message	38
Creating a Recording	38
Using My Text	39
Finding and Organizing Information	40
Customizing Your 700 Color Computer	41
Adjusting Settings	41
Adding or Removing Programs	41
Microsoft ActiveSync	44

Microsoft Pocket Outlook	46
Calendar: Scheduling Appointments and Meetings	46
Synchronizing Calendar	47
Why Use Categories in the Calendar?	47
What's an All Day Event?	48
What's a Recurrence Pattern?	49
Viewing Appointments	49
Creating or Changing an Appointment	51
Creating an All Day Event	52
Setting a Reminder for an Appointment	53
Adding a Note to an Appointment	54
Making an Appointment Recurring	55
Assigning an Appointment to a Category	56
Sending a Meeting Request	57
Finding an Appointment	58
Deleting an Appointment	58
Changing Calendar Options	59
Contacts: Tracking Friends and Colleagues	60
Creating a Contact	61
Synchronizing Contacts	61
Viewing Contacts	62
Creating or Changing a Contact	63
Adding a Note to a Contact	64
Assigning a Contact to a Category	65
Copying a Contact	65
Sending a Message to a Contact	66
Finding a Contact	67
Deleting a Contact	67
Changing Contacts Options	68
Tasks: Keeping a To Do List	69
Creating a Task	70
Synchronizing Tasks	70
Notes: Capturing Thoughts and Ideas	71
Creating a Note	71
Synchronizing Notes	72
Inbox: Sending and Receiving E-mail Messages	73
Synchronizing E-mail Messages	73
Managing E-mail Messages and Folders	74
Connecting to a Mail Server	75
Composing and Sending Messages	77
Companion Programs	78
Pocket Word	78
Creating a Document	78
Typing Mode	79
Writing Mode	80
Recording Mode	80
Drawing Mode	81
Synchronizing Pocket Word Documents	81
Pocket Excel	82
Creating a Workbook	82
Tips for Working in Pocket Excel	83

MSN Messenger	84
Setting Up an Account	85
Signing In and Out	85
Working with Contacts	86
Managing Contacts	87
Sending a Message	88
Windows Media Player for Windows Mobile	89
Microsoft Reader	90
Getting Books on Your 700 Color Computer	90
Using the Library	91
Reading a Book	92
Using Reader Features	93
Removing a Book	93
Pocket Internet Explorer	94
The Mobile Favorites Folder	94
Favorite Links	94
Mobile Favorites	95
Using AvantGo Channels	96
Using Pocket Internet Explorer	96
Viewing Mobile Favorites and Channels	97
Browsing the Internet	97
Getting Connected	98
Connecting to an Internet Service Provider	98
Creating a Modem Connection to an ISP	98
Creating an Ethernet Connection to an ISP	103
Connecting to Work	104
Creating a Modem Connection to Work	106
Creating a Wireless Network Connection to Work	108
Creating a VPN Server Connection to Work	111
Creating an Ethernet Connection to Work	113
Ending a Connection	114
Connecting Directly to an E-mail Server	114
Setting Up an E-mail Account	114

3 Installing Applications 117

Packaging an Application	118
Installing Applications	119
Using Microsoft ActiveSync	119
Using the FTP Server	120
Using a Storage Card	120
Copying to a CompactFlash Card	120
Copying to a Secure Digital Storage Card	121
Updating the System Software	121

Application Migration	122
Migrating from a 700 Monochrome Computer	124
Cabinet File Installation	124
4 Network Support	125
CORE	126
Activating CORE	126
Install an Available Radio Module	126
Loading a Radio Module	126
Network Adapters	127
Ethernet Communications	128
802.11b Communications	129
802.11b Radio CORE Module	129
No Networking	132
Network Selection APIs	132
Network Connections	133
WWAN Radio Options	134
CDMA/1xRTT	134
GSM/GPRS	163
PhoneUtility	165
AT Command Interface	168
Wireless Personal Area Networking	173
Documentation	173
About the Application	173
AutoIP/DHCP	177
SNMP Configuration on the 700 Series Computer	178
Management Information Base	178
Object Identifiers	179
Configuring with SNMP	179
5 Printer Support	181
Printing ASCII	182
Directly to a Port	182
Directly to a Generic Serial Port	182
IrDA Printer Driver	182

Contents

NPCP Printer Driver	183
About NPCP	183
NPCP Driver Installation and Removal	183
Opening the NPCP Driver	184
Closing the NPCP Driver	184
Reading from the NPCP Driver	184
Writing to the NPCP Driver	184
NPCP Driver I/O Controls	185
NPCP Printer Communications	186
Sample Code	186
NPCP Error Codes	187
O'Neil Printer Driver	188
DTR Driver Installation and Removal	188
Opening the DTR Driver	189
Closing the DTR Driver	189
Writing to the DTR Driver	189
DTR Printer Communications	189
6 Scanner Support	191
Scanner Control and Data Transfer	192
EasySet Software	192
Data Collection Configuration	193
Internal Scanners	194
For Units With PSM Build 3.00 or Newer	194
Scanner and Imager Settings	195
Internal Scanner Supported Symbologies	195
Tethered Scanners	196
For Units With PSM Builds Older than 3.00	196
Enabling and Disabling	196
Error Message	197
Changing Comm Settings	197
Scanner Cabling	199
Limitations and Capabilities	199
For Units With PSM Build 3.00 or Newer	201
Configuring the Tethered Scanner	201
Troubleshooting the 1551E/1553 Tethered Scanner	204
Reset Factory Defaults	204
Tethered Scanner Supported Symbologies	205

7 Programming	207
Creating CAB Files	208
Creating Device-Specific CAB Files	208
Creating an .INF File	208
Sample .INF File	217
Using Installation Functions in SETUP.DLL	220
After the CAB File Extraction	220
Creating CAB Files with CAB Wizard	223
Troubleshooting the CAB Wizard	224
Customization and Lockdown	225
FTP Server	227
Configurable Parameters Via the Registry Editor	228
BlockSize	228
DeviceName	229
DeviceURL	229
IDNATarget	230
ManifestName	230
PauseAtStartup	231
Root	231
Transferring Files Over TCP/IP Networks	232
Stopping the FTP Server from Your Application	236
Autostart FTP	237
Kernel I/O Controls	239
IOCTL_HAL_GET_DEVICE_INFO	239
IOCTL_HAL_ITC_READ_PARM	240
IOCTL_HAL_ITC_WRITE_SYSPARM	244
IOCTL_HAL_GET_DEVICEID	246
IOCTL_HAL_GET_OAL_VERINFO	247
IOCTL_HAL_GET_BOOTLOADER_VERINFO	248
IOCTL_HAL_WARMBOOT	249
IOCTL_HAL_COLDBOOT	249
IOCTL_HAL_GET_RESET_INFO	250
IOCTL_HAL_GET_BOOT_DEVICE	251
IOCTL_HAL_REBOOT	252
IOCTL_PROCESSOR_INFORMATION	253
IOCTL_GET_CPU_ID	254
Network Selection APIs	255
Basic Connect/Disconnect Functions	257
RadioConnect()	257
RadioDisconnect()	258
RadioDisassociate()	259

Contents

Query Information Functions	260
GetAssociationStatus()	260
GetAuthenticationMode()	261
GetBSSID()	262
GetDiversity()	263
GetLinkSpeed()	264
GetMac()	265
GetNetworkMode()	266
GetNetworkType()	267
GetSSID()	268
GetPowerMode()	269
GetRSSI()	270
GetTXPower()	271
GetWepStatus()	272
GetRadioIpAddress()	273
GetCCXStatus()	274
Set Information Functions	275
AddWep()	275
EnableWep()	276
EncryptionStatus()	277
SetAuthenticationMode()	278
SetChannel()	279
SetNetworkMode()	280
SetPowerMode()	281
SetSSID()	282
SetCCXStatus()	283
SetMixedCellMode()	284
RemoveWep()	285
Helper Functions	286
ConfigureProfile()	286
EnableZeroConfig()	287
isZeroConfigEnabled()	288
isOrinoco()	289
isSupplicantRunning()	290
StartScanList()	291
StartSupplicant()	292
StopSupplicant()	293
isDHCPEnabled()	294
RenewDHCP()	295
GetCurrentDriverName()	296
ResetRadioToSystemSave()	297
EnableSuppLogging()	298
SwitchPacketDriver()	299
Deprecated Functions	300
Notifications	301
NLEDGetDeviceInfo	302
NLEDSetDevice	302

Reboot Functions 303
 IOCTL_HAL_REBOOT 303
 IOCTL_HAL_COLDBOOT 303
 IOCTL_HAL_WARMBOOT 303

Remapping the Keypad 304
 Unshifted Plane 304
 Gold Plane 304
 Alpha (Blue) Plane 305
 Key Values 305
 Numeric Keypad 305
 Alphanumeric Keypad 305
 How Key Values Are Stored in Registry 306
 Change Notification 306
 Advanced Keypad Remapping 306
 Scan Codes 307
 Numeric Keypad 307
 Alphanumeric Keypad 308
 Sample View of Registry Keys 310

A Configurable Settings 311

Configuration Parameters 312
 Changing a Parameter Setting 312
 About Configuration Parameters 313

Data Collection Control Panel Applet 314
 Symbologies 315
 Code 39 316
 Standard 2 of 5 317
 Codabar 318
 UPC/EAN 319
 Code 93 320
 Code 128 321
 Plessey 324
 MSI 325
 PDF417 326
 Interleaved 2 of 5 329
 Matrix 2 of 5 330
 Telepen 331
 Code 11 332
 QR Code 333
 Data Matrix 334
 MaxiCode 335
 Symbology Options 336
 Symbology ID 336
 Prefix 342
 Suffix 343

Contents

Beeper/LED	344
Beeper	345
Beeper Volume	346
Beeper Frequency	347
Good Read Beeps	348
Good Read Beep Duration	349
Imager	350
Aimer LED Duration	350
Sticky Aimer Duration	351
Image Dimension	352
Lighting Mode	353
1D OmniDir Decode Enable	354
Virtual Wedge	355
Virtual Wedge	355
Preamble	356
Postamble	358
Grid	360
Code Page	361
Intermec Settings Control Panel Applet	362
SNMP Control Panel Applet	363
Security	364
Read Only Community	364
Read/Write Community	365
Read Encryption	366
Write Encryption	367
Encryption Key	368
Traps	369
Authentication	369
Threshold	370
Identification	371
Contact	371
Name	372
Location	373
Unit Information Control Panel Applet	374
Versions	375
Battery Status	376
CAB Files	377
Utilities Control Panel Applet	379
Dock Switch	380
Registry Save	381
Wakeup Mask	382
App Launch	383

Wireless Network Control Panel Applet	385
About the Wireless Network	385
Terminology	385
Configuring Your Wireless Network	387
Basic	388
Security	389
Advanced	407
Other Configurable Parameters	408
Audio Volume	408
Automatic Shutoff	408
Backlight Timeout	409
Date/Time	409
Key Clicks	409
Using Reader Commands	410
Change Configuration	410
Set Time and Date	411
Configuration Bar Codes	412
Audio Volume	412
Automatic Shutoff	413
Backlight Timeout	413
Key Clicks	414
Virtual Wedge Grid, Preamble, Postamble	415
Grid	415
Preamble	415
Postamble	415
B Bar Code Symbolologies	417
Codabar	418
Code 11	418
Code 39	418
Encoded Code 39 (Concatenation)	419
Encoded Code 39 (Full ASCII)	419
Code 93	419
Code 128	420
Data Matrix	421
EAN (European Article Numbering)	421

Contents

I 2 of 5 (Interleaved)	422
Matrix 2 of 5	422
MaxiCode	422
PDF417	422
Micro PDF417	423
Plessey	423
MSI Code (Variant of Plessey)	424
QR Code (Quick Response Code)	424
S 2 of 5 (Standard 2 of 5)	424
Telepen	425
UPC (Universal Product Code)	425

Index

Classes and Functions	428
General Index	430
Files Index	449

Before You Begin

This section provides you with safety information, technical support information, and sources for additional product information.

Safety Summary

Your safety is extremely important. Read and follow all warnings and cautions in this document before handling and operating Intermec equipment. You can be seriously injured, and equipment and data can be damaged if you do not follow the safety warnings and cautions.

Do not repair or adjust alone

Do not repair or adjust energized equipment alone under any circumstances. Someone capable of providing first aid must always be present for your safety.

First aid

Always obtain first aid or medical attention immediately after an injury. Never neglect an injury, no matter how slight it seems.

Resuscitation

Begin resuscitation immediately if someone is injured and stops breathing. Any delay could result in death. To work on or near high voltage, you should be familiar with approved industrial first aid methods.

Energized equipment

Never work on energized equipment unless authorized by a responsible authority. Energized electrical equipment is dangerous. Electrical shock from energized equipment can cause death. If you must perform authorized emergency work on energized equipment, be sure that you comply strictly with approved safety regulations.

Safety Icons

This section explains how to identify and understand dangers, warnings, cautions, and notes that are in this manual. You may also see icons that tell you when to follow ESD procedures and when to take special precautions for handling optical parts.



A warning alerts you of an operating procedure, practice, condition, or statement that must be strictly observed to avoid death or serious injury to the persons working on the equipment.

Avertissement: Un avertissement vous avertit d'une procédure de fonctionnement, d'une méthode, d'un état ou d'un rapport qui doit être strictement respecté pour éviter l'occurrence de mort ou de blessures graves aux personnes manipulant l'équipement.



A caution alerts you to an operating procedure, practice, condition, or statement that must be strictly observed to prevent equipment damage or destruction, or corruption or loss of data.

Attention: Une précaution vous avertit d'une procédure de fonctionnement, d'une méthode, d'un état ou d'un rapport qui doit être strictement respecté pour empêcher l'endommagement ou la destruction de l'équipement, ou l'altération ou la perte de données.



Note: Notes either provide extra information about a topic or contain special instructions for handling a particular condition or set of circumstances.

Global Services and Support

Warranty Information

To understand the warranty for your Intermec product, visit the Intermec web site at <http://www.intermec.com> and click **Service & Support**. The Intermec Global Sales & Service page appears. From the **Service & Support** menu, move your pointer over **Support**, and then click **Warranty**.

Disclaimer of warranties: The sample code included in this document is presented for reference only. The code does not necessarily represent complete, tested programs. The code is provided “as is with all faults.” All warranties are expressly disclaimed, including the implied warranties of merchantability and fitness for a particular purpose.

Web Support

Visit the Intermec web site at <http://www.intermec.com> to download our current manuals in PDF format. To order printed versions of the Intermec manuals, contact your local Intermec representative or distributor.

Visit the Intermec technical knowledge base (Knowledge Central) at <http://intermec.custhelp.com> to review technical information or to request technical support for your Intermec product.

Telephone Support

These services are available from Intermec Technologies Corporation.

Service	Description	In the U.S.A. and Canada call 1-800-755-5505 and choose this option
Factory Repair and On-site Repair	Request a return authorization number for authorized service center repair, or request an on-site repair technician.	1
Technical Support	Get technical support on your Intermec product.	2
Service Contract Status	Inquire about an existing contract, renew a contract, or ask invoicing questions.	3
Schedule Site Surveys or Installations	Schedule a site survey, or request a product or system installation.	4
Ordering Products	Talk to sales administration, place an order, or check the status of your order.	5

Outside the U.S.A. and Canada, contact your local Intermec representative. To search for your local representative, from the Intermec web site, click **Contact**.

Who Should Read this Manual?

This manual provides you with information about the features of the 700 Series Color Mobile Computer and how to configure, troubleshoot, and support it. You must be familiar with your host PC, your network, and your other Intermec equipment.

Related Documents

This table contains a list of related Intermec documents and their part numbers.

Document Title	Part Number
<i>700 Series Color Mobile Computer Quick Start Guide</i>	962-054-053
<i>730 Mobile Computer Quick Start Guide</i>	962-054-068
<i>Intermec Computer Command Reference Manual</i>	073529
Intermec Developer's Library CD	235-114-001 (<i>Kit</i>)
700C Recovery CD Windows Mobile 2003 Edition <i>English</i>	235-110-001 (<i>Kit</i>)

The Intermec web site at <http://www.intermec.com> contains many of our documents that you can download in PDF format.

To order printed versions of the Intermec manuals, contact your local Intermec representative or distributor.



1 Introduction

This chapter introduces the 700 Series Color Mobile Computer, developed by Intermec Technologies Corporation to enhance wireless connectivity needs.

This chapter contains hardware and software configuration information to assist you in making the most out of your 700 Color Computer. The components include:

- Ambient light sensors (*next page*)
- Audio system (*page 3*)
- Battery (*page 5*)
- Beeper (*page 7*)
- Keypad (*page 11*)
- Modem support (*page 16*)
- PSM build version (*page 16*)
- Software build version (*page 17*)
- Storage media (*page 18*)
- Vibrator (*page 19*)
- Wireless network support (*page 20*)



Note: Desktop icons and control panel applet icons are shown to the left.

Ambient Light Sensor



Note: This information does *not* apply to the 730 Computer.

The ambient light sensor turns on the display lighting when conditions warrant but automatically turns off again as surrounding light increases. This conserves your 700 Color battery power.

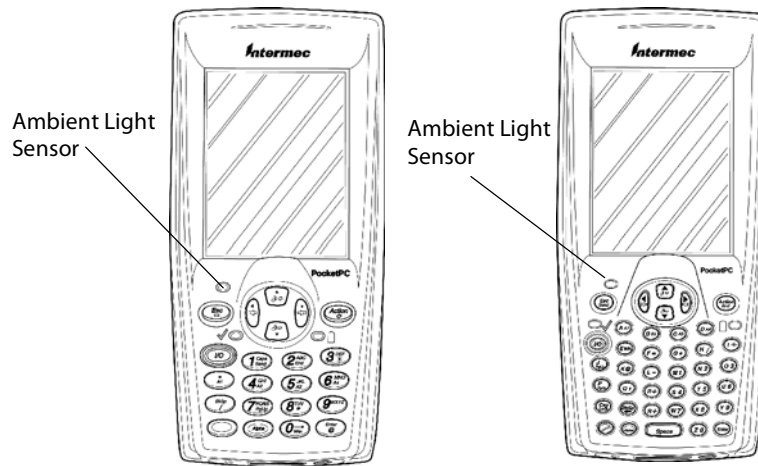

This illustration shows the 700 Color Computer with a numeric keypad (left) and an alphanumeric keypad (right).



Backlight

To adjust the ambient light sensor, tap **Start > Settings > the System tab > the Backlight icon > the Both Power tab**. Make your selections, then tap **ok** to exit this applet.

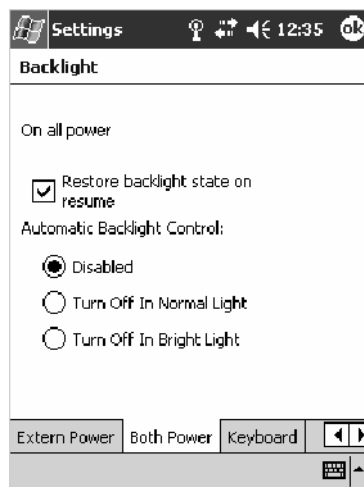

Audio System

The audio system consists of the speaker, internal microphone, and the external headset jack.

Speaker

A speaker capable of variable volume levels is located on the back of the computer. This speaker has a transducer volume of 85 dB min at 10 CM and a frequency range of 1–8 KHz.

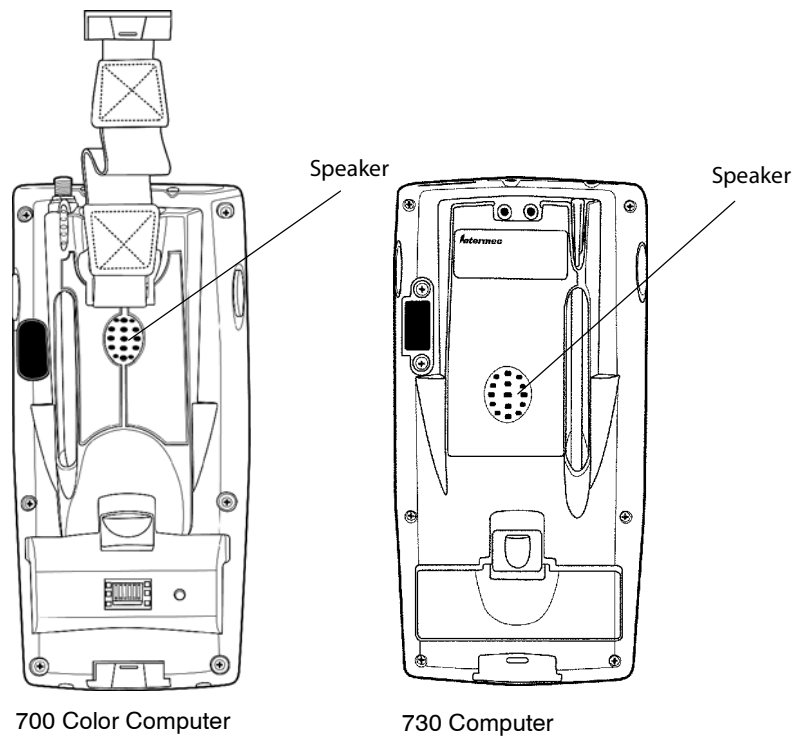

This illustration shows the back of the 700 Color Computer on the left and of the 730 Computer on the right.

Microphone

The built-in microphone is located on the bottom of the unit next to the Hirose docking connector.

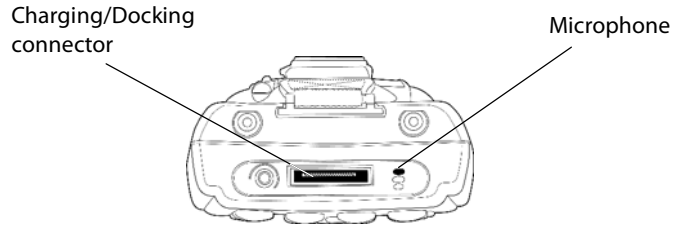

This is the bottom of the 700 Color Computer. Note that the keypad is to the bottom in this illustration.

External Headset Jack

The external headset jack connects a mobile phone style headset to your mobile computer for use in noisy environments. The jack is a 2.5 mm, three-conductor jack, with autosensing of the headset jack insertion which disables the internal speaker and microphone. The external headset jack is located on the bottom of the mobile computer next to the Hirose docking connector.

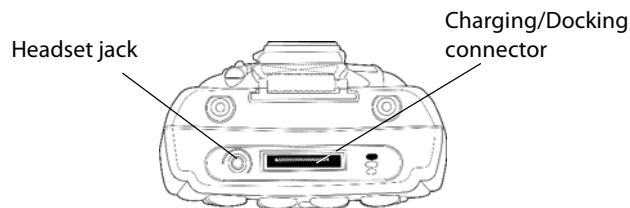

This is the bottom of the 700 Color Computer. Note that the keypad is to the bottom in this illustration.

Battery

The 700 Series Computer comes with a 14.4 Watt-hour, 7.2V, replaceable Lithium-Ion (LiIon) battery.

The 730 Computer comes with a 8.8 Watt-hour, 3.7V, replaceable LiIon battery.



Power

To view the status of this battery from the 700 Series Computer, tap **Start** > **Settings** > the **System** tab > the **Power** icon > the **Power** tab to view the current status of both the main battery and the backup battery. Tap **ok** to exit this information.

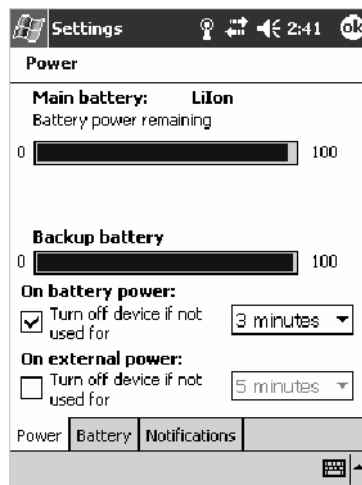

For Units With PSM Builds Older than 3.00



Unit Information

You can also view the battery status for the 700 Series Computer by accessing the **Unit Information** control panel applet. Tap **Start** > **Settings** > the **System** tab > the **Unit Information** icon > the **Battery Status** tab to view the current status. Tap **ok** to exit this information.

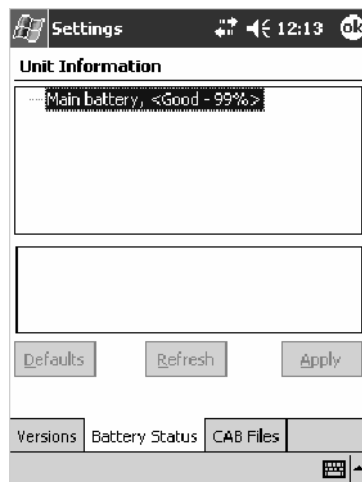

If your computer shuts down because of low battery conditions, your computer does not operate. This is done to ensure that data is protected. Although the battery does protect the data against loss for several hours, you should connect your computer to a power source when you first detect a low battery condition.

Your computer contains an internal super capacitor, a temporary power storage device, that protects data for up to ten minutes. This is to give you time to replace the main battery pack before that data is lost. *Be sure to put the computer in a suspend mode before doing so.*

If you have at least one device in your 700 Series Computer (radio, scanner, imager, or Ethernet), the battery power fail level is set so that after the system shuts down in a low battery condition, there is still sufficient charge to allow the unit to remain configured, keep proper time, and maintain DRAM (Dynamic Random Access Memory) for at least 23 to 32 hours at room temperature *if* the main battery remains in the mobile computer. The configuration and time are lost if:

- The battery discharges beyond this level.
- The battery is removed when the computer is *not in suspend mode*.
- A cold reset is performed on the computer.



You can modify RAM maintenance in a limited way. On the 700 Color Computer, tap **Start** > **Settings** > the **System** tab > the **Power** icon > the **Battery** tab. Drag the slider bar to the right to change the suspend voltage to favor suspend time over rundown time, then click **ok** to exit.

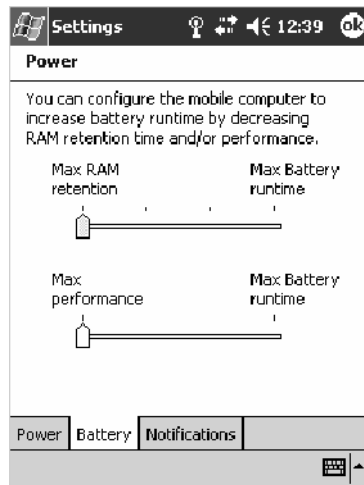

Beeper



Note: Each time the 700 Computer is cold-booted, all default settings are restored.

If the beeper is disabled on your 700 Color Computer, do the following instructions to enable the beeper. If you are not able to enable the beeper, then contact Customer Support.

For information about setting volume levels for screen taps, ActiveSync alert noises, etc., tap **Start** > **Help** > **Pocket PC Basics**, then select **Notifications**.

Enable the Beeper



Do the following to enable the beeper:

- 1 Tap **Start** > **Settings** > the **Personal** tab > **Sounds & Notifications** > the **Volume** tab.
- 2 Drag the **System volume** slider bar to the right off the “Silent” position.
- 3 Tap **ok** to exit this applet.

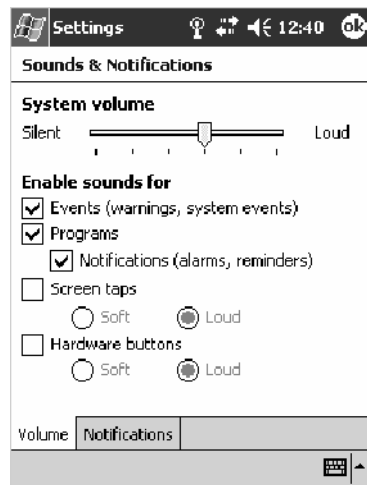

Disable the Scanner Mute



Note: This information does *not* apply to the 730 Computer.

Do the following to disable the mute feature on the scanner.



Audio

- 1 Tap **Start** > **Settings** > the **System** tab > the **Audio** icon, then select **User defined audio settings**.



- 2 Tap the **Input Mixing** tab, then clear the **SCAN Mute** box.

- 3 Drag its slider bar (note the greyed slider bar) to the appropriate level of loudest, with the left side being the most quiet and the right side being the most loud. Tap **ok** to exit this applet.

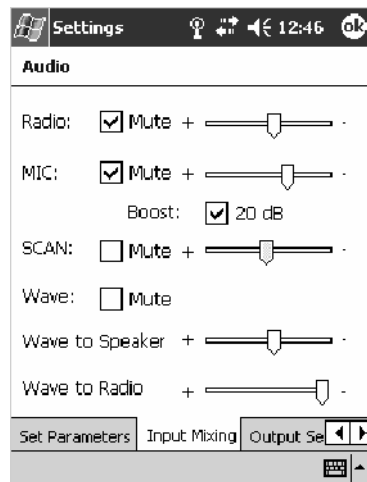

Select a Beeper Volume



Note: The 730 Computer does *not* support the laser scanner.

To determine your PSM Build version, tap **Start > Programs > File Explorer > the PSMinfo** text file.



For Units With PSM Builds Older than 3.00

Do the following to select a beeper volume. 700 Computers built with a laser scanner have three options: Off, High, or Medium. 700 Computers built with an imager have just two: Beeper or Vibrate. 730 Computers have just the **Beeper** option. See Appendix A, “*Configurable Settings*,” for more information about the **Beeper Volume** or **Beeper** option.

- 1 Tap **Start > Settings > the System tab > the Data Collection** icon to access its control panel applet.
- 2 Use the right and left arrows to scroll to the **Beeper/LED** tab, then tap this tab.
- 3 *For units with laser scanners:*
Tap **Beeper Volume**, select an option, then tap **Apply** to change the setting.

For units with imagers:

Select either option, then tap **Apply** to change the setting. *For 730 Computers, the Vibrate option is not supported.*

- 4 Tap **ok** to confirm this change, then tap **ok** to exit the Data Collection control panel applet.

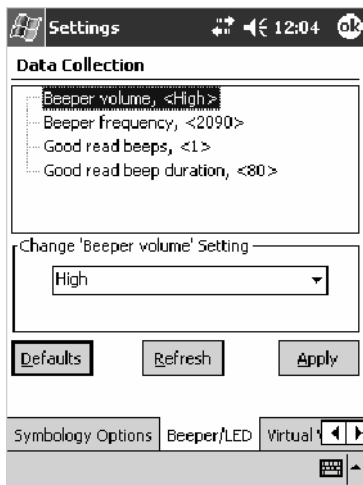

700 Color with Laser Scanner Screen

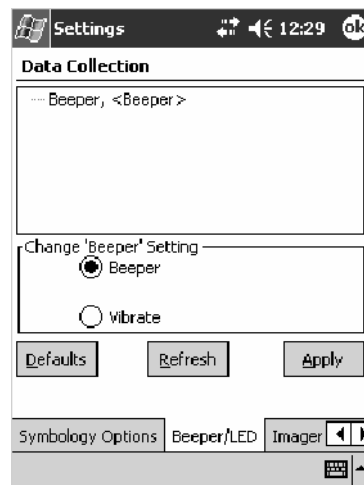

700 Color with Imager Screen



730 Screen

For Units With PSM Build 3.00 or Newer



Do the following to select a beeper volume for the 700 Color Computer. Tap **Start** > **Settings** > the **System** tab > the **Intermec Settings** icon. Tap the **700 Settings** folder twice, tap (+) to expand the **Beeper** folder, then tap (+) to expand the **Volume** option. Select an item, then tap (+) to close this option.

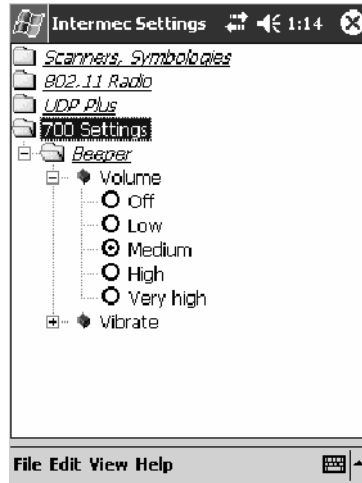

Note: Information about the settings you can configure with the Intermec Settings control panel applet is described in the *Intermec Computer Command Reference Manual* (P/N: 073529). The online manual is available from the Intermec web site at www.intermec.com.

Disable the Beeper



Do the following to disable the beeper:

- 1 Tap **Start** > **Settings** > the **Personal** tab > **Sounds & Notification** > the **Volume** tab.
- 2 Drag the **System volume** slider completely to the left to “Silent.”
- 3 Tap **ok** to exit this applet.

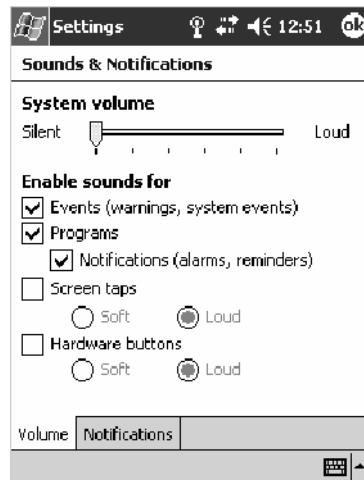

Keypad

Instructions for the keypad include the backlight and keypress sequences.

Backlight for Keypad



Note: This information does *not* apply to the 730 Computer.



Backlight

You can configure your keypad to turn on a backlight to assist you when you are working in low lighting. To adjust the backlight for the keypad, tap **Start** > **Settings** > the **System** tab > **Backlight**. Use the left/right scroll arrows to move to and tap the **Keyboard** tab. Make your selection, then tap **ok** to exit this applet.

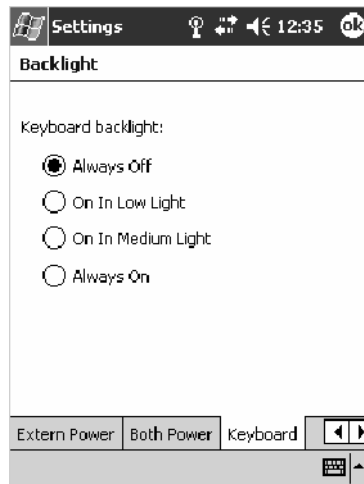

Key Sequences

Use the following key sequences to enter characters into your 700 Color Computer using either a numeric keypad or an alphanumeric keypad.

[Gold] or [Gold/White] Plane Keys

The [Gold] ☉ plane key (numeric keypad) or the [Gold/White] ☉ plane key (alphanumeric keypad) provides you access to display controls, special characters, and Pocket PC options.

Press the [Gold] ☉ key or the [Gold/White] ☉ key for each gold plane key stroke you wish to make. For example to turn on the front light, press and hold the [Gold] ☉ key plus the $\text{3}^{\text{DEF}}_{*}$ key on the numeric keypad or press and hold the [Gold/White] ☉ key plus the 1^{*} key on the alphanumeric keypad. To turn the front light off, press the appropriate keys again.

Below and on the next page are the key sequences.

Numeric Keypad

The following table lists sequences that use the [Gold] ☉ plane key. See Chapter 2, “Windows Mobile 2003,” for information about the Pocket PC applications.































Press the Keys	To Do This
[Gold] ☉ $\text{3}^{\text{DEF}}_{*}$	Toggle the backlight on or off (also goes through backlight power levels if held down)
[Gold] ☉ 1^{*}	Access the Pocket PC Record application (<i>see Note</i>).
[Gold] ☉ $\text{4}^{\text{OH}}_{\text{AD}}$	Access the Pocket PC Calendar application (<i>see Note</i>).
[Gold] ☉ $\text{5}^{\text{JKL}}_{\text{AD}}$	Access the Pocket PC Contacts application (<i>see Note</i>).
[Gold] ☉ $\text{6}^{\text{MNO}}_{\text{AD}}$	Access the Pocket PC Tasks application (<i>see Note</i>).
[Gold] ☉ $\text{7}^{\text{PGDN}}_{\text{PgUp}}$	Move up one page.
[Gold] ☉ 8^{TUV}	Enter an asterisk (*).
[Gold] ☉ 9^{WXYZ}	Move down one page.
[Gold] ☉ 0^{Win}	Access the Pocket PC Start menu.
[Gold] ☉ $\text{Enter}_{@}$	Enter an at symbol (@).
[Gold] ☉ $\text{BkSp}_{/}$	Enter a backslash (/).
[Gold] ☉ Esc_{-}	Enter a minus sign (-).
[Gold] ☉ Action_{+}	Enter a plus sign (+).
[Gold] ☉ →	Tab to the right.
[Gold] ☉ ←	Tab to the left.
<i>Note: Pocket PC applications are accessible only if configured to do so in the App Launch portion of the Utilities control panel applet. See page 379 for more information.</i>	



Alphanumeric Keypad

Note: This information does *not* apply to the 730 Computer.

The following table lists sequences that use the [Gold/White]  plane key. See Chapter 2, “*Windows Mobile 2003*,” for information about the Pocket PC applications.



Press the Keys	To Do This
[Gold/White]  	Toggle the backlight on or off (also goes through backlight power levels if held down)
[Gold/White]  	Access the Pocket PC Record application (<i>see Note</i>).
[Gold/White]  	Access the Pocket PC Calendar application (<i>see Note</i>).
[Gold/White]  	Access the Pocket PC Contacts application (<i>see Note</i>).
[Gold/White]  	Access the Pocket PC Tasks application (<i>see Note</i>).
[Gold/White]  	Move up one page.
[Gold/White]  	Enter an asterisk (*).
[Gold/White]  	Move down one page.
[Gold/White]  	Access the Pocket PC Start menu.
[Gold/White]  	Enter an at symbol (@).
[Gold/White]  	Enter a backslash (/).
[Gold/White]  	Enter a minus sign (-).
[Gold/White]  	Enter a plus sign (+).
[Gold/White]  	Tab to the right.
[Gold/White]  	Tab to the left.





Note: Pocket PC applications are accessible only if configured to do so in the App Launch portion of the Utilities control panel applet. See page 379 for more information.



Alpha (Blue) Plane Keys

The alphabet can be entered with either the numeric keypad or the alpha-numeric keypad. Below and on the next page are the key sequences.





























































































































































































Numeric Keypad

When you press , the Scanning/Alpha LED () shows 'red' for the Alpha mode. The keypad stays in Alpha mode until you press .



To type a lowercase 'c,' press     (the [2] key three times). To type a letter on the same key as the last letter entered, wait two seconds, then enter the correct series of keystrokes to create the next letter.





While you are in the Alpha mode and you press  to initiate the CAPS mode, you will render a CAPS LOCK until you press  again. Once you are in CAPS mode, you stay in CAPS until it is pressed again.

Press  to enter a space.



































































































































To Enter	Press the Keys	To Enter	Press the Keys
a	 	A	  
b	  	B	   
c	   	C	    
d	 	D	  
e	  	E	   
f	   	F	    
g	 	G	  
h	  	H	   
i	   	I	    
j	 	J	  
k	  	K	   
l	   	L	    
m	 	M	  
n	  	N	   
o	   	O	    
p	 	P	  
q	  	Q	   
r	   	R	    
s	    	S	     
t	 	T	  
u	  	U	   
v	   	V	    
w	 	W	  
x	  	X	   
y	   	Y	    
z	    	Z	     

Alphanumeric Keypad

When you press , the Scanning/Alpha LED () lights 'red' to indicate Alpha mode. The keypad stays in the Alpha mode until you press  again.

If you want to type a lowercase 'c,' press [**Gold/White**]  . If you want an uppercase "C," press and hold the , then press .

Press  to enter a space.

To Enter	Press the Keys	To Enter	Press the Keys
a	 	A	  
b	 	B	  
c	 	C	  
d	 	D	  
e	 	E	  
f	 	F	  
g	 	G	  
h	 	H	  
i	 	I	  
j	 	J	  
k	 	K	  
l	 	L	  
m	 	M	  
n	 	N	  
o	 	O	  
p	 	P	  
q	 	Q	  
r	 	R	  
s	 	S	  
t	 	T	  
u	 	U	  
v	 	V	  
w	 	W	  
x	 	X	  
y	 	Y	  
z	 	Z	  

Modem Support

The 700 Series Computer has the following modem options:

- Modem dock that provides charging and includes a built-in modem and a serial port between which an application can switch.
- Snap-on modem, a stand-alone product, that attaches to the bottom of your 700 Color Computer. Note that you cannot place this modem in a dock, printer, or other devices. Contact your Intermec representative for more information.

PSM Build Version



File Explorer

The Persistent Storage Manager (PSM) is an area of storage which is embedded in a section of the system's FLASH memory. This storage area is *not* erased during a cold-boot. It may, however, be erased during the re-flashing process. In addition to storing applications and data files, you do have the option to store a persistent registry to the PSM region.

To determine what PSM Build is on your 700 Series Computer, tap **Start** > **Programs** > **File Explorer** > the **PSMinfo** text file. Take note of your information, then tap **ok** to exit.

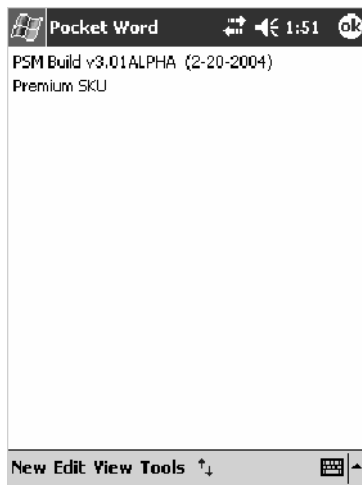

Software Build Version

To check to see if your 700 Series Computer has the latest software build, select **Start > Internet Explorer > the Intermec logo**.



The latest software build version is displayed beneath the **Version Information** title. This information would be useful should you need assistance.

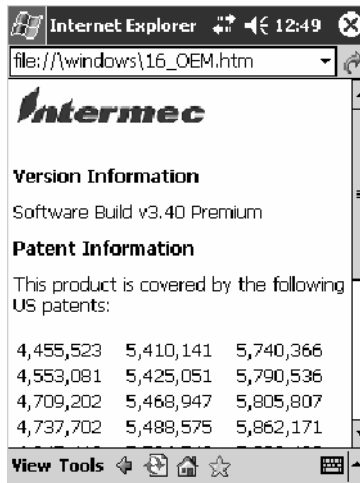

700 Color Screen

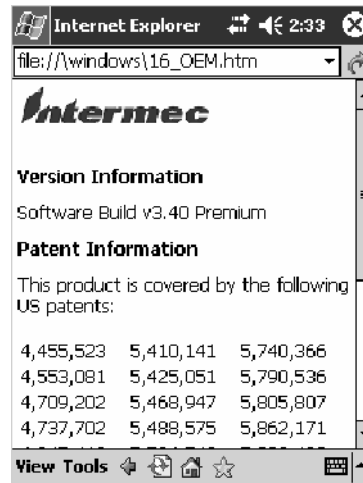

730 Screen



For Units With PSM Builds Older than 3.00

You can also view the latest software build by accessing the Unit Information control panel applet. Select **Start > Settings > the System tab > the Unit Information icon > the Versions tab** to view the current build.



700 Color Screen

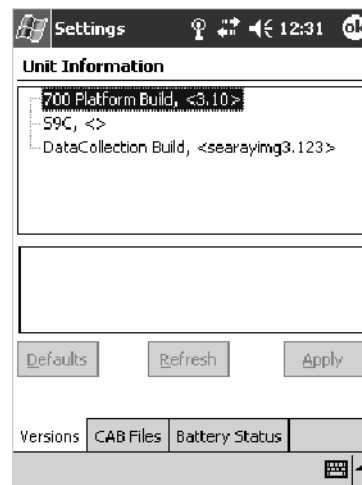

730 Screen

Storage Media



Note: MultiMediaCards (MMCs) are not supported in the 700 Series Computers.

The 700 Color Computer supports both CompactFlash and Secure Digital storage cards. To access either card slot, locate the access door at the top of the 700 Series Computer, remove its two screws, then remove the door. See the *700 Series Color Mobile Computer Quick Start Guide* (P/N: 962-054-053) for more information.

The 730 Mobile Computer only supports the Secure Digital storage card. The CompactFlash card slot is embedded in the 730 Computer and cannot be removed. To access the Secure Digital card slot, locate the access door at the top of the 730 Computer, remove its screws, then remove the door. See the *Model 730 Mobile Computer Quick Start Guide* (P/N: 962-054-068) for more information.

CompactFlash Cards

On 700 Color Computers, the CompactFlash card slot accepts either a storage card or the 802.11b radio, which is factory-installed and cannot be removed. The 730 Computer does not support CompactFlash storage cards.

Secure Digital Cards

The Secure Digital card slot accepts storage cards only.

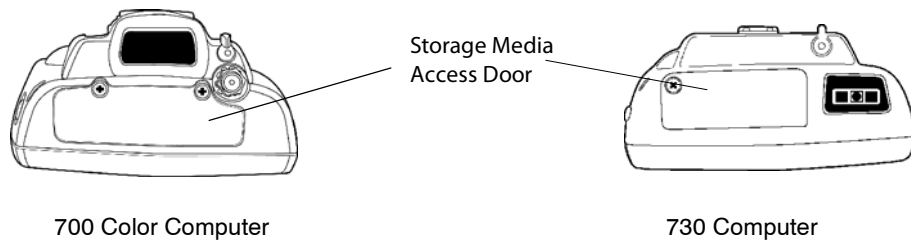

This illustration shows the top of the 700 Color Computer on the left and of the 730 Computer on the right. Note that the keypad is to the bottom.

Vibrator



Note: This information does *not* apply to the 730 Computer.

If your 700 Color Computer is built with an imager or scanner and the vibrator is disabled, do the following instructions to enable the vibrator. If you are not able to enable the vibrator, then contact Customer Support.

For information about setting volume levels for screen taps, ActiveSync alert noises, etc., tap **Start** > **Help** > **Pocket PC Basics**, then select **Notifications**.

See Chapter 7, “*Programming*,” to see how to programmatically control the vibrator. See Appendix A, “*Configurable Settings*,” for more information about the **Beeper Volume** option.



Note: Each time the 700 Computer is cold-booted, all default settings are restored.



For Units With PSM Builds Older than 3.00

- 1 Tap **Start** > **Settings** > the **System** tab > **Data Collection** to access its control panel applet.
- 2 Use the right and left arrows to scroll to the **Beeper/LED** tab, then tap this tab.
- 3 Tap **Beeper**, select the “Vibrate” option, then tap **Apply**.
- 4 Tap **ok** to confirm this change, then tap **ok** to exit the Data Collection control panel applet.





For Units With PSM Build 3.00 or Newer

Do the following to enable the vibrator for the 700 Color Computer. Tap **Start > Settings > the System tab > the Intermec Settings icon**. Tap the **700 Settings** folder twice, tap (+) to expand the **Beeper** folder, then tap (+) to expand the **Vibrate** option. Select an item, then tap (+) to close this option.

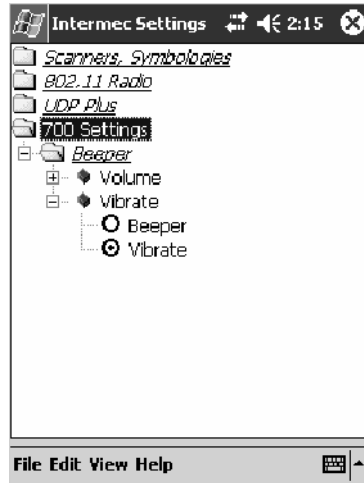

Note: Information about the settings you can configure with the Intermec Settings control panel applet is described in the *Intermec Computer Command Reference Manual*. The online manual is available from the Intermec web site at www.intermec.com

Wireless Network Support

Radios are installed at the factory and cannot be installed by a user. The 700 Color Computer must be serviced to install or replace radios. Contact your Intermec representative for more information. See Chapter 4, “*Network Support*” for information about supported radios.

Accessories

The following accessories are available for the 700 Series Computer. *Note that this is not a complete list.* Contact your Intermec representative for information about these and other accessories that are not in this list.

Accessory Descriptions	Intermec Part Number	700 Color	730 Computer
Single Dock Charger with Ethernet and Auxiliary Battery Charger	225-681-001		X **
Single Dock Charger with USB and Ethernet	225-683-001	X	X **
Quad Battery Charger	852-060-001 852-054-001	X	X
Single Battery Charger	852-060-002	X	
Multidock — Charge Only (<i>holds four 700 Computers</i>)	225-682-004	X	X
Multidock Charging with Ethernet support (<i>holds four units</i>)	225-682-003	X	
Modem Dock	225-683-002	X	X
Vehicle Dock	225-685-001	X	X
Vehicle Cradle	225-680-101	X	X
Snap-On Modem	225-687-001	X	
Long Range Tethered Scanning Adapter (3.3v to 5v)	225-686-002	X	
DEX Adapter	225-683-001	X	
Standard Scan Handle Option	714-525-001 714-502-001	X	X
Dockable Scan Handle	714-525-002	X	
Belt Clip	805-612-001	X	X
** No Ethernet Support			

What's New

The newest functionality is available in software build versions 3.10 or greater. These changes have occurred since the last release of this manual:

- Updated 802.11 Security Supplicant information in Chapter 4, “*Network Support*,” Chapter 7, “*Programming*,” and Appendix A, “*Configurable Settings*.”
- Incorporated information about the Intermec Settings control panel applet throughout the manual for PSM Builds 3.00 or newer.
- Added information about the PhoneUtility application to and revised information about Bluetooth in Chapter 4, “*Network Support*.”
- Added tethered scanner and internal scanner configuration and troubleshooting information to Chapter 6, “*Scanner Support*.”



2 Windows Mobile 2003

This chapter introduces Microsoft Windows Mobile 2003 for Pocket PC. While using your 700 Color Computer, keep these key points in mind:

- Tap **Start** on the navigation bar, located at the top of the screen, to quickly move to programs, files, and settings. Use the command bar at the bottom of the screen to perform tasks in programs. The command bar includes menus, buttons, and the onscreen keyboard.
- Tap and hold an item to see a pop-up menu containing a list of actions you can perform. Pop-up menus give you quick and easy access to the most common actions.



Help

Below is a list of Windows Mobile 2003 components described in this chapter. Additional information on these and other Windows Mobile components can be found on your 700 Color Computer by tapping **Start > Help**.

Windows Mobile 2003 Components
Microsoft ActiveSync Client (<i>page 44</i>)
Microsoft Pocket Outlook (<i>page 46</i>)
Pocket Word (<i>page 78</i>)
Pocket Excel (<i>page 82</i>)
MSN Messenger (<i>page 84</i>)
Windows Media Player for Pocket PC (<i>page 89</i>)
Microsoft Reader (<i>page 90</i>)
Pocket Internet Explorer (<i>page 94</i>)

Software Builds

Do the following to determine which Intermec build of Windows Mobile 2003 is on your unit.



- 1 Select **Start > Internet Explorer > the Intermec logo**.



- 2 Note the “Software Build” information displayed beneath the **Version Information** title.

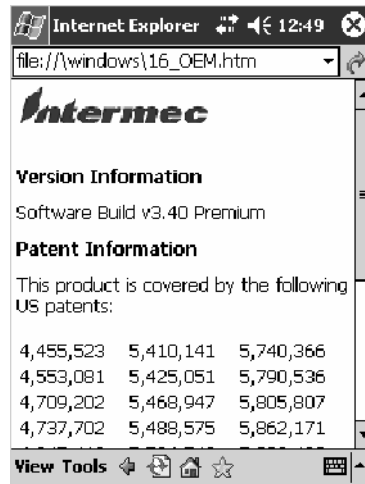

700 Color Screen

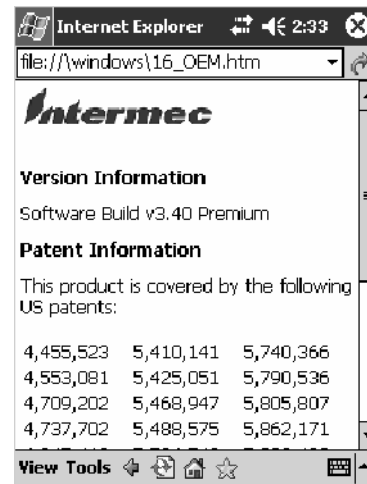

730 Screen

- 3 Tap the **Close** icon in the top right corner to exit the Internet Explorer.

Where to Find Information

This chapter describes your 700 Color Computer hardware, provides an overview of the programs on your 700 Color Computer, and explains how to connect your 700 Color Computer to a desktop, a network, or the Internet. For instructions on setting up your 700 Color Computer and installing ActiveSync, see the Quick Start Guide. The following is a guide to more information to assist you use your 700 Color Computer.

For information on:	See this source:
Programs on your mobile computer.	This chapter and mobile computer Help. To view Help, tap Start > Help .
Additional programs that can be installed on the mobile computer.	The <i>Windows Mobile Companion CD</i> .
Connecting to and synchronizing with a desktop.	The Quick Start Guide or <i>AutoSync Help</i> on your desktop. To view Help, click Help > Microsoft ActiveSync Help .
Last-minute updates and detailed technical information.	The Read Me files, located in the Microsoft ActiveSync folder on the desktop and on the <i>Windows Mobile Companion CD</i> .
Up-to-date information on your Windows Mobile.	http://www.microsoft.com/windowsmobile/resources/communities/default.aspx

Windows Mobile and many of the technologies supported by the 700 Color Computer are not from Intermec Technologies. Many of the utilities and features on a Windows Mobile device come directly from Microsoft without any modification from Intermec Technologies. There may be certain Microsoft-specific issues that Intermec Technologies would not be able to support, so contact our front-line support personnel to determine the best source of assistance.

Use these URLs for additional information about Microsoft Windows Mobile (Pocket PC):

- <http://msdn.microsoft.com/support/>
- <http://support.microsoft.com/>
- <news://news.microsoft.com> (*a free support option*)

Basic Skills

Learning to use your 700 Color Computer is easy. This section describes the basic concepts of using and customizing your 700 Color Computer.

Today Screen



When you turn on your 700 Color Computer for the first time each day (or after four hours of inactivity), you see the **Today** screen. You can also display it by tapping the **Start** flag (shown left) and then **Today**. On the Today screen, you can see important information for the day.

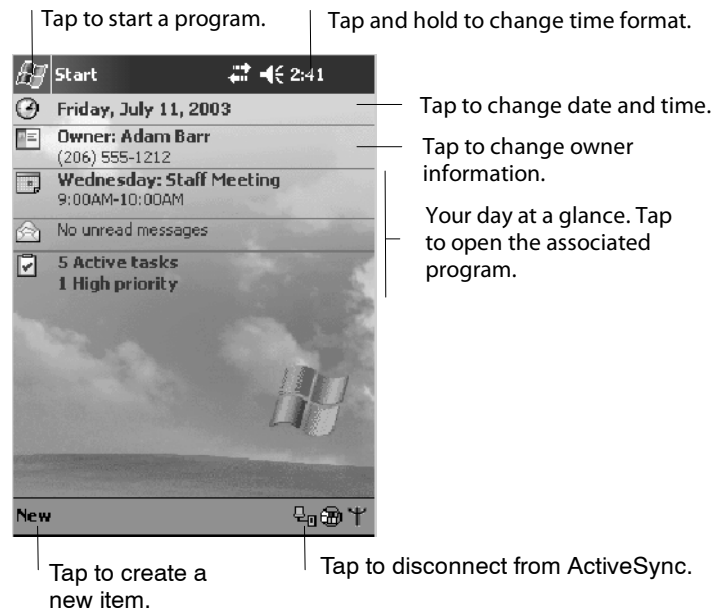

Today

To customize what is displayed on the Today screen, including the background image, tap **Start > Settings > the Personal tab > Today**.

Status icons display information such as low batteries or when the 700 Color Computer is connected to a desktop or to the Internet. You can tap an icon to open the associated setting or program.

Programs

You can switch from one program to another by selecting it from the **Start** menu. (You can customize which programs you see on this menu. For information, see “*Adjusting Settings*” on page 41.) To access some programs, tap **Start > Programs**, and then the program name.

You can also switch to some programs by pressing a program button. Your 700 Color Computer has one or more program buttons located on the front or side of the computer. The icons on the buttons identify the programs to which they switch.



Note: Some programs have abbreviated labels for check boxes and drop-down menus. To see the full spelling of an abbreviated label, tap and hold the stylus on the label. Drag the stylus off the label so that the command is not carried out.

The following is a partial list of programs that are on your 700 Color Computer. Look on the *Windows Mobile Companion CD* for additional programs that you can install onto your 700 Color Computer.

ActiveSync

Synchronize information between your 700 Color Computer and desktop.

Calendar

Keep track of your appointments and create meeting requests.

Contacts

Keep track of your friends and colleagues.

Inbox

Send and receive e-mail messages.

Internet Explorer

Browse Web and WAP (Wireless Application Protocol) sites, and download new programs and files from the Internet.

Notes

Create handwritten or typed notes, drawings, and recordings.

Tasks

Keep track of your tasks.

Windows Media

Play digital audio and video files that are stored on your 700 Series Computer or on a network.

Navigation Bar and Command Bar

The navigation bar is located at the top of the screen. It displays the active program and current time, and allows you to switch to programs and close screens.

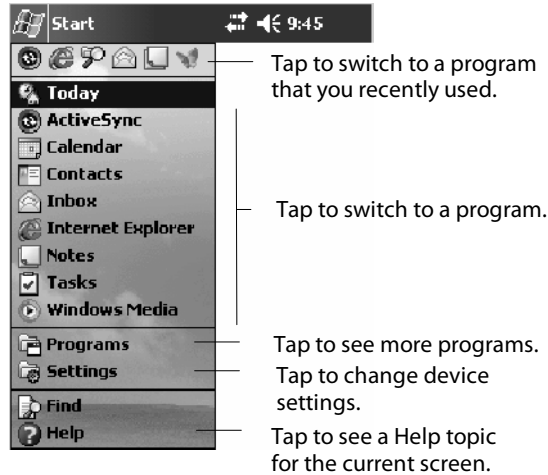

Use the command bar at the bottom of the screen to perform tasks in programs. The command bar includes menu names, buttons, and the **Input Panel** button. To create a new item in the current program, tap **New**. To see the name of a button, tap and hold the stylus on the button. Drag the stylus off the button so that the command is not carried out.

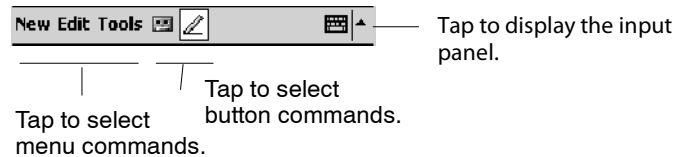

Pop-up Menus

Use pop-up menus to quickly perform an action on an item. For example, you can use a pop-up menu to delete or make a copy of an item. To access a pop-up menu, tap and hold the item on which you want to perform the action. When the menu appears, tap the action you want to perform, or tap anywhere outside the menu to close the menu without performing the action.

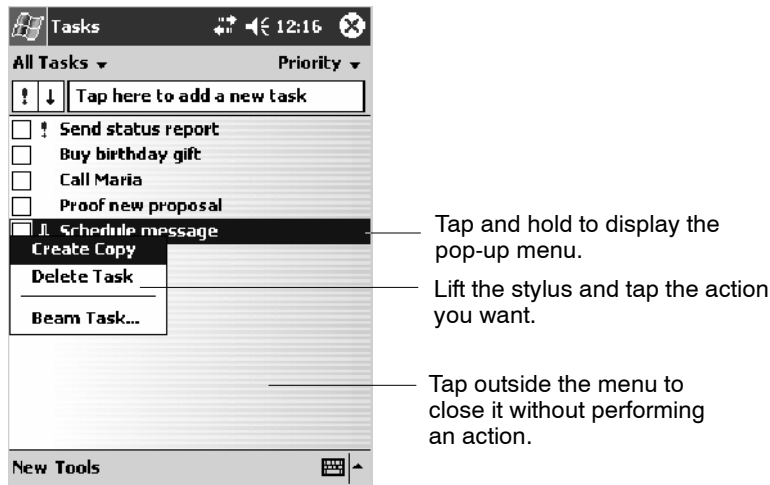

Notifications

When you have something to do, your device notifies you in a variety of ways. For example, if you have set up an appointment in Calendar, an e-mail message arrives, or a friend sends you an instant message, you are notified in any of the following ways:

- A message box appears on the screen.
- A sound, which you can specify, is played.
- A light flashes on your 700 Color Computer.
- The 700 Color Computer vibrates.

You can choose notification types.

Entering Information

You can enter information on your 700 Color Computer in several ways, depending on the type of device you have and the program you are using:

- **Synchronizing**
Using Microsoft ActiveSync, synchronize or copy information between your desktop and 700 Color Computer. For more information on ActiveSync, see *ActiveSync Help* on your desktop.
- **Typing**
Using the input panel, enter typed text into the 700 Color Computer. You can do this by tapping keys on the onscreen keyboard or by using handwriting recognition software.
- **Writing**
Using the stylus, write directly on the screen.
- **Drawing**
Using the stylus, draw directly on the screen.
- **Recording**
Create a stand-alone recording or embed a recording into a document or note.

Use the input panel to enter information in any program on your 700 Color Computer. You can either type using the onscreen keyboard or write using **Block Recognizer**, **Letter Recognizer**, or **Transcriber**. In either case, the characters appear as typed text on the screen.

To show or hide the input panel, tap the **Input Panel** button. Tap the arrow next to the **Input Panel** button to see your choices.

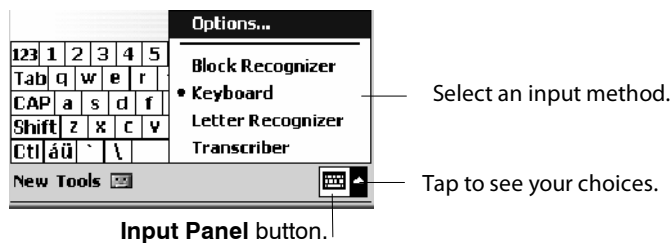

When you use the input panel, your 700 Color Computer anticipates the word you are typing or writing and displays it above the input panel. When you tap the displayed word, it is inserted into your text at the insertion point. The more you use your 700 Color Computer, the more words it learns to anticipate.

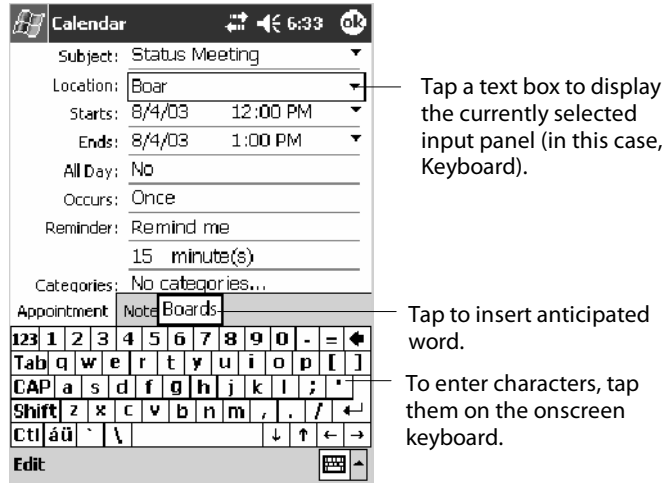

Input

To change word suggestion options, such as the number of words suggested at one time, tap **Start** > **Settings** > the **Personal** tab > **Input** > the **Word Completion** tab.

Typing With the Onscreen Keyboard

Tap the  arrow, then tap **Keyboard**. On the soft keyboard that is displayed, tap the keys with your stylus.

- To type lowercase letters, tap the keys with the stylus.
- To type a single uppercase letter or symbol, tap the **Shift** key. To tap multiple uppercase letters or symbols, tap the **CAP** key.
- To convert a letter to uppercase, tap and hold the stylus on the letter and drag up.
- To add a space, drag the stylus to the right across at least two keys.
- To backspace one character, drag the stylus to the left across at least two keys.
- To insert a carriage return, tap and hold the stylus anywhere on the keyboard and drag down.

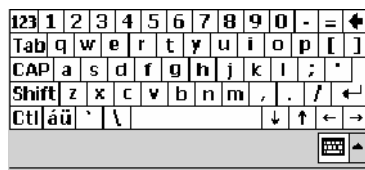



Note: If you want to use larger keys, tap the  arrow, tap **Options**, select “Keyboard” from the **Input method** drop-down list, then select **Large keys**.

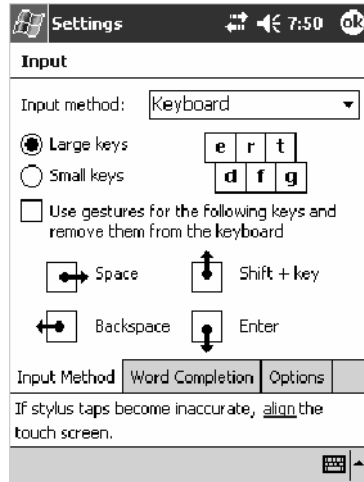

Using Block Recognizer

Character recognition software gives you a fast and easy method for entering information in any program on your 700 Color Computer. Letters, numbers, and punctuation you write are translated into typed text.

Tap the  arrow, then tap **Block Recognizer**. Write a letter in the box. When you write a letter, it is converted to typed text that appears on the screen.

For specific instructions on using Block Recognizer, with Block Recognizer open, tap the question mark next to the writing area.

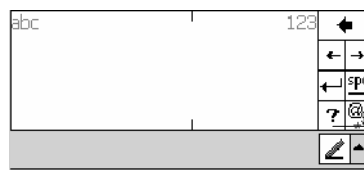

Tap for assistance.

Using Letter Recognizer

With Letter Recognizer, you can write letters using the stylus just as you would on paper.

Tap the  arrow, then tap **Letter Recognizer**. Write a letter in the box. When you write a letter, it is converted to typed text that appears on the screen. For specific instructions on using Letter Recognizer, with Letter Recognizer open, tap the question mark next to the writing area.

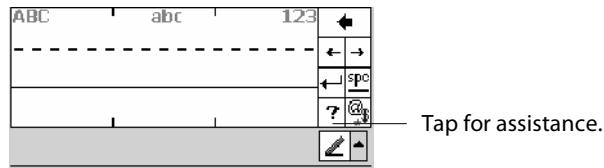

Using Transcriber

With Transcriber, you can write anywhere on the screen using the stylus just as you would on paper. Unlike Letter Recognizer and Block Recognizer, you can write a sentence or more of information. Then, pause and let Transcriber change the written characters to typed characters.

Tap the  arrow, then tap **Transcriber**. Write anywhere on the screen. For specific instructions on using Transcriber, with Transcriber open, tap the question mark in the lower, right-hand corner of the screen.

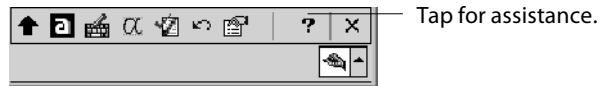

Selecting Typed Text

If you want to edit or format typed text, you must select it first.

- Drag the stylus across the text you want to select.

You can cut, copy, and paste text by tapping and holding the selected words and then tapping an editing command on the pop-up menu, or by tapping the command on the **Edit** menu.

Writing on the Screen

In any program that accepts writing, such as the Notes program, and in the **Notes** tab in Calendar, Contacts, and Tasks, you can use your stylus to write directly on the screen. Write the way you do on paper. You can edit and format what you have written and convert the information to text at a later time.

- Tap the **Pen** button to switch to writing mode. This action displays lines on the screen to help you write.

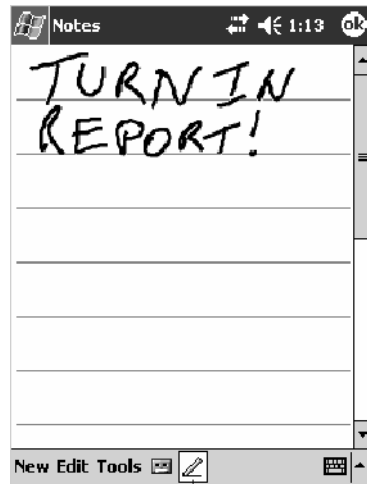

Tap to use your stylus like a pen.



Note: Some programs that accept writing may not have the **Pen** button. See the documentation for that program to find out how to switch to writing mode.

Selecting the Writing

If you want to edit or format writing, you must select it first.

- 1 Tap and hold the stylus next to the text you want to select until the insertion point appears.
- 2 Without lifting, drag the stylus across the text you want to select.

If you accidentally write on the screen, tap **Tools** > **Undo** and try again. You can also select text by tapping the **Pen** button to deselect it and then dragging the stylus across the screen.

You can cut, copy, and paste written text in the same way you work with typed text: tap and hold the selected words and then tap an editing command on the pop-up menu, or tap the command on the **Edit** menu.

Converting Writing to Text

You can convert words you write in print or cursive to text by tapping **Tools > Recognize**. If a word is not recognized, it stays in its written form.

If you want to convert only certain words, tap **Pen** to disable the writing function, tap twice over the word or phrase to highlight, then tap **Tools > Recognize**.

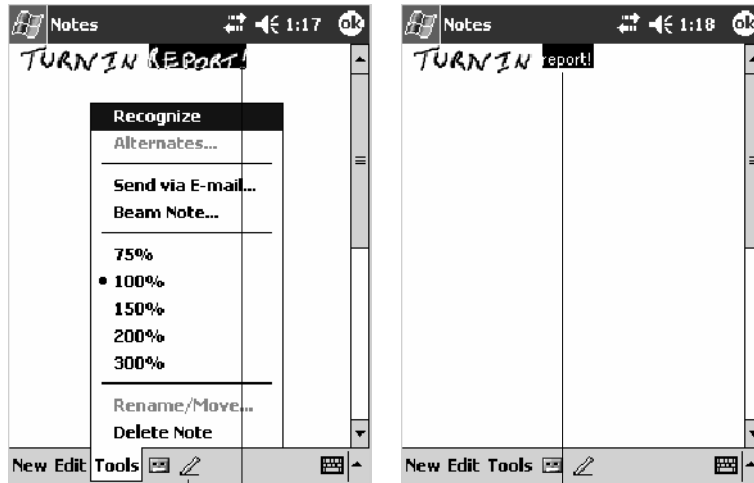

Select the text you want to convert and tap **Recognize** on the pop-up menu.

The writing is turned into text.

Tap to disable the pen function.

If the conversion is incorrect, you can choose different words from a list of alternates or return to the original writing. To do so, tap and hold the incorrect word (tap one word at a time). On the pop-up menu, tap **Alternates**. Tap the word you want to use from the menu with a list of alternate words, or tap the writing at the top of the menu to return to the original writing.

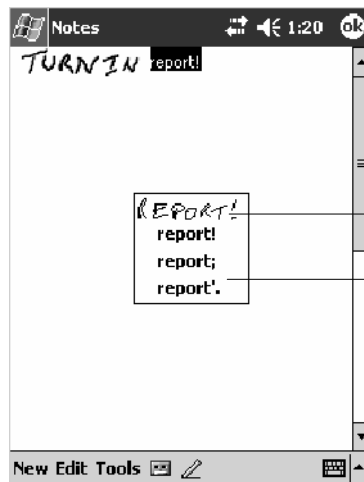

Tap to return to your original writing.

Or, tap the word you want to use.

Tips for getting good recognition:

- Write neatly.
- Write on the lines and draw descenders below the line. Write the cross of the “t” and apostrophes below the top line so they are not confused with the word above. Write periods and commas above the baseline.
- For better recognition, try increasing the zoom level to 300% by using the **Tools** menu. Recognition does not work well below a 150% zoom level.
- Write the letters of a word closely and leave big gaps between words so that the 700 Color Computer can easily tell where words begin and end.
- Hyphenated words, foreign words that use special characters such as accents, and some punctuation cannot be converted.
- If you add writing to a word to change it (such as changing a “3” to an “8”) after you attempt to recognize the word, the writing you add is not included if you attempt to recognize the writing again.

Drawing on the Screen

You can draw on the screen in the same way that you write on the screen. The difference between writing and drawing on the screen is how you select items and how they are edited. For example, you can resize selected drawings, while you cannot resize writing.

Creating a Drawing

- Cross three ruled lines on your first stroke. A drawing box appears. Subsequent strokes in or touching the drawing box become part of the drawing. Drawings that do not cross three ruled lines are treated as writing.

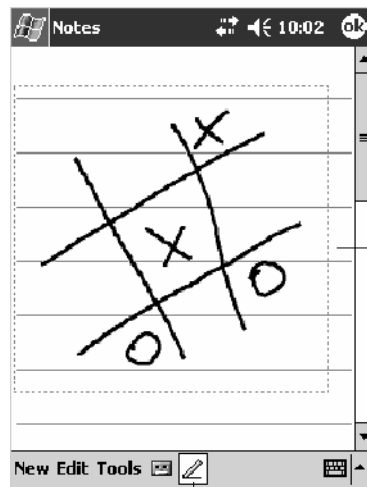

The drawing box indicates the boundaries of the drawing.

Pen button.



Note: You may want to change the zoom level so that you can more easily work on or view your drawing. Tap **Tools** and then a zoom level.

Selecting a Drawing

If you want to edit or format a drawing, you must select it first.

- Tap and hold the stylus on the drawing until the selection handle appears. To select multiple drawings, deselect the **Pen** button and then drag to select the drawings you want.



You can cut, copy, and paste selected drawings by tapping and holding the selected drawing and then tapping an editing command on the pop-up menu, or by tapping the command on the **Edit** menu. To resize a drawing, make sure the **Pen** button is not selected, and drag a selection handle.

Recording a Message

In any program where you can write or draw on the screen, you can also quickly capture thoughts, reminders, and phone numbers by recording a message.

In the Inbox program, you can add a recording to an e-mail message. In Calendar, Tasks, and Contacts, you can include a recording in the **Notes** tab. In the Notes program, you can create a stand-alone recording or add a recording to an open note.

Creating a Recording

- 1 Hold the 700 Color Computer's microphone near your mouth or source of sound.
- 2 Tap  and make your recording.
- 3 Tap  when finished. If you are recording in an open note, an icon appears in the note. If you are creating a stand-alone recording, it appears in the note list.
- 4 To play a recording, tap the recording icon in the open note or tap the recording in the note list.



Note: To quickly create a recording, hold down the Record hardware button. When you hear the beep, begin your recording. Release the button when you are finished. The new recording is stored in the open note or as a stand-alone recording if no note is open.

To play a recording, tap it in the list or tap its icon in the note.

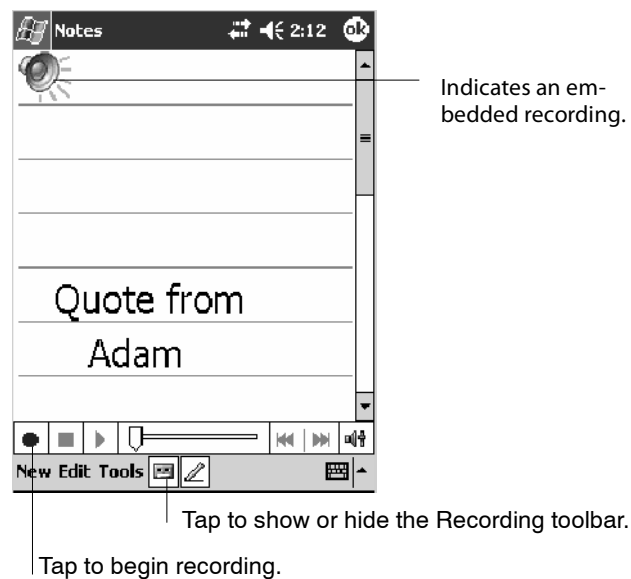

Using My Text

When using Inbox or MSN Messenger, use **My Text** to quickly insert pre-set or frequently used messages into the text entry area. To insert a message, tap **My Text** and tap a message.

- To quickly add common messages, tap **My Text** and tap a desired message.
- To edit a **My Text** message, tap **Tools > Edit My Text Messages**. Tap the message you want to edit and enter new text at the bottom of the screen.

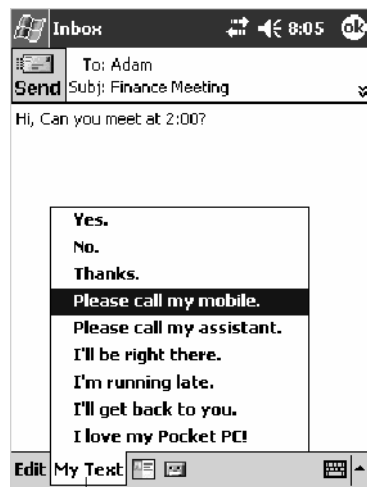

Tap to select a prewritten message.

Finding and Organizing Information

The **Find** feature on your 700 Color Computer helps you quickly locate information.

Tap **Start > Find**. Enter the text you want to find, select a data type, and then tap **Go** to initiate the search.



Note: To quickly find information that is taking up storage space on your 700 Color Computer, select **Larger than 64 KB** in **Type**.



File Explorer

You can also use the File Explorer to find files on your 700 Color Computer and to organize these files into folders. Tap **Start > Programs > File Explorer**.

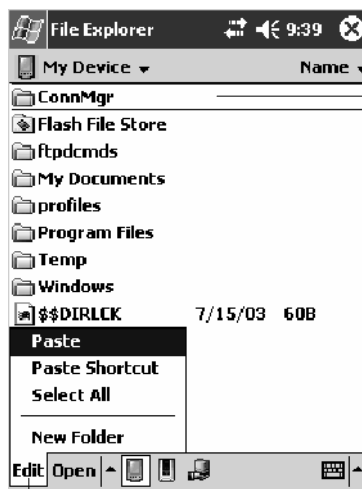

Tap the folder name to open it.

Tap **New Folder** to create a new folder.



Note: You can move files in File Explorer by tapping and holding the item you want to move, and then tapping **Cut** or **Copy** and **Paste** on the pop-up menu.

Customizing Your 700 Color Computer

You can customize your 700 Color Computer by adjusting settings and installing additional software.

Adjusting Settings

You can adjust settings to suit the way you work. To see available options, tap **Start > Settings >** either of the following tabs located at the bottom of the screen. You might want to adjust the following:

Personal Tab



Menus

Menus:

To customize what appears on the **Start** menu, and to enable a pop-up menu from the **New** button.



Owner Information

Owner Information:

To enter your contact information.



Password

Password:

To limit access to your 700 Color Computer.



Today

Today:

To customize the look and information displayed on the **Today** screen.



Clock

System Tab

Clock:

To change the time or to set alarms.



Power

Power:

To maximize battery life.

Adding or Removing Programs

Programs added to your 700 Color Computer at the factory are stored in ROM (Read Only Memory). You cannot remove this software, and you cannot accidentally lose ROM contents. ROM programs can be updated using special installation programs with a *.XIP extension. All other programs and data files added to your 700 Color Computer after factory installation are stored in RAM (Random Access Memory).

You can install any program created for your 700 Color Computer, as long as your 700 Color Computer has enough memory. The most popular place to find software for your 700 Color Computer is on the Windows Mobile Web site (<http://www.microsoft.com/windowsmobile/resources/communities/default.mspix>).

Adding Programs Using ActiveSync

Install the appropriate software for your 700 Color Computer on your desktop before installing it on your 700 Color Computer.



About

- 1 Determine your 700 Color Computer and processor type so that you know which version of the software to install. Tap **Start** > **Settings** > the **System** tab > **About** > the **Version** tab, then make a note of the information in **Processor**.
- 2 Download the program to your desktop (or insert the CD or disk that contains the program into your desktop). You may see a single *.XIP, *.EXE, or *.ZIP file, a SETUP.EXE file, or several versions of files for different 700 Color Computer types and processors. Be sure to select the program designed for the Windows Mobile and your 700 Color Computer processor type.
- 3 Read any installation instructions, Read Me files, or documentation that comes with the program. Many programs provide special installation instructions.
- 4 Connect your 700 Color Computer and desktop.
- 5 Double-click the *.EXE file.
 - If the file is an installer, the installation wizard begins. Follow the directions on the screen. Once the software is installed, the installer automatically transfers the software to your 700 Color Computer.
 - If the file is not an installer, an error message stating that the program is valid but it is designed for a different type of computer is displayed. Move this file to your 700 Color Computer. If you cannot find any installation instructions for the program in the Read Me file or documentation, use ActiveSync Explore to copy the program file to the Program Files folder on your 700 Color Computer. For more information on copying files using ActiveSync, see *ActiveSync Help*.

Once installation is complete, tap **Start** > **Programs**, and then the program icon to switch to it.

Adding a Program Directly from the Internet



About

- 1 Determine your 700 Color Computer and processor type so that you know which version of the software to install. Tap **Start** > **Settings** > the **System** tab > **About** > the **Version** tab, then make a note of the information in **Processor**.
- 2 Download the program to your 700 Color Computer straight from the Internet using Pocket Internet Explorer. You may see a single *.XIP, *.EXE, or *.ZIP file, a SETUP.EXE file, or several versions of files for different 700 Color Computer types and processors. Be sure to select the program designed for the Windows Mobile and your 700 Color Computer processor type.
- 3 Read program installation instructions, Read Me files, or other documentation. Many programs provide installation instructions.
- 4 Tap the file, such as a *.XIP or *.EXE file to start the installation wizard. Follow the directions on the screen.

Adding a Program to the Start Menu

Tap **Start > Settings > Menus > the Start Menu** tab, and then the check box for the program. If you do not see the program listed, you can either use File Explorer on the 700 Color Computer to move the program to the **Start Menu** folder, or use ActiveSync on the desktop to create a shortcut to the program and place the shortcut in the **Start Menu** folder.



Using File Explorer on the 700 Color Computer

Tap **Start > Programs > File Explorer**, and locate the program (tap the folder list, labeled **My Documents** by default, and then **My Device** to see a list of all folders on the 700 Color Computer). Tap and hold the program and tap **Cut** on the pop-up menu. Open the **Start Menu** folder located in the Windows folder, tap and hold a blank area of the window, and tap **Paste** on the pop-up menu. The program now appears on the **Start** menu. For more information on using File Explorer, see “*Finding and Organizing Information*” on page 40.

Using ActiveSync on the desktop

Use the Explorer in ActiveSync to explore your 700 Color Computer files and locate the program. Right-click the program, and then click **Create Shortcut**. Move the shortcut to the **Start Menu** folder in the Windows folder. The shortcut now appears on the **Start** menu. For more information, see *ActiveSync Help*.

Removing Programs



Tap **Start > Settings > the System** tab > **Remove Programs**.

If the program does not appear in the list of installed programs, use File Explorer on your 700 Color Computer to locate the program, tap and hold the program, and then tap **Delete** on the pop-up menu.

Microsoft ActiveSync

Visit the following Microsoft Web site for the latest in updates, technical information, and samples:

<http://www.microsoft.com/windowsmobile/resources/communities/default.aspx>

Using Microsoft ActiveSync, you can synchronize the information on your desktop with the information on your 700 Color Computer. Synchronization compares the data on your 700 Color Computer with your desktop and updates both computers with the most recent information. For example:

- Keep Pocket Outlook data up-to-date by synchronizing your 700 Color Computer with Microsoft Outlook data on your desktop.
- Synchronize Microsoft Word and Microsoft Excel files between your 700 Color Computer and desktop. Your files are automatically converted to the correct format



Note: By default, ActiveSync does not automatically synchronize all types of information. Use ActiveSync options to turn synchronization on and off for specific information types.

With ActiveSync, you can also:

- Back up and restore your 700 Color Computer data.
- Copy (rather than synchronize) files between your 700 Color Computer and desktop.
- Control when synchronization occurs by selecting a synchronization mode. For example, you can synchronize continually while connected to your desktop or only when you choose the synchronize command.
- Select which information types are synchronized and control how much data is synchronized. For example, you can choose how many weeks of past appointments you want synchronized.

Before you begin synchronization, install ActiveSync on your desktop from the *Windows Mobile Companion CD*. For more information on installing ActiveSync, see your Quick Start card. ActiveSync is already installed on your 700 Color Computer.

After installation is complete, the ActiveSync Setup Wizard helps you connect your 700 Color Computer to your desktop, set up a partnership so you can synchronize information between your 700 Color Computer and your desktop, and customize your synchronization settings. Your first synchronization process automatically begins when finished using the wizard.

After your first synchronization, look at Calendar, Contacts, and Tasks on your 700 Color Computer. Notice that information you have stored in Microsoft Outlook on your desktop was copied to your 700 Color Computer, and you did not have to type a word. Disconnect the 700 Color Computer from your computer and you are ready to go!

 **ActiveSync**

Once you have set up ActiveSync and completed the first synchronization process, you can initiate synchronization from your 700 Color Computer. To switch to ActiveSync on your 700 Color Computer, tap **Start > ActiveSync**. Note that if you have a wireless LAN card, you can synchronize remotely from your 700 Color Computer.

For information about using ActiveSync on your desktop, start ActiveSync on your desktop, and then see *ActiveSync Help*.

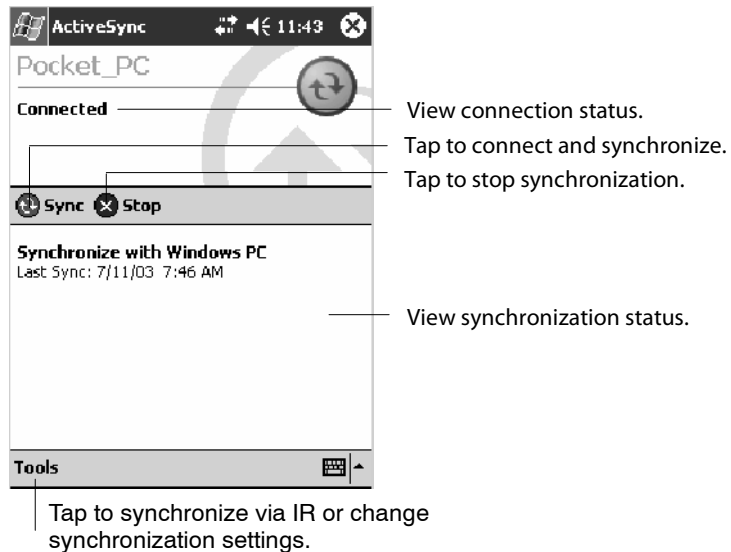

For more information about ActiveSync on your 700 Color Computer, switch to ActiveSync, then tap **Start > Help**.

Microsoft Pocket Outlook

Microsoft Pocket Outlook includes Calendar, Contacts, Tasks, Inbox, and Notes. You can use these programs individually or together. For example, you can use e-mail addresses stored in Contacts to address e-mail messages in Inbox.

Using ActiveSync, you can synchronize information in Microsoft Outlook or Microsoft Exchange on your desktop with your 700 Color Computer. You can also synchronize this information directly with a Microsoft Exchange server. Each time you synchronize, ActiveSync compares the changes you made on your 700 Color Computer and desktop or server and updates both computers with the latest information. For information on using ActiveSync, see *ActiveSync Help* on the desktop.

You can switch to any program by tapping it on the **Start** menu.

Calendar: Scheduling Appointments and Meetings



To switch to Calendar on the 700 Color Computer, tap **Start > Calendar**.

Use Calendar to schedule appointments, including meetings and other events. You can check your appointments in one of several views (Day, Week, Month, Year, and Agenda) and set Calendar to remind you of appointments with a sound or other method.

Appointments for the day can display on the Today screen.

If you use Outlook on your desktop, you can synchronize appointments between your device and desktop.

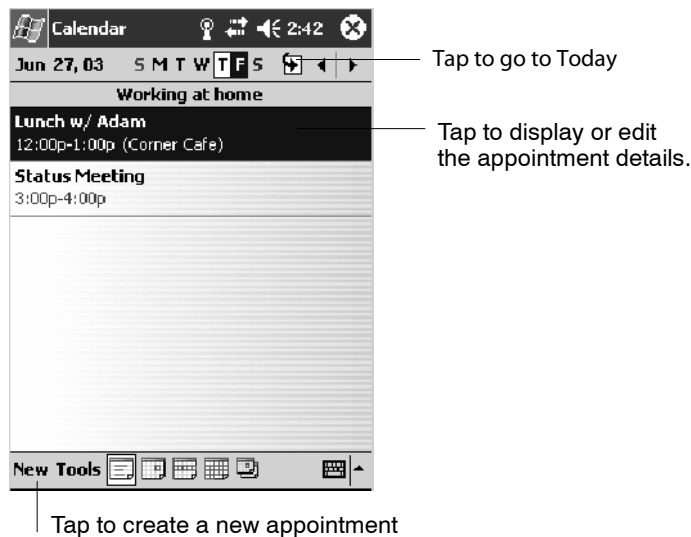

Synchronizing Calendar

Calendar items stored on your device can be synchronized with calendar items on your desktop or Microsoft Exchange Server. (Note that you can only synchronize information directly with an Exchange Server if your company is running Microsoft Mobile Information Server 2002 or later.) Calendar synchronization is automatically selected in ActiveSync.

Calendar items entered on one computer are copied to the other during synchronization. Handwritten notes and drawings are saved as metafiles (pictures).

For more information on synchronization, see *ActiveSync Help* on the desktop.

Why Use Categories in the Calendar?

Use categories to group related tasks, contacts, and appointments. Then, use these groupings to quickly display only the information you want. For example, you can easily share your device with another by assigning your appointments to a category with a special project's name. You can then use this category to filter Calendar and only display appointments for that project.



Note: In Month View, the day of an appointment assigned to the Holiday category appears in red.



This day was assigned the Holiday category.

Tap to access the Month view

What's an All Day Event?

An appointment can either be a normal appointment or an all day event, which lasts the full day or spans many days. Examples include a trade show, a vacation, or a seminar. You can also use all day events to schedule an annual event, such as a birthday or anniversary. In this case, change the Status box to Free (you may need to scroll to see it) so that it does not show time as busy in your calendar. All day events do not occupy blocks of time in Calendar; they appear in banners at the top of the calendar.



Note: You cannot modify or create all day events with attendees on the device. If you create all day events with attendees on your desktop, use ActiveSync to copy such events to the device. Then, view them in Calendar. For more information on copying files, see *ActiveSync Help*. To use the device to schedule an appointment with attendees lasting all day, set type to “Normal,” then adjust the date and time appropriately.

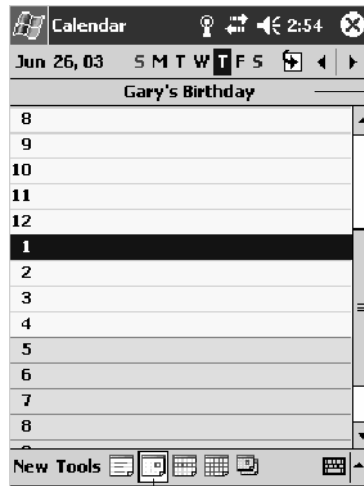

This describes the all day event.

Tap to access the Day view

What's a Recurrence Pattern?

If you have an appointment or task that you do on a regular basis, such as a weekly team meeting or a monthly status report, enter the item once and set a recurrence pattern for it. If the default patterns in the list are not what you need, you can create your own pattern using the wizard.

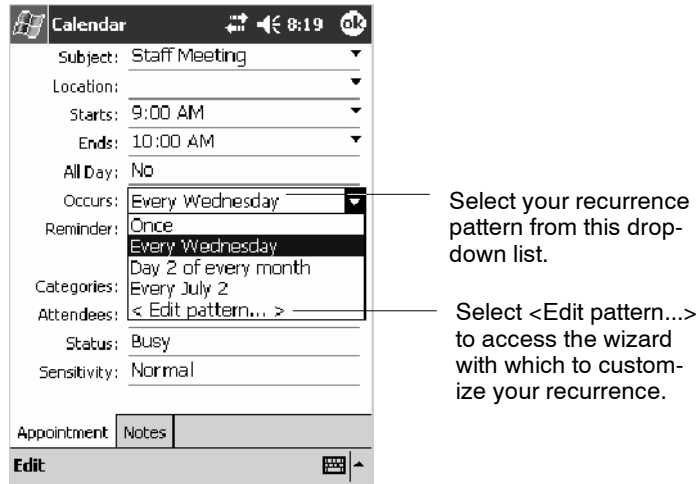

Viewing Appointments

You can view appointments in one of several views (Agenda, Day, Week, and Month). In Agenda view, upcoming appointments are displayed in bold. To see detailed appointment information in any view, tap the appointment. To see a list of available actions for an appointment, tap and hold the appointment.

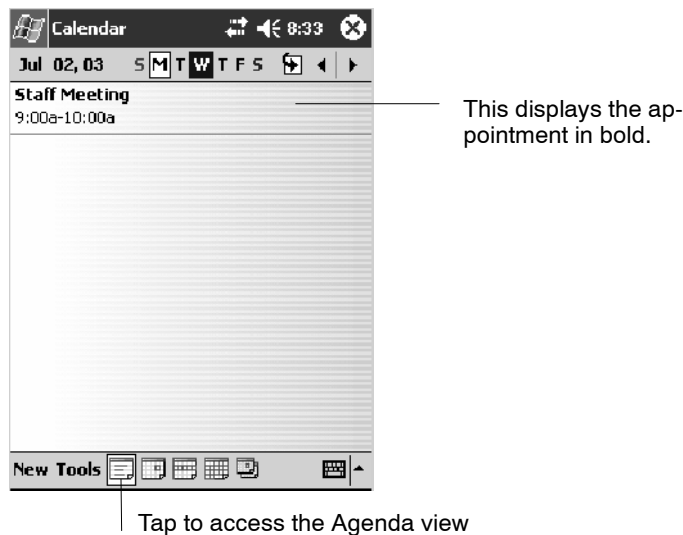

Note: Tap **Start > Today** to quickly see your appointments for the day.

Month view displays symbols to indicate the types of appointments you have on a given day. An upward triangle indicates a morning appointment; a downward triangle indicates an afternoon appointment. If you have appointments in the morning and afternoon, a solid square is displayed. If you have an all day event not marked Free, a hollow square is displayed.

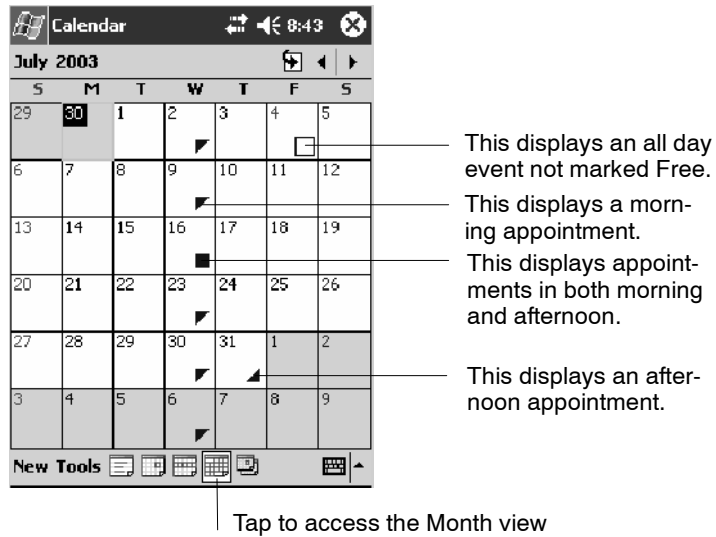

Creating or Changing an Appointment

To create an appointment, tap **New**. To select a new date from a pop-up calendar, tap the display date. To enter or select a new time, tap the display time. Enter the appointment details, and when finished, tap **OK** to return to the calendar.

If you are working in Day view, tap the time slot for the new appointment and then tap **New** to have the time automatically entered for you.

To change an appointment, tap it in the calendar, and then tap **Edit**. Change any appointment detail by tapping it and entering the new information.



Note: Tap the arrows to the right of the description and location boxes to choose from previous entries.

When entering a time, you can type military and abbreviated time forms, such as 2300 (becomes 11:00 PM), 913pm (becomes 9:13 PM), 911 (becomes 9:11 AM), and 9p (becomes 9:00 PM).

Tap to return to the calendar (the appointment is saved automatically).

Tap to choose from predefined text.

Tap to choose from previously entered locations.

Tap to select a time.

Tap to select a date.

Notes is a good place for maps and directions.

Creating an All Day Event

To create an all day event, do the following:

- 1 Tap **New**.
- 2 Tap **All Day**, then select **Yes**.

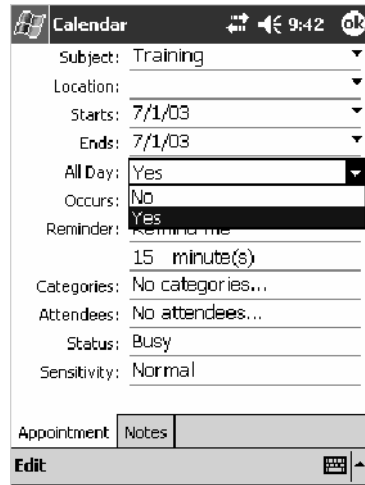

Tap to select either Yes or No whether this is an all day event.



Note: To change an all day event, switch to **Day** or **Agenda** view, tap the event listed at the top of the calendar, and then tap **Edit**. Change any appointment detail by tapping it and entering the new information.

You cannot modify or create all day events with attendees on the 700 Color Computer. If you create all day events with attendees on your desktop, use ActiveSync to copy such events to the 700 Color Computer. Then, view them in Calendar. For more information on copying files, see *ActiveSync Help*. To use the device to schedule an appointment with attendees lasting all day, set type to Normal, then adjust date and time accordingly.

Setting a Reminder for an Appointment

Do the following to set a reminder for an appointment in the calendar:

- 1 Tap the appointment, then tap **Edit** to change the appointment.
- 2 Tap **Reminder** and select **Remind me**.
- 3 To change how many minutes before the appointment you are reminded, tap the minutes displayed, then select the new minutes from a drop-down or enter the new minutes.

Tap **minutes** to change hours, days, or weeks.

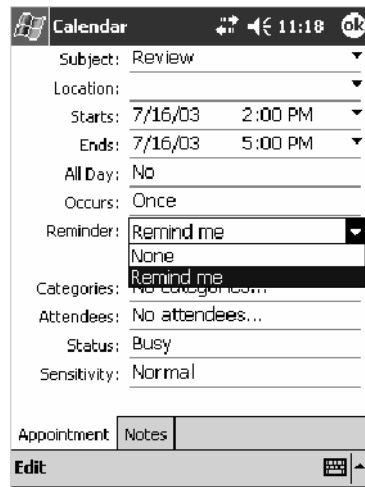

Tap to select **Remind me** to enable the reminder feature.



Note: To automatically set a reminder for all new appointments, in the calendar, tap **Tools > Options**, select **Set reminders for new items**, then tap the number and timeframe options to change the information given.

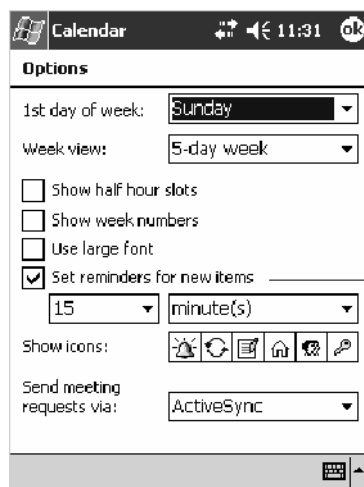

Tap this to set reminders for new appointments automatically.



**Sounds &
Notifications**

To choose how you are reminded, for example by a sound, Tap **Start > Settings > the Personal tab > the Sounds & Notifications icon**.

Adding a Note to an Appointment

You can add written or typed notes and even recordings (if your device supports recordings) to an appointment. This is a good place for maps, drawings, and other detailed information.

- 1 In the calendar, tap the appointment, then tap **Edit**.
- 2 Tap the **Notes** tab to enter notes. For specific instructions, tap **Start > Help > Notes** to see *Notes Help*.

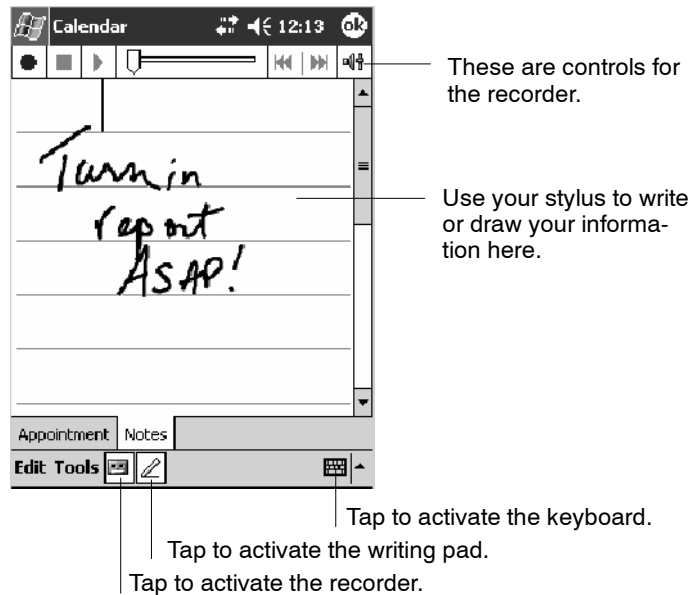

Note: To edit an existing note, tap the appointment in the calendar, tap **Edit**, then tap the **Notes** tab.

Making an Appointment Recurring

Do the following to make a recurring appointment:

- 1 In the calendar, tap the appointment, then tap **Edit**
- 2 Tap **Occurs** and select a pattern from the list. Or, to create a new pattern, tap **<Edit pattern...>**, and follow the steps in the wizard.

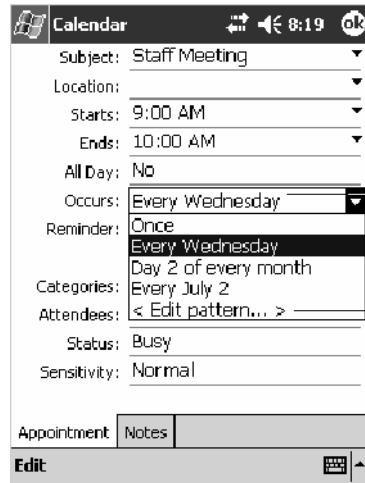

Select your recurrence pattern from this drop-down list.

Select **<Edit pattern...>** to access the wizard with which to customize your recurrence.

Assigning an Appointment to a Category

- 1 In the calendar, tap the appointment, then tap **Edit**.
- 2 Tap **Categories**.
- 3 On the **Select** tab, select the categories to which you want to assign the appointment.
- 4 To create a new category, tap the **Add/Delete** tab, enter the category name, then tap **Add**. The new category is automatically selected in the **Select** tab.
- 5 Tap **ok** to return to the appointment.

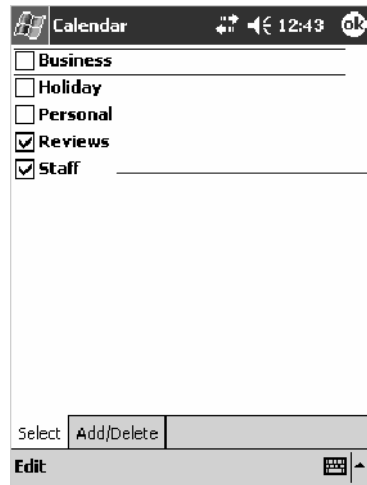

A check mark indicates a selected category.



Note: To find an appointment assigned to a category, tap **Tools > Categories** and select the type of appointment that you want displayed. To show all appointments again, tap **Tools > Categories** and clear all categories.

Sending a Meeting Request

Use Calendar to schedule meetings with people who use Outlook or Pocket Outlook. When attendees receive a meeting request, they can accept or decline the meeting. If they accept, the meeting is automatically added to their schedule. In addition, their response is sent back to you, and your calendar is updated.

Before you can send a meeting request, you must enter e-mail addresses in Contacts Help and set up Inbox to send and receive messages. For more information on sending and receiving meeting requests, tap **Start > Help > Calendar** to see *Calendar Help*, and tap **Start > Help > Inbox** to see *Inbox Help*.

- 1 Tap **New**, then enter the meeting information.
- 2 Hide the onscreen keyboard, if needed, then tap **Attendees**. Only those contacts with e-mail addresses are displayed. Select the contacts you want to invite, then tap **ok** to return to the appointment.
- 3 Select other desired options and then tap **ok**.
- 4 Inbox automatically creates a meeting request and sends it to the attendees the next time you synchronize with your desktop. Textual notes entered in the **Notes** tab (excluding writing or recordings) are sent also.

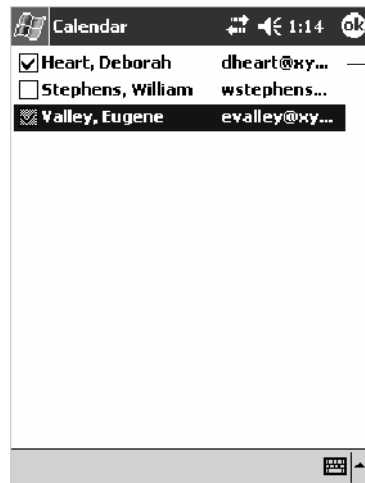

A check mark indicates a selected attendee.



Note: If you are sending the meeting request through a connection to an ISP or the network, rather than through synchronization with your desktop, tap **Tools > Options**. From the **Send meeting requests via** drop-down list, tap the service to use to send the meeting request.

Finding an Appointment

There are two ways to find an appointment:

- Tap **Start > Find**, enter the appointment name, tap the **Type** arrow and select **Calendar** from the drop-down list, and then tap **Go**.
- In the calendar, tap **Tools > Categories** and select the type of appointment you want displayed. To show all appointments again, tap **Tools > Categories** and clear all categories.

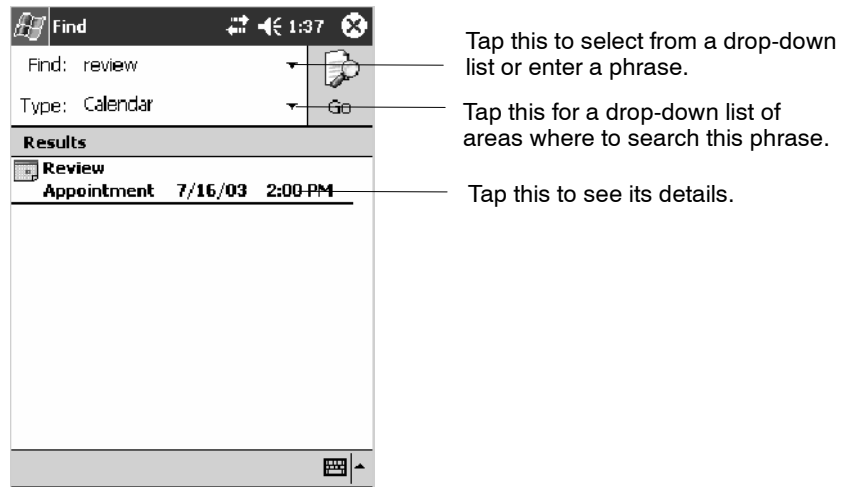

Note: In Find, you can tap the **Find** arrow to select from a list of items of previously searched items or phrases.

Deleting an Appointment

- 1 In the calendar, tap and hold the appointment.
- 2 On the pop-up menu, tap **Delete Appointment**. The next time you synchronize, the appointment is also deleted from the desktop.

Changing Calendar Options

In the calendar, tap **Tools > Options**.

- To see appointment indicators, select icons to display in **Show icons**. You can choose to display indicators for such things as recurring appointments, appointments with notes, and appointments with reminders. Tap and hold an icon to see its name.
- If you are having trouble reading the calendar, select **Use large font**. You may see less appointment information.

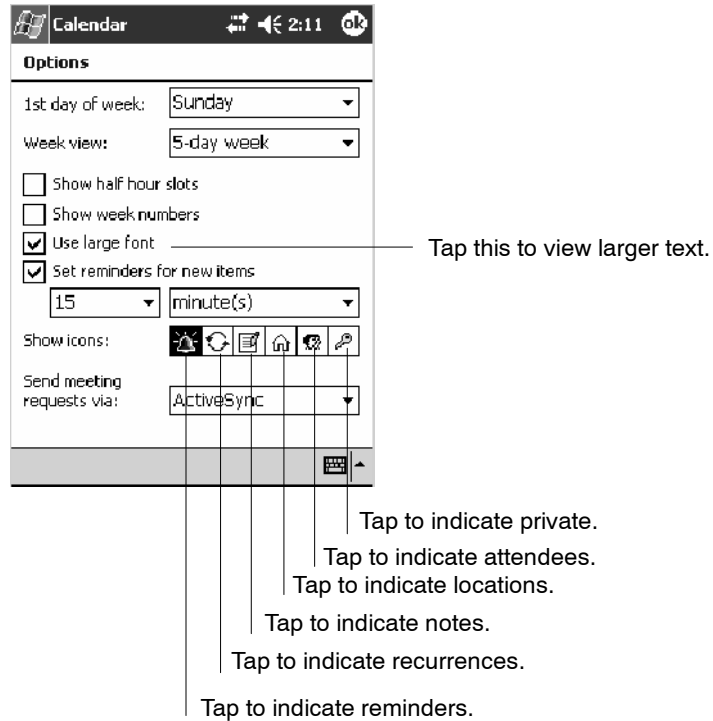

Contacts: Tracking Friends and Colleagues

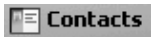

To switch to Contacts on the 700 Color Computer, tap **Start > Contacts**.

Contacts maintains a list of your friends and colleagues so that you can easily find the information you are looking for, whether you are at home or on the road. You can enter both personal and business information.

If you use Microsoft Outlook on your desktop, you can synchronize contacts between your 700 Color Computer and your desktop.

Select the category of contacts you want displayed in the list.

Tap and enter part of a name to quickly find it in the list.

Tap to see additional phone numbers and e-mail addresses.

Tap to display or edit the contact details.

Tap and hold to display a pop-up menu of actions.

Tap to toggle to **By Company** (note the Name view)

Tap to create a new contact.

Creating a Contact

- 1 Tap **New**.
- 2 Using the input panel, enter a name and other contact information. Scroll down to see all available fields.
- 3 To assign the contact to a category, scroll to and tap **Categories** and select a category from the list. In the contact list, you can display contacts by category.
- 4 To add notes, tap the **Notes** tab. You can enter text, draw, or create a recording. For more information on creating notes, see “*Notes: Capturing Thoughts and Ideas*” on page 71.
- 5 When finished, tap **OK** to return to the contact list.

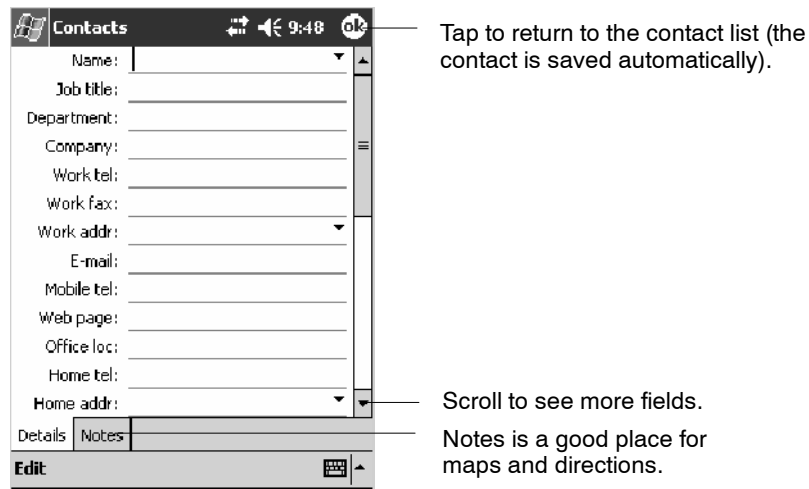

Synchronizing Contacts

Contacts stored on your device can be synchronized with Outlook contacts stored on your desktop or with Mobile Information Server 2002 or later.

New items entered in one location are copied to the other during synchronization. Handwritten notes and drawings are saved as pictures when synchronizing with your desktop, but are removed when synchronizing with a server.

For more information on synchronization, see *ActiveSync Help* on the desktop.

Viewing Contacts

The contact list displays the contact name and the first primary phone number or e-mail address specified for that contact. Contacts are ordered by name of contact or company.

- Tap the default letter (**h**ome, **w**ork, **m**obile, or **e**-mail) to the right of the contact to see additional phone numbers and e-mail addresses.
- Select a contact and press the Left/Right controls to change the default number, displayed as a letter to the right of the contact name.
- To see more contact information, tap the contact.
- To see a list of available actions for a contact via a pop-up menu, tap and hold the contact.
- To see a list of contacts employed by a specific company, tap **View > By Company**. Then, tap the desired company name.



Note: You can change the appearance of the contact list by tapping **Tools > Options**.

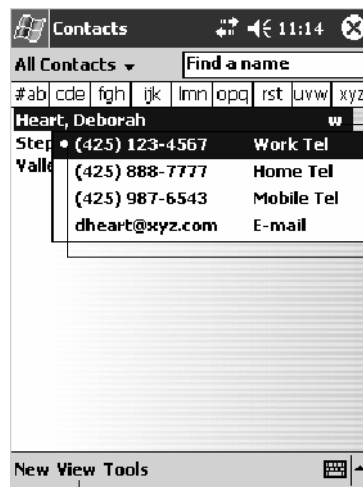

Tap for a list of phone numbers and e-mail addresses.

Indicates the default number.

Tap to toggle By Name and By Company views.

Creating or Changing a Contact

- To create a contact, tap **New**. To enter notes, tap the **Notes** tab. When finished, tap **ok** to return to the contact list.
- To change a contact, tap it in the contact list, and then tap **Edit**. To cancel edits, tap **Edit > Undo**. When finished making changes, tap **ok** to return to the contact list.



Note: If you enter a name with more than two words, the middle word is recorded as a middle name. If your contact has a double first or last name, tap the **Name** arrow and enter the names in the proper box.

Tap to access the **Name** fields.

Tap anywhere outside the box to close and return to details.



Note: New contacts are added to the displayed category.

Adding a Note to a Contact

You can add written or typed notes and even recordings (if your device supports recordings) to a contact. Notes are handy for maps and drawings.

- 1 In the contact list, tap the contact.
- 2 Tap the **Notes** tab. For specific instructions, tap **Start > Help > Notes** to see *Notes Help*.

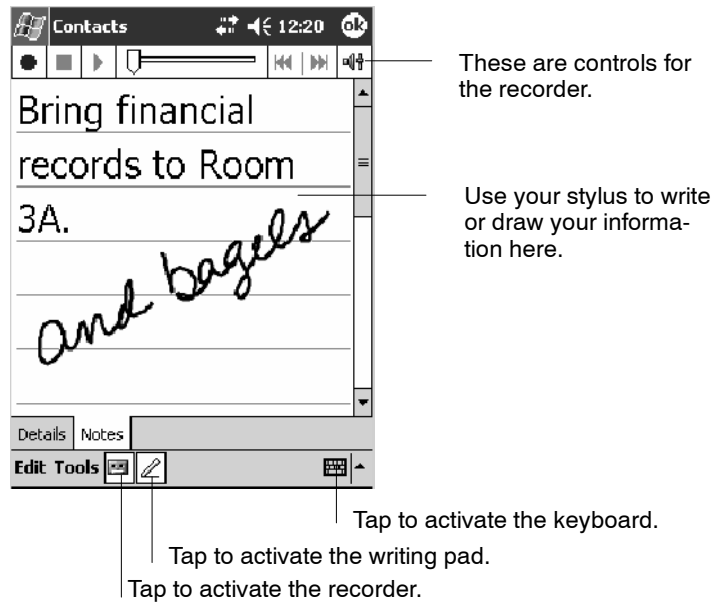

Note: To edit an existing note, tap the contact, tap **Edit**, then tap the **Notes** tab.

Assigning a Contact to a Category

- 1 In the contact list, tap the contact, and then tap **Edit**.
- 2 Scroll to and tap **Categories**.
- 3 On the **Select** tab, select the categories to which you want to assign the contact.
- 4 To create a new category, tap the **Add/Delete** tab, enter the category name, then tap **Add**. The new category is automatically selected in the **Select** tab.
- 5 Tap **ok** to return to the contacts.

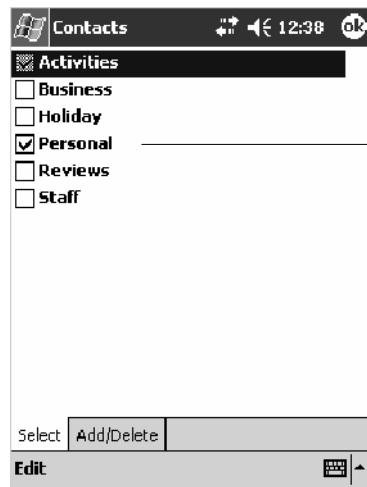

A check mark indicates a selected category.

Copying a Contact

- 1 In the contact list, select the contact. To select multiple contacts, tap and drag.
- 2 Tap **Tools**, and then select **Copy Contacts**.

Sending a Message to a Contact

- 1 In the contact list, tap and hold the contact. To select multiple contacts, tap and drag. Then, tap and hold the selected contacts.
- 2 On the pop-up menu, select **Send Email** or **Send SMS**, depending upon the type of message to send.

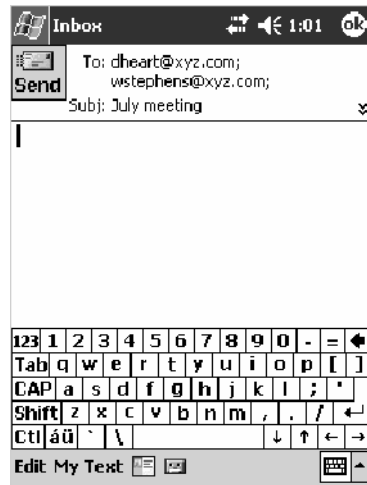

Note: To send an e-mail message, you must have an e-mail address configured for the contact. To send an SMS (Short Messaging Service) message, you must have an SMS number for the contact, which is usually the mobile phone number.

Finding a Contact

There are four ways to find a contact:

- Tap **Start > Find**, enter the contact name (first, last, or middle), phone number, or address, select **Contacts** for the type, then tap **Go**.
- From **Contacts**, start typing a contact name until you see it displayed on the screen. To show all contacts again, tap the text box at the top of the screen and clear the text, or tap the arrow to the right of the text box.
- In the contact list, tap the category list (labeled **All Contacts** by default) and tap the category to which you have assigned a contact. To show all contacts again, select **All Contacts**.
- To view the names of companies for which your contacts work, in the contact list, tap **View > By Company**. The number of contacts that work for that company is displayed to the right of the company name.



Note: To quickly move through a long list of contacts, tap one of the sets of letters displayed at the top of the contact list. This takes you to the contact names beginning with those letters.

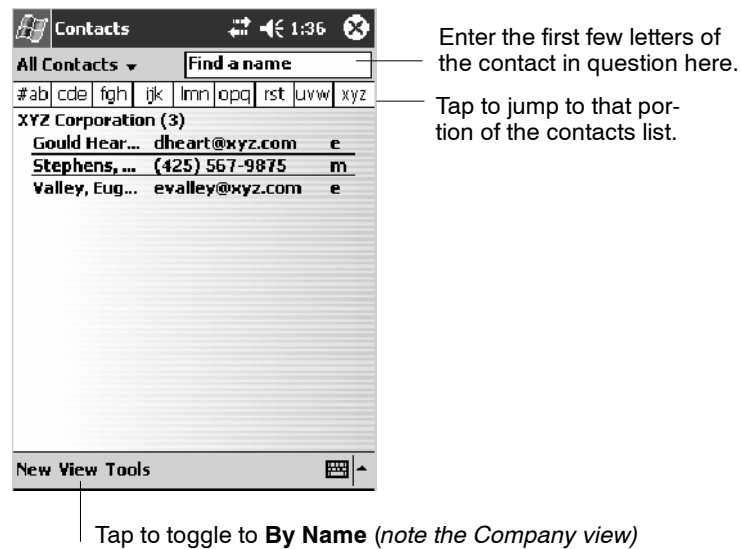

Deleting a Contact

- 1 In the contact list, tap and hold the contact. To select multiple contacts, tap and drag. Then, tap and hold the selected contacts.
- 2 On the pop-up menu, tap **Delete Contact**. The next time you synchronize, the contact is deleted from the desktop also.

Changing Contacts Options

In the contact list, tap **Tools > Options**.

- The area code and country/region for new contacts are automatically entered based on the information in **Country/Region settings**.
- If you are having trouble reading the contacts in the contact list, select **Use large font**.
- To increase the available space for displaying contacts in the list, clear **Show ABC tabs**.

The screenshot shows the 'Options' screen in the Windows Mobile 2003 Contacts application. The status bar at the top displays 'Contacts', signal strength, battery, and the time '1:54'. The main content area is divided into three sections: 'List view settings' with three checkboxes ('Show ABC tabs' is checked, 'Show contact names only' and 'Use large font' are unchecked); 'Country/Region settings' with an 'Area code' field containing '425' and a 'Country/Region' dropdown menu showing 'United States'; and an 'Edit' button at the bottom right.

Clear this to view more contacts per screen.

Tap this to view larger text.

Enter the three-digit area code.

Select from a drop-down list.

Tasks: Keeping a To Do List

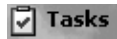

To switch to Tasks on your 700 Color Computer, tap **Start > Tasks**.

Use Tasks to keep track of what you have to do. A variety of task information can display on the Today screen. If you use Microsoft Outlook on your desktop, you can synchronize tasks between your device and desktop.

Select the category of tasks you want displayed in the list.

Select the sort order of the list.

Use this entry bar to assign a task quickly.

Indicates a high priority.

Tap to display or edit the task details.

Tap and hold to display a pop-up menu of actions.

Tap to create a new task.

The screenshot shows the 'Tasks' application window. At the top, there's a title bar with 'Tasks' and a clock showing 12:16. Below the title bar, there are two dropdown menus: 'All Tasks' and 'Priority'. A text entry field contains 'Tap here to add a new task'. Below this, a list of tasks is shown: 'Send status report' (with a high priority icon), 'Buy birthday gift', 'Call Maria', 'Proof new proposal', and 'Schedule message'. A pop-up menu is open over the 'Schedule message' task, showing options: 'Create Copy', 'Delete Task', and 'Beam Task...'. At the bottom of the screen, there is a 'New Tools' button.



Note: To change the way information is displayed in the list, tap **Tools > Options**.

Creating a Task

- To quickly create a task, enter text in the **Tap here to add a new task** box at the top of the screen. If you do not see this box, tap **Tools > Entry Bar**.
- To create a task with detailed information, such as start and due dates, tap **New**. To enter notes, tap the **Notes** tab.

You can enter a start date and due date or enter other information by first tapping the field. If the input panel is open, you need to hide it to see all available fields.

You can enter text, draw, or create a recording. For more information on creating notes, see “*Notes: Capturing Thoughts and Ideas*” on page 71.

- To change a task, tap it in the task list, and then tap **Edit**.
- Using the onscreen keyboard, enter a description.
- To assign the task to a category, tap **Categories** and select a category from the list. In the task list, you can display tasks by category.
- When finished, tap **ok** to return to the task list.

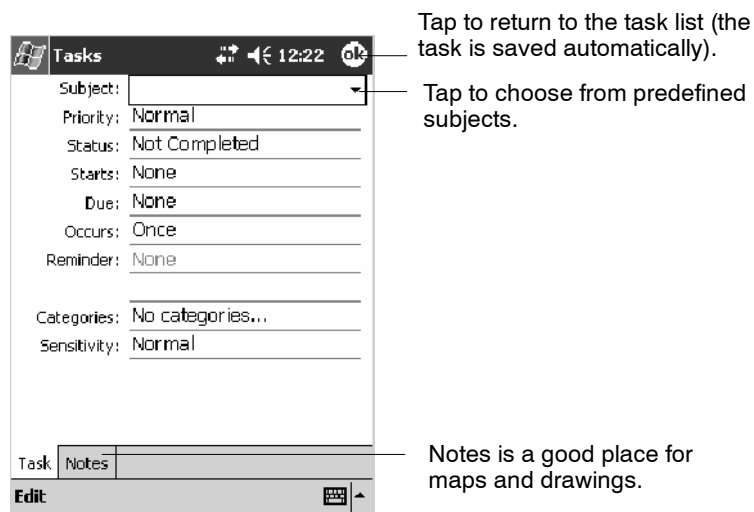

Note: To quickly create a task with only a subject, tap **Entry Bar** on the **Tools** menu. Then, tap **Tap here to add a new task** and enter your task information.

Synchronizing Tasks

Tasks stored on your 700 Color Computer can synchronize with Microsoft Outlook on your desktop. Task synchronization is automatically selected in ActiveSync.

New items entered on one computer are copied to the other during synchronization. Handwritten notes and drawings are saved as metafiles (pictures).

For more information on synchronization, see *ActiveSync Help* on the desktop.

Notes: Capturing Thoughts and Ideas

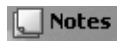

To switch to Notes on your 700 Color Computer, tap **Start > Notes**.

Notes helps you quickly capture your ideas, notes, and thoughts. You can create a note using written and typed text, drawings, and recordings. You can also share your notes with others through e-mail, infrared, and synchronization with your desktop.

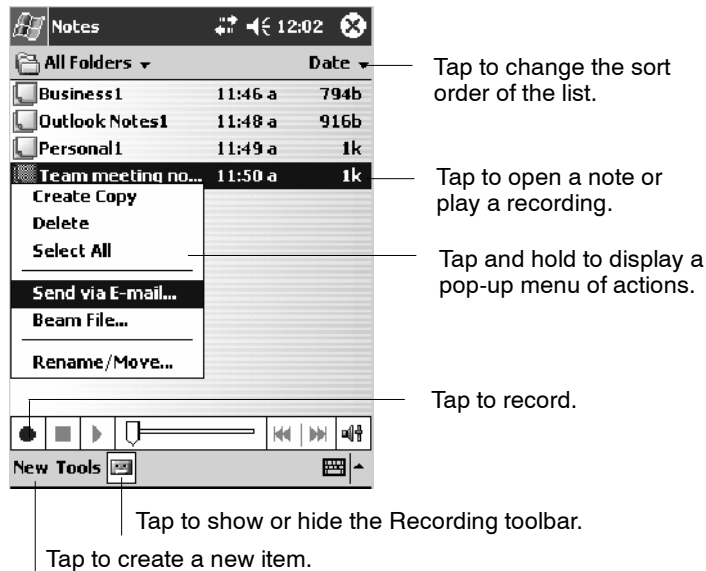

Note: To create documents with advanced formatting or templates, such as bulleted lists and tabs, use word processing software developed for your device, such as Pocket Word.

Creating a Note

To create your note, tap **New**, then write, draw, type, or record your information. For information about using the input panel, writing and drawing, and creating recordings, see “*Basic Skills*” on page 26.

- **Writing**
Using the stylus, write directly on the screen.
- **Drawing**
Using the stylus, draw directly on the screen.
- **Typing**
Using the input panel, enter typed text into the 700 Color Computer. Do this by tapping keys on the onscreen keyboard or by using handwriting recognition software.
- **Recording**
Create a stand-alone recording or embed a recording into a note.

Synchronizing Notes

Notes can be synchronized between your desktop and device either through notes synchronization or file synchronization. Notes synchronization synchronizes the notes on your 700 Color Computer with Outlook Notes on your desktop. File synchronization synchronizes all notes on your 700 Color Computer with the My Documents folder for the 700 Color Computer on your desktop.

To synchronize your notes through notes synchronization, first select the Notes information type for synchronization in ActiveSync. The next time you synchronize, all notes in My Documents and its subfolder on your device appear in Outlook Notes on your desktop. Notes that contain only text appear as regular notes in Outlook on your desktop, while notes containing written text or drawings appear in the device format. In addition, all notes in the Notes group in Outlook on the desktop appear in Notes on the device.

To synchronize your notes as files, in ActiveSync, select the Files information type for synchronization and clear the Notes information type. When you select Files, the My Documents folder for the 700 Color Computer is created on your desktop. All .PWI files placed in the My Documents folder on your device and all .DOC files placed in the My Documents folder for the 700 Color Computer on your desktop are synchronized. Password-protected files cannot be synchronized.

ActiveSync converts documents during synchronization. For more information on synchronization or file conversion, see *ActiveSync Help* on the desktop.



Note: When you delete or change an item on either your desktop or 700 Color Computer, the item is changed or deleted in the other location the next time you synchronize.



Note: If you synchronize your notes using file synchronization and then later decide to use notes synchronization, all of your notes are synchronized with Outlook on your desktop and no longer store in the My Documents folder for the 700 Color Computer.

Inbox: Sending and Receiving E-mail Messages

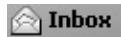

To switch to Inbox on your 700 Color Computer, tap **Start > Inbox**.

You can receive Internet e-mail messages and SMS messages in Inbox. Internet e-mail messages are sent by using an address you receive from your Internet service provider (ISP) or your employer. SMS messages are sent and received through your wireless phone service provider by using a phone number as the message address.

You can send and receive e-mail by synchronizing with your desktop, or by connecting to a Post Office Protocol 3 (POP3) or Internet Message Access Protocol 4 (IMAP4) mail server. You need to set up an e-mail account for each method that you use except for Microsoft ActiveSync, which is set up by default. The ActiveSync folder on your 700 Color Computer stores messages that you send and receive through synchronization with a desktop. Account names appear as folders in the folder list (located on the left, under the navigation bar) in the Inbox message list.

With synchronization, messages are synchronized between the device Inbox and the PC Inbox by using ActiveSync and Microsoft Exchange or Microsoft Outlook. For more information, see “*Synchronizing E-mail Messages*” below.

When connecting to a POP3 or IMAP4 server, you use a modem to connect to your Internet service provider (ISP), or a modem or Ethernet card to connect to the local area network to which your e-mail server is connected. You can also use your phone to connect by using a cellular line connection. For more information, see “*Connecting to a Mail Server*” on page 75.

Synchronizing E-mail Messages

After selecting Inbox for synchronization in ActiveSync, e-mail messages are synchronized as part of the general synchronization process. During synchronization:

- Messages are copied from the Inbox folder on your desktop or the Microsoft Exchange server to the Inbox folder on your 700 Color Computer. (Note that you can only synchronize information directly with an Exchange Server if your company is running Microsoft Mobile Information Server 2002 or later.) By default, you receive messages from the last three days only, the first 100 lines of each new message, and file attachments of less than 100 KB in size.
- Messages in the Outbox folder on your device are transferred to Exchange or Outlook and then sent from those programs.
- The messages on the two computers are linked. When you delete a message on your 700 Color Computer, it is deleted from your desktop the next time you synchronize.
- Messages in subfolders in other e-mail folders in Outlook are synchronized only if they were selected for synchronization in ActiveSync.

For information on initiating Inbox synchronization or changing synchronization settings, see *ActiveSync Help* on your desktop or select **Start > Help > Connections** to see *Connections Help*.

Managing E-mail Messages and Folders

Each e-mail account and SMS account has its own folder hierarchy with five default folders: Inbox, Outbox, Deleted Items, Drafts, and Sent Items. The messages you receive and send through the mail account are stored in these folders. You can also create additional folders within each hierarchy. The Deleted Items folder contains messages that were deleted on the device. The behavior of the Deleted Items and Sent Items folders depends on the Inbox options you have chosen.

The behavior of the folders you create depends on whether you are using ActiveSync, SMS, POP3, or IMAP4.

- *If you use ActiveSync,*
e-mail messages in the Inbox folder in Outlook automatically synchronize with your device. You can select to synchronize additional folders by designating them for ActiveSync. The folders you create and the messages you move are then mirrored on the server. For example, if you move two messages from the Inbox folder to a folder named Family, and you have designated Family for synchronization, the server creates a copy of the Family folder and copies the messages into that folder. You can then read the messages while away from your desktop.
- *If you use SMS,*
messages are stored in the Inbox folder.
- *If you use POP3*
and you move e-mail messages to a folder you created, the link is broken between the messages on the device and their copies on the mail server. The next time you connect, the mail server sees that the messages are missing from the device Inbox and deletes them from the server. This prevents you from having duplicate copies of a message, but it also means that you no longer have access to messages that you move to folders created from anywhere except the 700 Color Computer.
- *If you use IMAP4,*
the folders you create and the e-mail messages you move are mirrored on the server. Therefore, messages are available to you anytime you connect to your mail server, whether it is from your 700 Color Computer or desktop. This synchronization of folders occurs whenever you connect to your mail server, create new folders, or rename or delete folders when connected.

For all accounts except ActiveSync, you can access folder options by tapping **Tools > Manage Folders**.

Connecting to a Mail Server

In addition to synchronizing e-mail messages with your desktop, you can send and receive e-mail messages by connecting to an e-mail server using a modem or network card connected to your 700 Color Computer. You need to set up a remote connection to a network or an ISP, and a connection to your e-mail server. For more information, see “*Getting Connected*” on page 98.

When you connect to the e-mail server, new messages are downloaded to the 700 Color Computer Inbox folder, messages in the 700 Color Computer Outbox folder are sent, and messages that were deleted on the e-mail server are removed from the 700 Color Computer Inbox folder.

Messages that you receive directly from an e-mail server are linked to your e-mail server rather than your desktop. When you delete a message on your 700 Color Computer, it is also deleted from the e-mail server the next time you connect based on the settings selected in ActiveSync.

You can work online or offline. When working online, you read and respond to messages while connected to the e-mail server. Messages are sent as soon as you tap **Send**, which saves space on your 700 Color Computer.

When working offline, once you have downloaded new message headers or partial messages, you can disconnect from the e-mail server and then decide which messages to download completely. The next time you connect, Inbox downloads the complete messages you have marked for retrieval and sends the messages you have composed.

Setting Up or Changing an Account

To set up an account:

- To set up a POP3 or IMAP4 e-mail account, tap **Accounts > New Account**. Follow the instructions in the New Account Wizard.
- To set up an SMS account, tap **Accounts > Accounts**, and then tap **SMS**. Follow the instructions on the screen.

To change options for an account:

- 1 Tap **Accounts > Accounts**.
- 2 Tap the name of the account, and follow the instructions on the screen.

To delete an account:

- 1 Tap **Accounts > Accounts**.
- 2 Tap and hold the name of the account, and then tap **Delete**.



Note: You can set up several e-mail accounts including your ActiveSync account, but you can set up only one SMS account.



Note: You cannot add a new account while connected. Tap **Accounts > Disconnect** to disconnect.



Note: You cannot delete your SMS account.

Downloading Messages from the Server

In Inbox, tap **Accounts > Connect** to open a connection to the Internet or your corporate network, depending on the account. For more information, tap **Start > Help > Connections** to see *Connections Help*.

- 1 Tap **Accounts** and ensure that the account you want to use is selected (marked by a bullet.)
- 2 Tap **Connect**. The messages on your 700 Color Computer and e-mail server are synchronized: new messages are downloaded to the 700 Color Inbox folder, messages in the 700 Color Outbox folder are sent, and messages that were deleted from the server are removed from the 700 Color Inbox. Tap a message in the message list to open it.
- 3 If you read a message and decide that you need the full copy, tap **Edit > Mark for Download** while in the message window. If you are in the message list, tap and hold the message, and then tap **Mark for Download**. This also downloads message attachments if you selected those options when you set up the e-mail account. You can also choose to download full copies of messages by default.
- 4 When finished, tap **Accounts > Disconnect**.



Note: Receiving entire messages consumes storage memory.



Note: The size column in the message list displays the local size and server size of a message. Even when a message has downloaded fully, these numbers may differ because the size of a message can vary between the server and the device.

Composing and Sending Messages

To compose a message:

- 1 In the message list, tap **New**.
- 2 To select an account, tap the **From** list and select “ActiveSync,” “SMS,” or the desired e-mail account.
- 3 Enter the e-mail address or SMS address of one or more recipients, separating them with semicolons. To access addresses and phone numbers from Contacts, tap **To**.
- 4 Enter your message. To quickly add common messages, tap **My Text** and tap a desired message.
- 5 To check spelling, tap **Edit > Spell Check**.
- 6 Tap **Send**. If you are working offline, the message is moved to the Out-box folder and is sent the next time you connect.

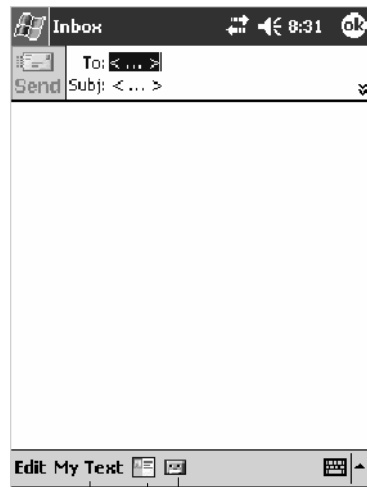

Tap to show or hide the complete header.

Tap to show or hide the recording tool bar.

Tap to display the Address Book.

Tap to insert common (preset) messages.



Note: If you are sending an SMS message and want to know if it was received, before sending the message, tap **Edit > Options > Request SMS text message delivery notification**.



You can directly call the sender of an SMS message by tapping the icon shown to the left, then **Call**.



Note: Depending on the e-mail address options that you select, you can use a directory service in addition to your contact list to verify names.

Companion Programs

The companion programs consist of Microsoft Pocket Word, Microsoft Pocket Excel, Windows Media Player, and Microsoft Reader. To switch to a companion program on your 700 Color Computer, tap **Start > Programs**, then tap the program name.

Pocket Word

Pocket Word works with Microsoft Word on your desktop to give you access to copies of your documents. You can create new documents on your 700 Color Computer, or you can copy documents from your desktop to your 700 Color Computer. Synchronize documents between your desktop and your 700 Color Computer to have up-to-date content in both locations.



Creating a Document

Use Pocket Word to create documents, such as letters or meeting minutes. To create a new file, tap **Start > Programs > Pocket Word > New**. You get either a blank document or a template, depending on what you have selected in the **Tools > Options** dialog box. Select an input mode from the **View** menu.

You can open only one document at a time; when you open a second document, you have to save the first. You can save a document you create or edit in formats such as Word (.DOC), Pocket Word (.PSW), Rich Text Format (.RTF), and Plain Text (.TXT).

Pocket Word contains a list of files stored on your 700 Color Computer. Tap a file in the list to open it. To delete, make copies of, and send files, tap and hold a file in the list, then, select the action on the pop-up menu.

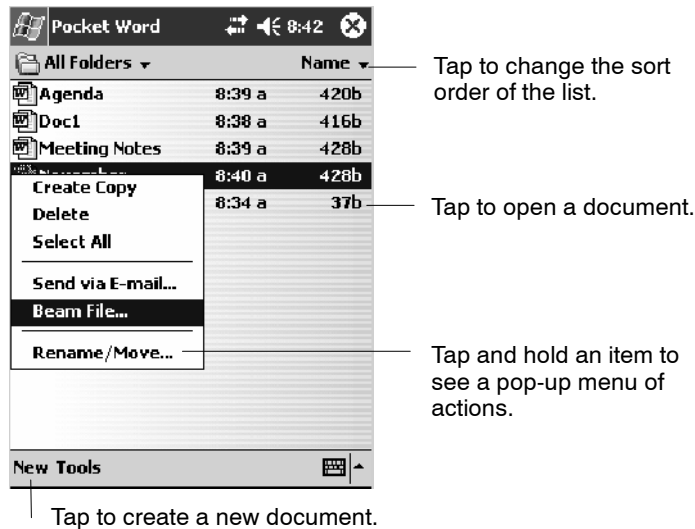

You can enter information in Pocket Word in one of four modes (typing, writing, recording, and drawing), which are displayed on the **View** menu. Each mode has its own toolbar, which you can show and hide by tapping the **Show/Hide Toolbar** button on the command bar.

You can change the zoom magnification by tapping **View > Zoom**, then select the percentage you want. Select a higher percentage to enter text and a lower one to see more of your document.

If you are opening a Word document created on a desktop, you may select **View > Wrap to Window** so that you can see the entire document.

To check spelling, select text, then tap **Tools > Spell Check**. To use your new document as a template, move the document to the Templates folder.

You can insert the data in a document. First, make sure that no drawings are selected, tap and hold anywhere on the document, then tap **Insert Date** from the pop-up menu.

Typing Mode

Using the input panel, enter typed text into the document. For more information on entering typed text, see “Basic Skills” on page 26.

To format existing text and to edit text, first select the text. You can select text as you do in a Word document, using your stylus instead of the mouse to drag through the text you want to select. You can search a document to find text by tapping **Edit > Find/Replace**.

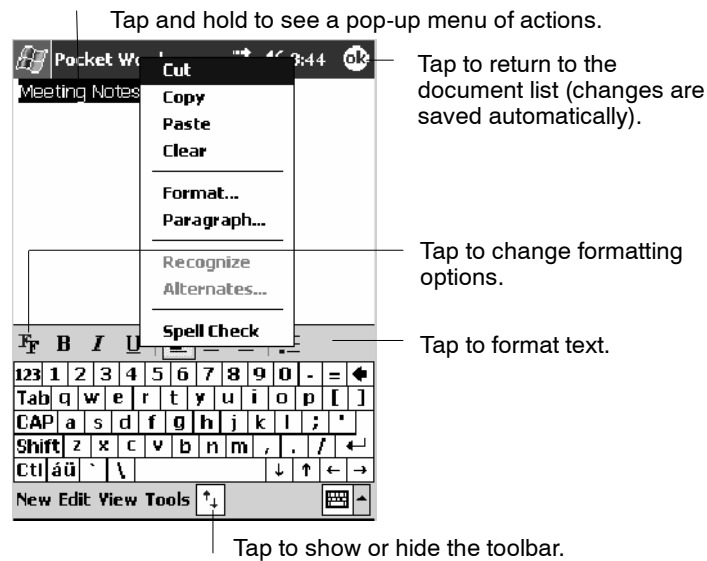

Writing Mode

In writing mode, use your stylus to write directly on the screen. Ruled lines are displayed as a guide, and the zoom magnification is greater than in typing mode to allow you to write more easily. For more information on writing and selecting writing, see “*Basic Skills*” on page 26.

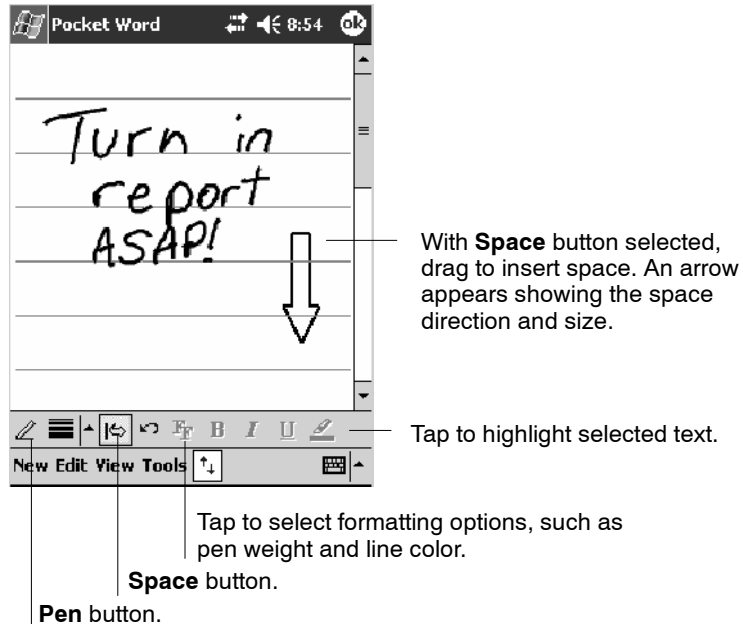

Note: If you cross three ruled lines in a single stylus stroke, the writing becomes a drawing, and can be edited and manipulated as described in “*Drawing Mode*” on the next page.



Note: Written words are converted to graphics (metafiles) when a Pocket Word document is converted to a Word document on your desktop.

Recording Mode

In recording mode, embed a recording into your document. Recordings are saved as .WAV files. For more information on recording, see “*Basic Skills*” on page 26.

For more information on using Pocket Word, tap **Start > Help > Pocket Word** to see *Pocket Word Help*.

Drawing Mode

In drawing mode, use your stylus to draw on the screen. Grid lines appear as a guide. When you lift your stylus off the screen after the first stroke, a drawing box indicating the boundaries of the drawing appears. Every subsequent stroke within or touching the drawing box becomes part of the drawing. For more information on drawing and selecting drawings, see “Basic Skills” on page 26.

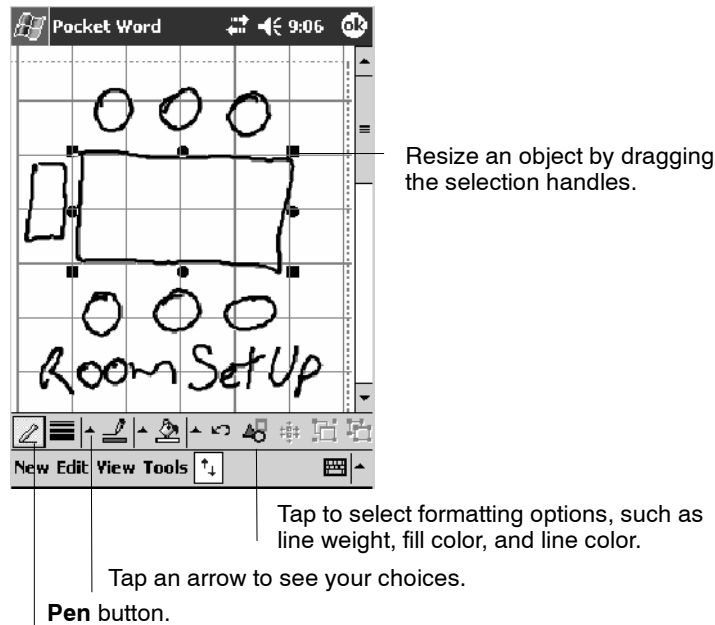

Synchronizing Pocket Word Documents

Pocket Word documents can be synchronized with Word documents on your desktop. To synchronize files, first select the Files information type for synchronization in ActiveSync. When you select Files, the My Documents folder for the 700 Color Computer is created on your desktop. Place all files you want to synchronize with the device in this folder. Password-protected files cannot be synchronized.

All Pocket Word files stored in My Documents and its subfolders are synchronized with the desktop. ActiveSync converts documents during synchronization.

For more information on synchronization or file conversion, see *ActiveSync Help* on the desktop.



Note: When you delete a file on either your desktop or your 700 Color Computer, the file is deleted in the other location the next time you synchronize.

Pocket Excel

You can create and edit workbooks and templates in Microsoft Pocket Excel as you do in Microsoft Excel on your desktop. Pocket Excel workbooks are usually saved as .PXL files, but you can also save them in .XLS format.

When you close a workbook, it is automatically named and placed in the Pocket Excel workbook list. You can attach a password to a workbook to help ensure privacy.

Creating a Workbook



Use Pocket Excel to create workbooks, such as expense reports and mileage logs. To create a new file, tap **Start > Programs > Pocket Excel > New**. A blank workbook appears. Or, if you have selected a template for new workbooks in the **Tools > Options** dialog box, that template appears with appropriate text and formatting already provided. You can open only one workbook at a time; when you open a second workbook, save the first. You can save a workbook you create or edit in a variety of formats, including Pocket Excel (.PXL) and Excel (.XLS). You can also save a workbook as a template by moving the workbook to the Templates folder.

Pocket Excel contains a list of the files stored on your 700 Color Computer. Tap a file in the list to open it. To delete, make copies of, and send files, tap and hold a file in the list. Then select the appropriate action from the pop-up menu.

Pocket Excel provides fundamental spreadsheet tools, such as formulas, functions, sorting, and filtering. To display the toolbar, tap **View > Toolbar**.

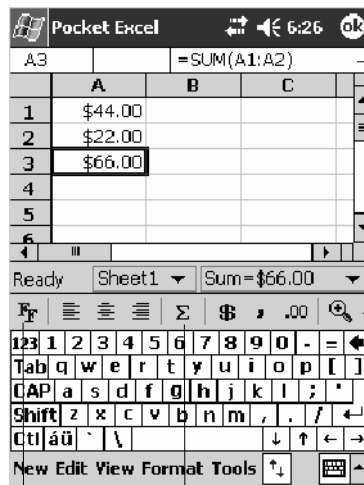

Cell contents appear here as you enter them.

Zoom button.

AutoSum button.

Format button.



Note: If your workbook contains sensitive information, you can protect it with a password. To do so, open the workbook, tap **Edit > Password**. Every time you open the workbook, enter a password, preferably one that is easy for you to remember but hard for others to guess.

Tips for Working in Pocket Excel

Note the following when working in large worksheets in Pocket Excel:

- View in full-screen mode to see as much of your worksheet as possible. Tap **View > Full Screen**. To exit full-screen mode, tap **Restore**.
- Tap **View > Zoom** and select a percentage so that you can easily read the worksheet.
- Show and hide window elements. Tap **View** and then tap the elements you want to show or hide.
- Freeze panes on a worksheet. First select the cell where you want to freeze panes. Tap **View > Freeze Panes**. You might want to freeze the top and leftmost panes in a worksheet to keep row and column labels visible as you scroll through a sheet. Tap **View > Unfreeze Panes** to undo this process.
- Split panes to view different areas of a large worksheet. Tap **View > Split**. Then drag the split bar to where you want it. To remove the split, tap **View > Remove Split**.
- Show and hide rows. To hide a row, select a cell in the row you want to hide. Then tap **Format > Row > Hide**. To show a hidden row, tap **Tools > Go To**, and then type a reference that is in the hidden row. Then tap **Format > Row > Unhide**.
- Do the same to show and hide columns. To hide a column, select a cell in the column you want to hide. Then tap **Format > Column > Hide**. To show a hidden column, tap **Tools > Go To**, and then type a reference that is in the hidden column. Then tap **Format > Column > Unhide**.

For more information on using Pocket Excel, tap **Start > Help > Pocket Excel** to see *Pocket Excel Help*.

MSN Messenger

MSN Messenger on your 700 Color Computer provides the same chat environment as MSN Messenger on your desktop. These features include:

- Seeing who is online
- Sending and receiving instant messages
- Having an instant message conversation with a group of contacts
- Telling contacts that you are unavailable
- Blocking contacts from seeing your status or sending you messages

To use MSN Messenger, you need a Microsoft Passport account, or a Microsoft Exchange e-mail account that your employer provides. Once you have one of these accounts, do the following:

- 1 Set up a connection on your 700 Color Computer, such as a modem or wireless connection, that enables you to connect to the Internet.
- 2 Set up an account in MSN Messenger.
- 3 Sign in to MSN Messenger.



Note: To set up a free Hotmail account, go to <http://www.hotmail.com>. To set up a Microsoft Passport account, go to <http://www.passport.com>. To set up an Exchange account, see your network administrator.

For more information on using MSN Messenger, tap **Start > Help > MSN Messenger** to see *MSN Messenger Help*.



MSN
Messenger

To switch to MSN Messenger, tap **Start > Programs > MSN Messenger**.

Setting Up an Account

Before you can use MSN Messenger, you must set up the instant messaging accounts to use. For MSN Messenger Service, you must have a Microsoft Passport or Hotmail account. For Exchange Instant Messaging, you must have an Exchange account.

- 1 Create a connection for your device. To use MSN Messenger Service, set up a connection to the Internet; to use Exchange Instant Messaging, set up a connection to your corporate network. See page 98 for more information on getting connected.
- 2 In MSN Messenger, tap **Tools** > **Options** > the **Accounts** tab.
- 3 Select **Enable MSN Messenger Service** or **Enable Exchange Instant Messaging**.
- 4 Enter your sign-in name and password for the selected accounts. Your sign-in name is usually in the username@domain.com form.
- 5 If you selected both accounts, under **Sign in using this account first**, select which account to sign in to first.



Signing In and Out

- To sign in, tap anywhere on the screen. Follow the directions on the screen.
- To sign out, tap **Tools** > **Sign Out**.
- To sign in upon connecting, tap **Tools** > **Options** > **General** and select the **Run this program upon connection** box.
- Signing in to an Exchange account may take several minutes depending upon your connection speed. Reducing the number of Exchange contacts decreases your sign-in time.

Working with Contacts

The MSN Messenger window shows all of your messenger contacts at a glance, divided into Online and Not Online categories. From this view, while connected, you can chat, send e-mail, block the contact from chatting with you, or delete contacts from your list using the pop-up menu.

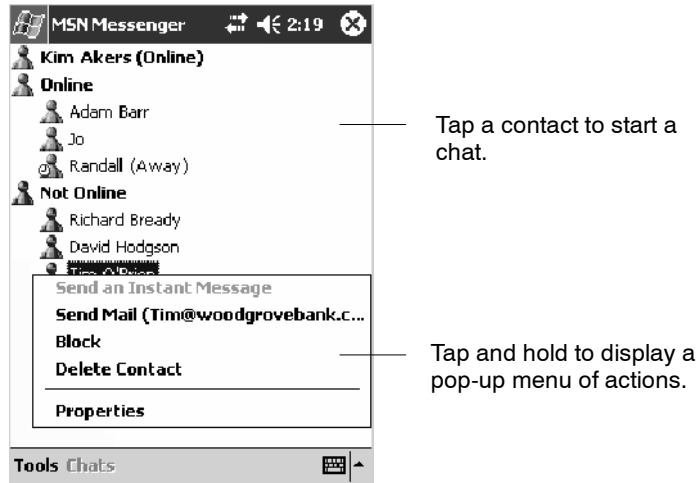

To add a contact, tap **Tools > Add a Contact** and follow the directions on the screen.

To delete a contact, tap and hold the contact's name, then tap **Delete Contact** from the pop-up menu.

To see others online without being seen, tap **Tools > My Status > Appear Offline**.

Managing Contacts

To be alerted each time you are added to a contact list, tap **Tools > Options > the Privacy tab**.

- To block a contact from seeing your status and sending you messages, tap the contact and tap the right arrow. This moves the contact to the **My Block List**.
- To unblock a contact, tap the contact and tap the left arrow. This moves the contact to the **My Allow List**.
- To receive an alert when someone adds you to their contacts list, select **Alert me when I am added to a Passport contact list**.
- To see who has you listed as a contact, tap **View**.



Sending a Message

- Tap a contact to whom you want to send a message. Enter your message in the text entry area at the bottom of the screen and tap **Send**. To quickly add common messages, tap **My Text** and tap a desired message.
- To invite another contact to an ongoing chat, tap **Tools > Invite** and tap a contact.
- To see who is already chatting or to switch between chats, tap **Chats**.

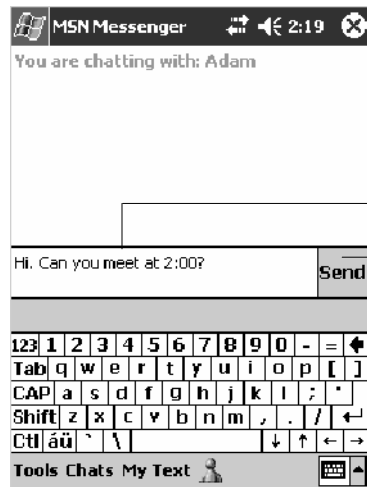

Enter a message.

Tap to send message.

Windows Media Player for Windows Mobile

Use Microsoft Windows Media Player for Windows Mobile to play digital audio and video files that are stored on your 700 Series Computer or on a network.

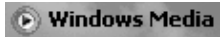

To switch to Windows Media Player on your 700 Color Computer, tap **Start > Windows Media**.

Use Microsoft Windows Media Player on your desktop to copy digital audio and video files to your 700 Color Computer. You can play Windows Media and MP3 files on your Windows Mobile.

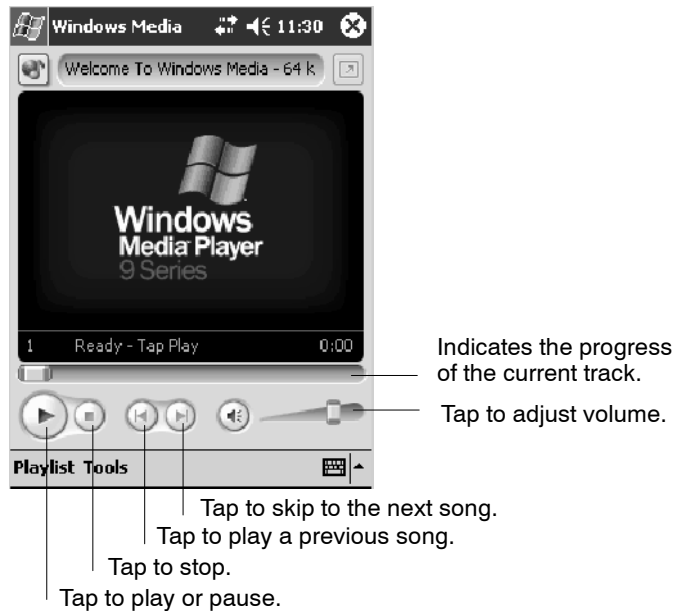

For more information about using Windows Media Player for Windows Mobile, tap **Start > Help > Windows Media Player** to see *Windows Media Player Help*.

Microsoft Reader

Use Microsoft Reader to read eBooks on your 700 Color Computer. Download books to your desktop from your favorite eBook Web site. Then, use ActiveSync to copy the book files to your activated 700 Color Computer. The books appear in the Reader Library, where you can tap them in the list to open them. Each book consists of a cover page, an optional table of contents, and the pages of the book. You can:

- Page through the book by using the Up/Down control on your 700 Color Computer or by tapping the page number on each page.
- Annotate the book with highlighting, bookmarks, notes, and drawings.
- Search for text and look up definitions for words.

The Guidebook contains all the information needed to use the software. To open the Guidebook, tap **Help** on the Reader command bar. Or, on a book page, tap and hold on the book title, and then tap **Help** on the pop-up menu.



Microsoft
Reader

To switch to Microsoft Reader, tap **Start > Programs > Microsoft Reader**.

Getting Books on Your 700 Color Computer

You can download book files from the Web. Just visit your favorite eBook retailer and follow the instructions to download the book files.

Sample books and a dictionary are also included in the MSReader folder in the Extras folder on the *Windows Mobile Companion CD*.

Use ActiveSync to download the files from your desktop to your activated mobile computer as described in the *Read Me* file in the MSReader folder.

Using the Library

The Library is your Reader home page; it displays a list of all books stored on your 700 Color Computer or storage card. To open the Library:

- 1 On the Reader command bar, tap **Library**.
- 2 On a book page, tap the book title, then tap **Library** on the pop-up menu.
- 3 To open a book, tap its title in the Library list.

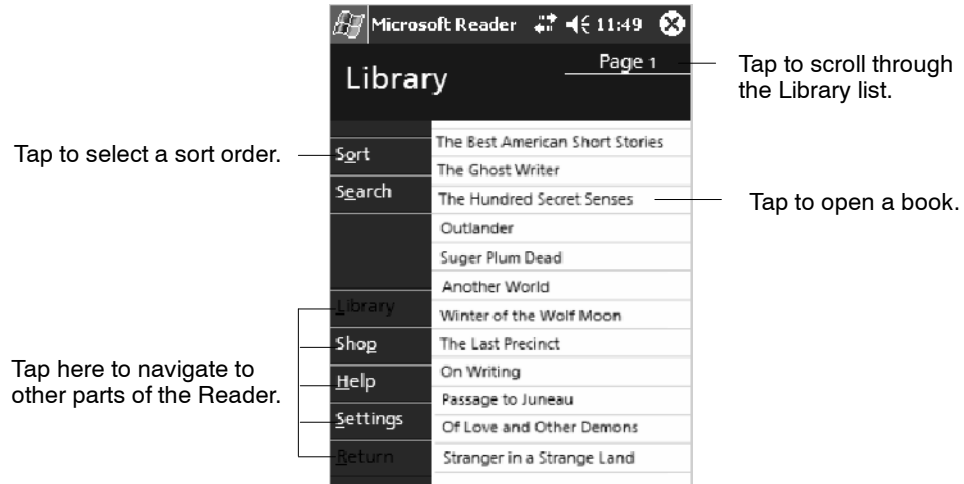

Reading a Book

Each book consists of a cover page, an optional table of contents, and the pages of the book. Navigation options are listed in the bottom portion of the cover page.

The first time you open a book, go to the first page or to the table of contents, if there is one. Subsequently, whenever you open the book, you are automatically taken to the last page read.

In addition to the text, each book page includes a page number and book title.

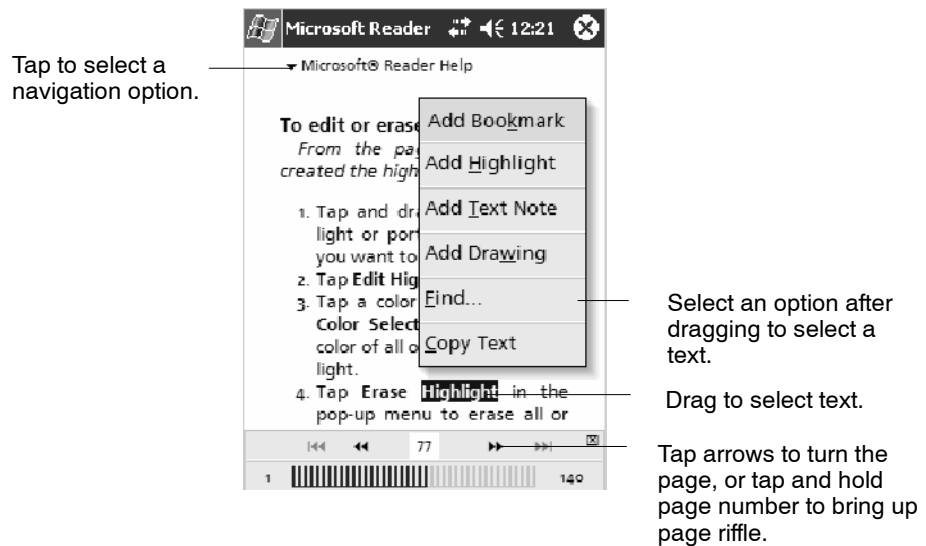

You can also page through a book by using the Up/Down/Left/Right controls on your 700 Color Computer.

Using Reader Features

Reading a book electronically gives you several options not available with paper books. These options are available from any book page.

Select text by dragging across the text on the page. Then, tap an option on the pop-up menu, as described here:

- **Searching for Text**
Find text in a book by tapping **Find** on the pop-up menu. Enter the word you want to search for, and tap the desired **Find** option. Reader highlights found text on the page. To close **Find**, tap outside the box. To return to your original page, tap the title and then tap **Return** on the pop-up menu.
- **Copying Text**
You can copy text from books that support this feature into any program that accepts text. On a book page, select the text you want to copy. Then, tap **Copy Text** on the pop-up menu. The text can be pasted into the program of your choice.
- **Adding Bookmarks**
When you add a bookmark to a book, a color-coded bookmark icon appears in the right margin. You can add multiple bookmarks to a book. Then, from anywhere in the book, tap the bookmark icon to go to the bookmarked page.
- **Highlighting Text**
When you highlight text, it appears with a colored background.
- **Attaching Notes to Text**
When you attach a note to text, you enter the text in a notepad that appears on top of the book page. A **Note** icon displays in the left margin. To show or hide the note, tap the icon.
- **Adding Drawings**
When you add a drawing, a **Drawing** icon appears in the bottom-left corner of the page, and drawing tools appear across the bottom of the page. Draw by dragging your stylus.
- **Annotations Index**
To see a list of a book's annotations, including bookmarks, highlights, text notes, and drawings, tap **Annotations Index** on the book's cover page. You can tap an entry in the list to go to the annotated page.

Removing a Book

When you finish reading a book, you can delete it to conserve space on your 700 Color Computer. If a copy of the book is stored on your desktop, you can download it again at any time.

To remove a book from your 700 Color Computer, tap and hold the title in the Library list, and then tap **Delete** on the pop-up menu.

Pocket Internet Explorer

Use Microsoft Pocket Internet Explorer to view Web or WAP pages in either of these ways:

- During synchronization with your desktop, download your favorite links and mobile favorites that are stored in the Mobile Favorites subfolder in Internet Explorer on the desktop.
- Connect to an ISP or network and browse the Web. To do this, create the connection first, as described in “*Getting Connected*” on page 98.

When connected to an ISP or network, you can also download files and programs from the Internet or intranet.

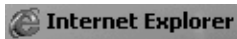

To switch to Pocket Internet Explorer on your 700 Color Computer, tap **Start > Internet Explorer**.

The Mobile Favorites Folder

Only items stored in the Mobile Favorites subfolder in the Favorites folder in Internet Explorer on your desktop are synchronized with your 700 Color Computer. This folder was created automatically when you installed ActiveSync.

Favorite Links

During synchronization, the list of favorite links in the Mobile Favorites folder on your desktop is synchronized with Pocket Internet Explorer on your 700 Color Computer. Both computers are updated with changes made to either list each time you synchronize. Unless you mark the favorite link as a mobile favorite, only the link is downloaded to your 700 Color Computer. Connect to your ISP or network to view the content.

- 1 In ActiveSync on your desktop, click **Tools > Options**, and select “Favorites” from the **Mobile Device** list. For more information on using ActiveSync, see *ActiveSync Help* on the desktop.
- 2 In Internet Explorer on your desktop, save or move favorite links to the Mobile Favorites subfolder in the Favorites list via **Favorites > Organize Favorites**. For more information on using Internet Explorer, see *Internet Explorer Help* on the desktop.
- 3 Connect your 700 Color Computer to your desktop. If synchronization does not start automatically, in ActiveSync on your desktop, click **Sync**.

Mobile Favorites

If you are using Microsoft Internet Explorer 5.0 or later on your desktop, you can download mobile favorites to your 700 Color Computer. Synchronizing mobile favorites downloads Web content to your 700 Color Computer so that you can view pages while you are disconnected from your ISP and desktop.

Use the Internet Explorer plug-in installed with ActiveSync to create mobile favorites quickly. To create a mobile favorite:

- 1 In ActiveSync on your desktop, click **Tools > Options**, and select “Favorites” from the **Mobile Device** list. For more information on using ActiveSync, see *ActiveSync Help* on the desktop.
- 2 In Internet Explorer 5.0 or greater on your desktop, browse to the page you want to view offline, then click **Tools > Create Mobile Favorite**.
- 3 To change the link name, enter a new name in the **Name** box.
- 4 In the **Update** box, select a desired update schedule to keep the page in the Mobile Favorites folder up to date. You can also update content by clicking **Tools > Synchronize** in Internet Explorer.
- 5 To save the link in a subfolder of Mobile Favorites, click **Create In** and select the desired subfolder.
- 6 Click **OK**. Internet Explorer downloads the latest version of the page to your desktop.
- 7 To download the pages that are linked to the mobile favorite you just created, in Internet Explorer on the desktop, right-click the mobile favorite, then click **Properties**. On the **Download** tab, specify the number of links deep you want to download. *To conserve 700 Color Computer memory, go only one level deep.*
- 8 Connect your 700 Color Computer to your desktop. If synchronization between your 700 Color Computer and desktop does not start, in ActiveSync on your desktop, click **Sync**.

Mobile favorites take up storage memory on your 700 Color Computer. To minimize the amount of memory used:

- In the settings for the Favorites information, type in ActiveSync options, turn off pictures and sounds, or stop some mobile favorites from being downloaded to the 700 Color Computer. For more information, see *ActiveSync Help*.
- Limit the number of downloaded linked pages. In Internet Explorer on the desktop, right-click the mobile favorite you want to change and then **Properties**. In the **Download** tab, specify “0” or “1” for the number of linked pages you want to download.

Using AvantGo Channels

AvantGo is a free interactive service that gives you access to personalized content and thousands of popular Web sites. You subscribe to AvantGo channels directly from your 700 Color Computer. Then, you synchronize your 700 Color Computer and desktop, or connect to the Internet to download the content. For more information, visit the AvantGo Web site. To synchronize an AvantGo channel:



- 1 In Pocket Internet Explorer on your 700 Color Computer, tap  to display your list of favorites.
- 2 Tap the **AvantGo Channels** link.
- 3 Tap **Activate**.
- 4 Follow the directions on the screen. Synchronize your 700 Series Computer with your desktop, then tap **My Channels** to complete the AvantGo setup.
- 5 When synchronization is complete, tap the **AvantGo Channels** link in your list of favorites to see a few of the most popular channels.

To add or remove channels, tap the **Add** or **Remove** link.

Using Pocket Internet Explorer

You can use Pocket Internet Explorer to browse mobile favorites and channels that were downloaded to your 700 Color Computer without connecting to the Internet. You can also connect to the Internet through an ISP or a network connection and browse the Web.



 Favorites button
 Home button
 Refresh button

Viewing Mobile Favorites and Channels

- 1 Tap the Favorites button to display your list of favorites.
- 2 Tap the page you want to view.



Tap the favorite you want to view.

Tap to add or delete a folder or favorite link.

The page that was downloaded the last time you synchronized with your desktop opens. If the page is not on your 700 Color Computer, the favorite is dimmed. Synchronize with your desktop again to download the page to your 700 Color Computer, or connect to the Internet to view the page.

Browsing the Internet

- 1 Set up a connection to your ISP or corporate network using **Connections**, as described in “*Getting Connected*” on page 98.
- 2 To connect and start browsing, do one of the following:
 - Tap the **Favorites** button, and then tap the favorite you want to view.
 - Tap **View > Address Bar**. In the address bar that appears at the top of the screen, enter the Web address you want to visit and then tap **Go**. Tap the arrow to choose from previously entered addresses.



Note: To add a favorite link while using the 700 Color Computer, go to the page you want to add, tap and hold on the page, and tap **Add to Favorites**.

Getting Connected

You can set up connections to the Internet and corporate network at work to do such activities as browsing the Internet or intranet, sending and receiving e-mail and instant messages, and synchronizing information using ActiveSync.

Connections can be made using a modem, wireless network, or network (Ethernet) card. You can use a modem connection to set up connections with an external modem, or through your mobile phone network using a cellular line or GPRS.

Your 700 Color Computer has two groups of connection settings: My ISP and My Work Network. My ISP settings connect to the Internet, and My Work Network settings connect to any private network, such as a corporate network you use at work.

- My ISP. Once connected, you can send and receive e-mail messages by using Inbox and view Web or WAP pages by using Pocket Internet Explorer. The communication software for creating an ISP connection is already installed on your 700 Color Computer. Your service provider provides the software needed to install other services, such as paging and fax services. If this is the method you want to use, see “*Connecting to an Internet Service Provider*” on page 98.
- My Work Network: Connect to the network at your company or organization where you work. Once connected, you can send and receive e-mail messages by using Inbox, view Web or WAP pages by using Pocket Internet Explorer, and synchronize with your desktop. If this is the method you want to use, see “*Connecting to Work*” on page 104.

Connecting to an Internet Service Provider

You can connect to your ISP, and use the connection to send and receive e-mail messages and view Web or WAP pages. You can connect to your ISP in one of two ways:

- Create a modem connection. If this is the method you want to use, see “*Creating a Modem Connection to an ISP*” below.
- Use an Ethernet card and a net tap to connect to the network. If this is the method you want to use, see “*Creating an Ethernet Connection to an ISP*” on page 103. *Note: This does not apply to the 730 Computer.*

Creating a Modem Connection to an ISP

Obtain the following information from your ISP. Some ISPs require information in front of the user name, such as MSN/username.

- ISP dial-up access telephone number
- User name
- Password

If you do not have a built-in modem, install a modem card, or use a NULL modem cable and appropriate adapters to connect an external modem to your 700 Color Computer through the serial port.



To view additional information for any screen in the wizard or while changing settings, tap the **Help** icon.



Connections

- 1 Tap **Start** > **Settings** > the **Connections** tab > the **Connections** icon. In **My ISP**, tap **Add a new modem connection**.

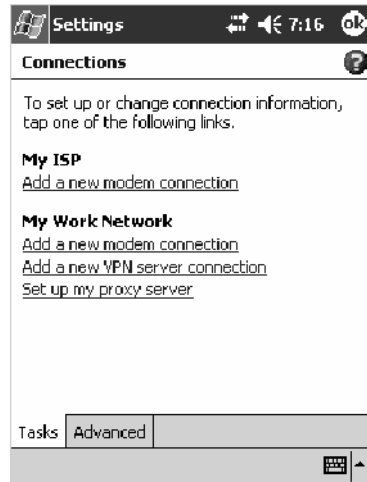

- 2 Enter a name for the connection, such as “ISP Connection.”

In the **Select a modem** list, select your modem type. If your modem type does not appear, try reinserting the modem card. If you are using an external modem that is connected to your 700 Color Computer with a cable, select “Hayes Compatible on COM1.” Tap **Next** to continue.

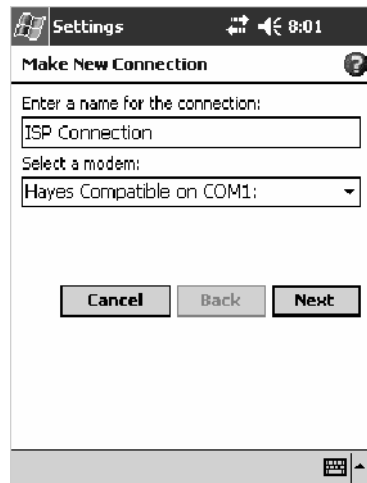

- 3 Enter the access phone number, then tap Next.

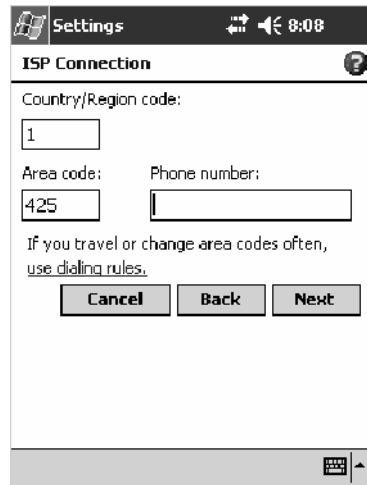

- 4 Enter the user name, password, and domain (if provided by an ISP or your network administrator).

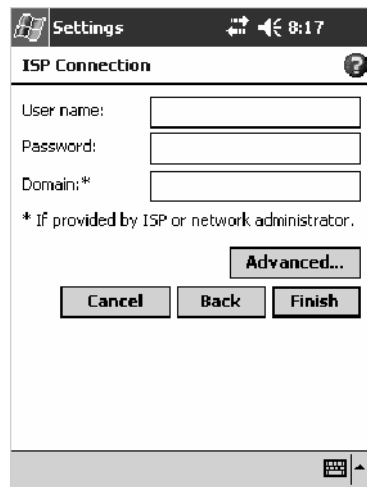

- 5 You should not need to change any settings in **Advanced**. Most ISPs now use a dynamically-assigned address. If the ISP you are connecting to does not use a dynamically-assigned address, tap **Advanced** > the **TCP/IP** tab, tap **Use specific IP address**, then enter the address. Tap **ok** to close the Advanced page, then tap **Finish**.

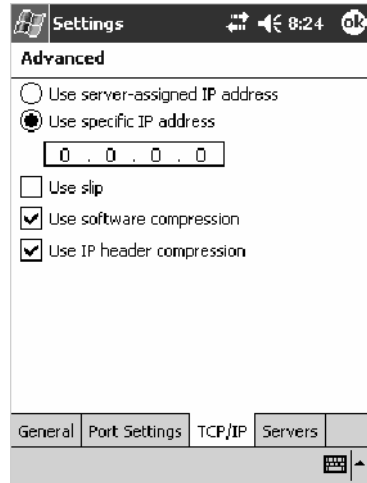

- 6 Tap the **Advanced** tab, then tap **Select Location** to specify your current location. These settings apply to all connections. Tap **Edit** to continue.

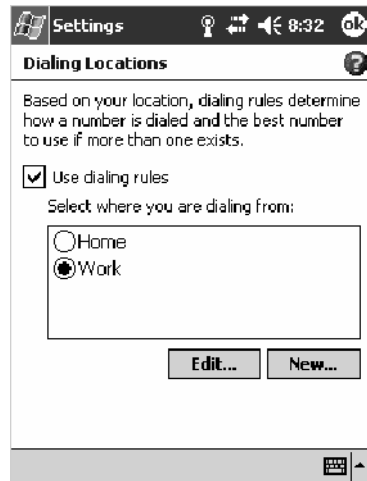

- 7 Specify your current phone type. If your phone type is pulse dialing, check the **Pulse dialing** box. If your type is tone dialing (as most phone lines are), then clear the **Pulse dialing** box. Continue to tap **ok** to close each page and return to the Settings page.

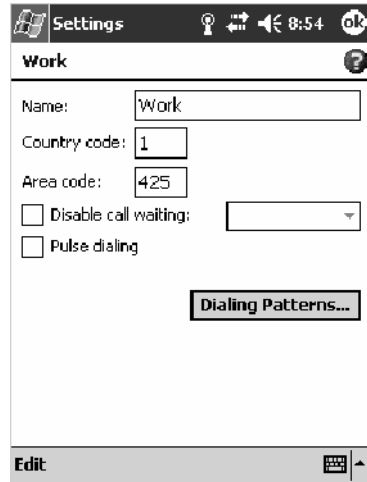

To start the connection, start using one of the following programs. Once connected, you can:

- Send and receive e-mail messages by using Inbox. Before you can use Inbox, you need to provide the information it needs to communicate with the e-mail server. For specific instructions, see “*Connecting Directly to an E-mail Server*” on page 114.
- Visit Web and WAP pages by using Pocket Internet Explorer. For more information, see “*Pocket Internet Explorer*” on page 94.
- Send and receive instant messages with MSN Messenger. For more information, see “*MSN Messenger*” on page 84.



Note: To change modem connection settings in My ISP, tap **Manage existing connections**. Select the desired modem connection, tap **Settings**, and follow the instructions on the screen.

Creating an Ethernet Connection to an ISP



Note: This information does *not* apply to the 730 Computer.

You do not need to create a new connection on your 700 Color Computer. Instead, you must purchase a dock to enable on-board Ethernet.



- 1 Obtain your user name, password, and domain name from your ISP.
- 2 Place your 700 Color Computer in a dock, tap **Start** > **Today**, then look in the System Tray for the Ethernet icon (*shown left*). If not there, then tap the antenna icon for the NDISTRAY pop-up menu and select **Built-in Ethernet** from the menu.

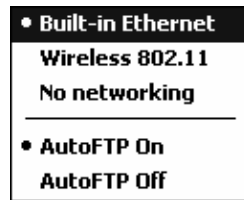

Connections

- 3 *If using an on-board Ethernet*, then tap **Start** > **Settings** > the **Connections** tab > **Connections** > the **Advanced** tab > **Network Card**. Tap “LAN9000” from the list of adapters installed to access and configure its properties.

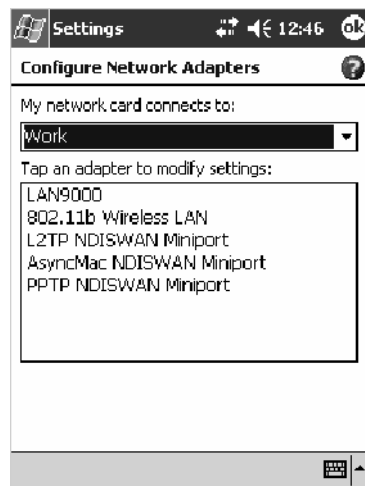

- 4 Connect the dock to the network by using a network cable. For information, see your owner’s manual.

- 5 Tap **ok** three times to return to the Connections page. Select “The Internet” from the **My network card connects to** drop-down list.

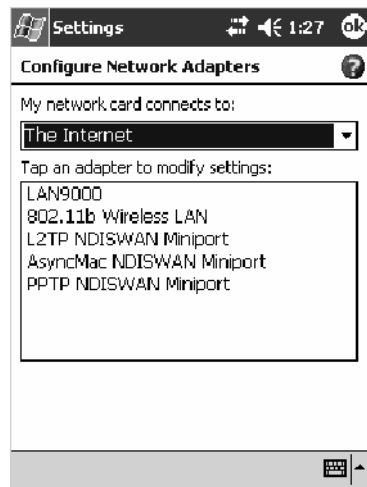

To start the connection, simply start using one of the programs listed in the preceding section. Once connected, you can perform the same activities as listed in the preceding section.

Connecting to Work

If you have access to a network at work, you can send e-mail messages, view intranet pages, synchronize your 700 Color Computer, and possibly access the Internet. You can connect to work in one of two ways:

- Create a modem connection by using a RAS (Remote Access Server) account. Before you can create this modem connection, your network administrator needs to set up a RAS account for you. If this is the method you want to use, see “*Creating a Modem Connection to Work*” below. Your network administrator may also give you Virtual Private Network (VPN) settings.
- *Note: This does not apply to the 730 Computer.* Use an embedded Ethernet card and a net tap to connect to the network. To use this method, see “*Creating an Ethernet Connection to Work*” on page 113.

Before you can create this modem connection, your network administrator needs to set up a RAS account for you. Your network administrator may also give you VPN settings.

Get the following information from your network administrator.

- Dial-up access telephone number
- User name
- Password

If your 700 Color Computer does not have access to a mobile phone network, insert a modem card.

**Connections**

Tap **Start** > **Settings** > the **Connections** tab > the **Connections** icon. In **My Work Network**, set up a modem connection via work (*page 106*), wireless network (*page 108*), or VPN server (*page 111*).

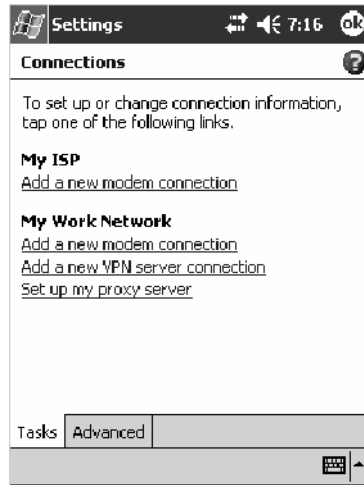

Note: To change modem connection settings in My Work Network, tap **Manage existing connections**. Select the desired modem connection, tap **Settings**, and follow the instructions on the screen.



To view additional information for any screen in the wizard or while changing settings, tap the **Help** icon.

Creating a Modem Connection to Work

- 1 Enter a name for the connection, such as “Company Connection.” In the **Select a modem** list, select your modem type. If your modem type does not appear, try reinserting the modem card.
 - If you are using an external modem connected to your 700 Color Computer with a cable, select “Hayes Compatible on COM1.”
 - If you are using any type of external modem, select the modem by name. If a listing does not exist for your external modem, select “Hayes Compatible on COM1.”
 - Wireless connections can be made via a mobile phone network or GPRS. If you are using a mobile phone network to connect, select “Cellular Line.” If you are using GPRS, tap “Cellular Line (GPRS).”

Tap **Next** to continue.

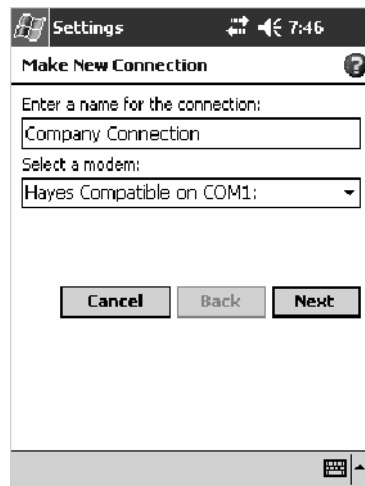

- 2 Enter the access phone number, using some of the following guidelines. If you know part of the phone number changes frequently as you travel, create dialing rules to avoid creating numerous modem connections for the same phone number. For more information, tap **Use Dialing Rules**.
 - Enter the phone number exactly as you want it dialed. For example, if you call from a business complex or hotel that requires a nine before dialing out, enter “9” in front of the phone number.
 - Enter the APN provided by your mobile phone service provider.
 - When using dialing rules, phone numbers are entered differently. To use additional numbers, such as a “9” to dial from an office complex or hotel, you must use additional dialing rules or change dialing patterns. See “*Create Dialing Rules*” via your online help for information.
 - a In the **Country/Region** box, enter the appropriate code when dialing internationally. For more information, contact an operator at your local phone company.
 - b In the **Area code** box, enter the area code. Area codes are not needed in all countries.

- c In the **Phone number** box, enter the main phone number.

Tap **Next** to continue.

Settings 11:14

Company Connection

Country/Region code:

Area code: Phone number:

If you travel or change area codes often, use dialing rules.

Cancel **Back** **Next**

- 3 Enter the user name, password, and domain (if provided by an ISP or your network administrator). If a domain name was not provided, try the connection without entering a domain name.

Settings 11:17

Company Connection

User name:

Password:

Domain:*

* If provided by ISP or network administrator.

Advanced...

Cancel **Back** **Finish**

- 4 You should not need to change any advanced settings. Instances where you are to change advanced settings include the following. To change advanced settings, tap **Advanced**. Otherwise, tap **Finish**.
 - You want to change baud rate settings, dialing string commands, or credit card options.
 - You need to change port settings.
 - The server you are connecting to does not use dynamically-assigned addresses, and you need to enter your TCP/IP settings.

Creating a Wireless Network Connection to Work

Networks that you have already configured are preferred networks and are listed in Wireless networks. You can select to connect to only preferred networks or have your device search for and connect to any available network whether it is preferred.

A wireless network can be added either when the network is detected, or manually by entering settings information. To determine if authentication information is needed, see your network administrator.



- 1 Tap **Start > Settings > the Connections tab > Connections > the Advanced tab > Network Card > the Wireless tab > Add New Settings.**

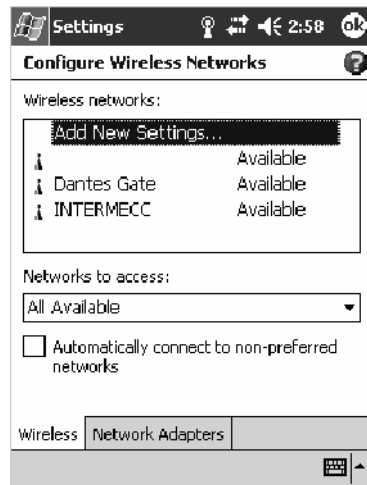

- 2 Tap the **General** tab, then enter a network name. If the network was detected, the network name is automatically entered and cannot be changed.

From **Connects to**, select to what your network is to connect: “Work” or “The Internet.”

To connect to an ad-hoc connection, select **This is a device-to-computer (ad-hoc) connection**.

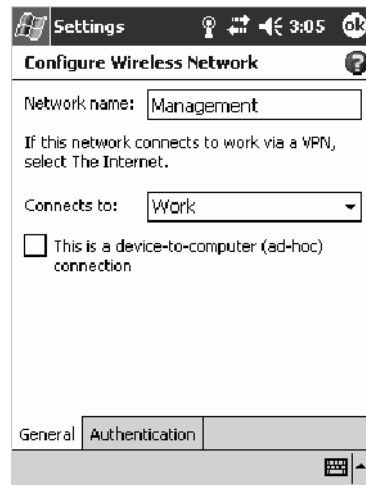

- 3 Tap the **Authentication** tab, then do the following:
- To use data encryption, tap **Data encryption (WEP Enabled)**.
 - To use Shared Key authentication, tap **Network Authentication (Shared mode)**. Be sure to have a network key.
 - To automatically use a network key, tap **The Key is provided for me automatically**. Otherwise, enter the network key.
 - For increased security, select **Enable network access using IEEE 802.1X**. Then, select the appropriate EAP type.

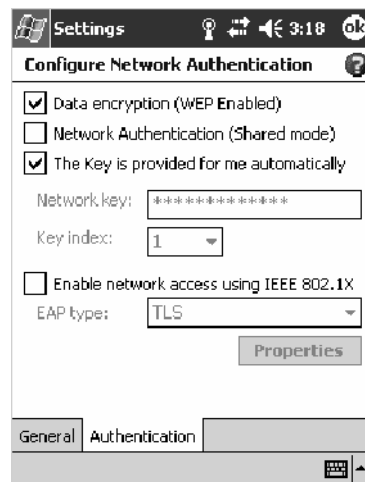

- 4 Tap **ok** to return to the Configure Wireless Network screen.
- 5 From the **Networks to access** drop-down list, select “All Available,” “Only access points,” or “Only computer-to-computer” depending on the type of networks to which you connect.
- 6 To connect only to networks you have already configured, clear **Automatically connect to non-preferred networks**.
- 7 Tap **ok** to close this screen.

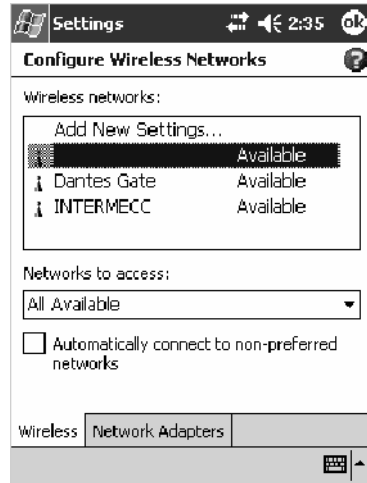

Note: If you select to automatically connect to non-preferred networks, your device detects any new networks and provide you the opportunity to configure them.

Creating a VPN Server Connection to Work

A VPN connection helps you to securely connect to servers, such as a corporate network, via the Internet. Ask your network administrator for a user name, password, domain name, TCP/IP settings, and host name or IP address of the VPN server.



To view additional information for any screen in the wizard or while changing settings, tap the **Help** icon.



Note: To change existing settings in My Work Network, tap **Manage existing connections** > the **VPN** tab. Select the desired VPN connection, tap **Settings**, and follow the instructions on the screen.

1 In **Name**, enter a name for the connection, such as a company's name.

In **Host name/ IP**, enter the VPN server name or IP address.

Next to **VPN type**, select the type of authentication to use with your device: "IPSec/L2TP" or "PPTP." If you are not sure which option to choose, ask your network administrator.

Tap **Next** to continue.

The screenshot shows the 'Settings' application with the 'Make New Connection' screen. The title bar includes a Windows logo, the word 'Settings', and the time '11:49'. The screen has a header 'Make New Connection' with a help icon. Below the header are three input fields: 'Name:' with the text 'My VPN', 'Host name/ IP:' which is empty, and 'VPN type:' with two radio button options: 'IPSec/L2TP' (which is selected) and 'PPTP'. At the bottom of the screen are three buttons: 'Cancel', 'Back', and 'Next'. A small keyboard icon is visible in the bottom right corner of the screen.

- 2 Select the type of authentication. If you select **A pre-shared key**, enter the key provided by your network administrator.



- 3 Enter your user name, password, and domain name as provided by your ISP or network administrator. If a domain name was not provided, try the connection without entering a domain name.

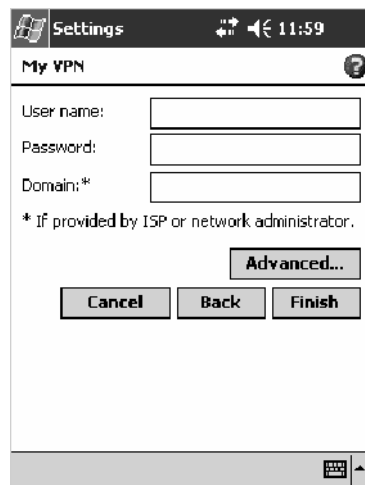

- 4 You should not need to change any **Advanced** settings. Instances where you must change advanced settings include:
 - The server to which you are connecting does not use dynamically-assigned addresses, and you need to enter your TCP/IP settings.
 - You need to change server DNS or WINS settings.

To change advanced settings, tap **Advanced**. Otherwise, tap **Finish**.

Insert necessary equipment, such as a network (Ethernet) card, into the device, and use a desired program to automatically begin connecting. For example, switch to Pocket Internet Explorer and browse to a Web page.

Creating an Ethernet Connection to Work



Note: This information does *not* apply to the 730 Computer.

You do not need to create a new connection on your 700 Color Computer. Instead, you must purchase a dock to enable on-board Ethernet. Obtain the user name, password, and domain name from your ISP.



- 1 If using an on-board Ethernet, place your 700 Color Computer in a dock, tap **Start** > **Today**, then look in the System Tray for the Ethernet icon (*shown left*). If not there, then tap the antenna icon for the NDISTRAY pop-up menu and select **Built-in Ethernet** from the menu.

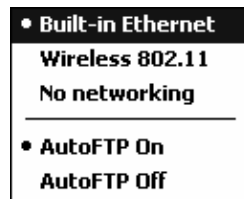

Connections

- 2 Tap **Start** > **Settings** > the **Connections** tab > **Connections** > the **Advanced** tab > **Network Card**. Tap “LAN9000” to configure properties.

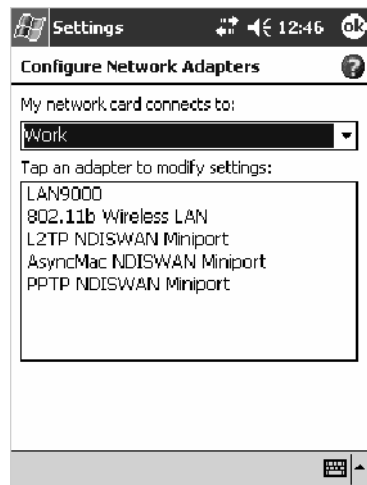

- 3 Connect the dock to the network by using a network cable. For information, see your owner’s manual.
- 4 To synchronize your 700 Color Computer, tap **Start** > **ActiveSync** to access Microsoft ActiveSync, then tap **Tools** > **Options** > the **PC** tab, check **Sync with this PC during manual sync**, and select your computer’s name from the **Use this PC** drop-down list.

Remote synchronization with a desktop works only if a partnership is set up with that computer through ActiveSync and ActiveSync is set to allow remote connections. Other restrictions apply. For more information, see *ActiveSync Help* on your desktop.

Use one of the programs listed in the preceding section to start a connection. Once connected, you can perform the activities listed previously.

Ending a Connection

To disconnect, do one of the following:



- When connected via modem or VPN, tap the **Connectivity** icon on the navigation bar, and then tap **Disconnect**.
- When connected via cable or cradle, detach your device.
- When connected via Infrared, move the device away from the other computer or device.
- When connected via a network (Ethernet) card, remove the card from your device. *Note this does not apply to 730 Computers.*
- When connected via a wireless network, switch off the connection.

Connecting Directly to an E-mail Server

You can set up a connection to an e-mail server so that you can send and receive e-mail messages by using a modem or network connection and Inbox on your 700 Color Computer.



Note: The ISP or network must use a POP3 or IMAP4 e-mail server and an SMTP gateway.

You can use multiple e-mail services to receive your messages. For each e-mail service you intend to use, first set up and name the e-mail service. If you use the same service to connect to different mailboxes, set up and name each mailbox connection.

Setting Up an E-mail Account



Do the following to set up an e-mail service. Tap the question mark at the top of the screen for more assistance.

- 1 On your 700 Color Computer, tap **Start > Inbox** to access the Inbox application. Tap **Accounts > New Account**.
- 2 Enter an e-mail address, tap **Next**, then tap **Next** again after the status of the automatic configuration is listed as “Completed.”

- 3 Enter your user name and password, then tap Next.

Inbox 1:16

E-mail Setup (3/5)

User information

Your name: Adam Barr

User name: Adam

Password: *****

Save password

Cancel Back Next

Edit X

- 4 Select the appropriate service type from the **Service type** drop-down list, either POP3 or IMAP4, or enter a new service type, then tap Next.

Inbox 1:16

E-mail Setup (4/5)

Account information

Account type: POP3

Name: POP3

Cancel Back Next

Edit X

- 5 In **Incoming mail**, enter the name of your e-mail server. In **Outgoing mail**, enter the name of your Simple Mail Transfer Protocol (SMTP) host. If you are using a network connection, enter your domain name in **Domain**. Tap **Options** to do additional configurations. Tap **Finish** to assign this service.

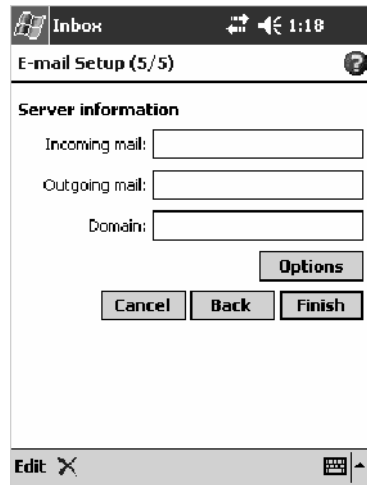

When finished, to connect to your e-mail server, from the Inbox application, tap **Services > Connect**. For more information on using the Inbox program, see “*Inbox: Sending and Receiving E-mail Messages*” on page 73.



3 Installing Applications

There are multiple ways to get an application to your 700 Series Color Mobile Computer; just as there are multiple ways to package the application for delivery.

Packaging an Application

Use any of these methods to package an application for installation:

- For very simple applications, the application itself might be the only file that needs to be delivered.
- It could be a directory structure that contains the application, supporting files like ActiveX controls, DLLs, images, sound files, and data files.
- Or, you could package an application via a CAB file.

Consider any of the following when choosing a location into which to store your application:

- In the basic 700 Color Computer, there are two built-in storage options: the Object Store and the Persistent Storage Manager (PSM). The Object Store is RAM that looks like a disk. Anything copied here is deleted when a cold-boot is performed on the 700 Color Computer. The PSM is an area of storage which is embedded in a section of the system's FLASH memory. This storage area is *not* erased during a cold-boot. It may, however, be erased during the reflashing process. In addition to storing applications and data files, you do have the option to store a persistent registry to the PSM region.
- If the optional Secure Digital or CompactFlash storage card is in the system, then consider this card the primary location for placing an applications install files. The following folders represent either card:
 - The Secure Digital storage card creates the “\SDMMC Disk” folder.
 - The CompactFlash storage card creates the “\Storage Card” folder.



Note: The 730 Mobile Computer does *not* support the Compact Flash storage card.

- Use the small non-volatile Flash File Store region to hold CAB files that rebuild the system at cold-boot or install applications from a CAB file *into* the Flash File Store so they are “ready-to-run” when a cold-boot is performed. Since the FLASH in the system has a limited number of write cycles, do not use the Flash File Store for excessive writing purposes; however, reading is okay.

Files copied to any of these locations are safe when a cold-boot is performed on a 700 Color Computer — *providing the AutoRun system is installed in the appropriate location*. You can find this system in the 700 Color Management Tools portion of the *Intermec Developer's Library CD*. Copying a CAB file to the “\CABFILES” folder on one of these cards automatically extracts that CAB file on every cold-boot to ensure that your system is properly set up (see page 124).

Installing Applications

Consider any of the following options to get the package to the preferred location on your 700 Series Computer.

- Microsoft ActiveSync
- FTP Server (*page 120*)
- Secure Digital or CompactFlash storage cards (*page 120*)

Using Microsoft ActiveSync



Note: These instructions assume the 700 Color Management Tools portion of the *Intermec Developer's Library CD* was installed on your desktop.

The Microsoft ActiveSync tool is located on the *700 Color Companion CD*. See Chapter 2, “*Windows Mobile 2003*,” for information about this tool as provided by Microsoft Corporation.

This can be a serial, USB, Ethernet, InfraRed, or 802.11b ActiveSync connection. Files can be copied using File Explorer on a desktop or a laptop computer. This is usually good when updating few 700 Color Computers.



Note: The 730 Computer does *not* support Ethernet.

These instructions assume that Microsoft ActiveSync was installed onto your desktop and is up and running. If not, go to Chapter 2, “*Windows Mobile 2003*,” for an URL from which to download the latest application.

- 1 Connect your 700 Color Computer to your desktop computer via an ActiveSync cable or IrDA.
- 2 Wait for a “Connected” message to appear in the Microsoft ActiveSync application to signal a connection to the 700 Series Computer. If necessary, select **File > Get Connected** to initiate a connection.

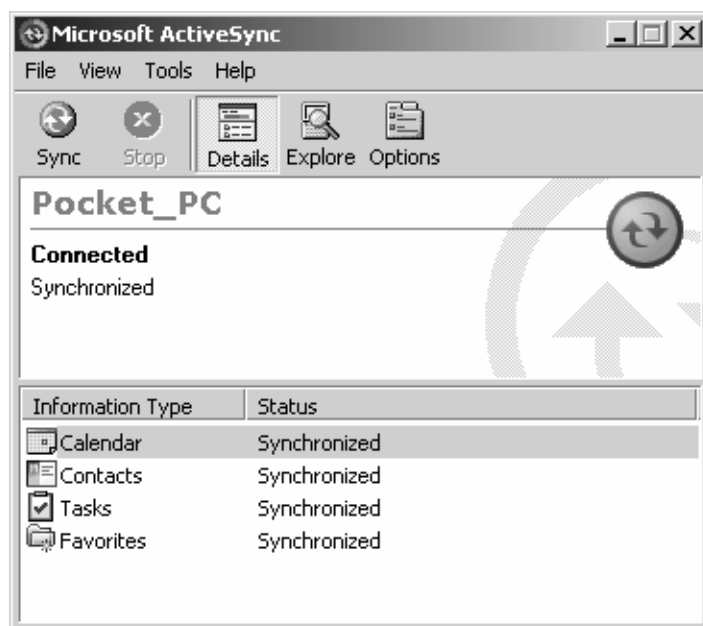



- 3 Click **Explore** to access the Mobile Device folder on your unit.
- 4 From your desktop, select **Start > Windows Explorer**, then browse the “C:\Intermec\700C Mgmt Tools\CabFiles” path for any CAB files needed for your 700 Color Computer. Select the appropriate file, right-click the file for a pop-up menu, then select **Copy**.
- 5 Within the Mobile Device directory, go to the directory where you want the files located on the 700 Color Computer, do a right-click for a pop-up menu, then select **Paste**.
- 6 When all of the files are pasted, perform a warm-boot on the 700 Color Computer. When the computer reboots, wait for the LED on the top left of your keypad to stop blinking. Tap **Start > Programs > File Explorer** to locate the newly copied executable files, then tap these files to activate their utilities.

Using the FTP Server

The 700 Color Computer has a built-in FTP Server that connects to a network via Ethernet, 802.11b, or WAN (Wireless Access Network). This allows connections to the 700 Color Computer to perform file transfers or computer management functions. Another benefit is you can create FTP scripts to automate the process of copying files to the 700 Color Computer. This option is good for when a large number of 700 Color Computers need updating. See Chapter 7, “Programming,” for more information.

Using a Storage Card

Use the following steps to install an application using a storage card:

Copying to a CompactFlash Card



Note: These instructions do *not* apply to the 730 Computer.

- 1 Suspend the 700 Color Computer and remove its CompactFlash drive, which holds a SanDisk CompactFlash storage card.
- 2 Using a CompactFlash Adapter card, place the CompactFlash drive in your desktop PC card drive.
- 3 Create a subdirectory on the PCMCIA CompactFlash drive in which to store your application.
- 4 Use the CEImager application to add the autorun system to the storage card. See the *Software Tools User’s Manual* to learn about CEImager.
- 5 Copy your application, data files, and all required DLLs and drivers to the subdirectory created on the CompactFlash drive.
- 6 Add your application to the AUTOUSER.DAT file on the “\Storage Card\2577” directory with the following statement:

```
RUN=\<your directory>\<yourapp.exe>
```

 where *your directory* is the directory on the CompactFlash storage card where the application was installed, and *yourapp.exe* is the name of your application. Finish the “RUN=” statement with a carriage return line-feed combination. There may be multiple run statements in the file.

- 7 Remove the CompactFlash card from your desktop and reinstall it into the 700 Color Computer.
- 8 Warm-boot the 700 Color Computer to add these files to the CompactFlash storage card.

If the AUTOUSER.DAT file is found and the “RUN=” statement is correct, the task manager launches and executes your program on startup.

Copying to a Secure Digital Storage Card

- 1 Suspend the 700 Color Computer and remove its Secure Digital drive, which holds a Secure Digital storage card.
- 2 Using a Secure Digital Adapter card, place the Secure Digital drive in your desktop PC card drive.
- 3 Create a subdirectory on the PCMCIA Secure Digital drive in which to store your application.
- 4 Use the CEImager application to add the autorun system to the storage card. See the *Software Tools User's Manual* to learn about CEImager.
- 5 Copy your application, data files, and all required DLLs and drivers to the subdirectory created on the Secure Digital drive.
- 6 Add your application to the AUTOUSER.DAT file on the “\SDMMC Disk\2577” directory with the following statement:

```
RUN=\<your directory>\<yourapp.exe>
```

 where *your directory* is the directory on the Secure Digital storage card where the application was installed, and *yourapp.exe* is the name of your application. Finish the “RUN=” statement with a carriage return line-feed combination. There may be multiple run statements in the file.
- 7 Remove the Secure Digital card from your desktop and reinstall it into the 700 Color Computer.
- 8 Warm-boot the 700 Color Computer to add these files to the Secure Digital storage card.

If the AUTOUSER.DAT file is found and the “RUN=” statement is correct, the task manager launches and executes your program on startup.

Updating the System Software

You can use the *Intermec Developer's Library CD* to reinstall or update the operating system software on the 700 Color Computer. For more information, contact your Intermec representative.

Application Migration



Note: These instructions assume that the 700 Color Management Tools portion of the *Intermec Developer's Library CD* was installed on your desktop and that a storage card was added to the base configuration of the 700 Color Computer.

Do the following *required* steps to ensure that CAB files are restored, applications automatically start, and registry is restored on cold-boot:



- 1 From your desktop, double-click the **Intermec CE Imager** desktop icon to access the Intermec CEImager application. If this icon is not on your desktop, then double-click the CEIMAGER.EXE executable from the “C:\Intermec\700C Mgmt Tools\Tools\CEImager” folder.
- 2 Click **Default** under **Components List** to activate the components.
- 3 Click (+) to expand the **AutoRun System** component, click (+) to expand the **Destination Media** option, then select *either* the **CompactFlash Card** option or the **Secure Digital Card** option. *Do not select both storage cards, as the AutoRun files copied will work for one storage card, but not work on the other storage card.*



Note: The 730 Computer does *not* support CompactFlash storage cards.

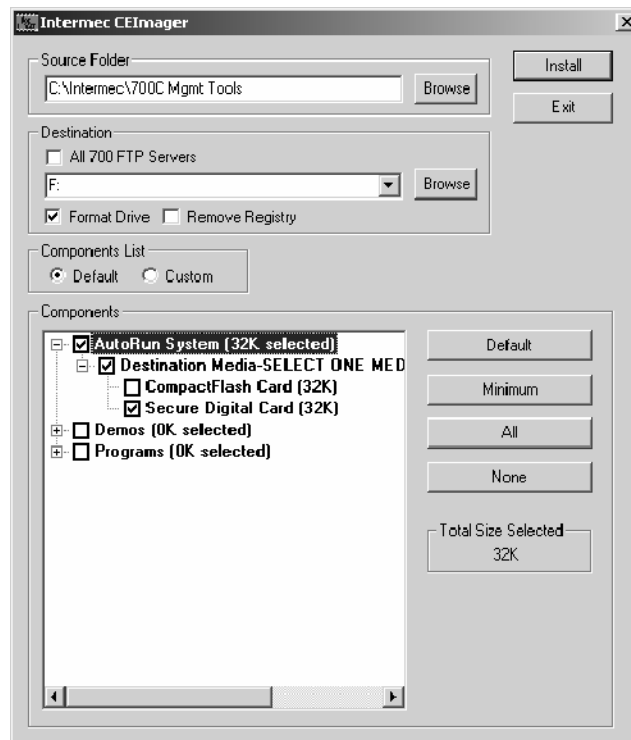

- 4 Click **Install** to install the AUTORUN files onto the storage card.
- 5 Create a “\CabFiles” folder on the storage card. Copy any CAB files that are to be extracted on every startup into this folder.

- 6 In the “\2577” directory, add your custom AUTOUSER.DAT file. See the *Recovery Help* for more information on how to set up an AUTOUSER.DAT file.
- 7 If you are using the RegFlushKey() API, the application must use a special API to make sure the registry is written to the appropriate card; or you can use the **Utilities** control panel applet, as follows. See Appendix A, “Configurable Settings,” for more information about this applet.



Utilities

- a From the 700 Series Computer, tap **Start > Settings > the System tab > the Utilities icon > the Registry Save tab**.
- b Tap **Enable Registry Storage** to save the registry in the Flash File System (PSM) via the “\Flash_File_Store\Registry” path.
- c Tap **ok** to save your entry and exit the **Utilities** control panel applet.

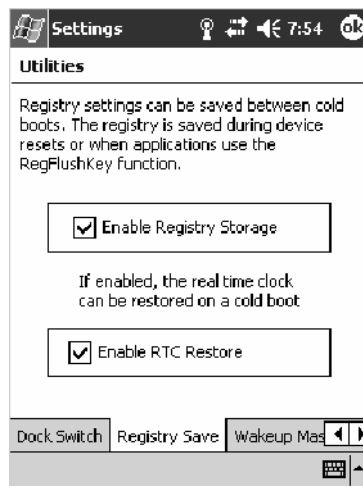

- 8 Remove the storage card from the desktop PC and install the card into the 700 Color Computer.
- 9 Perform a cold-boot on the 700 Color Computer. Files automatically install from the storage card upon reboot. Any calls to the RegFlushKey() API automatically writes the registry to the appropriate location.

Migrating from a 700 Monochrome Computer

As you migrate from a 700 Monochrome Computer to a 700 Color Computer, you need to consider the following: When converting a 700 Monochrome Computer application to run on the 700 Color Computer, most APIs should work without changes. Below are a few exceptions:

- The 700 Monochrome Computer uses the “\Storage Card” folder for nonvolatile storage. You may need to change the application to store data onto the “SDMMC Disk” folder instead of the “\Storage Card” folder if a Secure Digital storage card is present in the system.
- If the application uses the RegFlushKey() API, it must first verify that the proper media is available in the system and call the special API mentioned in Step 7 on the previous page.
- If the application is using the 700 Color switchable dock, use the IOCTL_DOCK_SWITCH value from the IOCTL_HAL_ITC_WRITE_SYSPARM function to set the proper port on the dock before communications. See more information about this KernelIOControl function in Chapter 7, “Programming.”
- Some WAN radio options have changed. Review the WAN radio information in Chapter 4, “Network Support,” to determine if any changes are required in your application.
- Arrow and tab keys are reversed from the 700 Monochrome Computer. Keyboard remapping is available on the 700 Color Computer should you need to map these keys like that of the 700 Monochrome Computer (see page 121).
- Special SDKs are not needed to compile applications for the Xscale processor. Targeting the SA1110 processor creates applications that run on the 700 Color Computer.

Cabinet File Installation

CAB files (*short form of “cabinet” files*) are compressed folders as defined by Microsoft. A “cabinet” file is a single file, usually suffixed with .CAB, that stores compressed files in a file library. A compressed file can be spread over several cabinet files. During installation, the setup application decompresses the files stored in a cabinet and copies them to the user’s system.

For the 700 Color Computer, CAB files register DLLs, create shortcuts, modify registry entries, and run custom setup programs. Tap a CAB file to extract that file or place the CAB file on one of the approved storage devices in the “\CabFiles” folder, then perform a warm-boot on the 700 Color Computer. There are two methods available to extract a CAB file:

- Tap a CAB file to extract it. With this method, the CAB file is automatically deleted when the extraction process is successful, *unless* the CAB file is set with the read-only attribute.
- Use the AUTOCAB method to extract all files when a cold-boot is performed on the 700 Color Computer. This method is on the *Intermec Developer’s Library CD*, see its *Software Tools User’s Manual* for information.



4 Network Support

The 700 Series Color Mobile Computer can integrate up to three radios in a single unit, and automatically installs the appropriate software for radio use when the unit is powered on.

The Intermec CORE (Common Object Resource Environment) application, which provides a framework for various modules that let you configure and manage your Intermec products, defaults to the most recently used module. If a module is not yet used or set, CORE defaults to the first module as listed alphabetically.

The following communication options on the 700 Series Computer provide wired and wireless connectivity:

- **Onboard wired Ethernet** (*standard on 700 Color Computers, not available on 730 Computers*)
- **Wireless Local Area Network** (*standard on 730 Computers*)
This 802.11b radio option provides up to 11 Mb/sec throughput.
- **Wireless Wide Area Network** (*not available on 730 Computers*)
Includes support for GSM/GPRS and CDMA/1xRTT radios.
- **Wireless Personal Area Network**
This allows for cable-free communications with peripheral devices, such as printers, over a ten-meter range. This compatibility is provided via a Bluetooth qualified module by Socket Communications.

CORE

The Intermec CORE application provides a framework for various modules that let you configure and manage your Intermec products. These modules are software plug-ins that can be configuration tools, such as the 802.11b radio configuration module, or they can provide information on your environment, such as a battery life module.

CORE modules are collections of specific information. Each module can display general and detailed information. Tap the **General** and **Details** tabs near the bottom to switch between general and detailed information. Note that not all modules have detailed information.

Activating CORE



CORE is built into the operating system of every 700 Color Computer. To run CORE for the first time, select **Start > Programs > File Explorer**, select “\Flash File Store\Apps\CORE,” then tap the CORE executable file.



After CORE is run on the 700 Color Computer, tap **Start > Programs > Core** to access this application henceforth.

Install an Available Radio Module

To install an available radio module onto your 700 Color Computer, tap **Modules > Add/Remove**, select a module from the bottom Available box, then tap **Add** to put the selected module in the upper Installed box. Click **OK** to exit the Add/Remove Modules screen.

Loading a Radio Module

To load or switch to another radio module installed on the 700 Color Computer, tap **Modules > Choose Module**, select a module from the Installed Modules box, then tap **Choose** to initialize and begin using that module.



To learn more about this application, see its online help. Tap **Start > Programs > File Explorer** and select “\Flash File Store\Apps\CORE,” then tap the **corehelp .HTM** file.



Note: Once CORE is running, you can return to it by tapping its icon from the System Tray via the Today screen. Tap **Start** > **Today** > the Core three-ring icon (*circled in the following illustration*).



Network Adapters

Your 700 Series Computer can have up to three radios installed. The default network adapter or radio is dependent on what radios are installed in your 700 Series Computer.

The 730 Computer only has the 802.11b radio and wireless printing. Other radios are *not* supported.

Below are the the network adapters that exist as of this publication. See the Developer's Support web site for the latest information on network adapters for your unit.

- Ethernet Communications (*LAN9000*) — page 128.
- 802.11b Radios (*802.11b Wireless LAN driver*) — page 129.
- WWAN (*Wireless WAN*) — page 134.
- Wireless Personal Area Networking — page 173.

Note that the tip of the antenna attached to your 700 Series Computer is color-coded to identify its WWAN radio type. *This does not apply to the 730 Computer.* Refer to the following to determine your radio type:

- **Red**
CDMA (non-Sprint networks) and GSM/GPRS US/Canada
- **White**
GPRS US/Canada and CDMA Sprint networks
- **Blue**
GPRS International

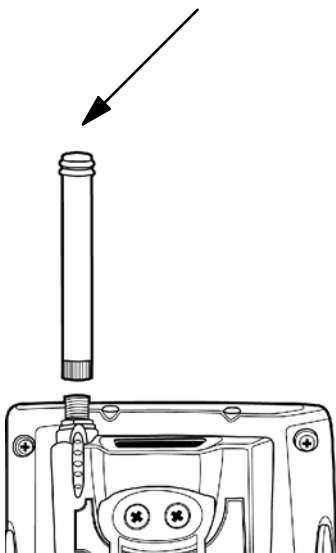

Ethernet Communications



Note: This section does *not* apply to the 730 Computer.

Follow the steps below to start Ethernet communications on the 700 Series Computer. If your system does not contain an 802.11b radio, then **Ethernet networking using DHCP** is selected as the default.

When “Built-in Ethernet” is selected from the NDISTRAY pop-up menu (the Network Driver Interface Specification tray application),

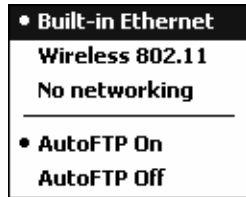

then the **Ethernet** icon shown to the left appears in the System Tray *as circled in the following illustration*.



802.11b Communications

When “Wireless 802.11” is selected via the NDISTRAY pop-up menu:

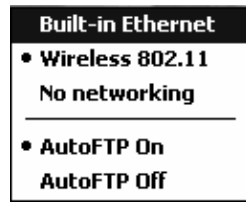

the **802.11 antenna** icon shown to the left appears in the system tray *as circled in the following illustration.*

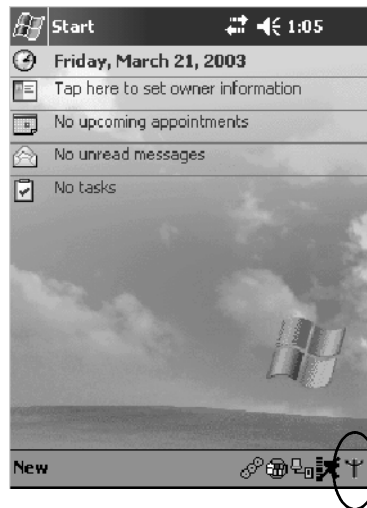

To configure 802.11b communications on the 700 Series Computer, tap **Start > Settings > the System tab > Wireless Network** to access the Profile Wizard for the 802.11b radio module. Go to Appendix A, “*Configurable Settings*,” for configuration information.

802.11b Radio CORE Module



Note: See page 126 for information on loading this module in CORE.

The 802.11b radio CORE module displays helpful information about the 802.11b radio option built into your 700 Series Computer.

Note that you can configure the 802.11b radio module from this CORE application. Select **Configure > Configure 802.11 CF** from the bottom menu bar to access the Profile Wizard application. See Appendix A, “*Configurable Settings*,” for information about this application via the Wireless Network control panel applet.

General

Below are descriptions and meanings for each piece of information provided via the **General** tab. *Note that the information is listed alphabetically.*

Adapter MAC	Identifies the MAC address for this 802.11b adapter.
Antenna	Identifies the antenna used with the 802.11b radio: “Primary,” “Secondary,” or “Diversity.”
AP Mac	Identifies the MAC address of the access point to which this 700 Series Computer is connected.
Connected to	Reports the connection status and to which SSID this 700 Series Computer is attached.
Encryption	Reports the encryption mode and the association mode (in parantheses). See page 389 for information about WEP encryption.
ESS	Identifies the type of network to which you are attached, either an ESS (Extended Service Set) 802.11 Station, or Ad-hoc.
IP	Provides the IP address which can be set as either DHCP (Dynamic Host Configuration Protocol) or statically.
Link	Indicates the speed at which a connection is made.
Power	Indicates the power status of this 802.11b profile.
Signal	Identifies the radio signal strength (in dBm).
TX Power	Shows the transmit power (in milliwatts) at which transmissions are made.



History:

This bar graph displays an active history of this radio module’s quality of connections.



Friendly Indicator:

This indicates the general quality of the 802.11b connection. Three filled dots indicates the best quality; two filled dots dictates good quality; one filled dot is of fair quality; and when all three dots are empty, the quality is considered poor.

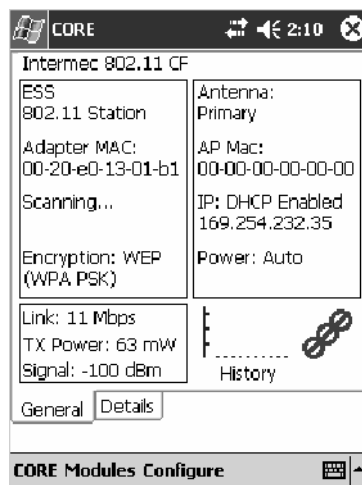

Details

Below are descriptions and meanings for each piece of information provided via the **Details** tab. *Note the information is listed alphabetically.*

Attach-Roam Cnt	Includes the number of new associations made during the current session, including any found roaming.
CCX Status	States the status of the CCX, either enabled or disabled.
Desired SSID	Identifies the preferred Service Set Identifier (SSID).
Driver Name	Identifies the 802.1x driver installed on this 700 Series Computer.
Last 5 Supp Msgs	Monitors and reports the 802.1x Security Supplicant activity.
Scanlist	Indicates whether the Scan List option was enabled or disabled.
Supplicant Status	Monitors the 802.1x security activity on the client: “Running” or “Stopped.”
Watchdog Status	Monitors the activity of the Scan List: “Running” or “Stopped.”

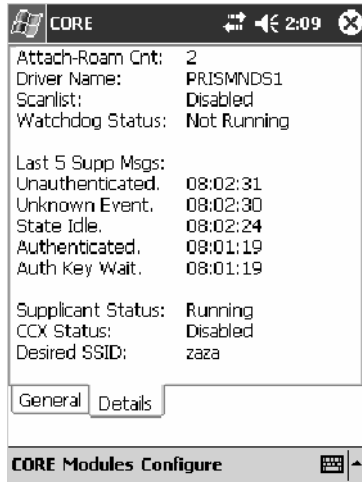

No Networking

When “No networking” is selected from the NDISTRAY pop-up menu:

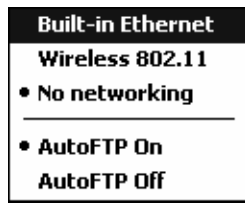

the **disconnected** icon shown to the left appears in the system tray *as circled in the following illustration.*



Network Selection APIs

The Network Selection APIs change the network adapter configuration programmatically. Both drivers support the same IOCTL function numbers for loading and unloading the drivers. Go to Chapter 7, “*Programming*,” to see the APIs.

Network Connections



Connections

From the 700 Series Computer, tap **Start** > **Settings** > the **Connections** tab > **Connections** > the **Advanced** tab > **Network Card** to access the network connections for this unit. Make the changes necessary for your network, then tap **ok** when finished.

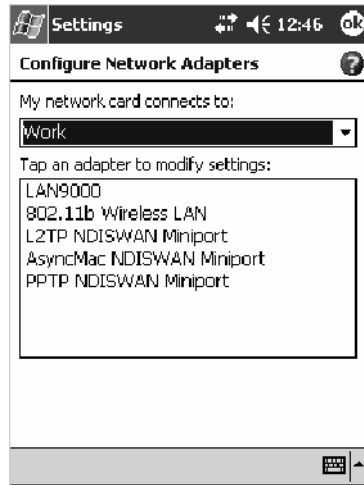

Note: “LAN9000” is for Ethernet and “802.11b Wireless LAN” is for 802.11b radios.

WWAN Radio Options



Note: This section does *not* apply to the 730 Computer.

Go to the following pages to learn more about your radio module:

- CDMA/1xRTT radio module (*see below*)
- GSM/GPRS radio module (*page 163*)

CDMA/1xRTT

Code Division Multiple Access (CDMA) is a form of wide area wireless communications. 1XRTT supports up to 144 KB per second packet data transmission and doubles the voice capacity of current generation CDMA networks.

The WAN radio CORE module displays helpful information about the CDMA/1xRTT radio option built into your 700 Series Computer.

WAN Monitor — General



Note: See page 126 for information on loading this module in CORE.

Below are descriptions and meanings for each piece of information provided via the **General** tab. *Note that the information is listed alphabetically.*

Activated	Indicates whether the ESN on this unit was activated by your service provider. <i>Note a decimal version of your ESN is on the Details page.</i>
f/w	Identifies the firmware version, if available.
Network Type	The network type which would list “CDMA-1XRTT.”
On	Indicates when activation was provided by your service provider.
Phone Number	Identifies the telephone number (or MDN) assigned to the WAN Module installed in your unit.
Radio ESN	Lists the Electronic Serial Number (ESN) assigned to this radio module or “Unavailable” if a number cannot be read from the radio. <i>This number is required for activation.</i> You must provide this number to your service provider, such as Sprint, Verizon, Bell Mobility, etc., for activation.
Registered on home network	If the WAN radio module has registered with a service provider network, then one of the following will appear: <ul style="list-style-type: none"> • <i>Registered on home network:</i> Radio module is registered on its “home” network. • <i>Registered on roamed network:</i> Radio module registered on another service provider’s network. • <i>Radio Not Registered:</i> There is no network within range of this radio module.
RSSI	Displays the Received Signal Strength Indicator (RSSI) frequency or lists “Unavailable” if there is no signal or the signal cannot be retrieved from the radio module.
Serial Status	Indicates whether serial communications passed (“Serial com OK”) or failed (“Serial com FAIL”) in its last transaction. A status of “Serial com FAIL” typically indicates that the 700 Series Computer is unable to establish communication with the radio module installed within.
Verizon Network	Identifies your network service provider.



History:

This bar graph displays an active history of this radio module’s quality of connections.



Friendly Indicator:

Usually indicates the signal strength for this radio module. Three filled dots indicate a high quality or strong signal. Three empty dots indicate that the signal is out of range or there is no signal detected.

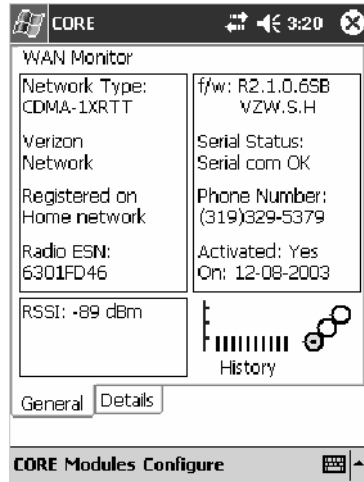

WAN Monitor — Details



Note: See page 126 for information on loading this module in CORE.

Below are descriptions and meanings for each piece of information provided via the **Details** tab. Most of this is similar to what is shown under the **General** tab. *Note that the information is listed alphabetically.*

ESN	Lists the Electronic Serial Number (ESN) assigned to this radio module or “Unavailable” if a number cannot be read from the radio. This number is required for activation. You must provide this number to your service provider, such as Sprint, Verizon, Bell Mobility, etc., for activation. <i>Note that both the hex version and the decimal version of your ESN is provided.</i>
Firmware Rev	Identifies the firmware version, if available.
Firmware Type	Identifies the type of firmware installed in the WAN radio module. It should match the carrier you are using as your network provider.
Hardware Rev	Identifies the hardware revision of the WAN radio module installed in your unit.
IMSI/MIN	Shows the IMSI (International Mobile Subscriber Identity) number assigned to the Subscriber Identity Module (SIM) card installed in this 700 Series Computer.
Manufacturer	Lists the name of the manufacturer that developed this radio module, such as “Sierra Wireless.”
MDN	Shows the MDN (Mobile Directory Number) or DN (Directory Number) — the number that identifies the account tied to your device. You can consider this the “phone number.” <i>Note that the MDN and IMSI/MIN numbers can be the same.</i>
Model	Lists the product name for this radio module, such as “Model 72.”
Phone Number	Identifies the telephone assigned to the WAN radio module.
PRI Version	Provides the version number of the Preferred Roaming List (PRL).
Radio Temp	Identifies the temperature of the radio module, or lists “Unavailable degrees” if no information or temperature cannot be measured.
Rx	<i>(abbreviation for receive)</i> Indicates the number of bytes received over the WAN connection since the CORE WAN Module was started.
Tx	<i>(abbreviatino for transmit)</i> Indicates the number of bytes received over the WAN connection since the CORE WAN Module was started.

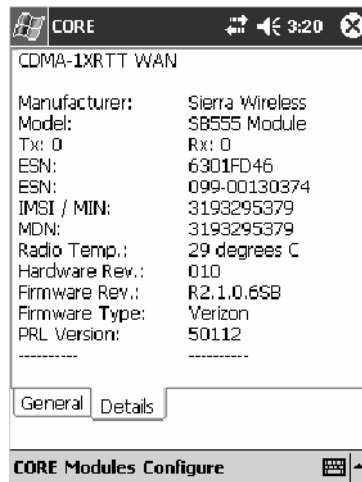

CDMA Radio Set Up



Note: Set up and provision information is also available in the *700 Color CDMA Radio Setup Quick Start Guide* P/N: 962-054-063.

This tells you how to set up your CDMA radio in your 760 Computer. Below are terms to familiarize you with CDMA radio technology:

Activation	The process of programming the radio with the lock code (MSL) and phone number (MIN) to allow it to communicate on the provider's network. Once activation is complete you can make voice calls (<i>if enabled by the carrier</i>) with the mobile computer.
Data Provisioning	The process of activating the ability for the CDMA radio to establish data connections, such as connecting to the Internet. The CDMA radio makes data connection only after it is activated and data provisioned.
NID (Network ID)	A numeric value programmed into the CDMA radio at the factory or during the activation process. Your carrier may or may not use this value, but your carrier may provide this for activation purposes.
SID (System ID)	A numeric value programmed into the CDMA radio at the factory or during the activation process. This number is used by your carrier to determine if the radio belongs to its CDMA network. Your carrier may provide this number for activation purposes.



Note: Descriptions in this chapter are for Sprint PCS, Bell Mobility, Telus, and Verizon Networks versions of the SB555 Watcher program. Other carriers may be added pending regulatory and carrier approval.

Copying CDMA Radio Module CAB Files from Intermec Web Site

Copy CAB files from the Intermec web site at <http://www.intermec.com> onto your desktop. *Note that this is subject to change.*

- 1 Select **Service & Support > Developers Support** from the blue navigation bar on the Intermec home page.
- 2 Select **700 Color Support** from the Developers Support navigation column on the left side of the screen.
- 3 Select **Downloads** from beneath the **700 Color Support** selection in the Developers Support navigation column on the left side of the screen.
- 4 Scroll down to the “Sierra Wireless ‘Watcher’ Application” paragraph (beneath the **Tools** category), download any of the CAB files shown, then choose your carrier CAB files.

Intermec recommends two methods with which to load these CAB files onto your 760 Computer: via the Microsoft ActiveSync application (next paragraph) or via a CompactFlash or Secure Digital storage card (next page). See Chapter 3, “*Installing Applications*,” for more information about these methods.

Via Microsoft ActiveSync

You can transfer files from your desktop to your 760 Computer via Microsoft ActiveSync. See Chapter 2, “Windows Mobile 2003” for more information about ActiveSync.

- 1 Obtain software from the Intermec web site as described earlier. Download the software to any location on your 760 Computer, such as the **Temp** folder via the **My Device** root location.
- 2 Tap the carrier CAB file to install the application.
- 3 Go to “*Finishing the Installation*” on page 139.

Via a CompactFlash or Secure Digital Storage Card



Note: These instructions are based on default locations. You can change the location to which to copy your CAB files.



Utilities

- 1 Make sure the Registry Restore feature on your 760 Computer is disabled. Select **Start** > **Settings** > the **System** tab. Tap the **Utilities** desktop icon, then the **Registry Save** tab. Clear the **Enable Registry Save** box.

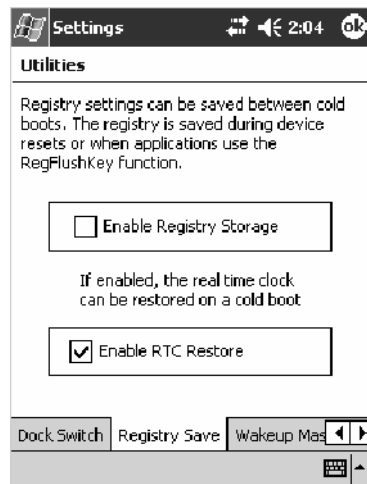

- 2 Copy the CAB files for your carrier to your CompactFlash or Secure Digital storage card after downloading it from the web site.
- 3 Cold-boot your 760 Computer. Remove the battery pack and press the reset button in the bottom of the battery compartment.
- 4 Go through the normal getting started steps detailed in your *700 Series Color Mobile Computer Quick Start Guide* P/N: 962-054-053.
- 5 Install the CompactFlash or Secure Digital memory card into the card slot in your 760 Computer. *Note that if you do not want the CAB files erased after installation, set the CAB file attributes to “read-only” after copying them to the storage card.*
- 6 From the 760 Computer, tap **Start** > **Programs** > the **File Explorer** icon.



File Explorer

- 7 Tap the pull-down menu for **My Documents** and tap the **My Device** root location.
- 8 *If you are using a CompactFlash storage card,* tap **Storage Card**.
If you are using an Secure Digital storage card, tap **SDMMC Disk**.
- 9 Scroll down, then tap the **Sprint Watcher CAB** file to install the application.
- 10 Go to “*Finishing the Installation*” on page 139

Finishing the Installation

Do the following to run the SB555 Watcher application. Be sure to do step 1 as it is important to perform a warm-boot on your 760 Computer. Upon restart, the Watcher application sets up on the 760 Computer for activation.

- 1 Press and hold down the (I/O) button on your 760 Computer for about 12 seconds to warm start the terminal, then press the (I/O) button again for a couple of seconds.
- 2 Tap **Start > Programs > the Watcher icon**.
- 3 Tap **Yes, I accept** to accept the license agreement, then tap **OK** to continue. *Note that this license agreement does not appear again after this installation.*

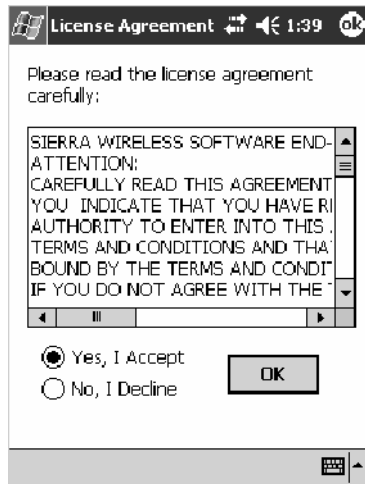

- 4 Tap **OK** for the 760 Computer to perform a warm-boot and complete the installation.



Activation



Note: Set the date and time before doing this activation.

SB555 Watcher is for activation and data provisioning. Once you enable voice capability, data capability, or both depending on the carrier, remove this program from the system by cold-booting your computer.

Intermec Technologies does not recommend using the SB555 Watcher program to make data and voice calls on a daily basis for these reasons:

- The SB555 Watcher application is a third-party application unaware of certain power management methods used in your 760 Computer. Therefore, the application consumes more power than necessary.
- The application size consumes memory better used for your application data.

The process of setting up the account with your carrier and enabling the CDMA WAN radio in your 760 Computer is called *activation*.

The CDMA radio is pre-programmed for a specific carrier, such as Sprint, Telus, Bell Mobility, Verizon, etc.). Therefore, information about your radio should already be in your carrier's database.

You need to notify the carrier and set up mobile accounts for each unit you are activating. The Electronic Serial Number (ESN hex 63xxxxxx) that you need to supply to your carrier is located in two places:

- On the outside of the 760 Computer shipping box.
- On the inside of the 760 Computer battery compartment.

The ESN comes in both decimal and hexadecimal formats. Most carriers accept either format, but with a preference for the decimal format. You only need to provide one number to your carrier.

- The decimal format consists of 11 digits, beginning with “099.”
- The hexadecimal format is an 8-digit number, beginning with “63.”

Accounts for Verizon and Sprint carriers can be set up for data only. Canadian carriers (Telus and Bell Mobility) can be set for data only, voice only, or both voice and data. This is determined by your application and the services your carrier offers.

After the all ESNs are provided to the carrier and the carrier has established the accounts, you will be provided with the lock codes and telephone numbers needed to complete the activation process. You use the SB555 Watcher program to accomplish this task. *Be sure to write down this information for future use.*



Note: Ensure that you receive a spreadsheet with your order that calls out all ESNs in both decimal and hexadecimal formats.



Note: Not all of the elements listed are required by all service providers.

ESN of the modem
Lock/Activation Code (may be termed one of the following):
<ul style="list-style-type: none"> • MSL — Master Subsidy Lock • OTSL — OneTime Subsidy Lock • SPC — Service Provisioning Code • OTKSL — One Time Key Subsidy Lock
SID (System ID)
NID (Network ID)
User Name
Password
MIN
MSD
MDN



Note: The activation process for your Watcher version may vary from the following steps. Thus, you may not have to do all of them.



1 Tap **Start** > **Programs** > the **Watcher** icon or tap the Watcher icon from the NDISTRAY via the Today screen (*circled in the following illustration*) to launch the SB555 Watcher program.



- 2 The Activation Wizard should start automatically. If not, then tap **Admin > Activation Wizard** from the bottom of the screen.



- 3 Follow the screen prompts, tapping **Next** to move from one screen to the next.
- 4 When you reach the Activation screen, select **Manual Activation**.
- 5 At the appropriate screen, enter the **Activation Code** (OTSL, MSL, OTKSL, or SPC) provided by your carrier and tap **Next**.
- 6 Enter the phone number provided when your 760 Computer was activated and tap **Next**.

Verizon Automated Activation Process



Note: This process takes approximately 60 seconds.

Using Verizon Watcher

Do the following to activate Verizon on your 760 Computer:

- 1 After initializing the Watcher program, tap **Yes, I accept** to accept the license agreement, then tap **OK** to perform a warm-start on the 760 Computer. *Note that this license agreement does not appear again after this installation.*

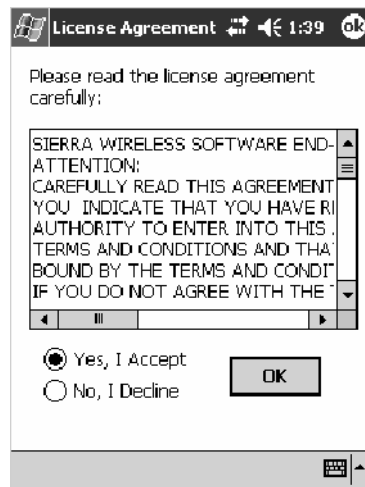

- 2 Start the Watcher program again, select **Automated Activation**, then click **Next**.



Note: You must be in the Verizon coverage area to activate your 760 Computer and only in the location of intended use.

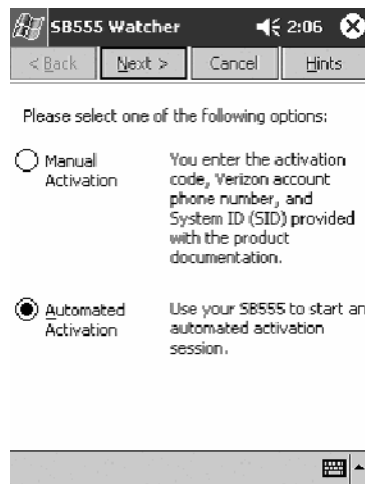

- 3 Click Next, click Next again to dial the number displayed on the screen.

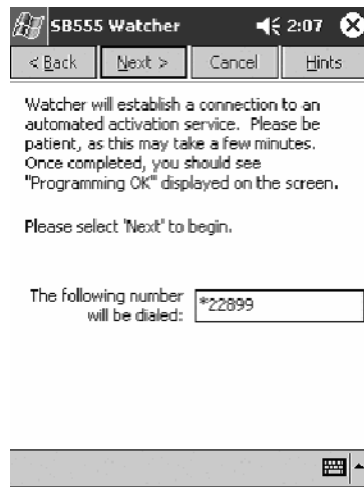

- 4 The activation process starts automatically.



5 You will see a series of unlock codes on your screen.



6 The following illustration shows the result of a successful activation.





- Click the **Connect** button (circled in the following illustration) to connect to the carrier's network.



- Select **Start > Internet Explorer**, then choose a web site. Your unit is now successfully activated.



- Perform a cold-boot on your 760 Computer to uninstall the Watcher application. Watcher is intended for activation purposes only. Intermec recommends using the following for establishing and maintaining connection to the WAN radio.

- Custom application using Intermec's WWAN Toolkit API
- WWANInit demo program (see page 156)
- Custom customer application using Connection Manager Interface



Note: When connecting to the WAN radio via Pocket PC Connection Manager, use the 10-digit phone number@vzw3g.com for the user name (such as 1234567890@vzw3g.com) and "vzw" for the password.

Sprint Automated Activation Process



Note: Sprint PCS uses a data provisioning method termed IOTA (Internet Over The Air) to complete its activation and data enablement. The following steps detail how to properly activate and data provision your 760 Computer.

Do the following to set up activation:

- 1 Provide Sprint with your ESN, rate plan, and account information.
- 2 Sprint provides you with the following for each ESN:
 - MDN, such as 214-555-5555
 - MSID, such as 214-555-5555
 - MSL/OTKSL (Activation Code), such as 945614
 - NAI (Network Access Identifier), such as the following:
CustomerNameo103@sprintpcs.com

You must use a Secure Digital storage card with *only* the SPRINT_WATCHER.CAB file in the “\SDMMC/Cabfiles” directory.



Note: Other CAB files in the “SDMMC/Cabfiles” directory may cause problems with testing — remove or uninstall these before proceeding.

You need at least 80% (4 of 5 bars) CDMA signal strength for a successful over-the-air activation.

Download and Activate Sprint Watcher



Utilities

- 1 Make sure the Registry Restore feature on your 760 Computer is disabled. Select **Start** > **Settings** > the **System** tab. Tap the **Utilities** desktop icon, then the **Registry Save** tab. Clear the **Enable Registry Save** box.

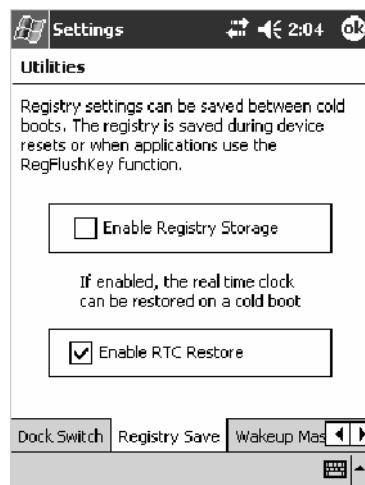

- 2 Perform a cold-boot on your 760 Computer, then go through the normal Pocket PC set-up (i.e. Align Screen etc.).

- 3 **Important!** Set the Date and Time.
- 4 Tap the SPRINT_WATCHER.CAB file to perform the installation.
- 5 Perform a warm-boot on your 760 Computer to load the CAB file.
- 6 From the Today screen, tap the **LAN Network** icon in the System Tray (circled in the following illustration).

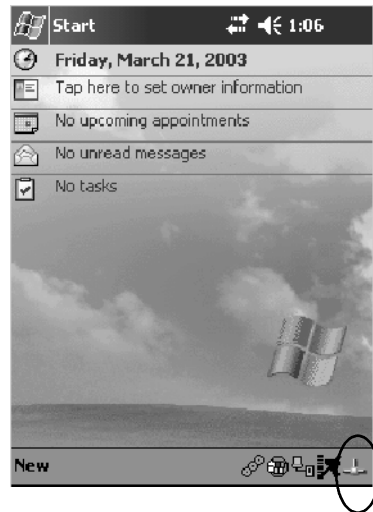

- 7 In the NDISTRAY pop-up menu (the Network Driver Interface Specification tray application), select **No Networking** and **Auto FTP Off**. Tap anywhere on the screen to close the menu.

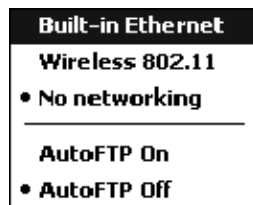



- 8 Tap **Start** > **Programs** > the **Watcher** icon or tap the **Watcher** icon from the **NDISTRAY** via the **Today** screen (*circled in the following illustration*) to launch the **SB555** **Watcher** program.



- 9 Tap **Yes, I accept** to accept the license agreement, then tap **OK** to continue. *Note that this license agreement does not appear again after this installation.*

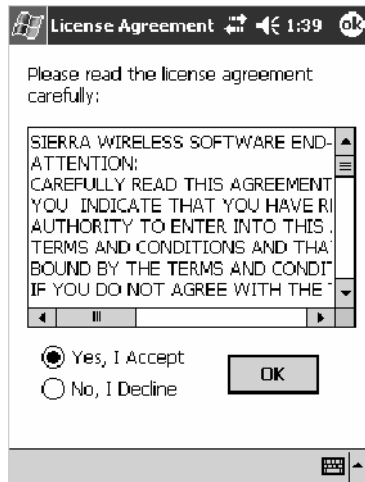

Tap **OK** for the 760 Computer to perform a warm-boot and complete the installation.



Using Sprint Watcher

Before you start using the Sprint Watcher application, make sure you match the correct ESN with each 760 Computer and that you have at least 80% CDMA signal strength.



- 1 Tap **Start** > **Programs** > the **Watcher** icon or tap the Watcher icon from the NDISTRAY via the Today screen (*circled in the following illustration*) to launch the SB555 Watcher program.

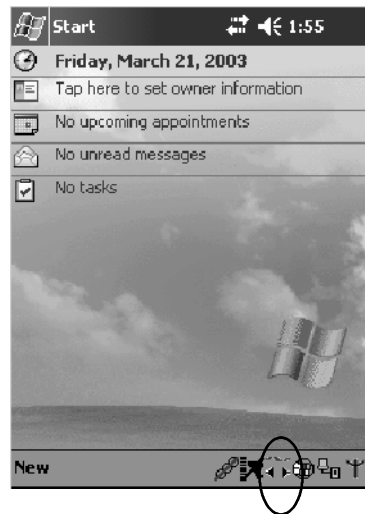

- 2 If your 760 Computer was not previously activated, Watcher automatically starts the Activation Wizard. Otherwise, select **Manual Activation** to continue.

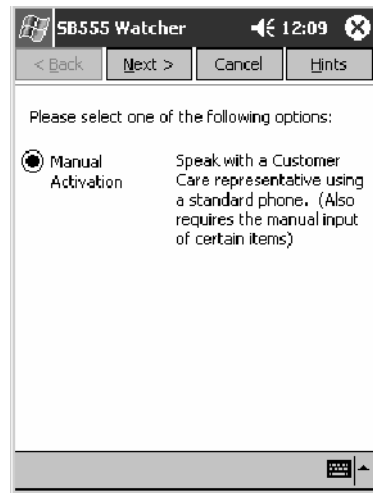

- 3 Enter the MSL or lock code received from Sprint.

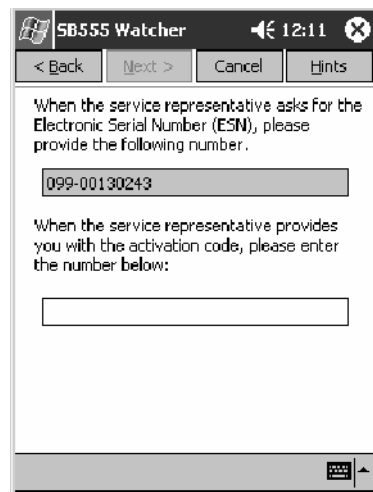

- 4 Enter the phone number (MIN) and MSID received from Sprint. These numbers may be the same.

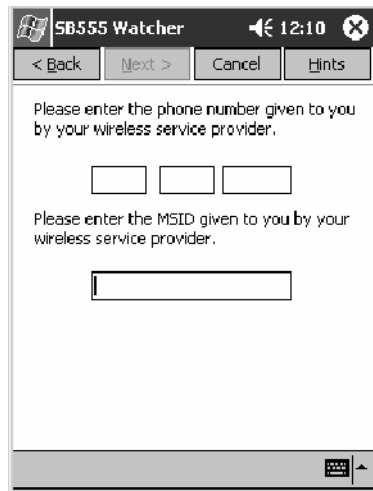

- 5 After entering the phone number and MSID, the modem resets. Watcher displays the following two screens:

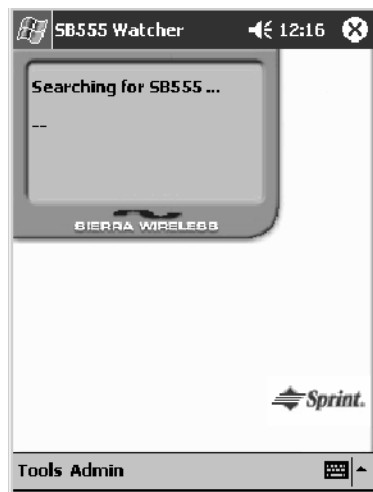

Note: If the “searching for SB555” screen does not proceed to the next screen after 30-40 seconds, perform a warm-boot on your 760 Computer, then restart the Watcher program.

- 6 If **Data Provisioning** does not start automatically, select **Admin > Data Provisioning** from the bottom menu bar.

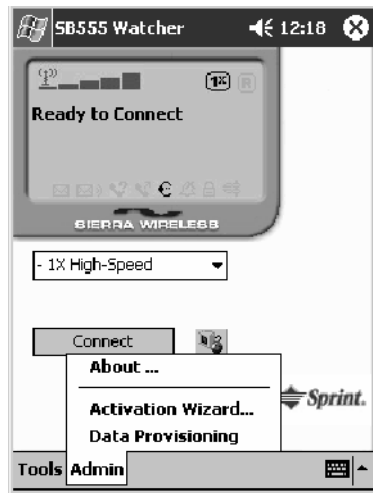

- 7 Tap **Yes** to proceed with data provisioning.



Activation over the air typically takes 1–20 minutes.

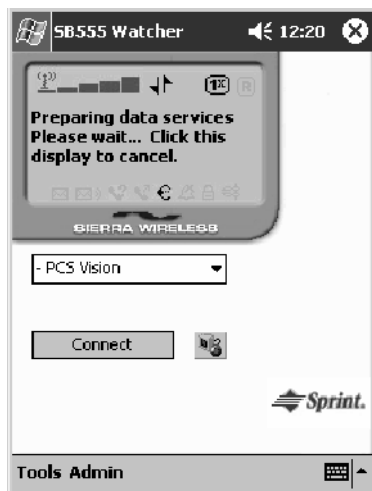

If data provisioning fails, do the following:

- If Data Provisioning fails and the message “could not prepare data services, please contact Sprint” displays, retry the Data Provisioning step by tapping the “Admin” menu icon at the bottom of the Watcher screen. Select “Data Provisioning...” and answer “yes” to the request.
- If after several attempts to complete the Data Provisioning over the air, it may be necessary to manually enter the data activation method.
- Manual activation is beyond the scope of this guide, therefore, go to Intermec Knowledge Central (<http://www.intermec.com>, then select **Service & Support > Knowledge Central**) The article (number 5749) is titled *How to Manually Activate a Sprint CDMA WAN Radio in the 760 Device*.



8 The following screen appears once data provisioning is complete:

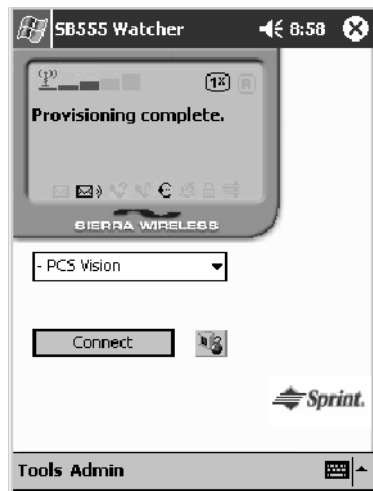



- 9 Test the data connection by tapping on the “connect” button to make a data connection to the network. Watcher progresses through the following two screens. Once you see the second screen you know that your mobile computer has successfully connected to the 1XRTT network.

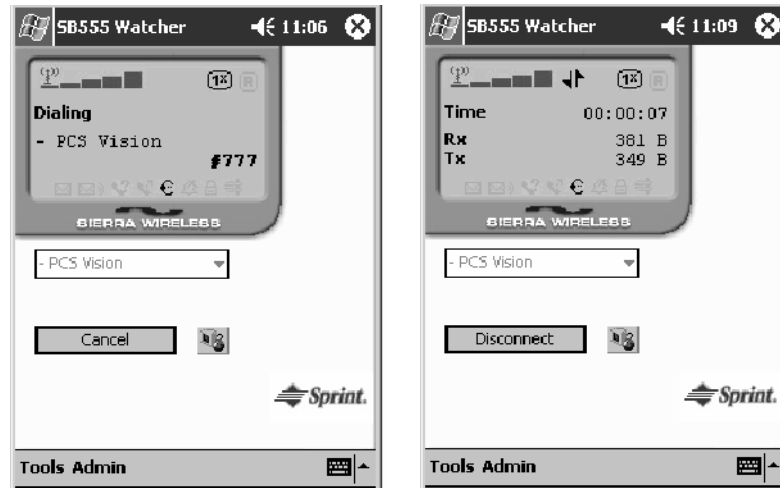

- 10 Select **Start > Internet Explorer**, then choose a web site. Your unit is now successfully activated.



Perform a cold-boot on your 760 Computer to uninstall the Watcher application. Watcher is intended for activation purposes only. Intermec recommends using the following for establishing and maintaining connection to the WAN radio.

- Custom application using Intermec’s WWAN Toolkit API
- WWANInit demo program (*see page 156*)
- Custom customer application using Connection Manager Interface

Telus and Bell Mobility Activation

Activation of Bell Mobility and Telus are similar to the first portion of the Sprint activation process. Follow the instructions for manual activation using the Bell Mobility `Watcher.CAB` or Telus `Watcher.CAB` file to install the applicable application. Enter the activation lock codes and phone numbers as requested.

Username, Password, SID Information

	Bell Mobility	Telus
Username	10 digit phone number@1xbell.ca	10-digit phone number@1x.telusmobility.com
Password	Original Voice Mail system password (usually a 4 digit number) This is available from the activating organization.	The 11-digit ESN printed inside the 760 Computer battery compartment, begins with 099.
SID	16420	16422

WWANInit Demo Program

Make sure your 760 Computer with CDMA card is activated and data provisioned.

You must use a Secure Digital storage card with *only* the `WWANINITxxxxx.CAB` file in the “SDMMC/Cabfiles” directory, where “xxxxx” is the version number.

You can download this CAB file from the Intermec web site, via the following:

- 1 Select **Service & Support > Developers Support** from the blue navigation bar on the Intermec home page.
- 2 Select **700 Color Support** from the Developers Support navigation column on the left side of the screen.
- 3 Select **Downloads** from beneath the **700 Color Support** selection in the Developers Support navigation column on the left side of the screen.
- 4 Under the **Tools** category, scroll down to “WWANInit xxx Connection Program-WWAN Radios,” then click **Download**



Note: Other CAB files in the “SDMMC/Cabfiles” directory may cause problems with testing — remove or uninstall these before proceeding.

Set Up the WWANInit Companion Program

Do the following to set up the WWANInit xxx Companion Program:



- 1 Make sure the Registry Restore feature on your 760 Computer is disabled. Select **Start** > **Settings** > the **System** tab. Tap the **Utilities** desktop icon, then the **Registry Save** tab. Clear the **Enable Registry Save** box.

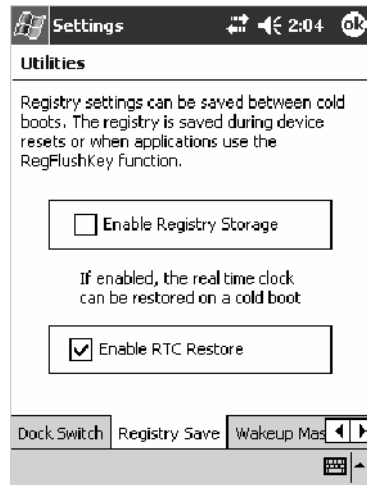

- 2 Perform a cold-boot on your 760 Computer, then go through the normal Pocket PC set-up (i.e. Align Screen etc.).
- 3 Tap the WWANINITxxxxx.CAB file to perform the installation.
- 4 Perform a warm-boot on the 760 Computer.



- 5 From the Today screen, tap the **LAN Network** icon in the System Tray (circled in the following illustration).

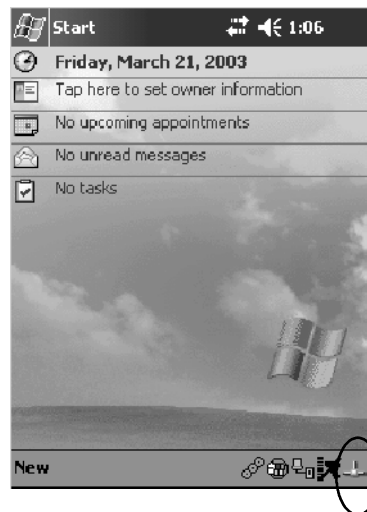

- In the NDISTRAY pop-up menu (the Network Driver Interface Specification tray application), select **No Networking** and **Auto FTP Off**. Tap anywhere on the screen to close the menu.

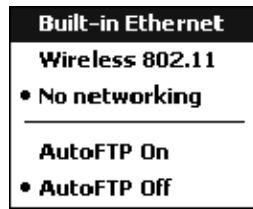

Create a New Connection



- Select **Start > Settings > the Connections tab > Connections**. Under **My ISP**, tap **Add a new modem connection**.

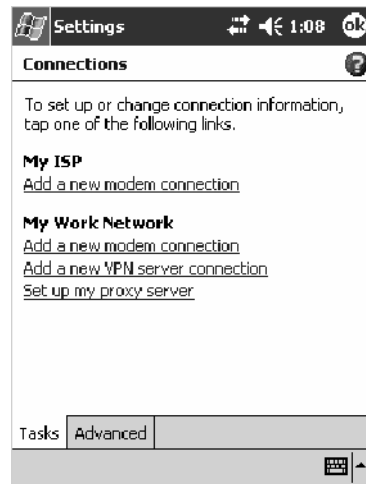

- Enter "1XRTT" as the name for the connection, select "WANA on COM4" from the **Select a modem** drop-down list, then tap **Next**.



- 3 Enter #777 for the phone number as it should be dialed, then tap Next to continue. Select **Start > Help** for more information or tap **use dialing rules** to make modifications. *Note that this screen may vary based on your dialing rules.*

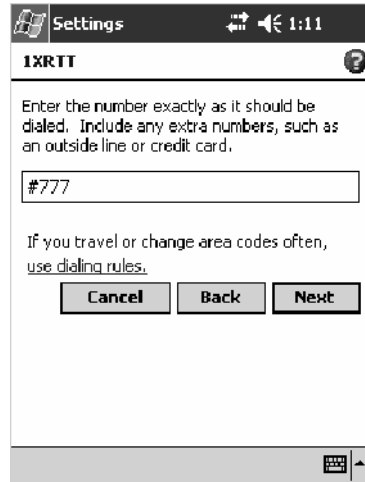

- 4 Tap **Advanced** to continue.

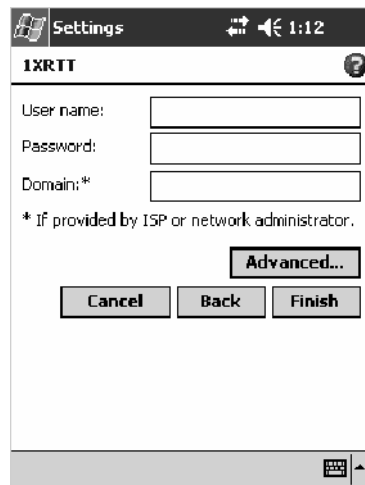

- 5 Tap the **General** tab, select “115200” from the **Baud rate** drop-down list, enter “&C2” *without the quotes* in the **Extra dial-string modem commands** field, then tap **ok** to return to the 1xRTT settings.

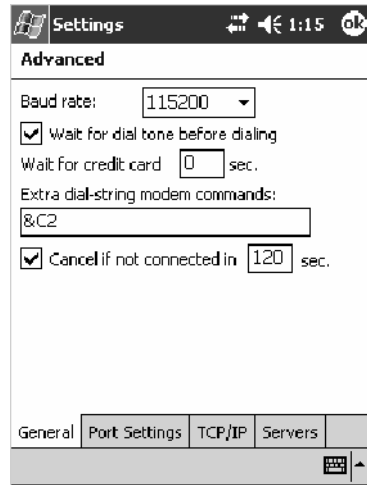

- 6 Tap **Finish** to return to the Connections page.

Using the WWANInit Companion Program

Do the following to run the WWANInit application:



- 1 From the Today screen, tap the **WAN Network** icon in the System Tray (*circled in the following illustration*) or select **Start > WWANInit** to start the application.

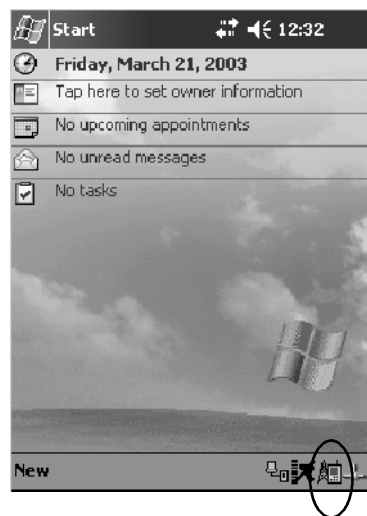

- 2 Tap **Modem On**. Let it step through process (usually about 30 seconds) until **Modem Ready for use** appears.

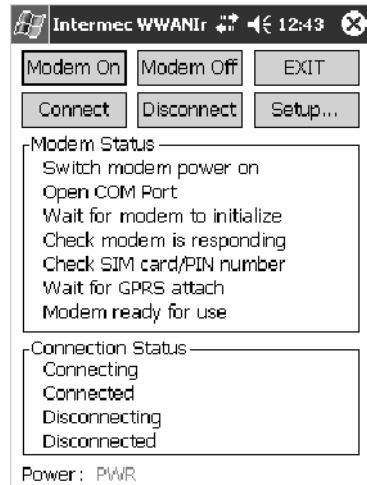

- 3 Tap **Connect**.
- 4 For *Telus, Bell Mobility, and Verizon carriers*, click **Save password**. For *Sprint carriers*, leave the field blank.

Username and Password Information

	Verizon	Bell Mobility	Telus
Username	10-digit phone number@vzw3g.com	10 digit phone number@1xbell.ca	10-digit phone number@1x.telusmobility.com
Password	vzw	Original Voice Mail system password (usually a 4 digit number) This is available from the activating organization.	The 11-digit ESN printed inside the 760 Computer battery compartment, begins with 099.

- 5 Click **OK**. You should see a pop-up message with “Connecting to my connection→then connected”.

- 6 Tap **Setup**, then the **Backup** tab. Choose the location of the backup file, then tap **Backup Pocket PC connection settings now**.

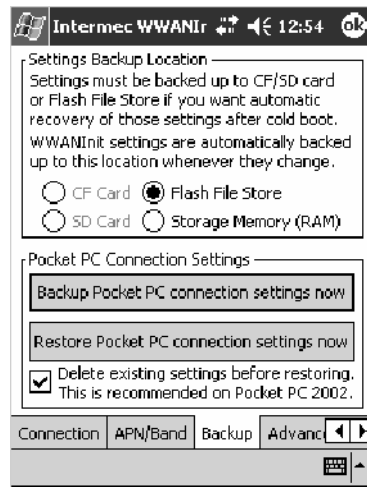

- 7 Tap **ok** when prompted.



- 8 Select **Start > Internet Explorer**, then tap the large **MSN Mobile** link.



- 9 Tap the small **connect to MSN Mobile** link. After about 20 seconds, you should connect to the web.

GSM/GPRS

GSM (Global System for Mobile communications) is an open, nonproprietary wireless system. **GPRS** (General Packet Radio Service) is the high-speed data evolution of GSM that supports Internet Protocol (IP), enabling access to Internet and intranet content and applications from GPRS wireless devices.



Note: See page 126 for information on loading this module in CORE.

WAN Monitor — General

The WAN Monitor CORE module displays helpful information about the GSM/GPRS radio option built into your 700 Series Computer. *The following illustrations are for a GSM/GPRS Siemens MC45 radio.*

Below are descriptions and meanings for each piece of information provided via the **General** tab. *Note that the information is listed alphabetically.*

ATT Wireless Network	Lists the name of the service providing the network support.
Baud	Identifies the frequency bandwidth used by the radio module.
BER	(Bit Error Rate) The average number of bits transmitted in error.
f/w	Identifies the firmware version, if available.
h/w	Identifies the hardware version, if available.
Network Type	The network type which would list “GSM-GPRS.”
Phone Number	Identifies the telephone number assigned to the SIM card.
Radio ESN	The Electronic Serial Number (ESN) assigned to this radio module. “Unavailable” appears if a number cannot be read from the radio.
Registered on home network	If the WAN radio module has registered with a service provider network, then one of the following will appear: <ul style="list-style-type: none"> • <i>Registered on home network:</i> Radio module is registered on its “home” network. • <i>Registered on roamed network:</i> Radio module registered on another service provider’s network. • <i>Radio Not Registered:</i> There is no network within range of this radio module.
RSSI	Displays the Received Signal Strength Indicator (RSSI) frequency or lists “Unavailable” if there is no signal or the signal cannot be retrieved from the radio module.
Serial Status	Indicates whether serial communications passed (“Serial com OK”) or failed (“Serial com FAIL”) in its last transaction. A status of “Serial com FAIL” typically indicates that the 700 Series Computer is unable to establish communication with the radio module installed within.

**History:**

This bar graph displays an active history of this radio module’s quality of connections.



Friendly Indicator:

Usually indicates the signal strength for this radio module. Three filled dots indicate a high quality or strong signal. Three empty dots indicate that the signal is out of range or there is no signal detected.

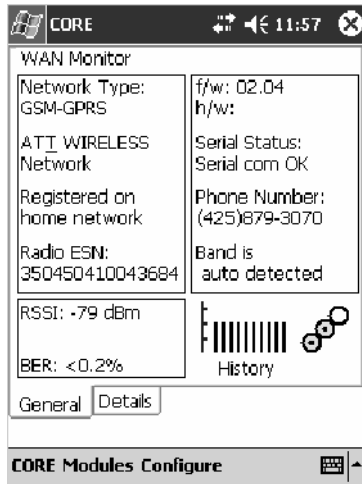

WAN Monitor — Details

Below are descriptions and meanings for each piece of information provided via the **Details** tab. Most of this is similar to what is shown under the **General** tab. *Note that the information is listed alphabetically.*

Firmware Rev	Identifies the firmware version, if available.
IMEI #	The IMEI (International Mobile station Equipment Identity) serial number of the GSM/GPRS radio module.
IMSI #	Shows the IMSI (International Mobile Subscriber Identity) number assigned to the SIM card installed in this 700 Series Computer.
Manufacturer	Lists the name of the manufacturer that developed this radio module, such as “Siemens.”
Model	Lists the product name for this radio module, such as “MC45.”
Net Provider	Lists the name of the service providing the network support.
RSSI	Displays the RSSI frequency or lists “Unavailable” if there is no signal or the signal cannot be retrieved from the radio module.
SIM Status	Identifies whether a SIM card is installed in this 700 Series Computer.





PhoneUtility

Note: This application is for GPRS radios only, due to E911 requirements issued by the FCC. CDMA radios no longer have voice activation.

With the WAN radio module installed in your 700 Series Computer, you can send and receive telephone calls. Use the speaker on the back of the computer as your earpiece and use the connector on the bottom of the computer for your mouthpiece.

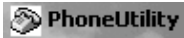

Tap **Start** > **PhoneUtility** from the Today screen to access the application which will process your phone calls. Tap **Exit** or **ok** to close this application and return to the Today screen.

Audio Mode

Select either **Handset** or **Speakerphone** from the **Audio Mode** box, then do the following to send or answer a phone call:

- Tap the numbers for a phone call, using **Clear** to erase each digit, then tap **Send** to initiate the call.
- Tap **Answer** to receive an incoming call.
- Tap **End** to disconnect a transaction.
- Drag the **Vol** slider up or down to adjust the speaker volume.
- Drag the **Mic** slider up or down to adjust the microphone sensitivity.

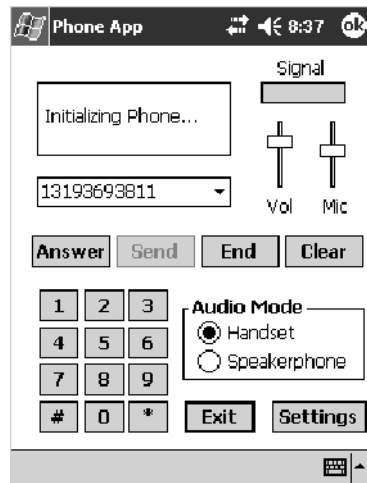

Handset Audio Mode

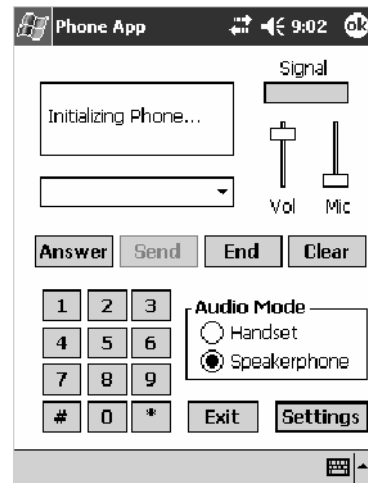

Speakerphone Audio Mode

Notification

Tap **Settings** to set your 700 Series Computer to either ring or vibrate or do both, then tap **OK** or **ok** to return to the Audio Mode screen. If you need to adjust the audio settings, tap **Advanced Audio** to continue.

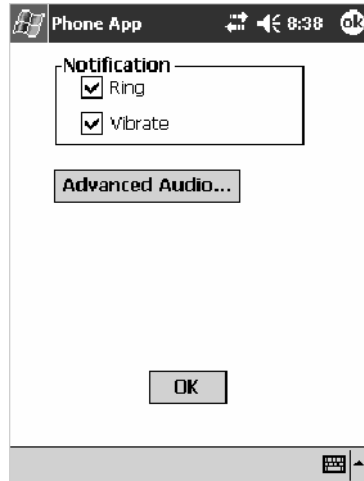

Advanced Audio

Tap **ok** to close the warning and continue.

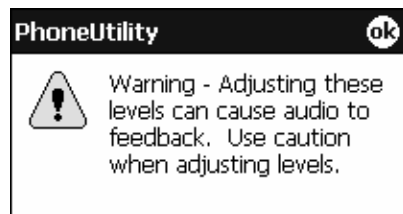

Drag the appropriate slider bars left or right to adjust the output and input levels. Tap **Defaults** to return the handset or speakerphone levels to their factory defaults. Click **OK** or **ok** to return to the Notification screen.

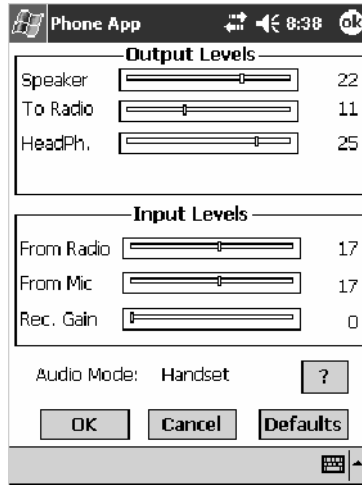

Handset Output/Input Levels

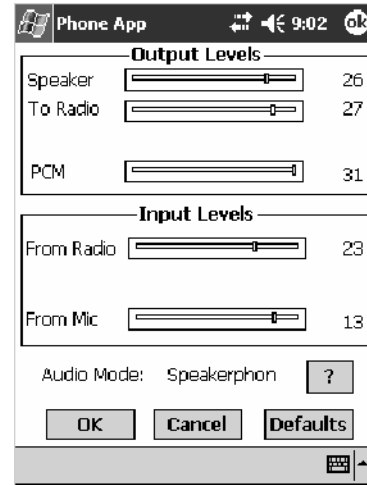

Speakerphone Output/Input Levels

Tap ? for more information on these level settings, then click **ok** or **OK** to return to the Output/Input Levels screen.

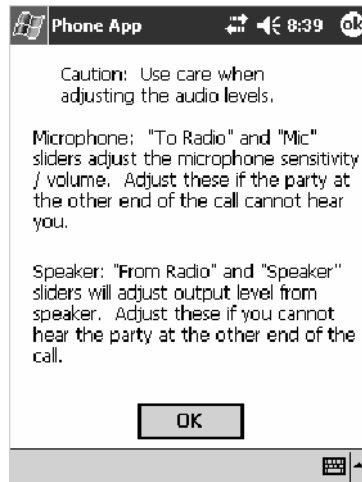

AT Command Interface

This interface specification is based on the following recommendation:

- **ETSI GSM 07.05:**
European Digital Cellular Telecommunication System (phase 2)
Use of DTE-DCE interface for Short message and cell broadcast service.
- **ETSI GSM 07.07:**
European Digital Cellular Telecommunication System (phase 2)
AT command set for GSM Mobile Equipment.
- **ITU-T Recommendation V.25 ter**
Serial asynchronous automatic dialing and control.



Note: You will need the Adobe Acrobat Reader application to view a PDF document. Go to <http://www.adobe.com/prodindex/acrobat/readstep.html> to install or download the latest Adobe Acrobat Reader according to Adobe's instructions.

Command Set for Sierra Wireless SB555

Use the AT command interface from Sierra Wireless to program the CDMA/1xRTT SB555 radio module. Documentation for this interface is available via the following URL. Click the “General AT command reference” link for a PDF document, which is 680 KB in size. *Note that this URL is subject to change.*

http://www.sierrawireless.com/ProductsOrdering/embedded_docs.html

Command Set for Siemens MC45

Use the MC45 AT command interface from Siemens AG to program the GPRS/GSM MC45 radio module. The “*MC45 Siemens Cellular Engine AT Command Set*” is available either from Intermec Technologies or from Siemens AG. Contact either your Intermec representative or the Siemens AG support personnel at the following URL for more information. *Note that this URL is subject to change.*

http://www.siemens-mobile.com/btob/CDA/presentation/ap_btob_cda_presentation_frontdoor/0,2950,12,FF.html

Testing the AT Commands

These commands can be sent to either WAN radio by setting up a dial-up networking connection to COM4. Do the following to initiate this connection and test these commands to your radio:



Connections

- 1 From the 700 Series Computer, select **Start > Settings > the Connections tab > Connections**. Under **My ISP**, tap **Add a new modem connection**.

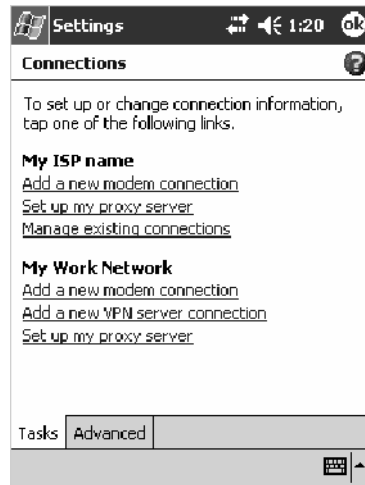

- 2 Enter a name for the connection, select “WAN on COM4” from the **Select a modem** drop-down list, then tap **Next** to continue.

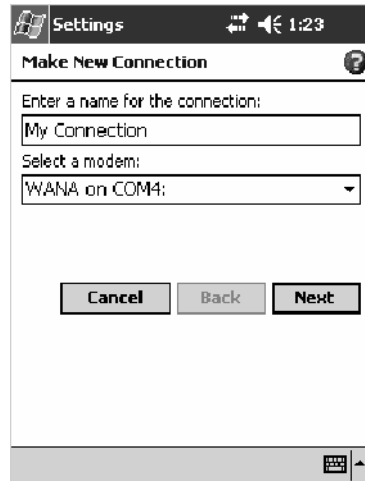

- 3 Enter a phone number as it should be dialed, then tap **Next** to continue. Select **Start > Help** for more information or tap **use dialing rules** to make modifications. *Note that this screen may vary based on your dialing rules.*

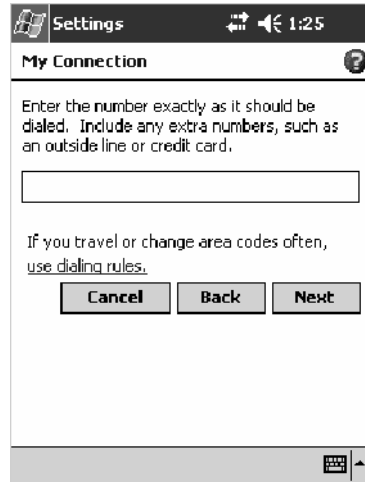

- 4 Tap **Advanced** to continue.

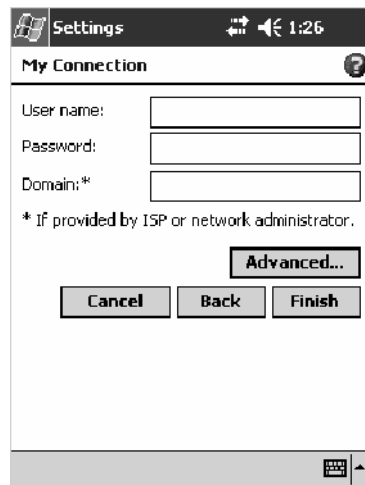

- 5 Select “115200” from the **Baud rate** drop-down list via the General page.

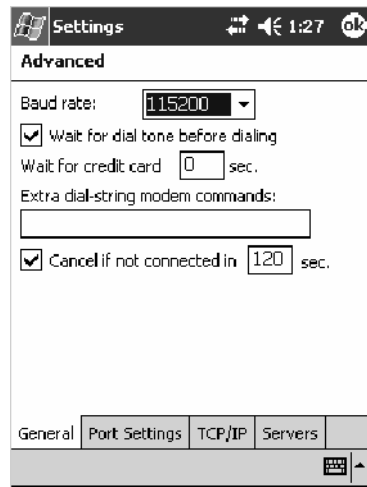

- 6 Tap the **Port Settings** tab, check **Enter dialing commands manually**, then tap **ok**, then **Finish** to return to the Connections screen.

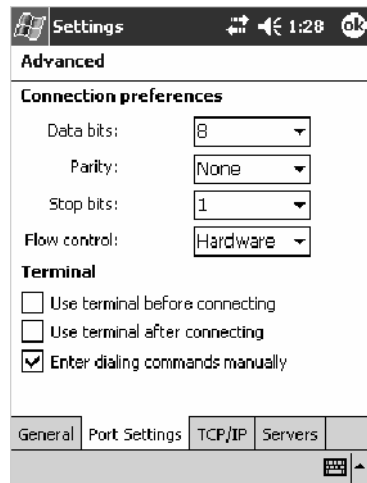

- 7 Press and hold the new connection for a pop-up menu, then tap **Connect** to initiate the connection.

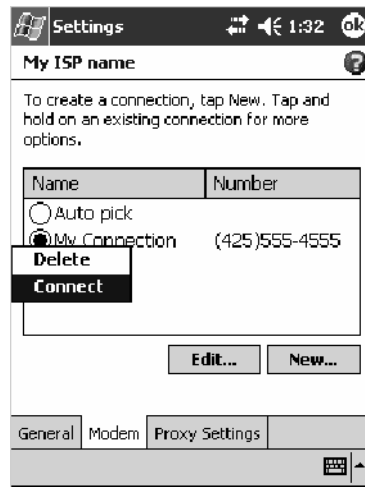

- 8 Wait about ten seconds for the Network Log On screen, then tap **OK**.
Note: You do not need to enter any information within the Network Log On screen.

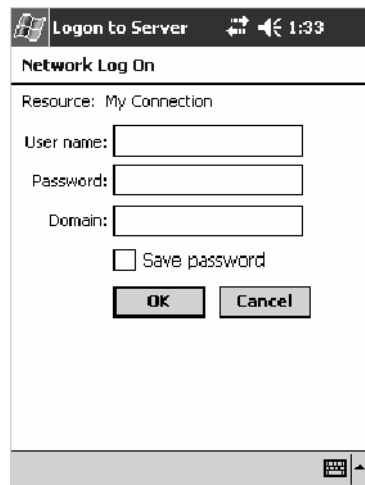

Use either the onscreen keyboard, or press the keys to type any of the AT commands provided. Press or tap **Enter** to send each command. The results of each command sent will print onscreen. *Note that each “AT” command must start with the “at” characters.*

- To see what you typed onscreen, type “at`l`” to initiate the AT Echo command, then press **Enter**.

Wireless Personal Area Networking

“Bluetooth” is the name given to a technology standard using short-range radio links, intended to replace the cables connecting portable and fixed electronic devices. The standard defines a uniform structure for a wide range of devices to communicate with each other, with minimal user effort. Its key features are robustness, low complexity, low power, and low cost. The technology also offers wireless access to LANs, the mobile phone network, and the internet for a host of home appliances and portable hand-held interfaces.

Documentation

Information about additional Bluetooth software is in the Wireless Printing SDK and in the *Wireless Printing Development Guide* (on the *Intermec Developer's Library CD*, via the “Wireless Printing SDK” directory off the root).



Bluetooth

About the Application

Bluetooth is not started automatically by default after a cold-boot is performed. To run Bluetooth, tap **Start > Settings > the Connections tab > the Bluetooth icon**.

The 700 Series Computer retains the Bluetooth state when warm-boots are performed, for example:

- *If Bluetooth is active*, and a warm-boot was performed, the 700 Series Computer boots up with the Bluetooth state activated and Bluetooth virtual COM ports (such as printing) registered. However, you must reactivate connections, as the system does not do these automatically.
- *If Bluetooth is inactive*, and a warm-boot was performed, the 700 Series Computer boots up with Bluetooth deactivated.

Mode

The default tab activates or deactivates Bluetooth. When Bluetooth is activated, the 700 Series Computer can discover and connect to remote devices.

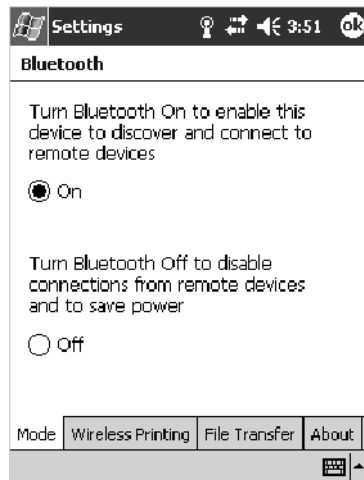

Wireless Printing

Use this tab to print via Bluetooth devices. Tap **Device Discovery** to discover (or scan) for remote Bluetooth devices. When the 700 Series Computer is finished scanning, any newly discovered devices appear in the upper **Devices** box.

Tap **Clear Devices** to remove the list from the **Devices** box.

To print to a Bluetooth device, select any of the devices listed in the **Devices** box, then tap **Connect**. Once connected, the selected device moves to the lower **Connected** box.

To view connection information or register a COM port for a device, from the lower **Connected** box, select a device, then tap **Properties**. *See “Properties” on the next page for information.*

When done printing to a device, select that device in the **Connected** box, then tap **Disconnect**. This moves the device in question back to the upper **Devices** box.

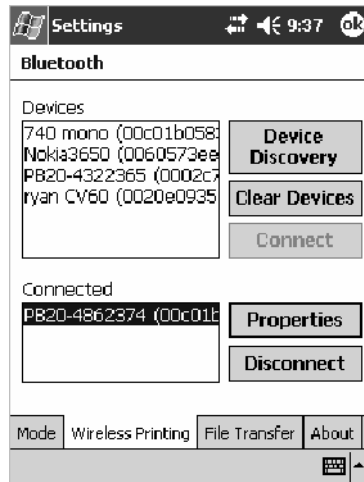

Properties

Select a COM Port from the **Choose COM Port** box to register for this device, then check **Enable Wireless Printing** to complete the COM port registration. To change your COM port selection, clear (uncheck) the **Enable Wireless Printing** box, select a new COM port, then check **Enable Wireless Printing** again. COM ports that already are in use are grayed out.

When you enable Wireless Printing, a status message is shown near the bottom of the screen to confirm your action. To print a test page to your printer, tap **Print Test Page**.

Tap **ok** to return to the Wireless Printing page.

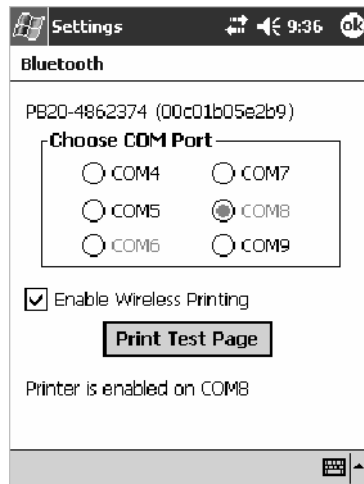

File Transfer

Use this page to enable your unit to receive files from another Bluetooth device, or from any device that supports this function.

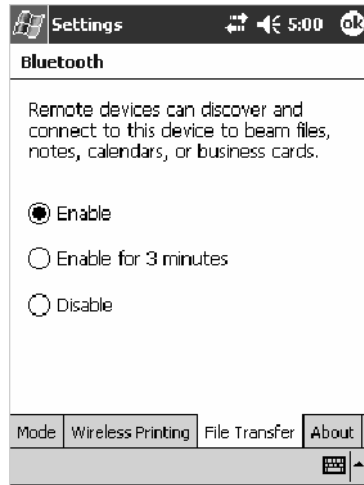

From this point, this transfer is similar to an IrDA file transfer. To transfer a file, tap **Start > Programs > File Explorer** and locate the file to transfer. Press and hold on the file for a pop-up menu, then select **Beam File**.



The system searches for a list of Bluetooth devices that will accept a connection from your unit. When the list is complete, tap on a device to which to send the file. *Note: in some cases, the user of the target device has to “accept” the file before it is transmitted.*

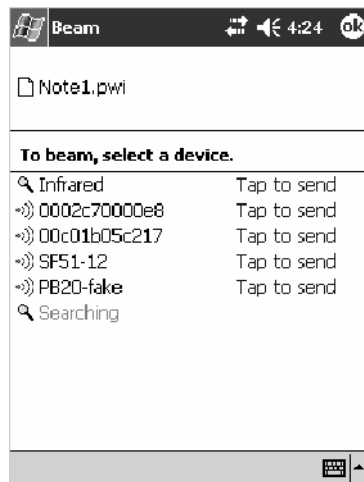

AutoIP/DHCP

Automatic Private IP Addressing (AutoIP) is enabled by default in Windows Mobile 2003. To remain compatible with other versions of Pocket PC, this setting needs to be enabled. You can configure the registry settings in the following to set the required AutoIP/DHCP behavior:

- For Ethernet: `HKEY_LOCAL_MACHINE\Comm\LAN9001\TcpIp`
- For 802.11b: `HKEY_LOCAL_MACHINE\Comm\NETWLAN1\TcpIp`

Other registry keys that can modify the behavior of AutoIP are as follows. You can find the appropriate settings and behavior of each of these keys in Microsoft Help.

- AutoInterval
- AutoMask
- AutoSubnet
- AutoIP
- AutoSeed

When a TCP/IP client cannot find a DHCP server, it generates an AutoIP address from the 169.254.xxx.xxx block. The client then tries to check for a DHCP server every 300 seconds (5 minutes) and if a DHCP server is found, the client drops the AutoIP address and uses the address from the DHCP server.

In the MSDN Windows CE documentation available out on the Microsoft Developer Network web site (<http://www.msdn.com>), see “*Automatic Client Configuration*” for more information on AutoIP.

To disable AutoIP, set the AutoCfg registry entry to “0.” If a DHCP server cannot be found, instead of using AutoIP, the system will display the “Unable to obtain a server assigned IP address” message.



Note: If AutoIP is defined using CAB files, the EnableDHCP registry key must also be defined and set to “1” before the system will attempt to obtain a DHCP address.



Note: To extend the number of attempts that a DHCP client makes to get a DHCP address, use the DhcpRetryDialogue and DhcpMaxRetry registry settings.



Note: Change the AutoInterval registry key value to make the client retry more often to obtain a DHCP address.

SNMP Configuration on the 700 Series Computer

In short, SNMP is an application-layer protocol that facilitates the exchange of management information between network devices. The 700 Series Computer is such an SNMP-enabled device. Use SNMP to control and configure the 700 Series Computer anywhere on an SNMP-enabled network.

The 700 Series Computer supports four proprietary Management Information Bases (MIBs) and Intermec Technologies provides SNMP support for MIB-II through seven read-only MIB-II (RFC1213-MIB) Object Identifiers (OIDs).



Note: You can only query these seven OIDs through an SNMP management station.

Management Information Base

The Management Information Base is a database that contains information about the elements to be managed. The information identifies the management element and specifies its type and access mode (Read-Only, Read-Write). MIBs are written in ASN.1 (Abstract Syntax Notation.1) — a machine independent data definition language. *Note: Elements to be managed are represented by objects. The MIB is a structured collection of such objects.*

You will find the following MIB files either in the 700 Color Management Tools portion of the *Intermec Developer's Library CD* or on the web via <http://www.intermec.com>:

- **INTERMEC.MIB**
Defines the root of the Intermec MIB tree.
- **ITCADC.MIB**
Defines objects for Automated Data Collection (ADC), such as bar code symbologies.
- **ITCSNMP.MIB**
Defines objects for Intermec SNMP parameters and security methods, such as an SNMP security IP address.
- **ITCTERMINAL.MIB**
Defines objects for 700 Series parameters, such as key clicks.

Object Identifiers

Each object has a unique identifier called an OID, which consist of a sequence of integer values represented in dot notation. Objects are stored in a tree structure and OIDs are assigned based on the position of the object in the tree. For example, the internet OID is equal to 1.3.6.1. Seven MIB OIDs are shown in the following table:

MIB Object Identifiers

MIB-II Item	OID	Group or Table	Description
ifNumber	1.3.6.1.2.1.2.1.0	Interfaces Group	Indicates the number of adapters present in the system. For the 700 Series Computer, if one adapter is present in the system, then <i>ifNumber</i> = 1 and <i>ifIndex</i> = 1.
ifIndex	1.3.6.1.2.1.2.2.1.1.ifIndex	Interfaces Table (ifTable)	A unique value for each interface. The value ranges between 1 and the value of <i>ifNumber</i> .
ifDescr	1.3.6.1.2.1.2.2.1.2.ifIndex	Interfaces Table (ifTable)	A textual string containing information about the interface.
ifType	1.3.6.1.2.1.2.2.1.3.ifIndex	Interfaces Table (ifTable)	An integer containing information about the type of the interface. It is equal to 1 for Other.
ipAdEntAddr	1.3.6.1.2.1.4.20.1.1.IpAddress	IP address Table (ipAddrTable)	The IP address to which this entry's addressing information pertains (<i>same as 700 IP address</i>), where IP Address is the valid non-zero IP address of the 700 Series Computer.
ipAdEntIfIndex	1.3.6.1.2.1.4.20.1.2.IpAddress	IP address Table (ipAddrTable)	The index value that uniquely identifies the interface to which this entry is applicable (<i>same as ifIndex</i>).
ipAdEntNetMask	1.3.6.1.2.1.4.20.1.3.IpAddress	IP address Table (ipAddrTable)	The subnet mask associated with the IP address of this entry (<i>same as Subnet Mask</i>).

Configuring with SNMP

The community string allows an SNMP manager to manage the 700 Series Computer with a specified privilege level. The default read-only community string is “public” and “private” is the default read/write community string. See the specific configuration parameter to find its OID. To configure the 700 Series Computers using SNMP:

- 1 Configure 700 Series Computers for RF or Ethernet communications.
- 2 Determine the OID (Object Identifier) for the parameter to be changed. The Intermec base OID is 1.3.6.1.4.1.1963.
- 3 Use your SNMP management station to get and set variables that are defined in the Intermec MIBs. You can set the traps, identification, or security configuration parameters for SNMP. See *Appendix A, “Configurable Settings,”* to learn more about these parameters.



5 Printer Support

The 700 Series Color Mobile Computer works with the following printers from Intermec Technologies. Contact an Intermec representative for information about these printers.

- **6820**
A full-page, 80-column printer.
- **6808**
A 4-inch belt-mount printer.
- **PB20**
A 2-inch belt-mount printer with a Bluetooth compatible module from Socket Communications.
- **782T**
A 2-inch workboard printer.

Printing ASCII

The following methods for printing using Pocket PC at this time is as follows:

- Add port drivers to print ASCII directly to the port.
- Use LinePrinter ActiveX Control from the Software Developer's Kit (SDK) - *see the SDK User's Manual for more information.*
- Via wireless printing - *see the Wireless Printing Development Guide on the Intermec Developer's Library CD for more information.*

Directly to a Port

Printing directly to the port sends RAW data to the printer. The format of this data depends upon your application and the printer capabilities.

You must understand the printer commands available for your specific printer. Generally, applications just send raw ASCII text to the printer. Since you are sending data to the printer from your application directly to the port you are in complete control of the printers operations. This allows you to do line printing (*print one line at a time*) rather than the page format printing offered by the GDI approach. It is also much faster since data does not have to be converted from one graphics format to the other (display to printer). Most Intermec[®] printers use Epson Escape Sequences to control print format operations.

These commands are available in documentation you receive with your printers or from technical support. Win32 APIs are required to print directly to the port.

Directly to a Generic Serial Port

To print directly to a generic serial port printer (non-Intermec printers):

- Use CreateFile() to open ports - COM1: can be opened on most devices.
- Use WriteFile() to send data directly to the printer.
- Use CloseHandle() when you are finished printing to close the port.

IrDA Printer Driver

IrDA printing is only available on the certain devices and is supported directly by the Windows CE load via the IrSock API provided by the Microsoft Win32 API without need for additional drivers. Intermec 6804, 6805, 6806, 6808 and 6820 and other IrDA printers are supported.

NPCP Printer Driver

The NPCP printer communications driver (NPCPPORT.DLL) is a Stream Device Driver built into the operating system. The driver supports only NPCP communications to and from the 6820 and 4820 printers over a selected serial port.

All applications use WIN32 API functions to access the drivers. Basic operations are easily implemented by applications through the CreateFile(), WriteFile(), ReadFile(), DeviceIOControl(), and CloseHandle() Win32 APIs.

Operations to upgrade printer modules, perform printer diagnostics, and get printer configuration are performed largely via DeviceIOControl() functions.

About NPCP

NPCP (Norand[®] Portable Communications Protocol) is a proprietary protocol that provides session, network, and datalink services for Intermecc mobile computers in the Intermecc LAN environment used with printers and data communications.

NPCP Driver Installation and Removal

Use LPT9: for the NPCP printer device and COM1 for the last parameter. COM1 is the connection available via the 700 Series Computer.

Applications use the RegisterDevice() function to install the driver. DeregisterDevice() uninstalls the device driver and frees memory space when the driver is not required. Use the HANDLE returned by RegisterDevice() as the parameter to DeregisterDevice().

Use the RegisterDevice() function call as demonstrated below. Specify the full path name to the driver starting at the root for the RegisterDevice() function to work properly. The last parameter to RegisterDevice() is a DWORD that represents the name of the port for the NPCP stream driver to use. Build this parameter on the stack if it is not to be paged out during the call. The first parameter "LPT" (Device Name) and the second parameter "9" (index), indicate the name of the registered device, such as LPT9. This is used in the CreateFile() function call.

```
Install()
{
    HANDLE hDevice;
    TCHAR port[6];
    port[0] = TCHAR('C');
    port[1] = TCHAR('O');
    port[2] = TCHAR('M');
    port[3] = TCHAR('9');
    port[4] = TCHAR(':');
    port[5] = TCHAR(0);
    hDevice = RegisterDevice ( (TEXT("LPT"), 9,
    TEXT("\\STORAGE CARD\\WINDOWS\\NPCPPORT.dll"), (DWORD)port);
}
```

Opening the NPCP Driver

The application opens the NPCP driver by using the `CreateFile()` function. The call can be implemented as follows. The first parameter “LPT9:” must reflect the device name and index used in the `RegisterDevice()` function call and will fail for any of the following reasons:

```
hFile = CreateFile(_T("LPT9:"), GENERIC_WRITE |  
GENERIC_READ, 0, NULL, OPEN_ALWAYS, FILE_ATTRIBUTE_NORMAL,  
NULL);
```

- The port associated with the device during `RegisterDevice()` is in use.
- The NPCP device is already open.
- The share mode is not set to zero. The device cannot be shared.
- Access permissions are not set to `GENERIC_WRITE | GENERIC_READ`. Both modes must be specified.

Closing the NPCP Driver

Using the `CloseHandle()` (`hFile`) function closes the NPCP driver. Where *hFile* is the handle returned by the `CreateFile()` function call.

- TRUE = the device is successfully closed.
- FALSE = an attempt to close NULL HANDLE or an already closed device.

Reading from the NPCP Driver

Reading of the NPCP printers is not supported since all responses from the printer are the result of commands sent to the printer. `DeviceIoControl()` functions are provided where data is to be received from the printer.

Writing to the NPCP Driver

All Print data can be sent to the printer using the `WriteFile()` function. The print data written to the driver must contain the proper printer commands for formatting. If the function returns FALSE, the NPCP error may be retrieved using `IOCTL_NPCP_ERROR`. See the description on the next page.

NPCP Driver I/O Controls

An application uses the DeviceIoControl() function to specify a printer operation to be performed. Certain I/O controls are required to bind and close communication sessions with the printer, and must be completed before any other commands to the driver can execute properly.

The function returns TRUE to indicate the device successfully completed its specified I/O control operation, otherwise it returns FALSE. The following I/O control codes are defined:

```
#define IOCTL_NPCP_CANCEL
CTL_CODE(FILE_DEVICE_SERIAL_PORT, 0x400, METHOD_BUFFERED, FILE_ANY_ACCESS)
#define IOCTL_NPCP_BIND
CTL_CODE(FILE_DEVICE_SERIAL_PORT, 0x401, METHOD_BUFFERED, FILE_ANY_ACCESS)
#define IOCTL_NPCP_CLOSE
CTL_CODE(FILE_DEVICE_SERIAL_PORT, 0x402, METHOD_BUFFERED, FILE_ANY_ACCESS)
#define IOCTL_NPCP_ERROR
CTL_CODE(FILE_DEVICE_SERIAL_PORT, 0x403, METHOD_BUFFERED, FILE_ANY_ACCESS)
#define IOCTL_NPCP_FLUSH
CTL_CODE(FILE_DEVICE_SERIAL_PORT, 0x404, METHOD_BUFFERED, FILE_ANY_ACCESS)
#define IOCTL_NPCP_IOCTL
CTL_CODE(FILE_DEVICE_SERIAL_PORT, 0x405, METHOD_BUFFERED, FILE_ANY_ACCESS)
#define IOCTL_NPCP_PRTVER
CTL_CODE(FILE_DEVICE_SERIAL_PORT, 0x406, METHOD_BUFFERED, FILE_ANY_ACCESS)
```

- **IOCTL_NPCP_CANCEL**
This cancels all printing at the printer. It flushes the printer buffers and reinitializes the printer to its default state. No parameters are required.
- **IOCTL_NPCP_BIND**
This command is required before any data is sent or received by the printer. Once the driver is opened, the application must bind the communications session with the printer before any data can be sent or received by the printer. If an error occurs during the bind, the application may use IOCTL_NPCP_ERROR to get the current extended error code. No parameters are required.
- **IOCTL_NPCP_CLOSE**
This command closes the current session with the printer. This function always returns TRUE. No parameters are required.
- **IOCTL_NPCP_ERROR**
This command returns the extended NPCP error code in PL/N format. The word returned will contain the PL/N compatible error code in the low byte and completion flags in the high byte. If the frame that returned an error was not received correctly by the printer the FRAME_NOT_ACKED bit will be set in the high byte. This operation always returns TRUE. An output buffer of at least 2 bytes is required. See “NPCP Error Codes” on page 187.
- **IOCTL_NPCP_FLUSH**
This command allows the application to poll the printer for errors while the report is completing the print process at the printer. If an error occurs during the polling process, the operation will return FALSE and the application can get the extended error code by using IOCTL_NPCP_ERROR. No parameters are required.

NPCP Printer Communications

All NPCP printer communications should be based on the following flow:

- 1 Use `CreateFile()`; to open the printer driver.
- 2 Use `IOCTL_NPCP_BIND` to bind a session with the printer; `IOCTL_NPCP_ERROR` to check for errors on the bind to ensure success; and `IOCTL_NPCP_CANCEL` to cancel any outstanding print jobs.
- 3 Use `IOCTL_NPCP_FLUSH` to poll the printer to free up printer buffer resources. Use `IOCTL_NPCP_FLUSH` to poll the printer's status. If an error is reported by the IOCTL, then use `IOCTL_NPCP_ERROR` to get the error and determine the correct recovery procedure.
- 4 Use `WriteFile()`; to write your data to the printer. Check for errors and that all data were written. Use `IOCTL_NPCP_ERROR` to get the extended error. If the error is critical in nature, use `IOCTL_NPCP_CLOSE`, followed by `CloseFile()`, to end the communications session. Start a new session, beginning with step 1 to ensure proper printing. For noncritical errors display the error and retry the operation.
- 5 After all data is sent to the printer, ensure that the printer continues to print the report properly by polling the printer's status. Use `IOCTL_NPCP_FLUSH` to poll the printer's status. If an error is reported by the IOCTL, then use `IOCTL_NPCP_ERROR` to get the error and determine the correct recovery procedure.

Sample Code

See sample code in the “\700C Dev Tools\Installable Drivers\Port Drivers\Npcp\NPCPPrint\” directory for more details on printing, printer communications and error code handling.

NPCP Error Codes

Call the `IOCTL_NPCP_ERROR` I/O control function to receive PL/N compatible error codes. Applications must decide how to act upon the data returned.

```
// Definition of NPCP communications Errors and Printer Errors
#define PNRDY (BYTE)102 // link not ready error
#define RXTMO (BYTE)104 // link no receive error
#define TXTMO (BYTE)106 // link no transmit error
#define BADADR (BYTE)111 // frame address error
#define GAPERR (BYTE)112 // link gap error (timeout) in receive data
#define LSRPE (BYTE)113 // frame parity error on length field
#define IFTS (BYTE)120 // session layer - invalid frame this state
#define NS_NE_VR (BYTE)121 // session layer sequence error
#define NR_NE_VS (BYTE)122 // session layer sequence error
#define MAC_CRCERR (BYTE)124 // MAC CRC error
#define RLENERR (BYTE)123 // MAC too much data received
#define FRMERR (BYTE)200 // Frame Reject
#define FRMERR_IF (BYTE)201 // Frame Reject - Invalid Frame
#define FRMERR_NR (BYTE)202 // Frame Reject - NR Mismatch
#define FRMERR_NS (BYTE)203 // Frame Reject - NS Mismatch
#define NDMERR (BYTE)204 // Normal Disconnect mode error
#define BINDERR (BYTE)210 // bind error
#define IPLDUR (BYTE)221 // invalid presentation layer response
#define HEADJAM (BYTE)222 // printer head jam
#define PAPEROUT (BYTE)223 // printer paper out
#define LOWVOLTS (BYTE)224 // printer low voltage
#define HIVOLTS (BYTE)225 // printer over voltage
#define LOWBAT (BYTE)226 // printer low battery
#define COVEROFF (BYTE)227 // printer cover off error
#define HEADFAULT (BYTE)228 // printer head short or driver short error
#define PFFAULT (BYTE)229 // paper feed motor fault.
#define FRAME_NOT_ACKED 0x8000 // frame was not received by printer and need
to be resent.
```

O'Neil Printer Driver

The DTR printer communications driver is a Stream Device Driver named ONEIL.DLL.

All applications use WIN32 API functions to access drivers. Basic operations are easily implemented by applications through the CreateFile(), WriteFile(), DeviceIOControl() and CloseHandle() Win32 APIs.

The driver supports communications to 6804DM, 6804T, 6805A, 6806, 6808, 681T, and PB20 printers over a selected serial port.

DTR Driver Installation and Removal

Your application must install the device driver by using the RegisterDevice() function. The driver name is ONEIL.DLL. We recommend that you use "DTR" for the Device Name parameter, "1" for the Device Driver index parameter, and use any of the following strings for the last parameter:

- NULL (==0) Defaults to COM1 @ 9600
- "COM1" only COM port specified defaults to 9600
- "COM1:9600" sets to COM port and specified bit rate
- "COM1:19200" sets to COM port and specified bit rate

Use the HANDLE returned by RegisterDevice() as the parameter to DeregisterDevice(). The correct usage of the RegisterDevice() function call is demonstrated below. You may use DeregisterDevice() to uninstall the driver.

```
Install()
{
    HANDLE hDevice;
    TCHAR port[6];
    port[0] = TCHAR('C');
    port[1] = TCHAR('O');
    port[2] = TCHAR('M');
    port[3] = TCHAR('1');
    port[4] = TCHAR(':');
    port[5] = TCHAR(' ');
    hDevice = RegisterDevice ( (TEXT("DTR"), 1, TEXT("\\WINDOWS\\ONEIL.DLL"),
        (DWORD)port);
}
```

Opening the DTR Driver

The application opens the DTR driver by using the `CreateFile()` function. The call can be implemented as follows:

```
hFile = CreateFile(_T("DTR1:"), GENERIC_WRITE, 0, NULL,
OPEN_ALWAYS, FILE_ATTRIBUTE_NORMAL, NULL);
```

The first parameter “DTR1:” must reflect the device name and index used in the `RegisterDevice()` function call.

The function call will fail for any of the following reasons:

- The port associated with the device during `RegisterDevice()` is currently in use.
- The DTR device is already open.
- The share mode is not set to zero. The device cannot be shared.
- Access permissions are not set to `GENERIC_WRITE`.

Closing the DTR Driver

Using the `CloseHandle()` (`hFile`) function closes the DTR driver. Where *hFile* is the handle returned by the `CreateFile()` function call.

- `TRUE` indicates the device is successfully closed.
- `FALSE` indicates an attempt to close a `NULL HANDLE` or an already closed device.

Writing to the DTR Driver

You can use the `WriteFile()` function to send all Print data to the printer. The print data being written must contain the proper formatting printer commands.

DTR Printer Communications

All DTR printer communications should be based on the following flow:

- 1 Use `CreateFile()`; to open the printer driver.
- 2 Use `WriteFile()` to write your data to the printer. Check for errors and that all data were written.
- 3 Use `CloseHandle()` to close the driver.



6 Scanner Support

The 700 Series Color Mobile Computer is available with imaging or laser scanning technologies, including the following:

<p>APS Linear Imager: (standard for 730 Computers) — includes the EV10 Scan Engine</p>	<p>Reads 1D symbologies and PDF417 bar codes. Linear imaging using Vista Scanning technology reads low-contrast bar codes, laminated bar codes, and bar codes displayed on CRT or TRT displays. This imaging uses harmless LEDs for illumination and does not require any warning labels. Vista Scanning is more reliable than lasers as it is a completely solid state with no moving parts or oscillating mirrors.</p>
<p>2D Imager: (not supported on 730 Computers) — includes the IT4000 Scan Engine</p>	<p>This decodes several stacked 1D and 2D symbologies, including PDF417, Data Matrix, and MaxiCode without “painting.” It can also read 1D codes from any orientation, for example the scan beam does not need to align perpendicular to the symbol to read it. Photography is a secondary application; the lens in the device favors bar code reading. Photos are 640x480, 256 gray-scale.</p>
<p>1D Laser Scanner: (not supported on 730 Computers) — includes the SE900, SE900HS, SE900-S6, and SE900HS-S6 scan engines</p>	<p>Traditional laser scanner that decodes 1D bar codes.</p>
<p>PDF417 Laser Scanner: (not supported on 730 Computers)</p>	<p>Higher speed laser scanner that can read PDF417 labels by “painting” the label.</p>

A 700 Color Imager Demo application demonstrates the more common features of the 700 Color Computer imager. See the *Imager Demo V1.0 User’s Guide* on the *Intermec Developer’s Library CD* for information.

Scanner Control and Data Transfer



Note: To use the methods described below, enable Data Collection functionality on the 700 Computer using the bootloader configuration menu.

The Data Server and associated software provide several ways to manipulate scanner control and data transfer between the scanner subsystem and user applications:

- **Automatic Data Collection COM Interfaces:**
These COM interfaces allow user applications to receive bar code data, and configure and control the bar code reader engine.
- **ITCAxBarCodeReaderControl functions:**
These ActiveX controls allow user applications to collect bar code data from the scanner, to configure the scanner, and to configure audio and visual notification when data arrives.
- **ITCAxReaderCommand functions:**
Use these ActiveX controls to modify and retrieve configuration information using the reader interface commands.
- **Scanning EasySet bar code labels:**
You can use the EasySet[®] bar code creation software from Intermec Technologies Corporation to print configuration labels. Scan the labels to change the scanner configuration and data transfer settings.

For more information, see the *SDK User's Manual* provided with your *Windows CE/PocketPC SDK*.

EasySet Software

Use the Intermec EasySet software to print configuration labels you can scan to change your configuration settings. For more information, see the EasySet online help. EasySet is available from the Intermec Data Capture web site.

Data Collection Configuration



For Units with PSM Builds Older than 3.00

Scanner settings for the 700 Series Computer can be configured via the **Data Collection** control panel applet. From the 700 Series Computer, tap **Start > Settings > the System tab > Data Collection**. See *Appendix A*, “Configurable Settings” for more information about the following parameters. *Note that these are in alphabetical order.*

- Codabar (*page 318*)
- Code 11 (*page 332*)
- Code 128 (*page 321*)
 - Code 128 Options (*page 322*)
 - Code 128 FNC1 Character (*page 323*)
- Code 39 (*page 316*)
- Code 93 (*page 320*)
 - Code 93 Length (*page 320*)
- Data Matrix (*page 334*)
- Interleaved 2 of 5 (*page 329*)
- Matrix 2 of 5 (*page 330*)
- MaxiCode (*page 335*)
- MSI (*page 325*)
- PDF417 (*page 326*)
 - Macro PDF (*page 326*)
 - Micro PDF417 (*page 328*)
- Plessey (*page 324*)
- QR Code (*page 333*)
- Standard 2 of 5 (*page 317*)
- Telepen (*page 331*)
- UPC/EAN (*page 319*)

For Units With PSM Build 3.00 or Newer



You can configure scanner settings for the 700 Series Computer via the **Intermec Settings** control panel applet. From the 700 Series Computer, tap **Start > Settings > the System tab > the Intermec Settings icon**. See the *Intermec Computer Command Reference Manual* (P/N: 073529) for information about the settings you can configure with this applet. This online manual is available from the Intermec web site at www.intermec.com.

Internal Scanners

The Intermec Internal Scanner feature allows Automatic Data Collection (ADC) by accepting data from the COM1 port and wedging it into the keyboard interface. You can enable or disable this feature from the Today screen on the 700 Series Computer.

For Units With PSM Build 3.00 or Newer

Do the following before you configure your internal scanner from the Intermec Settings control panel applet. Information about the settings you can configure with this applet is described in the *Intermec Computer Command Reference Manual*. The online manual is available from the Intermec web site at www.intermec.com.



Intermec
Settings

- 1 From the 700 Series Computer, tap **Start** > **Settings** > the **System** tab > the **Intermec Settings** icon.

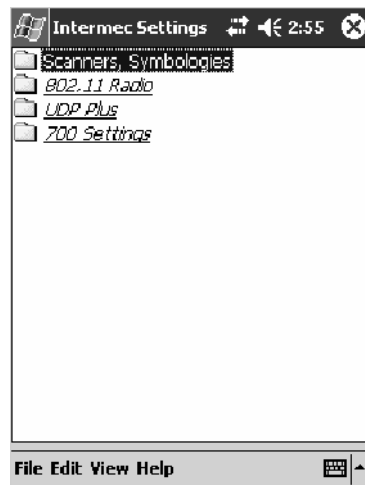

- 2 Double-tap the **Scanners, Symbolologies** folder, then expand (+) the **Internal Scanner** option. *This sample screen is for the IT4000 scan engine.*

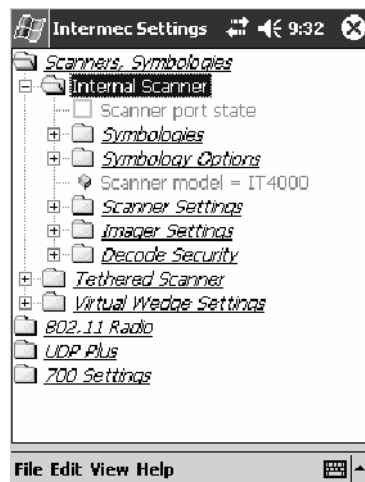

Scanner and Imager Settings

Depending on what is selected as the scanner model, image settings, decode security, scanner settings, and virtual wedge are configured from the Intermec Settings applet. See the the *Intermec Computer Command Reference Manual*, available from the Intermec web site at www.intermec.com, for more information about each enabled option.

Internal Scanner Supported Symbolologies

See the following table for a guideline and Appendix B, “*Bar Code Symbolologies*” for more information on each supported symbology:

Symbologies	EV10	IT4000	SE900	SE900HS	SE900-S6	SE900HS-S6
Code39	X	X	X	X	X	X
UPC/EAN	X	X	X	X	X	X
Code 128	X	X	X	X	X	X
Interleaved 2 of 5	X	X	X	X	X	X
Code 93	X	X	X	X	X	X
Codabar	X	X	X	X	X	X
Code 2 of 5	X	X	X	X	X	X
MSI	X	X	X	X	X	X
Plessey	X	X	X	X	X	X
Code 11	X	X	X	X	X	X
Matrix 2 of 5	X	X	X	X	X	X
Telepen	X	X	X	X	X	X
PDF417	X	X	X	X	X	X
Micro PDF417	X	X	X	X	X	X
MaxiCode		X				
Data Matrix		X				
QR Code		X				
RSS 14	X	X	X	X	Available in f/w Sxxp304	Available in f/w Sxxp304
RSS Limited	X	X	X	X	Available in f/w Sxxp304	Available in f/w Sxxp304
RSS Expanded	X	X	X	X	Available in f/w Sxxp304	Available in f/w Sxxp304
Codablock A	X	X	X	X	X	X
Codablock F	X	X	X	X	X	X
UCC Composite		X				

Tethered Scanners

The Intermec Tethered Scanner feature allows Automatic Data Collection (ADC) by accepting data from the COM1 port and wedging it into the keyboard interface. You can enable or disable this feature from the Today screen on the 700 Series Computer.

The following information is divided between units with PSM Builds older than 3.00 (*next paragraph*) or units with PSM Builds 3.00 or newer (*starting on page 201*).

For Units With PSM Builds Older than 3.00

Enabling and Disabling



On the 700 Series Computer, tap **Start > Today**. Tap the bar code scanner icon in the System Tray (*circled below*). Initially, the bar code scanner icon indicates that this feature is disabled (*shown to the left*).

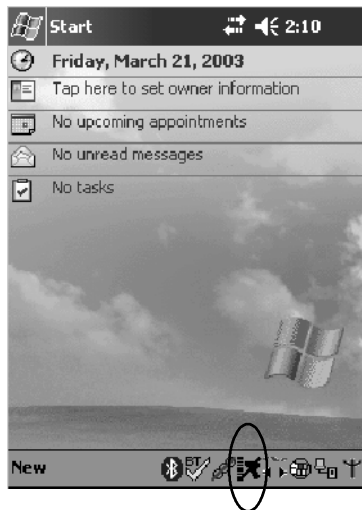

- Select **Comm Port Wedge** to send any data, coming into the 700 Series Computer through the COM1 port from an external input device, as keyboard data to an application on the desktop.

For example, if you have Pocket Word running on your 700 Series Computer desktop, information scanned with a scanner connected to the COM1 port appears in the Word document. If another data collection application is running and is active on the 700 Series Computer, the scanned information appears in that application.



Note: When **Comm Port Wedge** is selected, regardless of the data sent by the external input device, you cannot control the device or the data format using any of the Intermec scanner control or data transfer APIs from the SDK or the internal Data Collection software. The external input device is governed by what software it has onboard to tell it how to scan, take pictures, or send the data elsewhere.

- Select **1551/1553** to enable the Sabre 1551E or 1553 Tethered Scanner to scan, then send data as keyboard data. The 1551/1553 Tethered Scanner has software onboard that translates scanned data into characters, so the running/active application does not need to know how to do that. All the scanner control and data transfer APIs will work with the 1551/1553 Tethered Scanner, so you can control the device.
- Select **Disable All** to disable this feature and use the COM1 port for another application, such as ActiveSync. An error message will result if this option were not selected, but this action was attempted. Similarly, if ActiveSync is using the COM1 port, and you select **Comm Port Wedge** or **1551/1553**, an error message will result. See “*Error Message*” for more information.

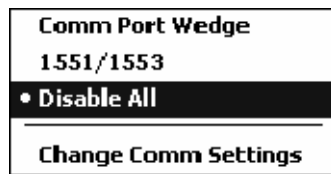

Error Message

If the COM1 port is used by another application, such as ActiveSync, neither the Comm Port Wedge nor the 1551/1553 Tethered Scanner can be enabled. As a result, the following message may appear. *Note that this message is for the Comm Port Wedge.* You must disable that application to free up the COM1 port before you can enable either the wedge or the scanner.



Changing Comm Settings

Tap **Change Comm Settings** to configure the settings for the COM1 port. Current settings are restored after a warm-boot is performed, but are lost after a cold-boot is performed. When these settings are not changed, the OK button is disabled (grayed out). When changes are made, tap **OK** after it is enabled to accept these changes.

- **Baud Rate:** 1200, 2400, 4800, 9600, 19200, 38400, 57600, 115200
- **Data Bits:** 7 or 8
- **Parity:** None, Odd, Even, Mark, Space
- **Stop Bits:** 1 or 2
- **Flow Control:** None or Hardware

Tethered Scanner

Default settings for the Tethered Scanner are shown in this illustration:

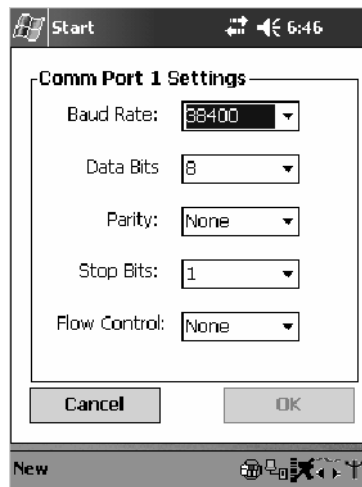

Sabre 1551E or 1553 Tethered Scanner

The default communication configuration for the Sabre 1551E or 1553 Tethered Scanner is shown in the following illustration. Scan the EasySet Reset Factory Defaults label to set the Sabre 1551E or 1553 tethered scanner communications settings to this configuration. The COM1 port configuration settings must also match those of the scanner to scan labels.

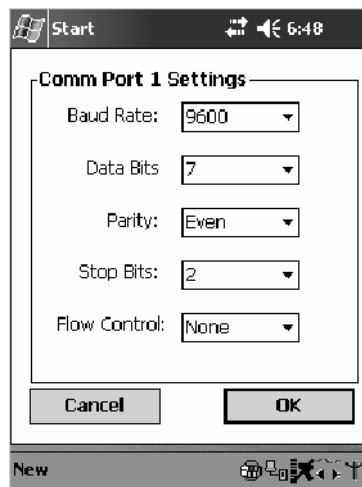

Welch Allyn 1470 Imager Settings

You can set the Welch Allyn 1470 Imager to this configuration by scanning the Factory Default Settings label.

Scanner Cabling

A null modem cable is required for the Welch Allyn 1470 Imager to communicate with the 700 Series Computer when using the 700 Series Serial Cable (P/N: 226-999-001).

Sabre 1551E / 1553 Cables connect directly to the Model 700 COM Port.

Limitations and Capabilities

The Tethered Scanner has the following limitations:

- No auto detection of a scanner's physical connection to COM1 port. User needs to ensure the communication settings of COM1 port matched the settings of the device.
- The Pocket PC Pocket Office applications misbehave when control characters such as carriage return are wedged. This is a known Pocket PC problem, which is being worked with Microsoft and for which a work around is being developed.
- Communications port is COM1 and cannot be changed.
- A complete bar code label is detected when the time between bytes (the inter-byte gap) exceeds 100 ms. This allows that data could be concatenated if two labels were received while the Comm Port Wedge or the 1551/1553 Tethered Scanner was not performing a read. That is, it could be wedging data just read or the read thread could be preempted. Also, the labels could appear concatenated if the scanner itself were to buffer the labels before transmitting them.

When enabled, the “Comm Port Wedge” menu option has this limitation:

- There is no bar code API to get bar code data from the bar code scanner. The Comm Port Wedge transmits the data through the keyboard interface only.

When enabled, the “1551/1553” menu option has these capabilities:

- Grid Data Editing is available.
- The source of the symbology configurations is only available via the Easy Set command labels. You can only configure the Virtual Wedge configurations via the Data Collection control panel applet Virtual Wedge page. See Appendix A, “*Configurable Settings*,” for information.
- May transmit the data through the keyboard interface (via the Virtual Wedge).

- The bar code APIs, defined in the IADC interface, are available to get bar code data from the bar code scanner. The following example shows how to programmatically collect bar code data:

```
#include "IADC.h" // Linked with ITCUUID.LIB
#include "ITCAdcMgmt.h" // Linked with ITCAdcDevMgmt.lib

IADC* pIADC;
HRESULT hrStatus = S_OK;

// Create a ADC COM interface to collect bar code data from the 1551E/1553
// when the 1551/1553 menu option is enabled.
hrStatus =
ITCDeviceOpen(TEXT("ExtScanner"), // Name of the ADC device.
IID_IADC, // COM interface to return
ITC_DHDEVFLAG_READAHEAD, // Device's Flags
(LPVOID *) &pIADC); // the returned interface

if( SUCCEEDED(hrStatus) )
{
BYTE byteBuffer[MAX_LABEL_SIZE];
DWORD dwLength = 0;
HRESULT hr = pIADC->Read(
byteBuffer, // Buffer to put the ADC data.
MAX_LABEL_SIZE, // Size of pDataBuffer in bytes.
&dwLength, // Number bytes returned.
NULL, // Time stamp of the received data. NULL.
INFINITE // Number of milliseconds to wait.
);
}

when done using this COM interface, delete it:
ITCDeviceClose( (IUnknown **) pIADC);
```

For Units With PSM Build 3.00 or Newer

Configuring the Tethered Scanner

Do the following before you configure your tethered scanner from the Intermec Settings control panel applet. Information about the settings you can configure with this applet is described in the *Intermec Computer Command Reference Manual*. The online manual is available from the Intermec web site at www.intermec.com.

- 1 Connect your tethered scanner to the tethered scanner port.
- 2 From the 700 Series Computer, tap **Start** > **Settings** > the **System** tab > the **Intermec Settings** icon.

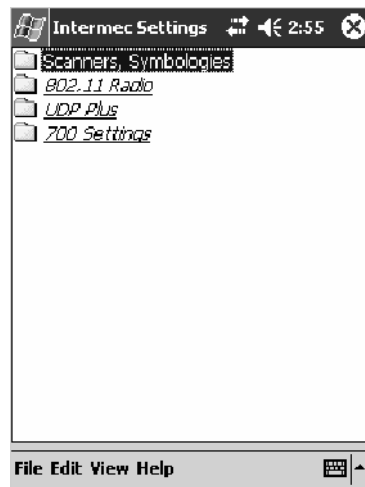

- 3 Double-tap the **Scanners, Symbolologies** folder, then expand (+) the **Tethered Scanner** option.

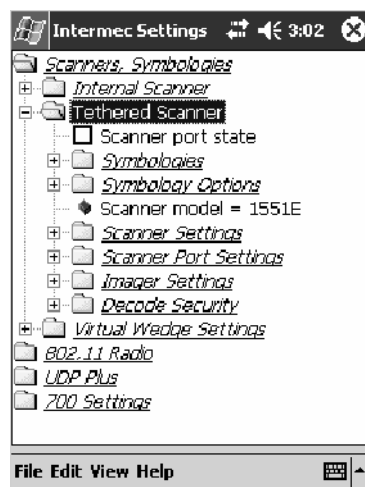

- 4 Tap the **Scanner model** option for a drop-down list, then select the applicable scanner, such as “1551E” or “1553” in this sample screen.

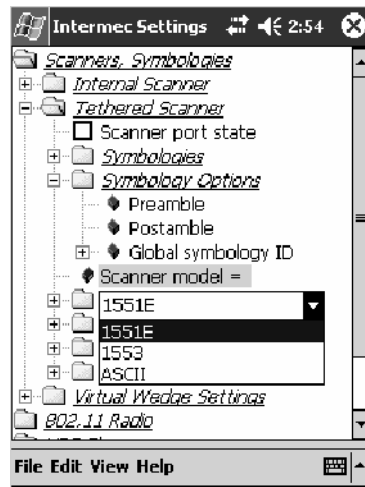

- 5 Make sure a scanner is connected to your 700 Computer properly. Then, tap to check **Scanner Port State**, then tap **File > Save Settings** from the bottom of the screen. These changes will take several moments to reset.

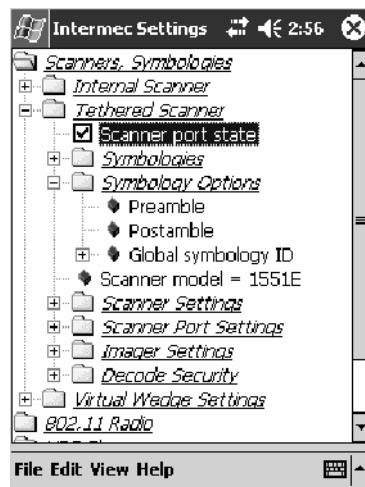

1551E or 1553 Selected for Scanner Model

When “1551E” or “1553” is selected from the **Scanner model** option (see step 4 above), and the port state is already enabled (see step 5), the process will take several moments to reset. When 1551E or 1553 is successfully connected during this step, the unit will emit some beeps. Here, the terminal is initializing the scanner at 9600 for the baud rate, 7 data bits, even parity, and 2 stop bits and synchronizing the terminal’s configuration with the attached scanner.

With “1551E” or “1553” selected, Symbologies, Symbology Options, Hardware Trigger, and Scanner Port settings are configured from the Intermec Settings applet. See the the *Intermec Computer Command Reference Manual*, available from the Intermec web site at www.intermec.com, for more information about each enabled option.

ASCII Selected for Scanner Model

To send data coming into the 700 Series Computer through the COM1 port from an external input device, as keyboard data to an application on the desktop, do the following:

- 1 Select “ASCII” from the **Scanner model** option.
- 2 Tap to check **Scanner Port State**.
- 3 Tap **File > Save Settings** from the bottom of the screen.

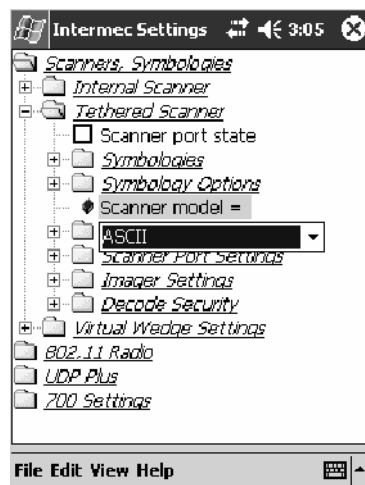

With “ASCII” selected, Symbology Options, Hardware Trigger, and Scanner Port settings are configured from the Intermec Settings applet. See the the *Intermec Computer Command Reference Manual*, available from the Intermec web site at www.intermec.com, for more information about each enabled option.



Note: When selecting either the 1551E or the 1553 Scanner or enabling the scanner port for these scanners, the 700 Computer tries to communicate with the attached scanner. If the scanner is not powered, if the cable is not connected properly, the wrong cable is used, or if the scanner firmware is older than 2.0, and the “Failed to save one or more settings” message appears, then this step failed.

This process can take time as the terminal is going through a group of RS-232 settings to communicate with the scanner. After successful communication with the scanner (about eight beeps are generated), it initializes the scanner with the 700 Computer’s current settings. This process might generate a series of beeps pending on the firmware version installed in the scanner. These beeps are suppressed in firmware versions 2.08 or greater.

Troubleshooting the 1551E/1553 Tethered Scanner

Do the following to troubleshoot your 1551/1553 Tethered Scanner:

- 1 Ensure the correct cable is used for the scanner on the tethered scanner port. *Note the 700 Computer cannot supply power to the scanner.*
- 2 Perform a quick test to determine whether the connection is good. Temporary select the scanner model as “ASCII,” then enable the scanner port state. Go to a command prompt or a notepad and scan a data label. If a label is wedged into the command prompt or notepad, then the connection is good.
- 3 If step 2 passes, reset the scanner configurations to their defaults (scan the Reset Factory Defaults label on the next page) to prevent miscommunication, then reenables the scanner port state.
- 4 If step 2 fails, then the firmware installed in the tethered scanner may be older than version 2.0. Upgrade your scanner firmware.

Reset Factory Defaults

Scan the EasySet software bar code label “Reset Factory Default” to restore all of your scanner’s configurations to their factory defaults. When this command label is scanned, reinitialize the tethered scanner (such as disable the scanner port state, then enable it) on the 700 Computer. Otherwise, the online configuration and scanning on the 700 Computer are not functional. In general, scan this label only to initially reset the scanner.

Do not scan EasySet command labels to change the following settings:

- Symbologies code mark
- Code 128, EAN29 Identifier
- Preamble and Postamble
- Enable/Disable symbologies
- Symbology ID transmit option

In some cases, scanning EasySet Command labels cause the current setting on the user interface to be out of sync with the scanner settings. However, in some cases, scanning these labels does corrupt scanned data.

The “Open COMx error: 0x00000037” message appears if the COM port cannot open due to another application using the port. Disable that application to free up the COM1 port before you can enable the scanner. “x” is the COM port number, such as 1, 2, or 3.

Tethered Scanner Supported Symbologies

The user interface may allow configuration of PDF417, Micro PDF417, RSS, and Codablock bar code symbologies. However, these symbologies are dependant on what scanner models and firmware versions are in use. See the following table for a guideline and Appendix B, “*Bar Code Symbologies*” for more information on each supported symbology:

You can use a generic ASCII scanner with the 700 Computer. Pending on the scanner, linear symbologies such as Code39, should decode correctly. However, 2D symbologies such as PDF417 may not decode correctly.

Symbologies	1551E	1553
Code39	X	X
UPC/EAN	X	X
Code 128	X	X
Interleaved 2 of 5	X	X
Code 93	X	X
Codabar	X	X
Code 2 of 5	X	X
MSI	X	X
Plessey	X	X
Code 11	X	X
Matrix 2 of 5	X	X
Telepen	X	X
PDF417	Available in 1551 0808 PDF	
Micro PDF417	Available in 1551 0808 PDF, Sxxp217_ or later	
MaxiCode		
Data Matrix		
QR Code		
RSS 14	F/w version 2.15 or later	F/w version 2.15 or later
RSS Limited	F/w version 2.15 or later	F/w version 2.15 or later
RSS Expanded	F/w version 2.15 or later	F/w version 2.15 or later
Codablock A	Available in 1551 0808 PDF	
Codablock F	Available in 1551 0808 PDF	
UCC Composite		

