

Exhibit O: CDMA SAR Report - Part 3 of 3

FCC ID: HN2ABTM3-3

APPENDIX C - SYSTEM VALIDATION

Schmid & Partner Engineering AG

Zeughausstrasse 43, 8004 Zurich, Switzerland, Phone +41 1 245 97 00, Fax +41 1 245 97 79

Calibration Certificate

1800 MHz System Validation Dipole

Type:

D1800V2

Serial Number:

247

Place of Calibration:

Zurich

Date of Calibration:

June 20, 2001

Calibration Interval:

24 months

Schmid & Partner Engineering AG hereby certifies, that this device has been calibrated on the date indicated above. The calibration was performed in accordance with specifications and procedures of Schmid & Partner Engineering AG.

Wherever applicable, the standards used in the calibration process are traceable to international standards. In all other cases the standards of the Laboratory for EMF and Microwave Electronics at the Swiss Federal Institute of Technology (ETH) in Zurich, Switzerland have been applied.

Calibrated by:

Blasius Kodja

Approved by:

N. K. S.

DASY

Dipole Validation Kit

Type: D1800V2

Serial: 247

Manufactured: August 25, 1999

Calibrated: June 20, 2001

1. Measurement Conditions

The measurements were performed in the flat section of the new generic twin phantom filled with head simulating glycol solution of the following electrical parameters at 1800 MHz:

Relative Dielectricity	40.0	$\pm 5\%$
Conductivity	1.36 mho/m	$\pm 5\%$

The DASY3 System (Software version 3.1c) with a dosimetric E-field probe ET3DV6 (SN:1507, Conversion factor 5.57 at 1800 MHz) was used for the measurements.

The dipole was mounted on the small tripod so that the dipole feedpoint was positioned below the center marking of the flat phantom section and the dipole was oriented parallel to the body axis (the long side of the phantom). The standard measuring distance was 10mm from dipole center to the solution surface. The included distance holder was used during measurements for accurate distance positioning.

The coarse grid with a grid spacing of 15mm was aligned with the dipole. The 5x5x7 fine cube was chosen for cube integration. Probe isotropy errors were cancelled by measuring the SAR with normal and 90° turned probe orientations and averaging.

The dipole input power (forward power) was 250mW $\pm 3\%$. The results are normalized to 1W input power.

2. SAR Measurement

Standard SAR-measurements were performed with the phantom according to the measurement conditions described in section 1. The results have been normalized to a dipole input power of 1W (forward power). The resulting averaged SAR-values are:

averaged over 1 cm ³ (1 g) of tissue:	38.64 mW/g
averaged over 10 cm ³ (10 g) of tissue:	20.08 mW/g

Note: If the liquid parameters for validation are slightly different from the ones used for initial calibration, the SAR-values will be different as well. The estimated sensitivities of SAR-values and penetration depths to the liquid parameters are listed in the DASY Application Note 4: 'SAR Sensitivities'.

3. Dipole Impedance and return loss

The impedance was measured at the SMA-connector with a network analyzer and numerically transformed to the dipole feedpoint. The transformation parameters from the SMA-connector to the dipole feedpoint are:

Electrical delay:	1.208 ns	(one direction)
Transmission factor:	0.995	(voltage transmission, one direction)

The dipole was positioned at the flat phantom sections according to section 1 and the distance holder was in place during impedance measurements.

Feedpoint impedance at 1800 MHz:	$\text{Re}\{Z\} = 52.4 \Omega$
	$\text{Im}\{Z\} = 0.7 \Omega$
Return Loss at 1800 MHz	-32.1 dB

4. Measurement Conditions

The measurements were performed in the flat section of the new generic twin phantom filled with brain sugar-water solution of the following electrical parameters at 1800 MHz:

Relative Dielectricity	40.1	$\pm 5\%$
Conductivity	1.71 mho/m	$\pm 5\%$

The DASY3 System (Software version 3.1c) with a dosimetric E-field probe ET3DV6 (SN:1507, Conversion factor 5.63 at 1800 MHz) was used for the measurements.

The dipole was mounted on the small tripod so that the dipole feedpoint was positioned below the center marking of the flat phantom section and the dipole was oriented parallel to the body axis (the long side of the phantom). The standard measuring distance was 10mm from dipole center to the solution surface. The included distance holder was used during measurements for accurate distance positioning.

The coarse grid with a grid spacing of 15mm was aligned with the dipole. The 5x5x7 fine cube was chosen for cube integration. Probe isotropy errors were cancelled by measuring the SAR with normal and 90° turned probe orientations and averaging.

The dipole input power (forward power) was 250mW $\pm 3\%$. The results are normalized to 1W input power.

5. SAR Measurement

Standard SAR-measurements were performed with the phantom according to the measurement conditions described in section 4. The results have been normalized to a dipole input power of 1W (forward power). The resulting averaged SAR-values are:

averaged over 1 cm³ (1 g) of tissue: **43.6 mW/g**

averaged over 10 cm³ (10 g) of tissue: **21.6 mW/g**

Note: If the liquid parameters for validation are slightly different from the ones used for initial calibration, the SAR-values will be different as well. The estimated sensitivities of SAR-values and penetration depths to the liquid parameters are listed in the DASYS Application Note 4: 'SAR Sensitivities'.

6. Handling

The dipole is made of standard semirigid coaxial cable. The center conductor of the feeding line is directly connected to the second arm of the dipole. The antenna is therefore short-circuited for DC-signals.

Do not apply excessive force to the dipole arms, because they might bend. If the dipole arms have to be bent back, take care to release stress to the soldered connections near the feedpoint; they might come off.

After prolonged use with 40W radiated power, only a slight warming of the dipole near the feedpoint can be measured.

20 Jun 2001 15:31:17

[CH1] S11 1 U FS 1: 52.408 Ω 0.7441 Ω 65.796 pH 1 800.000 000 MHz

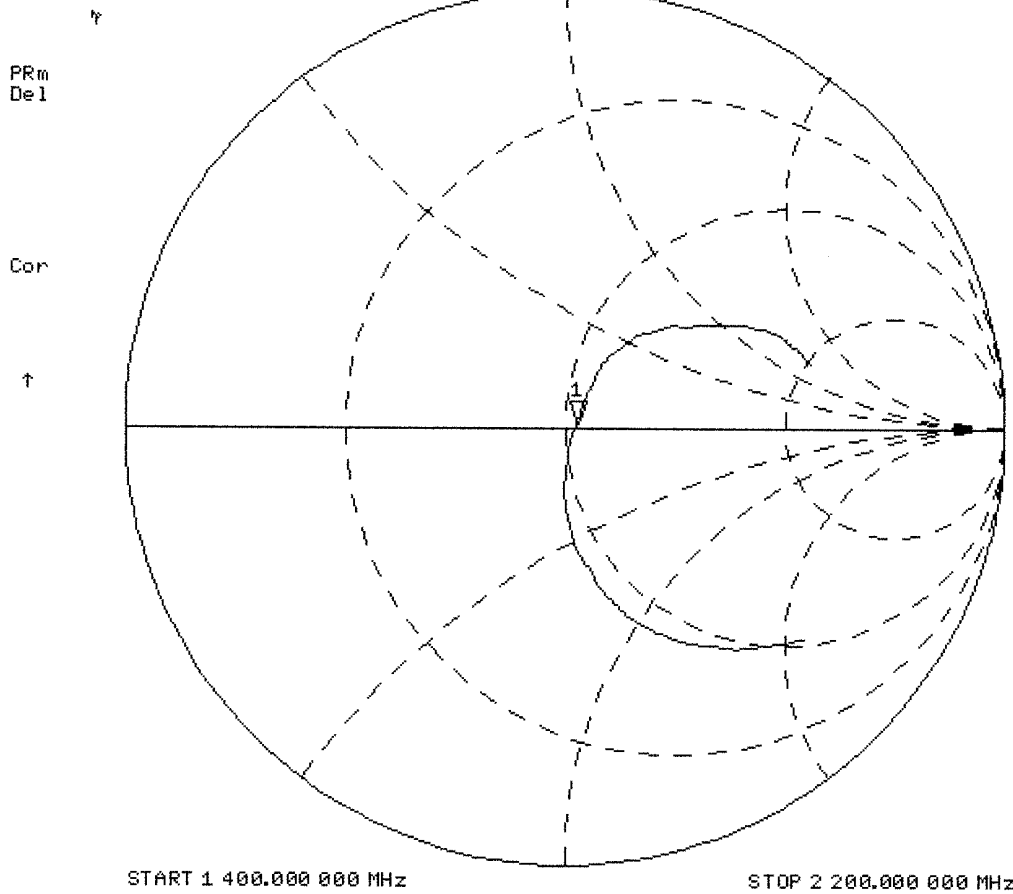

20 Jun 2001 15:31:04

CH1 S11 LOG 5 dB/REF 0 dB 1:-32.107 dB 1 800.000 000 MHz

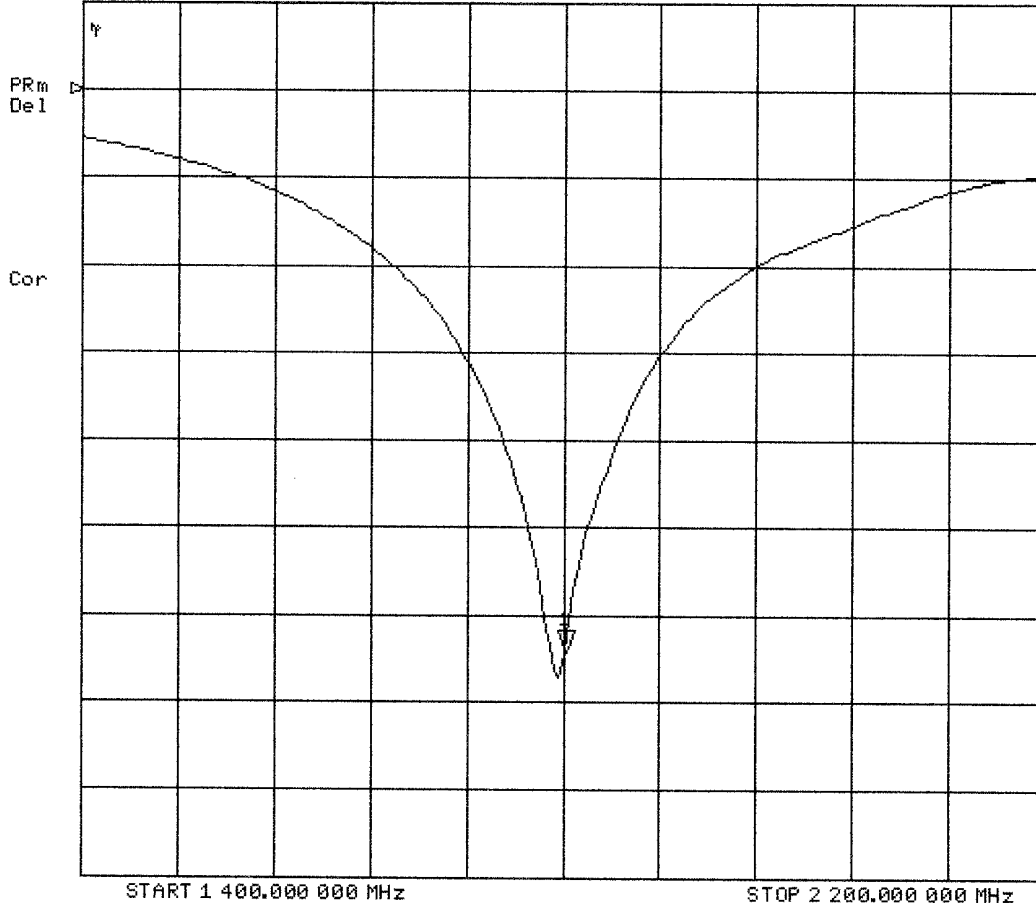

Validation Dipole D1800V2 SN:247, d = 10 mm

Frequency: 1800 MHz; Antenna Input Power: 250 [mW]
Generic Twin Phantom; Flat Section; Grid Spacing: Dx = 15.0, Dy = 15.0, Dz = 10.0
Probe: ET3DV6 - SN1507; ConvF(5.57,5.57,5.57); Crest factor: 1.0; IEEE1528 1800 MHz : $\sigma = 1.36$ mho/m $\epsilon_r = 40.0$ $\rho = 1.00$ g/cm³
Cubes (2): Peak: 18.2 mW/g ± 0.04 dB, SAR (1g): 9.66 mW/g ± 0.03 dB, SAR (10g): 5.02 mW/g ± 0.03 dB, (Worst-case extrapolation)
Penetration depth: 8.2 (7.6, 9.4) [mm]
Powerdrift: -0.01 dB

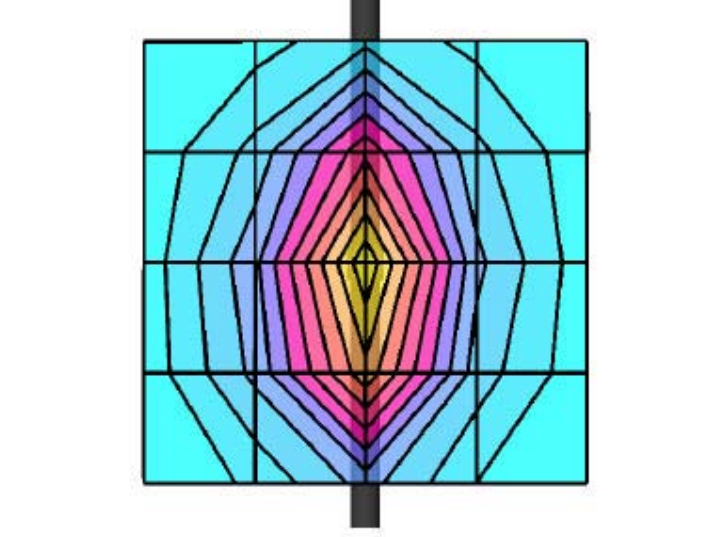

Schmid & Partner Engineering AG

Zeughausstrasse 43, 8004 Zurich, Switzerland, Phone +41 1 245 97 00, Fax +41 1 245 97 79

Calibration Certificate

900 MHz System Validation Dipole

Type:

D900V2

Serial Number:

054

Place of Calibration:

Zurich

Date of Calibration:

June 20, 2001

Calibration Interval:

24 months

Schmid & Partner Engineering AG hereby certifies, that this device has been calibrated on the date indicated above. The calibration was performed in accordance with specifications and procedures of Schmid & Partner Engineering AG.

Wherever applicable, the standards used in the calibration process are traceable to international standards. In all other cases the standards of the Laboratory for EMF and Microwave Electronics at the Swiss Federal Institute of Technology (ETH) in Zurich, Switzerland have been applied.

Calibrated by:

Rhonic Vohja

Approved by:

[Signature]

DASY

Dipole Validation Kit

Type: D900V2

Serial: 054

Manufactured: August 25, 1999
Calibrated: June 20, 2001

1. Measurement Conditions

The measurements were performed in the flat section of the new generic twin phantom filled with head simulating solution of the following electrical parameters at 900 MHz:

Relative Dielectricity	42.4	$\pm 5\%$
Conductivity	0.97 mho/m	$\pm 5\%$

The DASY3 System (Software version 3.1c) with a dosimetric E-field probe ET3DV6 (SN:1507, Conversion factor 6.27 at 900 MHz) was used for the measurements.

The dipole was mounted on the small tripod so that the dipole feedpoint was positioned below the center marking of the flat phantom section and the dipole was oriented parallel to the body axis (the long side of the phantom). The standard measuring distance was 15mm from dipole center to the solution surface. The included distance holder was used during measurements for accurate distance positioning.

The coarse grid with a grid spacing of 15mm was aligned with the dipole. The 5x5x7 fine cube was chosen for cube integration. Probe isotropy errors were cancelled by measuring the SAR with normal and 90° turned probe orientations and averaging.

The dipole input power (forward power) was 250mW $\pm 3\%$. The results are normalized to 1W input power.

2. SAR Measurement

Standard SAR-measurements were performed with the phantom according to the measurement conditions described in section 1. The results have been normalized to a dipole input power of 1W (forward power). The resulting averaged SAR-values are:

averaged over 1 cm ³ (1 g) of tissue:	11.12 mW/g
averaged over 10 cm ³ (10 g) of tissue:	7.04 mW/g

Note: If the liquid parameters for validation are slightly different from the ones used for initial calibration, the SAR-values will be different as well.

3. Dipole Impedance and Return Loss

The impedance was measured at the SMA-connector with a network analyzer and numerically transformed to the dipole feedpoint. The transformation parameters from the SMA-connector to the dipole feedpoint are:

Electrical delay:	1.413 ns	(one direction)
Transmission factor:	0.989	(voltage transmission, one direction)

The dipole was positioned at the flat phantom sections according to section 1 and the distance holder was in place during impedance measurements.

Feedpoint impedance at 900 MHz:	$\text{Re}\{Z\} = \mathbf{51.3 \Omega}$
	$\text{Im}\{Z\} = \mathbf{-0.5 \Omega}$
Return Loss at 900 MHz	-36.9 dB

4. Measurement Conditions

The measurements were performed in the flat section of the new generic twin phantom filled with brain simulating solution of the following electrical parameters at 900 MHz:

Relative Dielectricity	41.0	$\pm 5\%$
Conductivity	0.86 mho/m	$\pm 5\%$

The DASY3 System (Software version 3.1c) with a dosimetric E-field probe ET3DV6 (SN:1507, Conversion factor 6.22 at 900 MHz) was used for the measurements.

The dipole was mounted on the small tripod so that the dipole feedpoint was positioned below the center marking of the flat phantom section and the dipole was oriented parallel to the body axis (the long side of the phantom). The standard measuring distance was 15mm from dipole center to the solution surface. The included distance holder was used during measurements for accurate distance positioning.

The coarse grid with a grid spacing of 15mm was aligned with the dipole. The 5x5x7 fine cube was chosen for cube integration. Probe isotropy errors were cancelled by measuring the SAR with normal and 90° turned probe orientations and averaging.

The dipole input power (forward power) was 250mW $\pm 3\%$. The results are normalized to 1W input power.

5. SAR Measurement

Standard SAR-measurements were performed with the phantom according to the measurement conditions described in section 4. The results have been normalized to a dipole input power of 1W (forward power). The resulting averaged SAR-values are:

averaged over 1 cm ³ (1 g) of tissue:	10.12 mW/g
averaged over 10 cm ³ (10 g) of tissue:	6.52 mW/g

Note: If the liquid parameters for validation are slightly different from the ones used for initial calibration, the SAR-values will be different as well.

6. Handling

The dipole is made of standard semirigid coaxial cable. The center conductor of the feeding line is directly connected to the second arm of the dipole. The antenna is therefore short-circuited for DC-signals.

Do not apply excessive force to the dipole arms, because they might bend. If the dipole arms have to be bent back, take care to release stress to the soldered connections near the feedpoint; they might come off.

After prolonged use with 100W radiated power, only a slight warming of the dipole near the feedpoint can be measured.

CHI S11 1 U FS 1: 51.324 Ω -478.52 $m\Omega$ 369.56 μF 900.000 000 MHz

γ

PRm
Del

Cor
Avg
16

↑

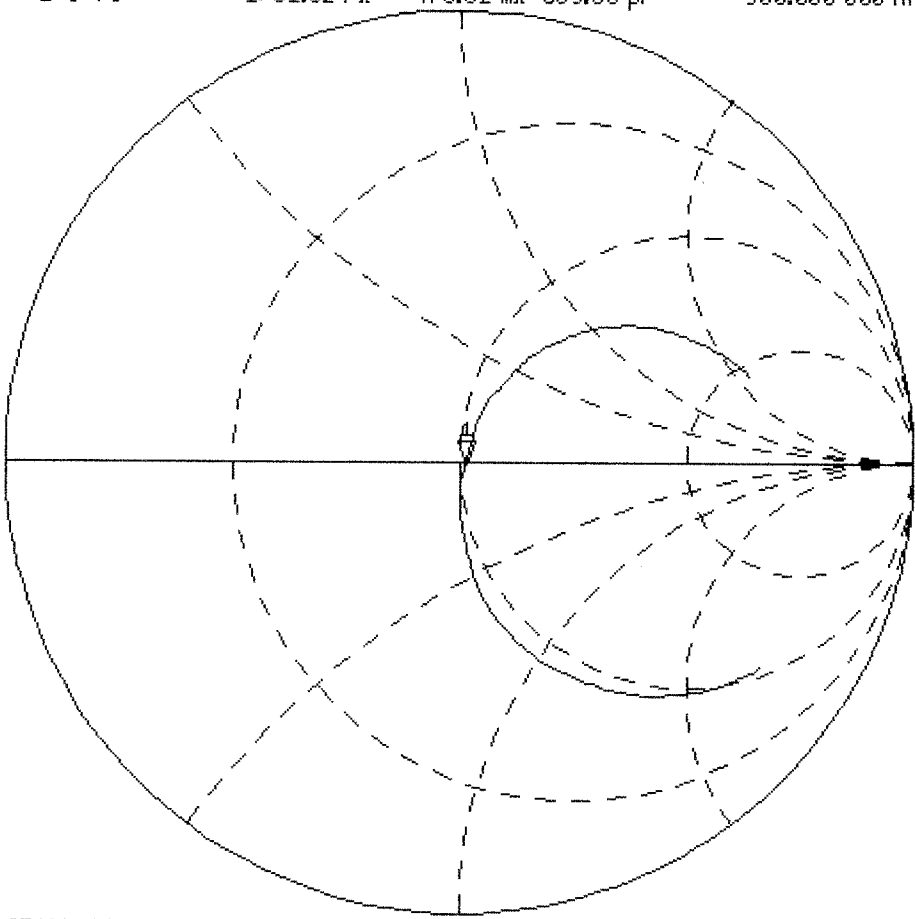

START 700.000 000 MHz

STOP 1 1100.000 000 MHz

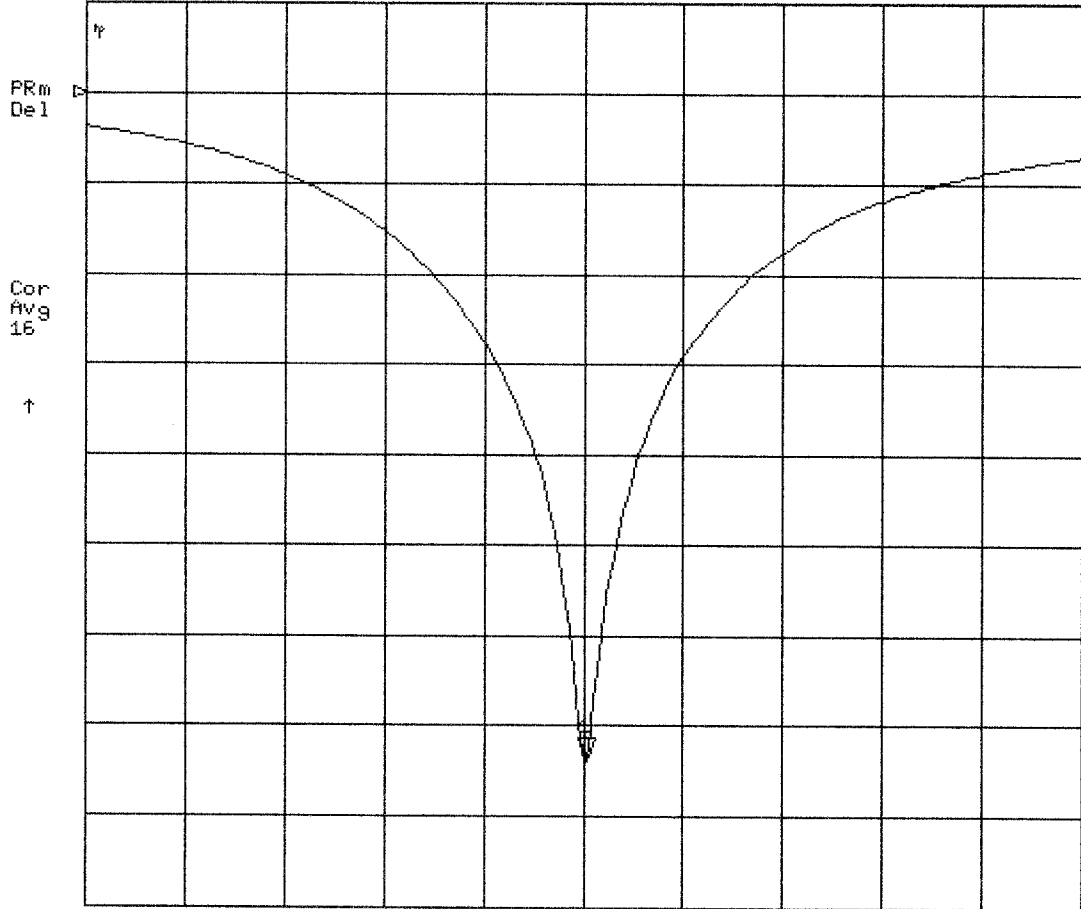

Validation Dipole D900V2 SN:054, d = 15 mm

Frequency: 900 MHz; Antenna Input Power: 250 [mW]
Generic Twin Phantom; Flat Section; Grid Spacing: Dx = 15.0, Dy = 15.0, Dz = 10.0
Probe: ET3DV6 - SN1507; ConvF(6.27,6.27,6.27); Crest factor: 1.0; IEEE1528 900 MHz: $\sigma = 0.97$ mho/m $\epsilon_r = 42.4$ $\rho = 1.00$ g/cm³
Cubes (2): Peak: 4.47 mW/g ± 0.05 dB, SAR (1g): 2.78 mW/g ± 0.04 dB, SAR (10g): 1.76 mW/g ± 0.02 dB, (Worst-case extrapolation)
Penetration depth: 11.5 (10.3, 13.2) [mm]
Powerdrift: -0.00 dB

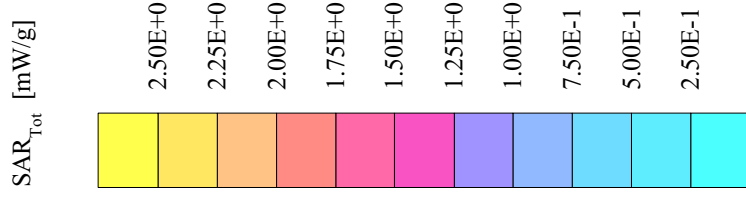

2450MHz SYSTEM VALIDATION DIPOLE

Type:

2450MHz Validation Dipole

Serial Number:

150

Place of Calibration:

Celltech Labs Inc.

Date of Calibration:

October 24, 2002

Celltech Research Inc. hereby certifies that this device has been calibrated on the date indicated above.

Calibrated by:

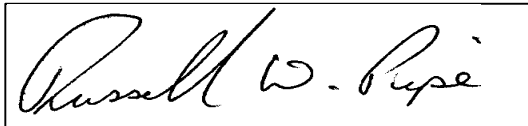

Approved by:

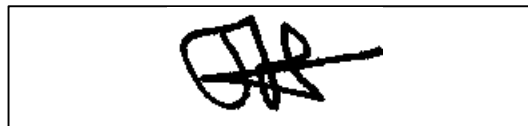

1. Dipole Construction & Electrical Characteristics

The validation dipole was constructed in accordance with the IEEE Std "Recommended Practice for Determining the Spatial-Peak Specific Absorption Rate (SAR) in the Human Body Due to Wireless Communications Devices: Experimental Techniques". The electrical properties were measured using an HP 8753E Network Analyzer. The network analyzer was calibrated to the validation dipole N-type connector feed point using an HP85032E Type N calibration kit. The dipole was placed parallel to a planar phantom at a separation distance of 10.0mm from the simulating fluid using a loss-less dielectric spacer. The measured input impedance is:

Feed point impedance at 2450MHz	$\text{Re}\{Z\} = 49.838\Omega$ $\text{Im}\{Z\} = 0.2207\Omega$
Return Loss at 2450MHz	-49.398 dB

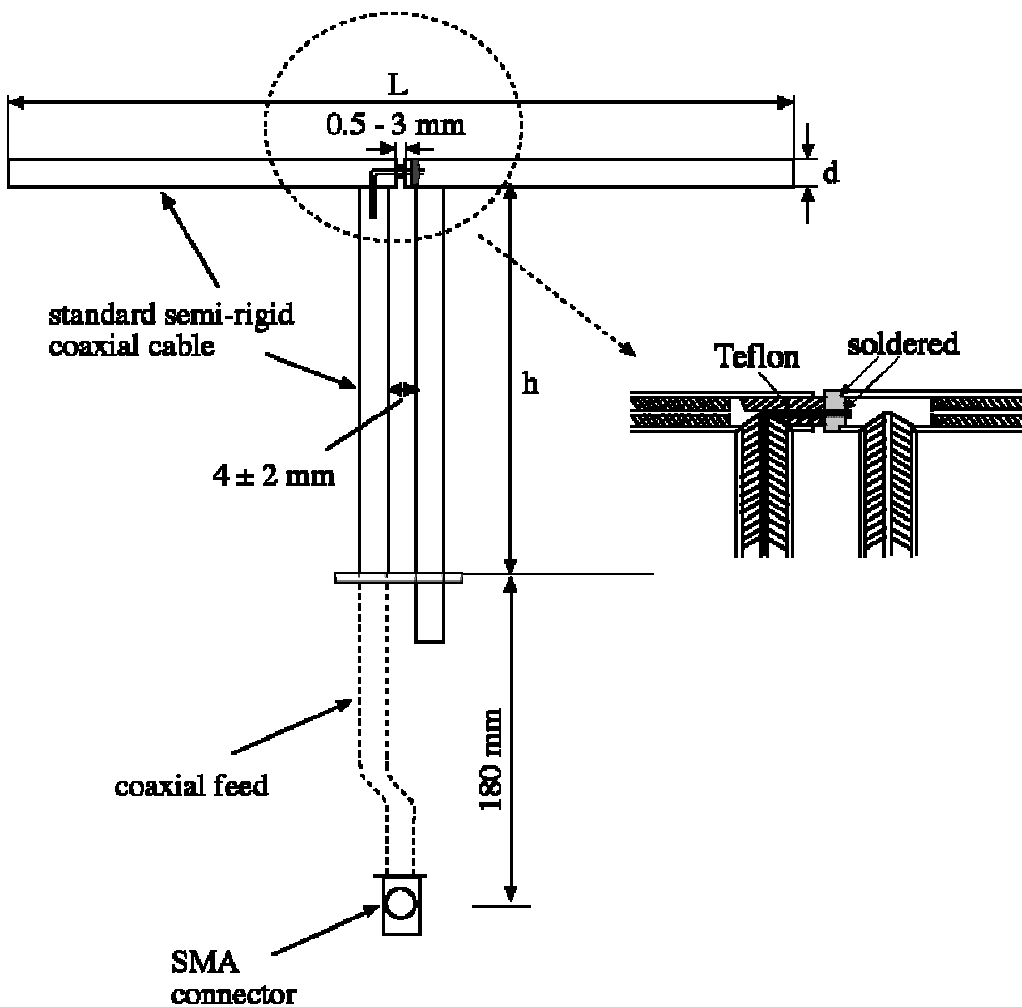

Validation Dipole Dimensions

Frequency (MHz)	L (mm)	h (mm)	d (mm)
300	420.0	250.0	6.2
450	288.0	167.0	6.2
835	161.0	89.8	3.6
900	149.0	83.3	3.6
1450	89.1	51.7	3.6
1800	72.0	41.7	3.6
1900	68.0	39.5	3.6
2000	64.5	37.5	3.6
2450	51.8	30.6	3.6
3000	41.5	25.0	3.6

2. Validation Phantom

The validation phantom is the SAM (Specific Anthropomorphic Mannequin) phantom manufactured by Schmid & Partner Engineering AG. The SAM phantom is a Fiberglass shell integrated in a wooden table. The shape of the shell corresponds to the phantom defined by SCC34-SC2. It enables the dosimetric evaluation of left and right hand phone usage as well as body mounted usage at the flat phantom region. A cover prevents evaporation of the liquid. Reference markings on the phantom allow the complete setup of all predefined phantom positions and measurement grids by manually teaching three points in the robot.

Shell Thickness: 2.0 ± 0.1 mm
Filling Volume: Approx. 20 liters
Dimensions: 50 cm (W) x 100 cm (L)

SAM Twin-Phantom

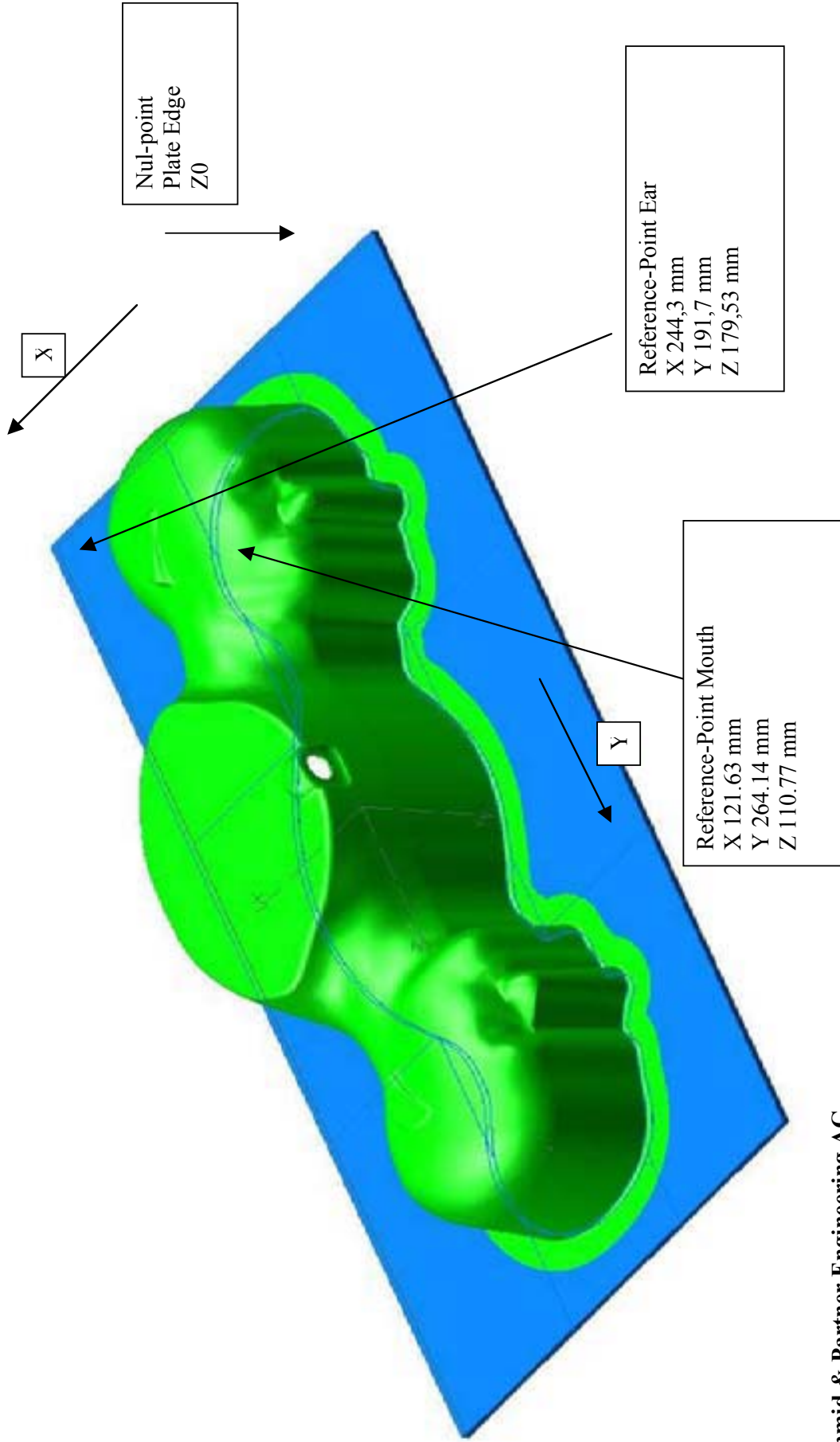

2450MHz Dipole Calibration



2450MHz Dipole Calibration



3. Measurement Conditions

The planar phantom was filled with brain simulating tissue having the following electrical parameters at 2450MHz:

Relative Permittivity:	36.8
Conductivity:	1.79 mho/m
Ambient Temperature:	23.6°C
Fluid Temperature:	23.8°C
Fluid Depth:	≥ 15cm

The 2450MHz simulating tissue consists of the following ingredients:

Ingredient	Percentage by weight
Water	55.20%
Glycol Monobutyl	44.80%
Target Dielectric Parameters at 22°C	$\epsilon_r = 39.2$ (+/-10%) $\sigma = 1.80$ S/m (+/-5%)

4. SAR Measurement

The SAR measurement was performed with the E-field probe in mechanical detection mode only. The setup and determination of the forward power into the dipole was performed using the following procedures.

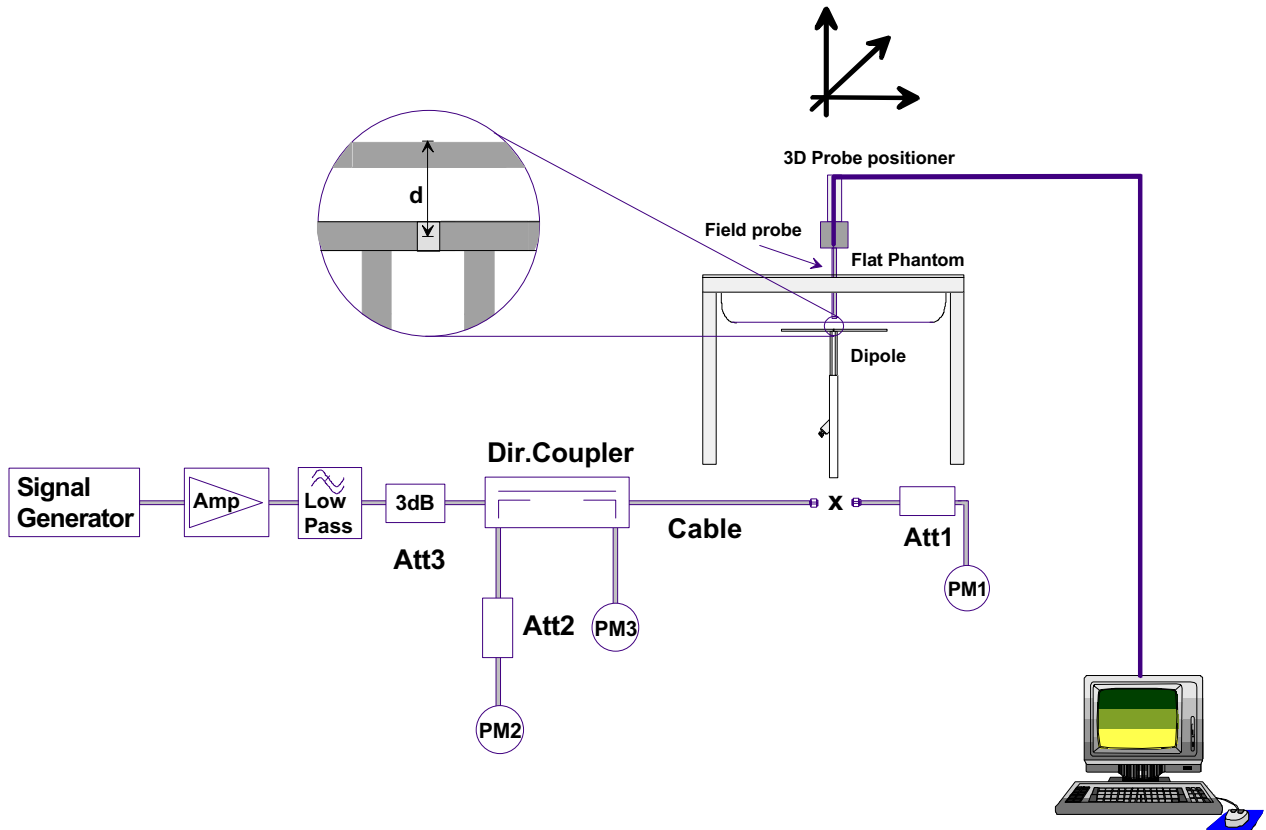

First, the power meter **PM1** (including attenuator **Att1**) is connected to the cable to measure the forward power at the location of the dipole connector (**X**). The signal generator is adjusted for the desired forward power at the dipole connector (taking into account the attenuation of **Att1**) as read by power meter **PM2**. After connecting the cable to the dipole, the signal generator is readjusted for the same reading at power meter **PM2**. If the signal generator does not allow adjustment in 0.01dB steps, the remaining difference at **PM2** must be taken into consideration. **PM3** records the reflected power from the dipole to ensure that the value is not changed from the previous value. The reflected power should be 20dB below the forward power.

Ten SAR measurements were performed in order to achieve repeatability and to establish an average target value.

Validation Dipole SAR Test Results

Validation Measurement	SAR @ 0.25W Input averaged over 1g	SAR @ 1W Input averaged over 1g	SAR @ 0.25W Input averaged over 10g	SAR @ 1W Input averaged over 10g	Peak SAR @ 0.25W Input
Test 1	14.4	57.6	6.55	26.20	30.5
Test 2	14.2	56.8	6.44	25.76	30.0
Test 3	14.0	56.0	6.35	25.40	29.7
Test 4	13.9	55.6	6.32	25.28	29.5
Test 5	14.0	56.0	6.33	25.32	29.7
Test 6	14.0	56.0	6.33	25.32	29.7
Test 7	13.9	55.6	6.31	25.24	29.5
Test 8	13.8	55.2	6.28	25.12	29.3
Test 9	13.8	55.2	6.28	25.12	29.4
Test10	14.0	56.0	6.33	25.32	29.7
Average Value	14.0	56.0	6.35	25.41	29.7

The results have been normalized to 1W (forward power) into the dipole.

Averaged over 1cm (1g) of tissue: 56.00 mW/g

Averaged over 10cm (10g) of tissue: 25.41 mW/g

24 Oct 2002 09:28:50

CH1 S11 1 U FS 1: 49.838 Ω 0.2207 Ω 14.337 pH 2 450.000 000 MHz

PRm

MARKER 1
2.45 GHz

Cor

↑

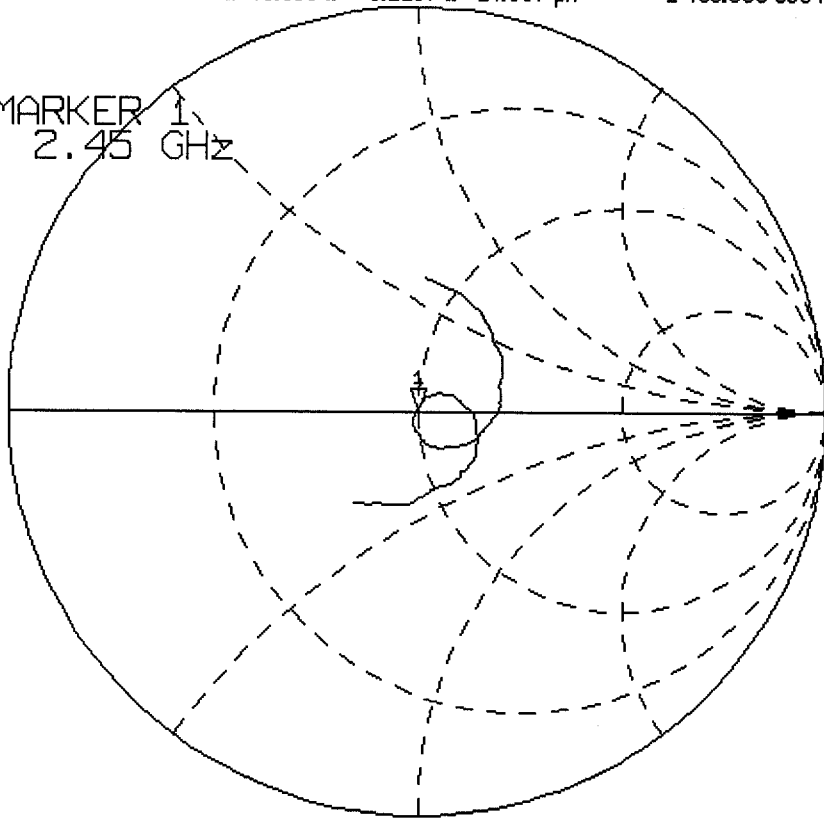

START 2 250.000 000 MHz

STOP 2 650.000 000 MHz

24 Oct 2002 09:28:12

CH1 S11 LOG 10 dB/REF 0 dB 11-49.398 dB 2 450.000 000 MHz

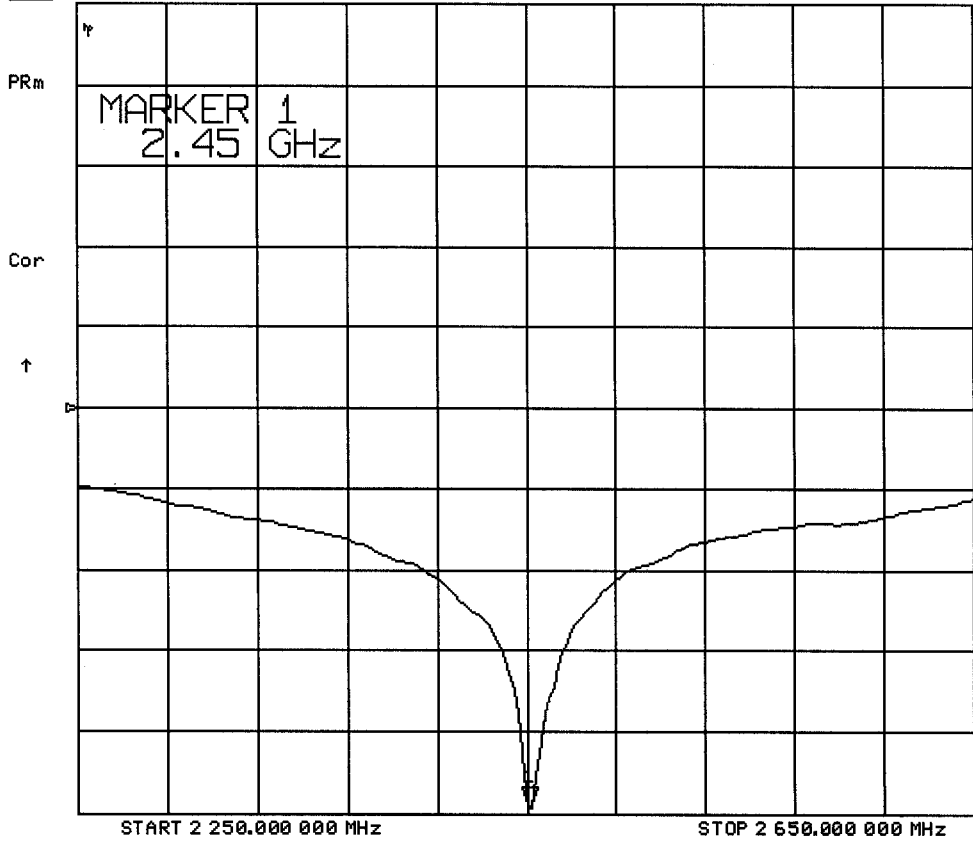

Dipole 2450MHz

SAM Phantom; Flat Section

Probe: ET3DV6 - SNI387; ConvF(4.70,4.70,4.70); Crest factor: 1.0; 2450 MHz Brain: $\sigma = 1.79 \text{ mho/m}$ $\epsilon_r = 36.8 \rho = 1.00 \text{ g/cm}^3$

Cubes (4): Peak: 29.7 mW/g $\pm 0.04 \text{ dB}$, SAR (1g): 14.0 mW/g $\pm 0.04 \text{ dB}$, SAR (10g): 6.35 mW/g $\pm 0.04 \text{ dB}$, (Worst-case extrapolation)

Penetration depth: 6.4 (6.1, 7.2) [mm]; Powerdrift: -0.04 dB

Ambient Temp.: 23.6°C; Fluid Temp.: 23.8°C

Forward Conducted Power: 250 mW

Calibration Date: October 24, 2002

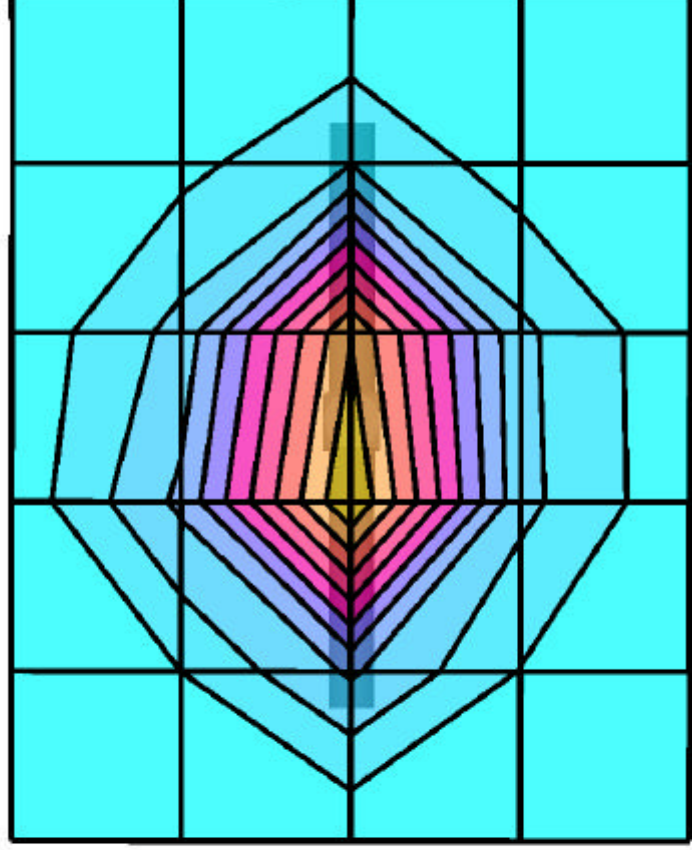

SAR_{tot} [mW/g]

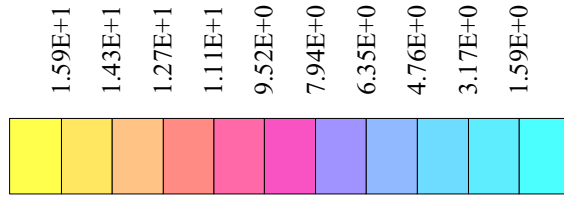

2450MHz System Validation

Measured Fluid Dielectric Parameters (Brain)

October 24, 2002

Frequency		ϵ'	ϵ''
2.350000000	GHz	37.2108	12.9039
2.360000000	GHz	37.1695	12.9350
2.370000000	GHz	37.1398	12.9630
2.380000000	GHz	37.1057	12.9945
2.390000000	GHz	37.0746	13.0290
2.400000000	GHz	37.0424	13.0464
2.410000000	GHz	36.9746	13.0743
2.420000000	GHz	36.9322	13.1074
2.430000000	GHz	36.8908	13.1372
2.440000000	GHz	36.8449	13.1527
2.450000000	GHz	36.7983	13.1767
2.460000000	GHz	36.7651	13.2038
2.470000000	GHz	36.7300	13.2377
2.480000000	GHz	36.7004	13.2677
2.490000000	GHz	36.6658	13.2862
2.500000000	GHz	36.6120	13.2988
2.510000000	GHz	36.5655	13.3268
2.520000000	GHz	36.5147	13.3582
2.530000000	GHz	36.4743	13.3922
2.540000000	GHz	36.4044	13.4131
2.550000000	GHz	36.3807	13.4402

APPENDIX D - PROBE CALIBRATION

Schmid & Partner Engineering AG

Zeughausstrasse 43, 8004 Zurich, Switzerland, Phone +41 1 245 97 00, Fax +41 1 245 97 79



Calibration Certificate

Dosimetric E-Field Probe

Type:	ET3DV6
Serial Number:	1590
Place of Calibration:	Zurich
Date of Calibration:	December 1, 2002
Calibration Interval:	12 months

Schmid & Partner Engineering AG hereby certifies, that this device has been calibrated on the date indicated above. The calibration was performed in accordance with specifications and procedures of Schmid & Partner Engineering AG.

Wherever applicable, the standards used in the calibration process are traceable to international standards. In all other cases the standards of the Laboratory for EMF and Microwave Electronics at the Swiss Federal Institute of Technology (ETH) in Zurich, Switzerland have been applied.

Calibrated by:	
Approved by:	

Probe ET3DV6

SN:1590

Manufactured:	March 19, 2001
Last calibration:	April 26, 2002
Recalibrated:	December 1, 2002

Calibrated for DASY Systems

(Note: non-compatible with DASY2 system!)

DASY - Parameters of Probe: ET3DV6 SN:1590

Sensitivity in Free Space

NormX	1.75 $\mu\text{V}/(\text{V}/\text{m})^2$
NormY	1.89 $\mu\text{V}/(\text{V}/\text{m})^2$
NormZ	1.63 $\mu\text{V}/(\text{V}/\text{m})^2$

Diode Compression

DCP X	92	mV
DCP Y	92	mV
DCP Z	92	mV

Sensitivity in Tissue Simulating Liquid

Head	900 MHz	$\epsilon_r = 41.5 \pm 5\%$	$\sigma = 0.97 \pm 5\% \text{ mho}/\text{m}$
Head	835 MHz	$\epsilon_r = 41.5 \pm 5\%$	$\sigma = 0.90 \pm 5\% \text{ mho}/\text{m}$
ConvF X	6.9 $\pm 9.5\%$ (k=2)		Boundary effect:
ConvF Y	6.9 $\pm 9.5\%$ (k=2)		Alpha 0.30
ConvF Z	6.9 $\pm 9.5\%$ (k=2)		Depth 2.71
Head	1800 MHz	$\epsilon_r = 40.0 \pm 5\%$	$\sigma = 1.40 \pm 5\% \text{ mho}/\text{m}$
Head	1900 MHz	$\epsilon_r = 40.0 \pm 5\%$	$\sigma = 1.40 \pm 5\% \text{ mho}/\text{m}$
ConvF X	5.6 $\pm 9.5\%$ (k=2)		Boundary effect:
ConvF Y	5.6 $\pm 9.5\%$ (k=2)		Alpha 0.42
ConvF Z	5.6 $\pm 9.5\%$ (k=2)		Depth 2.56

Boundary Effect

Head	900 MHz	Typical SAR gradient: 5 % per mm	
	Probe Tip to Boundary	1 mm	2 mm
	SAR _{be} [%] Without Correction Algorithm	8.7	5.0
	SAR _{be} [%] With Correction Algorithm	0.3	0.5
Head	1800 MHz	Typical SAR gradient: 10 % per mm	
	Probe Tip to Boundary	1 mm	2 mm
	SAR _{be} [%] Without Correction Algorithm	10.7	7.4
	SAR _{be} [%] With Correction Algorithm	0.1	0.3

Sensor Offset

Probe Tip to Sensor Center	2.7	mm
Optical Surface Detection	1.2 \pm 0.2	mm

Receiving Pattern (ϕ), $\theta = 0^\circ$

f = 30 MHz, TEM cell ifi110

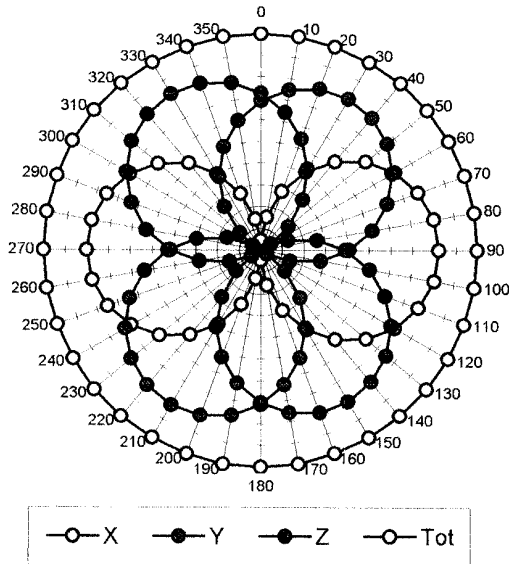

f = 100 MHz, TEM cell ifi110

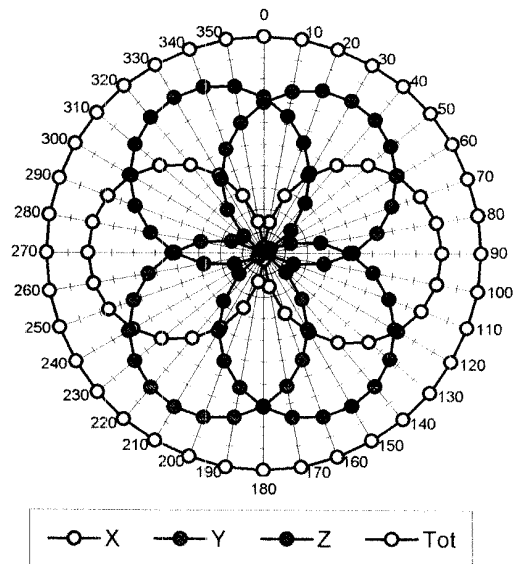

f = 300 MHz, TEM cell ifi110

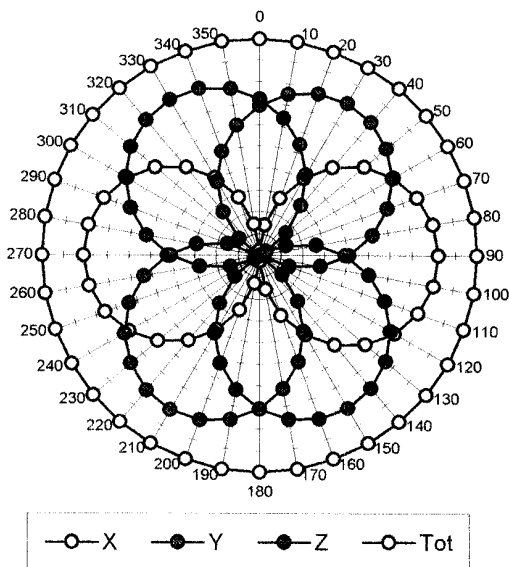

f = 900 MHz, TEM cell ifi110

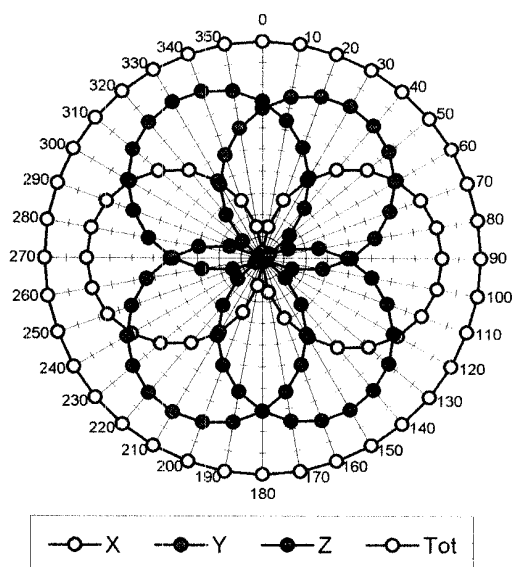

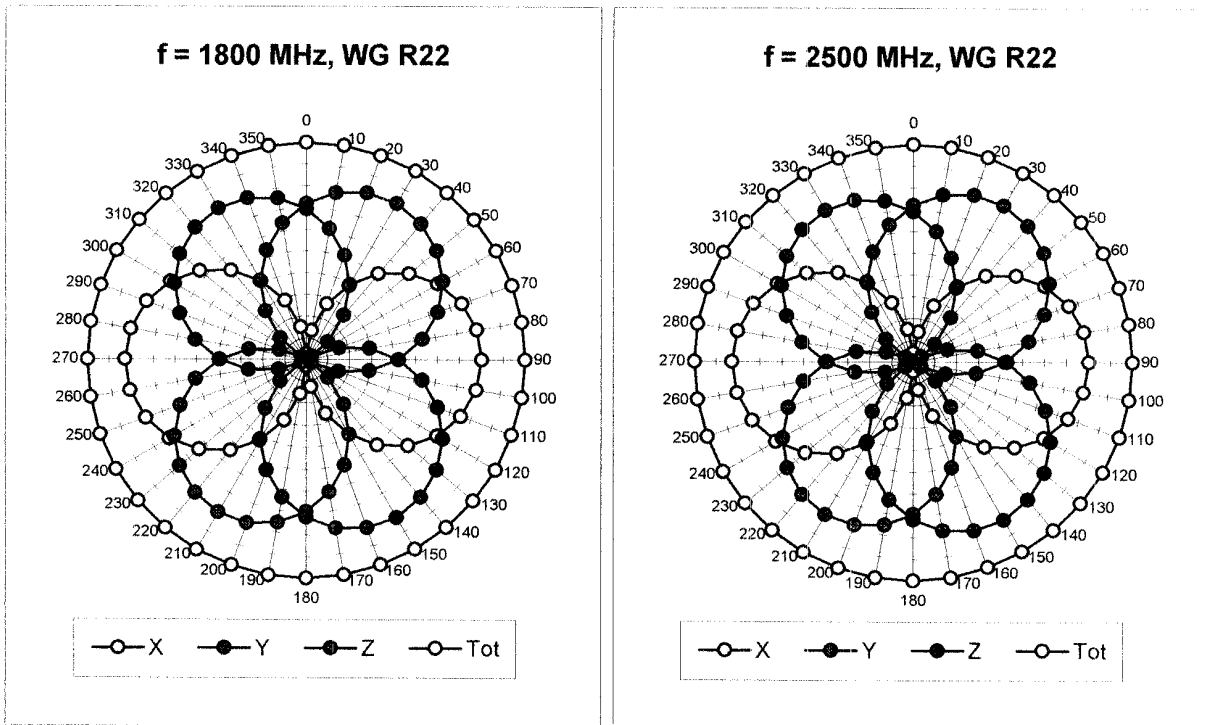

Isotropy Error (ϕ), $\theta = 0^\circ$

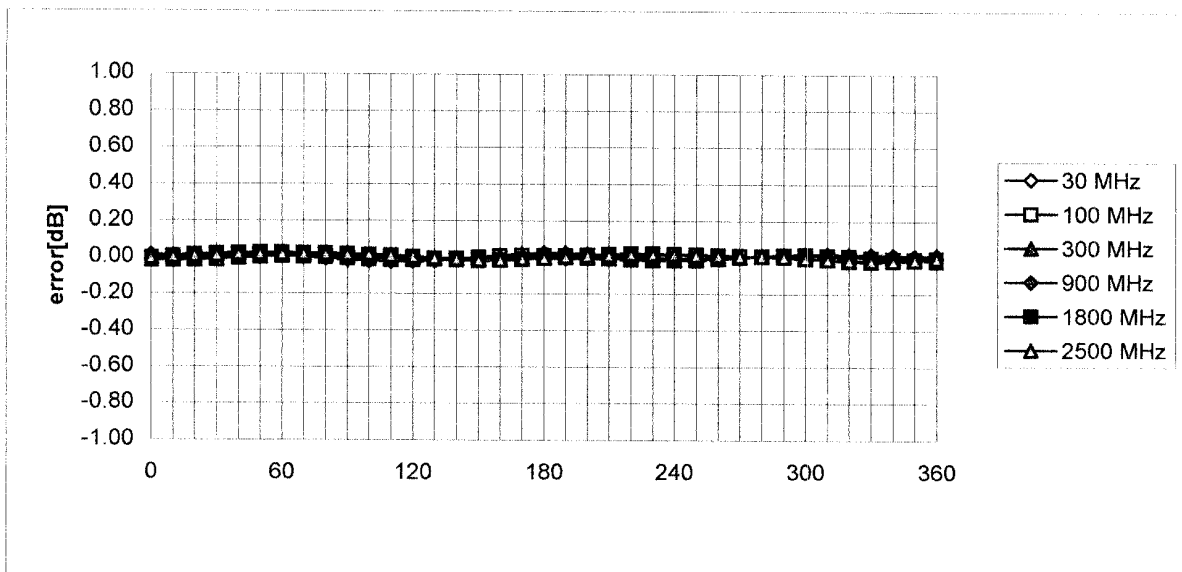

Frequency Response of E-Field

(TEM-Cell:ifi110, Waveguide R22)

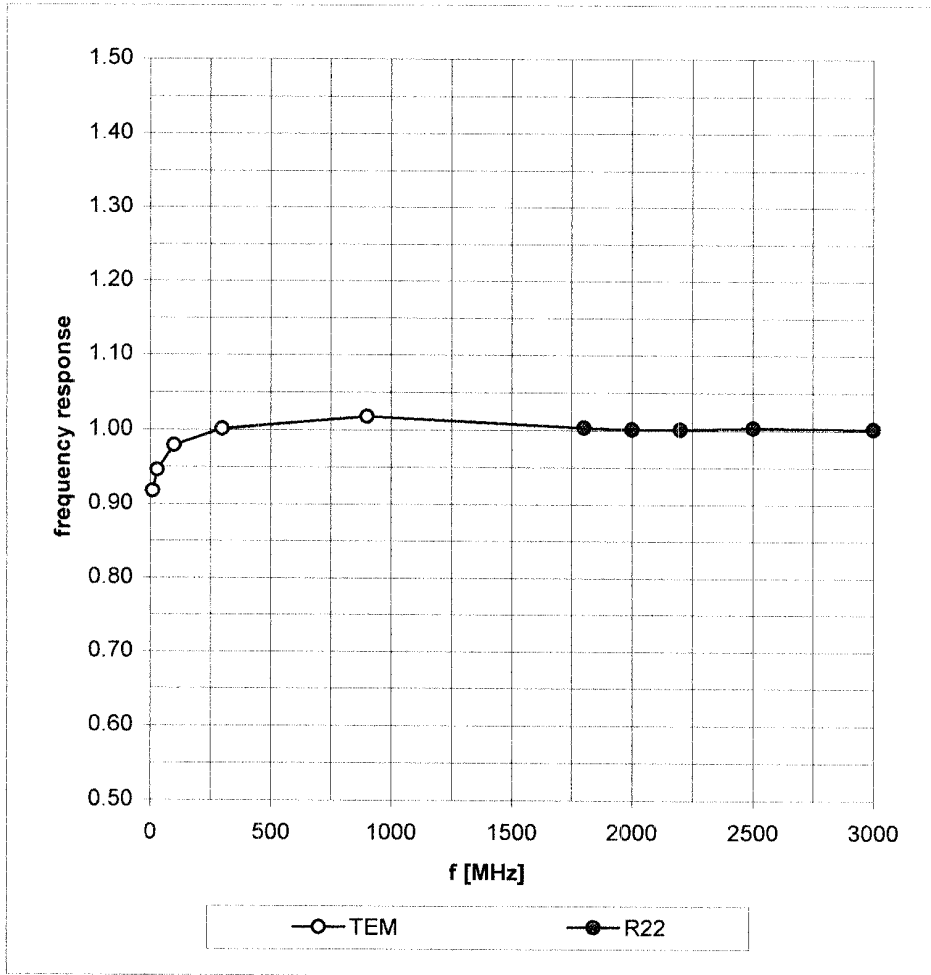

Dynamic Range f(SAR_{brain}) (Waveguide R22)

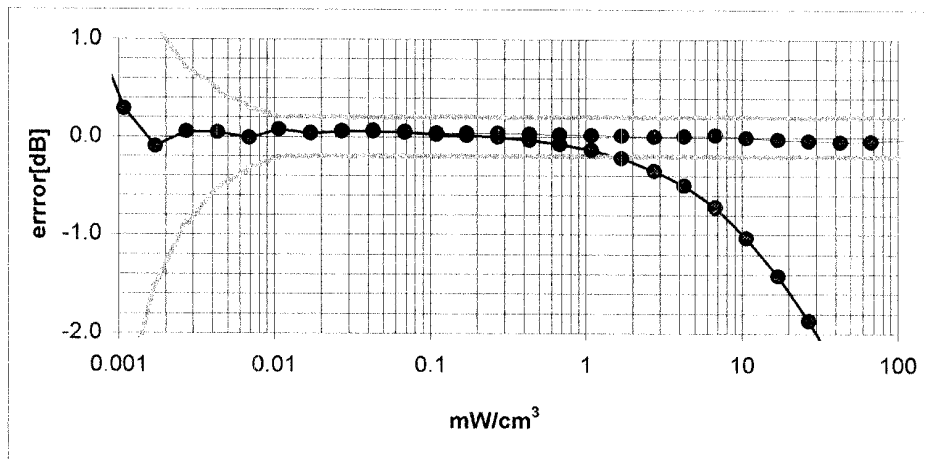
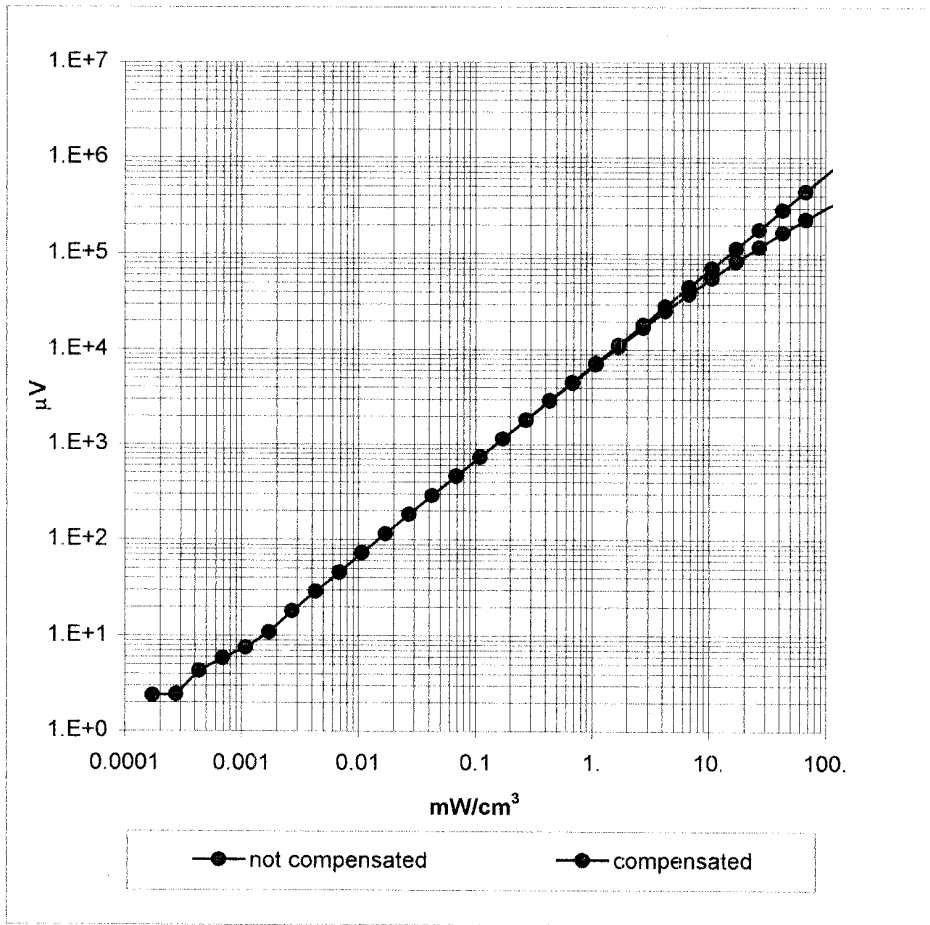

Conversion Factor Assessment

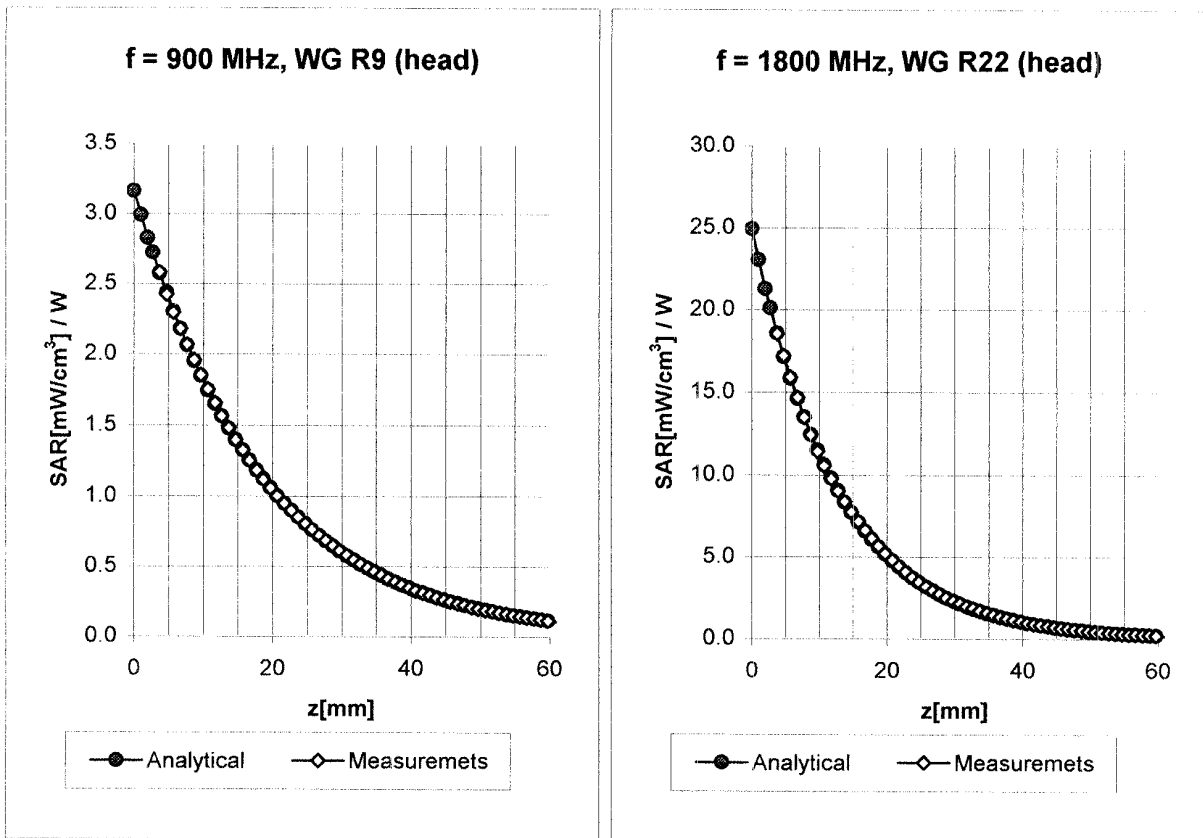

Head	900 MHz	$\epsilon_r = 41.5 \pm 5\%$	$\sigma = 0.97 \pm 5\% \text{ mho/m}$
Head	835 MHz	$\epsilon_r = 41.5 \pm 5\%$	$\sigma = 0.90 \pm 5\% \text{ mho/m}$
	ConvF X	6.9 $\pm 9.5\%$ (k=2)	Boundary effect:
	ConvF Y	6.9 $\pm 9.5\%$ (k=2)	Alpha 0.30
	ConvF Z	6.9 $\pm 9.5\%$ (k=2)	Depth 2.71
Head	1800 MHz	$\epsilon_r = 40.0 \pm 5\%$	$\sigma = 1.40 \pm 5\% \text{ mho/m}$
Head	1900 MHz	$\epsilon_r = 40.0 \pm 5\%$	$\sigma = 1.40 \pm 5\% \text{ mho/m}$
	ConvF X	5.6 $\pm 9.5\%$ (k=2)	Boundary effect:
	ConvF Y	5.6 $\pm 9.5\%$ (k=2)	Alpha 0.42
	ConvF Z	5.6 $\pm 9.5\%$ (k=2)	Depth 2.56

Conversion Factor Assessment

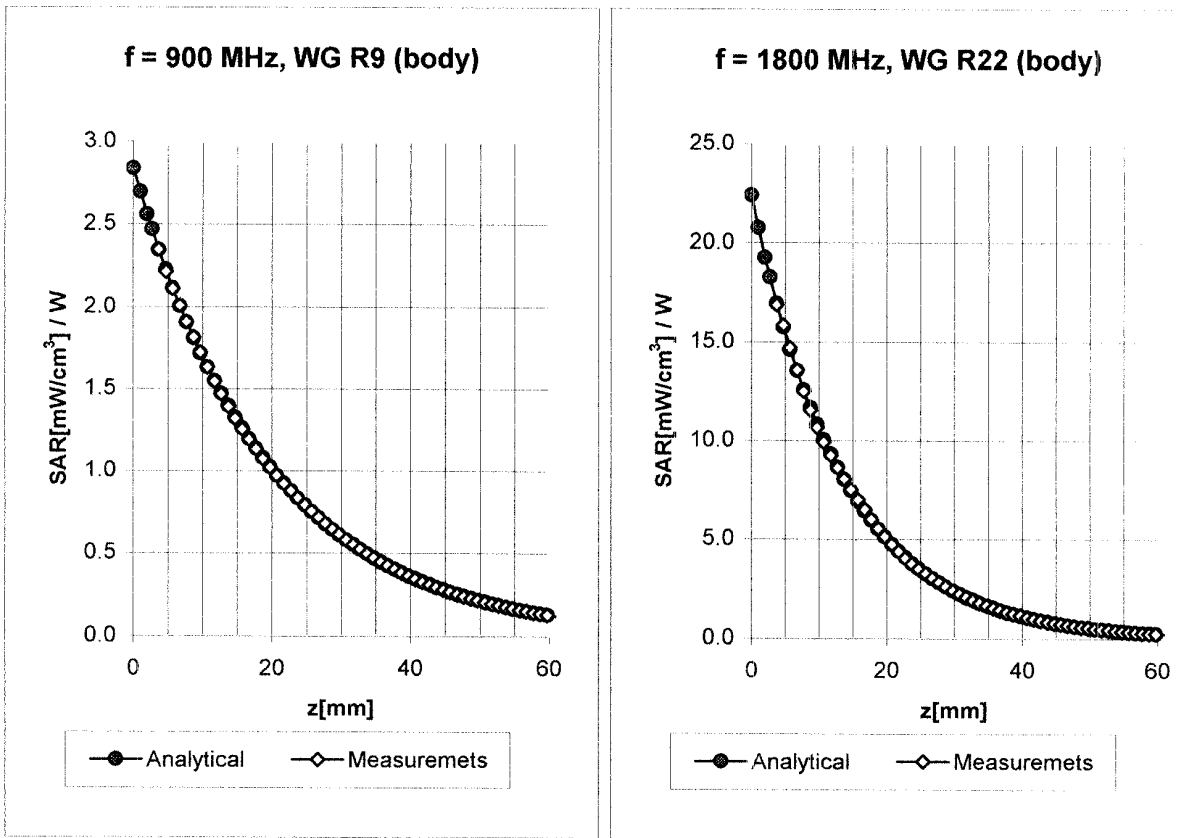

Body	900 MHz	$\epsilon_r = 55.0 \pm 5\%$	$\sigma = 1.05 \pm 5\% \text{ mho/m}$
Body	835 MHz	$\epsilon_r = 55.2 \pm 5\%$	$\sigma = 0.97 \pm 5\% \text{ mho/m}$
	ConvF X	6.7 $\pm 9.5\%$ (k=2)	Boundary effect:
	ConvF Y	6.7 $\pm 9.5\%$ (k=2)	Alpha 0.34
	ConvF Z	6.7 $\pm 9.5\%$ (k=2)	Depth 2.57
Body	1800 MHz	$\epsilon_r = 53.3 \pm 5\%$	$\sigma = 1.52 \pm 5\% \text{ mho/m}$
Body	1900 MHz	$\epsilon_r = 53.3 \pm 5\%$	$\sigma = 1.52 \pm 5\% \text{ mho/m}$
	ConvF X	5.3 $\pm 9.5\%$ (k=2)	Boundary effect:
	ConvF Y	5.3 $\pm 9.5\%$ (k=2)	Alpha 0.52
	ConvF Z	5.3 $\pm 9.5\%$ (k=2)	Depth 2.46

Deviation from Isotropy in HSL

Error (θ, ϕ), $f = 900$ MHz

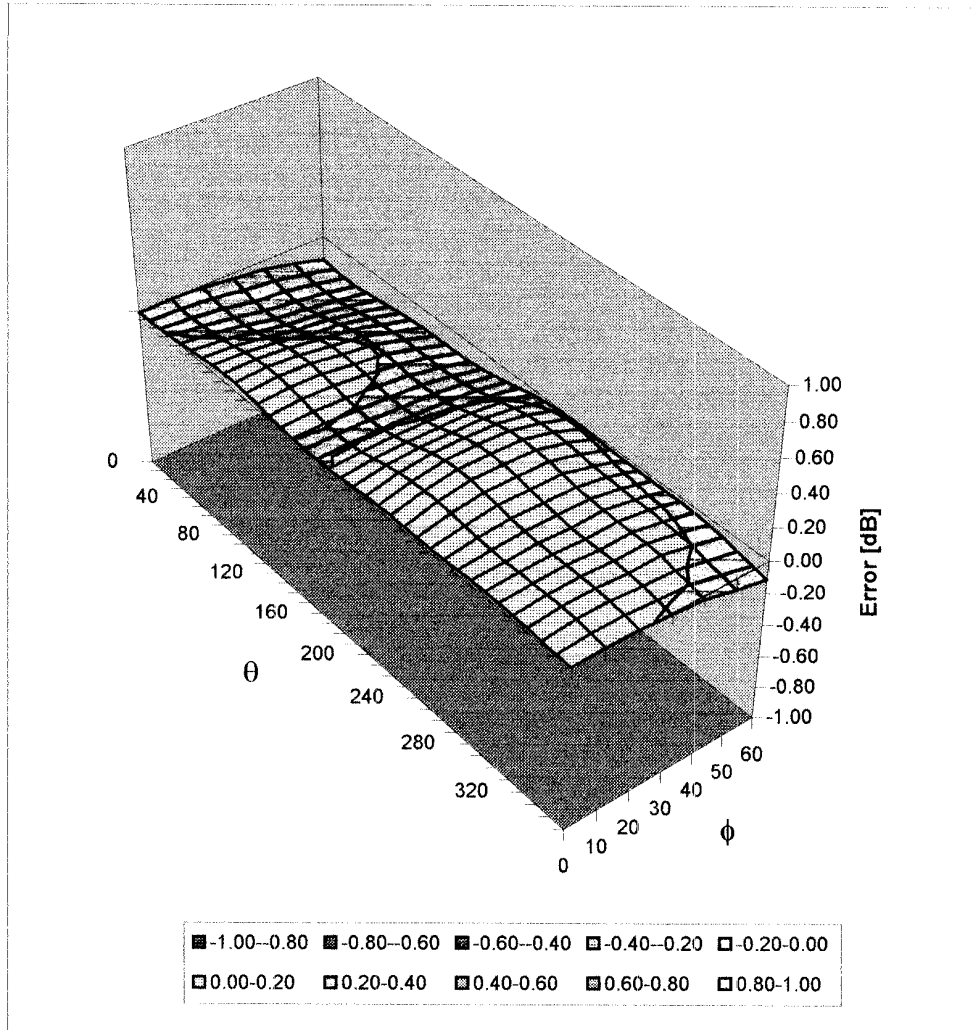

Additional Conversion Factors for Dosimetric E-Field Probe

Type:

ET3DV6

Serial Number:

1590

Place of Assessment:

Zurich

Date of Assessment:

May 1, 2002

Probe Calibration Date:

April 26, 2002

Schmid & Partner Engineering AG hereby certifies that conversion factor(s) of this probe have been evaluated on the date indicated above. The assessment was performed using the FDTD numerical code SEMCAD of Schmid & Partner Engineering AG. Since the evaluation is coupled with measured conversion factors, it has to be recalculated yearly, i.e., following the re-calibration schedule of the probe. The uncertainty of the numerical assessment is based on the extrapolation from measured value at 900 MHz or at 1800 MHz.

Assessed by:

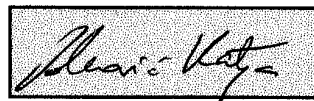

Dosimetric E-Field Probe ET3DV6 SN:1590

Conversion factor (\pm standard deviation)

150 MHz	ConvF	9.4 \pm 8%	$\epsilon_r = 52.3$ $\sigma = 0.76$ mho/m (head tissue)
300 MHz	ConvF	8.2 \pm 8%	$\epsilon_r = 45.3$ $\sigma = 0.87$ mho/m (head tissue)
450 MHz	ConvF	7.8 \pm 8%	$\epsilon_r = 43.5$ $\sigma = 0.87$ mho/m (head tissue)
150 MHz	ConvF	9.1 \pm 8%	$\epsilon_r = 61.9$ $\sigma = 0.80$ mho/m (body tissue)
450 MHz	ConvF	7.9 \pm 8%	$\epsilon_r = 56.7$ $\sigma = 0.94$ mho/m (body tissue)
2450 MHz	ConvF	4.5 \pm 8%	$\epsilon_r = 39.2$ $\sigma = 1.80$ mho/m (head tissue)
2450 MHz	ConvF	4.1 \pm 8%	$\epsilon_r = 52.7$ $\sigma = 1.95$ mho/m (body tissue)

APPENDIX E - MEASURED FLUID DIELECTRIC PARAMETERS

1800MHz System Performance Check

Measured Fluid Dielectric Parameters (Brain)

February 05, 2003

Frequency	e'	e''
1.700000000 GHz	40.4061	13.8009
1.710000000 GHz	40.3733	13.8098
1.720000000 GHz	40.3382	13.8292
1.730000000 GHz	40.3126	13.8524
1.740000000 GHz	40.2715	13.9054
1.750000000 GHz	40.2335	13.9505
1.760000000 GHz	40.1868	13.9883
1.770000000 GHz	40.1670	14.0289
1.780000000 GHz	40.1124	14.0533
1.790000000 GHz	40.0603	14.0852
1.800000000 GHz	40.0190	14.1231
1.810000000 GHz	39.9656	14.1531
1.820000000 GHz	39.9030	14.1856
1.830000000 GHz	39.8698	14.1952
1.840000000 GHz	39.8129	14.2278
1.850000000 GHz	39.7683	14.2444
1.860000000 GHz	39.7407	14.2628
1.870000000 GHz	39.6906	14.2859
1.880000000 GHz	39.6470	14.3082
1.890000000 GHz	39.6163	14.3403
1.900000000 GHz	39.5770	14.3515

1900MHz EUT Evaluation (Head)

Measured Fluid Dielectric Parameters (Brain)

February 05, 2003

Frequency	ϵ'	ϵ''
1.780000000 GHz	38.6873	12.9569
1.790000000 GHz	38.6348	12.9971
1.800000000 GHz	38.5879	13.0134
1.810000000 GHz	38.5244	13.0453
1.820000000 GHz	38.4633	13.0789
1.830000000 GHz	38.4096	13.1026
1.840000000 GHz	38.3629	13.1312
1.850000000 GHz	38.3326	13.1358
1.860000000 GHz	38.3044	13.1422
1.870000000 GHz	38.2669	13.1657
1.880000000 GHz	38.2332	13.1842
1.890000000 GHz	38.2020	13.2099
1.900000000 GHz	38.1546	13.2309
1.910000000 GHz	38.1238	13.2536
1.920000000 GHz	38.0701	13.2700
1.930000000 GHz	38.0280	13.3084
1.940000000 GHz	38.0164	13.3340
1.950000000 GHz	37.9901	13.3571
1.960000000 GHz	37.9699	13.3793
1.970000000 GHz	37.9247	13.4055
1.980000000 GHz	37.8975	13.4406

900MHz System Performance Check

Measured Fluid Dielectric Parameters (Brain)

February 05, 2003

Frequency	ϵ'	ϵ''
800.000000 MHz	42.1740	19.7156
810.000000 MHz	42.0933	19.7013
820.000000 MHz	41.9317	19.6725
830.000000 MHz	41.8074	19.6084
840.000000 MHz	41.6626	19.5887
850.000000 MHz	41.5291	19.5567
860.000000 MHz	41.4146	19.5412
870.000000 MHz	41.2620	19.4866
880.000000 MHz	41.1726	19.4965
890.000000 MHz	41.0479	19.4769
900.000000 MHz	40.9714	19.3895
910.000000 MHz	40.8670	19.3664
920.000000 MHz	40.7501	19.2749
930.000000 MHz	40.6708	19.2660
940.000000 MHz	40.5484	19.2325
950.000000 MHz	40.4001	19.2273
960.000000 MHz	40.3158	19.2033
970.000000 MHz	40.1948	19.1730
980.000000 MHz	40.0876	19.1766
990.000000 MHz	39.9922	19.1632
1.000000000 GHz	39.9056	19.0976

835MHz EUT Evaluation (Head)

Measured Fluid Dielectric Parameters (Brain)

February 05, 2003

Frequency	ϵ'	ϵ''
735.000000 MHz	43.9057	20.3575
745.000000 MHz	43.7600	20.3386
755.000000 MHz	43.6378	20.2802
765.000000 MHz	43.4930	20.2068
775.000000 MHz	43.3777	20.1841
785.000000 MHz	43.2591	20.1745
795.000000 MHz	43.1569	20.1280
805.000000 MHz	43.0713	20.0891
815.000000 MHz	42.9442	20.0252
825.000000 MHz	42.8254	20.0143
835.000000 MHz	42.6693	19.9884
845.000000 MHz	42.5414	19.9350
855.000000 MHz	42.3724	19.9057
865.000000 MHz	42.2461	19.8656
875.000000 MHz	42.1132	19.8594
885.000000 MHz	42.0308	19.8392
895.000000 MHz	41.9503	19.7489
905.000000 MHz	41.8650	19.7166
915.000000 MHz	41.7337	19.6698
925.000000 MHz	41.6408	19.6566
935.000000 MHz	41.5240	19.6033

1800MHz System Performance Check

Measured Fluid Dielectric Parameters (Brain)

February 06, 2003

Frequency	e'	e''
1.700000000 GHz	40.3798	13.6837
1.710000000 GHz	40.3602	13.6951
1.720000000 GHz	40.3428	13.7239
1.730000000 GHz	40.3332	13.7635
1.740000000 GHz	40.2970	13.8033
1.750000000 GHz	40.2597	13.8594
1.760000000 GHz	40.2399	13.9108
1.770000000 GHz	40.1942	13.9531
1.780000000 GHz	40.1424	13.9931
1.790000000 GHz	40.1023	14.0196
1.800000000 GHz	40.0392	14.0514
1.810000000 GHz	39.9723	14.1044
1.820000000 GHz	39.9305	14.1262
1.830000000 GHz	39.8701	14.1601
1.840000000 GHz	39.8256	14.2024
1.850000000 GHz	39.7963	14.2136
1.860000000 GHz	39.7578	14.2371
1.870000000 GHz	39.6143	14.2698
1.880000000 GHz	39.6860	14.3051
1.890000000 GHz	39.6368	14.3388
1.900000000 GHz	39.5979	14.3539

1900MHz EUT Evaluation (Body)

Measured Fluid Dielectric Parameters (Muscle)

February 06, 2003

Frequency	ϵ'	ϵ''
1.780000000 GHz	52.7796	13.9878
1.790000000 GHz	52.7309	14.0132
1.800000000 GHz	52.7071	14.0612
1.810000000 GHz	52.6554	14.0826
1.820000000 GHz	52.6011	14.1030
1.830000000 GHz	52.5695	14.1222
1.840000000 GHz	52.5274	14.1438
1.850000000 GHz	52.4862	14.1684
1.860000000 GHz	52.4521	14.1907
1.870000000 GHz	52.4158	14.2044
1.880000000 GHz	52.3952	14.2296
1.890000000 GHz	52.3583	14.2626
1.900000000 GHz	52.3421	14.2806
1.910000000 GHz	52.2986	14.3021
1.920000000 GHz	52.2808	14.3184
1.930000000 GHz	52.2599	14.3450
1.940000000 GHz	52.2554	14.3601
1.950000000 GHz	52.2385	14.3833
1.960000000 GHz	52.2083	14.3903
1.970000000 GHz	52.1897	14.4155
1.980000000 GHz	52.1720	14.4436

900MHz System Performance Check

Measured Fluid Dielectric Parameters (Brain)

February 06, 2003

Frequency	ϵ'	ϵ''
800.000000 MHz	42.2516	19.8355
810.000000 MHz	42.1387	19.7978
820.000000 MHz	42.0176	19.7745
830.000000 MHz	41.8900	19.6955
840.000000 MHz	41.7743	19.6998
850.000000 MHz	41.6084	19.6252
860.000000 MHz	41.5266	19.6111
870.000000 MHz	41.3653	19.5597
880.000000 MHz	41.2624	19.5538
890.000000 MHz	41.1575	19.5290
900.000000 MHz	41.0716	19.4246
910.000000 MHz	40.9775	19.3990
920.000000 MHz	40.8824	19.3600
930.000000 MHz	40.7844	19.3181
940.000000 MHz	40.6835	19.2880
950.000000 MHz	40.5394	19.2632
960.000000 MHz	40.4590	19.2477
970.000000 MHz	40.3532	19.2035
980.000000 MHz	40.2108	19.2099
990.000000 MHz	40.1196	19.1911
1.000000000 GHz	40.0367	19.1474

835MHz EUT Evaluation (Body)

Measured Fluid Dielectric Parameters (Muscle)

February 06, 2003

Frequency	ϵ'	ϵ''
735.000000 MHz	54.1219	21.2500
745.000000 MHz	54.0580	21.2023
755.000000 MHz	53.8874	21.1430
765.000000 MHz	53.7792	21.0768
775.000000 MHz	53.6616	21.0385
785.000000 MHz	53.5728	21.0030
795.000000 MHz	53.4847	20.9566
805.000000 MHz	53.4224	20.9078
815.000000 MHz	53.3484	20.8636
825.000000 MHz	53.2422	20.8426
835.000000 MHz	53.1222	20.8164
845.000000 MHz	53.0085	20.7944
855.000000 MHz	52.8885	20.7431
865.000000 MHz	52.7609	20.7175
875.000000 MHz	52.6412	20.7008
885.000000 MHz	52.5292	20.6925
895.000000 MHz	52.4905	20.6048
905.000000 MHz	52.3781	20.5621
915.000000 MHz	52.2834	20.5548
925.000000 MHz	52.2066	20.5053
935.000000 MHz	52.0883	20.4833

2450MHz System Performance Check

Measured Fluid Dielectric Parameters (Brain)

February 07, 2003

Frequency		ϵ'	ϵ''
2.350000000	GHz	36.0271	13.4825
2.360000000	GHz	35.9858	13.5136
2.370000000	GHz	35.9561	13.5416
2.380000000	GHz	35.8820	13.5731
2.390000000	GHz	35.8409	13.6076
2.400000000	GHz	35.8087	13.6250
2.410000000	GHz	35.7851	13.6529
2.420000000	GHz	35.7485	13.6860
2.430000000	GHz	35.7071	13.7158
2.440000000	GHz	35.6612	13.7313
2.450000000	GHz	35.6146	13.7553
2.460000000	GHz	35.5814	13.7824
2.470000000	GHz	35.5463	13.8163
2.480000000	GHz	35.5167	13.8463
2.490000000	GHz	35.4821	13.8648
2.500000000	GHz	35.4283	13.8774
2.510000000	GHz	35.3818	13.9054
2.520000000	GHz	35.3310	13.9638
2.530000000	GHz	35.2906	13.9708
2.540000000	GHz	35.2207	13.9991
2.550000000	GHz	35.2970	14.0188

2450MHz EUT Evaluation (Body)

Measured Fluid Dielectric Parameters (Muscle)

February 07, 2003

Frequency	e'	e''
2.350000000 GHz	48.1875	14.4457
2.360000000 GHz	48.1641	14.5004
2.370000000 GHz	48.1334	14.5432
2.380000000 GHz	48.1113	14.5419
2.390000000 GHz	48.0725	14.5613
2.400000000 GHz	48.0341	14.5611
2.410000000 GHz	47.9777	14.5897
2.420000000 GHz	47.9240	14.6325
2.430000000 GHz	47.8743	14.6652
2.440000000 GHz	47.8417	14.7100
2.450000000 GHz	47.7897	14.7756
2.460000000 GHz	47.7626	14.8481
2.470000000 GHz	47.7327	14.8916
2.480000000 GHz	47.7271	14.9228
2.490000000 GHz	47.6871	14.9452
2.500000000 GHz	47.6706	14.9364
2.510000000 GHz	47.6281	14.9757
2.520000000 GHz	47.5699	14.9994
2.530000000 GHz	47.5285	15.0253
2.540000000 GHz	47.4758	15.0640
2.550000000 GHz	47.4343	15.1240

2450MHz EUT Evaluation (Body)

Measured Fluid Dielectric Parameters (Muscle)

February 07, 2003

Frequency	e'	e''
2.350000000 GHz	48.1875	14.4457
2.360000000 GHz	48.1641	14.5004
2.370000000 GHz	48.1334	14.5432
2.380000000 GHz	48.1113	14.5419
2.390000000 GHz	48.0725	14.5613
2.400000000 GHz	48.0341	14.5611
2.410000000 GHz	47.9777	14.5897
2.420000000 GHz	47.9240	14.6325
2.430000000 GHz	47.8743	14.6652
2.440000000 GHz	47.8417	14.7100
2.450000000 GHz	47.7897	14.7756
2.460000000 GHz	47.7626	14.8481
2.470000000 GHz	47.7327	14.8916
2.480000000 GHz	47.7271	14.9228
2.490000000 GHz	47.6871	14.9452
2.500000000 GHz	47.6706	14.9364
2.510000000 GHz	47.6281	14.9757
2.520000000 GHz	47.5699	14.9994
2.530000000 GHz	47.5285	15.0253
2.540000000 GHz	47.4758	15.0640
2.550000000 GHz	47.4343	15.1240

APPENDIX F - SAM PHANTOM CERTIFICATE OF CONFORMITY

Schmid & Partner Engineering AG

Zeughausstrasse 43, 8004 Zurich, Switzerland, Phone +41 1 245 97 00, Fax +41 1 245 97 79

Certificate of conformity / First Article Inspection

Item	SAM Twin Phantom V4.0
Type No	QD 000 P40 BA
Series No	TP-1002 and higher
Manufacturer / Origin	Untersee Composites Hauptstr. 69 CH-8559 Fruthwilen Switzerland

Tests

The series production process used allows the limitation to test of first articles. Complete tests were made on the pre-series Type No. QD 000 P40 AA, Serial No. TP-1001 and on the series first article Type No. QD 000 P40 BA, Serial No. TP-1006. Certain parameters have been retested using further series units (called samples).

Test	Requirement	Details	Units tested
Shape	Compliance with the geometry according to the CAD model.	IT'IS CAD File (*)	First article, Samples
Material thickness	Compliant with the requirements according to the standards	2mm +/- 0.2mm in specific areas	First article, Samples
Material parameters	Dielectric parameters for required frequencies	200 MHz – 3 GHz Relative permittivity < 5 Loss tangent < 0.05.	Material sample TP 104-5
Material resistivity	The material has been tested to be compatible with the liquids defined in the standards	Liquid type HSL 1800 and others according to the standard.	Pre-series, First article

Standards

- [1] CENELEC EN 50361
- [2] IEEE P1528-200x draft 6.5
- [3] IEC PT 62209 draft 0.9

(*) The IT'IS CAD file is derived from [2] and is also within the tolerance requirements of the shapes of [1] and [3].

Conformity

Based on the sample tests above, we certify that this item is in compliance with the uncertainty requirements of SAR measurements specified in standard [1] and draft standards [2] and [3].

Date 18.11.2001

Signature / Stamp



**Schmid & Partner
Engineering AG**



Zeughausstrasse 43, CH-8004 Zurich
Tel. +41 1 245 97 00, Fax +41 1 245 97 79

APPENDIX G - SAR TEST SETUP & EUT PHOTOGRAPHS

SAR TEST SETUP PHOTOGRAPHS
Single-Band External Stubby Antenna (P/N: 805-606-004)
Left Head Section / Cheek-Touch Position



SAR TEST SETUP PHOTOGRAPHS
Single-Band External Stubby Antenna (P/N: 805-606-004)
Left Head Section / Ear-Tilt Position



SAR TEST SETUP PHOTOGRAPHS
Single-Band External Stubby Antenna (P/N: 805-606-004)
Right Head Section / Cheek-Touch Position



SAR TEST SETUP PHOTOGRAPHS
Single-Band External Stubby Antenna (P/N: 805-606-004)
Right Head Section / Ear-Tilt Position

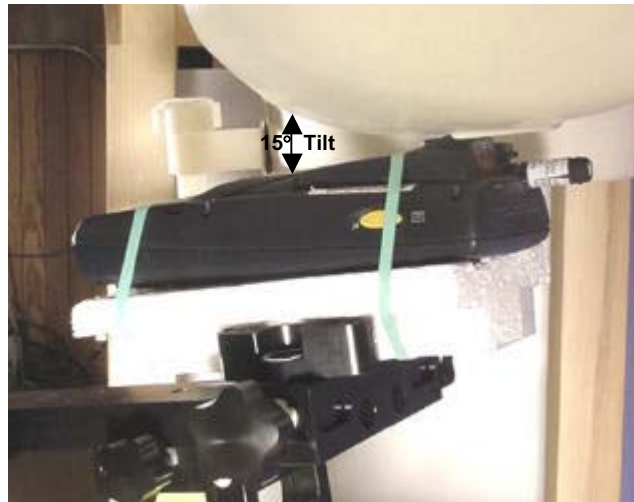

SAR TEST SETUP PHOTOGRAPHS
Dual-Band External Stubby Antenna (P/N: 805-606-002)
Left Head Section / Cheek-Touch Position



SAR TEST SETUP PHOTOGRAPHS
Dual-Band External Stubby Antenna (P/N: 805-606-002)
Left Head Section / Ear-Tilt Position

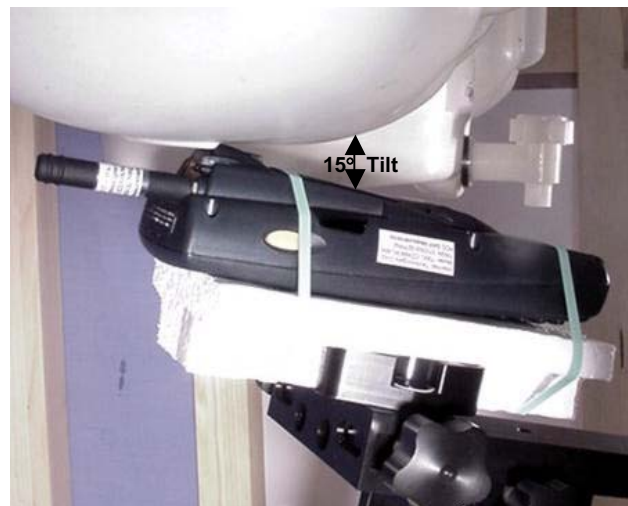

SAR TEST SETUP PHOTOGRAPHS
Dual-Band External Stubby Antenna (P/N: 805-606-002)
Right Head Section / Cheek-Touch Position



SAR TEST SETUP PHOTOGRAPHS
Dual-Band External Stubby Antenna (P/N: 805-606-002)
Right Head Section / Ear-Tilt Position

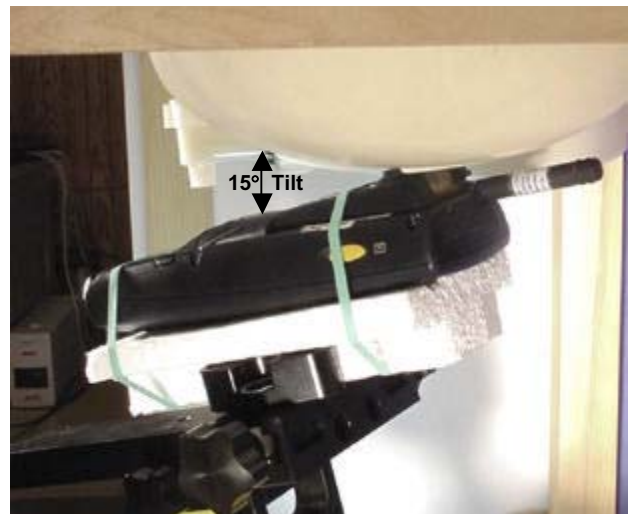

SAR TEST SETUP PHOTOGRAPHS
Single-Band External Stubby Antenna (P/N: 805-606-004)
Body-Worn / Back Side / 0.0cm Separation Distance

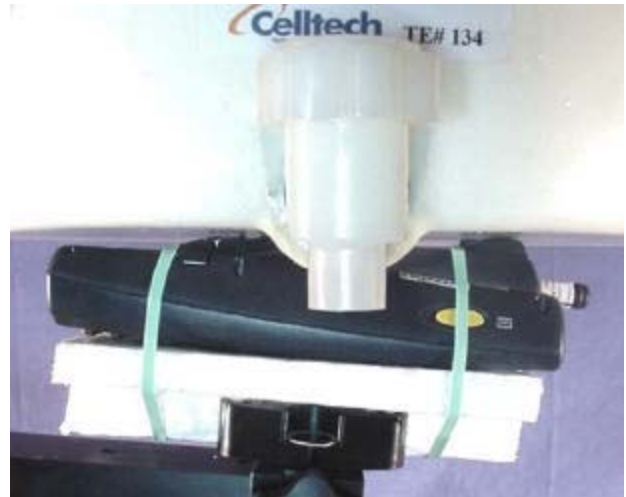

SAR TEST SETUP PHOTOGRAPHS
Single-Band External Stubby Antenna (P/N: 805-606-004)
Body-Worn / Right Side / 0.0cm Separation Distance



SAR TEST SETUP PHOTOGRAPHS
Single-Band External Stubby Antenna (P/N: 805-606-004
Body-Worn / Top Side / 1.5cm Separation Distance



SAR TEST SETUP PHOTOGRAPHS
Dual-Band External Stubby Antenna (P/N: 805-606-002)
Body-Worn / Back Side / 0.0cm Separation Distance



SAR TEST SETUP PHOTOGRAPHS
Dual-Band External Stubby Antenna (P/N: 805-606-002)
Body-Worn / Right Side / 0.0cm Separation Distance



SAR TEST SETUP PHOTOGRAPHS
Dual-Band External Stubby Antenna (P/N: 805-606-002)
Body-Worn / Top End / 1.5cm Separation Distance



SAR TEST SETUP PHOTOGRAPHS
Internal Patch Antenna
Body-Worn / Back Side / 0.0cm Separation Distance



SAR TEST SETUP PHOTOGRAPHS
Internal Patch Antenna
Body-Worn / Left Side / 0.0cm Separation Distance



SAR TEST SETUP PHOTOGRAPHS
Internal Patch Antenna
Body-Worn / Right Side / 0.0cm Separation Distance



EUT PHOTOGRAPHS
with Single-Band External Stubby Antenna (P/N: 805-606-004)



Front of EUT



Back of EUT



Single-Band Stubby Antenna (P/N: 805-606-004)



Left Side of EUT



Right Side of EUT

EUT PHOTOGRAPHS
with Dual-Band External Stubby Antenna (P/N: 805-606-002)



Front of EUT



Back of EUT



Dual-Band Stubby Antenna (P/N: 805-606-002)



Left Side of EUT



Right Side of EUT

EUT PHOTOGRAPHS



Battery Compartment



Lithium-Ion Battery



Lithium-Ion Battery