

Exhibit P: 802.11(b) SAR Report

FCC ID: HN22011B-2

DECLARATION OF COMPLIANCE SAR EVALUATION

Test Lab

CELLTECH RESEARCH INC.

Testing and Engineering Lab
1955 Moss Court
Kelowna, B.C.
Canada V1Y 9L3
Phone: 250-448-7047
Fax: 250-448-7046
e-mail: info@celltechlabs.com
web site: www.celltechlabs.com

Applicant Information

INTERMEC TECHNOLOGIES CORPORATION

6001 36th Avenue West
Everett, WA 98203

Rule Part(s):	FCC 47 CFR §2.1093; IC RSS-102 Issue 1 (Provisional)
FCC Test Procedure(s):	OET Bulletin 65, Supplement C (01-01)
Device Classification:	Part 15 Spread Spectrum Transmitter (DSS)
FCC ID:	HN22011B
Model(s):	700C
EUT Type:	Wireless Data Collection Terminal with DSSS WLAN Card
Modulation:	Direct Sequence Spread Spectrum (DSSS)
Tx Frequency Range:	2412 - 2462 MHz
Conducted Power Tested:	19.5 dBm (2437 MHz)
Antenna Type(s):	Internal Patch & External Stubby
Battery Type(s):	7.2V Lithium-ion (2000 mAh)
Max. SAR Measured:	0.154 W/kg

Celltech Research Inc. declares under its sole responsibility that this device was found to be in compliance with the Specific Absorption Rate (SAR) RF exposure requirements specified in FCC §2.1093 and Health Canada's Safety Code 6. The device was tested in accordance with the measurement standards and procedures specified in FCC OET Bulletin 65, Supplement C, Edition 01-01 and Industry Canada RSS-102 Issue 1 (General Population / Uncontrolled Exposure).

I attest to the accuracy of data. All measurements were performed by me or were made under my supervision and are correct to the best of my knowledge and belief. I assume full responsibility for the completeness of these measurements and vouch for the qualifications of all persons taking them.

This test report shall not be reproduced partially, or in full, without the prior written approval of Celltech Research Inc. The results and statements contained in this report pertain only to the device(s) evaluated.



Russell Pipe
Senior Compliance Technologist
Celltech Research Inc.



TABLE OF CONTENTS		
1.0	INTRODUCTION.....	3
2.0	DESCRIPTION OF EUT.....	3
3.0	SAR MEASUREMENT SYSTEM	4
4.0	MEASUREMENT SUMMARY.....	5
5.0	DETAILS OF SAR EVALUATION.....	6
6.0	EVALUATION PROCEDURES.....	7
7.0	SYSTEM VALIDATION.....	8
8.0	EQUIVALENT TISSUES.....	9
9.0	SAR LIMITS.....	9
10.0	SYSTEM SPECIFICATIONS.....	10
11.0	PROBE SPECIFICATION.....	11
12.0	SAM PHANTOM.....	11
13.0	DEVICE HOLDER.....	11
14.0	TEST EQUIPMENT LIST.....	12
15.0	MEASUREMENT UNCERTAINTIES.....	13
16.0	REFERENCES.....	14
	APPENDIX A - SAR MEASUREMENT DATA.....	15
	APPENDIX B - SYSTEM VALIDATION.....	16
	APPENDIX C - DIPOLE CALIBRATION.....	17
	APPENDIX D - PROBE CALIBRATION.....	18
	APPENDIX E - MEASURED FLUID DIELECTRIC PARAMETERS.....	19
	APPENDIX F - SAM PHANTOM CERTIFICATE OF CONFORMITY.....	20
	APPENDIX G - SAR TEST SETUP & EUT PHOTOGRAPHS.....	21

1.0 INTRODUCTION

This measurement report demonstrates that the Intermec Technologies Corporation Model: 700C Wireless Data Collection Terminal FCC ID: HN22011B with DSSS WLAN Card complies with the RF exposure requirements specified in FCC 47 CFR §2.1093 (see reference [1]), and Health Canada Safety Code 6 (see reference [2]) for the General Population / Uncontrolled Exposure environment. The test procedures described in FCC OET Bulletin 65, Supplement C, Edition 01-01 (see reference [3]) and IC RSS-102 Issue 1 (Provisional) (see reference [4]), were employed. A description of the product, operating configuration, detailed summary of the test results, methodology and procedures used in the evaluation, equipment used, and the various provisions of the rules are included within this test report.

2.0 DESCRIPTION of Equipment Under Test (EUT)

FCC Rule Part(s)	47 CFR §2.1093
IC Rule Part(s)	RSS-102 Issue 1 (Provisional)
Test Procedure(s)	FCC OET Bulletin 65, Supplement C (01-01)
FCC Device Classification	Part 15 Spread Spectrum Transmitter (DSS)
Device Type	Wireless Data Collection Terminal with DSSS WLAN Card
FCC ID	HN22011B
Model(s)	700C
Serial No.	Pre-production
Modulation	Direct Sequence Spread Spectrum
Tx Frequency Range	2412 - 2462 MHz
RF Conducted Power Tested	19.5 dBm (2437 MHz)
Antenna Type(s)	Internal Patch & External Stubby
Battery Type(s)	7.2V Lithium-ion (2000 mAh)

3.0 SAR MEASUREMENT SYSTEM

Celltech Research SAR measurement facility utilizes the Dosimetric Assessment System (DASY™) manufactured by Schmid & Partner Engineering AG (SPEAG™) of Zurich, Switzerland. The DASY system is comprised of the robot controller, computer, near-field probe, probe alignment sensor, specific anthropomorphic mannequin (SAM) phantom, and various planar phantoms for face-held and/or body-worn SAR evaluations. The robot is a six-axis industrial robot performing precise movements to position the probe to the location (points) of maximum electromagnetic field (EMF). A cell controller system contains the power supply, robot controller, teach pendant (Joystick), and remote control, is used to drive the robot motors. The Staubli robot is connected to the cell controller to allow software manipulation of the robot. A data acquisition electronic (DAE) circuit performs the signal amplification, signal multiplexing, AD-conversion, offset measurements, mechanical surface detection, collision detection, etc. is connected to the Electro-optical coupler (EOC). The EOC performs the conversion from the optical into digital electric signal of the DAE and transfers data to the PC plug-in card. The DAE3 utilizes a highly sensitive electrometer-grade preamplifier with auto-zeroing, a channel and gain-switching multiplexer, a fast 16-bit AD-converter and a command decoder and control logic unit. Transmission to the PC-card is accomplished through an optical downlink for data and status information and an optical uplink for commands and clock lines. The mechanical probe-mounting device includes two different sensor systems for frontal and sidewise probe contacts. They are also used for mechanical surface detection and probe collision detection. The robot uses its own controller with a built in VME-bus computer.



DASY3 SAR Measurement System with SAM phantom

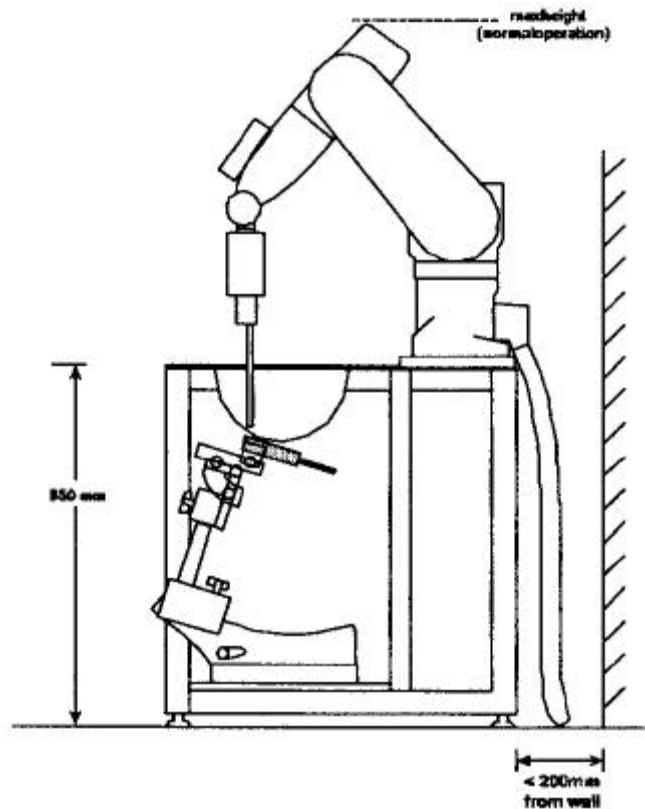

Figure 1. DASY3 Compact Version - Side View

4.0 MEASUREMENT SUMMARY

The measurement results were obtained with the EUT tested in the conditions described in this report. Detailed measurement data and plots showing the maximum SAR location of the EUT are reported in Appendix A.

BODY SAR MEASUREMENT RESULTS									
Freq. (MHz)	Channel	Mode	Conducted Power dBm		Phantom Section	EUT Position	Antenna Type	Separation Distance (cm)	Measured SAR 1g (W/kg)
			Before	After					
2437	Mid	DSSS	19.5	19.3	Planar	Back Side	Internal	0.0	0.154
2437	Mid	DSSS	19.5	19.3	Planar	Back Side	External	0.0	0.136
2437	Mid	DSSS	19.5	19.3	Planar	Right Side	Internal	0.0	0.0964
2437	Mid	DSSS	19.5	19.3	Planar	Right Side	External	0.0	0.153
ANSI / IEEE C95.1 1992 - SAFETY LIMIT BODY: 1.6 W/kg (averaged over 1 gram) Spatial Peak - Uncontrolled Exposure / General Population									
Test Date(s)	10/18/02				Relative Humidity	70 %			
Measured Mixture Type	2450MHz Muscle				Atmospheric Pressure	103.2 kPa			
Dielectric Constant ϵ_r	Target	Measured	Ambient Temperature		23.3 °C				
	52.7 ±10%	48.3	Fluid Temperature		23.5 °C				
Conductivity σ (mho/m)	Target	Measured	Fluid Depth		≥ 15 cm				
	1.95 ±10%	2.04	ρ (Kg/m ³)		1000				

Note(s):

1. SAR measurements at mid channel were ≥ 3 dB below the SAR limit, therefore measurements at the low and high channels were optional (per FCC OET Bulletin 65, Supplement C, Edition 01-01 (see reference [3])).

5.0 DETAILS OF SAR EVALUATION

The Intermec Technologies Corporation Model: 700C Wireless Data Collection Terminal FCC ID: HN22011B with DSSS WLAN Card was found to be compliant for localized Specific Absorption Rate based on the test provisions and conditions described below. Detailed photographs of the measurement setup are shown in Appendix G.

1. The EUT was tested for body SAR with the back side of the EUT placed parallel to the outer surface of the SAM planar phantom. A 0.0 cm separation distance was maintained between the back side of the EUT and the outer surface of the SAM planar phantom for the duration of the test.
2. The EUT was tested for body SAR with the right side of the EUT (antenna side) placed parallel to the outer surface of the SAM planar phantom. A 0.0 cm separation distance was maintained between the right side of the EUT and the outer surface of the SAM planar phantom for the duration of the test.
3. The EUT was operated for an appropriate period prior to the evaluation to minimize power drift.
4. The conducted power levels were checked before and after each test according to the procedures described in FCC Part 2.1046. During the entire test the conducted power was maintained to within 5% of the initial conducted power. Any unusual anomalies over the course of the test warranted a re-evaluation.
5. The EUT was placed in test mode via internal software and was tested at maximum power in DSSS continuous transmit mode (100% duty cycle).
6. The antenna to be evaluated (internal patch or external stubby) was selected via internal software using the keypad of the EUT.
7. The location of the maximum spatial SAR distribution (Hot Spot) was determined relative to the device and its antenna.
8. The EUT was tested with a fully charged 7.2V Lithium-ion battery.



**SAR Test Setup
Back Side of EUT**



**SAR Test Setup
Right Side of EUT**

6.0 EVALUATION PROCEDURES

a. (i) The evaluation was performed in the applicable area of the phantom depending on the type of device being tested. For devices held to the ear during normal operation, both the left and right ear positions were evaluated in accordance with FCC OET Bulletin 65, Supplement C (Edition 01-01) using the SAM phantom.

(ii) For body-worn and face-held devices a planar phantom was used.

b. The SAR was determined by a pre-defined procedure within the DASY3 software. Upon completion of a reference and optical surface check, the exposed region of the phantom was scanned near the inner surface with a grid spacing of 20mm x 20mm.

c. A 5x5x7 matrix was performed around the greatest spatial SAR distribution found during the area scan of the applicable exposed region. SAR values were then calculated using a 3-D spline interpolation algorithm and averaged over spatial volumes of 1 and 10 grams.

d. For this evaluation a stack of low-density, low-loss dielectric foamed polystyrene was used in place of the device holder.

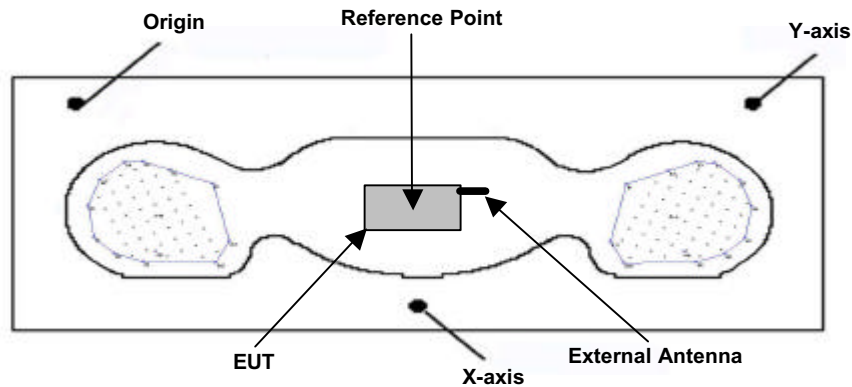

Figure 2. Phantom Reference Point & EUT Positioning - Back Side of EUT

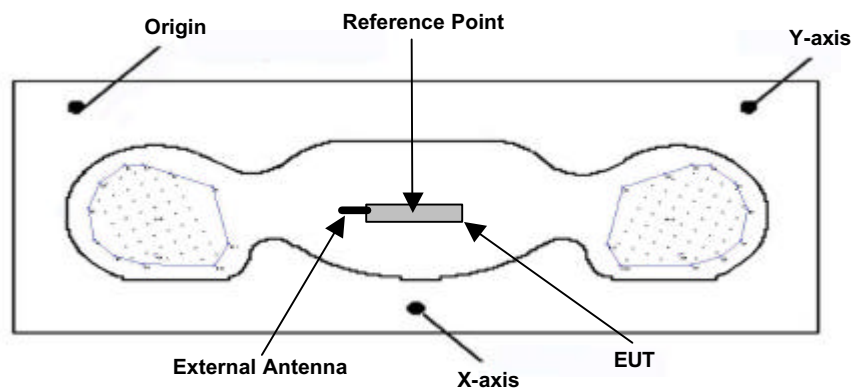

Figure 3. Phantom Reference Point & EUT Positioning - Right Side of EUT

7.0 SYSTEM VALIDATION

Prior to the assessment, the system was verified in the planar section of the SAM phantom with a 2450MHz dipole (see Appendix C for detailed dipole calibration procedures). The fluids were verified using an 85070C Dielectric Probe Kit and an 8753E Network Analyzer (see Appendix E for printout of measured fluid dielectric parameters). A forward power of 250 mW was applied to the dipole and system was verified to a tolerance of $\pm 10\%$ (see Appendix B for system validation test plot).

SYSTEM VALIDATION											
Test Date	Equiv. Tissue	SAR 1g (W/kg)		Dielectric Constant ϵ_r		Conductivity σ (mho/m)		ρ (Kg/m ³)	Ambient Temp.	Fluid Temp.	Fluid Depth
		Target	Measured	Target	Measured	Target	Measured				
10/18/02	2450MHz (Brain)	14.2 $\pm 10\%$	13.1	39.2 $\pm 10\%$	37.4	1.80 $\pm 10\%$	1.89	1000	23.3 °C	23.5 °C	≥ 15 cm

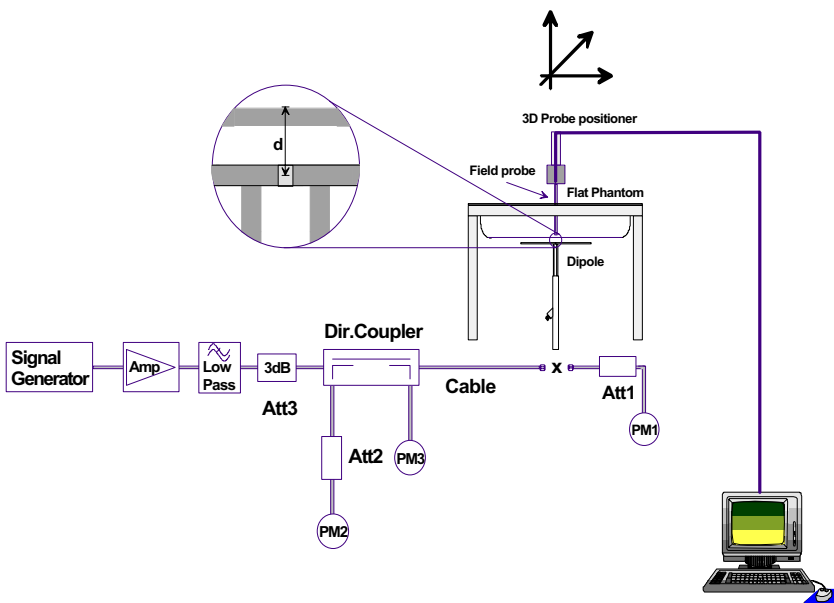

Figure 5. System Validation Setup Diagram



2450MHz Dipole Validation Setup

8.0 EQUIVALENT TISSUES

The 2450MHz brain and body mixtures consist of Glycol-monobutyl, water, and salt (body mixture only). The fluid was prepared according to standardized procedures and measured for dielectric parameters (permittivity and conductivity).

TISSUE MIXTURES		
INGREDIENT	2450MHz Brain Mixture (System Validation)	2450MHz Body Mixture (EUT Evaluation)
Water	55.20 %	69.95 %
Glycol Monobutyl	44.80 %	30.00 %
Salt	-	0.05 %

9.0 SAR SAFETY LIMITS

EXPOSURE LIMITS	SAR (W/Kg)	
	(General Population / Uncontrolled Exposure Environment)	(Occupational / Controlled Exposure Environment)
Spatial Average (averaged over the whole body)	0.08	0.4
Spatial Peak (averaged over any 1 g of tissue)	1.60	8.0
Spatial Peak (hands/wrists/feet/ankles averaged over 10 g)	4.0	20.0

Notes:

1. Uncontrolled environments are defined as locations where there is potential exposure of individuals who have no knowledge or control of their potential exposure.
2. Controlled environments are defined as locations where there is potential exposure of individuals who have knowledge of their potential exposure and can exercise control over their exposure.

10.0 ROBOT SYSTEM SPECIFICATIONS

Specifications

POSITIONER: Stäubli Unimation Corp. Robot Model: RX60L
Repeatability: 0.02 mm
No. of axis: 6

Data Acquisition Electronic (DAE) System

Cell Controller

Processor: Pentium III
Clock Speed: 450 MHz
Operating System: Windows NT
Data Card: DASY3 PC-Board

Data Converter

Features: Signal Amplifier, multiplexer, A/D converter, and control logic
Software: DASY3 software
Connecting Lines: Optical downlink for data and status info.
Optical uplink for commands and clock

PC Interface Card

Function: 24 bit (64 MHz) DSP for real time processing
Link to DAE3
16-bit A/D converter for surface detection system
serial link to robot
direct emergency stop output for robot

E-Field Probe

Model: ET3DV6
Serial No.: 1387
Construction: Triangular core fiber optic detection system
Frequency: 10 MHz to 6 GHz
Linearity: ± 0.2 dB (30 MHz to 3 GHz)

Phantom

Type: SAM V4.0C
Shell Material: Fiberglass
Thickness: 2.0 \pm 0.1 mm
Volume: Approx. 20 liters

11.0 PROBE SPECIFICATION (ET3DV6)

Construction:	Symmetrical design with triangular core Built-in shielding against static charges PEEK enclosure material (resistant to organic solvents, e.g. glycol)
Calibration:	In air from 10 MHz to 2.5 GHz In brain simulating tissue at frequencies of 900 MHz and 1.8 GHz (accuracy $\pm 8\%$)
Frequency:	10 MHz to >6 GHz; Linearity: ± 0.2 dB (30 MHz to 3 GHz)
Directivity:	± 0.2 dB in brain tissue (rotation around probe axis) ± 0.4 dB in brain tissue (rotation normal to probe axis)
Dynam. Rnge:	5 μ W/g to >100 mW/g; Linearity: ± 0.2 dB
Srfce. Detect.	± 0.2 mm repeatability in air and clear liquids over diffuse reflecting surfaces
Dimensions:	Overall length: 330 mm Tip length: 16 mm Body diameter: 12 mm Tip diameter: 6.8 mm Distance from probe tip to dipole centers: 2.7 mm
Application:	General dosimetry up to 3 GHz Compliance tests of mobile phone



ET3DV6 E-Field Probe

12.0 SAM PHANTOM V4.0C

The SAM phantom V4.0C is a fiberglass shell phantom with a 2.0 mm shell thickness for left and right head and flat planar area integrated in a wooden table. The shape of the fiberglass shell corresponds to the phantom defined by SCC34-SC2. The device holder positions are adjusted to the standard measurement positions in the three sections.

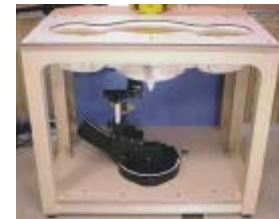

SAM Phantom

13.0 DEVICE HOLDER

The DASY3 device holder has two scales for device rotation (with respect to the body axis) and the device inclination (with respect to the line between the ear openings). The plane between the ear openings and the mouth tip has a rotation angle of 65° . The bottom plate contains three pair of bolts for locking the device holder. The device holder positions are adjusted to the standard measurement positions in the three sections.



Device Holder

14.0 TEST EQUIPMENT LIST

SAR MEASUREMENT SYSTEM		
EQUIPMENT	SERIAL NO.	CALIBRATION DATE
DASY3 System -Robot -ET3DV6 E-Field Probe -300MHz Validation Dipole -450MHz Validation Dipole -900MHz Validation Dipole -1800MHz Validation Dipole -2450MHz Validation Dipole -SAM Phantom V4.0C -Small Planar Phantom -Medium Planar Phantom -Large Planar Phantom	599396-01 1387 135 136 054 247 150 N/A N/A N/A N/A	N/A Feb 2002 Oct 2001 Oct 2001 June 2001 June 2001 Oct 2001 N/A N/A N/A N/A
85070C Dielectric Probe Kit	N/A	N/A
Gigatronics 8652A Power Meter -Power Sensor 80701A -Power Sensor 80701A	1835272 1833535 1833542	Feb 2002 Feb 2002 Mar 2002
E4408B Spectrum Analyzer	US39240170	Nov 2001
8594E Spectrum Analyzer	3543A02721	Feb 2002
8753E Network Analyzer	US38433013	Feb 2002
8648D Signal Generator	3847A00611	Feb 2002
5S1G4 Amplifier Research Power Amplifier	26235	N/A

15.0 MEASUREMENT UNCERTAINTIES

Error Description	Uncertainty Value ±%	Probability Distribution	Divisor	C_i 1g	Standard Uncertainty ±% (1g)	v_i or v_{eff}
Measurement System						
Probe calibration	± 4.8	Normal	1	1	± 4.8	∞
Axial isotropy of the probe	± 4.7	Rectangular	√3	(1- C_p)	± 1.9	∞
Spherical isotropy of the probe	± 9.6	Rectangular	√3	(C_p)	± 3.9	∞
Spatial resolution	± 0.0	Rectangular	√3	1	± 0.0	∞
Boundary effects	± 5.5	Rectangular	√3	1	± 3.2	∞
Probe linearity	± 4.7	Rectangular	√3	1	± 2.7	∞
Detection limit	± 1.0	Rectangular	√3	1	± 0.6	∞
Readout electronics	± 1.0	Normal	1	1	± 1.0	∞
Response time	± 0.8	Rectangular	√3	1	± 0.5	∞
Integration time	± 1.4	Rectangular	√3	1	± 0.8	∞
RF ambient conditions	± 3.0	Rectangular	√3	1	± 1.7	∞
Mech. constraints of robot	± 0.4	Rectangular	√3	1	± 0.2	∞
Probe positioning	± 2.9	Rectangular	√3	1	± 1.7	∞
Extrapolation & integration	± 3.9	Rectangular	√3	1	± 2.3	∞
Test Sample Related						
Device positioning	± 6.0	Normal	√3	1	± 6.7	12
Device holder uncertainty	± 5.0	Normal	√3	1	± 5.9	8
Power drift	± 5.0	Rectangular	√3		± 2.9	∞
Phantom and Setup						
Phantom uncertainty	± 4.0	Rectangular	√3	1	± 2.3	∞
Liquid conductivity (target)	± 5.0	Rectangular	√3	0.6	± 1.7	∞
Liquid conductivity (measured)	± 10.0	Rectangular	√3	0.6	± 3.5	∞
Liquid permittivity (target)	± 5.0	Rectangular	√3	0.6	± 1.7	∞
Liquid permittivity (measured)	± 5.0	Rectangular	√3	0.6	± 1.7	∞
Combined Standard Uncertainty					± 13.7	
Expanded Uncertainty (k=2)					± 27.5	

Measurement Uncertainty Table in accordance with IEEE Std 1528 (Draft - see reference [5])

16.0 REFERENCES

- [1] Federal Communications Commission, "Radiofrequency radiation exposure evaluation: portable devices", Rule Part 47 CFR §2.1093: 1999.
- [2] Health Canada, "Limits of Human Exposure to Radiofrequency Electromagnetic Fields in the Frequency Range from 3 kHz to 300 GHz", Safety Code 6.
- [3] Federal Communications Commission, "Evaluating Compliance with FCC Guidelines for Human Exposure to Radio frequency Electromagnetic Fields", OET Bulletin 65, Supplement C (Edition 01-01), FCC, Washington, D.C.: June 2001.
- [4] Industry Canada, "Evaluation Procedure for Mobile and Portable Radio Transmitters with respect to Health Canada's Safety Code 6 for Exposure of Humans to Radio Frequency Fields", Radio Standards Specification RSS-102 Issue 1 (Provisional): September 1999.
- [5] IEEE Standards Coordinating Committee 34, Std 1528-200X, "DRAFT Recommended Practice for Determining the Spatial-Peak Specific Absorption Rate (SAR) in the Human Body Due to Wireless Communications Devices: Experimental Techniques".

APPENDIX A - SAR MEASUREMENT DATA

Intermec Technologies Corp. FCC ID: HN22011B

SAM Phantom; Flat Section; Position: (270°,270°)
 Probe: ET3DV6 - SN1387; ConvF(4.30,4.30,4.30); Crest factor: 1.0
 2450 MHz Muscle: $\sigma = 2.04 \text{ mho/m}$ $\epsilon_r = 48.3$ $\rho = 1.00 \text{ g/cm}^3$
 Coarse: Dx = 15.0, Dy = 15.0, Dz = 10.0
 Cube 5x5x7; Powerdrift: -0.17 dB
 SAR (1g): 0.154 mW/g, SAR (10g): 0.0802 mW/g

Body SAR - 0.0cm Separation Distance - Back Side of EUT
 Handheld Data Terminal with 2.4 GHz DSSS WLAN Card
 Intermec Model: 700C with Internal Patch Antenna
 7.2V Lithium-ion Battery (2000 mAh)
 DSSS Mode (Continuous Transmit @ Max. Power)
 Mid Channel [2437 MHz]
 Conducted Power: 19.5 dBm
 Ambient Temp. 23.3°C; Fluid Temp. 23.5°C
 Date Tested: October 18, 2002

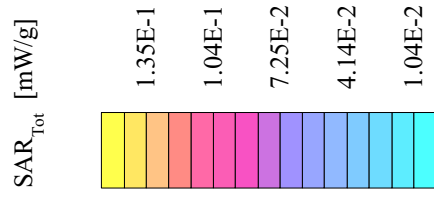
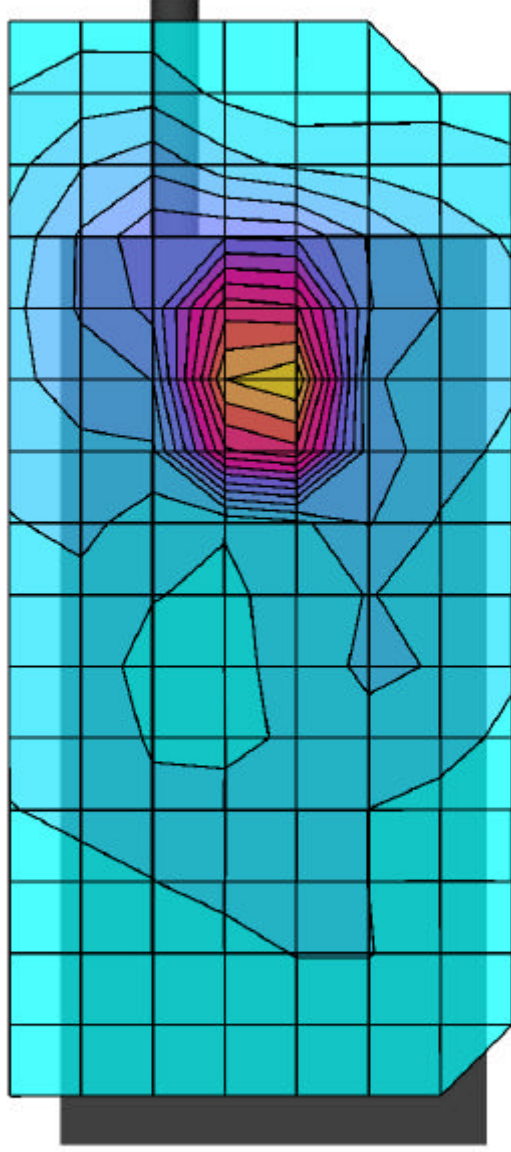

Intermec Technologies Corp. FCC ID: HN22011B

SAM Phantom; Flat Section

Probe: ET3DV6 - SN1387; ConvF(4.30,4.30,4.30); Crest factor: 1.0
2450 MHz Muscle: $\sigma = 2.04 \text{ mho/m}$ $\epsilon_r = 48.3$ $\rho = 1.00 \text{ g/cm}^3$

Z-Axis Extrapolation at Peak SAR Location

Body SAR - 0.0cm Separation Distance - Back Side of EUT
Handheld Data Terminal with 2.4 GHz DSSS WLAN Card
Intermec Model: 700C with Internal Patch Antenna
7.2V Lithium-ion Battery (2000 mAh)
DSSS Mode (Continuous Transmit @ Max. Power)
Mid Channel [2437 MHz]
Conducted Power: 19.5 dBm
Ambient Temp. 23.3°C; Fluid Temp. 23.5°C
Date Tested: October 18, 2002

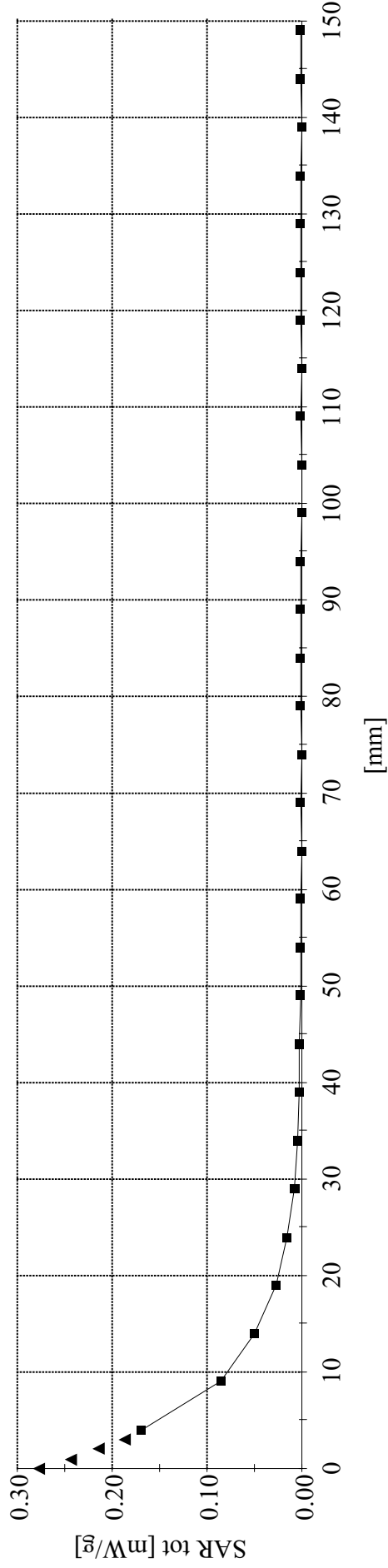

Intermec Technologies Corp. FCC ID: HN22011B

SAM Phantom; Flat Section; Position: (270°,270°)
 Probe: ET3DV6 - SN1387; ConvF(4.30,4.30,4.30); Crest factor: 1.0
 2450 MHz Muscle: $\sigma = 2.04 \text{ mho/m}$ $\epsilon_r = 48.3$ $\rho = 1.00 \text{ g/cm}^3$
 Coarse: Dx = 15.0, Dy = 15.0, Dz = 10.0
 Cube 5x5x7; Powerdrift: -0.16 dB
 SAR (1g): 0.136 mW/g, SAR (10g): 0.0688 mW/g

Body SAR - 0.0cm Separation Distance - Back Side of EUT
 Handheld Data Terminal with 2.4 GHz DSSS WLAN Card
 Intermec Model: 700C with External Stubby Antenna
 7.2V Lithium-ion Battery (2000 mAh)
 DSSS Mode (Continuous Transmit @ Max. Power)
 Mid Channel [2437 MHz]
 Conducted Power: 19.5 dBm
 Ambient Temp. 23.3°C; Fluid Temp. 23.5°C
 Date Tested: October 18, 2002

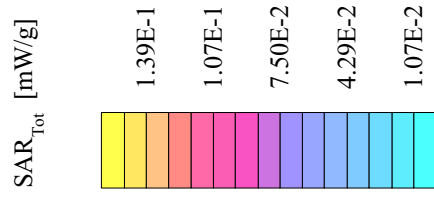
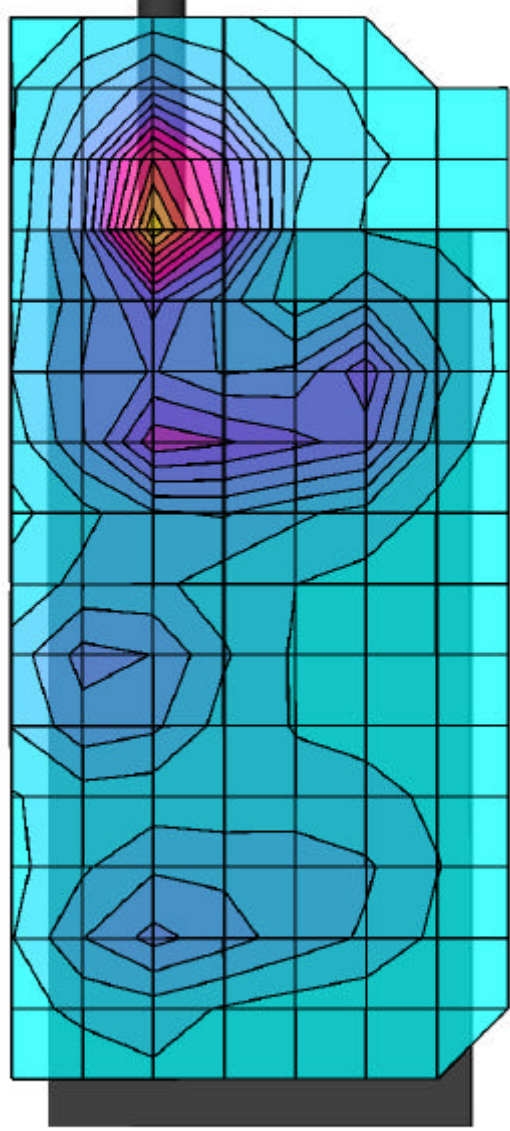

Intermec Technologies Corp. FCC ID: HN22011B

SAM Phantom; Flat Section; Position: (90°, 270°)
 Probe: ET3DV6 - SN1387; ConvF(4.30,4.30,4.30); Crest factor: 1.0
 2450 MHz Muscle: $\sigma = 2.04 \text{ mho/m}$, $\epsilon_r = 48.3$, $\rho = 1.00 \text{ g/cm}^3$
 Coarse: Dx = 15.0, Dy = 15.0, Dz = 10.0
 Cube 5x5x7; Powerdrift: -0.15 dB
 SAR (1g): 0.0964 mW/g, SAR (10g): 0.0515 mW/g

Body SAR - 0.0cm Separation Distance - Right Side of EUT
 Handheld Data Terminal with 2.4 GHz DSSS WLAN Card
 Intermec Model: 700C with Internal Patch Antenna
 7.2V Lithium-ion Battery (2000 mAh)
 DSSS Mode (Continuous Transmit @ Max. Power)
 Mid Channel [2437 MHz]
 Conducted Power: 19.5 dBm
 Ambient Temp. 23.3°C; Fluid Temp. 23.5°C
 Date Tested: October 18, 2002

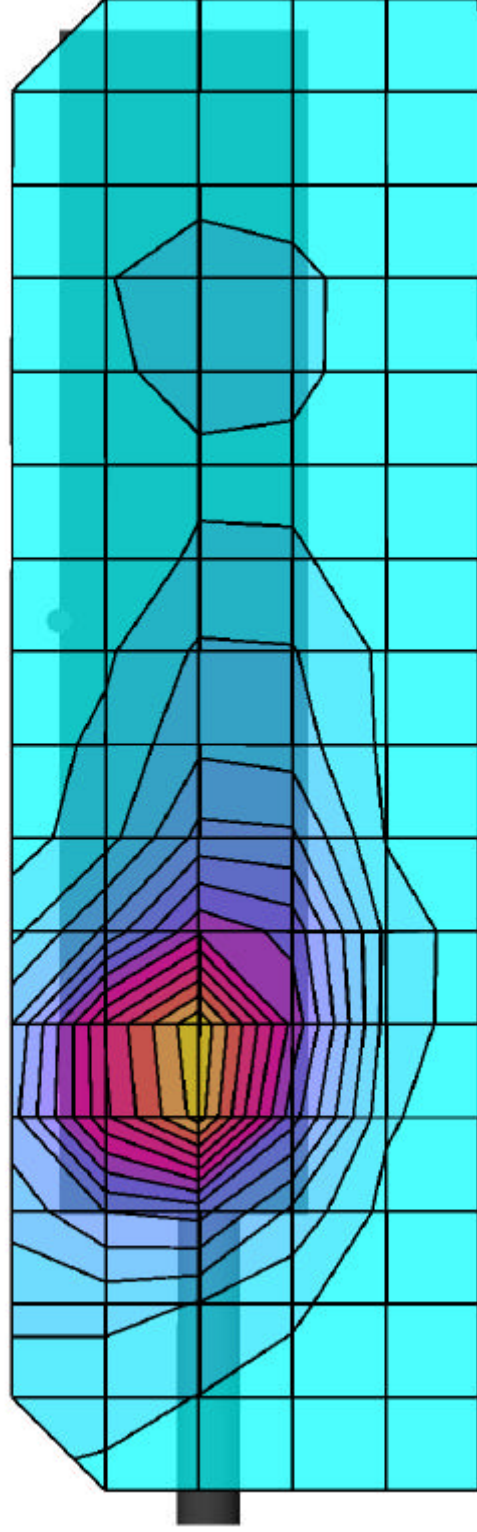

Intermec Technologies Corp. FCC ID: HN22011B

SAM Phantom; Flat Section; Position: (270°, 90°)
Probe: ET3DV6 - SN1387; ConvF(4.30,4.30,4.30); Crest factor: 1.0
2450 MHz Muscle: $\sigma = 2.04 \text{ mho/m}$ $\epsilon_r = 48.3$ $\rho = 1.00 \text{ g/cm}^3$
Coarse: Dx = 15.0, Dy = 15.0, Dz = 10.0
Cube 5x5x7; Powerdrift: -0.19 dB
SAR (1g): 0.153 mW/g, SAR (10g): 0.0787 mW/g

Body SAR - 0.0cm Separation Distance - Right Side of EUT
Handheld Data Terminal with 2.4 GHz DSSS WLAN Card
Intermec Model: 700C with External Stubby Antenna
7.2V Lithium-ion Battery (2000 mAh)
DSSS Mode (Continuous Transmit @ Max. Power)
Mid Channel [2437 MHz]
Conducted Power: 19.5 dBm
Ambient Temp. 23.3°C; Fluid Temp. 23.5°C
Date Tested: October 18, 2002

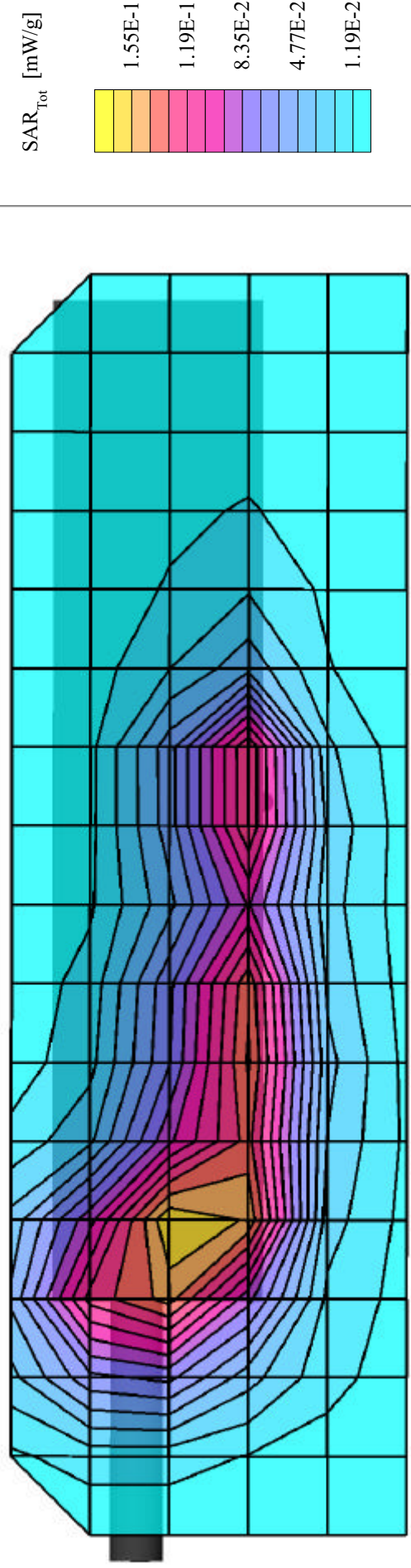

APPENDIX B - SYSTEM VALIDATION

Dipole 2450MHz

SAM Phantom; Flat Section

Probe: ET3DV6 - SNI387; ConvF(4.70,4.70,4.70); Crest factor: 1.0; 2450 MHz Brain: $\sigma = 1.89$ mho/m $\epsilon_r = 37.4$ $\rho = 1.00$ g/cm³

Cube 5x5x7; Peak: 28.5 mW/g, SAR (1g): 13.1 mW/g, SAR (10g): 5.80 mW/g, (Worst-case extrapolation)

Penetration depth: 5.9 (5.7, 6.6) [mm]; Ambient Temp. 23.3°C; Fluid Temp. 23.5°C

Powerdrift: -0.01 dB

2450MHz Validation

Date: October 18, 2002

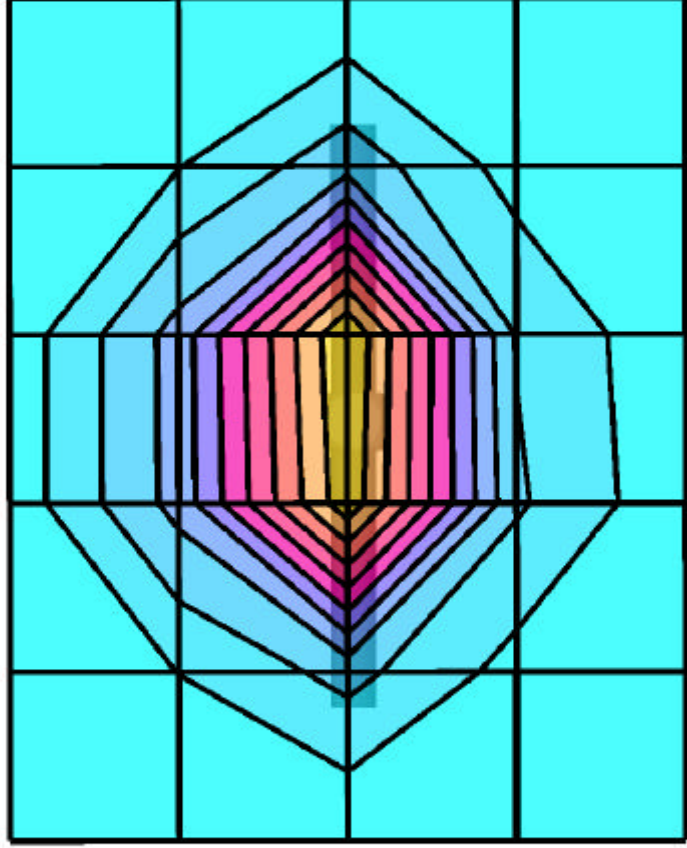

SAR_{tot} [mW/g]

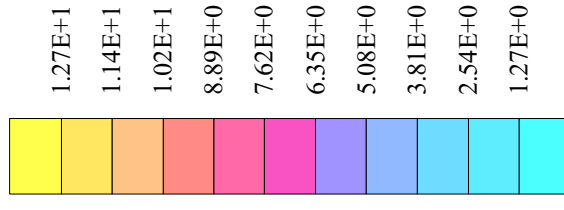

APPENDIX C - DIPOLE CALIBRATION

2450MHz SYSTEM VALIDATION DIPOLE

Type:

2450MHz Validation Dipole

Serial Number:

150

Place of Calibration:

Celltech Research Inc.

Date of Calibration:

October 24, 2001

Celltech Research Inc. hereby certifies that this device has been calibrated on the date indicated above.

Calibrated by:



Approved by:

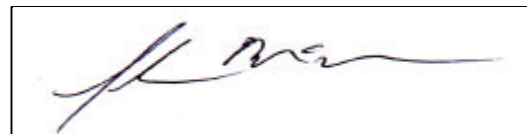

1. Dipole Construction & Electrical Characteristics

The validation dipole was constructed in accordance with the IEEE Std "Recommended Practice for Determining the Spatial-Peak Specific Absorption Rate (SAR) in the Human Body Due to Wireless Communications Devices: Experimental Techniques". The electrical properties were measured using an HP 8753E Network Analyzer. The network analyzer was calibrated to the validation dipole N-type connector feed point using an HP85032E Type N calibration kit. The dipole was placed parallel to a planar phantom at a separation distance of 10.0mm from the simulating fluid using a loss-less dielectric spacer. The measured input impedance is:

Feed point impedance at 2450MHz	$\text{Re}\{Z\} = 49.268\Omega$ $\text{Im}\{Z\} = 0.4121\Omega$
Return Loss at 2450MHz	-40.897dB

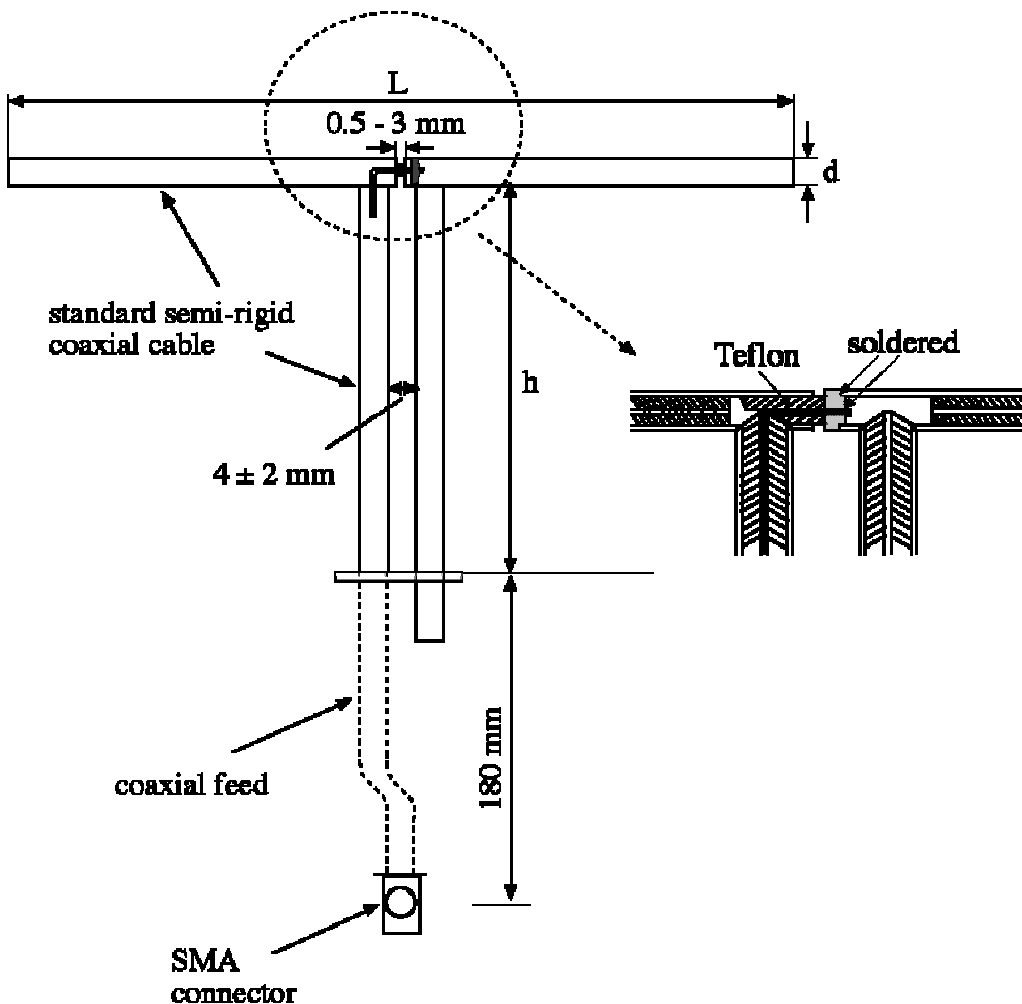

9 Nov 2001 09:52:05

CH1 S11 LOG 10 dB/REF 0 dB 1:-40.897 dB 2:450.000 000 MHz

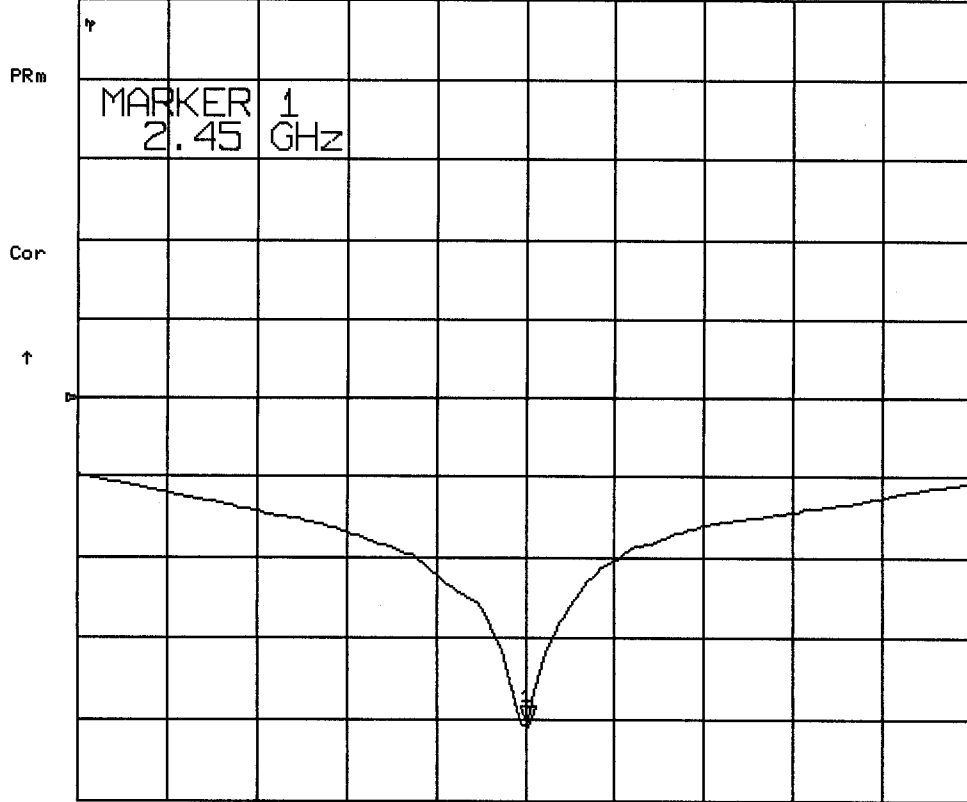

START 2 250.000 000 MHz

STOP 2 650.000 000 MHz

9 Nov 2001 09:52:18

CH1 S11 1 U FS 1: 49.268 Ω 0.4121 Ω 26.771 pH 2 450.000 000 MHz

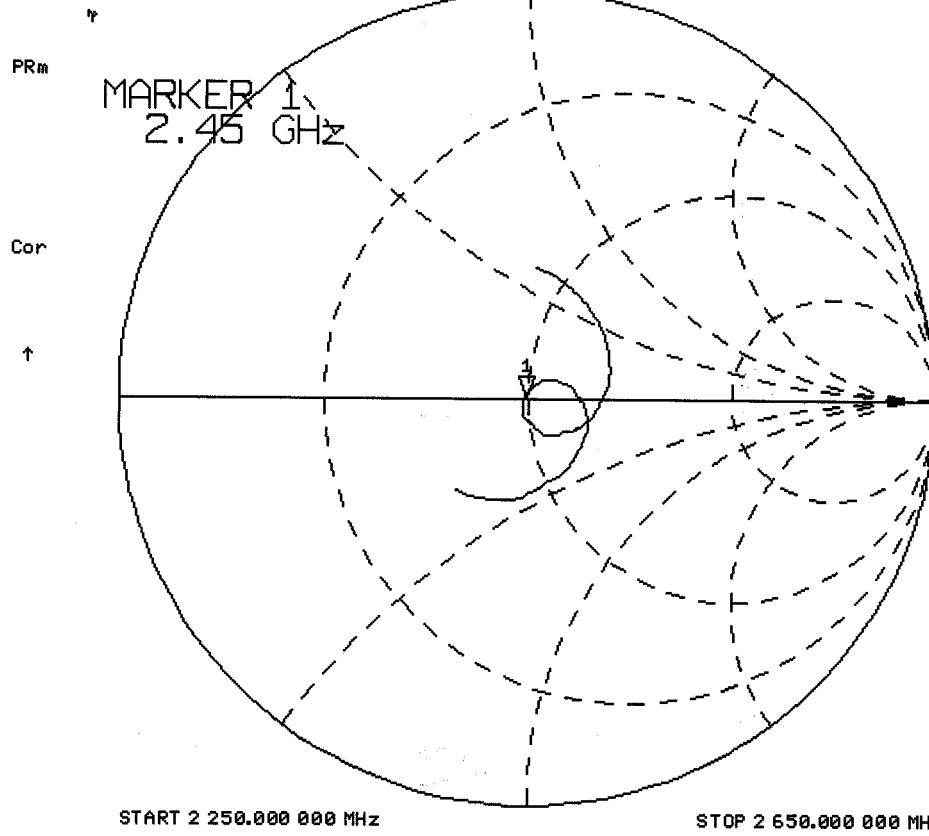

Validation Dipole Dimensions

Frequency (MHz)	L (mm)	h (mm)	d (mm)
300	420.0	250.0	6.2
450	288.0	167.0	6.2
835	161.0	89.8	3.6
900	149.0	83.3	3.6
1450	89.1	51.7	3.6
1800	72.0	41.7	3.6
1900	68.0	39.5	3.6
2000	64.5	37.5	3.6
2450	51.8	30.6	3.6
3000	41.5	25.0	3.6

2. Validation Phantom

The validation phantom is the SAM (Specific Anthropomorphic Mannequin) phantom manufactured by Schmid & Partner Engineering AG. The SAM phantom is a Fiberglass shell integrated in a wooden table. The shape of the shell corresponds to the phantom defined by SCC34-SC2. It enables the dosimetric evaluation of left and right hand phone usage as well as body mounted usage at the flat phantom region. A cover prevents evaporation of the liquid. Reference markings on the phantom allow the complete setup of all predefined phantom positions and measurement grids by manually teaching three points in the robot.

Shell Thickness: 2 ± 0.1 mm
Filling Volume: Approx. 20 liters
Dimensions: 50 cm (W) x 100 cm (L)

SAM Twin-Phantom

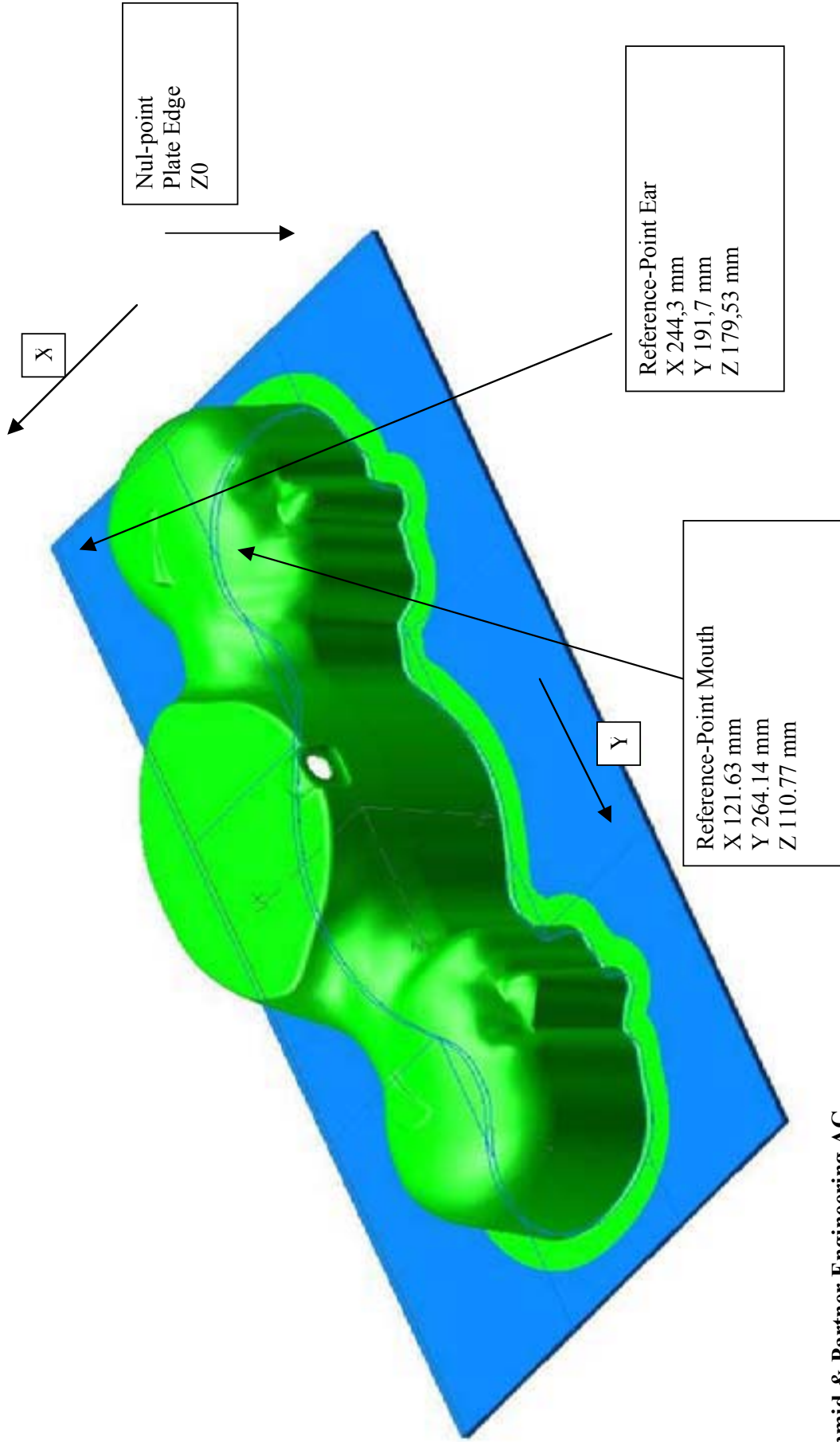

2450MHz Dipole Calibration



2450MHz Dipole Calibration



3. Measurement Conditions

The planar phantom was filled with brain simulating tissue having the following electrical parameters at 2450MHz:

Relative Permittivity:	39.2	± 5%
Conductivity:	1.80 mho/m	± 5%
Temperature:	23.1°C	

The 2450MHz simulating tissue consists of the following ingredients:

Ingredient	Percentage by weight
Water	55.20 %
Glycol Monobutyl	44.80 %
Target Dielectric Parameters at 22°C	$\epsilon_r = 39.2$ $\sigma = 1.80 \text{ S/m}$

4. SAR Measurement

The SAR measurement was performed with the E-field probe in mechanical detection mode only. The setup and determination of the forward power into the dipole was performed using the following procedures.

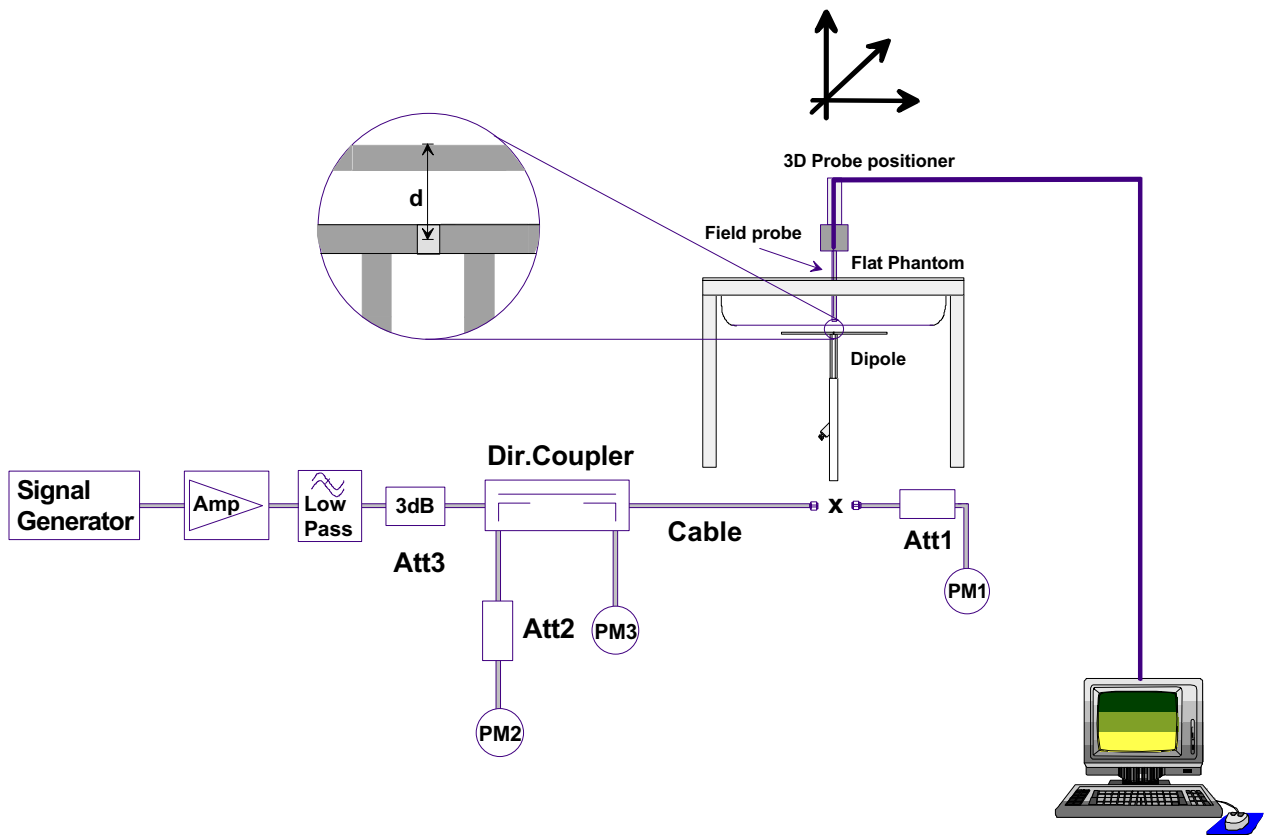

First, the power meter PM1 (including attenuator Att1) is connected to the cable to measure the forward power at the location of the dipole connector (X). The signal generator is adjusted for the desired forward power at the dipole connector (taking into account the attenuation of Att1) as read by power meter PM2. After connecting the cable to the dipole, the signal generator is readjusted for the same reading at power meter PM2. If the signal generator does not allow adjustment in 0.01dB steps, the remaining difference at PM2 must be taken into consideration. PM3 records the reflected power from the dipole to ensure that the value is not changed from the previous value. The reflected power should be 20dB below the forward power.

Ten SAR measurements were performed in order to achieve repeatability and to establish an average target value.

Validation Dipole SAR Test Results

Validation Measurement	SAR @ 0.25W Input averaged over 1g	SAR @ 1W Input averaged over 1g	SAR @ 0.25W Input averaged over 10g	SAR @ 1W Input averaged over 10g	Peak SAR @ 0.25W Input
Test 1	14.2	56.80	6.33	25.32	30.5
Test 2	14.3	57.20	6.34	25.36	30.8
Test 3	14.2	56.80	6.33	25.32	30.4
Test 4	14.1	56.40	6.32	25.28	30.1
Test 5	14.3	57.20	6.33	25.32	30.7
Test 6	14.0	56.00	6.31	25.24	30.0
Test 7	14.2	56.80	6.33	25.32	30.4
Test 8	14.2	56.80	6.33	25.32	30.5
Test 9	14.4	57.60	6.34	25.36	30.8
Test10	14.2	56.80	6.32	25.28	30.4
Average Value	14.21	56.84	6.32	25.31	30.46

The results have been normalized to 1W (forward power) into the dipole.

Averaged over 1cm (1g) of tissue: 56.84 mW/g

Averaged over 10cm (10g) of tissue: 25.31 mW/g

Dipole 2450MHz

SAM Phantom; Flat Section

Probe: ET3DV6 - SNI1590; ConvF(4.93,4.93,4.93); Crest factor: 1.0; 2450 MHz Brain: $\sigma = 1.80$ mho/m $\epsilon_r = 39.2$ $\rho = 1.00$ g/cm³

Cube 5x5x7: Peak: 30.5 mW/g, SAR (1g): 14.2 mW/g, SAR (10g): 6.33 mW/g, (Worst-case extrapolation)

Penetration depth: 6.2 (5.9, 7.0) [mm]; Ambient Temp: 21.5°C; Fluid Temp: 23.1°C

Powerdrift: 0.03 dB

Calibration Date: October 24, 2001

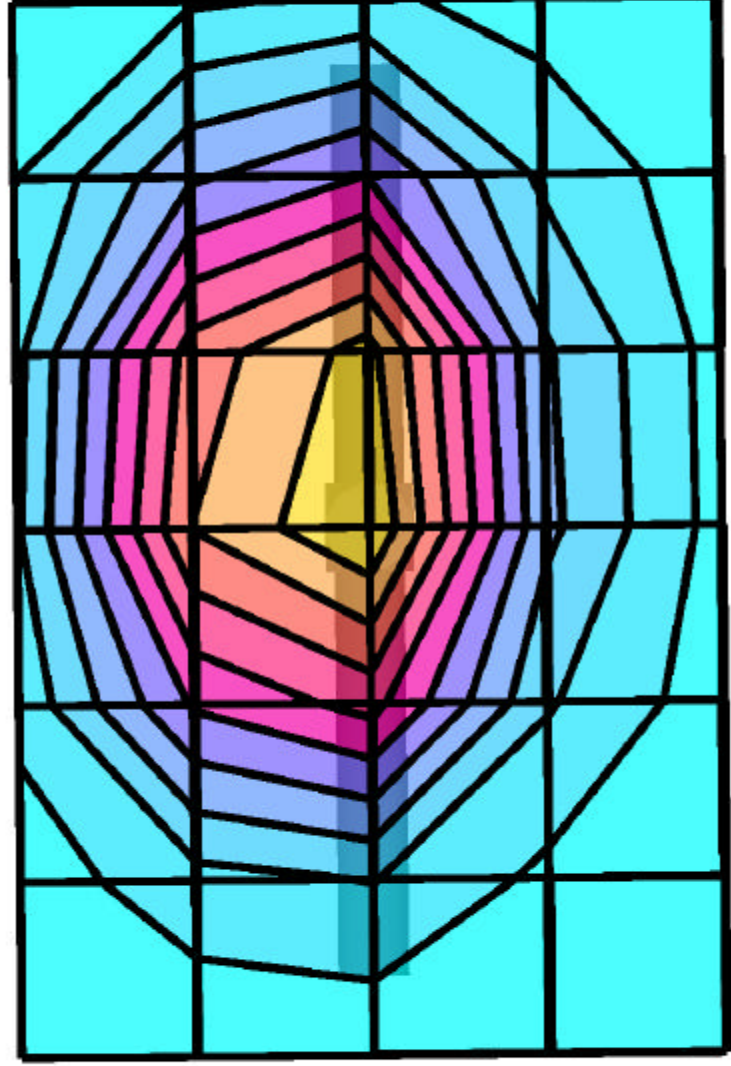

APPENDIX D - PROBE CALIBRATION

Schmid & Partner Engineering AG

Zeughausstrasse 43, 8004 Zurich, Switzerland, Phone +41 1 245 97 00, Fax +41 1 245 97 79

Calibration Certificate

Dosimetric E-Field Probe

Type:

ET3DV6

Serial Number:

1387

Place of Calibration:

Zurich

Date of Calibration:

February 22, 2002

Calibration Interval:

12 months

Schmid & Partner Engineering AG hereby certifies, that this device has been calibrated on the date indicated above. The calibration was performed in accordance with specifications and procedures of Schmid & Partner Engineering AG.

Wherever applicable, the standards used in the calibration process are traceable to international standards. In all other cases the standards of the Laboratory for EMF and Microwave Electronics at the Swiss Federal Institute of Technology (ETH) in Zurich, Switzerland have been applied.

Calibrated by:

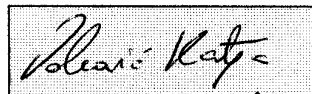

Approved by:



Probe ET3DV6

SN:1387

Manufactured:	September 21, 1999
Last calibration:	September 22, 1999
Recalibrated:	February 22, 2002

Calibrated for System DASY3

DASY3 - Parameters of Probe: ET3DV6 SN:1387

Sensitivity in Free Space

NormX	1.58 $\mu\text{V}/(\text{V}/\text{m})^2$
NormY	1.67 $\mu\text{V}/(\text{V}/\text{m})^2$
NormZ	1.67 $\mu\text{V}/(\text{V}/\text{m})^2$

Diode Compression

DCP X	97	mV
DCP Y	97	mV
DCP Z	97	mV

Sensitivity in Tissue Simulating Liquid

Head	900 MHz	$\epsilon_r = 41.5 \pm 5\%$	$\sigma = 0.97 \pm 5\%$ mho/m
Head	835 MHz	$\epsilon_r = 41.5 \pm 5\%$	$\sigma = 0.90 \pm 5\%$ mho/m
ConvF X	6.6 $\pm 9.5\%$ (k=2)		Boundary effect:
ConvF Y	6.6 $\pm 9.5\%$ (k=2)		Alpha 0.40
ConvF Z	6.6 $\pm 9.5\%$ (k=2)		Depth 2.38
Head	1800 MHz	$\epsilon_r = 40.0 \pm 5\%$	$\sigma = 1.40 \pm 5\%$ mho/m
Head	1900 MHz	$\epsilon_r = 40.0 \pm 5\%$	$\sigma = 1.40 \pm 5\%$ mho/m
ConvF X	5.4 $\pm 9.5\%$ (k=2)		Boundary effect:
ConvF Y	5.4 $\pm 9.5\%$ (k=2)		Alpha 0.57
ConvF Z	5.4 $\pm 9.5\%$ (k=2)		Depth 2.18

Boundary Effect

Head	900 MHz	Typical SAR gradient: 5 % per mm	
	Probe Tip to Boundary	1 mm	2 mm
	SAR _{be} [%] Without Correction Algorithm	9.7	5.4
	SAR _{be} [%] With Correction Algorithm	0.3	0.6
Head	1800 MHz	Typical SAR gradient: 10 % per mm	
	Probe Tip to Boundary	1 mm	2 mm
	SAR _{be} [%] Without Correction Algorithm	11.5	7.3
	SAR _{be} [%] With Correction Algorithm	0.1	0.3

Sensor Offset

Probe Tip to Sensor Center	2.7	mm
Optical Surface Detection	1.3 \pm 0.2	mm

Receiving Pattern (ϕ , $\theta = 0^\circ$)

f = 30 MHz, TEM cell ifi110

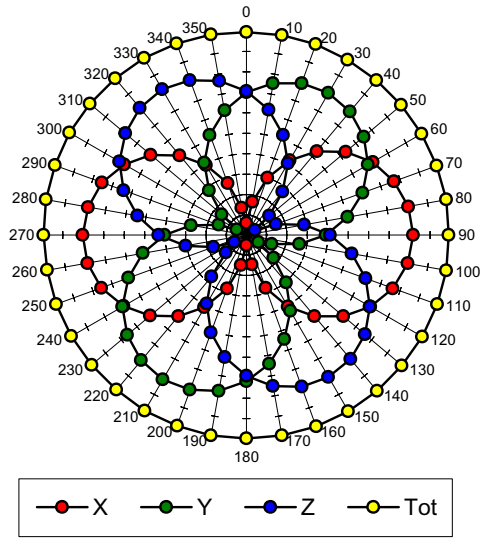

f = 100 MHz, TEM cell ifi110

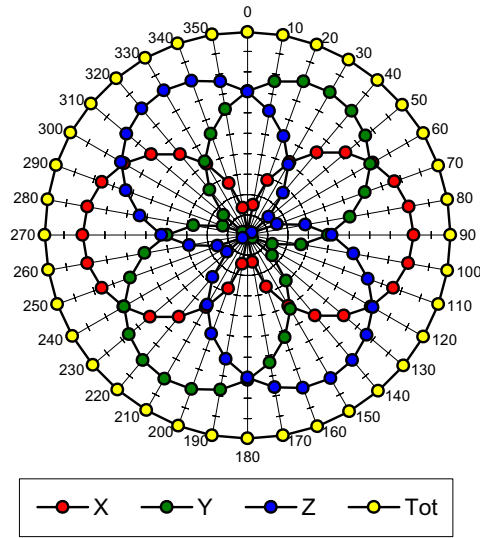

f = 300 MHz, TEM cell ifi110

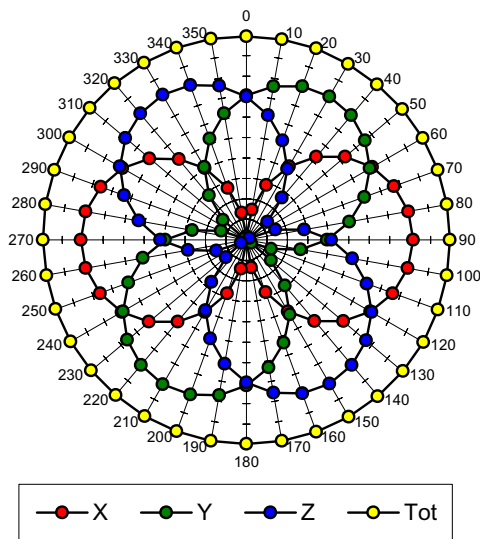

f = 900 MHz, TEM cell ifi110

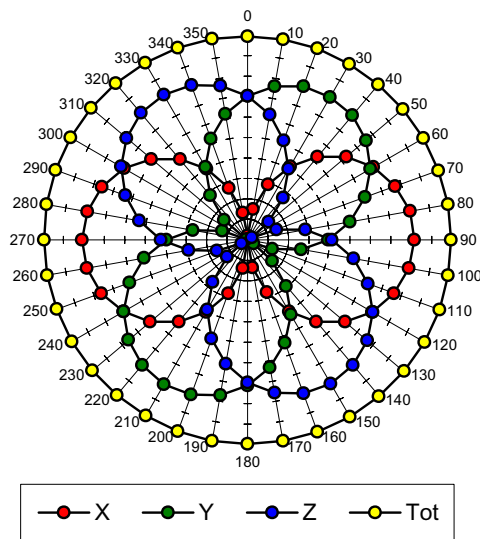

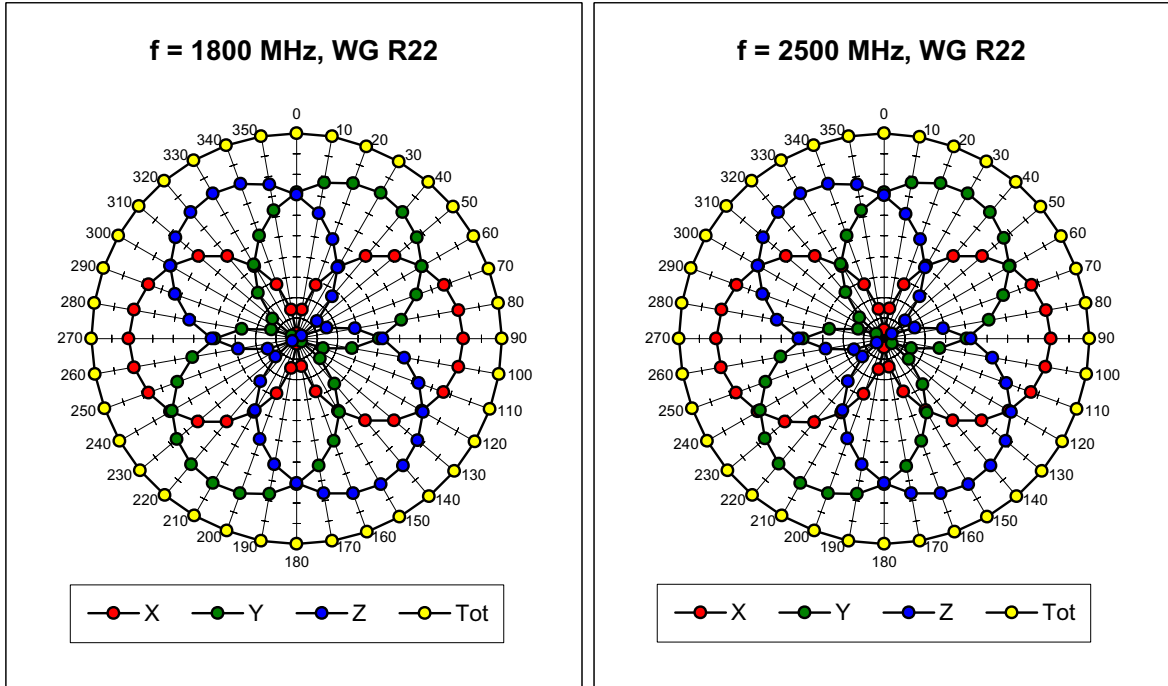

Isotropy Error (ϕ), $\theta = 0^\circ$

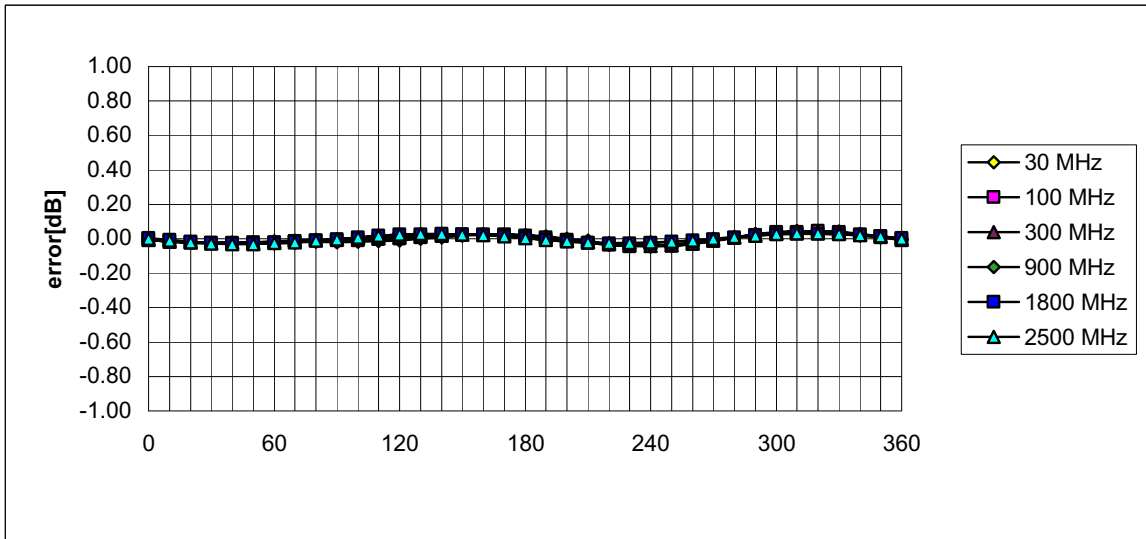

Frequency Response of E-Field

(TEM-Cell:ifi110, Waveguide R22)

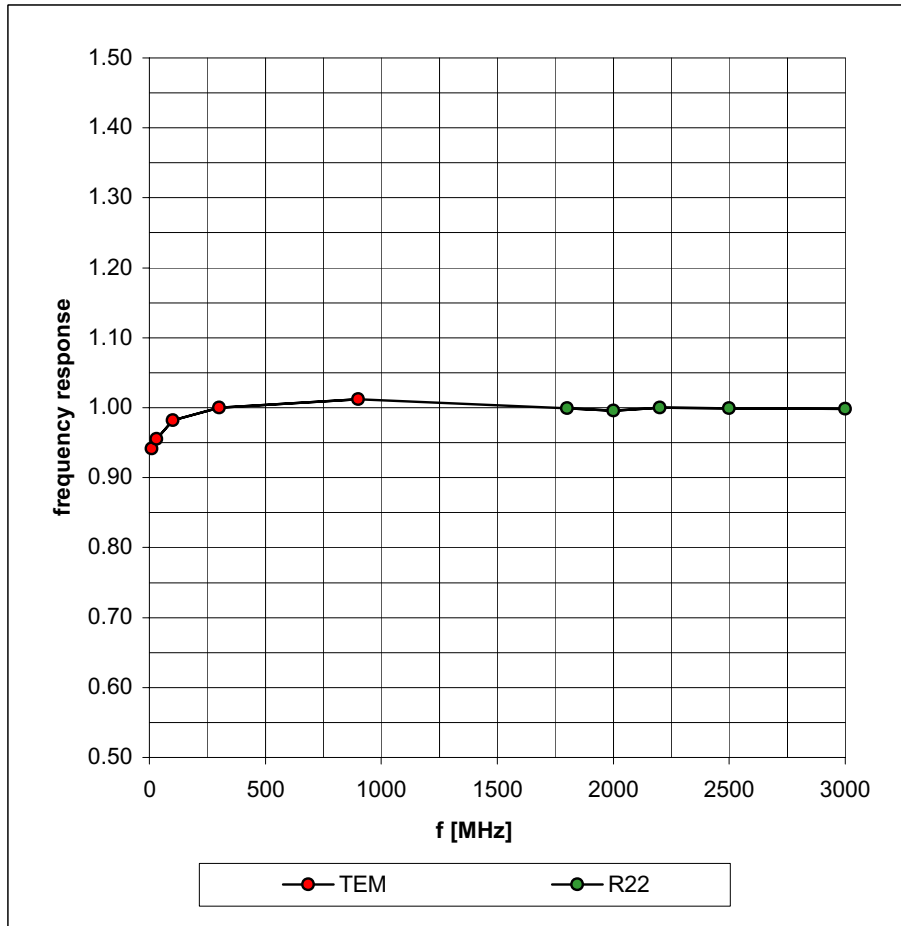

Dynamic Range f(SAR_{brain}) (Waveguide R22)

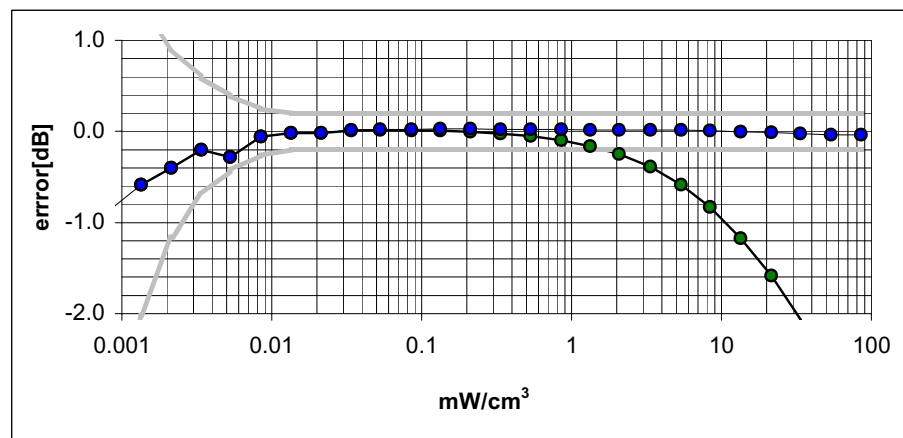
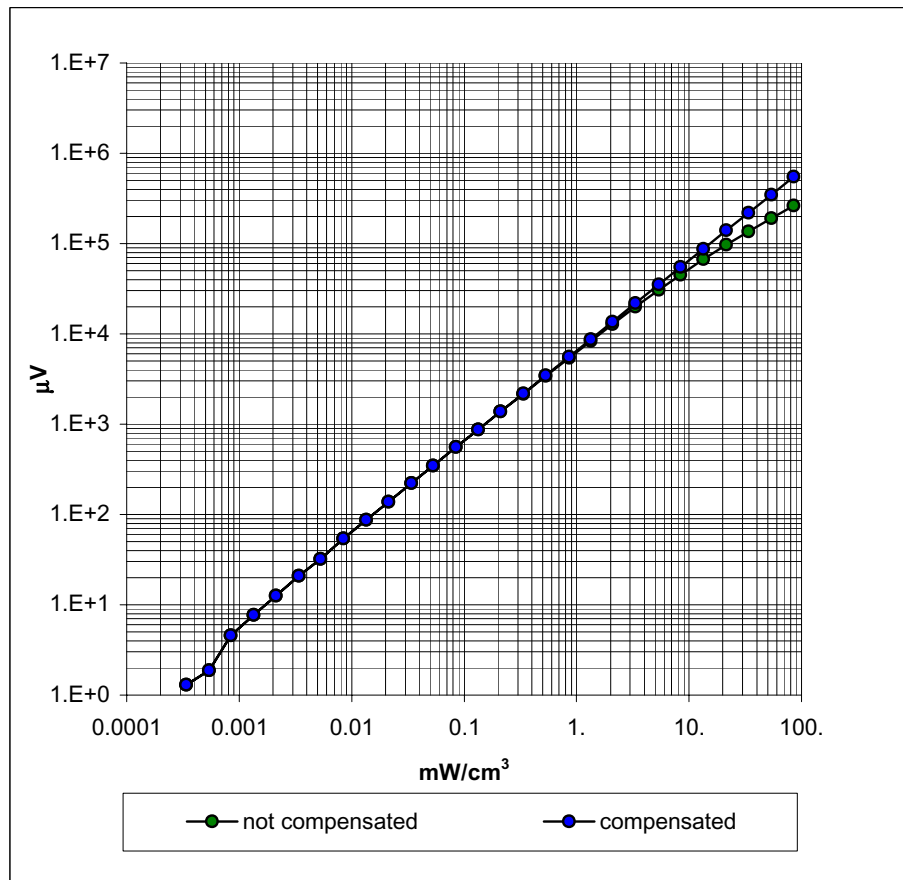

Conversion Factor Assessment

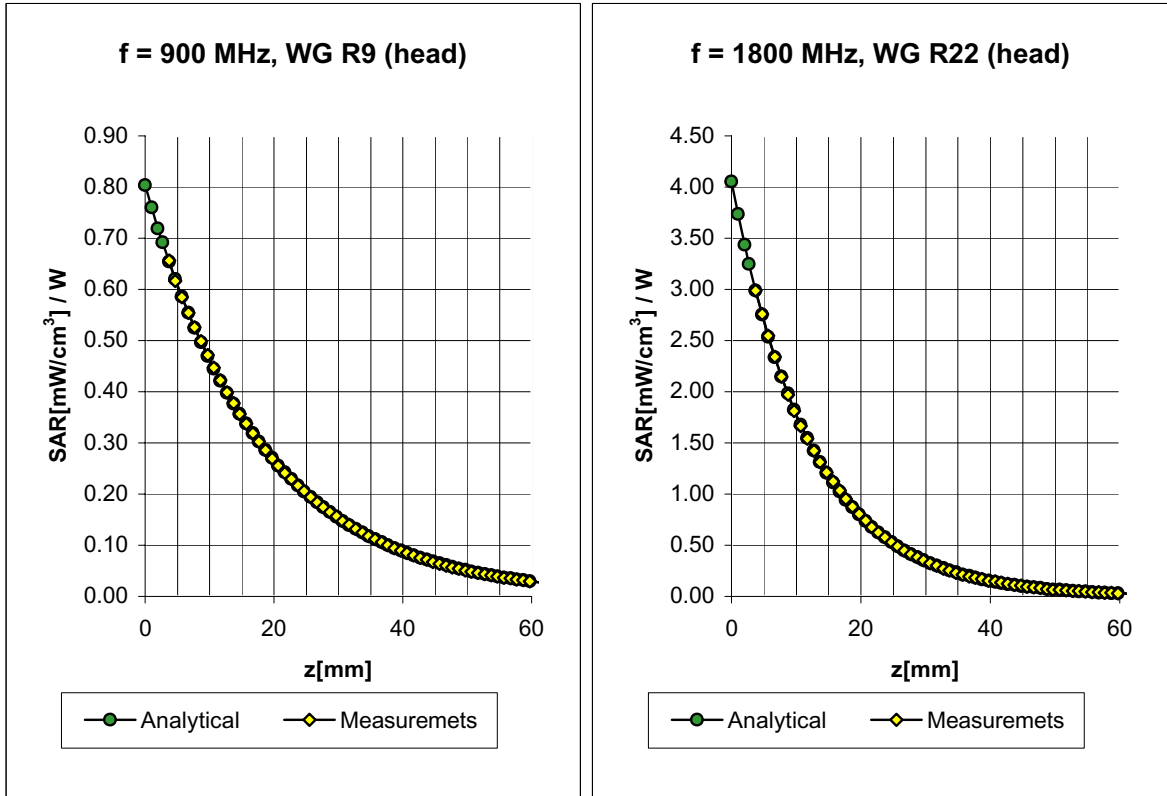

Head	900 MHz	$\epsilon_r = 41.5 \pm 5\%$	$\sigma = 0.97 \pm 5\% \text{ mho/m}$
Head	835 MHz	$\epsilon_r = 41.5 \pm 5\%$	$\sigma = 0.90 \pm 5\% \text{ mho/m}$
	ConvF X	6.6 $\pm 9.5\%$ (k=2)	Boundary effect:
	ConvF Y	6.6 $\pm 9.5\%$ (k=2)	Alpha 0.40
	ConvF Z	6.6 $\pm 9.5\%$ (k=2)	Depth 2.38
Head	1800 MHz	$\epsilon_r = 40.0 \pm 5\%$	$\sigma = 1.40 \pm 5\% \text{ mho/m}$
Head	1900 MHz	$\epsilon_r = 40.0 \pm 5\%$	$\sigma = 1.40 \pm 5\% \text{ mho/m}$
	ConvF X	5.4 $\pm 9.5\%$ (k=2)	Boundary effect:
	ConvF Y	5.4 $\pm 9.5\%$ (k=2)	Alpha 0.57
	ConvF Z	5.4 $\pm 9.5\%$ (k=2)	Depth 2.18

ET3DV6 SN:1387

February 22, 2002

Conversion Factor Assessment

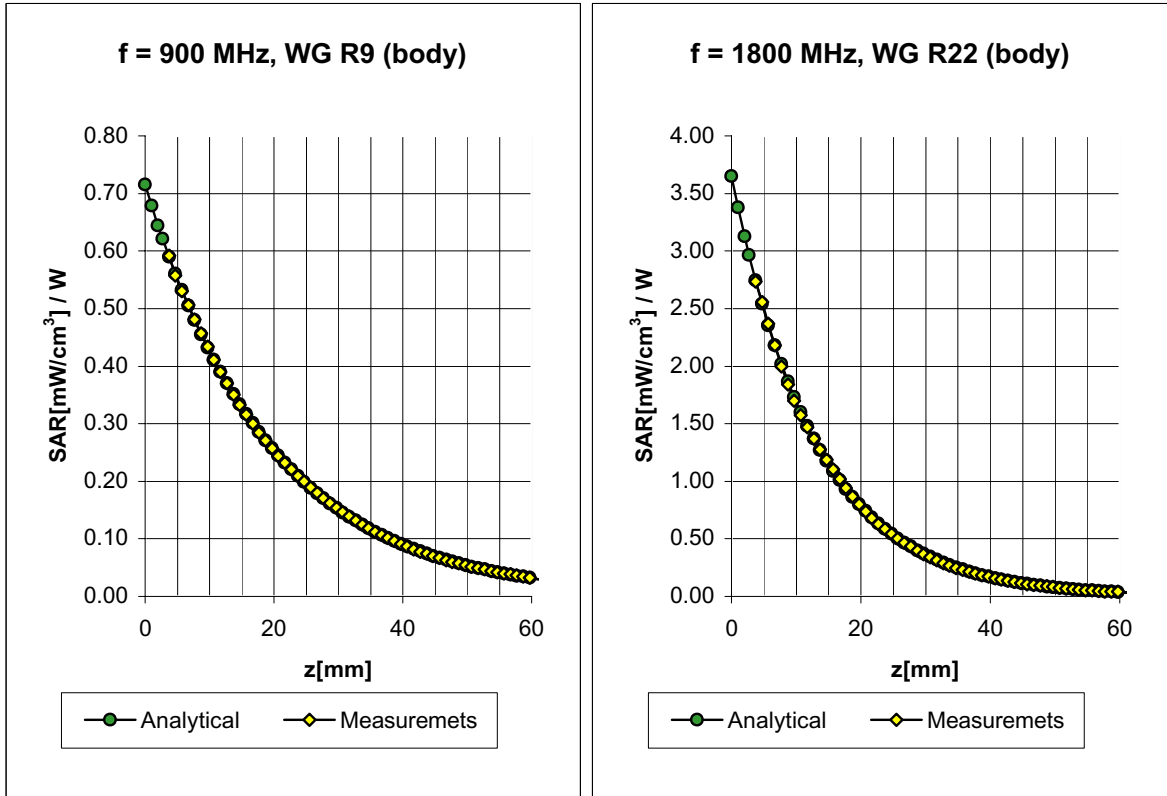

Body	900 MHz	$\epsilon_r = 55.0 \pm 5\%$	$\sigma = 1.05 \pm 5\% \text{ mho/m}$
Body	835 MHz	$\epsilon_r = 55.2 \pm 5\%$	$\sigma = 0.97 \pm 5\% \text{ mho/m}$
	ConvF X	6.3 $\pm 9.5\%$ (k=2)	Boundary effect:
	ConvF Y	6.3 $\pm 9.5\%$ (k=2)	Alpha 0.42
	ConvF Z	6.3 $\pm 9.5\%$ (k=2)	Depth 2.44
Body	1800 MHz	$\epsilon_r = 53.3 \pm 5\%$	$\sigma = 1.52 \pm 5\% \text{ mho/m}$
Body	1900 MHz	$\epsilon_r = 53.3 \pm 5\%$	$\sigma = 1.52 \pm 5\% \text{ mho/m}$
	ConvF X	5.0 $\pm 9.5\%$ (k=2)	Boundary effect:
	ConvF Y	5.0 $\pm 9.5\%$ (k=2)	Alpha 0.76
	ConvF Z	5.0 $\pm 9.5\%$ (k=2)	Depth 2.01

ET3DV6 SN:1387

February 22, 2002

Deviation from Isotropy in HSL

Error (θ, ϕ), $f = 900$ MHz

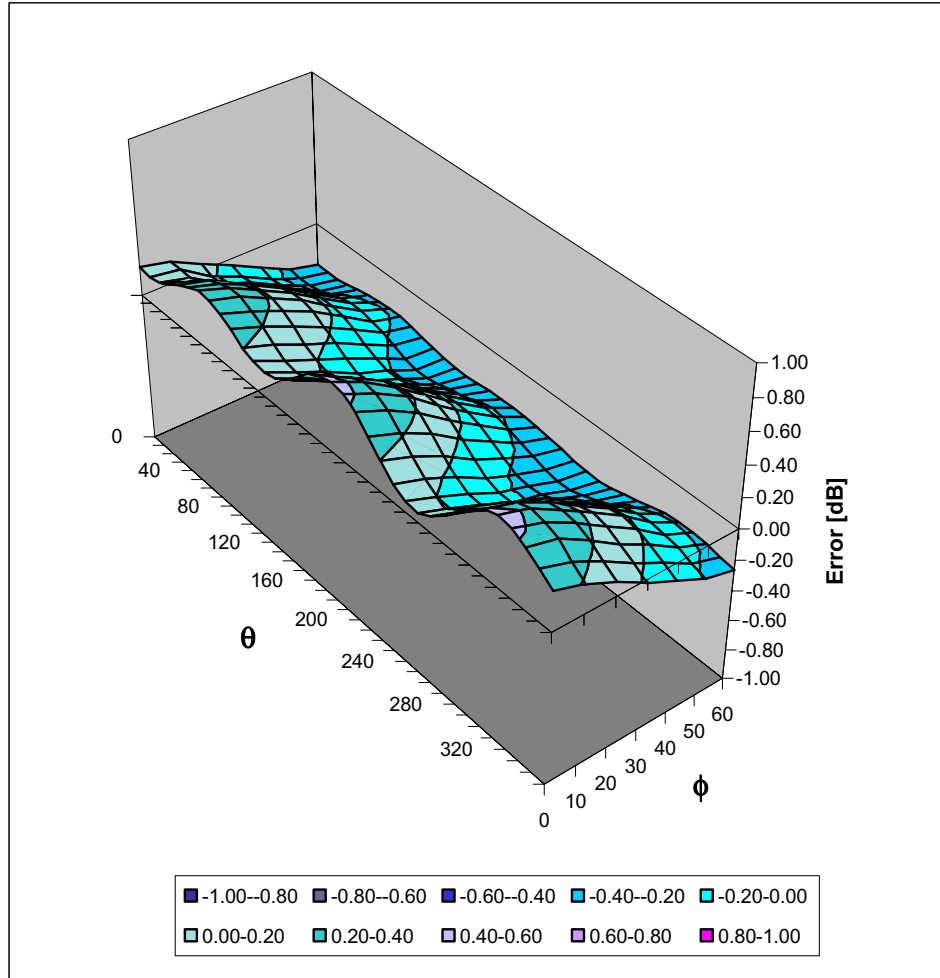

Additional Conversion Factors for Dosimetric E-Field Probe

Type:

ET3DV6

Serial Number:

1387

Place of Assessment:

Zurich

Date of Assessment:

February 25, 2002

Probe Calibration Date:

February 22, 2002

Schmid & Partner Engineering AG hereby certifies that conversion factor(s) of this probe have been evaluated on the date indicated above. The assessment was performed using the FDTD numerical code SEMCAD of Schmid & Partner Engineering AG. Since the evaluation is coupled with measured conversion factors, it has to be recalculated yearly, i.e., following the re-calibration schedule of the probe. The uncertainty of the numerical assessment is based on the extrapolation from measured value at 900 MHz or at 1800 MHz.

Assessed by:

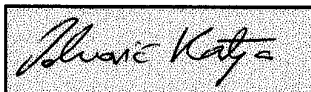

Dosimetric E-Field Probe ET3DV6 SN:1387

Conversion Factor (\pm standard deviation)

150 MHz	ConvF	$9.2 \pm 8\%$	$\epsilon_r = 52.3$ $\sigma = 0.76 \text{ mho/m}$ (head tissue)
300 MHz	ConvF	$8.0 \pm 8\%$	$\epsilon_r = 45.3$ $\sigma = 0.87 \text{ mho/m}$ (head tissue)
450 MHz	ConvF	$7.3 \pm 8\%$	$\epsilon_r = 43.5$ $\sigma = 0.87 \text{ mho/m}$ (head tissue)
2450 MHz	ConvF	$4.7 \pm 8\%$	$\epsilon_r = 39.2$ $\sigma = 1.80 \text{ mho/m}$ (head tissue)
150 MHz	ConvF	$8.8 \pm 8\%$	$\epsilon_r = 61.9$ $\sigma = 0.80 \text{ mho/m}$ (body tissue)
450 MHz	ConvF	$7.7 \pm 8\%$	$\epsilon_r = 56.7$ $\sigma = 0.94 \text{ mho/m}$ (body tissue)
2450 MHz	ConvF	$4.3 \pm 8\%$	$\epsilon_r = 52.7$ $\sigma = 1.95 \text{ mho/m}$ (body tissue)

APPENDIX E - MEASURED FLUID DIELECTRIC PARAMETERS

2450MHz System Validation

Measured Fluid Dielectric Parameters (Brain)

October 18, 2002

Frequency	ϵ'	ϵ''
2.300000000 GHz	38.0485	13.4006
2.310000000 GHz	37.9766	13.4246
2.320000000 GHz	37.9217	13.4443
2.330000000 GHz	37.8623	13.5035
2.340000000 GHz	37.8444	13.5722
2.350000000 GHz	37.8298	13.6330
2.360000000 GHz	37.8318	13.6891
2.370000000 GHz	37.8051	13.7456
2.380000000 GHz	37.7777	13.7508
2.390000000 GHz	37.7396	13.7344
2.400000000 GHz	37.6920	13.7122
2.410000000 GHz	37.6252	13.7167
2.420000000 GHz	37.5547	13.7326
2.430000000 GHz	37.4754	13.7670
2.440000000 GHz	37.4383	13.8226
2.450000000 GHz	37.3761	13.8794
2.460000000 GHz	37.3346	13.9742
2.470000000 GHz	37.3104	14.0283
2.480000000 GHz	37.2784	14.0780
2.490000000 GHz	37.2621	14.0690
2.500000000 GHz	37.2348	14.0422

2450MHz EUT Evaluation (Body)

Measured Fluid Dielectric Parameters

October 18, 2002

Frequency	e'	e''
2.350000000 GHz	48.7617	14.6225
2.360000000 GHz	48.7210	14.6558
2.370000000 GHz	48.6801	14.7067
2.380000000 GHz	48.6431	14.7472
2.390000000 GHz	48.5924	14.7894
2.400000000 GHz	48.5310	14.8234
2.410000000 GHz	48.4830	14.8404
2.420000000 GHz	48.4293	14.8946
2.430000000 GHz	48.4064	14.9262
2.440000000 GHz	48.3385	14.9835
2.450000000 GHz	48.3063	15.0195
2.460000000 GHz	48.2443	15.0549
2.470000000 GHz	48.2251	15.0880
2.480000000 GHz	48.1908	15.1247
2.490000000 GHz	48.1297	15.1543
2.500000000 GHz	48.0895	15.1682
2.510000000 GHz	48.0119	15.1839
2.520000000 GHz	47.9767	15.2274
2.530000000 GHz	47.9089	15.2709
2.540000000 GHz	47.8670	15.3061
2.550000000 GHz	47.8222	15.3318

APPENDIX F - SAM PHANTOM CERTIFICATE OF CONFORMITY

Schmid & Partner Engineering AG

Zeughausstrasse 43, 8004 Zurich, Switzerland, Phone +41 1 245 97 00, Fax +41 1 245 97 79

Certificate of conformity / First Article Inspection

Item	SAM Twin Phantom V4.0
Type No	QD 000 P40 BA
Series No	TP-1002 and higher
Manufacturer / Origin	Untersee Composites Hauptstr. 69 CH-8559 Fruthwilen Switzerland

Tests

The series production process used allows the limitation to test of first articles. Complete tests were made on the pre-series Type No. QD 000 P40 AA, Serial No. TP-1001 and on the series first article Type No. QD 000 P40 BA, Serial No. TP-1006. Certain parameters have been retested using further series units (called samples).

Test	Requirement	Details	Units tested
Shape	Compliance with the geometry according to the CAD model.	IT'IS CAD File (*)	First article, Samples
Material thickness	Compliant with the requirements according to the standards	2mm +/- 0.2mm in specific areas	First article, Samples
Material parameters	Dielectric parameters for required frequencies	200 MHz – 3 GHz Relative permittivity < 5 Loss tangent < 0.05.	Material sample TP 104-5
Material resistivity	The material has been tested to be compatible with the liquids defined in the standards	Liquid type HSL 1800 and others according to the standard.	Pre-series, First article

Standards

- [1] CENELEC EN 50361
- [2] IEEE P1528-200x draft 6.5
- [3] IEC PT 62209 draft 0.9

(*) The IT'IS CAD file is derived from [2] and is also within the tolerance requirements of the shapes of [1] and [3].

Conformity

Based on the sample tests above, we certify that this item is in compliance with the uncertainty requirements of SAR measurements specified in standard [1] and draft standards [2] and [3].

Date

18.11.2001

Signature / Stamp



**Schmid & Partner
Engineering AG**



Zeughausstrasse 43, CH-8004 Zurich
Tel. +41 1 245 97 00, Fax +41 1 245 97 79

APPENDIX G - SAR TEST SETUP & EUT PHOTOGRAPHS

BODY SAR TEST SETUP PHOTOGRAPHS
Back Side of EUT - 0.0cm Separation Distance

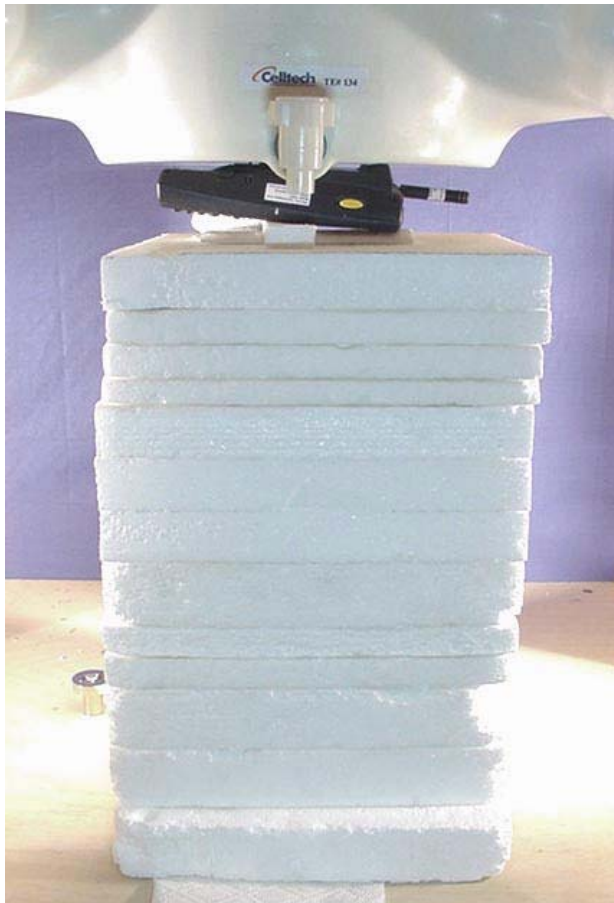

BODY SAR TEST SETUP PHOTOGRAPHS
Right Side of EUT (Antenna Side)
0.0cm Separation Distance



EUT PHOTOGRAPHS



Front Side of EUT



Back Side of EUT



Battery Enclosure



Left Side of EUT



Right Side of EUT



External Stubby Antenna



7.2V Lithium-ion Battery