

Exhibit O: CDMA SAR Report - Part 1 of 3

FCC ID: HN22011B-2

DECLARATION OF COMPLIANCE SAR EVALUATION

<p><u>Test Lab</u></p> <p>CELLTECH LABS INC. Testing and Engineering Lab 1955 Moss Court Kelowna, B.C. Canada V1Y 9L3 Phone: 250-448-7047 Fax: 250-448-7046 e-mail: info@celltechlabs.com web site: www.celltechlabs.com</p>	<p><u>Applicant Information</u></p> <p>INTERMEC TECHNOLOGIES CORPORATION 6001 36th Avenue West Everett, WA 98203</p>																								
<table style="width: 100%; border-collapse: collapse;"> <tr> <td style="width: 30%;">Rule Part(s):</td> <td>FCC 47 CFR §2.1093; IC RSS-102 Issue 1 (Provisional)</td> </tr> <tr> <td>Test Procedure(s):</td> <td>FCC OET Bulletin 65, Supplement C (Edition 01-01)</td> </tr> <tr> <td>FCC ID:</td> <td>HN2SB555</td> </tr> <tr> <td>Model(s):</td> <td>700C</td> </tr> <tr> <td>Equipment Type:</td> <td>Handheld Voice/Data Terminal with Dual-Band CDMA Modem, DSSS Wireless LAN Card, & Bluetooth Module (802.11a)</td> </tr> <tr> <td>Device Classification(s):</td> <td>FCC Part 15 Digital Transmission System (DTS) FCC Part 24 Licensed Portable Transmitter Held to Ear (PCE)</td> </tr> <tr> <td>Modulation(s):</td> <td>Direct Sequence Spread Spectrum (DSSS), PCS CDMA, Cellular CDMA</td> </tr> <tr> <td>Tx Frequency Range(s):</td> <td>2412 - 2462 MHz (DSSS) 1851.25 - 1908.75 MHz (PCS CDMA) 824.70 - 848.31 MHz (Cellular CDMA)</td> </tr> <tr> <td>Conducted Power Tested:</td> <td>17.0 dBm (DSSS) 23.5 dBm (PCS CDMA) 23.5 dBm (Cellular CDMA)</td> </tr> <tr> <td>Antenna Type(s):</td> <td>Internal Patch (DSSS) External Stubby (Single-Band PCS CDMA P/N: 805-606-004) External Stubby (Dual-Band CDMA P/N: 805-606-002)</td> </tr> <tr> <td>Battery Type(s):</td> <td>7.2V Lithium-Ion (P/N: 318-013-001)</td> </tr> <tr> <td>Max. SAR Measured:</td> <td>1.47 W/kg (Head) / 1.00 W/kg (Body)</td> </tr> </table>		Rule Part(s):	FCC 47 CFR §2.1093; IC RSS-102 Issue 1 (Provisional)	Test Procedure(s):	FCC OET Bulletin 65, Supplement C (Edition 01-01)	FCC ID:	HN2SB555	Model(s):	700C	Equipment Type:	Handheld Voice/Data Terminal with Dual-Band CDMA Modem, DSSS Wireless LAN Card, & Bluetooth Module (802.11a)	Device Classification(s):	FCC Part 15 Digital Transmission System (DTS) FCC Part 24 Licensed Portable Transmitter Held to Ear (PCE)	Modulation(s):	Direct Sequence Spread Spectrum (DSSS), PCS CDMA, Cellular CDMA	Tx Frequency Range(s):	2412 - 2462 MHz (DSSS) 1851.25 - 1908.75 MHz (PCS CDMA) 824.70 - 848.31 MHz (Cellular CDMA)	Conducted Power Tested:	17.0 dBm (DSSS) 23.5 dBm (PCS CDMA) 23.5 dBm (Cellular CDMA)	Antenna Type(s):	Internal Patch (DSSS) External Stubby (Single-Band PCS CDMA P/N: 805-606-004) External Stubby (Dual-Band CDMA P/N: 805-606-002)	Battery Type(s):	7.2V Lithium-Ion (P/N: 318-013-001)	Max. SAR Measured:	1.47 W/kg (Head) / 1.00 W/kg (Body)
Rule Part(s):	FCC 47 CFR §2.1093; IC RSS-102 Issue 1 (Provisional)																								
Test Procedure(s):	FCC OET Bulletin 65, Supplement C (Edition 01-01)																								
FCC ID:	HN2SB555																								
Model(s):	700C																								
Equipment Type:	Handheld Voice/Data Terminal with Dual-Band CDMA Modem, DSSS Wireless LAN Card, & Bluetooth Module (802.11a)																								
Device Classification(s):	FCC Part 15 Digital Transmission System (DTS) FCC Part 24 Licensed Portable Transmitter Held to Ear (PCE)																								
Modulation(s):	Direct Sequence Spread Spectrum (DSSS), PCS CDMA, Cellular CDMA																								
Tx Frequency Range(s):	2412 - 2462 MHz (DSSS) 1851.25 - 1908.75 MHz (PCS CDMA) 824.70 - 848.31 MHz (Cellular CDMA)																								
Conducted Power Tested:	17.0 dBm (DSSS) 23.5 dBm (PCS CDMA) 23.5 dBm (Cellular CDMA)																								
Antenna Type(s):	Internal Patch (DSSS) External Stubby (Single-Band PCS CDMA P/N: 805-606-004) External Stubby (Dual-Band CDMA P/N: 805-606-002)																								
Battery Type(s):	7.2V Lithium-Ion (P/N: 318-013-001)																								
Max. SAR Measured:	1.47 W/kg (Head) / 1.00 W/kg (Body)																								

Celltech Labs Inc. declares under its sole responsibility that this device was found to be in compliance with the Specific Absorption Rate (SAR) RF exposure requirements specified in FCC 47 CFR §2.1093 and Health Canada's Safety Code 6. The device was tested in accordance with the measurement standards and procedures specified in FCC OET Bulletin 65, Supplement C, Edition 01-01 and Industry Canada RSS-102 Issue 1 (Provisional) for the General Population / Uncontrolled Exposure environment.

I attest to the accuracy of data. All measurements were performed by me or were made under my supervision and are correct to the best of my knowledge and belief. I assume full responsibility for the completeness of these measurements and vouch for the qualifications of all persons taking them.

This test report shall not be reproduced partially, or in full, without the prior written approval of Celltech Labs Inc. The results and statements contained in this report pertain only to the device(s) evaluated.



Russell W. Pipe
 Senior Compliance Technologist
 Celltech Labs Inc.



TABLE OF CONTENTS		
1.0	INTRODUCTION.....	3
2.0	DESCRIPTION OF EUT.....	3
3.0	SAR MEASUREMENT SYSTEM	4
4.0	MEASUREMENT SUMMARY.....	5-7
5.0	DETAILS OF SAR EVALUATION.....	8-10
6.0	EVALUATION PROCEDURES.....	11
7.0	SAR LIMITS.....	11
8.0	EVALUATION FLOW CHART.....	12
9.0	SYSTEM PERFORMANCE CHECK.....	13
10.0	EQUIVALENT TISSUES.....	14
11.0	SYSTEM SPECIFICATIONS.....	15
12.0	SAM PHANTOM.....	16
13.0	DEVICE HOLDER.....	16
14.0	PROBE SPECIFICATION.....	16
15.0	TEST EQUIPMENT LIST.....	17
16.0	MEASUREMENT UNCERTAINTIES.....	18
17.0	REFERENCES.....	19
	APPENDIX A - SAR MEASUREMENT DATA.....	20
	APPENDIX B - SYSTEM CHECK DATA.....	21
	APPENDIX C - SYSTEM VALIDATION.....	22
	APPENDIX D - PROBE CALIBRATION.....	23
	APPENDIX E - MEASURED FLUID DIELECTRIC PARAMETERS.....	24
	APPENDIX F - SAM PHANTOM CERTIFICATE OF CONFORMITY.....	25
	APPENDIX G - SAR TEST SETUP & EUT PHOTOGRAPHS.....	26

1.0 INTRODUCTION

This measurement report demonstrates that the Intermec Technologies Corporation Model: 700C Handheld Voice/Data Terminal with Dual-Band CDMA Modem & DSSS WLAN Card FCC ID: HN2SB555 complies with the RF exposure requirements specified in FCC 47 CFR §2.1093 (see reference [1]), and Health Canada's Safety Code 6 (see reference [2]) for the General Population / Uncontrolled Exposure environment. The test procedures described in FCC OET Bulletin 65, Supplement C, Edition 01-01 (see reference [3]) and IC RSS-102 Issue 1 (Provisional) (see reference [4]), were employed. A description of the product, operating configuration, detailed summary of the test results, methodology and procedures used in the evaluation, equipment used, and the various provisions of the rules are included within this test report.

2.0 DESCRIPTION of Equipment Under Test (EUT)

Rule Part(s)	FCC 47 CFR §2.1093 IC RSS-102 Issue 1 (Provisional)
Test Procedure(s)	FCC OET Bulletin 65 Supplement C (Edition 01-01)
FCC Equipment Class	Part 15 Digital Transmission System (DTS) Part 24 Licensed Portable Transmitter Held to Ear (PCE)
Equipment Type	Handheld Voice/Data Terminal with integrated Dual-Band PCS/Cellular CDMA Modem & DSSS WLAN Card
FCC ID	HN2SB555
Model No.(s)	700C
Tx Frequency Range(s)	2412 - 2462 MHz (DSSS) 1851.25 - 1908.75 MHz (PCS CDMA) 824.70 - 848.31 MHz (Cellular CDMA)
Measured RF Conducted Power	17.0 dBm (DSSS) 23.5 dBm (PCS CDMA) 23.5 dBm (Cellular CDMA)
Battery Type(s) Tested	7.2V Lithium-Ion
Antenna Type(s) Tested	Internal Patch (DSSS) External Stubby (Dual-Band CDMA P/N: 805-606-002) External Stubby (Single-Band PCS CDMA P/N: 805-006-004)
Antenna Length(s)	Dual-Band CDMA - 57mm Single-Band PCS CDMA - 28mm

3.0 SAR MEASUREMENT SYSTEM

Celltech Labs SAR measurement facility utilizes the Dosimetric Assessment System (DASY™) manufactured by Schmid & Partner Engineering AG (SPEAG™) of Zurich, Switzerland. The DASY system is comprised of the robot controller, computer, near-field probe, probe alignment sensor, specific anthropomorphic mannequin (SAM) phantom, and various planar phantoms for brain and/or body SAR evaluations. The robot is a six-axis industrial robot performing precise movements to position the probe to the location (points) of maximum electromagnetic field (EMF). A cell controller system contains the power supply, robot controller, teach pendant (Joystick), and remote control, is used to drive the robot motors. The Staubli robot is connected to the cell controller to allow software manipulation of the robot. A data acquisition electronic (DAE) circuit performs the signal amplification, signal multiplexing, AD-conversion, offset measurements, mechanical surface detection, collision detection, etc. is connected to the Electro-optical coupler (EOC). The EOC performs the conversion from the optical into digital electric signal of the DAE and transfers data to the PC plug-in card. The DAE3 utilizes a highly sensitive electrometer-grade preamplifier with auto-zeroing, a channel and gain-switching multiplexer, a fast 16-bit AD-converter and a command decoder and control logic unit. Transmission to the PC-card is accomplished through an optical downlink for data and status information and an optical uplink for commands and clock lines. The mechanical probe-mounting device includes two different sensor systems for frontal and sidewise probe contacts. They are also used for mechanical surface detection and probe collision detection. The robot uses its own controller with a built in VME-bus computer.



DASY3 SAR Measurement System with SAM phantom

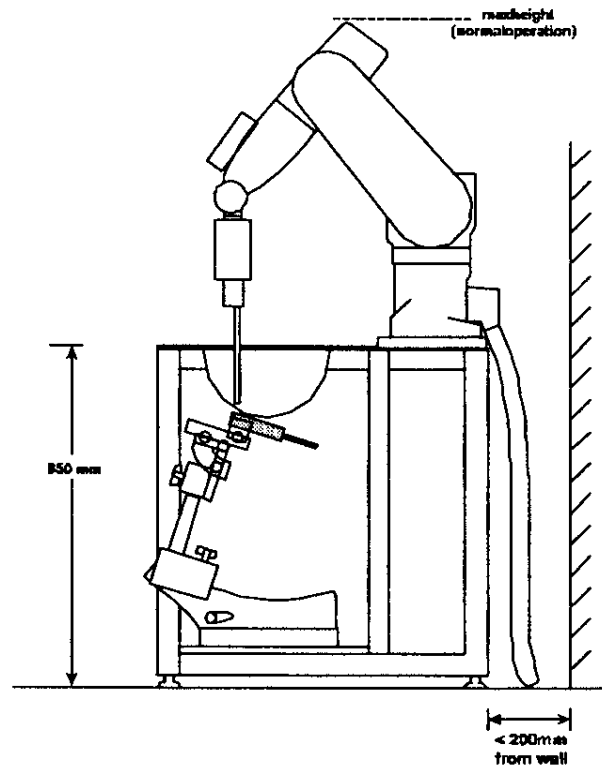

Figure 1. DASY3 Compact Version - Side View

4.0 MEASUREMENT DATA

The measurement results were obtained with the EUT tested in the conditions described in this report. Detailed measurement data and plots showing the maximum SAR location of the EUT are reported in Appendix A.

HEAD SAR MEASUREMENT RESULTS - DUAL-BAND CDMA MODEM									
Freq. (MHz)	Channel	Test Mode	Battery Type	Conducted Power (dBm)		Antenna Type	Phantom Section	Test Position	Measured SAR 1g (W/kg)
				Before	After				
1880.00	600	PCS CDMA	Lithium-Ion	23.5	23.5	Single-Band PCS	Left Ear	Cheek/Touch	0.685
1880.00	600	PCS CDMA	Lithium-Ion	23.5	23.4	Single-Band PCS	Left Ear	Ear/Tilt (15°)	0.672
1880.00	600	PCS CDMA	Lithium-Ion	23.5	23.5	Single-Band PCS	Right Ear	Cheek/Touch	0.738
1880.00	600	PCS CDMA	Lithium-Ion	23.5	23.5	Single-Band PCS	Right Ear	Ear/Tilt (15°)	0.962
1851.25	25	PCS CDMA	Lithium-Ion	23.5	23.5	Single-Band PCS	Right Ear	Ear/Tilt (15°)	1.07
1908.75	1175	PCS CDMA	Lithium-Ion	23.5	23.3	Single-Band PCS	Right Ear	Ear/Tilt (15°)	0.651
1851.25	25	PCS CDMA	Lithium-Ion	23.5	23.5	Single-Band PCS	Right Ear	Ear/Tilt (15°)	0.996*
1880.00	600	PCS CDMA	Lithium-Ion	23.5	23.3	Dual-Band	Left Ear	Cheek/Touch	0.321
1880.00	600	PCS CDMA	Lithium-Ion	23.5	23.3	Dual-Band	Left Ear	Ear/Tilt (15°)	0.560
1880.00	600	PCS CDMA	Lithium-Ion	23.5	23.4	Dual-Band	Right Ear	Cheek/Touch	0.537
1880.00	600	PCS CDMA	Lithium-Ion	23.5	23.4	Dual-Band	Right Ear	Ear/Tilt (15°)	1.28
1851.25	25	PCS CDMA	Lithium-Ion	23.5	23.4	Dual-Band	Right Ear	Ear/Tilt (15°)	1.17
1908.75	1175	PCS CDMA	Lithium-Ion	23.5	23.5	Dual-Band	Right Ear	Ear/Tilt (15°)	1.47
1908.75	1175	PCS CDMA	Lithium-Ion	23.5	23.3	Dual-Band	Right Ear	Ear/Tilt (15°)	1.22*
835.89	363	Cellular CDMA	Lithium-Ion	23.5	23.3	Dual-Band	Left Ear	Cheek/Touch	0.0291
835.89	363	Cellular CDMA	Lithium-Ion	23.5	23.3	Dual-Band	Left Ear	Ear/Tilt (15°)	0.0555
835.89	363	Cellular CDMA	Lithium-Ion	23.5	23.3	Dual-Band	Right Ear	Cheek/Touch	0.128
835.89	363	Cellular CDMA	Lithium-Ion	23.5	23.3	Dual-Band	Right Ear	Ear/Tilt (15°)	0.0921
835.89	363	Cellular CDMA	Lithium-Ion	23.5	23.5	Dual-Band	Right Ear	Cheek/Touch	0.109*
ANSI / IEEE C95.1 1992 - SAFETY LIMIT BRAIN: 1.6 W/kg (averaged over 1 gram) Spatial Peak - Uncontrolled Exposure / General Population									
Test Date(s)	PCS CDMA		Cellular CDMA		Measured Mixture Type	1900MHz Brain	835MHz Brain		
	02/05/03		02/05/03					Fluid Temperature	22.7 °C
Measured Mixture Type	1900MHz Brain		835MHz Brain		Ambient Temperature	23.3 °C	23.3 °C		
Dielectric Constant ϵ_r	IEEE Target	Measured	IEEE Target	Measured	Atmospheric Pressure	102.9 kPa	102.9 kPa		
	40.0 ±5%	38.2	41.5 ±5%	42.7	Relative Humidity	37 %	37 %		
Conductivity σ (mho/m)	IEEE Target	Measured	IEEE Target	Measured	Fluid Depth	≥ 15 cm	≥ 15 cm		
	1.40 ±5%	1.40	0.90 ±5%	0.93	ρ (Kg/m ³)	1000	1000		

* Co-located SAR measurement data (Dual-Band CDMA Modem and DSSS WLAN Card transmitting simultaneously).

Note(s):

1. If the SAR measurements performed at the middle channel were ≥ 3 dB below the SAR limit; SAR evaluation for the low and high channels was optional (per FCC OET Bulletin 65, Supplement C, Edition 01-01 (see reference [3])).
2. The ambient and fluid temperatures were measured prior to, and during, the fluid dielectric parameter check and the SAR evaluation. The temperatures listed were consistent for all measurement periods.
3. The dielectric properties of the simulated brain fluid were verified prior to the evaluation using an 85070C Dielectric Probe Kit and an 8753E Network Analyzer (see Appendix E for printout of measured fluid dielectric parameters).

MEASUREMENT DATA (Cont.)

BODY SAR MEASUREMENT RESULTS - DUAL-BAND CDMA MODEM

Freq. (MHz)	Channel	Test Mode	Battery Type	Conducted Power (dBm)		Antenna Type	Phantom Section	EUT Test Position	Separation Distance to Planar Phantom	Measured SAR 1g (W/kg)
				Before	After					
1880.00	600	PCS CDMA	Lithium-Ion	23.5	23.4	Single-Band PCS	Planar	Back Side	0.0 cm	0.407
1880.00	600	PCS CDMA	Lithium-ion	23.5	23.5	Single-Band PCS	Planar	Right Side	0.0 cm	0.836
1851.25	25	PCS CDMA	Lithium-ion	23.5	23.5	Single-Band PCS	Planar	Right Side	0.0 cm	1.00
1908.75	1175	PCS CDMA	Lithium-ion	23.5	23.4	Single-Band PCS	Planar	Right Side	0.0 cm	0.553
1880.00	600	PCS CDMA	Lithium-ion	23.5	23.5	Single-Band PCS	Planar	Top End	1.5 cm	0.159
1851.25	25	PCS CDMA	Lithium-ion	23.5	23.4	Single-Band PCS	Planar	Right Side	0.0 cm	0.971*
1880.00	600	PCS CDMA	Lithium-ion	23.5	23.4	Dual-Band	Planar	Back Side	0.0 cm	0.422
1880.00	600	PCS CDMA	Lithium-ion	23.5	23.5	Dual-Band	Planar	Right Side	0.0 cm	0.458
1880.00	600	PCS CDMA	Lithium-ion	23.5	23.5	Dual-Band	Planar	Top End	1.5 cm	0.0573
1880.00	600	PCS CDMA	Lithium-ion	23.5	23.4	Dual-Band	Planar	Right Side	0.0 cm	0.429*
835.89	363	Cellular CDMA	Lithium-ion	23.5	23.4	Dual-Band	Planar	Back Side	0.0 cm	0.308
835.89	363	Cellular CDMA	Lithium-ion	23.5	23.4	Dual-Band	Planar	Right Side	0.0 cm	0.0616
835.89	363	Cellular CDMA	Lithium-ion	23.5	23.3	Dual-Band	Planar	Top End	1.5 cm	0.0048
835.89	363	Cellular CDMA	Lithium-ion	23.5	23.4	Dual-Band	Planar	Back Side	0.0 cm	0.301*
ANSI / IEEE C95.1 1992 - SAFETY LIMIT BODY: 1.6 W/kg (averaged over 1 gram) Spatial Peak - Uncontrolled Exposure / General Population										
Test Date(s)	PCS CDMA		Cellular CDMA		Measured Mixture Type	1900MHz Body	835MHz Body			
	02/06/03		02/06/03		Fluid Temperature	23.2 °C	23.4 °C			
Measured Mixture Type	1900MHz Body		835MHz Body		Ambient Temperature	23.5 °C	23.5 °C			
Dielectric Constant ϵ_r	IEEE Target	Measured	IEEE Target	Measured	Atmospheric Pressure	103.1 kPa	103.1 kPa			
	53.3 ±5%	52.3	55.2 ±5%	53.1	Relative Humidity	43 %	43 %			
Conductivity σ (mho/m)	IEEE Target	Measured	IEEE Target	Measured	Fluid Depth	≥ 15 cm	≥ 15 cm			
	1.52 ±5%	1.51	0.97 ±5%	0.97	ρ (Kg/m ³)	1000	1000			

* Co-located SAR measurement data (Dual-Band CDMA Modem and DSSS WLAN Card transmitting simultaneously).

Note(s):

1. If the SAR measurements performed at the middle channel were ≥ 3 dB below the SAR limit; SAR evaluation for the low and high channels was optional (per FCC OET Bulletin 65, Supplement C, Edition 01-01 (see reference [3])).
2. The ambient and fluid temperatures were measured prior to, and during, the fluid dielectric parameter check and the SAR evaluation. The temperatures listed were consistent for all measurement periods.
3. The dielectric properties of the simulated body fluid were verified prior to the evaluation using an 85070C Dielectric Probe Kit and an 8753E Network Analyzer (see Appendix E for printout of measured fluid dielectric parameters).

MEASUREMENT DATA (Cont.)

BODY SAR MEASUREMENT RESULTS – DSSS WLAN CARD										
Freq. (MHz)	Channel	Test Mode	Battery Type	Conducted Power (dBm)		Antenna Type	Phantom Section	EUT Test Position	Separation Distance to Planar Phantom	Measured SAR 1g (W/kg)
				Before	After					
2437	Mid	CW	Lithium-ion	17.0	17.0	Internal	Planar	Back Side	0.0 cm	0.0018
2437	Mid	CW	Lithium-ion	17.0	17.0	Internal	Planar	Left Side	0.0 cm	0.0008
2437	Mid	CW	Lithium-ion	17.0	17.0	Internal	Planar	Right Side	0.0 cm	0.0016
ANSI / IEEE C95.1 1992 - SAFETY LIMIT BODY: 1.6 W/kg (averaged over 1 gram) Spatial Peak - Uncontrolled Exposure / General Population										
Test Date(s)		02/07/03			Relative Humidity			43 %		
Measured Mixture Type		2450MHz Body			Atmospheric Pressure			103.1 kPa		
Dielectric Constant ϵ_r		IEEE Target		Measured		Ambient Temperature			23.5 °C	
		52.7 ±10%		47.8		Fluid Temperature			23.5 °C	
Conductivity σ (mho/m)		IEEE Target		Measured		Fluid Depth			≥ 15 cm	
		1.95 ±5%		2.01		ρ (Kg/m³)			1000	

Note(s):

1. If the SAR measurements performed at the middle channel were ≥ 3dB below the SAR limit; SAR evaluation for the low and high channels was optional (per FCC OET Bulletin 65, Supplement C, Edition 01-01 (see reference [3])).
2. The ambient and fluid temperatures were measured prior to, and during, the fluid dielectric parameter check and the SAR evaluation. The temperatures listed were consistent for all measurement periods.
3. The dielectric properties of the simulated body fluid were verified prior to the evaluation using an 85070C Dielectric Probe Kit and an 8753E Network Analyzer (see Appendix E for printout of measured fluid dielectric parameters).

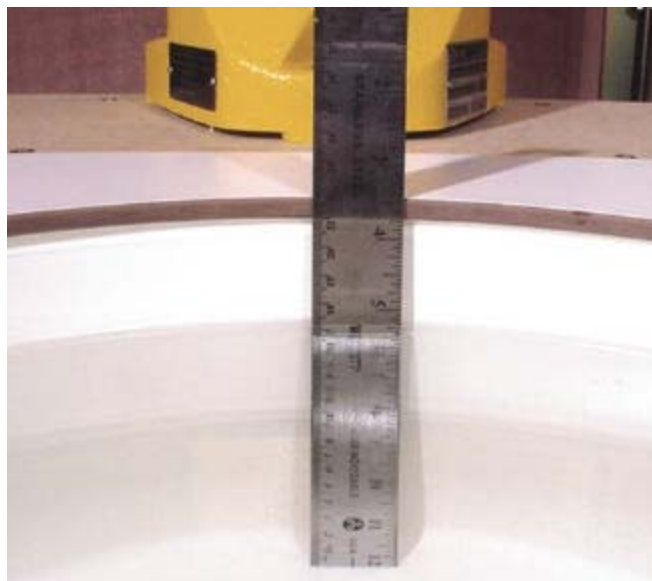

2450MHz Fluid Depth

5.0 DETAILS OF SAR EVALUATION

The Intermec Technologies Corporation Model: 700C Handheld Voice/Data Terminal with Dual-Band CDMA Modem & DSSS WLAN Card FCC ID: HN2SB555 was found to be compliant for localized Specific Absorption Rate (SAR) based on the test provisions and conditions described below. The detailed test setup photographs are shown in Appendix G.

- 1) The EUT was tested in a ear-held configuration on both the left and right sections of the at the middle channel of the operating band. If the SAR value of the middle channel for each test configuration (left ear, right ear, cheek/touch, ear/tilt) was 3dB or greater below the SAR limit, measurements at the low and high channels were optional for those test configurations (including head and body SAR).
 - a) The handset was placed in the device holder in a normal operating position with the test device reference point located along the vertical centerline on the front of the device aligned to the ear reference point, with the center of the earpiece touching the center of the ear spacer of the SAM phantom.
 - b) With the handset positioned parallel to the cheek, the test device reference point was aligned to the ear reference point on the head phantom, and the vertical centerline was aligned to the phantom reference plane (initial ear position).
 - c) While maintaining the three alignments, the body of the handset was gradually adjusted to each of the following test positions:
 - Cheek/Touch Position: The handset was brought toward the mouth of the head phantom by pivoting against the ear reference point until any point of the mouthpiece or keypad touched the phantom.

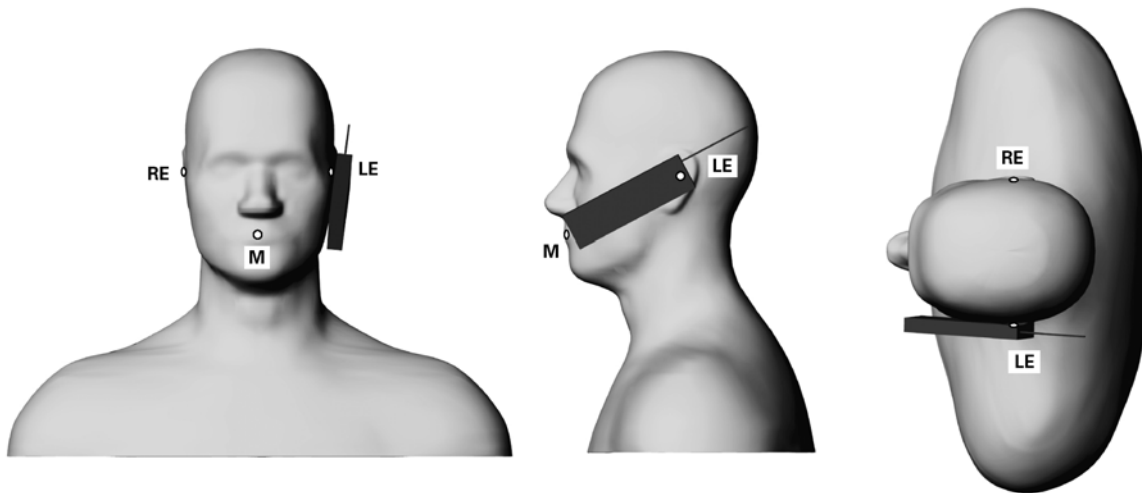

Phone position 1, “cheek” or “touch” position. The reference points for the right ear (RE), left ear (LE) and mouth (M), which define the reference plane for phone positioning, are indicated (Shoulders are shown for illustration only).

DETAILS OF SAR EVALUATION (Cont.)

- Ear/Tilt Position: With the phone aligned in the Cheek/Touch position, the handset was tilted away from the mouth with respect to the test device reference point by 15 degrees.

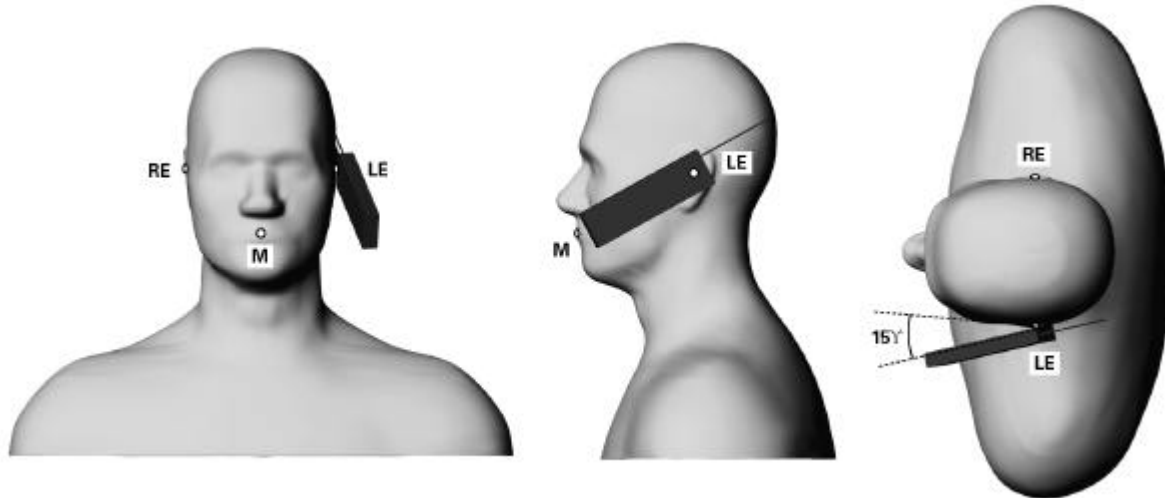

Phone position 2, “tilted position.” The reference points for the right ear (RE), left ear (LE) and mouth (M), which define the reference plane for phone positioning, are indicated (Shoulders are shown for illustration only).

- 2) The EUT was tested in a body-worn configuration with the back of the device placed parallel to, and touching, the outer surface of the planar phantom (for both dual-band CDMA modem and DSSS WLAN card tests).
- 3) The EUT was tested in a body-worn configuration with the right side of the device (antenna side for dual-band CDMA modem) placed parallel to, and touching, the outer surface of the planar phantom (for both dual-band CDMA modem and DSSS WLAN card tests).
- 4) The EUT was tested in a body-worn configuration with the left side of the device placed parallel to, and touching, the outer surface of the planar phantom (for DSSS WLAN card test only).
- 5) The EUT was tested in a body-worn configuration with the top end of the device (external antenna end for dual-band CDMA modem) placed parallel to the outer surface of the planar phantom. A 1.5 cm separation distance was maintained between the tip of the antenna and the outer surface of the planar phantom (for dual-band CDMA modem test only).
- 6) The EUT was also evaluated for SAR with both the CDMA and DSSS modems transmitting simultaneously. For the co-located simultaneous transmit SAR measurements, only the worst-case test configurations from the single transmit tests were re-evaluated.
- 7) The EUT was controlled in test mode via internal software and evaluated for SAR with no turn-on delay.
- 8) SAR measurements were performed with the EUT transmitting continuously at maximum power with a modulated CDMA signal (for dual-band CDMA modem tests).
- 9) SAR measurements were performed with the EUT in unmodulated continuous wave mode (CW) at 100% duty cycle (for DSSS WLAN card tests).
- 10) The conducted power levels were measured before and after each test according to the procedures described in FCC 47 CFR §2.1046. If the conducted power levels measured after each evaluation varied more than 5% from the initial power level, then the EUT was retested. Any unusual anomalies over the course of the test also warranted a re-evaluation.
- 11) The location of the maximum spatial SAR distribution (Hot Spot) was determined relative to the device and its antenna.
- 12) Due to the dimensions of the EUT, a stack of low-density, low-loss dielectric foamed polystyrene was used in the device holder for the head SAR measurements. For the body SAR measurements, a stack of low-density, low-loss dielectric foamed polystyrene was used in place of the device holder.
- 13) The EUT was tested with a fully charged battery.

DETAILS OF SAR EVALUATION (Cont.)

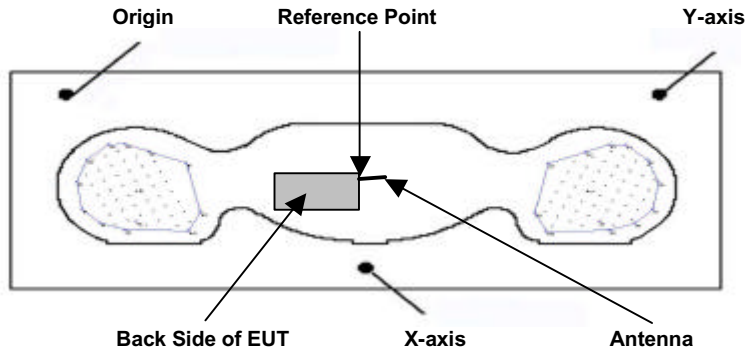

Figure 2. Device Positioning & Reference Point (Body-worn SAR - Back Side)

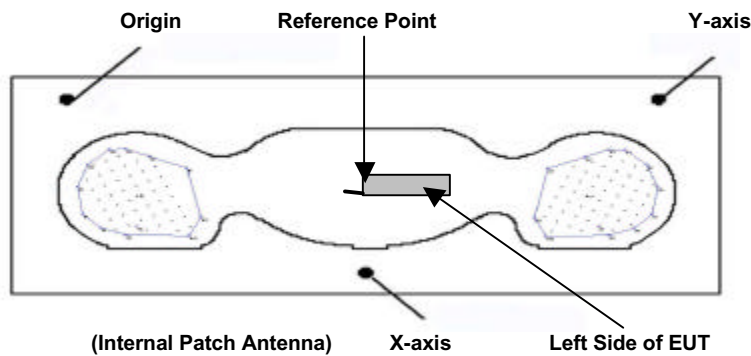

Figure 3. Device Positioning & Reference Point (Body-worn SAR - Left Side)

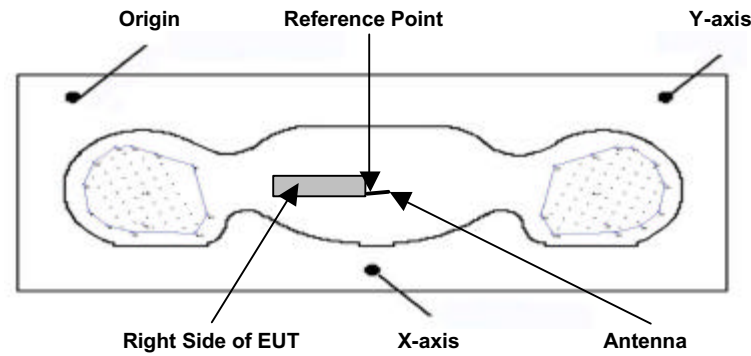

Figure 4. Device Positioning & Reference Point (Body-worn SAR - Right Side)

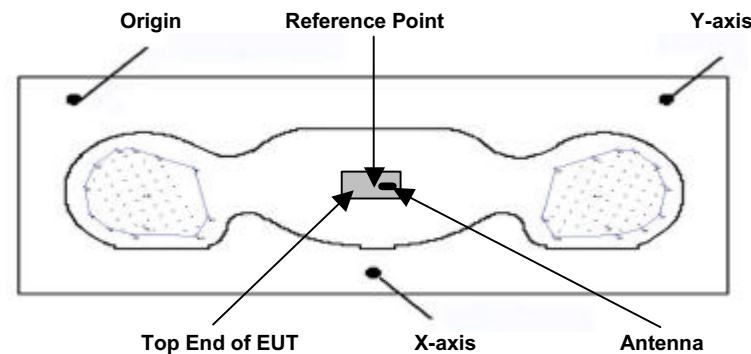

Figure 5. Device Positioning & Reference Point (Body-worn SAR - Top End)

6.0 EVALUATION PROCEDURES

- a. (i) The evaluation was performed in the applicable area of the phantom depending on the type of device being tested. For devices held to the ear during normal operation, both the left and right ear positions were evaluated in accordance with FCC OET Bulletin 65, Supplement C (Edition 01-01) using the SAM phantom.
 - (ii) For body-worn and face-held devices a planar phantom was used.
- b. The SAR was determined by a pre-defined procedure within the DASY3 software. Upon completion of a reference and optical surface check, the exposed region of the phantom was scanned near the inner surface with a grid spacing of 20mm x 20mm.
- c. Based on the area scan data, the area of maximum absorption was determined by spline interpolation. Around this point, a volume of 40 x 40 x 35 mm (fine resolution volume scan, zoom scan) was assessed by measuring 5 x 5 x 7 points.
- d. The 1g and 10g spatial peak SAR was determined as follows:
 1. The first step was an extrapolation to find the points between the dipole center of the probe and the surface of the phantom. This data cannot be measured, since the center of the dipoles is 2.7 mm away from the tip of the probe and the distance between the surface and the lowest measuring point is 1.3 mm (see probe calibration document in Appendix D). The extrapolation was based on a least square algorithm [W. Gander, Computermathematik, p.168-180] (see reference [6]). Through the points in the first 3 cm in all z-axis, polynomials of the fourth order were calculated. This polynomial was then used to evaluate the points between the surface and the probe tip.
 2. The next step used 3D-spline interpolation to get all points within the measured volume in a 1mm grid (35000 points). The 3D-spline is composed of three one-dimensional splines with the "Not a knot" condition [W. Gander, Computermathematik, p.141-150] (x, y and z -direction) [Numerical Recipes in C, Second Edition, p.123ff] (see reference [6]).
 3. The maximal interpolated value was searched with a straightforward algorithm. Around this maximum the SAR values averaged over the spatial volumes (1g or 10g) were computed using the 3D-spline interpolation algorithm. 8000 points (20x20x20) were interpolated to calculate the average.

7.0 SAR SAFETY LIMITS

EXPOSURE LIMITS	SAR (W/kg)	
	(General Population / Uncontrolled Exposure Environment)	(Occupational / Controlled Exposure Environment)
Spatial Average (averaged over the whole body)	0.08	0.4
Spatial Peak (averaged over any 1 g of tissue)	1.60	8.0
Spatial Peak (hands/wrists/feet/ankles averaged over 10 g)	4.0	20.0

Notes:

1. Uncontrolled environments are defined as locations where there is potential exposure of individuals who have no knowledge or control of their potential exposure.
2. Controlled environments are defined as locations where there is potential exposure of individuals who have knowledge of their potential exposure and can exercise control over their exposure.

8.0 EVALUATION FLOW CHART

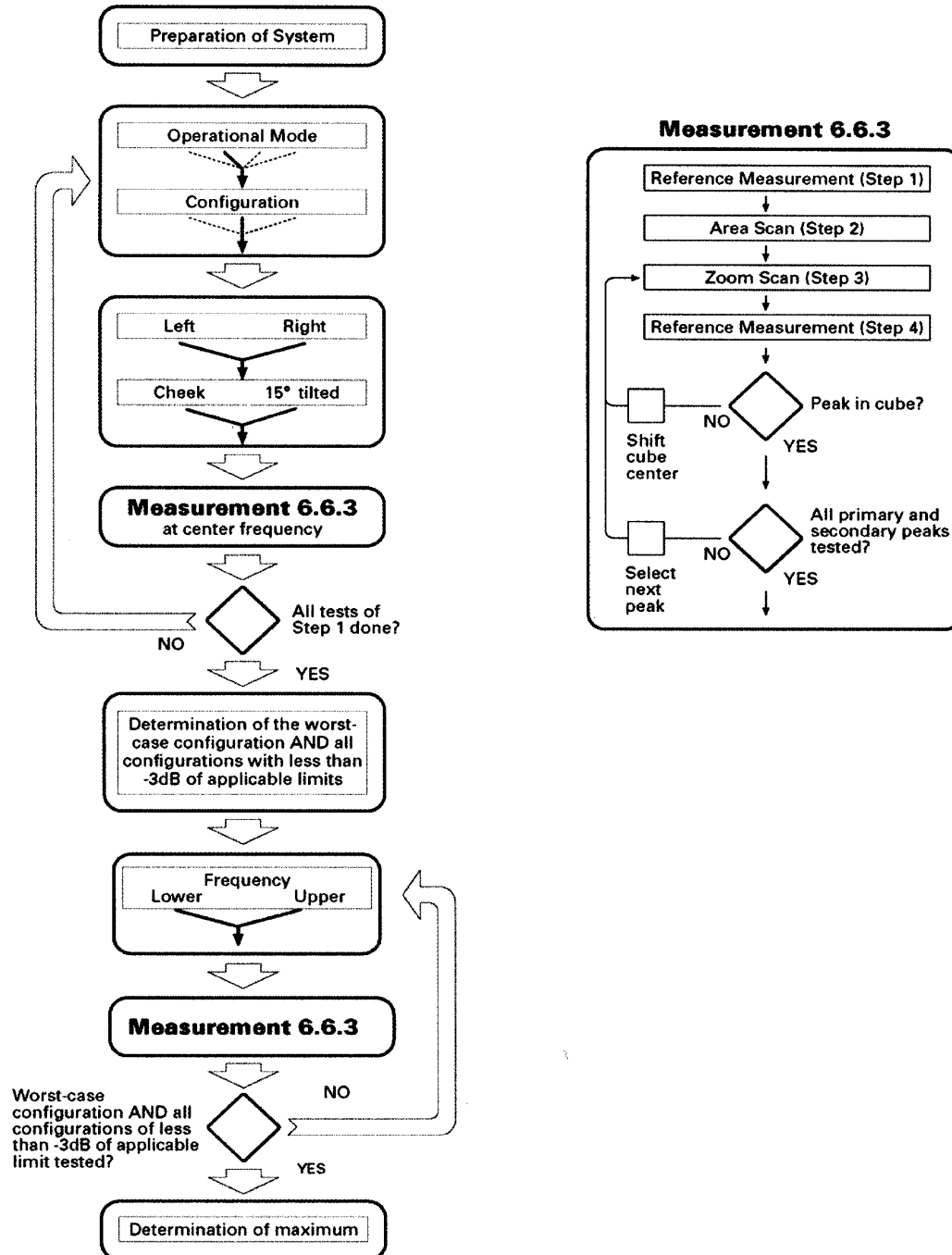

Figure 4. Flow Chart of the recommended practices and procedures per IEEE Std 1528 (Draft) [see reference 5]

9.0 SYSTEM PERFORMANCE CHECK

Prior to the SAR evaluation a system check was performed at the planar section of the SAM phantom with an 1800MHz dipole, 900MHz dipole, and 2450MHz dipole (see Appendix C for system validation procedures). The fluid dielectric parameters were measured prior to the system check using an 85070C Dielectric Probe Kit and an 8753E Network Analyzer (see Appendix E for printout of measured fluid dielectric parameters). A forward power of 250mW was applied to the dipole and the system was verified to a tolerance of $\pm 10\%$ (see Appendix B for system check test plots).

SYSTEM PERFORMANCE CHECK											
Test Date	Equiv. Tissue (Brain)	SAR 1g (W/kg)		Dielectric Constant ϵ_r		Conductivity σ (mho/m)		ρ (Kg/m ³)	Ambient Temp.	Fluid Temp.	Fluid Depth
		IEEE Target	Measured	IEEE Target	Measured	IEEE Target	Measured				
02/05/03	1800MHz	9.53 $\pm 10\%$	9.95	40.0 $\pm 5\%$	40.0	1.40 $\pm 5\%$	1.41	1000	23.3 °C	22.5 °C	≥ 15 cm
02/06/03	1800MHz	9.53 $\pm 10\%$	9.80	40.0 $\pm 5\%$	40.0	1.40 $\pm 5\%$	1.41	1000	23.5 °C	23.4 °C	≥ 15 cm
02/05/03	900MHz	2.70 $\pm 10\%$	2.71	41.5 $\pm 5\%$	41.0	0.97 $\pm 5\%$	0.97	1000	23.3 °C	22.3 °C	≥ 15 cm
02/06/03	900MHz	2.70 $\pm 10\%$	2.74	41.5 $\pm 5\%$	41.1	0.97 $\pm 5\%$	0.97	1000	23.5 °C	23.3 °C	≥ 15 cm
02/07/03	2450MHz	13.1 $\pm 10\%$	14.2	39.2 $\pm 5\%$	35.6	1.80 $\pm 5\%$	1.87	1000	23.4 °C	23.5 °C	≥ 15 cm

Note(s):

1. The ambient and fluid temperatures were measured prior to, and during, the fluid dielectric parameter check and the system performance check. The temperatures listed in the table above were consistent for all measurement periods.

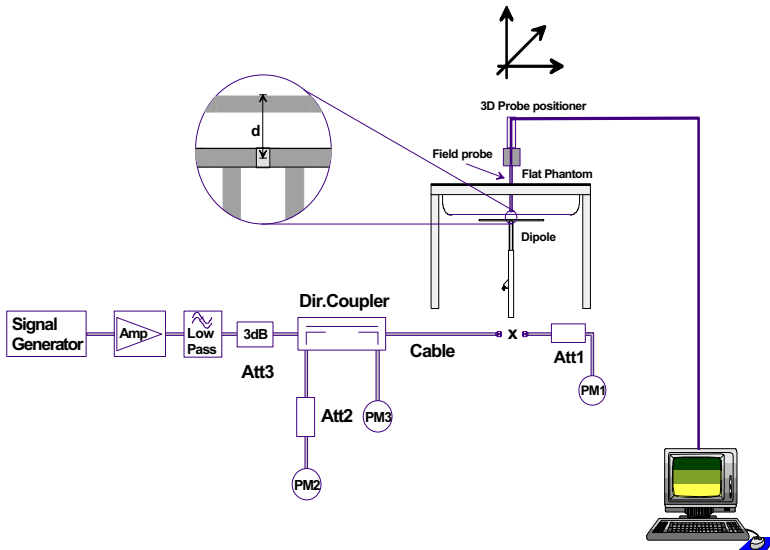

Figure 6. System Check Setup Diagram



1800MHz System Check Setup



900MHz System Check Setup



2450MHz System Check Setup

10.0 EQUIVALENT TISSUES

The 1800-2450MHz brain and body simulated tissue mixtures consist of Glycol-monobutyl, water, and salt (except 2450MHz brain). The 835MHz and 900MHz simulated tissue mixtures consist of a viscous gel using hydroxethylcellulose (HEC) gelling agent and saline solution. Preservation with a bactericide was added and visual inspection was made to ensure air bubbles were not trapped during the mixing process. The fluid was prepared according to standardized procedures and measured for dielectric parameters (permittivity and conductivity).

1800MHz & 1900MHz TISSUE MIXTURES (1 Liter Yields)			
INGREDIENT	1800MHz Brain (System Check)	1900MHz Brain (EUT Evaluation)	1900MHz Body (EUT Evaluation)
Water	548.0 g	552.40 g	716.60 g
Glycol Monobutyl	448.5 g	444.52 g	300.70 g
Salt	3.20 g	3.06 g	3.10 g

2450MHz TISSUE MIXTURES		
INGREDIENT	2450MHz Brain (System Check)	2450MHz Body (EUT Evaluation)
Water	55.20 %	69.95 %
Glycol Monobutyl	44.80 %	30.00 %
Salt	-	0.05 %

835MHz & 900MHz TISSUE MIXTURES		
INGREDIENT	900MHz Brain (System Check)	835MHz Body (EUT Evaluation)
Water	40.71 %	53.70 %
Sugar	56.63 %	45.10 %
Salt	1.48 %	0.97 %
HEC	1.00 %	0.13%
Bactericide	0.18 %	0.10 %

11.0 ROBOT SYSTEM SPECIFICATIONS

Specifications

POSITIONER: Stäubli Unimation Corp. Robot Model: RX60L
Repeatability: 0.02 mm
No. of axis: 6

Data Acquisition Electronic (DAE) System

Cell Controller

Processor: Pentium III
Clock Speed: 450 MHz
Operating System: Windows NT
Data Card: DASY3 PC-Board

Data Converter

Features: Signal Amplifier, multiplexer, A/D converter, and control logic
Software: DASY3 software
Connecting Lines: Optical downlink for data and status info.
Optical uplink for commands and clock

PC Interface Card

Function: 24 bit (64 MHz) DSP for real time processing
Link to DAE3
16-bit A/D converter for surface detection system
serial link to robot
direct emergency stop output for robot

E-Field Probe

Model: ET3DV6
Serial No.: 1590
Construction: Triangular core fiber optic detection system
Frequency: 10 MHz to 6 GHz
Linearity: ± 0.2 dB (30 MHz to 3 GHz)

Phantom

Type: SAM V4.0C
Shell Material: Fiberglass
Thickness: 2.0 ± 0.1 mm
Volume: Approx. 20 liters

12.0 SAM PHANTOM V4.0C

The SAM phantom V4.0C is a fiberglass shell phantom with a 2.0 mm shell thickness for left and right head and flat planar area integrated in a wooden table. The shape of the fiberglass shell corresponds to the phantom defined by SCC34-SC2. The device holder positions are adjusted to the standard measurement positions in the three sections.



SAM Phantom V4.0C

13.0 DEVICE HOLDER

The DASY3 device holder has two scales for device rotation (with respect to the body axis) and the device inclination (with respect to the line between the ear openings). The plane between the ear openings and the mouth tip has a rotation angle of 65°. The bottom plate contains three pair of bolts for locking the device holder. The device holder positions are adjusted to the standard measurement positions in the three sections.



Device Holder

14.0 PROBE SPECIFICATION (ET3DV6)

Construction:	Symmetrical design with triangular core Built-in shielding against static charges PEEK enclosure material (resistant to organic solvents, e.g. glycol)
Calibration:	In air from 10 MHz to 2.5 GHz In brain simulating tissue at frequencies of 900 MHz and 1.8 GHz (accuracy $\pm 8\%$)
Frequency:	10 MHz to >6 GHz; Linearity: ± 0.2 dB (30 MHz to 3 GHz)
Directivity:	± 0.2 dB in brain tissue (rotation around probe axis) ± 0.4 dB in brain tissue (rotation normal to probe axis)
Dynam. Rnge:	5 μ W/g to >100 mW/g; Linearity: ± 0.2 dB
Srfce. Detect.	± 0.2 mm repeatability in air and clear liquids over diffuse reflecting surfaces
Dimensions:	Overall length: 330 mm Tip length: 16 mm Body diameter: 12 mm Tip diameter: 6.8 mm Distance from probe tip to dipole centers: 2.7 mm
Application:	General dosimetry up to 3 GHz Compliance tests of mobile phone



ET3DV6 E-Field Probe

15.0 TEST EQUIPMENT LIST

SAR MEASUREMENT SYSTEM		
EQUIPMENT	SERIAL NO.	CALIBRATION DATE
DASY3 System	-	-
-Robot	599396-01	N/A
-ET3DV6 E-Field Probe	1590	April 2002
-300MHz Validation Dipole	135	Oct 2002
-450MHz Validation Dipole	136	Oct 2002
-900MHz Validation Dipole	054	June 2001
-1800MHz Validation Dipole	247	June 2001
-2450MHz Validation Dipole	150	Oct 2002
-SAM Phantom V4.0C	N/A	N/A
-Small Planar Phantom	N/A	N/A
-Large Planar Phantom	N/A	N/A
85070C Dielectric Probe Kit	N/A	N/A
Gigatronics 8652A Power Meter	1835272	Feb 2003
-Power Sensor 80701A	1833535	Feb 2003
-Power Sensor 80701A	1833542	Feb 2003
E4408B Spectrum Analyzer	US39240170	Nov 2002
8594E Spectrum Analyzer	3543A02721	Feb 2003
8753E Network Analyzer	US38433013	Feb 2003
8648D Signal Generator	3847A00611	Feb 2003
5S1G4 Amplifier Research Power Amplifier	26235	N/A

16.0 MEASUREMENT UNCERTAINTIES

Error Description	Uncertainty Value ±%	Probability Distribution	Divisor	C_i 1g	Standard Uncertainty ±% (1g)	v_i or v_{eff}
Measurement System						
Probe calibration	± 4.8	Normal	1	1	± 4.8	∞
Axial isotropy of the probe	± 4.7	Rectangular	√3	(1- c_p)	± 1.9	∞
Spherical isotropy of the probe	± 9.6	Rectangular	√3	(c_p)	± 3.9	∞
Spatial resolution	± 0.0	Rectangular	√3	1	± 0.0	∞
Boundary effects	± 5.5	Rectangular	√3	1	± 3.2	∞
Probe linearity	± 4.7	Rectangular	√3	1	± 2.7	∞
Detection limit	± 1.0	Rectangular	√3	1	± 0.6	∞
Readout electronics	± 1.0	Normal	1	1	± 1.0	∞
Response time	± 0.8	Rectangular	√3	1	± 0.5	∞
Integration time	± 1.4	Rectangular	√3	1	± 0.8	∞
RF ambient conditions	± 3.0	Rectangular	√3	1	± 1.7	∞
Mech. constraints of robot	± 0.4	Rectangular	√3	1	± 0.2	∞
Probe positioning	± 2.9	Rectangular	√3	1	± 1.7	∞
Extrapolation & integration	± 3.9	Rectangular	√3	1	± 2.3	∞
Test Sample Related						
Device positioning	± 6.0	Normal	√3	1	± 6.7	12
Device holder uncertainty	± 5.0	Normal	√3	1	± 5.9	8
Power drift	± 5.0	Rectangular	√3		± 2.9	∞
Phantom and Setup						
Phantom uncertainty	± 4.0	Rectangular	√3	1	± 2.3	∞
Liquid conductivity (target)	± 5.0	Rectangular	√3	0.6	± 1.7	∞
Liquid conductivity (measured)	± 5.0	Rectangular	√3	0.6	± 1.7	∞
Liquid permittivity (target)	± 5.0	Rectangular	√3	0.6	± 1.7	∞
Liquid permittivity (measured)	± 5.0	Rectangular	√3	0.6	± 1.7	∞
Combined Standard Uncertainty					± 13.7	
Expanded Uncertainty (k=2)					± 27.5	

Measurement Uncertainty Table in accordance with IEEE Std 1528 (Draft - see reference [5])

17.0 REFERENCES

- [1] Federal Communications Commission, "Radiofrequency radiation exposure evaluation: portable devices", Rule Part 47 CFR §2.1093: 1999.
- [2] Health Canada, "Limits of Human Exposure to Radiofrequency Electromagnetic Fields in the Frequency Range from 3 kHz to 300 GHz", Safety Code 6.
- [3] Federal Communications Commission, "Evaluating Compliance with FCC Guidelines for Human Exposure to Radio frequency Electromagnetic Fields", OET Bulletin 65, Supplement C (Edition 01-01), FCC, Washington, D.C.: June 2001.
- [4] Industry Canada, "Evaluation Procedure for Mobile and Portable Radio Transmitters with respect to Health Canada's Safety Code 6 for Exposure of Humans to Radio Frequency Fields", Radio Standards Specification RSS-102 Issue 1 (Provisional): September 1999.
- [5] IEEE Standards Coordinating Committee 34, Std 1528-200X, "DRAFT Recommended Practice for Determining the Spatial-Peak Specific Absorption Rate (SAR) in the Human Body Due to Wireless Communications Devices: Experimental Techniques".
- [6] W. Gander, *Computermathematick*, Birkhaeuser, Basel: 1992.

APPENDIX A - SAR MEASUREMENT DATA

Intermec Technologies Corp. FCC ID: HN2SB555

SAM Phantom; Flat Section; Position: (90°,65°)
Probe: ET3DV6 - SN1590; ConvF(5.60,5.60,5.60); Crest factor: 1.0
1900 MHz Brain: $\sigma = 1.40$ mho/m $\epsilon_r = 38.2$ $\rho = 1.00$ g/cm³
Coarse: Dx = 15.0, Dy = 15.0, Dz = 10.0
Cube 5x5x7; Powerdrift: -0.03 dB
SAR (1g): 0.685 mW/g, SAR (10g): 0.383 mW/g

Head SAR - Left Ear - Cheek/Touch Position
Handheld Data Terminal with Dual Band CDMA Modem & DSSS WLAN Card
Intermec Model: 700C with Single-Band External Stubby Antenna (P/N: 805-606-004)
7.2V Lithium-Ion Battery
PCS CDMA Mode
Channel 600 [1880.00 MHz]
Conducted Power: 23.5 dBm
Ambient Temp. 23.3°C; Fluid Temp. 22.7°C
Date Tested: February 05, 2003

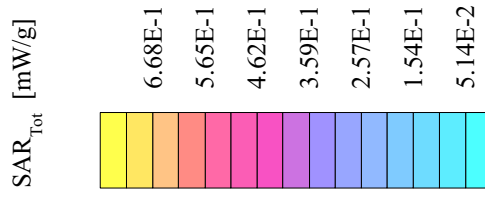
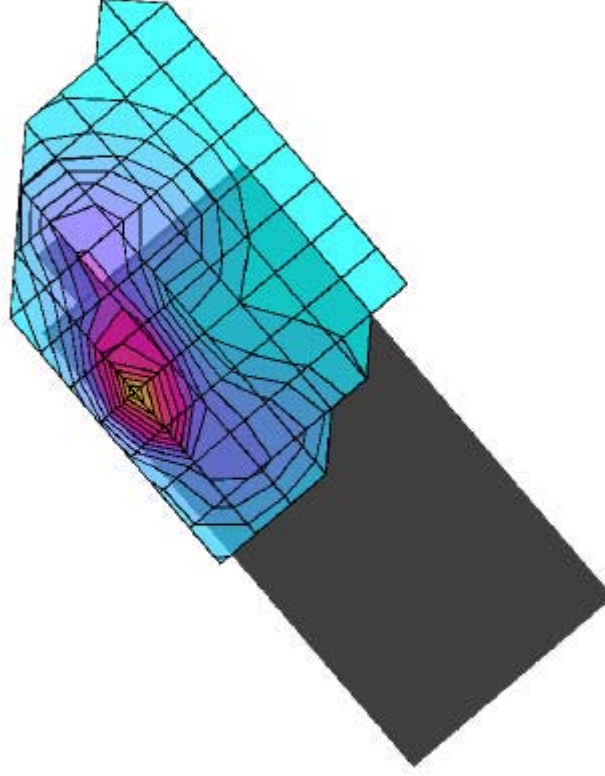

Intermec Technologies Corp. FCC ID: HN2SB555

SAM Phantom; Flat Section; Position: (90°,65°)
Probe: ET3DV6 - SN1590; ConvF(5.60,5.60,5.60); Crest factor: 1.0
1900 MHz Brain: $\sigma = 1.40$ mho/m $\epsilon_r = 38.2$ $\rho = 1.00$ g/cm³
Coarse: Dx = 15.0, Dy = 15.0, Dz = 10.0
Cube 5x5x7; Powerdrift: -0.15 dB
SAR (1g): 0.672 mW/g, SAR (10g): 0.377 mW/g

Head SAR - Left Ear - Ear/Tilt Position
Handheld Data Terminal with Dual Band CDMA Modem & DSSS WLAN Card
Intermec Model: 700C with Single-Band External Stubby Antenna (P/N: 805-606-004)
7.2V Lithium-Ion Battery
PCS CDMA Mode
Channel 600 [1880.00 MHz]
Conducted Power: 23.5 dBm
Ambient Temp. 23.3°C; Fluid Temp. 22.7°C
Date Tested: February 05, 2003

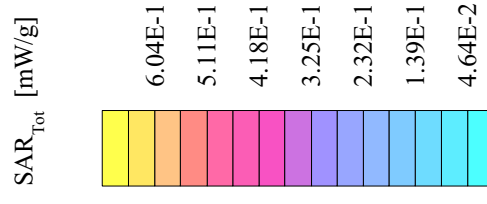
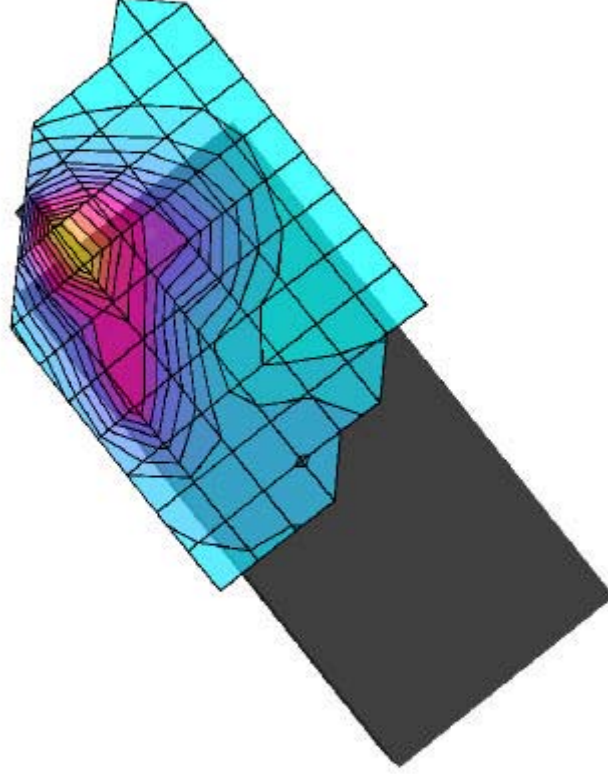

Intermec Technologies Corp. FCC ID: HN2SB555

SAM Phantom; Flat Section; Position: (90°, 295°)
Probe: ET3DV6 - SN1590; ConvF(5.60,5.60,5.60); Crest factor: 1.0
1900 MHz Brain: $\sigma = 1.40$ mho/m $\epsilon_r = 38.2$ $\rho = 1.00$ g/cm³
Coarse: Dx = 15.0, Dy = 15.0, Dz = 10.0
Cube 5x5x7; Powerdrift: -0.04 dB
SAR (1g): 0.738 mW/g, SAR (10g): 0.412 mW/g

Head SAR - Right Ear - Cheek/Touch Position
Handheld Data Terminal with Dual Band CDMA Modem & DSSS WLAN Card
Intermec Model: 700C with Single-Band External Stubby Antenna (P/N: 805-606-004)
7.2V Lithium-Ion Battery
PCS CDMA Mode
Channel 600 [1880.00 MHz]
Conducted Power: 23.5 dBm
Ambient Temp. 23.3°C; Fluid Temp. 22.7°C
Date Tested: February 05, 2003

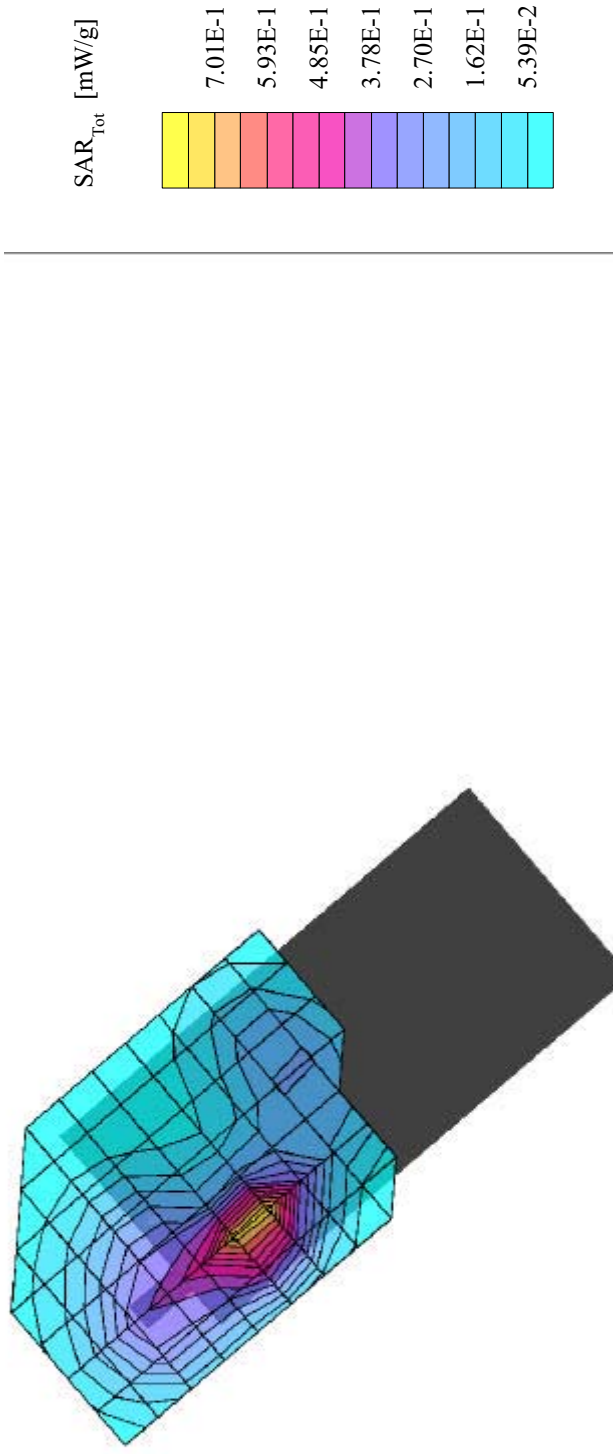

Intermec Technologies Corp. FCC ID: HN2SB555

SAM Phantom; Flat Section; Position: (90°, 295°)
Probe: ET3DV6 - SN1590; ConvF(5.60,5.60,5.60); Crest factor: 1.0
1900 MHz Brain: $\sigma = 1.40$ mho/m $\epsilon_r = 38.2$ $\rho = 1.00$ g/cm³
Coarse: Dx = 15.0, Dy = 15.0, Dz = 10.0
Cube 5x5x7; Powerdrift: -0.03 dB
SAR (1g): 0.962 mW/g, SAR (10g): 0.515 mW/g

Head SAR - Right Ear - Ear/Tilt Position
Handheld Data Terminal with Dual Band CDMA Modem & DSSS WLAN Card
Intermec Model: 700C with Single-Band External Stubby Antenna (P/N: 805-606-004)
7.2V Lithium-Ion Battery
PCS CDMA Mode
Channel 600 [1880.00 MHz]
Conducted Power: 23.5 dBm
Ambient Temp. 23.3°C; Fluid Temp. 22.7°C
Date Tested: February 05, 2003

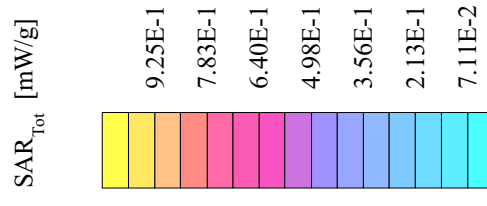
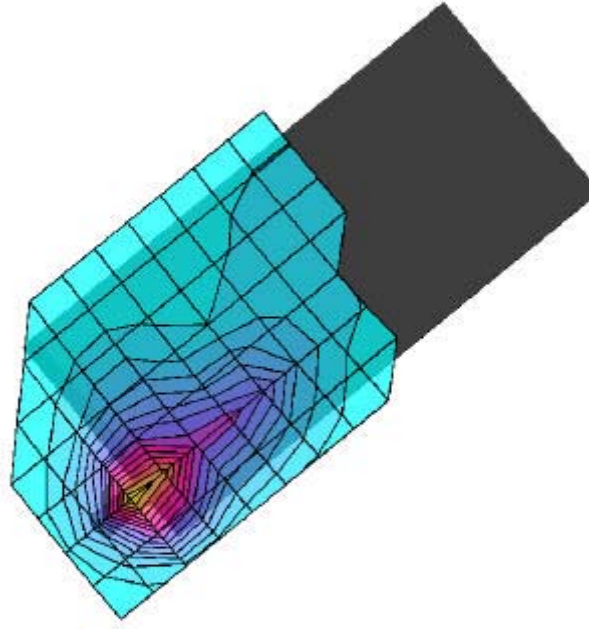

Intermec Technologies Corp. FCC ID: HN2SB555

SAM Phantom; Flat Section; Position: (90°, 295°)
Probe: ET3DV6 - SN1590; ConvF(5.60,5.60,5.60); Crest factor: 1.0
1900 MHz Brain: $\sigma = 1.40$ mho/m $\epsilon_r = 38.2$ $\rho = 1.00$ g/cm³
Coarse: Dx = 15.0, Dy = 15.0, Dz = 10.0
Cube 5x5x7; Powerdrift: 0.05 dB
SAR (1g): 1.07 mW/g, SAR (10g): 0.579 mW/g

Head SAR - Right Ear - Ear/Tilt Position
Handheld Data Terminal with Dual Band CDMA Modem & DSSS WLAN Card
Intermec Model: 700C with Single-Band External Stubby Antenna (P/N: 805-606-004)
7.2V Lithium-Ion Battery
PCS CDMA Mode
Channel 25 [1851.25 MHz]
Conducted Power: 23.5 dBm
Ambient Temp. 23.3°C; Fluid Temp. 22.7°C
Date Tested: February 05, 2003

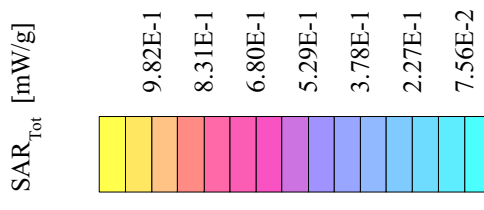
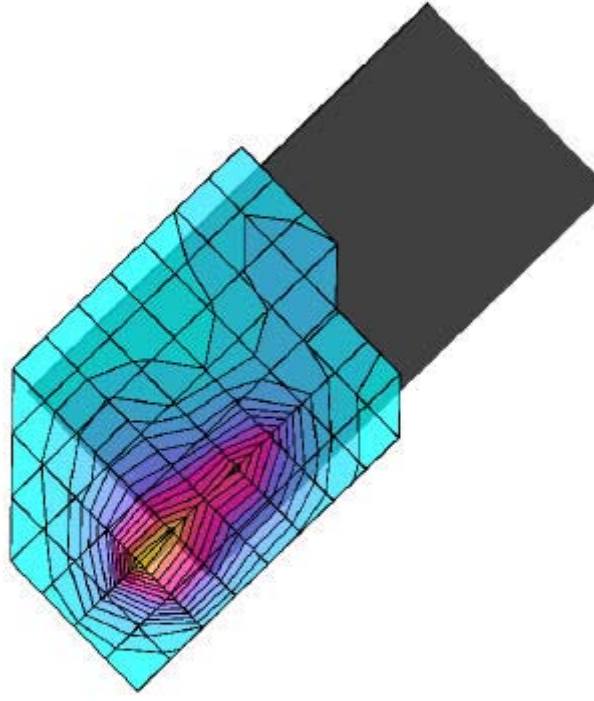

Intermec Technologies Corp. FCC ID: HN2SB555

SAM Phantom; Flat Section; Position: (90°, 295°)
Probe: ET3DV6 - SN1590; ConvF(5.60,5.60,5.60); Crest factor: 1.0
1900 MHz Brain: $\sigma = 1.40$ mho/m $\epsilon_r = 38.2$ $\rho = 1.00$ g/cm³
Coarse: Dx = 15.0, Dy = 15.0, Dz = 10.0
Cube 5x5x7; Powerdrift: -0.16 dB
SAR (1g): 0.651 mW/g, SAR (10g): 0.343 mW/g

Head SAR - Right Ear - Ear/Tilt Position
Handheld Data Terminal with Dual Band CDMA Modem & DSSS WLAN Card
Intermec Model: 700C with Single-Band External Stubby Antenna (P/N: 805-606-004)
7.2V Lithium-Ion Battery
PCS CDMA Mode
Channel 1175 [1908.75 MHz]
Conducted Power: 23.5 dBm
Ambient Temp. 23.3°C; Fluid Temp. 22.7°C
Date Tested: February 05, 2003

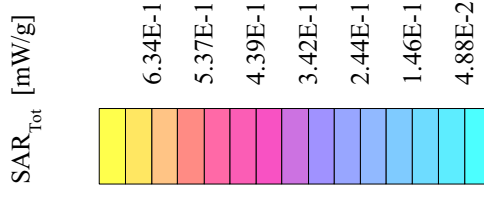
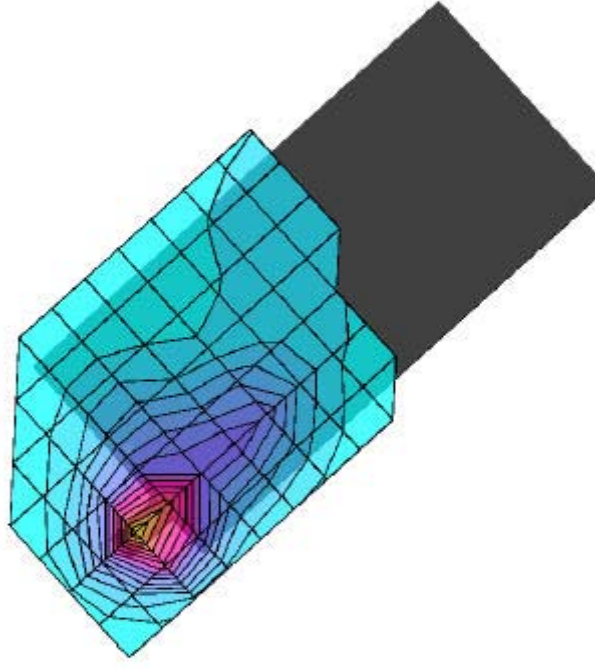

Intermec Technologies Corp. FCC ID: HN2SB555

SAM Phantom; Flat Section; Position: (90°, 295°)
Probe: ET3DV6 - SN1590; ConvF(5.60,5.60,5.60); Crest factor: 1.0
1900 MHz Brain: $\sigma = 1.40$ mho/m $\epsilon_r = 38.2$ $\rho = 1.00$ g/cm³
Coarse: Dx = 15.0, Dy = 15.0, Dz = 10.0
Cube 5x5x7; Powerdrift: 0.02 dB
SAR (1g): 0.996 mW/g, SAR (10g): 0.538 mW/g

Head SAR - Right Ear - Ear/Tilt Position (Co-located Transmit with DSSS WLAN Card)
Handheld Data Terminal with Dual Band CDMA Modem & DSSS WLAN Card
Intermec Model: 700C with Single-Band External Stubby Antenna (P/N: 805-606-004)
7.2V Lithium-Ion Battery
PCS CDMA Mode
Channel 25 [1851.25 MHz]
Conducted Power: 23.5 dBm
Ambient Temp. 23.3°C; Fluid Temp. 22.7°C
Date Tested: February 05, 2003

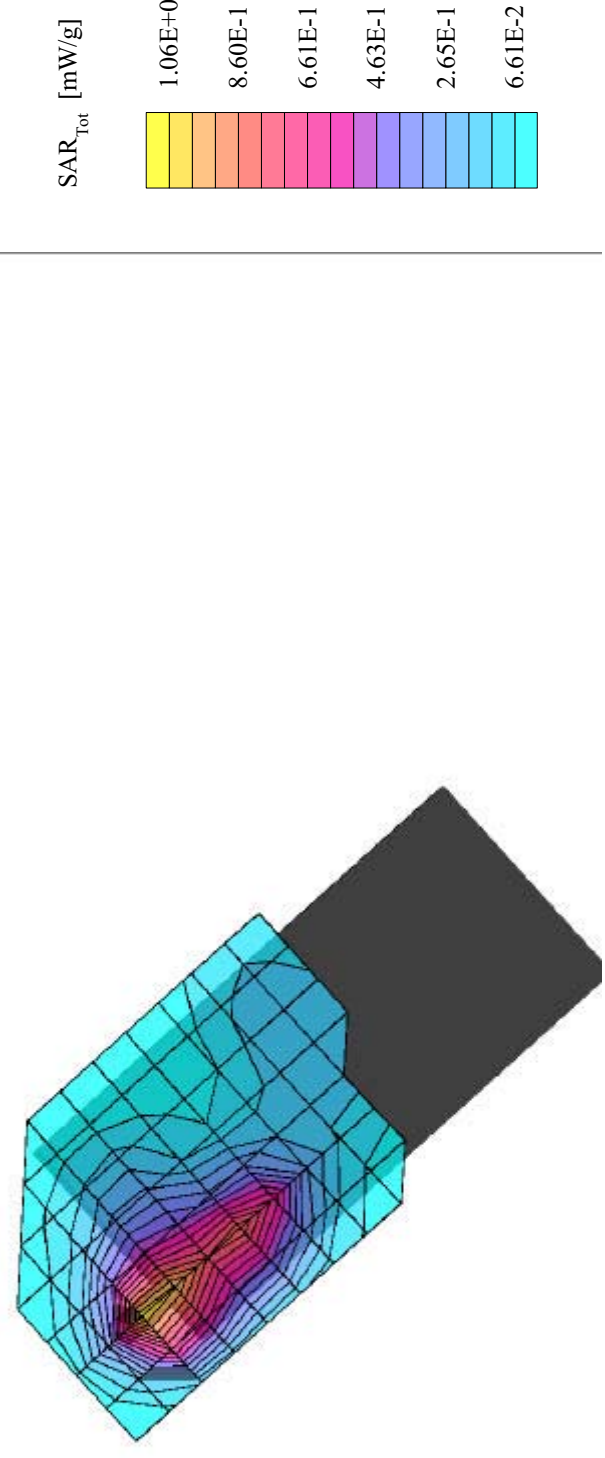

Intermec Technologies Corp. FCC ID: HN2SB555

SAM Phantom; Flat Section; Position: (90°,65°)
Probe: ET3DV6 - SN1590; ConvF(5.60,5.60,5.60); Crest factor: 1.0
1900 MHz Brain: $\sigma = 1.40$ mho/m $\epsilon_r = 38.2$ $\rho = 1.00$ g/cm³
Coarse: Dx = 15.0, Dy = 15.0, Dz = 10.0
Cube 5x5x7; Powerdrift: -0.18 dB
SAR (1g): 0.321 mW/g, SAR (10g): 0.189 mW/g

Head SAR - Left Ear - Cheek/Touch Position
Handheld Data Terminal with Dual Band CDMA Modem & DSSS WLAN Card
Intermec Model: 700C with Dual-Band External Stubby Antenna (P/N: 805-606-002)
7.2V Lithium-Ion Battery
PCS CDMA Mode
Channel 600 [1880.00 MHz]
Conducted Power: 23.5 dBm
Ambient Temp: 23.3°C; Fluid Temp: 22.7°C
Date Tested: February 05, 2003

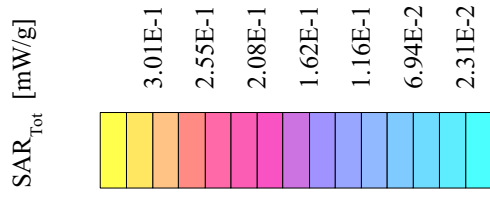
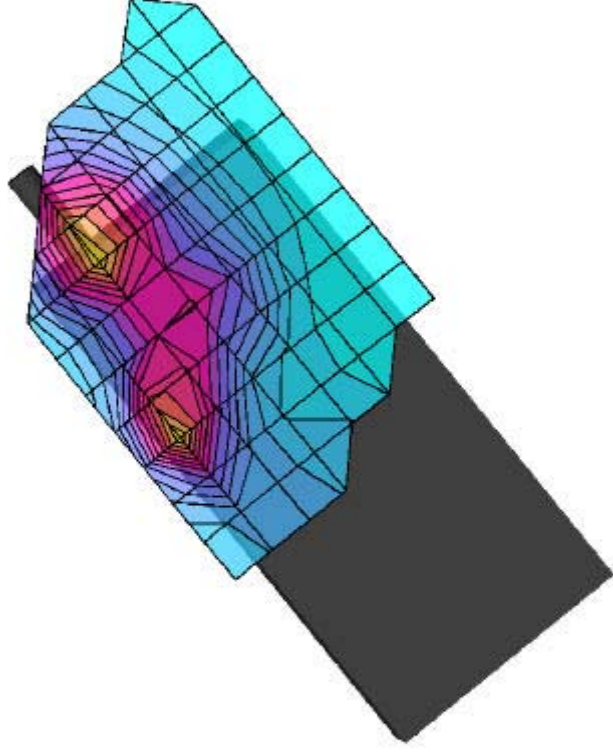

Intermec Technologies Corp. FCC ID: HN2SB555

SAM Phantom; Flat Section; Position: (90°,65°)
Probe: ET3DV6 - SN1590; ConvF(5.60,5.60,5.60); Crest factor: 1.0
1900 MHz Brain: $\sigma = 1.40$ mho/m $\epsilon_r = 38.2$ $\rho = 1.00$ g/cm³
Coarse: Dx = 15.0, Dy = 15.0, Dz = 10.0
Cube 5x5x7; Powerdrift: -0.15 dB
SAR (1g): 0.560 mW/g, SAR (10g): 0.306 mW/g

Head SAR - Left Ear - Ear/Tilt Position
Handheld Data Terminal with Dual Band CDMA Modem & DSSS WLAN Card
Intermec Model: 700C with Dual-Band External Stubby Antenna (P/N: 805-606-002)
7.2V Lithium-Ion Battery
PCS CDMA Mode
Channel 600 [1880.00 MHz]
Conducted Power: 23.5 dBm
Ambient Temp: 23.3°C; Fluid Temp: 22.7°C
Date Tested: February 05, 2003

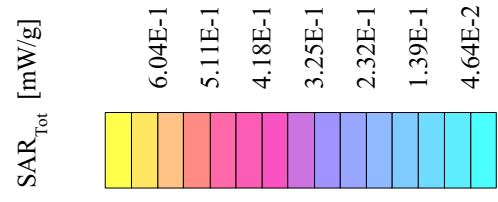
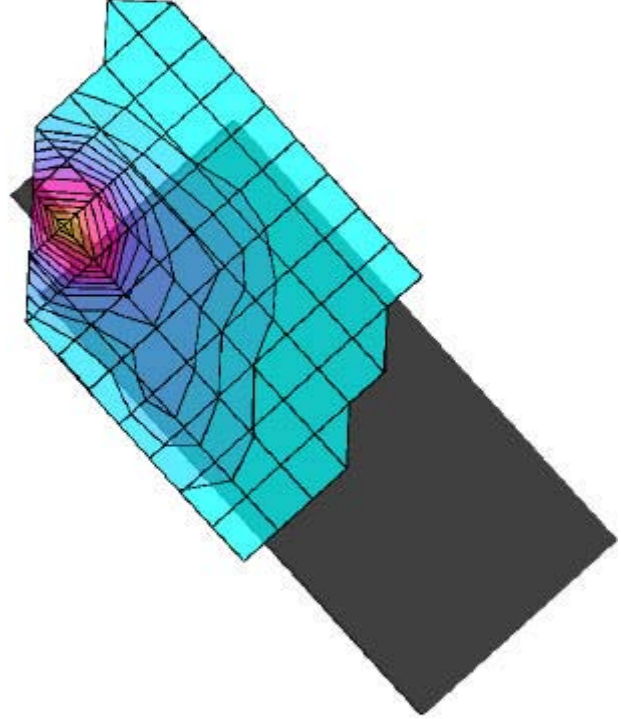

Intermec Technologies Corp. FCC ID: HN2SB555

SAM Phantom; Flat Section; Position: (90°, 295°)
Probe: ET3DV6 - SN1590; ConvF(5.60,5.60,5.60); Crest factor: 1.0
1900 MHz Brain: $\sigma = 1.40$ mho/m $\epsilon_r = 38.2$ $\rho = 1.00$ g/cm³
Coarse: Dx = 15.0, Dy = 15.0, Dz = 10.0
Cube 5x5x7; Powerdrift: -0.14 dB
SAR (1g): 0.537 mW/g, SAR (10g): 0.308 mW/g

Head SAR - Right Ear - Cheek/Touch Position
Handheld Data Terminal with Dual Band CDMA Modem & DSSS WLAN Card
Intermec Model: 700C with Dual-Band External Stubby Antenna (P/N: 805-606-002)
7.2V Lithium-Ion Battery
PCS CDMA Mode
Channel 600 [1880.00 MHz]
Conducted Power: 23.5 dBm
Ambient Temp: 23.3°C; Fluid Temp: 22.7°C
Date Tested: February 05, 2003

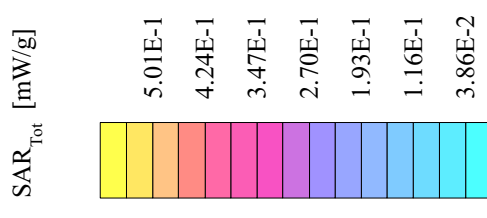
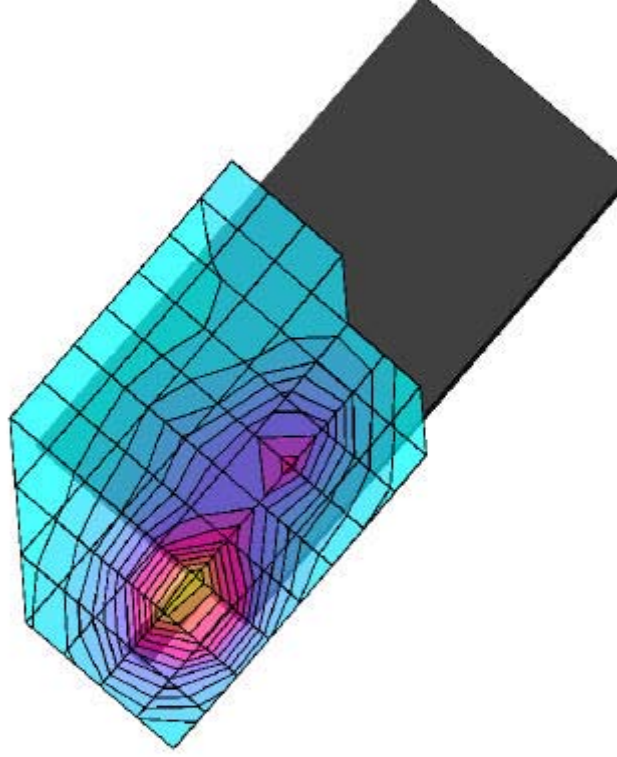

Intermec Technologies Corp. FCC ID: HN2SB555

SAM Phantom; Flat Section; Position: (90°, 295°)
Probe: ET3DV6 - SN1590; ConvF(5.60,5.60,5.60); Crest factor: 1.0
1900 MHz Brain: $\sigma = 1.40$ mho/m $\epsilon_r = 38.2$ $\rho = 1.00$ g/cm³
Coarse: Dx = 15.0, Dy = 15.0, Dz = 10.0
Cube 5x5x7; Powerdrift: -0.12 dB
SAR (1g): 1.28 mW/g, SAR (10g): 0.690 mW/g

Head SAR - Right Ear - Ear/Tilt Position
Handheld Data Terminal with Dual Band CDMA Modem & DSSS WLAN Card
Intermec Model: 700C with Dual-Band External Stubby Antenna (P/N: 805-606-002)
7.2V Lithium-Ion Battery
PCS CDMA Mode
Channel 600 [1880.00 MHz]
Conducted Power: 23.5 dBm
Ambient Temp: 23.3°C; Fluid Temp: 22.7°C
Date Tested: February 05, 2003

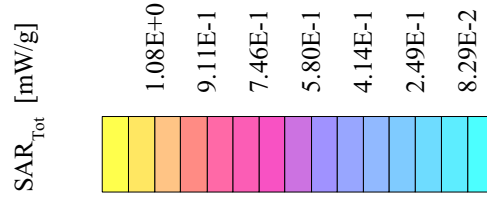
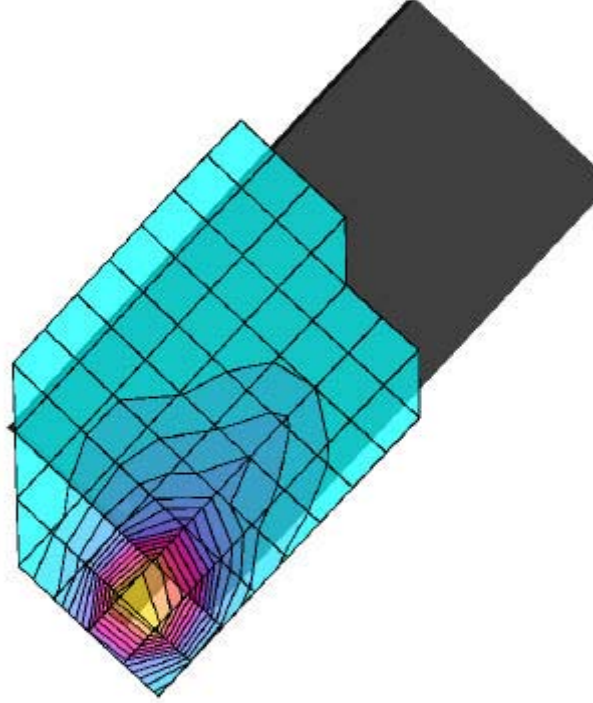

Intermec Technologies Corp. FCC ID: HN2SB555

SAM Phantom; Flat Section; Position: (90°, 295°)
Probe: ET3DV6 - SN1590; ConvF(5.60,5.60,5.60); Crest factor: 1.0
1900 MHz Brain: $\sigma = 1.40$ mho/m $\epsilon_r = 38.2$ $\rho = 1.00$ g/cm³
Coarse: Dx = 15.0, Dy = 15.0, Dz = 10.0
Cube 5x5x7; Powerdrift: -0.10 dB
SAR (1g): 1.17 mW/g, SAR (10g): 0.631 mW/g

Head SAR - Right Ear - Ear/Tilt Position
Handheld Data Terminal with Dual Band CDMA Modem & DSSS WLAN Card
Intermec Model: 700C with Dual-Band External Stubby Antenna (P/N: 805-606-002)
7.2V Lithium-Ion Battery
PCS CDMA Mode
Channel 25 [1851.25 MHz]
Conducted Power: 23.5 dBm
Ambient Temp: 23.3°C; Fluid Temp: 22.7°C
Date Tested: February 05, 2003

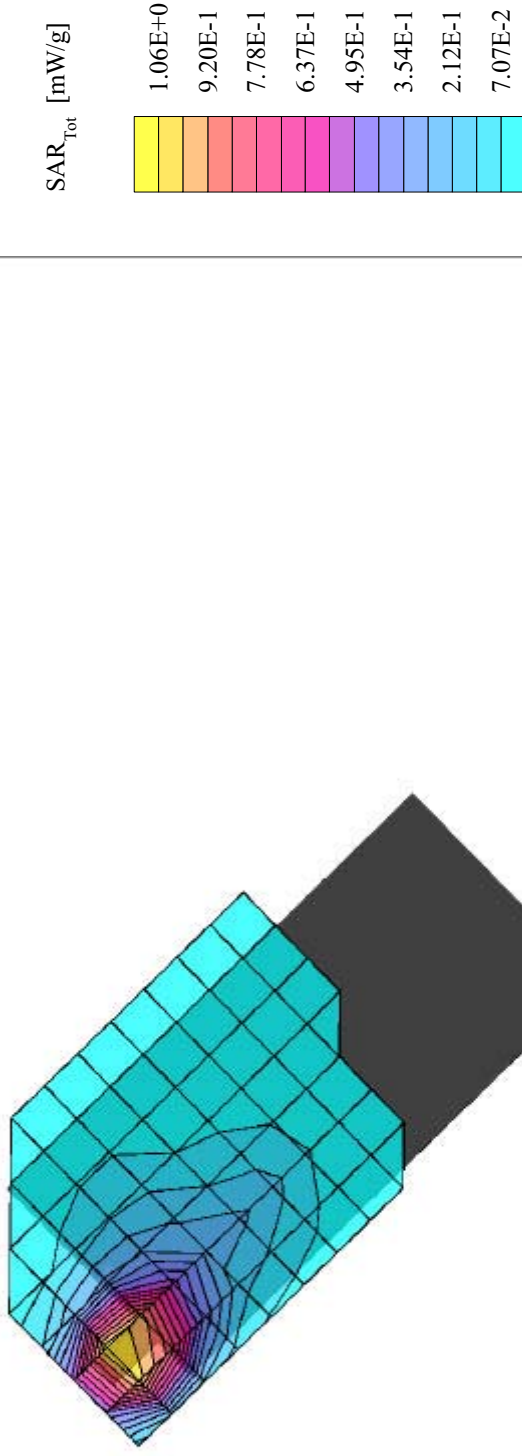

Intermec Technologies Corp. FCC ID: HN2SB555

SAM Phantom; Flat Section; Position: (90°, 295°)
Probe: ET3DV6 - SN1590; ConvF(5.60,5.60,5.60); Crest factor: 1.0
1900 MHz Brain: $\sigma = 1.40$ mho/m $\epsilon_r = 38.2$ $\rho = 1.00$ g/cm³
Coarse: Dx = 15.0, Dy = 15.0, Dz = 10.0
Cube 5x5x7; Powerdrift: -0.00 dB
SAR (1g): 1.47 mW/g, SAR (10g): 0.784 mW/g

Head SAR - Right Ear - Ear/Tilt Position
Handheld Data Terminal with Dual Band CDMA Modem & DSSS WLAN Card
Intermec Model: 700C with Dual-Band External Stubby Antenna (P/N: 805-606-002)
7.2V Lithium-Ion Battery
PCS CDMA Mode
Channel 1175 [1908.75 MHz]
Conducted Power: 23.5 dBm
Ambient Temp: 23.3°C; Fluid Temp: 22.7°C
Date Tested: February 05, 2003

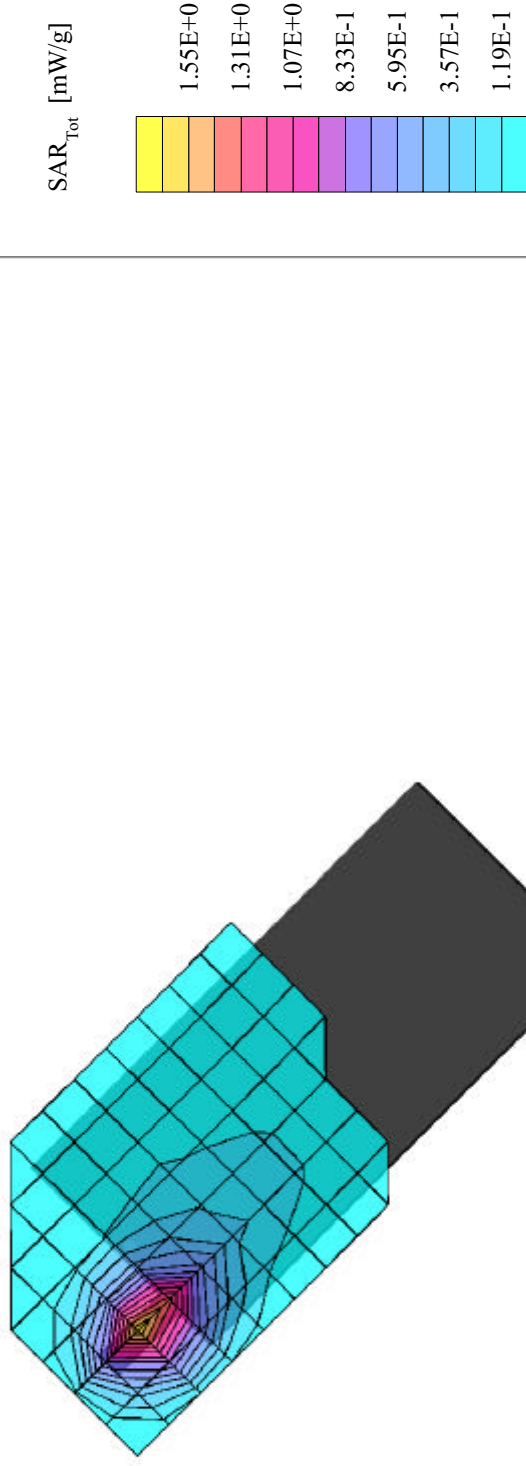

Intermec Technologies Corp. FCC ID: HN2SB555

SAM Phantom; Planar Section

Probe: ET3DV6 - SN1590; ConvF(5.60,5.60,5.60); Crest factor: 1.0

1900 MHz Brain: $\sigma = 1.40$ mho/m $\epsilon_r = 38.2$ $\rho = 1.00$ g/cm³

Z-Axis Extrapolation at Peak SAR Location

Head SAR - Right Ear - Ear/Tilt Position

Handheld Data Terminal with Dual Band CDMA Modem & DSSS WLAN Card

Intermec Model: 700C with Dual-Band External Stubby Antenna (P/N: 805-606-002)

7.2V Lithium-Ion Battery

PCS CDMA Mode

Channel 1175 [1908.75 MHz]

Conducted Power: 23.5 dBm

Ambient Temp. 23.3°C; Fluid Temp. 22.7°C

Date Tested: February 05, 2003

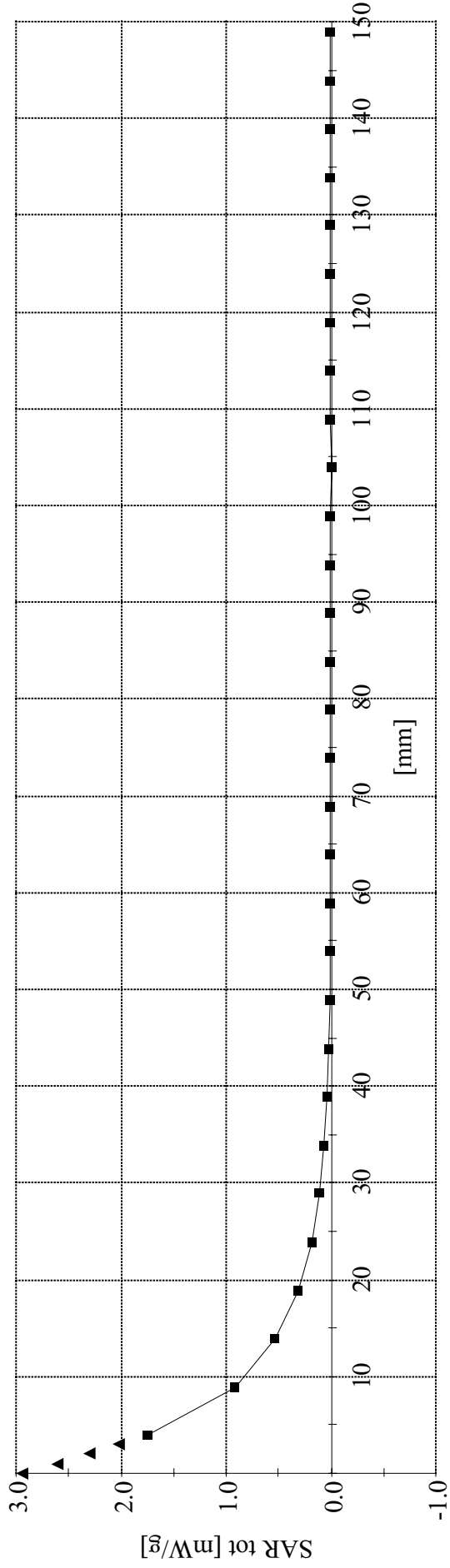

Intermec Technologies Corp. FCC ID: HN2SB555

SAM Phantom; Flat Section; Position: (90°, 295°)
Probe: ET3DV6 - SN1590; ConvF(5.60,5.60,5.60); Crest factor: 1.0
1900 MHz Brain: $\sigma = 1.40$ mho/m $\epsilon_r = 38.2$ $\rho = 1.00$ g/cm³
Coarse: Dx = 15.0, Dy = 15.0, Dz = 10.0
Cube 5x5x7; Powerdrift: -0.20 dB
SAR (1g): 1.22 mW/g, SAR (10g): 0.658 mW/g

Head SAR - Right Ear - Ear/Tilt Position (Co-located Transmit with DSSS WLAN Card)
Handheld Data Terminal with Dual Band CDMA Modem & DSSS WLAN Card
Intermec Model: 700C with Dual-Band External Stubby Antenna (P/N: 805-606-002)
7.2V Lithium-Ion Battery
PCS CDMA Mode
Channel 1175 [1908.75 MHz]
Conducted Power: 23.5 dBm
Ambient Temp: 23.3°C; Fluid Temp: 22.7°C
Date Tested: February 05, 2003

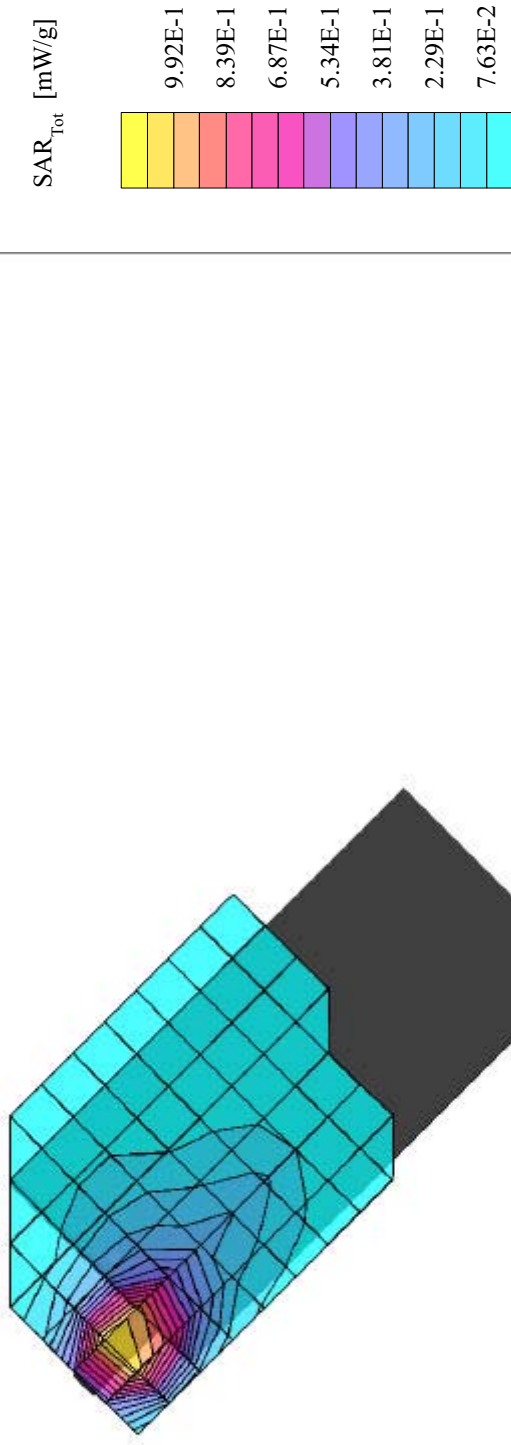

Intermec Technologies Corp. FCC ID: HN2SB555

SAM Phantom; Flat Section; Position: (90°,65°)
Probe: ET3DV6 - SN1590; ConvF(6.90,6.90,6.90); Crest factor: 1.0
835 MHz Brain: $\sigma = 0.93$ mho/m $\epsilon_r = 42.7$ $\rho = 1.00$ g/cm³
Coarse: Dx = 15.0, Dy = 15.0, Dz = 10.0
Cube 5x5x7; Powerdrift: -0.16 dB
SAR (1g): 0.0291 mW/g, SAR (10g): 0.0183 mW/g

Head SAR - Left Ear - Cheek/Touch Position
Handheld Data Terminal with Dual Band CDMA Modem & DSSS WLAN Card
Intermec Model: 700C with Dual-Band External Stubby Antenna (P/N: 805-606-002)
7.2V Lithium-Ion Battery
Cellular CDMA Mode
Channel 363 [835.89 MHz]
Conducted Power: 23.5 dBm
Ambient Temp. 23.3°C; Fluid Temp. 22.4°C
Date Tested: February 05, 2003

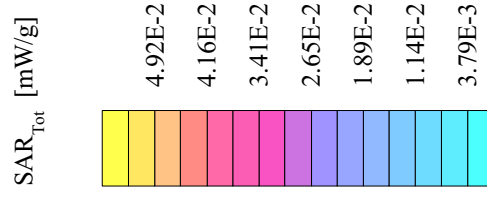
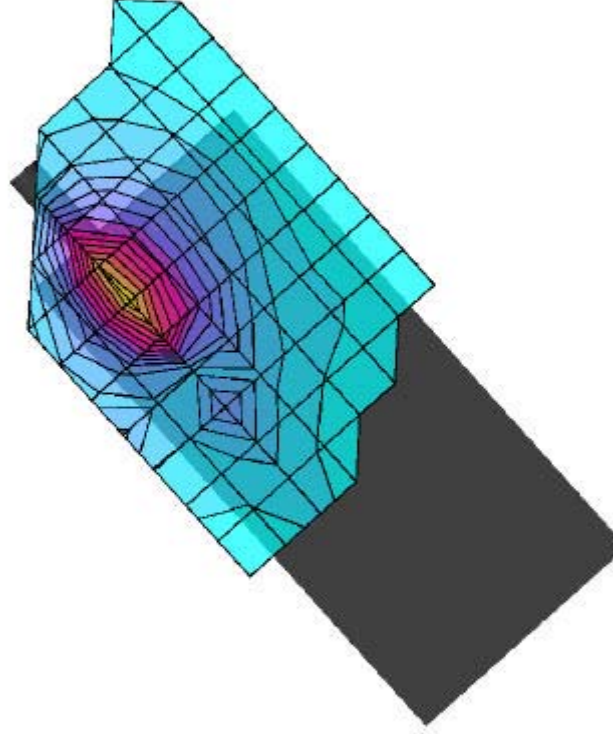

Intermec Technologies Corp. FCC ID: HN2SB555

SAM Phantom; Flat Section; Position: (90°,65°)
Probe: ET3DV6 - SN1590; ConvF(6.90,6.90,6.90); Crest factor: 1.0
835 MHz Brain: $\sigma = 0.93$ mho/m $\epsilon_r = 42.7$ $\rho = 1.00$ g/cm³
Coarse: Dx = 15.0, Dy = 15.0, Dz = 10.0
Cube 5x5x7; Powerdrift: -0.15 dB
SAR (1g): 0.0555 mW/g, SAR (10g): 0.0340 mW/g

Head SAR - Left Ear - Ear/Tilt Position
Handheld Data Terminal with Dual Band CDMA Modem & DSSS WLAN Card
Intermec Model: 700C with Dual-Band External Stubby Antenna (P/N: 805-606-002)
7.2V Lithium-Ion Battery
Cellular CDMA Mode
Channel 363 [835.89 MHz]
Conducted Power: 23.5 dBm
Ambient Temp. 23.3°C; Fluid Temp. 22.4°C
Date Tested: February 05, 2003

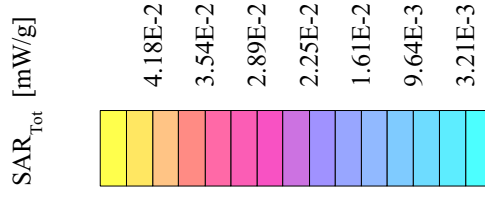
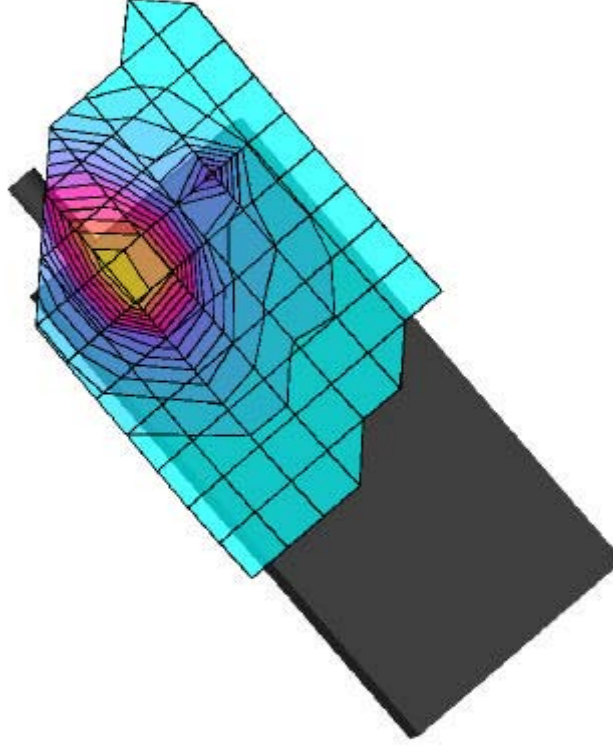

Intermec Technologies Corp. FCC ID: HN2SB555

SAM Phantom; Flat Section; Position: (90°, 295°)
Probe: ET3DV6 - SN1590; ConvF(6.90,6.90,6.90); Crest factor: 1.0
835 MHz Brain: $\sigma = 0.93$ mho/m $\epsilon_r = 42.7$ $\rho = 1.00$ g/cm³
Coarse: Dx = 15.0, Dy = 15.0, Dz = 10.0
Cube 5x5x7; Powerdrift: -0.20 dB
SAR (1g): 0.128 mW/g, SAR (10g): 0.0740 mW/g

Head SAR - Right Ear - Cheek/Touch Position
Handheld Data Terminal with Dual Band CDMA Modem & DSSS WLAN Card
Intermec Model: 700C with Dual-Band External Stubby Antenna (P/N: 805-606-002)
7.2V Lithium-Ion Battery
Cellular CDMA Mode
Channel 363 [835.89 MHz]
Conducted Power: 23.5 dBm
Ambient Temp: 23.3°C; Fluid Temp: 22.4°C
Date Tested: February 05, 2003

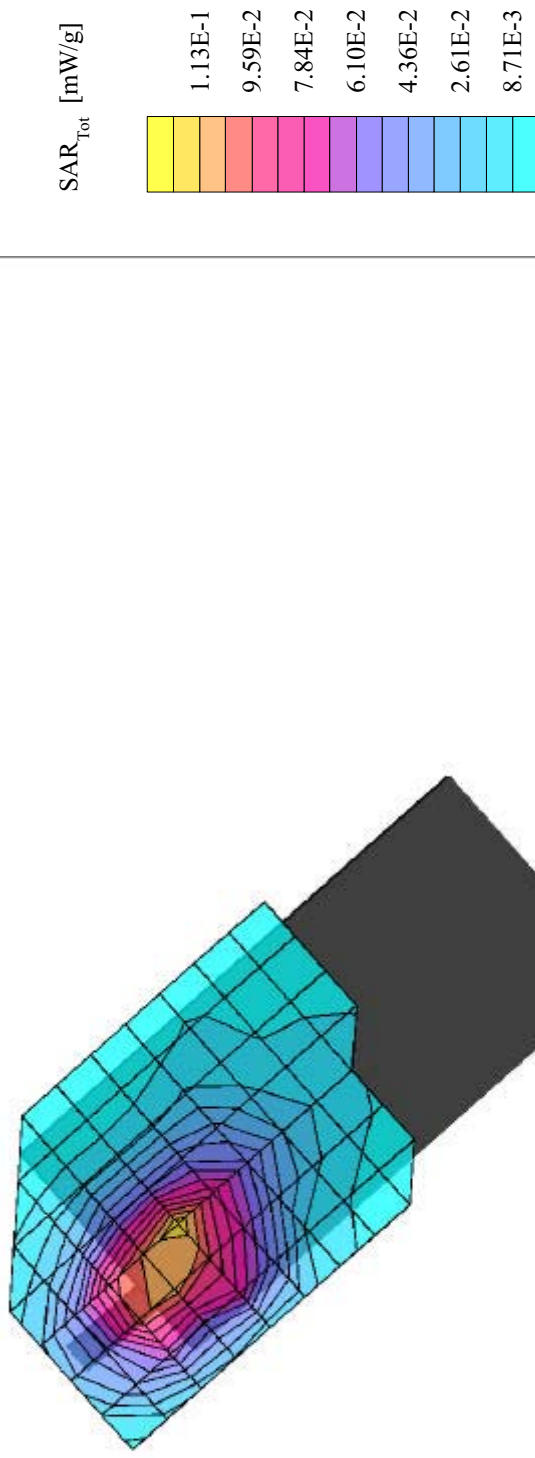

Intermec Technologies Corp. FCC ID: HN2SB555

SAM Phantom; Planar Section

Probe: ET3DV6 - SNI590; ConvF(6.90,6.90,6.90); Crest factor: 1.0

835 MHz Brain: $\sigma = 0.93$ mho/m $\epsilon_r = 42.7$ $\rho = 1.00$ g/cm³

Z-Axis Extrapolation at Peak SAR Location

Head SAR - Right Ear - Cheek/Touch Position

Handheld Data Terminal with Dual Band CDMA Modem & DSSS WLAN Card

Intermec Model: 700C with Dual-Band External Stubby Antenna (P/N: 805-606-002)

7.2V Lithium-Ion Battery

Cellular CDMA Mode

Channel 363 [835.89 MHz]

Conducted Power: 23.5 dBm

Ambient Temp. 23.3°C; Fluid Temp. 22.4°C

Date Tested: February 05, 2003

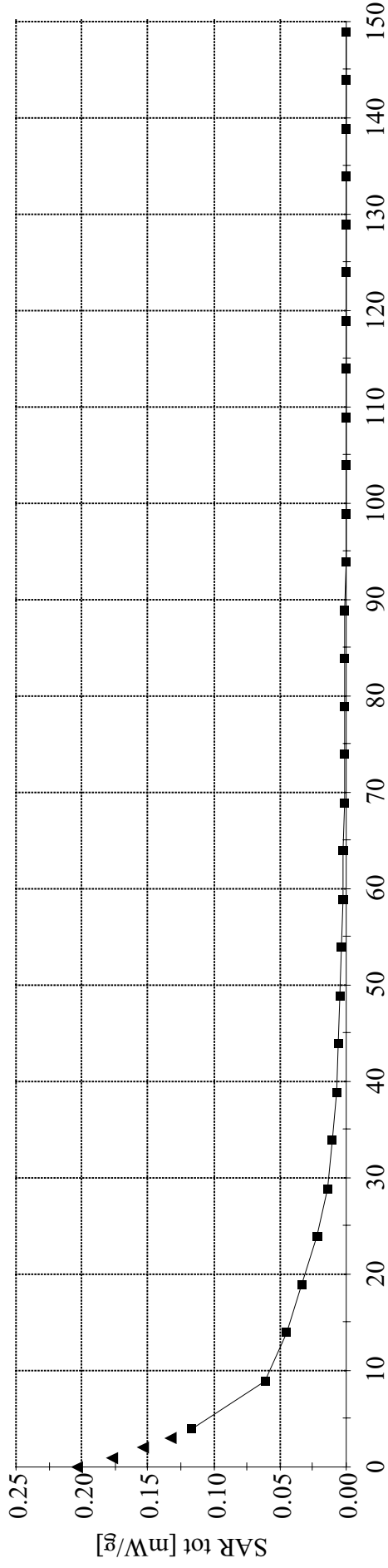

Intermec Technologies Corp. FCC ID: HN2SB555

SAM Phantom; Flat Section; Position: (90°, 295°)
Probe: ET3DV6 - SN1590; ConvF(6.90,6.90,6.90); Crest factor: 1.0
835 MHz Brain: $\sigma = 0.93$ mho/m $\epsilon_r = 42.7$ $\rho = 1.00$ g/cm³
Coarse: Dx = 15.0, Dy = 15.0, Dz = 10.0
Cube 5x5x7; Powerdrift: -0.20 dB
SAR (1g): 0.0921 mW/g, SAR (10g): 0.0609 mW/g

Head SAR - Right Ear - Ear/Tilt Position
Handheld Data Terminal with Dual Band CDMA Modem & DSSS WLAN Card
Intermec Model: 700C with Dual-Band External Stubby Antenna (P/N: 805-606-002)
7.2V Lithium-Ion Battery
Cellular CDMA Mode
Channel 363 [835.89 MHz]
Conducted Power: 23.5 dBm
Ambient Temp. 23.3°C; Fluid Temp. 22.4°C
Date Tested: February 05, 2003

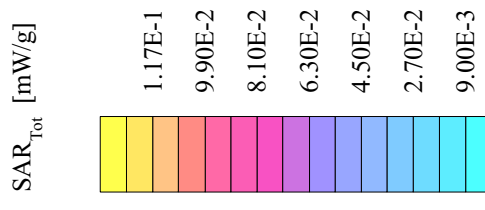
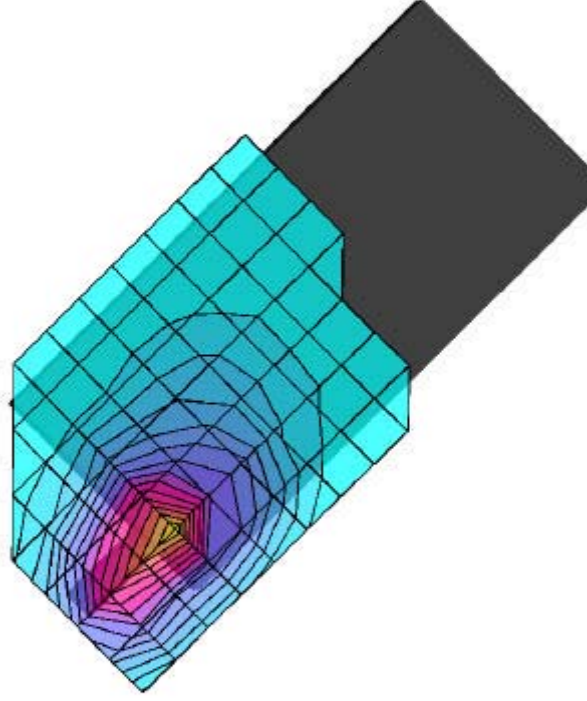

Intermec Technologies Corp. FCC ID: HN2SB555

SAM Phantom; Flat Section; Position: (90°, 295°)
Probe: ET3DV6 - SN1590; ConvF(6.90,6.90,6.90); Crest factor: 1.0
835 MHz Brain: $\sigma = 0.93$ mho/m $\epsilon_r = 42.7$ $\rho = 1.00$ g/cm³
Coarse: Dx = 15.0, Dy = 15.0, Dz = 10.0
Cube 5x5x7; Powerdrift: -0.02 dB
SAR (1g): 0.109 mW/g, SAR (10g): 0.0627 mW/g

Head SAR - Right Ear - Cheek/Touch Position (Co-located Transmit with DSSS WLAN Card)
Handheld Data Terminal with Dual Band CDMA Modem & DSSS WLAN Card
Intermec Model: 700C with Dual-Band External Stubby Antenna (P/N: 805-606-002)
7.2V Lithium-Ion Battery
Cellular CDMA Mode
Channel 363 [835.89 MHz]
Conducted Power: 23.5 dBm
Ambient Temp: 23.3°C; Fluid Temp: 22.4°C
Date Tested: February 05, 2003

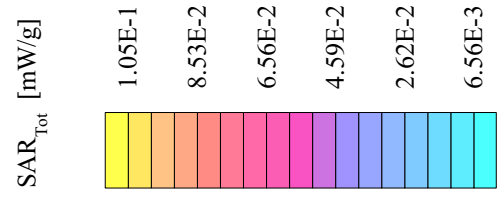
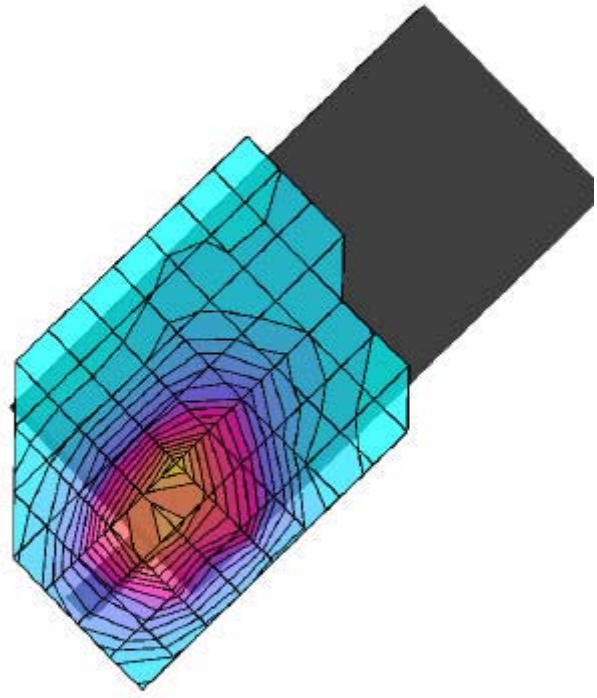

Intermec Technologies Corp. FCC ID: HN2SB555

SAM Phantom; Flat Section; Position: (270°,270°)
Probe: ET3DV6 - SN1590; ConvF(5.30,5.30,5.30); Crest factor: 1.0
1900 MHz Muscle: $\sigma = 1.51 \text{ mho/m}$, $\epsilon_r = 52.3$, $\rho = 1.00 \text{ g/cm}^3$
Coarse: Dx = 15.0, Dy = 15.0, Dz = 10.0
Cube 5x5x7; Powerdrift: -0.11 dB
SAR (1g): 0.407 mW/g, SAR (10g): 0.242 mW/g

Body SAR - 0.0cm Separation Distance - Back of EUT
Handheld Data Terminal with Dual-Band CDMA Modem & DSSS WLAN Card
Intermec Model: 700C with Single-Band External Stubby Antenna (P/N: 805-606-004)
7.2V Lithium-Ion Battery
PCS CDMA Mode
Channel 600 [1880.00 MHz]
Conducted Power: 23.5 dBm
Ambient Temp. 23.5°C; Fluid Temp. 23.2°C
Date Tested: February 06, 2003

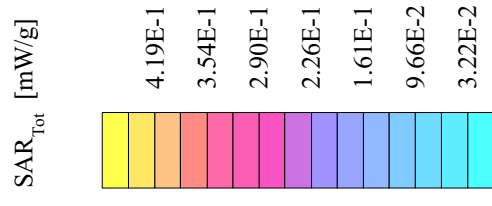
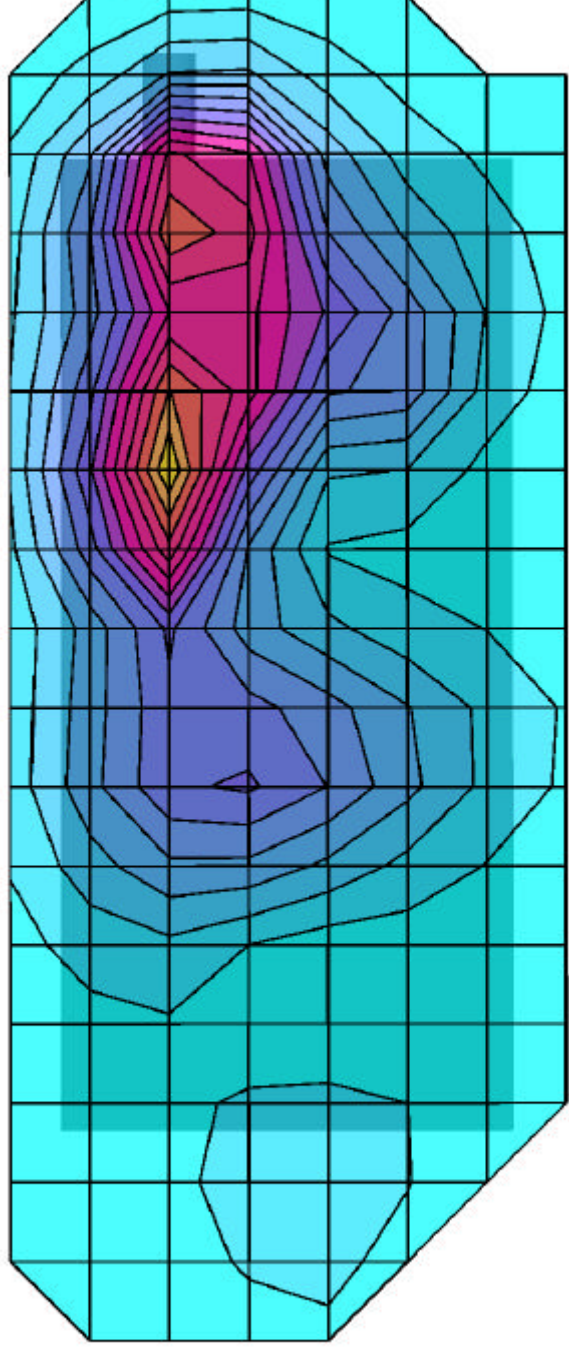

Intermec Technologies Corp. FCC ID: HN2SB555

SAM Phantom; Flat Section; Position: (270°,270°)
Probe: ET3DV6 - SN1590; ConvF(5.30,5.30,5.30); Crest factor: 1.0
1900 MHz Muscle: $\sigma = 1.51 \text{ mho/m}$, $\epsilon_r = 52.3$, $\rho = 1.00 \text{ g/cm}^3$
Coarse: Dx = 15.0, Dy = 15.0, Dz = 10.0
Cube 5x5x7; Powerdrift: 0.07 dB
SAR (1g): 0.836 mW/g, SAR (10g): 0.465 mW/g

Body SAR - 0.0cm Separation Distance - Right Side of EUT (Antenna Side)
Handheld Data Terminal with Dual-Band CDMA Modem & DSSS WLAN Card
Intermec Model: 700C with Single-Band External Stubby Antenna (P/N: 805-606-004)
7.2V Lithium-Ion Battery
PCS CDMA Mode
Channel 600 [1880.00 MHz]
Conducted Power: 23.5 dBm
Ambient Temp. 23.5°C; Fluid Temp. 23.2°C
Date Tested: February 06, 2003

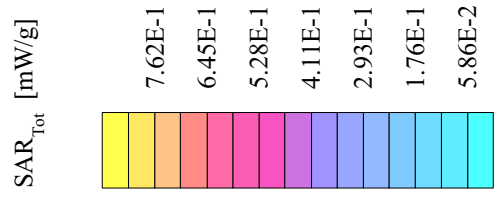
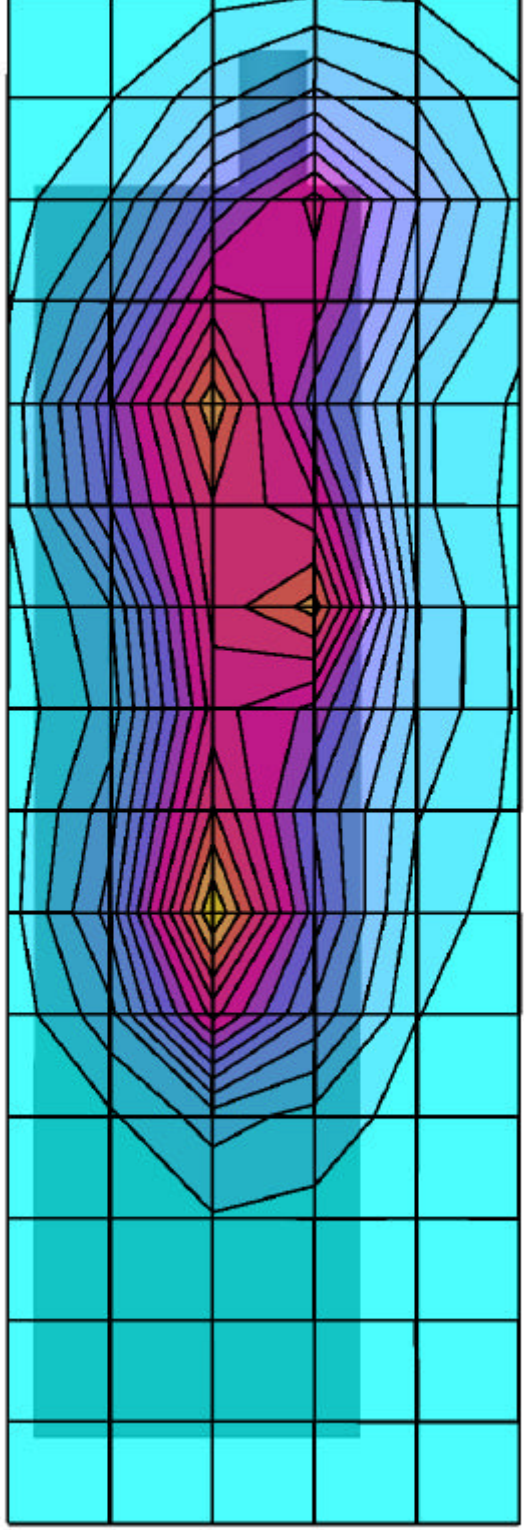

Intermec Technologies Corp. FCC ID: HN2SB555

SAM Phantom; Flat Section; Position: (270°,270°)
Probe: ET3DV6 - SN1590; ConvF(5.30,5.30,5.30); Crest factor: 1.0
1900 MHz Muscle: $\sigma = 1.51 \text{ mho/m}$, $\epsilon_r = 52.3$, $\rho = 1.00 \text{ g/cm}^3$
Coarse: Dx = 15.0, Dy = 15.0, Dz = 10.0
Cube 5x5x7; Powerdrift: 0.05 dB
SAR (1g): 1.00 mW/g, SAR (10g): 0.564 mW/g

Body SAR - 0.0cm Separation Distance - Right Side of EUT (Antenna Side)
Handheld Data Terminal with Dual-Band CDMA Modem & DSSS WLAN Card
Intermec Model: 700C with Single-Band External Stubby Antenna (P/N: 805-606-004)
7.2V Lithium-Ion Battery
PCS CDMA Mode
Channel 25 [1851.25 MHz]
Conducted Power: 23.5 dBm
Ambient Temp. 23.5°C; Fluid Temp. 23.2°C
Date Tested: February 06, 2003

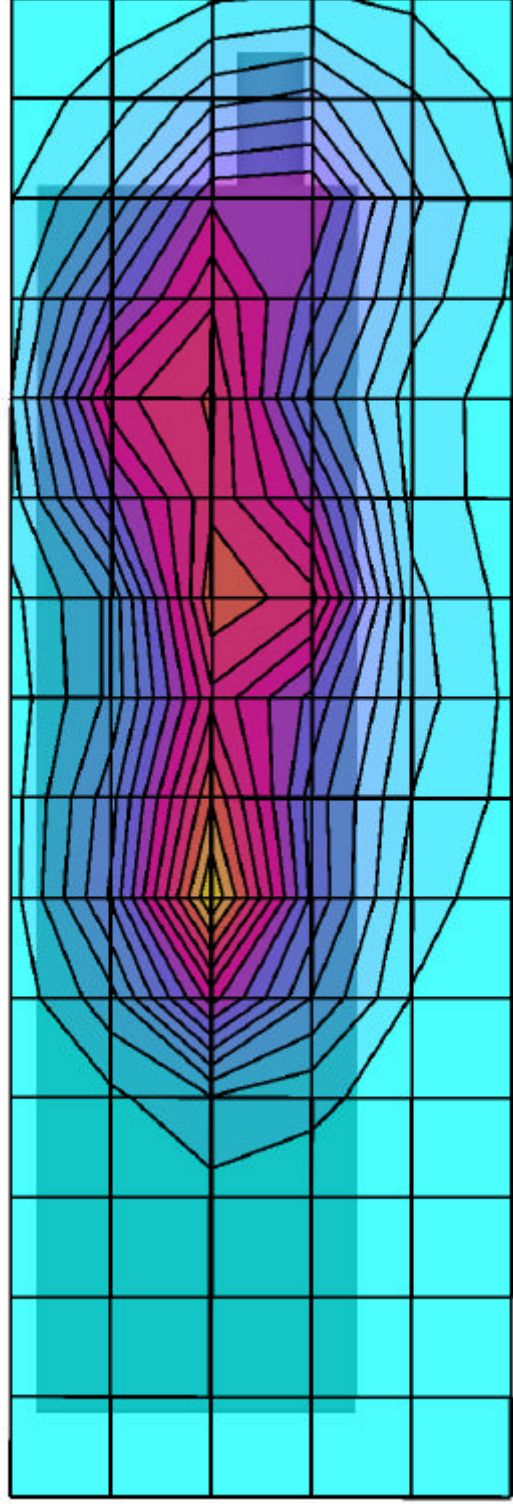

Intermec Technologies Corp. FCC ID: HN2SB555

SAM Phantom; Planar Section

Probe: ET3DV6 - SN1590; ConvF(5.30,5.30,5.30); Crest factor: 1.0
1900 MHz Muscle: $\sigma = 1.51 \text{ mho/m}$ $\epsilon_r = 52.3$ $\rho = 1.00 \text{ g/cm}^3$

Z-Axis Extrapolation at Peak SAR Location

Body SAR - 0.0cm Separation Distance - Right Side of EUT (Antenna Side)
Handheld Data Terminal with Dual-Band CDMA Modem & DSSS WLAN Card
Intermec Model: 700C with Single-Band External Stubby Antenna (P/N: 805-606-004)

7.2V Lithium-Ion Battery

PCS CDMA Mode

Channel 25 [1851.25 MHz]

Conducted Power: 23.5 dBm

Ambient Temp. 23.5°C; Fluid Temp. 23.2°C

Date Tested: February 06, 2003

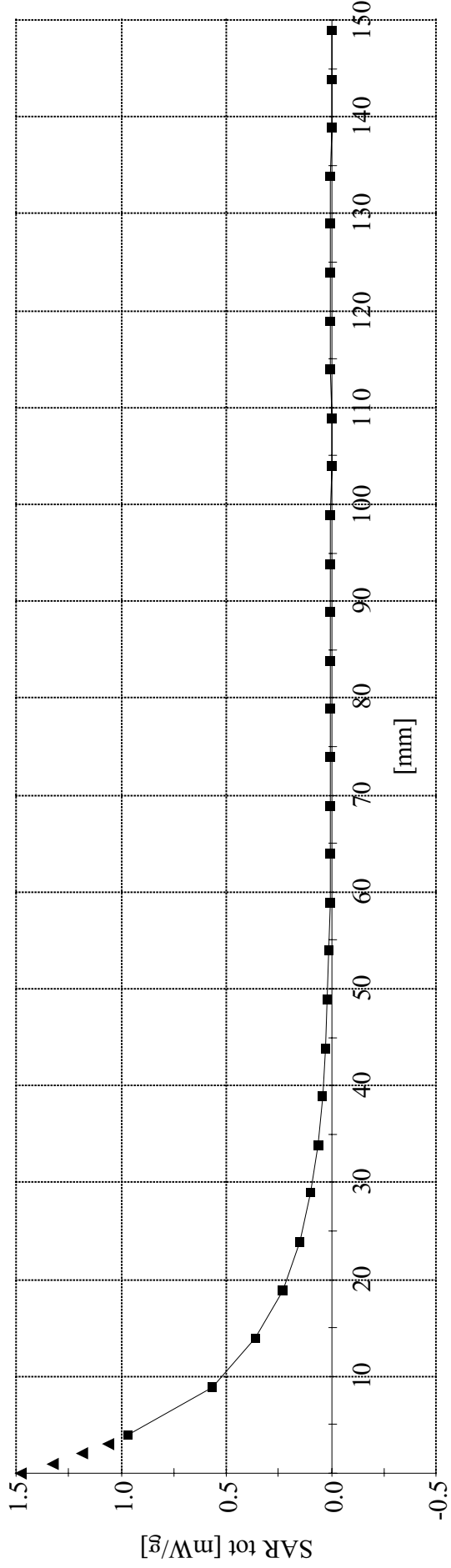

Intermec Technologies Corp. FCC ID: HN2SB555

SAM Phantom; Flat Section; Position: (270°,270°)
Probe: ET3DV6 - SN1590; ConvF(5.30,5.30,5.30); Crest factor: 1.0
1900 MHz Muscle: $\sigma = 1.51 \text{ mho/m}$, $\epsilon_r = 52.3$, $\rho = 1.00 \text{ g/cm}^3$
Coarse: Dx = 15.0, Dy = 15.0, Dz = 10.0
Cube 5x5x7; Powerdrift: -0.07 dB
SAR (1g): 0.553 mW/g, SAR (10g): 0.307 mW/g

Body SAR - 0.0cm Separation Distance - Right Side of EUT (Antenna Side)
Handheld Data Terminal with Dual-Band CDMA Modem & DSSS WLAN Card
Intermec Model: 700C with Single-Band External Stubby Antenna (P/N: 805-606-004)
7.2V Lithium-Ion Battery
PCS CDMA Mode
Channel 1175 [1908.75 MHz]
Conducted Power: 23.5 dBm
Ambient Temp. 23.5°C; Fluid Temp. 23.2°C
Date Tested: February 06, 2003

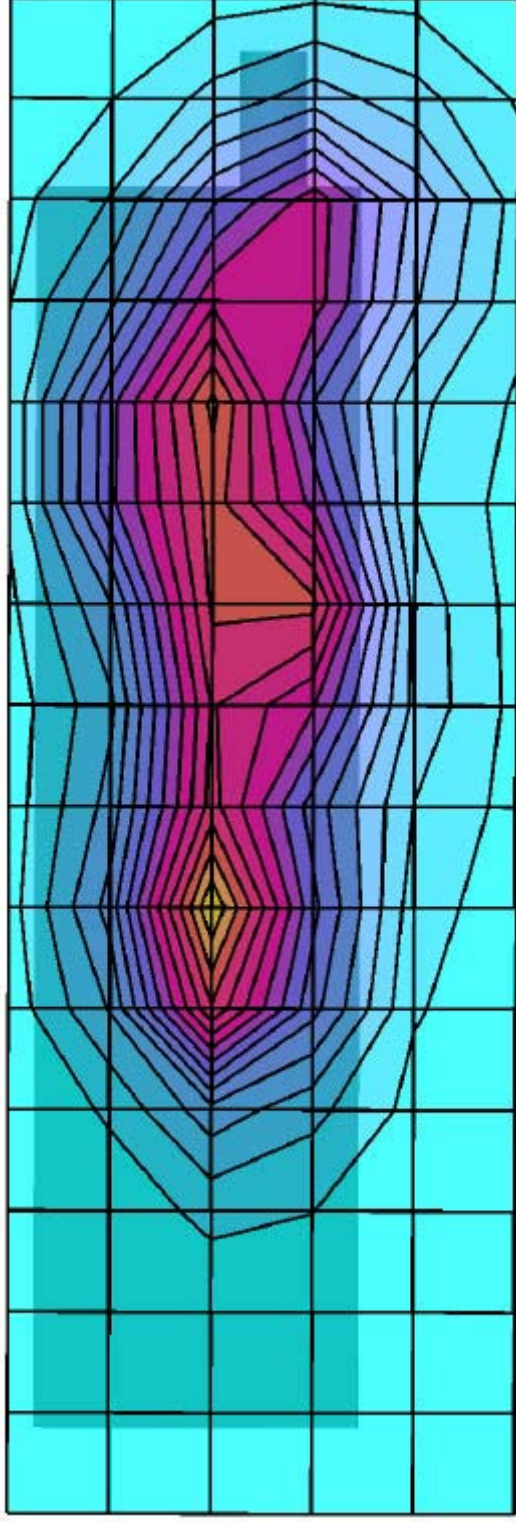

Intermec Technologies Corp. FCC ID: HN2SB555

SAM Phantom; Flat Section; Position: (90°, 180°)
Probe: ET3DV6 - SN1590; ConvF(5.30,5.30,5.30); Crest factor: 1.0
1900 MHz Muscle: $\sigma = 1.51 \text{ mho/m}$, $\epsilon_r = 52.3$, $\rho = 1.00 \text{ g/cm}^3$
Coarse: Dx = 15.0, Dy = 15.0, Dz = 10.0
Cube 5x5x7; Powerdrift: 0.08 dB
SAR (1g): 0.159 mW/g, SAR (10g): 0.0969 mW/g

Body SAR - 1.5cm Separation Distance - Top End of EUT (Antenna End)
Handheld Data Terminal with Dual-Band CDMA Modem & DSSS WLAN Card
Intermec Model: 700C with Single-Band External Stubby Antenna (P/N: 805-606-004)
7.2V Lithium-Ion Battery
PCS CDMA Mode
Channel 600 [1880.00 MHz]
Conducted Power: 23.5 dBm
Ambient Temp. 23.5°C; Fluid Temp. 23.2°C
Date Tested: February 06, 2003

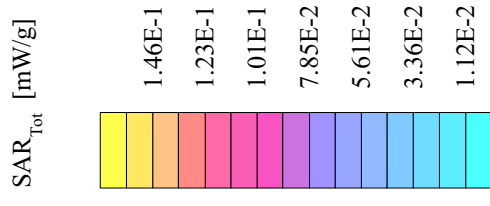
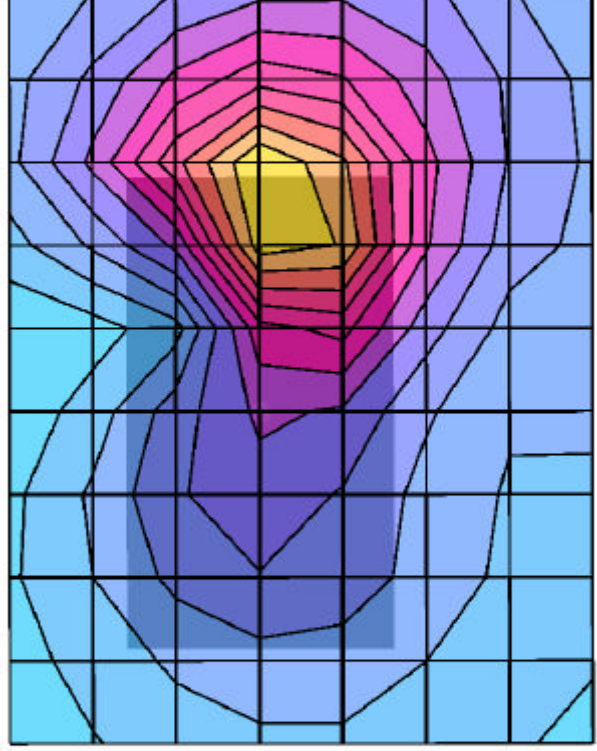

Intermec Technologies Corp. FCC ID: HN2SB555

SAM Phantom; Flat Section; Position: (270°, 270°)
Probe: ET3DV6 - SN1590; ConvF(5.30,5.30,5.30); Crest factor: 1.0
1900 MHz Muscle: $\sigma = 1.51 \text{ mho/m}$, $\epsilon_r = 52.3$, $\rho = 1.00 \text{ g/cm}^3$
Coarse: Dx = 15.0, Dy = 15.0, Dz = 10.0
Cube 5x5x7; Powerdrift: -0.12 dB
SAR (1g): 0.971 mW/g, SAR (10g): 0.546 mW/g

Body SAR - 0.0cm Separation Distance - Right Side of EUT (Antenna Side)
Co-located Transmit with DSSS WLAN Card
Handheld Data Terminal with Dual-Band CDMA Modem & DSSS WLAN Card
Intermec Model: 700C with Single-Band External Stubby Antenna (P/N: 805-606-004)
7.2V Lithium-Ion Battery
PCS CDMA Mode
Channel 25 [1851.25 MHz]
Conducted Power: 23.5 dBm
Ambient Temp. 23.5°C; Fluid Temp. 23.2°C
Date Tested: February 06, 2003

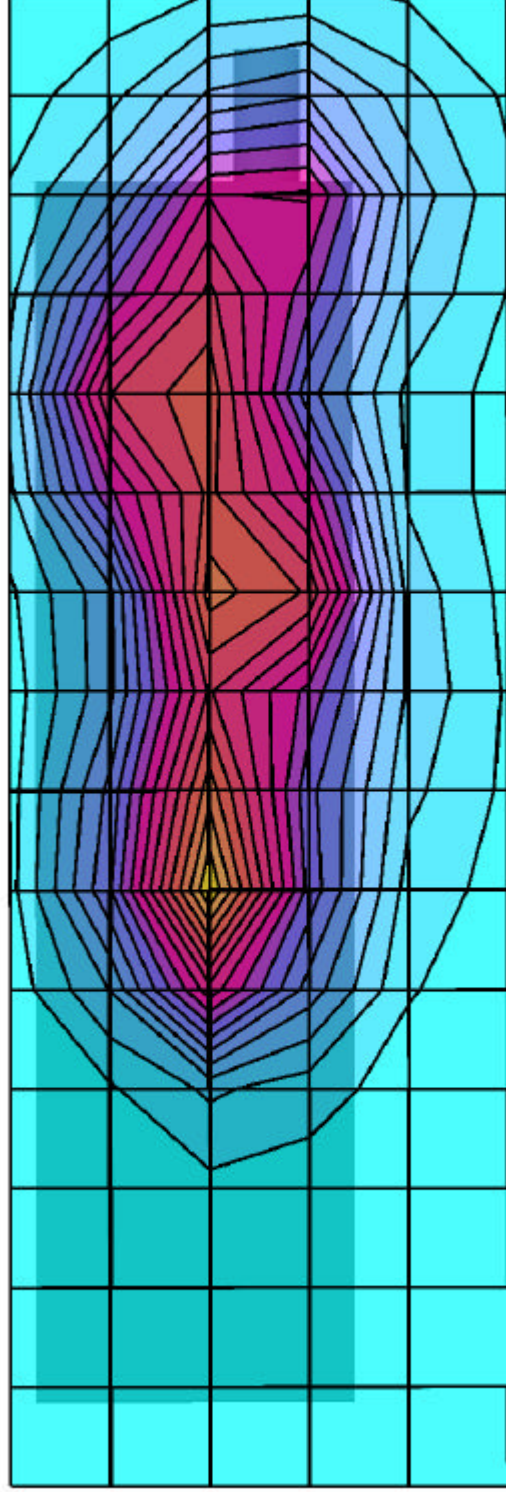

Intermec Technologies Corp. FCC ID: HN2SB555

SAM Phantom; Flat Section; Position: (270°,270°)
Probe: ET3DV6 - SN1590; ConvF(5.30,5.30,5.30); Crest factor: 1.0
1900 MHz Muscle: $\sigma = 1.51 \text{ mho/m}$ $\epsilon_r = 52.3$ $\rho = 1.00 \text{ g/cm}^3$
Coarse: Dx = 15.0, Dy = 15.0, Dz = 10.0
Cube 5x5x7; Powerdrift: -0.11 dB
SAR (1g): 0.422 mW/g, SAR (10g): 0.248 mW/g

Body SAR - 0.0cm Separation Distance - Back of EUT
Handheld Data Terminal with Dual-Band CDMA Modem & DSSS WLAN Card
Intermec Model: 700C with Dual-Band External Stubby Antenna (P/N: 805-606-002)
7.2V Lithium-Ion Battery
PCS CDMA Mode
Channel 600 [1880.00 MHz]
Conducted Power: 23.5 dBm
Ambient Temp. 23.5°C; Fluid Temp. 23.2°C
Date Tested: February 06, 2003

