

Getting Started Guide

P/N x-xxxx49-01



Sabre 1555 Laser Scanner & RFID Reader/Programmer

Guía de Iniciación

Guida Introduttiva

Guide de Démarrage

Guia de Iniciação

Anleitung für Einsteiger



Intermec

A **UNOVA** Company

Introduction

Use this Getting Started Guide to set up the Sabre 1555 laser scanner and RFID reader/ programmer for most terminal connections and symbologies. If necessary, use the EasySet setup software or Installation Manual for additional configuration possibilities and terminal connections.

Basic setup

Configuración básica
Configuration de base
Grundkonfiguration
Configurazione di base

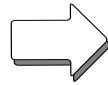

Getting Started Guide

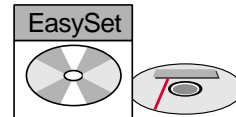
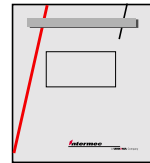

EasySet setup software

Full setup

Configuración completa
Configuration complète
Vollständige Konfiguration
Configurazione completa
Configuração completa

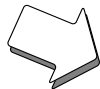
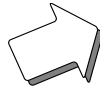

Installation Manual

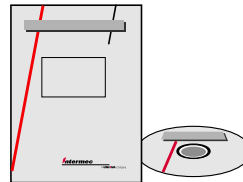

(on the CD-ROM or to order)

Operating

Uso
Utilisation
Betrieb
Utilizzazione

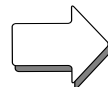

Operator's Guide

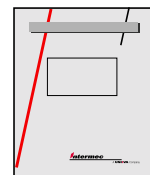

Interactive Programming

(need translations to other languages)

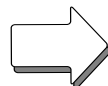

Interactive Programming Guide

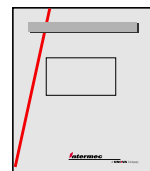

Connect scanner cable (standard version shown)

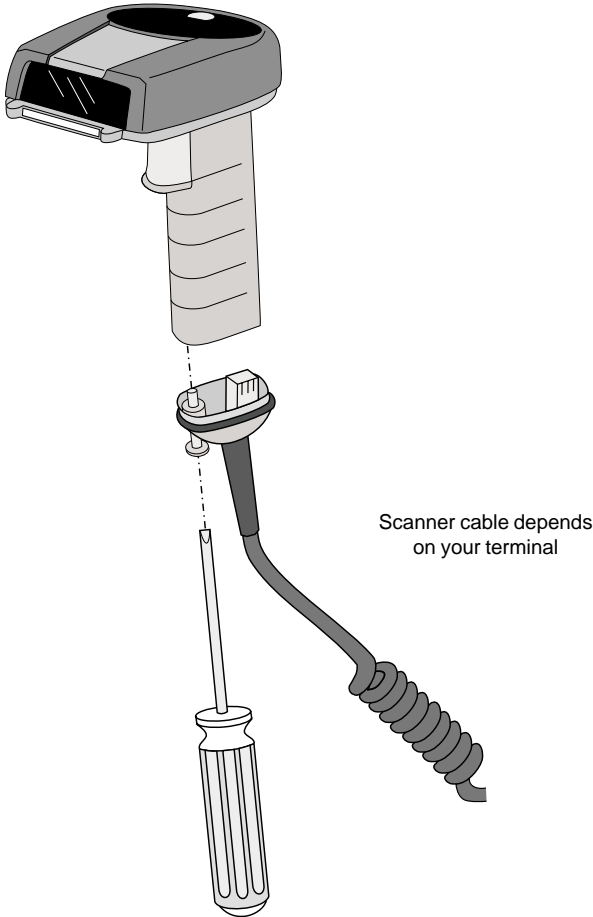

Cables
Accessories

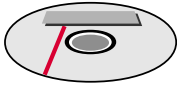

RFID reader/programmer operation

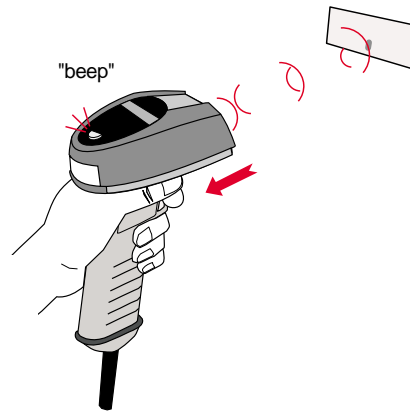

RFID reader/programmer reading distance

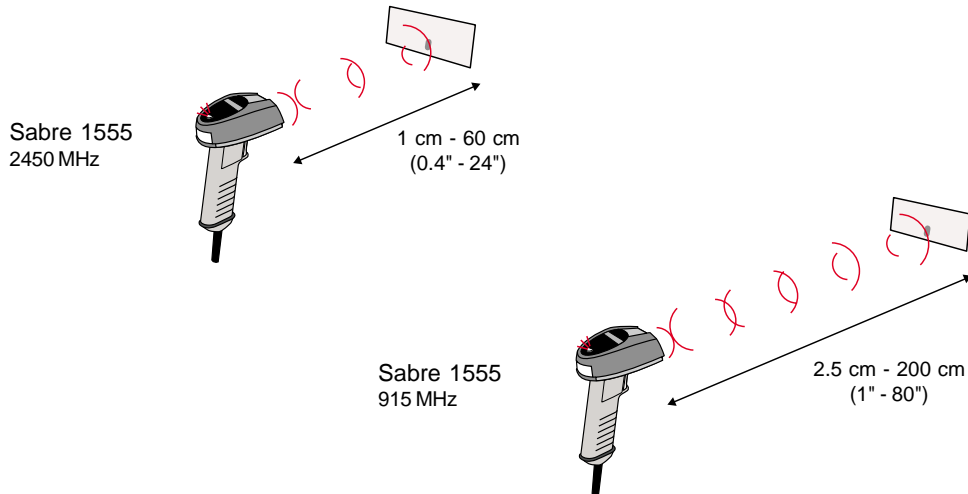

Scanner operation

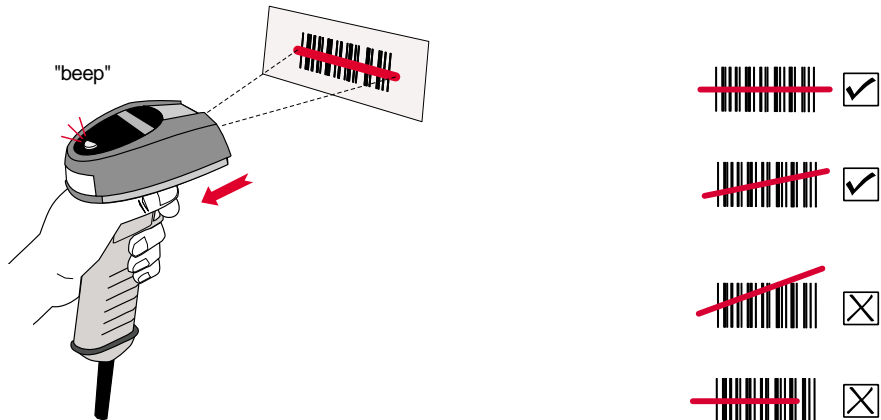

Scanner reading distance

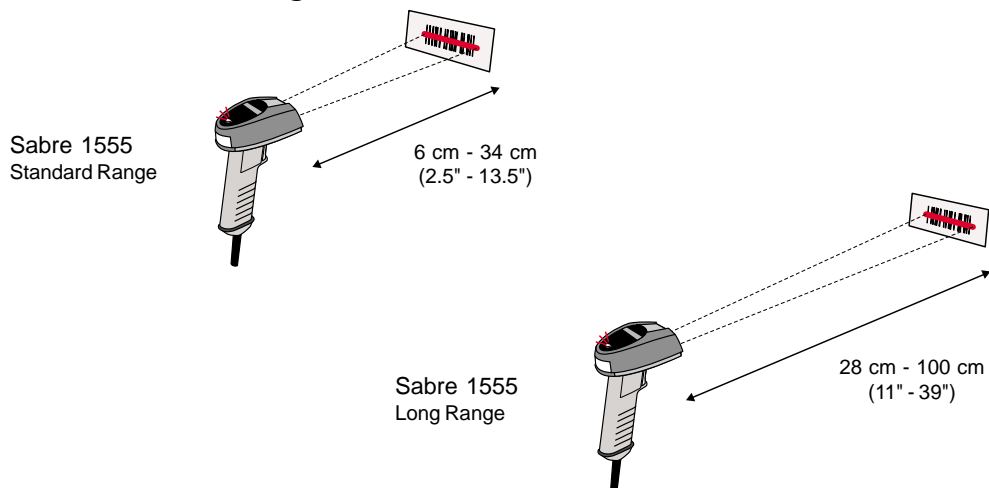

RS-232 C

- ① System power OFF

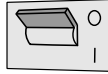

- ② Connect cable



Direct RS-232 C cable
P/N 3-604032-00

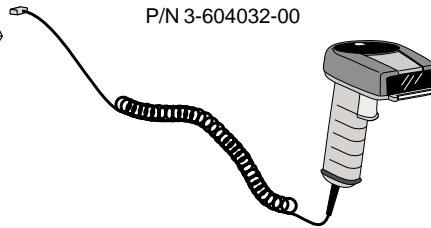

- ③ Scanner power ON

- ④ System power ON



- ⑤ Select standard RS-232 C
(PC serial port compatible)

9600 baud, 7 data bits, even parity, 2 stop bits
postamble = carriage return + line feed



6 Customize parameters (optional)

(*) = default value

9600 baud (*)



19200 baud

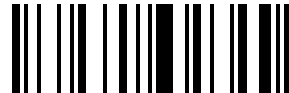

7 data bits (*)

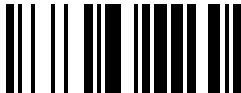

8 data bits



Even parity (*)

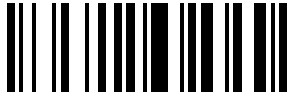

Odd parity



No parity



Postamble = Carriage Return + Line Feed (*)



Postamble = Carriage Return

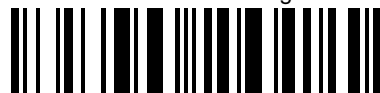

Postamble = none



RS-232 TTL

- ① System power OFF

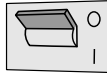

- ② Connect cable

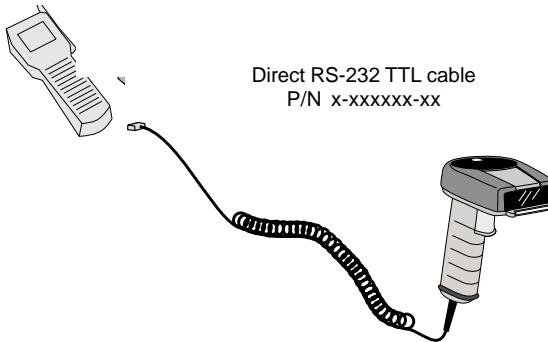

- ③ Scanner power ON

- ④ System power ON

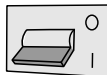

- ⑤ Select RS-232 TTL

9600 baud, 7 data bits, even parity, 2 stop bits
postamble = carriage return + line feed



6 Customize parameters (optional)

(*) = default value

9600 baud (*)



19200 baud

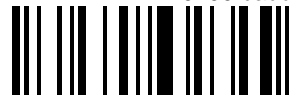

7 data bits (*)



8 data bits



Even parity (*)



Odd parity

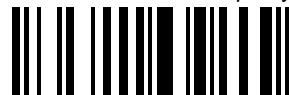

No parity



Postamble = Carriage Return + Line Feed (*)



Postamble = Carriage Return

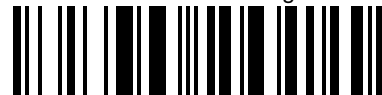

Postamble = none



Universal Serial Bus (USB)

1 System power OFF

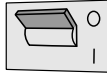

2 Connect cable

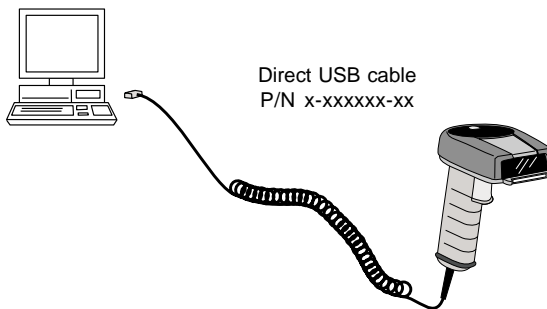

3 Scanner power ON

4 System power ON



5 Select standard USB
(PC serial port compatible)

9600 baud, 7 data bits, even parity, 2 stop bits
postamble = carriage return + line feed



⑥ Customize parameters (optional)

(*) = default value

Intermec representative needs to supply USB symbologies when the symbols are available.

Symbology

❶ Disable all symbologies



❷ Select symbology

Code 39

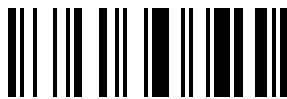

UPC-A, UPC-E, EAN-8, EAN-13
(UPC-A -> EAN-13)



Code 128 / EAN 128



UPC-A, UPC-E, EAN-8, EAN-13
(UPC-A -> UPC-A)



❸ Test

Code 39



CODE-39

UPC-A



0 01234 50000 7

Code 128



CODE-128

EAN 13



1234567890128

Reset

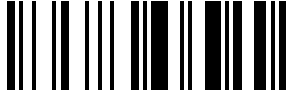

Online setup

- 1** System power OFF

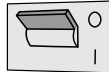

- 2** Connect RS-232 C cable
(P/N 3-604032-00)

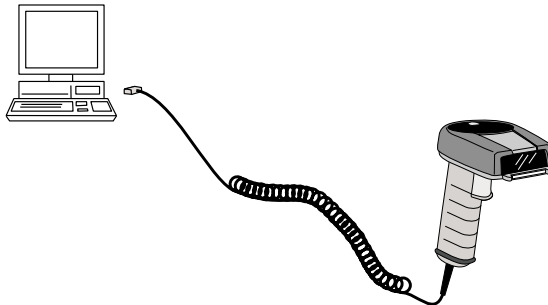

- 3** Scanner power ON

- 4** System power ON

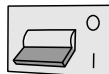

- 5** Scan EasySet setup code

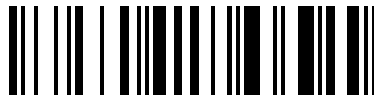

- 6** Start EasySet software



Laser warnings

The Sabre 1555 has a maximum laser output of 1mW at 630-680 nm and complies with the following safety standards:

USA: CDRH - Class II Laser Product (CFR 21 Subpart J)
IEC 825-1 EN 60825-1 - Class 2 Laser Product

Fix these warning labels onto the product if they are not already present.

Collez les étiquettes d'avertissement sur votre produit. Cole as etiquetas de precaução no equipamento.

Bringen Sie Warnetiketten auf dem Produkt an.

Un'etichetta di avviso per il laser è da applicare sul prodotto.

Fije la etiqueta de advertencia en el producto.

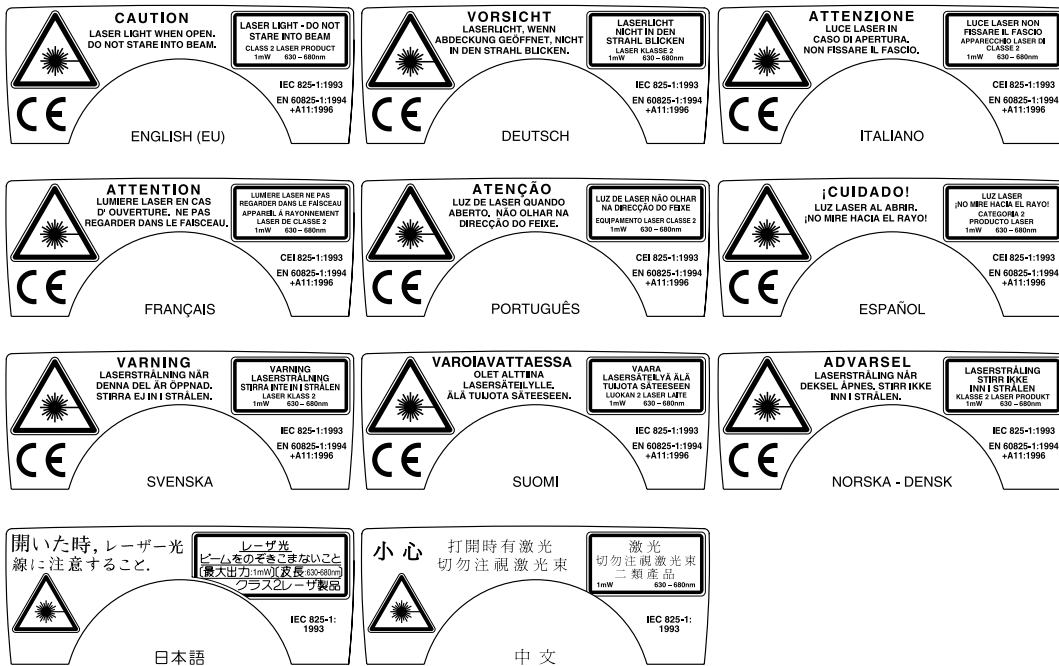
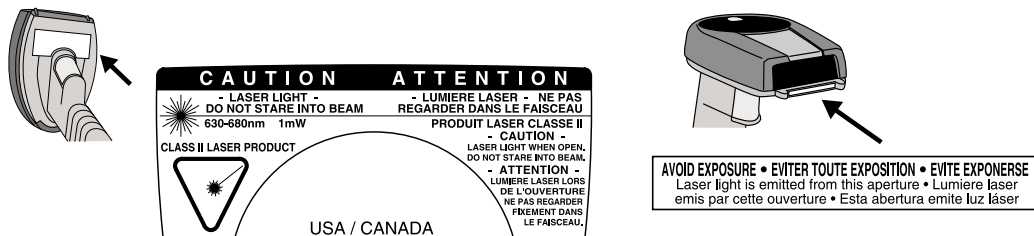

CAUTION – Use of controls or adjustments or performance of procedures other than those specified herein result in hazardous laser light.

VORSICHT – Bei einer anders als hier beschriebenen Verwendung der Bedienelemente oder Veränderungen oder einer anderen Ausführung der Arbeitsabläufe entsteht gefährliches Laserlicht.

ATTENTION – L'utilisation de contrôles/commandes ou de réglages ou de procédures autres que ceux précisés par le présent document provoquent une lumière laser dangereuse.

Regulatory statements

USA & Canada: This Class B digital apparatus meets all requirements of the Canadian Interference-Causing Equipment Regulations.

This device requires a radio license, unless it is used totally inside of a building. (The user must obtain this license.)

Cet appareil numérique de la classe B respecte toutes les exigences du Règlement sur le matériel brouilleur du Canada. Cet appareil exige une licence radio à moins d'être entièrement installé dans un bâtiment. (L'utilisateur doit obtenir cette licence.)

This device complies with Part 15 of the FCC Rules and with RSS-210 of Industry Canada. Operation is subject to the following two conditions: (1) this device may not cause harmful interference, and (2) this device must accept any interference received, including interference that may cause undesired operation.

This equipment is intended for operation in a commercial environment, in compliance with the requirements for a Class A digital device, pursuant to Part 15 of the FCC Rules, and it must not be used in a residential environment. It generates, uses, and can radiate radio frequency energy. If not installed and used in accordance with the instruction manual, it may cause interference to radio communications. If this equipment causes interference, the user will be required to correct the interference at the user's own expense.

To maintain compliance with the FCC Rules, the input/output (I/O) cables that interconnect between the device and any peripheral (such as a reader) must be as specified by Intermec.

Operator Warning: FCC regulations limit exposure to radio frequency (RF) radiation. To comply with these regulations, the operator of this device must maintain a distance of at least 4 cm (2 inches) from the front part of the device to any bystanders under normal operating conditions. **While the device is on, the operator's body and parts of the body, such as eyes, hands, or head, must be 4 cm (2 inches) or farther from the front of the device.**

This device is UL listed (UL 1950/C22.2 No. 950) for safety when powered by a host system or by one of the following external Intermec power supplies: Catalog No. and P/N 043230 ~100V, 50/60 Hz or Catalog No. and P/N 047793 ~120V, 60 Hz. The device is CSA certified.



Intermec hereby declares that the Sabre 1555 has been tested and found compliant with the below listed standards as required by the EMC Directive 89/336/EEC as amended by 92/31/EEC and by the Low Voltage Directive 73/23/EEC as amended by 93/68/EEC: EN55022, EN50082-2, EN60950

This device is TÜV GS licensed (EN 60950 and EN 60825-1) for safety when powered by a host system or by the following external Intermec power supply: Catalog No. and P/N 047795 ~230V, 50 Hz. For 240V applications use the power supply: Catalog No. 047794 (P/N 5014UK) ~240V, 50 Hz.

Australia-New Zealand: This equipment has been tested and found to conform to the Australian EMC framework concerning Class B digital devices, prescribed by the Australian and New Zealand standard AS/NZS 3548.  N309

Mexico: Este equipo cumple con la certificación NOM.

The information contained in this document is for informational purposes only and is subject to change without notice. No part of this document may be copied or reproduced in any manner without the prior written permission of Intermec Technologies Corporation.

Sabre products are covered by patents issued or pending in the USA and other countries.

The word Intermec, the Intermec logo, Sabre and EasySet are either trademarks or registered trademarks of Intermec.

Throughout this document, trademarked names may be used. Rather than put a trademark (™ or ®) symbol in every occurrence of a trademarked name, we state that we are using the names only in an editorial fashion, and to the benefit of the trademark owner, with no intention of infringement.



Caution

Changes or modifications not expressly approved by Intermec could void the user's authority to operate this equipment.

North America / Asia Pacific / Latin America • 6001 36th Avenue West, PO Box 4280, Everett, WA 98203-9280
Tel: +1 425 348 2600 • Fax: +1 425 348 2833 • U.S. service and technical support, tel: 1.800.755.5505 • Canadian service and technical support, tel: 1.800.688.7043

Europe / Middle East / Africa • Sovereign House, Vastern Road, Reading RG1 8BT, England
Tel: +44 118 987 9420 • Fax: +44 118 987 9416

Internet: <http://www.intermec.com>

E-mail: info@intermec.com

Support: <http://datacapture.intermec.com>

