



A Test Lab Techno Corp.

Changan Lab : No. 140 -1, Changan Street, Bade City, Taoyuan County, Taiwan R.O.C.
Tel : 886-3-271-0188 / Fax : 886-3-271-0190

P22 & P24 Test Report



Test Report No.	: 0809FR14
Applicant	: Acer Incorporated
Manufacturer	: Quanta Computer Inc.
Model Name	: Notebook PC
Trade Mark	: acer
Model Number	: ZG5, Aspire One
FCC ID	: HLZZG53GQ
Dates of Test	: Aug. 21 ~ Sep. 01, 2008
Test Specification	: 47 CFR Part 22H, 24E & and 24, ANSI/TIA-603-C-2004
Location of Test Lab.	: Chang-an Lab.

1. The test operations have to be performed with cautious behavior, the test results are as attached.
2. The test results are under chamber environment of A Test Lab Techno Corp. A Test Lab Techno Corp. does not assume responsibility for any conclusions and generalizations drawn from the test results with regard to other specimens or samples.
3. The measurement report has to be written approval of A Test Lab Techno Corp. It may only be reproduced or published in full.

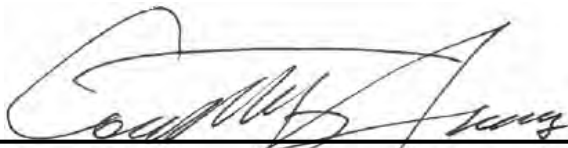
Country Huang 20090122

Measurement Center Manager

John Cheng 20090122

Testing Engineer



Contents

1. General Information	3
2. Test Configuration of Equipment under Test	4
2.1 Test Manner.....	4
2.2 Test Mode.....	4
2.3 Connection Diagram of Test System	7
2.4 Ancillary Equipment List.....	8
3. General Information of Test Site.....	9
3.1 Test Voltage.....	9
3.2 Test in Compliance with.....	9
3.3 Frequency Range Investigated	9
3.4 Test Distance.....	9
4. Test Data and Test Result.....	10
4.1 List of Measurements and Examinations	10
4.2 RF Output Power.....	11
4.3 ERP / EIRP Measurement.....	14
4.4 Occupied Bandwidth and Band Edge Measurement.....	19
4.5 Conducted Emission	37
4.6 Field Strength of Spurious Radiation	43
4.7 Frequency Stability (Temperature Variation)	69
4.8 Frequency Stability (Voltage Variation).....	72
4.9 AC Power Conducted Emissions Requirements	74
5. List of Measurement Equipments.....	81
6. Uncertainty Evaluation	82



1. General Information

Applicant :

Acer Incorporated
8F,88,Sec.1,Hsin Tai Wu Rd. Hsichih, Taipei Hsien 221 Taiwan, R.O.C.

Manufacturer	: Quanta Computer Inc. No.211, Wen Hwa 2nd Rd., Kuei Shan Hsiang, Tao Yuan Shien, Taiwan, R.O.C.
Product Name	: Notebook PC
Trade Mark	: acer
Model Number	: ZG5, Aspire One
FCC ID	: HLZZG53GQ
TX Frequency	: 824 - 849 MHz (GPRS/EGPRS 850) 1850 - 1910 MHz (GPRS/EGPRS 1900) 826 - 847 MHz (WCDMA /HSDPA Band V) 1852 - 1908 MHz (WCDMA/HSDPA Band II)
RX Frequency	: 869 - 894 MHz (GPRS/EGPRS 850) 1930 - 1990 MHz (GPRS/EGPRS 1900) 871 - 892 MHz (WCDMA /HSDPA Band V) 1932 - 1988 MHz (WCDMA/HSDPA Band II)
Antenna Type	: Internal Antenna
Maximum Output Power to Antenna (Conducted)	: 32.35 dBm (GPRS/EGPRS 850) 28.85 dBm (GPRS/EGPRS 1900) 23.98 dBm (WCDMA /HSDPA Band V) 23.37 dBm (WCDMA/HSDPA Band II)
Max. ERP/EIRP Power	: 0.210 W / 23.21 dBm ERP (GPRS 850) 0.699 W / 28.44 dBm EIRP (GPRS 1900) 0.138 W / 21.39 dBm ERP (WCDMA Band V) 0.590 W / 27.71 dBm EIRP (WCDMA Band II)
Type of Emission	: GPRS 850 : 250KGXW GPRS 1900 : 247KGXW WCDMA Band V : 4M17F9W WCDMA Band II : 4M18F9W
Power Rating (DC , Voltage and Current of RF element or PA)	: 19V / 1.58 A
Digital Modulation Emission	: GMSK(GPRS 850 / PCS1900) QPSK(WCDMA Band V / WCDMA Band II)
Power Supply Type	: AC Adapter
DC Power Cord	: 1.5 meter, DC Plug
Adapter	: LITE-ON / PA-1300-04
DUT Stage	: Production Unit



2. Test Configuration of Equipment under Test

2.1 Test Manner

1. The spurious emission measurements were carried out in semi-anechoic chamber with 3-meter test range.
2. During all testing, EUT is in link mode with base station emulator at maximum power level. (PCL=5 for GPRS 850 or PCL=0 for PCS 1900)
3. Frequency range investigated: radiated emission 30 MHz to 9000 MHz for GSM850; 30MHz to 19000 MHz for PCS 1900.

2.2 Test Mode

Preliminary tests were performed in different data mode to find the worst case. The data mode shown in the table below is the worst-case rate (Blue color). Investigation has been done on all the possible configurations for searching the worst cases. The following table is a list of the test modes shown in this test report.

Band	Date Rate	CH	Conducted Power	Worst
GPRS850 (Class 10)	3Down 2up	Lowest	32.35	■
		Middle	32.21	□
		Highest	32.08	□
	3Down 1up	Lowest	32.00	□
		Middle	32.20	□
		Highest	32.30	□
EGPRS850 (Class 10)	3Down 2up	Lowest	26.45	■
		Middle	26.31	□
		Highest	26.25	□
	3Down 1up	Lowest	26.24	□
		Middle	26.26	□
		Highest	26.38	□



Band	Date Rate	CH	Conducted Power	Worst
GPRS1900 (Class 10)	3Down 2up	Lowest	28.85	■
		Middle	28.81	□
		Highest	28.76	□
	3Down 1up	Lowest	28.31	□
		Middle	28.18	□
		Highest	28.12	□
EGPRS1900 (Class 10)	3Down 2up	Lowest	25.48	□
		Middle	25.66	□
		Highest	25.71	■
	3Down 1up	Lowest	25.50	□
		Middle	25.28	□
		Highest	25.24	□

Band	Sub-test	CH	Conducted Power	Worst
WCDMA V	---	Lowest	23.43	□
		Middle	23.85	□
		Highest	23.98	■
HSDPA V	1	Lowest	20.83	□
		Middle	21.25	□
		Highest	20.26	□
	2	Lowest	20.10	□
		Middle	20.22	□
		Highest	20.25	□
	3	Lowest	18.22	□
		Middle	18.58	□
		Highest	18.50	□
	4	Lowest	17.68	□
		Middle	17.82	□
		Highest	17.88	□



Band	Sub-test	CH	Conducted Power	Worst
WCDMA II	---	Lowest	23.37	■
		Middle	23.11	<input type="checkbox"/>
		Highest	22.86	<input type="checkbox"/>
HSDPA II	1	Lowest	21.45	<input type="checkbox"/>
		Middle	21.58	<input type="checkbox"/>
		Highest	21.33	<input type="checkbox"/>
	2	Lowest	20.44	<input type="checkbox"/>
		Middle	20.65	<input type="checkbox"/>
		Highest	20.29	<input type="checkbox"/>
	3	Lowest	18.77	<input type="checkbox"/>
		Middle	18.92	<input type="checkbox"/>
		Highest	18.55	<input type="checkbox"/>
	4	Lowest	18.28	<input type="checkbox"/>
		Middle	18.31	<input type="checkbox"/>
		Highest	18.05	<input type="checkbox"/>

2.3 Connection Diagram of Test System

Conducted Emission Setup

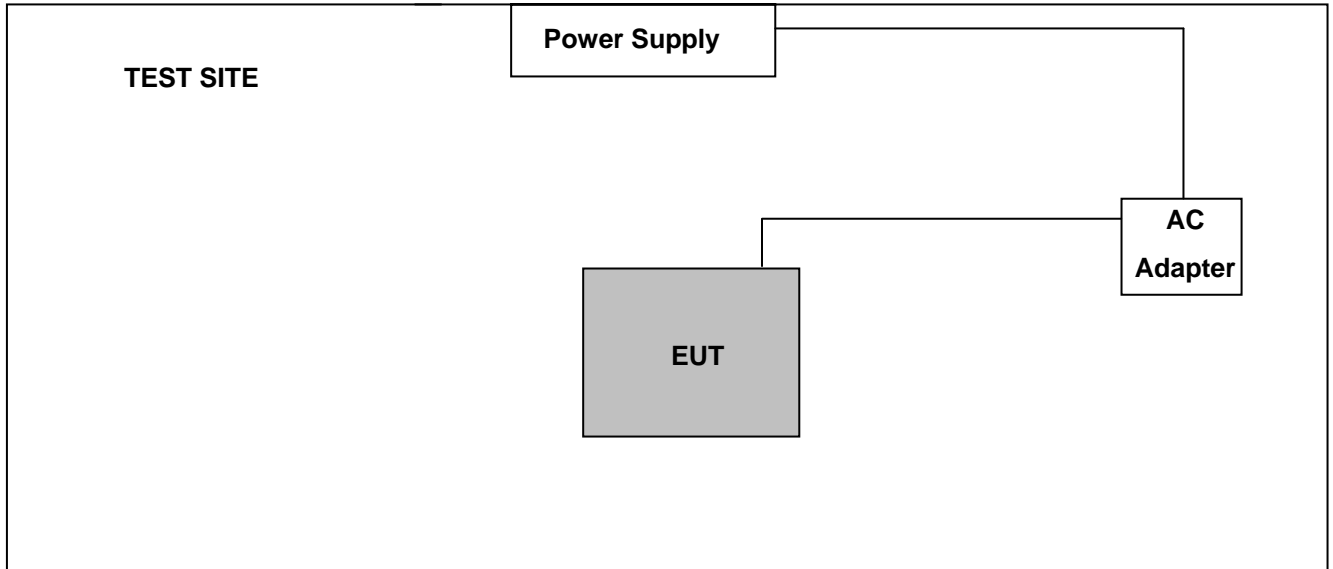

During EMI testing (LINK & Stand by Mode) the EUT (Notebook PC)'s power port connected to AC adapter.

Radiation Spurious Emission Setup

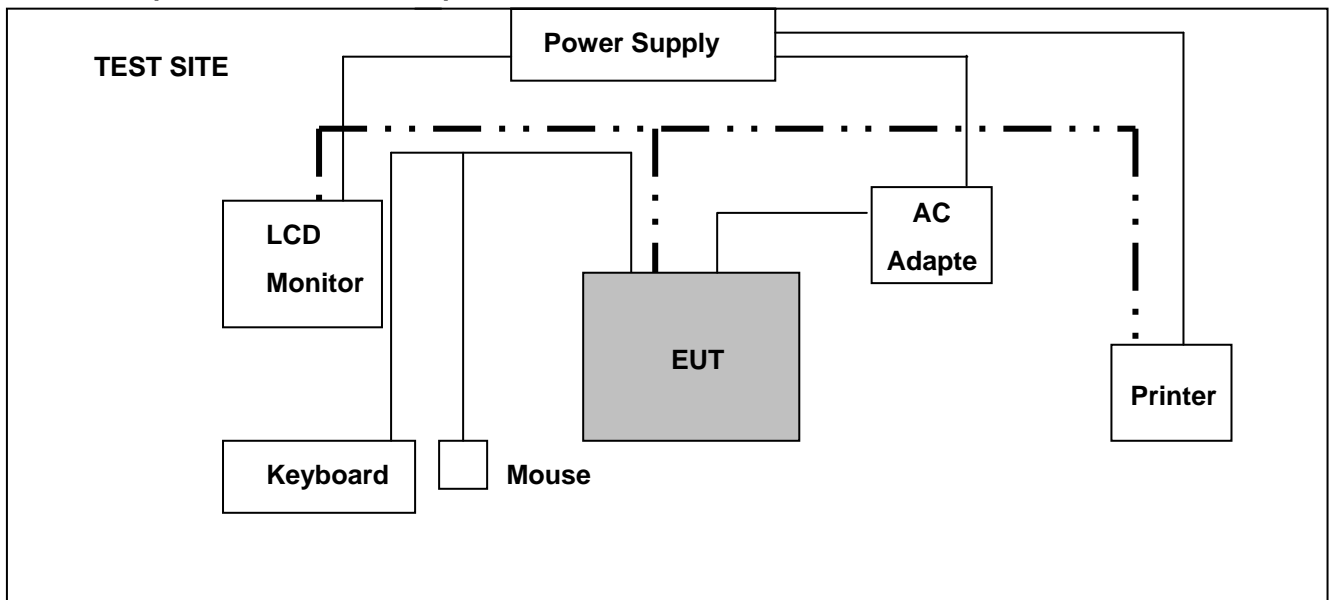

During EMI testing (LINK & Stand by Mode) the EUT (Notebook PC)'s power port connected to AC Adapter. A mouse was connected to the USB port of Notebook. And a keyboard & printer were connected to the USB ports of Notebook. An external LCD monitor connected the VGA port on AE' Notebook.



2.4 Ancillary Equipment List

1. Base Station(R&S) CMU200 106656
2. Power Supply (GW) 12P3A H281001



3. General Information of Test Site

Test Site Location: No. 140 -1, Changan Street, Bade City, Taoyuan County, Taiwan R.O.C.
TEL: 886-3-271-0188 FAX: 886-3-271-0190

Registration Number : 854525
Designation Number : TW1330

The chamber meets the characteristics of ANSI C63.4-2006. This site is on file with the FCC.

3.1 Test Voltage

DC 3.7V / 1.41 A (Battery)

3.2 Test in Compliance with

47 CFR Part 22H, 24E and Part 2. and 24, ANSI/TIA-603-C-2004

3.3 Frequency Range Investigated

1. Radiation: from 30 MHz to 9000 MHz for GSM 850.
2. Radiation: from 30 MHz to 19000 MHz for PCS 1900.
3. Radiation: from 30 MHz to 9000 MHz for WCDMA Band V.
4. Radiation: from 30 MHz to 19000 MHz for WCDMA Band II.

3.4 Test Distance

The test distance of radiated emission from antenna to EUT is 3 m.



4. Test Data and Test Result

4.1 List of Measurements and Examinations

FCC Rule	DESCRIPTION OF TEST	Result	Section
§ 2.1046	RF Output Power	Passed	4.2
§ 22.913 § 24.232	ERP / EIRP	Passed	4.3
§ 2.1049 § 22.917 § 24.238(b)	Occupied Bandwidth & Band Edge Measurement	Passed	4.4
§ 2.1051	Conducted Emission	Passed	4.5
§ 2.1053	Field Strength of Spurious Radiation	Passed	4.6
§ 2.1055 § 22.355 § 24.235	Frequency Stability vs. Temperature	Passed	4.7
§ 2.1055 § 22.355 § 24.235	Frequency Stability vs. Voltage	Passed	4.8
§ 15.207	AC Power Conducted Emissions Requirements	Passed	4.9

4.2 RF Output Power

4.2.1 Measurement Instruments :

As described in chapter 5 of this test report.

4.2.2 Test Procedure :

The measurement is made according to ANSI/TIA-603-C-2004 as follows:

1. The transmitter output was connected to power meter and base station through power divider.
2. Set base station for EUT at GSM 850: PCL=5 and PCS 1900: PCL=0.
3. Set base station for EUT at WCDMA Band V and WCDMA Band II, power level was set to maximum.
4. Select lowest, middle, and highest channels for each band.

4.2.3 Test Setup Layout :

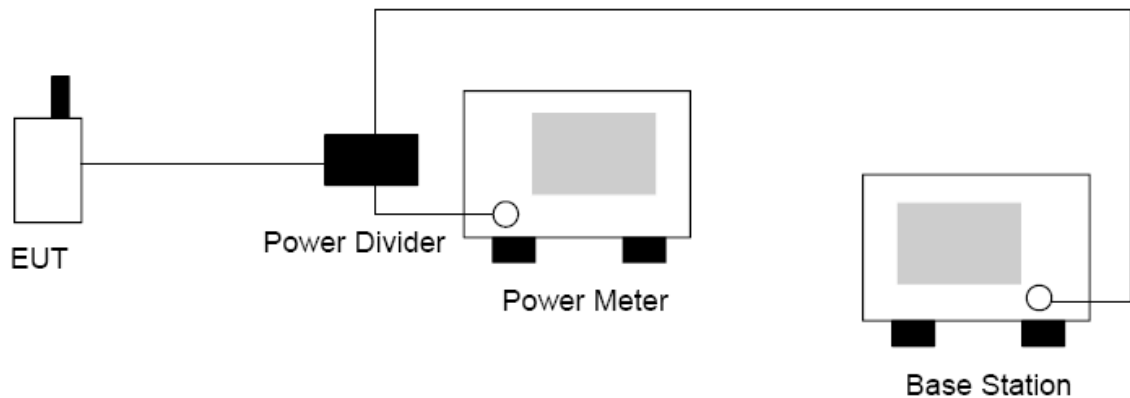



4.2.4 Test Result :

Bands	Channel	Frequency (MHz)		Conducted Power (dBm)	Conducted Power (Watts)
GPRS 850	128	Low	824.2	32.35	1.718
	190	Mid	836.4	32.21	1.663
	251	High	848.8	32.08	1.614

Bands	Channel	Frequency (MHz)		Conducted Power (dBm)	Conducted Power (Watts)
EGPRS 850	128	Low	824.2	26.45	0.442
	190	Mid	836.4	26.31	0.428
	251	High	848.8	26.25	0.422

Bands	Channel	Frequency (MHz)		Conducted Power (dBm)	Conducted Power (Watts)
GPRS 1900	512	Low	1850.2	28.85	0.767
	661	Mid	1880.0	28.81	0.760
	810	High	1909.8	28.76	0.752

Bands	Channel	Frequency (MHz)		Conducted Power (dBm)	Conducted Power (Watts)
EGPRS 1900	512	Low	1850.2	25.48	0.353
	661	Mid	1880.0	25.66	0.368
	810	High	1909.8	25.71	0.372



Bands	Channel	Frequency (MHz)		Conducted Power (dBm)	Conducted Power (Watts)
WCDMA Band V	4132	Low	826.4	23.43	0.220
	4182	Mid	836.4	23.85	0.243
	4233	High	846.4	23.98	0.250

Bands	Channel	Frequency (MHz)		Conducted Power (dBm)	Conducted Power (Watts)
HSDPA Band V	4132	Low	826.4	20.83	0.121
	4182	Mid	836.4	21.25	0.133
	4233	High	846.4	20.26	0.106

Bands	Channel	Frequency (MHz)		Conducted Power (dBm)	Conducted Power (Watts)
WCDMA Band II	9262	Low	1852.4	23.37	0.217
	9400	Mid	1880.0	23.11	0.205
	9538	High	1907.6	22.86	0.193

Bands	Channel	Frequency (MHz)		Conducted Power (dBm)	Conducted Power (Watts)
HSDPA Band II	9262	Low	1852.4	21.45	0.140
	9400	Mid	1880.0	21.58	0.144
	9538	High	1907.6	21.33	0.136



4.3 ERP / EIRP Measurement

Equivalent isotropic radiated power measurements by substitution method according to ANSI/TIA/EIA-603-B-2002.

4.3.1 Measurement Instruments

As described in chapter 5 of this test report.

4.3.2 Test Procedure

The phone was tested in an anechoic chamber with a 3-axis position system that permits taking complete spherical scans of the EUT's 3-axis radiation patterns. For all tests, the phone was supported in a free space type environment, vertically oriented in the chamber. Tests were done for GSM 850 three frequencies (824.2, 836.6 and 848.8 MHz) and GSM 1900 three frequencies (1850.2, 1880.00, and 1909.80 MHz).

GSM measurements were made with the phone placed in a call using the CMU200 mobile station test set. The phone was weakly coupled to the test set and configured to transmit in full data rate mode.

The radiated power was measured using ETS-LINDGREN OTA Chamber in "Peak" mode. From these measurements, the software calculates the angle at which maximum radiated power occurs for each case, and the radiated power at this angle was extracted from the data.

Each individual data point in a radiated power or sensitivity measurement is referred to as the effective isotropic radiated power or effective isotropic sensitivity. That is, the desired information is how the measured quantity relates to the same quantity from an isotropic radiator. Thus, the reference measurement must relate the power received or transmitted at the EUT test equipment (spectrum analyzer or communication tester) back to the power transmitted or received at a theoretical isotropic radiator. The total path loss then, is just the difference in dB between the power transmitted or received at the isotropic radiator and that seen at the test equipment (see follow Figure 1).

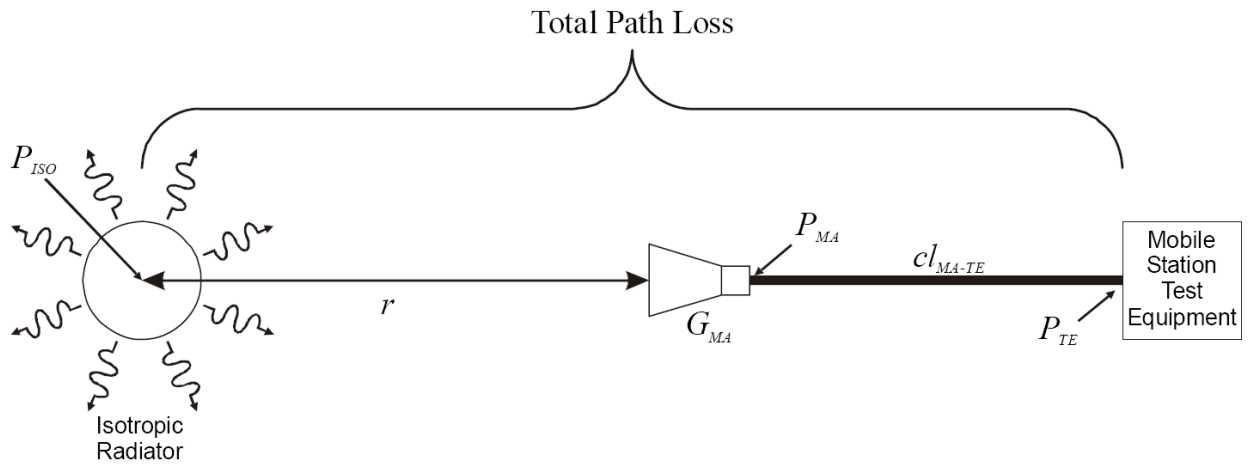

Figure 1. THEORETICAL CASE FOR DETERMINING PATH LOSS

In equation form, this becomes:

Equation 1

$$PL = P_{ISO} - P_{TE},$$

where PL is the total path loss, P_{ISO} is the power radiated by the theoretical isotropic radiator, and P_{TE} is the power received at the test equipment port. As can be seen in Figure 1, this quantity includes the range path loss due to the range length r , the gain of the measurement antenna, and any loss terms associated with the cabling, connections, amplifiers, splitters, etc. between the measurement antenna and the test equipment port.

Figure 2 shows a typical real world configuration for measuring the path loss. In this case, a reference antenna with known gain is used in place of the theoretical isotropic source. The path loss may then be determined from the power into the reference antenna by adding the gain of the reference antenna.

That is:

Equation 2

$$P_{ISO} = P_{RA} + G_{RA},$$

where P_{RA} is the power radiated by reference antenna, and G_{RA} is the gain of the reference antenna, so that:

Equation 3

$$PL = P_{RA} + G_{RA} - P_{TE},$$

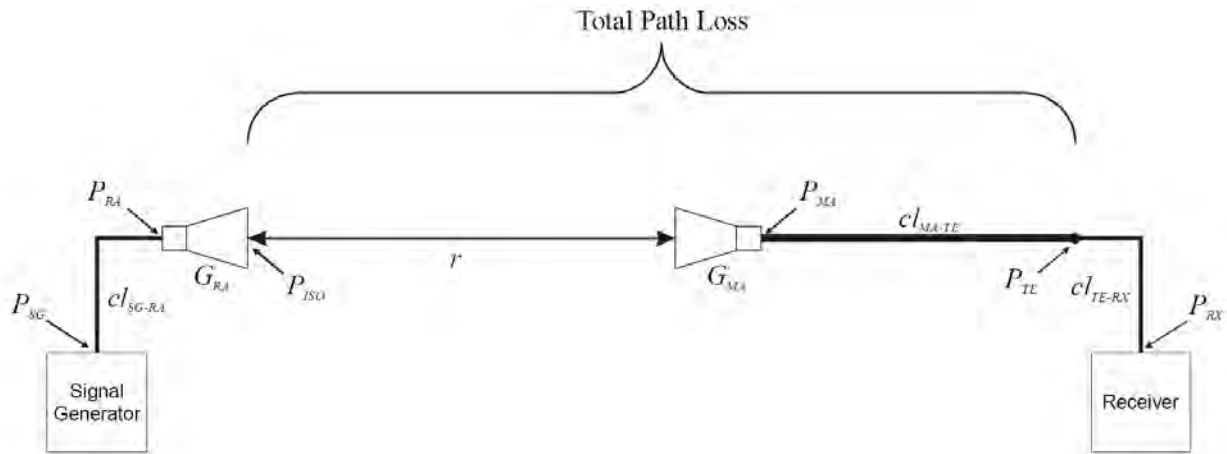

Figure 2. TYPICAL CONFIGURATION FOR MEASURING PATH LOSS

In order to determine P_{RA} , it is necessary to perform a cable reference measurement to remove the effects of the cable loss between signal generator and reference antenna, and between the test equipment port and the receiver. This establishes a reference point at the input to the reference antenna. Figure 3 illustrates the cable reference measurement configuration. Assuming the power level at the signal generator is fixed, it is easy to show that the difference between P_{RA} and P_{TE} in Figure 2 is given by:

Equation 4

$$P_{RA} - P_{TE} = P_{RX}' - P_{RX},$$

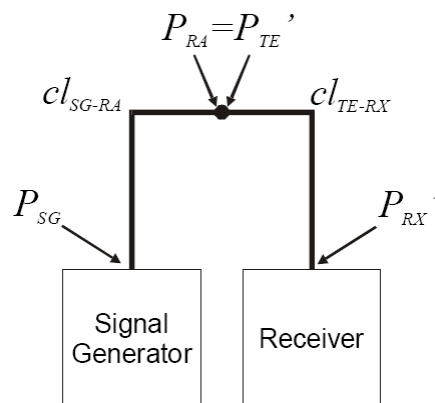

Figure 3. CABLE REFERENCE CALIBRATION CONFIGURATION

Where P_{RX} is the power measured at the receiver during the cable reference test, and P_{RX} is the power measured at the receiver during the range path loss measurement in Figure 2. Thus, the path loss is then just given by:

Equation 5

$$PL = G_{RA} + P_{RX}' - P_{RX}$$

$$EIRP = P_t + P_L$$

P_t = Often referred to as antenna output power

4.3.3 Test Setup Layout of ERP/EIRP

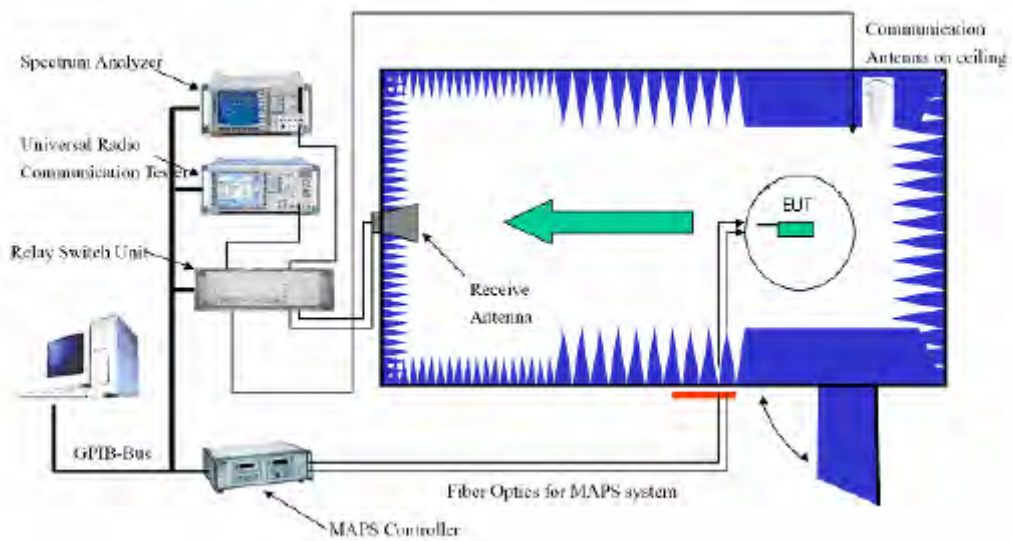



4.3.4 Test Result

GPRS 850 Radiated Power ERP				
Maximum Output Power				
Frequency (MHz)	Read Level (dBm)	Correction factor (dBm)	ERP (dBm)	ERP (W)
824.20	72.01	-48.80	23.21	0.210
836.40	74.15	-48.80	25.35	0.343
848.80	75.83	-48.80	27.03	0.504

GPRS 1900 Radiated Power EIRP				
Maximum Output Power				
Frequency (MHz)	Read Level (dBm)	Correction factor (dBm)	EIRP (dBm)	EIRP (W)
1850.20	81.04	-54.00	27.04	0.506
1880.00	83.32	-55.60	27.72	0.591
1909.80	85.34	-56.90	28.44	0.699

WCDMA Band V Radiated Power ERP				
Maximum Output Power				
Frequency (MHz)	Read Level (dBm)	Correction factor (dBm)	ERP (dBm)	ERP (W)
826.40	68.79	-49.50	19.29	0.085
836.40	70.88	-49.70	21.18	0.131
846.60	71.09	-49.70	21.39	0.138

WCDMA Band II Radiated Power EIRP				
Maximum Output Power				
Frequency (MHz)	Read Level (dBm)	Correction factor (dBm)	EIRP (dBm)	EIRP (W)
1852.40	83.11	-55.40	27.71	0.590
1880.00	83.21	-55.60	27.61	0.577
1907.60	83.31	-55.70	27.61	0.576

Note: ERP = Read Level + Correction factor

4.4 Occupied Bandwidth and Band Edge Measurement

4.4.1 Measurement Instruments

As described in chapter 5 of this test report.

4.4.2 Test Procedure

The measurement is made according to FCC rules part 22 and 24:

1. The EUT was connected to Spectrum Analyzer and Base Station via power divider.
2. The occupied bandwidth of middle channel for the highest and lowest RF powers was measured.
3. The band edge of low and high channels for the highest RF powers within the transmitting frequency band were measured. Setting RBW as roughly BW/100.
4. The band edge setting:
 - a. RB=3 kHz; VB=3 kHz for GSM 850 and PCS 1900.
 - b. RB=100 kHz; VB=100 kHz for WCDMA Band V and WCDMA Band II.

4.4.3 Test Setup Layout

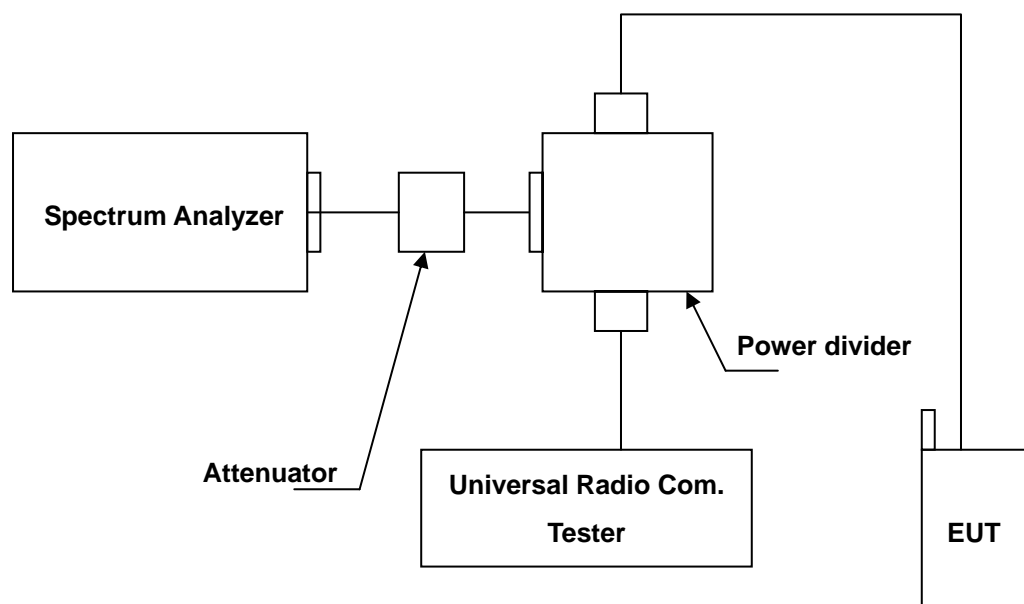



4.4.4 Occupied Bandwidth Test Result

GPRS 850		
Channel	Frequency (MHz)	Output Power - 26 dBc Bandwidth (kHz)
128	824.2	242.6151
190	836.6	245.3983
251	848.8	250.5487
RB:3KHz , VBW:10KHz		

GPRS 1900		
Channel	Frequency (MHz)	Output Power - 26 dBc Bandwidth (kHz)
512	1850.2	240.0566
661	1880.0	241.5075
810	1909.8	247.7099
RB:3KHz , VBW:10KHz		

WCDMA Band V		
Channel	Frequency (MHz)	Output Power - 26 dBc Bandwidth (MHz)
4132	826.4	4.1577
4182	836.4	4.1701
4233	846.6	4.1583
RB:30KHz , VBW:300KHz		

WCDMA Band II		
Channel	Frequency (MHz)	Output Power - 26 dBc Bandwidth (MHz)
9262	1852.4	4.1899
9400	1880.0	4.1812
9538	1907.6	4.1769
RB:30KHz , VBW:300KHz		



Test Mode: GPRS 850 CH128 99% Occupied Bandwidth

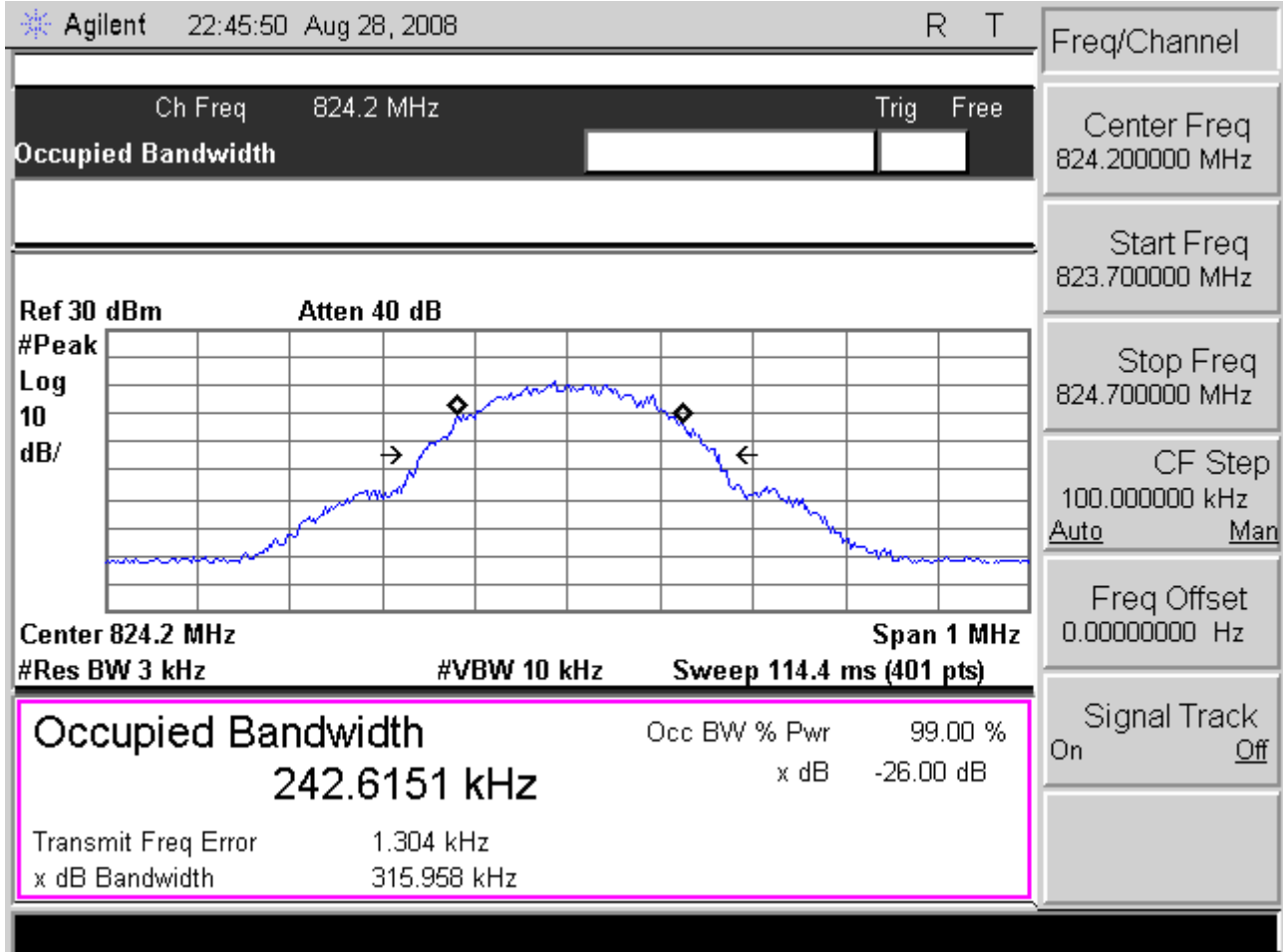



Test Mode: GPRS 850 CH190 99% Occupied Bandwidth

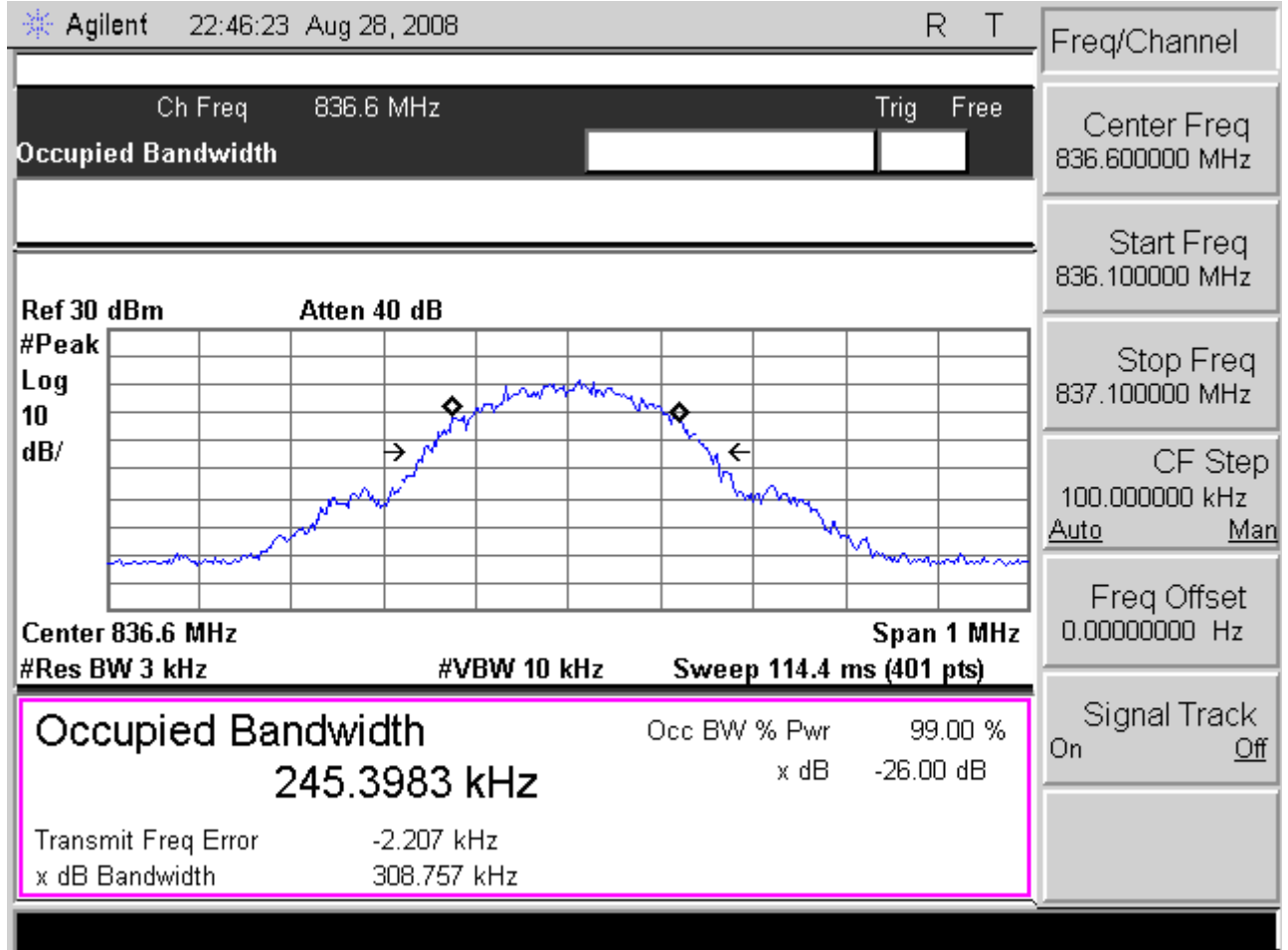



Test Mode: GPRS 850 CH251 99% Occupied Bandwidth

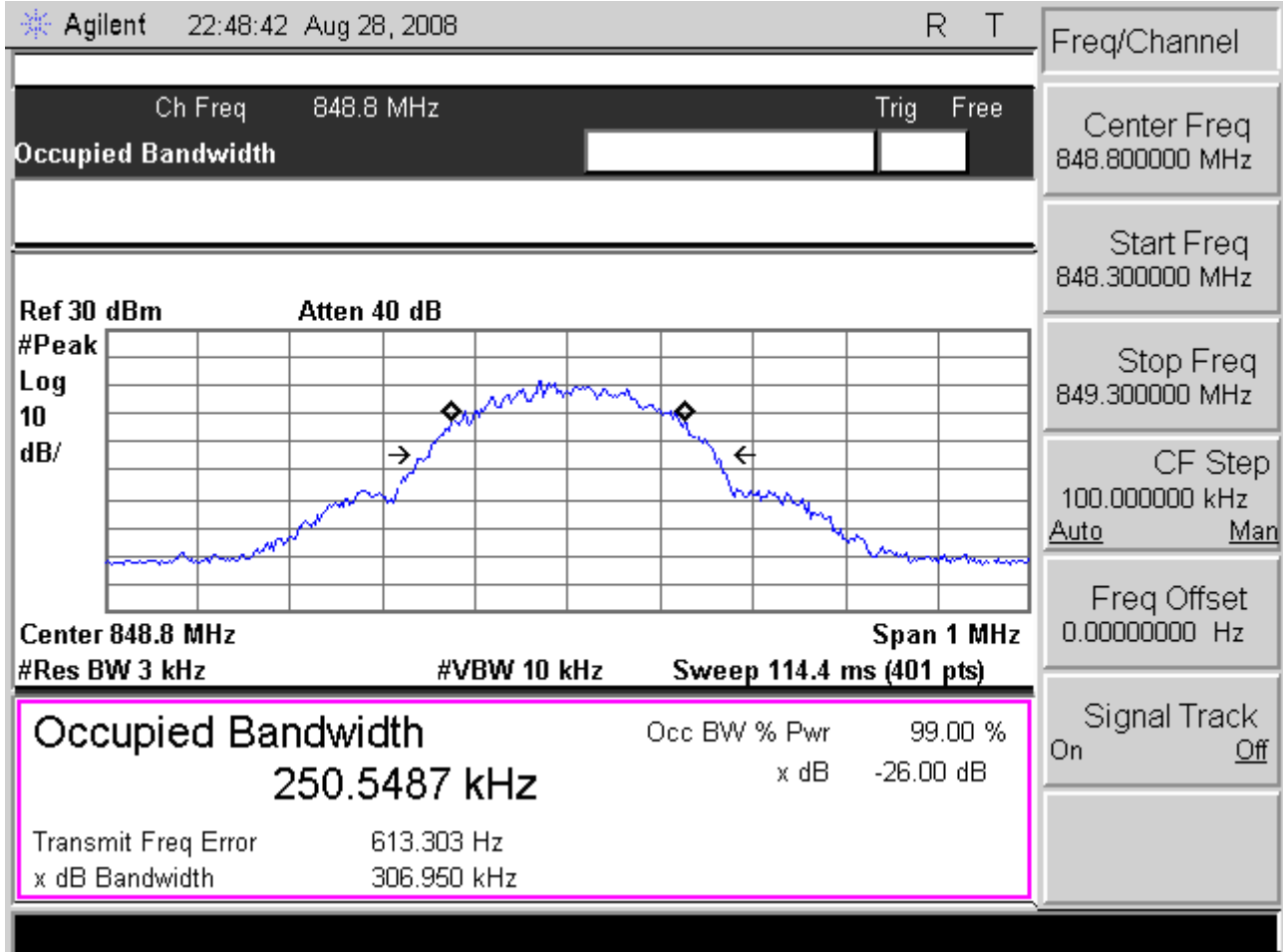



Test Mode: GPRS 1900 CH512 99% Occupied Bandwidth

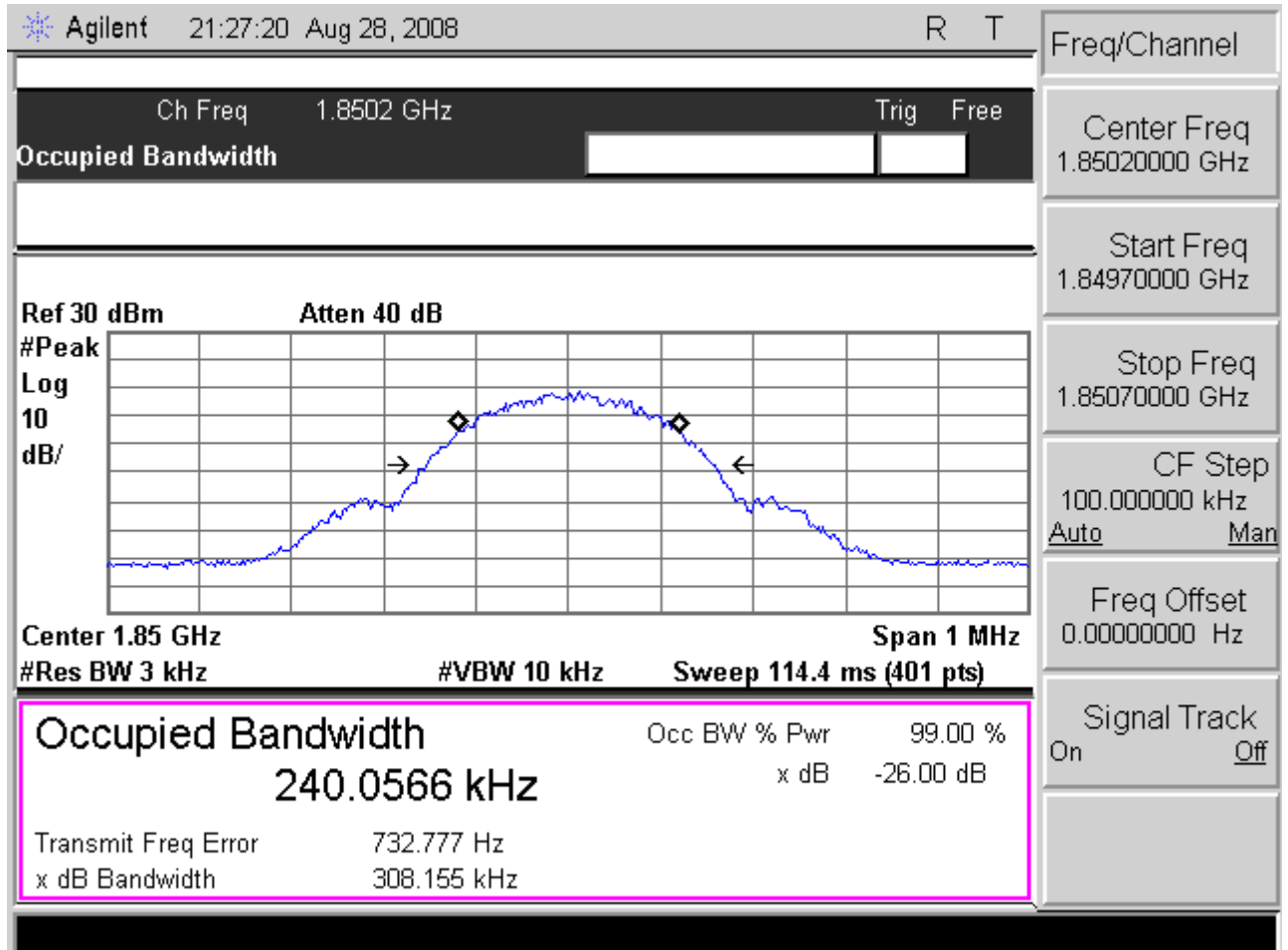



Test Mode: GPRS 1900 CH661 99% Occupied Bandwidth

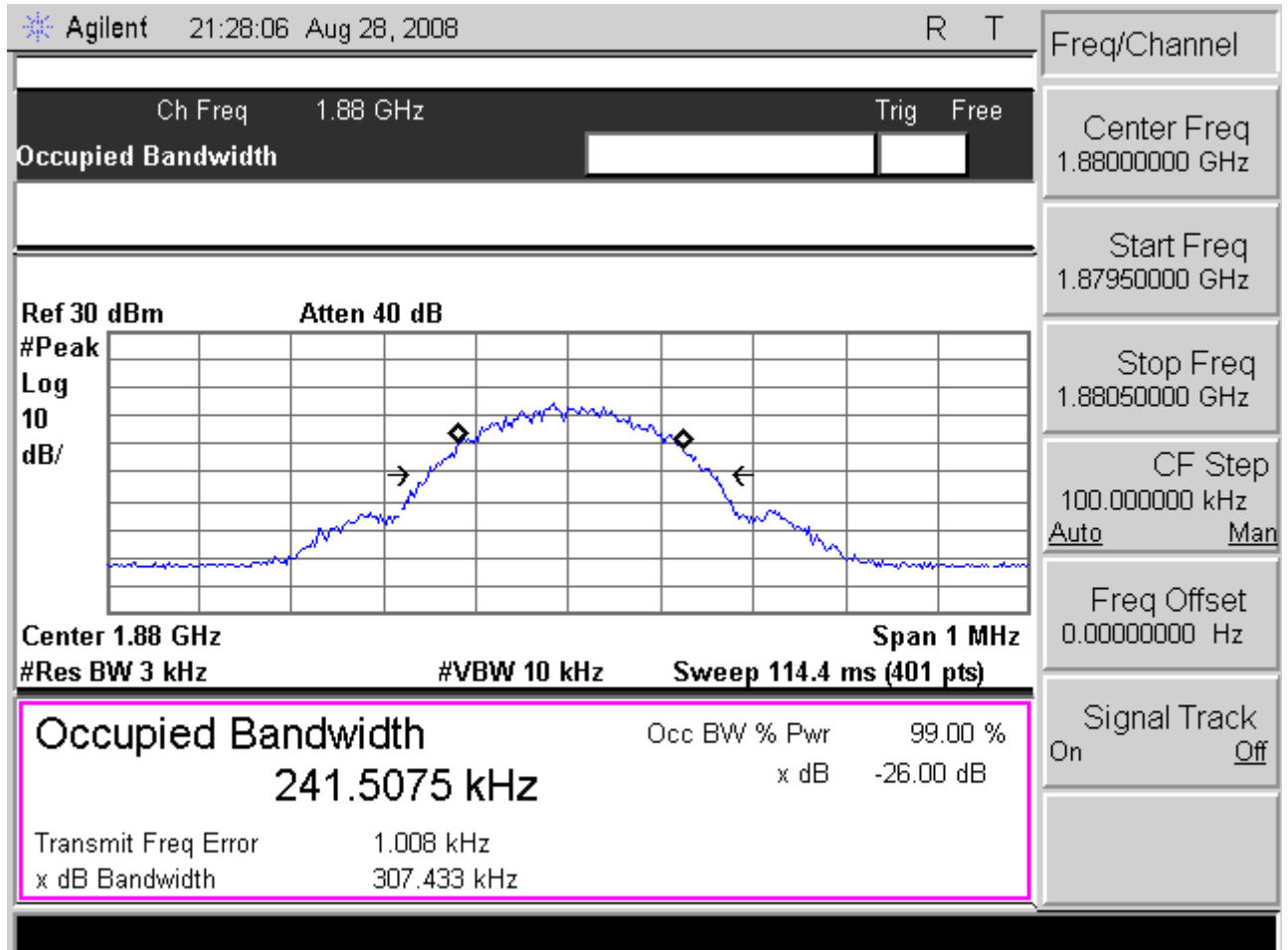



Test Mode: GPRS 1900 CH810 99% Occupied Bandwidth

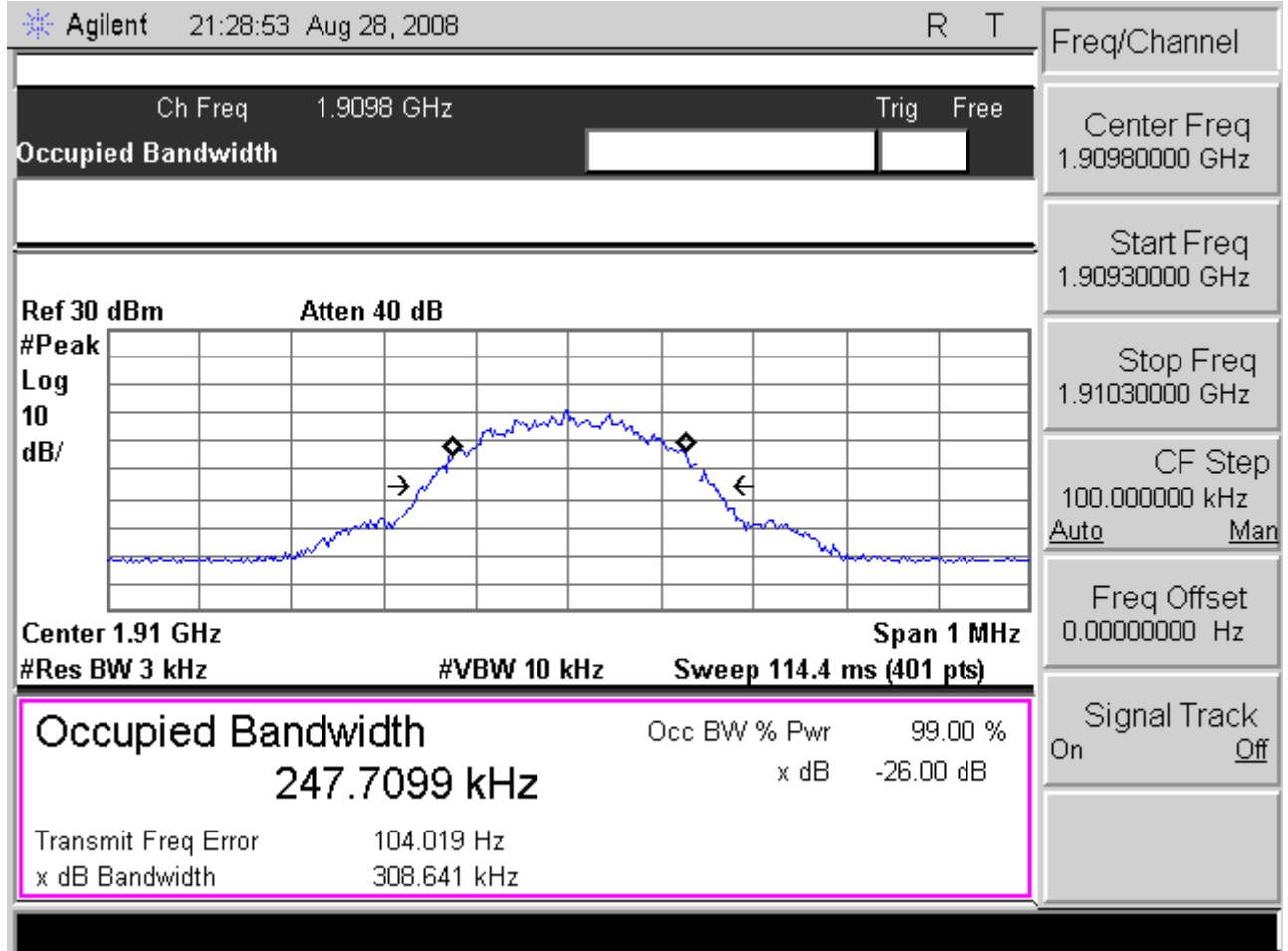



Test Mode: WCDMA Band V CH4132 99% Occupied Bandwidth

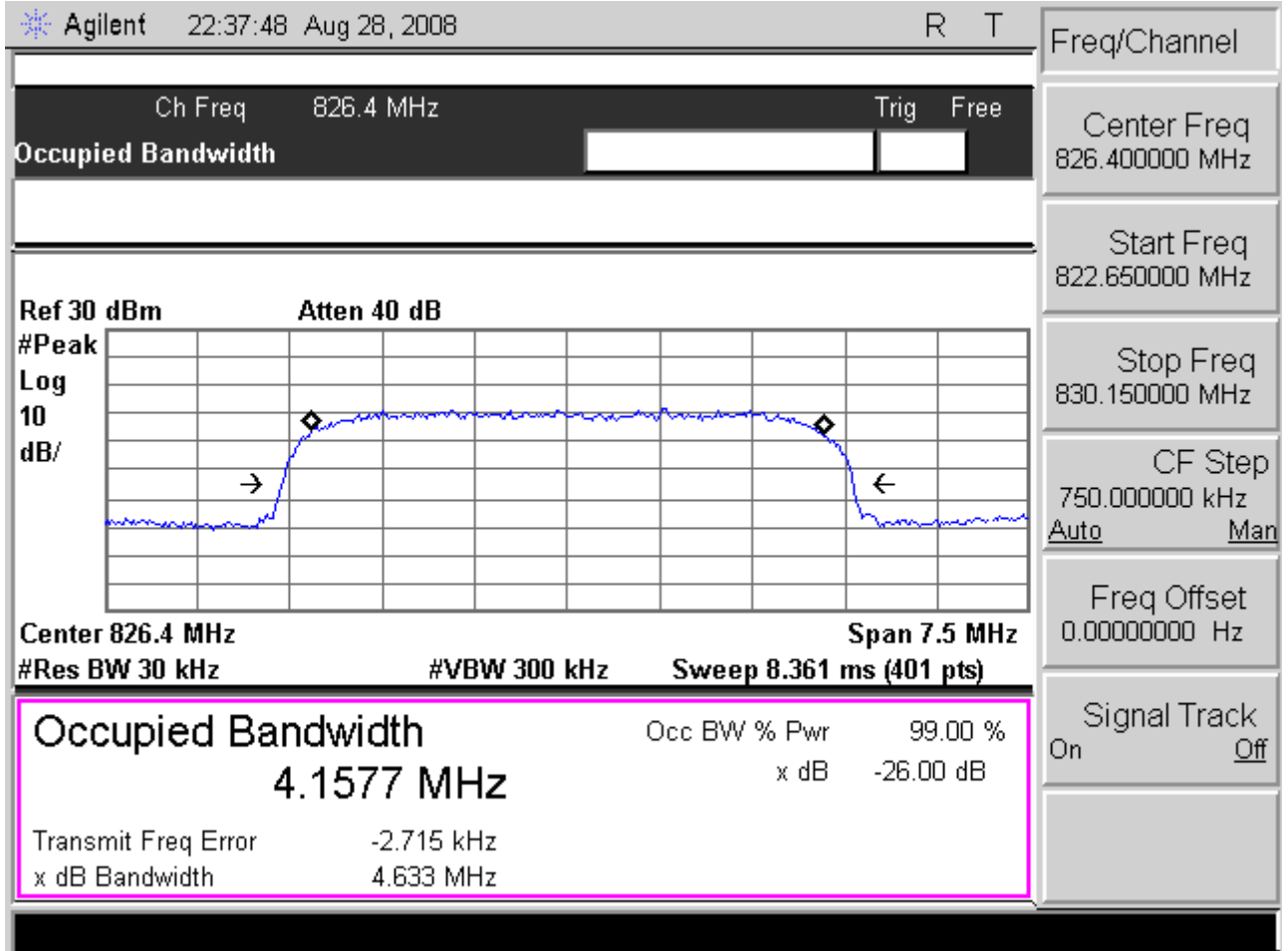



Test Mode: WCDMA Band V CH4182 99% Occupied Bandwidth

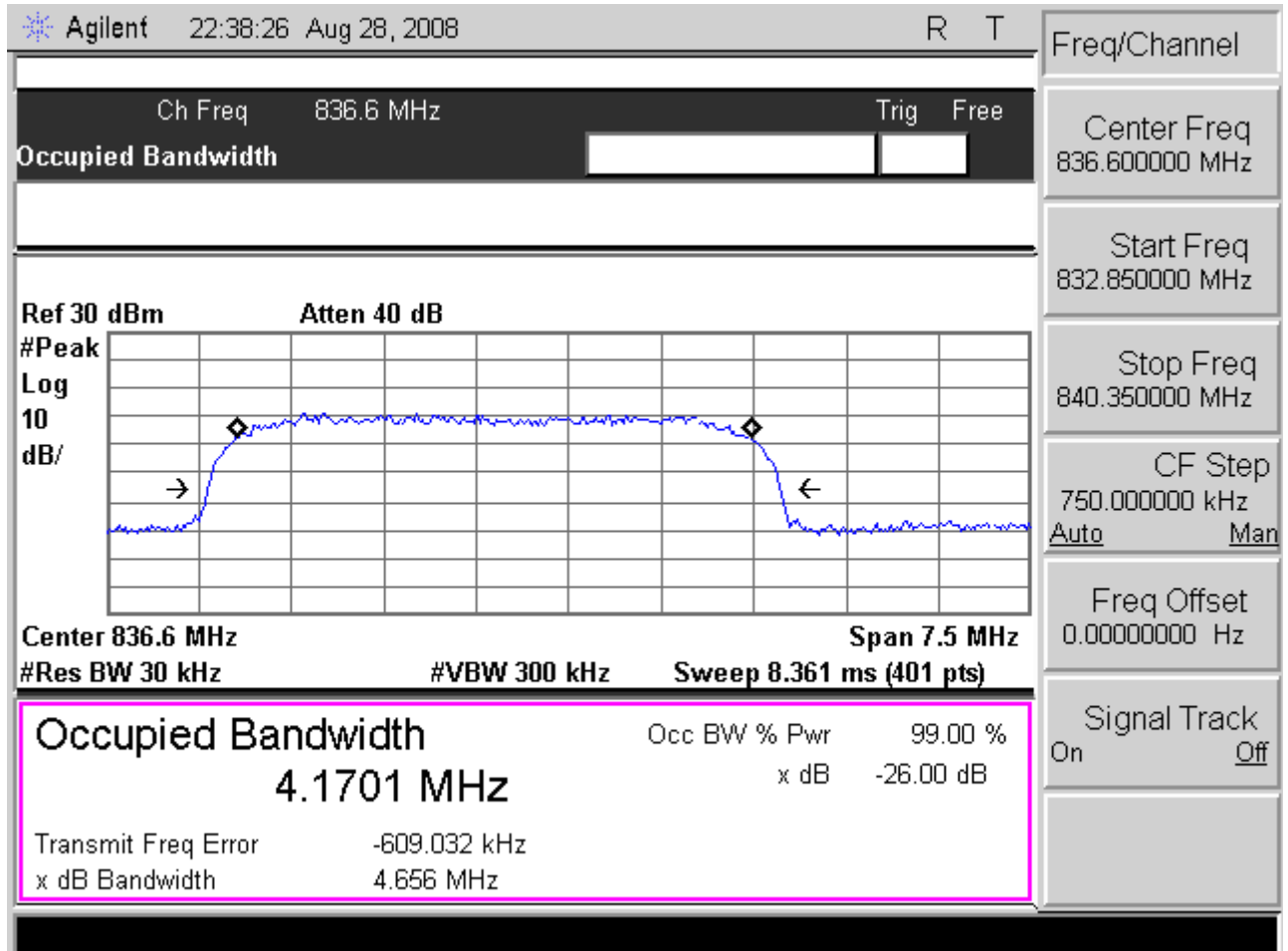



Test Mode: WCDMA Band V CH4233 99% Occupied Bandwidth

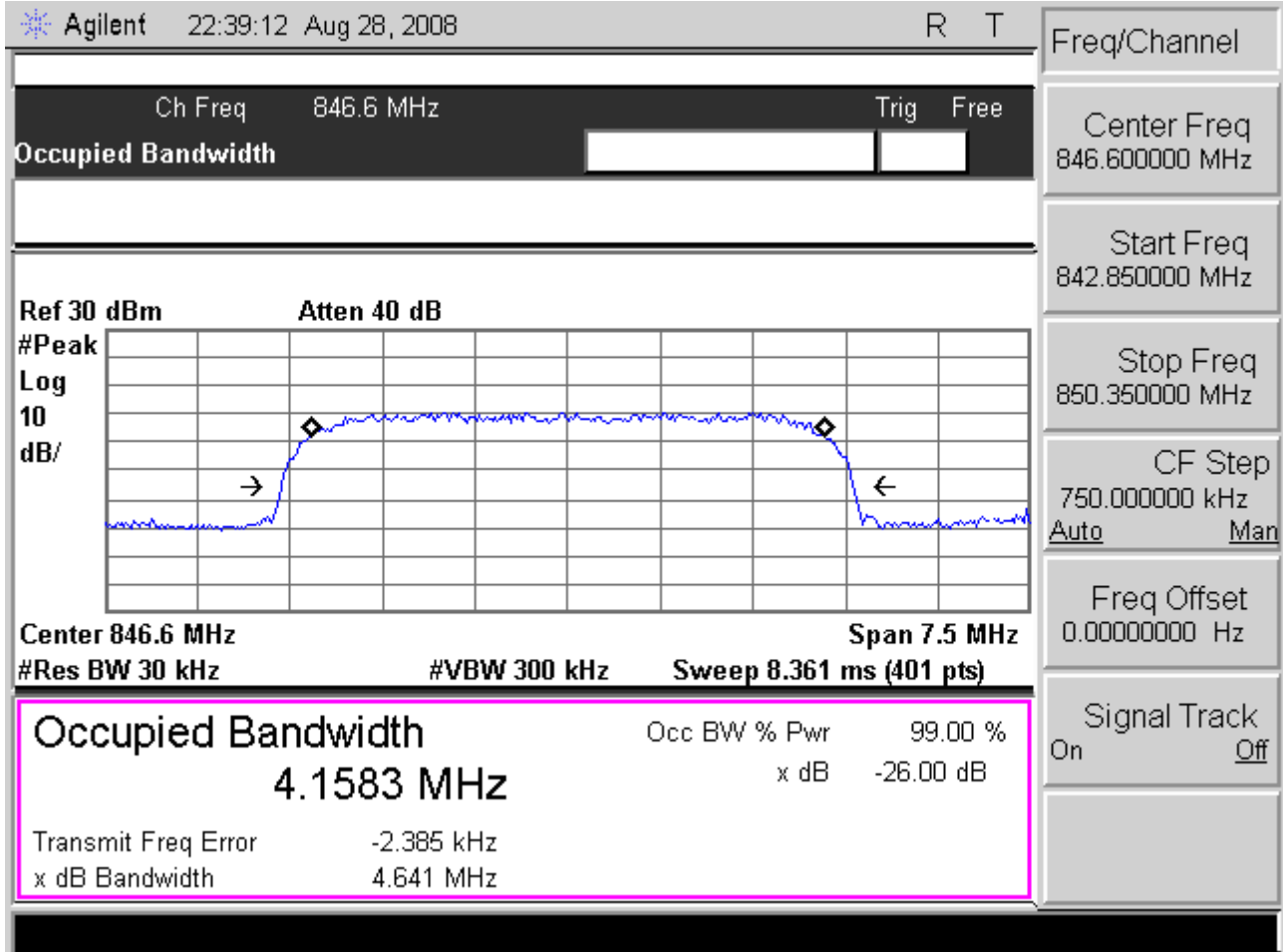



Test Mode: WCDMA Band II CH9262 99% Occupied Bandwidth

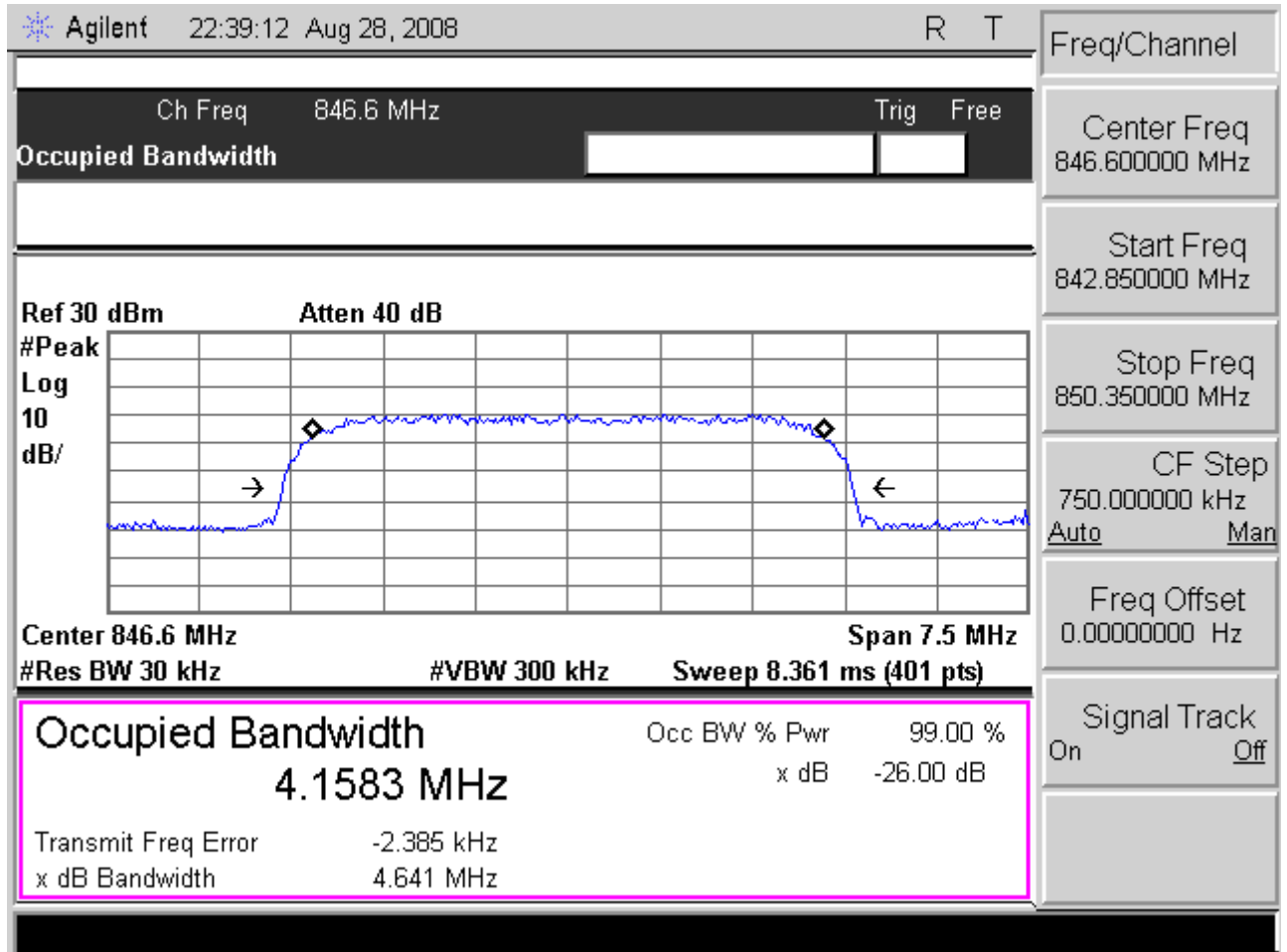



Test Mode: WCDMA Band II CH9400 99% Occupied Bandwidth

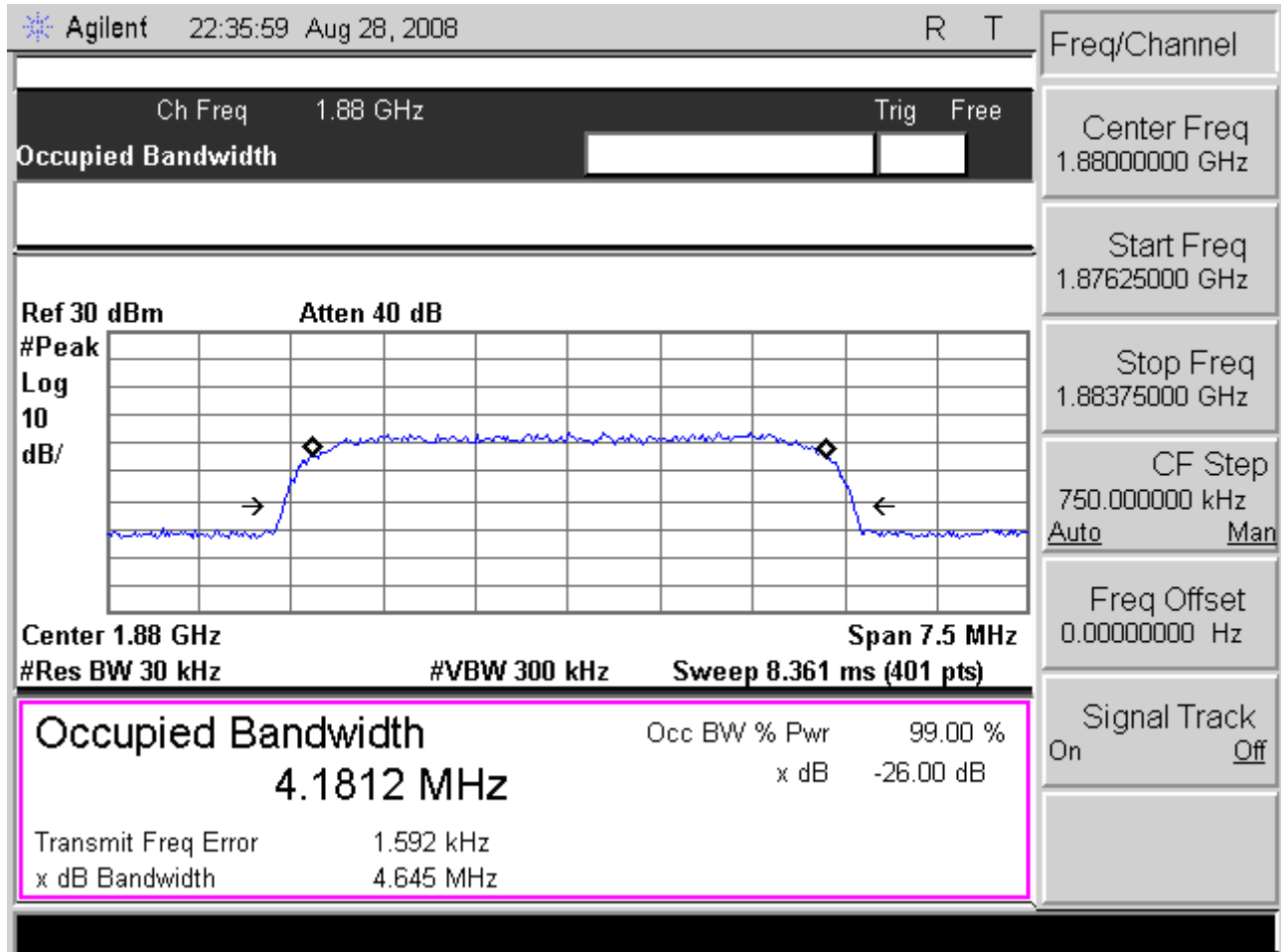



Test Mode: WCDMA Band II CH9538 99% Occupied Bandwidth

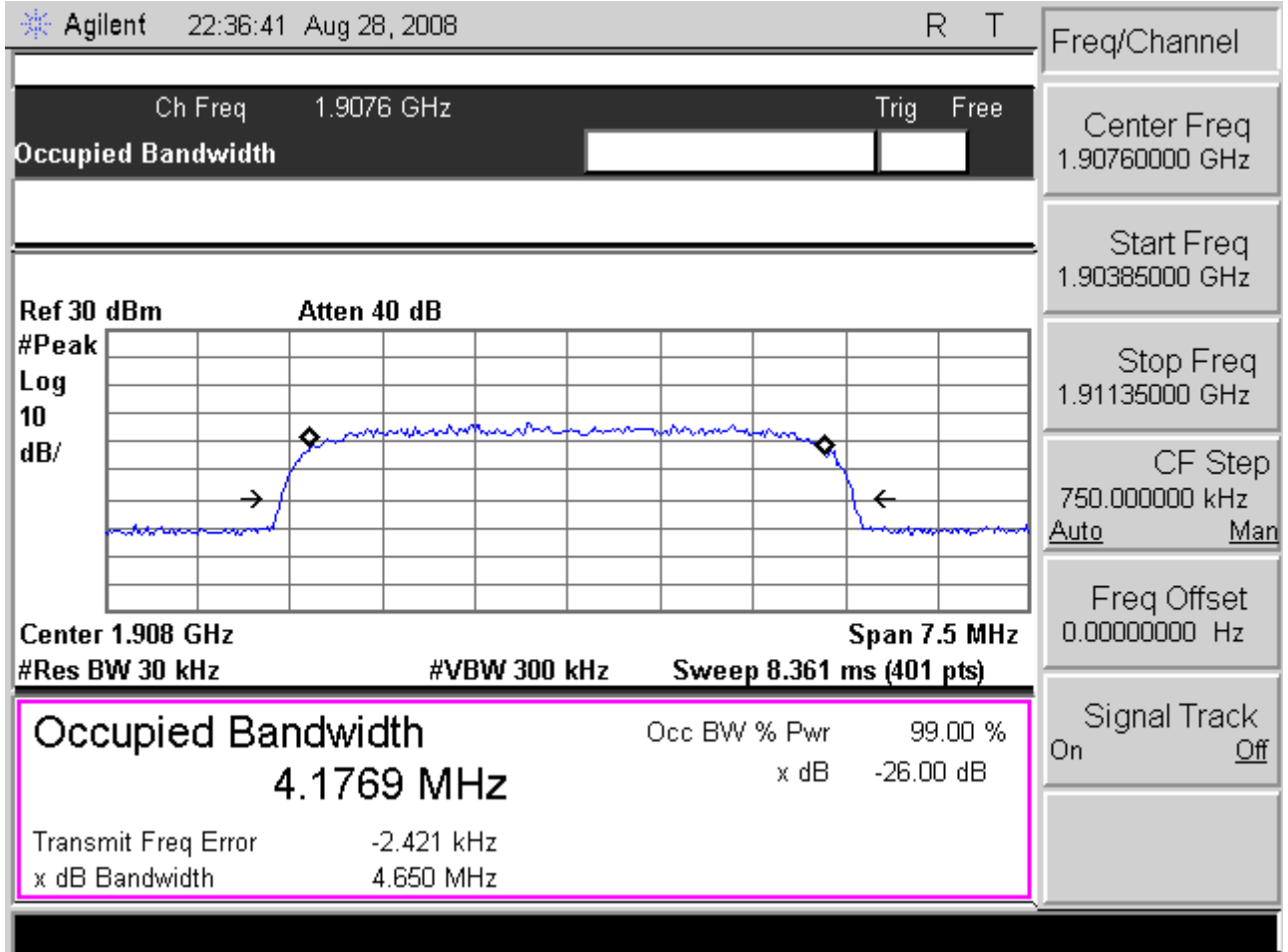



4.4.5 Band Edge Test Result

4.4.5.1 GPRS 850 Test Result

GPRS 850				
Band	Channel	Frequency (MHz)	Bandwidth (dBm)	Limit (dBm)
Lower	128	823.9973	-15.46	-13
Higher	251	849.0225	-17.02	-13

Please refer to next pager of detail testing data.



Radiated Emission Measurement

File :ZG5(GSM850)

Data :#1

Date: 2008/9/01

Time:

30.0 dBm

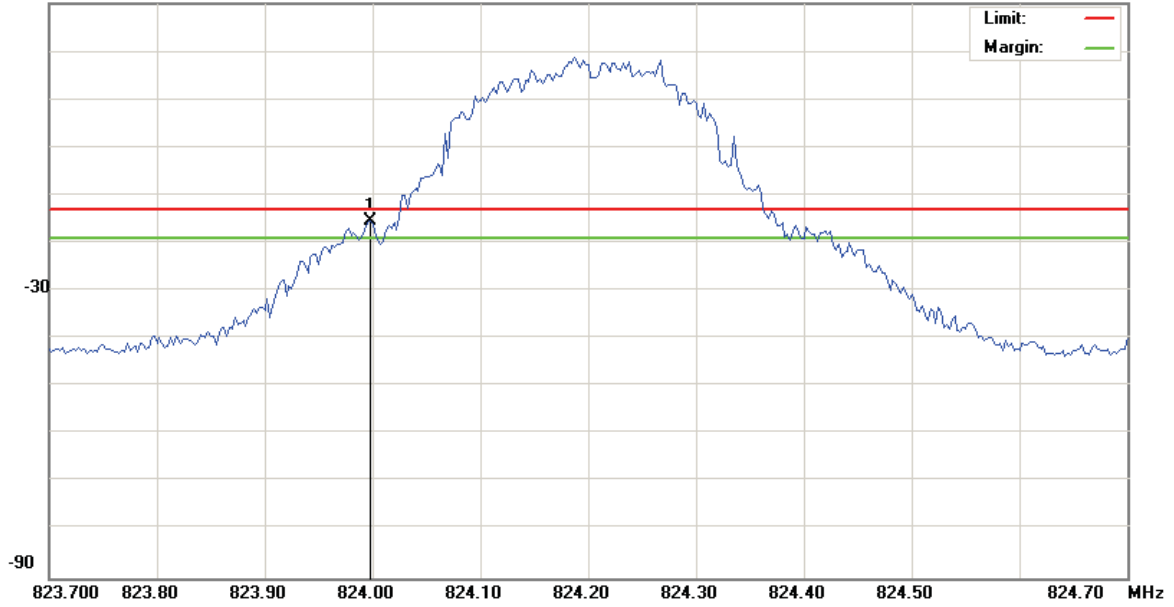

Site site#1

Polarization: *Conducted po*

Temperature: 26 °C

Limit: FCC Part 22 conducted(9k-12.75G)

Power: AC 110V/60Hz

Humidity: 55 %

EUT:

Distance:

M/N: ZG5

Mode:

Note: CH128(824.2MHz)

加10db衰减器

No.	Mk.	Freq.	Reading Level	Correct Factor	Measurement	Limit	Over	Antenna Height	Table Degree	
		MHz	dBm	dB	dBm	dBm	dB	cm	degree	Comment
1	*	823.9973	-28.64	13.18	-15.46	-13.00	-2.46	peak		

*:Maximum data x:Over limit !:over margin

●Reference Only

Engineer Signature:



File :ZG5(GSM850)

Data :#2

Date: 2008/9/01

Time:

30.0 dBm

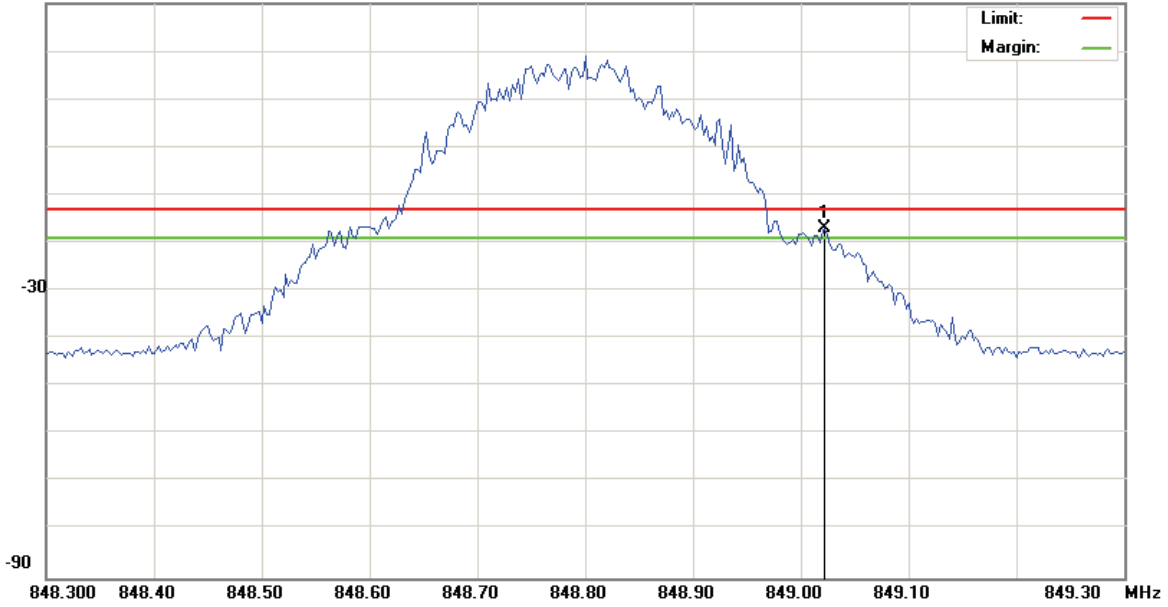

Site site#1

Polarization: *Conducted po*

Temperature: 26 °C

Limit: FCC Part 22 conducted(9k-12.75G)

Power: AC 110V/60Hz

Humidity: 55 %

EUT:

Distance:

M/N: ZG5

Mode:

Note: CH251(848.8MHz)

加10db衰减器

No.	Mk.	Freq.	Reading Level	Correct Factor	Measurement	Limit	Over	Antenna Height	Table Degree	
		MHz	dBm	dB	dBm	dBm	dB	cm	degree	Comment
1	*	849.0225	-30.27	13.25	-17.02	-13.00	-4.02			peak

*:Maximum data x:Over limit !:over margin

●Reference Only



4.4.5.2 GPRS 1900 Test Result

GPRS 1900				
Band	Channel	Frequency (MHz)	Bandwidth (dBm)	Limit (dBm)
Lower	512	1849.980	-17.99	-13
Higher	810	1910.020	-18.90	-13

Please refer to next pager of detail testing data.



File :ZG5(PCS1900)

Data :#1

Date: 2008/9/01

Time:

30.0 dBm

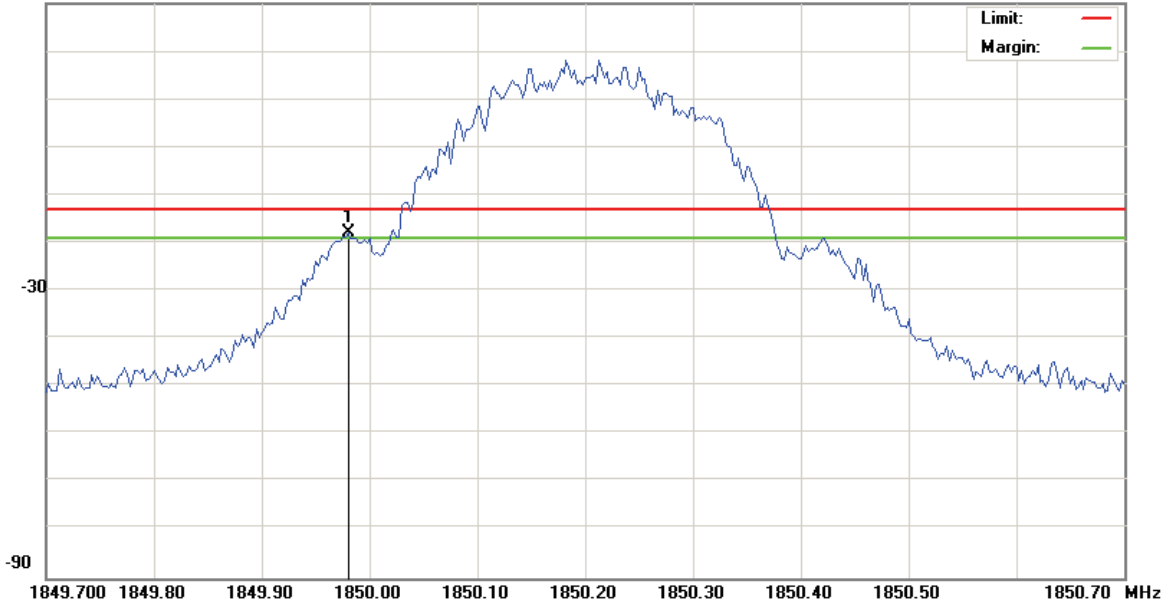

Site site#1

Polarization: *Conducted po*

Temperature: 26 °C

Limit: FCC Part 24 conducted(9k-12.75G)

Power: AC 110V/60Hz

Humidity: 55 %

EUT:

Distance:

M/N: ZG5

Mode:

Note: CH512(1784.8MHz)

加10db衰减器

No.	Mk.	Freq. MHz	Reading Level dBm	Correct Factor dB	Measure- ment dBm	Limit dBm	Over dB	Antenna Height cm	Table Degree degree	Comment
1	*	1849.980	-22.24	4.25	-17.99	-13.00	-4.99	peak		

*:Maximum data x:Over limit !:over margin

●Reference Only



File :ZG5(PCS1900)

Data :#2

Date: 2008/9/01

Time:

30.0 dBm

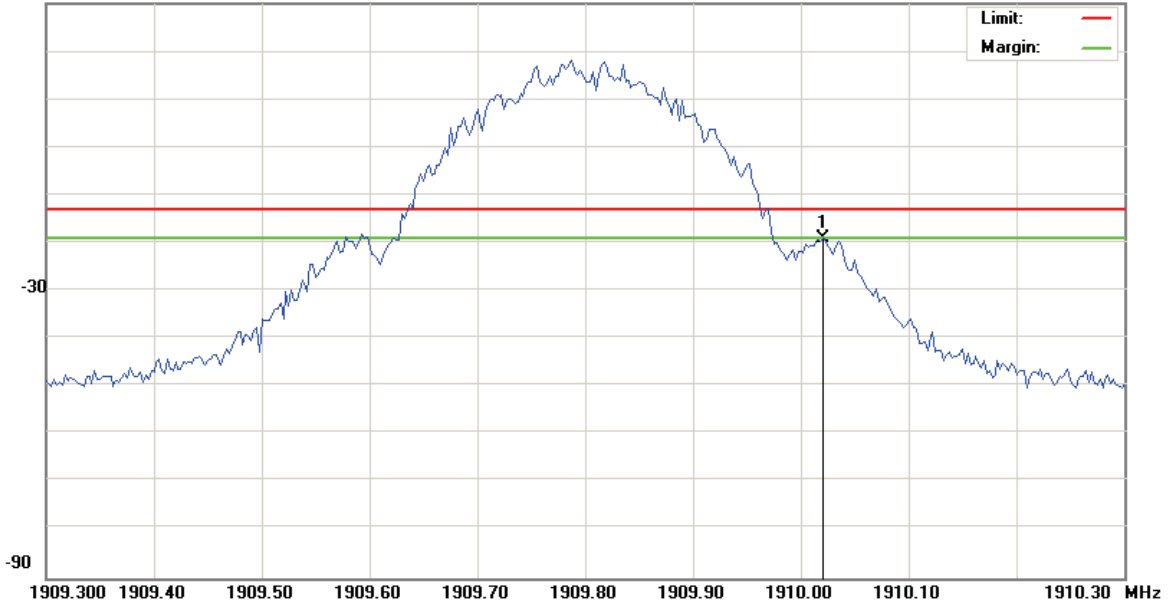

Site site#1

Polarization: *Conducted po*

Temperature: 26 °C

Limit: FCC Part 24 conducted(9k-12.75G)

Power: AC 110V/60Hz

Humidity: 55 %

EUT:

Distance:

M/N: ZG5

Mode:

Note: CH810(1909.8MHz)

加10db衰减器

No.	Mk.	Freq. MHz	Reading Level dBm	Correct Factor dB	Measure- ment dBm	Limit dBm	Over dB	Antenna Height cm	Table Degree degree	Comment
1	*	1910.020	-24.60	5.70	-18.90	-13.00	-5.90	peak		

*:Maximum data x:Over limit !:over margin

●Reference Only



4.4.5.3 WCDMA Band V Test Result

WCDMA Band V				
Band	Channel	Frequency (MHz)	Bandwidth (dBm)	Limit (dBm)
Lower	4132	824.000	-19.13	-13
Higher	4233	849.000	-16.46	-13

Please refer to next pager of detail testing data.



File :ZG5(wcdma band5)

Data :#1

Date: 2008/9/01

Time:

30.0 dBm

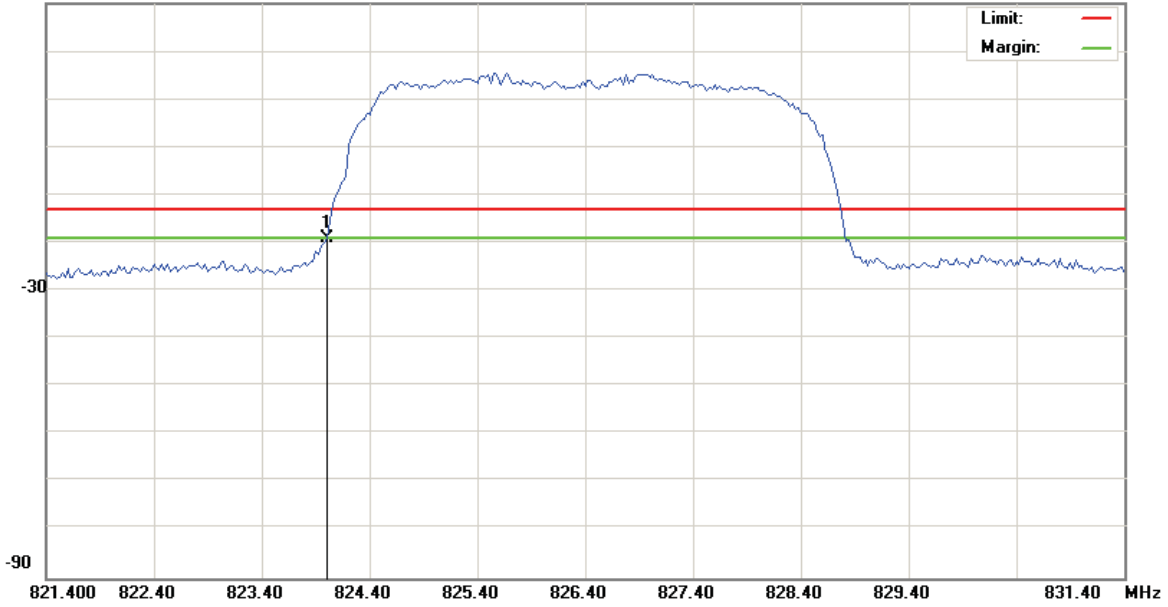

Site site#1

Polarization: *Conducted po*

Temperature: 26 °C

Limit: FCC Part 22 conducted(9k-12.75G)

Power: AC 110V/60Hz

Humidity: 55 %

EUT:

Distance:

M/N: ZG5

Mode:

Note: CH4132(824MHz)

加10db衰减器

No.	Mk.	Freq.	Reading Level	Correct Factor	Measurement	Limit	Over	Antenna Height	Table Degree
		MHz	dBm	dB	dBm	dBm	dB	cm	degree
1	*	824.0000	-32.31	13.18	-19.13	-13.00	-6.13	peak	Comment

*:Maximum data x:Over limit !:over margin

●Reference Only



File :ZG5(wcdma band5)

Data :#2

Date: 2008/9/01

Time:

30.0 dBm

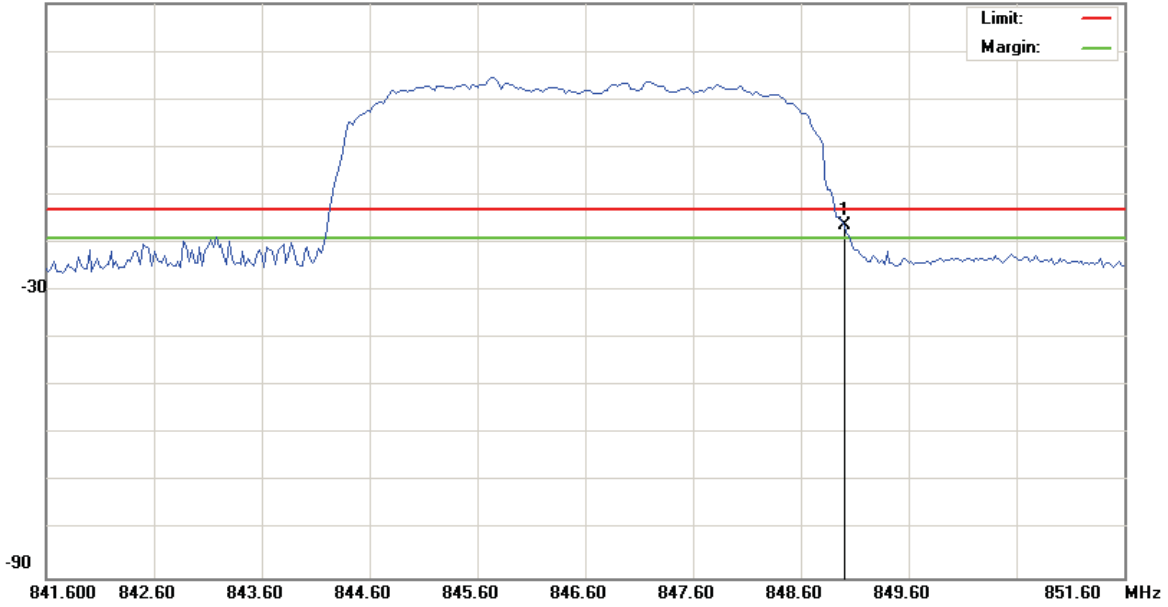

Site site#1 Polarization: **Conducted po** Temperature: 26 °C
 Limit: FCC Part 22 conducted(9k-12.75G) Power: AC 110V/60Hz Humidity: 55 %
 EUT: Distance:
 M/N: ZG5
 Mode:
 Note: CH4233(849MHz)
 加10db衰减器

No.	Mk.	Freq.	Reading Level	Correct Factor	Measurement	Limit	Over	Antenna Height	Table Degree
		MHz	dBm	dB	dBm	dBm	dB	cm	degree
1	*	849.0000	-29.71	13.25	-16.46	-13.00	-3.46	peak	

*:Maximum data x:Over limit !:over margin

●Reference Only



4.4.5.4 WCDMA Band II Test Result

WCDMA Band II				
Band	Channel	Frequency (MHz)	Bandwidth (dBm)	Limit (dBm)
Lower	9262	1850.000	-16.11	-13
Higher	9538	1910.000	-16.64	-13

Please refer to next pager of detail testing data.



File :ZG5(wcdma band2)

Data :#1

Date: 2008/9/01

Time:

30.0 dBm

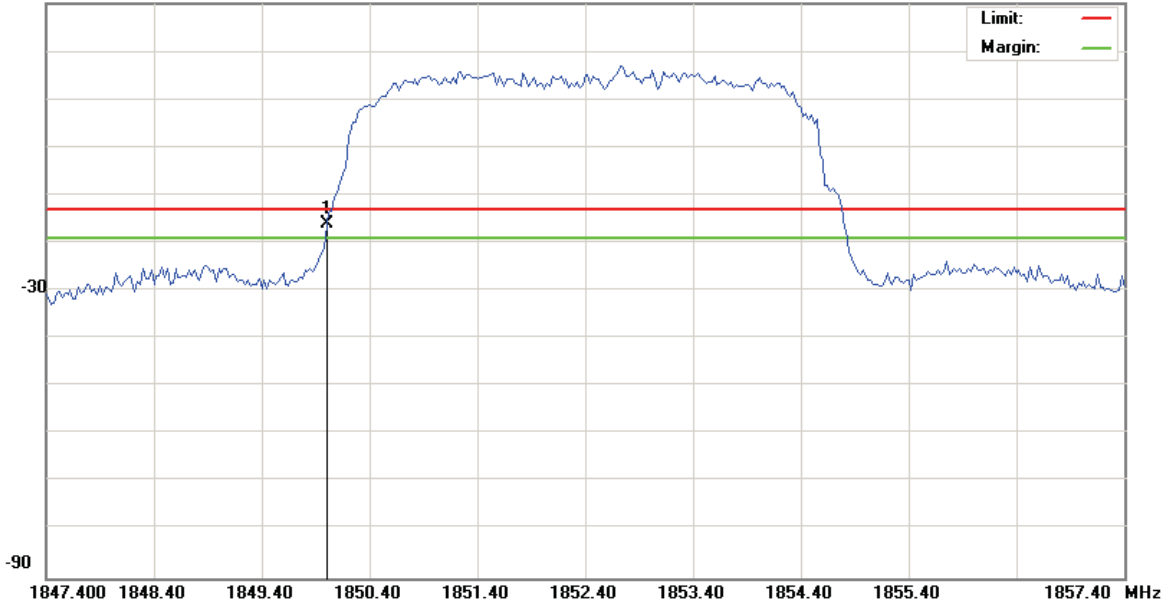

Site site#1

Polarization: *Conducted po*

Temperature: 26 °C

Limit: FCC Part 24 conducted(9k-12.75G)

Power: AC 110V/60Hz

Humidity: 55 %

EUT:

Distance:

M/N: ZG5

Mode:

Note:

加10db衰减器

No.	Mk.	Freq.	Reading Level	Correct Factor	Measurement	Limit	Over	Antenna Height	Table Degree	
		MHz	dBm	dB	dBm	dBm	dB	cm	degree	Comment
1	*	1850.000	-20.37	4.26	-16.11	-13.00	-3.11			peak

*:Maximum data x:Over limit !:over margin

●Reference Only



File :ZG5(wcdma band2)

Data :#2

Date: 2008/9/01

Time:

30.0 dBm

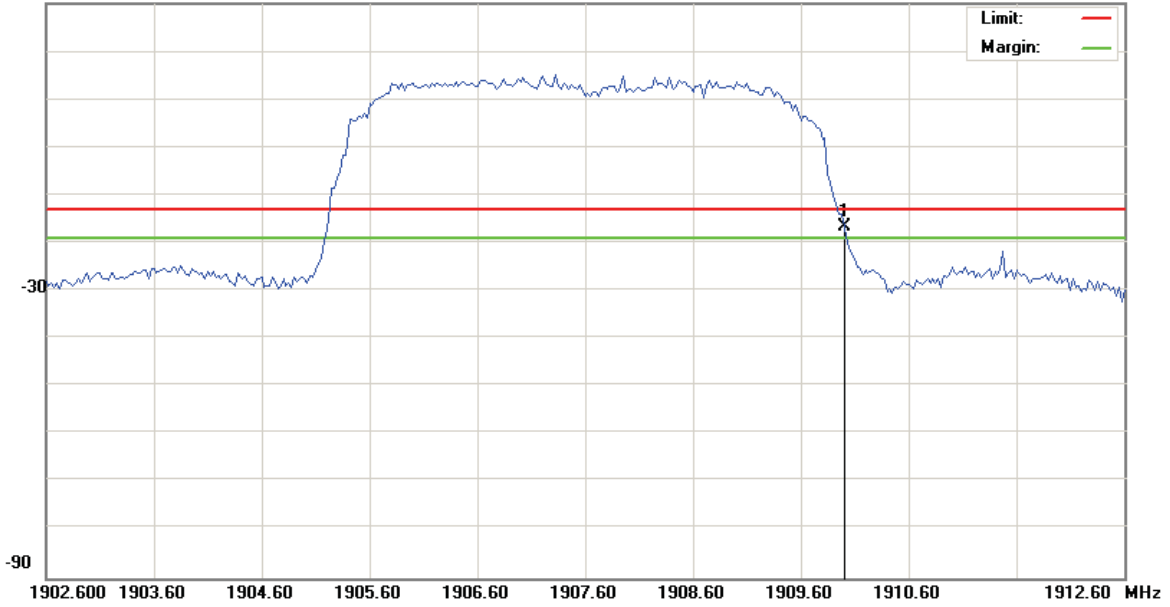

Site site#1

Polarization: *Conducted po*

Temperature: 26 °C

Limit: FCC Part 24 conducted(9k-12.75G)

Power: AC 110V/60Hz

Humidity: 55 %

EUT:

Distance:

M/N: ZG5

Mode:

Note:

加10db衰减器

No.	Mk.	Freq.	Reading Level	Correct Factor	Measurement	Limit	Over	Antenna Height	Table Degree
		MHz	dBm	dB	dBm	dBm	dB	cm	degree
1	*	1910.000	-22.34	5.70	-16.64	-13.00	-3.64	peak	

*:Maximum data x:Over limit !:over margin

●Reference Only

4.5 Conducted Emission

4.5.1 Measurement Instruments

As described in chapter 5 of this test report.

4.5.2 Test Procedure

1. The EUT was connected to Spectrum Analyzer and Base Station via power divider.
2. The middle channel for the highest RF power within the transmitting frequency was measured.
3. The conducted spurious emission for the whole frequency range was taken.
4. Test setting at GSM 850 RB>100 kHz, VB>100 kHz; PCS 1900 RB>1MHz, VB>1MHz.

4.5.3 Test Setup Layout

Below 2.8GHz

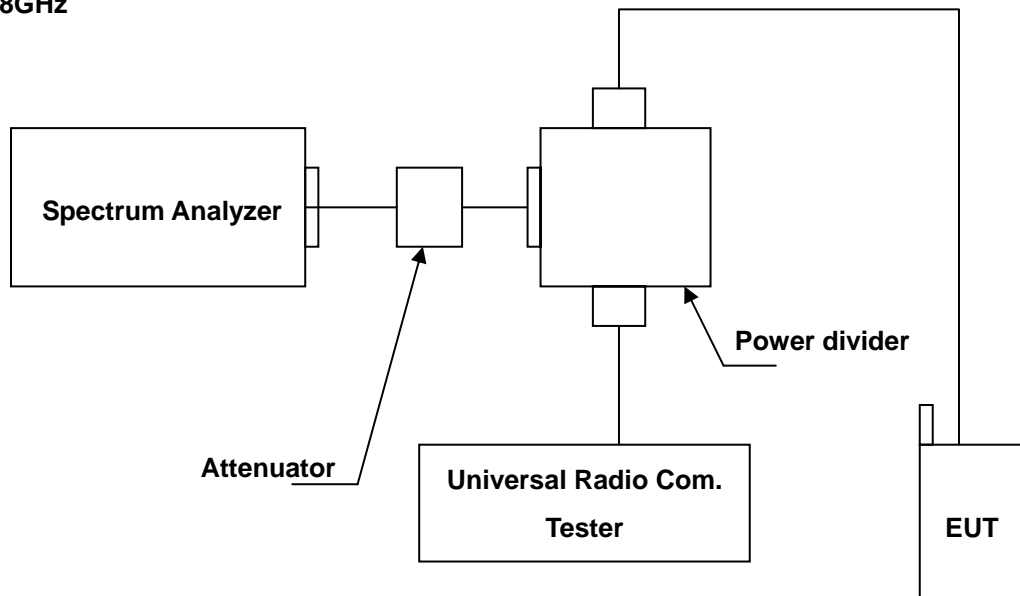

Above 2.8GHz

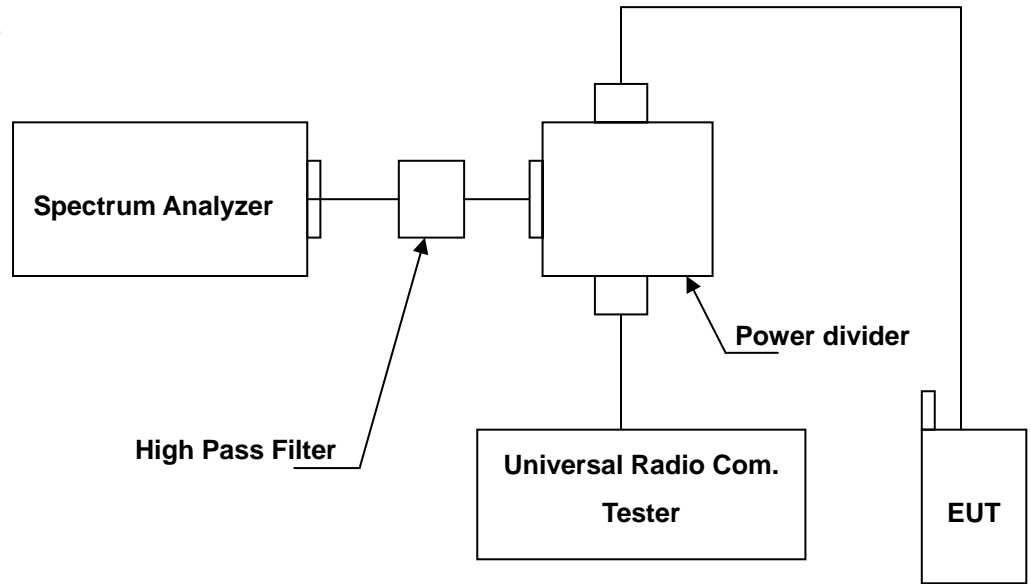



4.5.4 Test Result

4.5.4.1 GPRS 850 Test Result

Applicant : Acer Incorporated
Model No : ZG5
EUT : Notebook PC
Test Mode : GPRS 850 (Low CH128 / Middle CH190 / High CH 251)
Test Date : 08/28/2008

Please refer to next pager of detail testing data.

Note: Amplitude= Reading Amplitude + Factor (Cable loss + Filter Amplitude= Insertion loss)
(Auto calculate in spectrum analyzer)



File :ZG5(CH128)

Data :#1

Date: 2008/8/28

Time: 下午 11:04:04

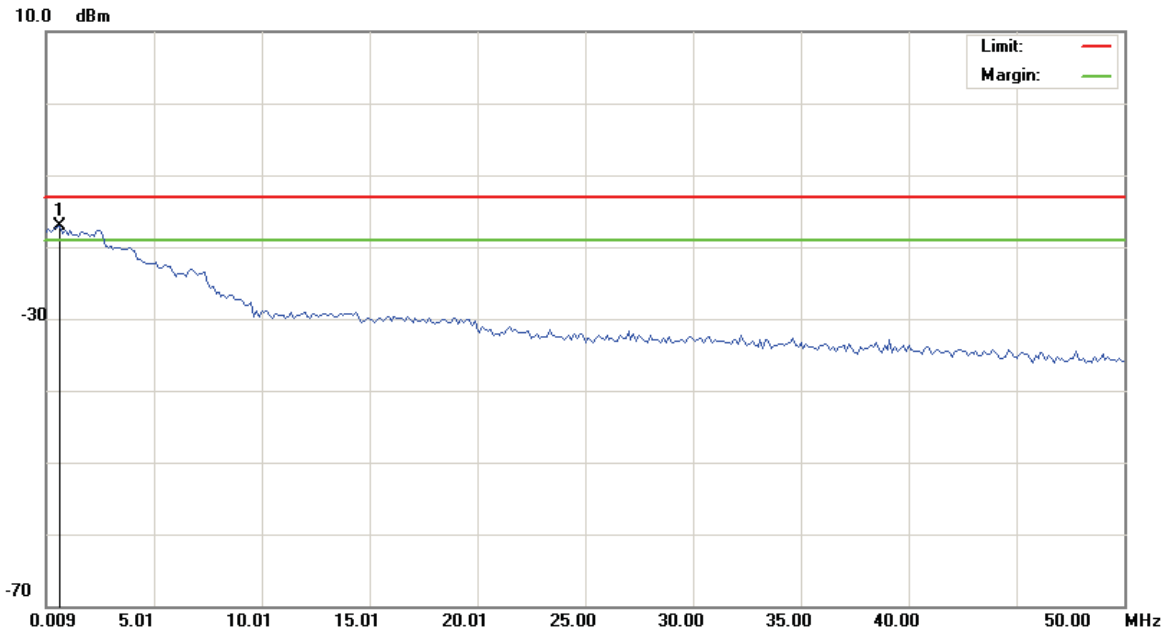

Site site#1 Polarization: **Conducted po** Temperature: 26 °C
 Limit: FCC Part 22 conducted(9k-12.75G) Power: AC 110V/60Hz Humidity: 55 %
 EUT: Distance:
 M/N: ZG5
 Mode: GSM850(GPRS)
 Note: CH128
 加Notch(3TNF-800)

No.	Mk.	Freq.	Reading Level	Correct Factor	Measurement	Limit	Over	Antenna Height	Table Degree	
		MHz	dBm	dB	dBm	dBm	dB	cm	degree	Comment
1	*	0.6339	-49.04	31.91	-17.13	-13.00	-4.13			peak

*:Maximum data x:Over limit !:over margin

●Reference Only



File :ZG5(CH128)

Data :#2

Date: 2008/8/28

Time: 下午 11:04:25

20.0 dBm

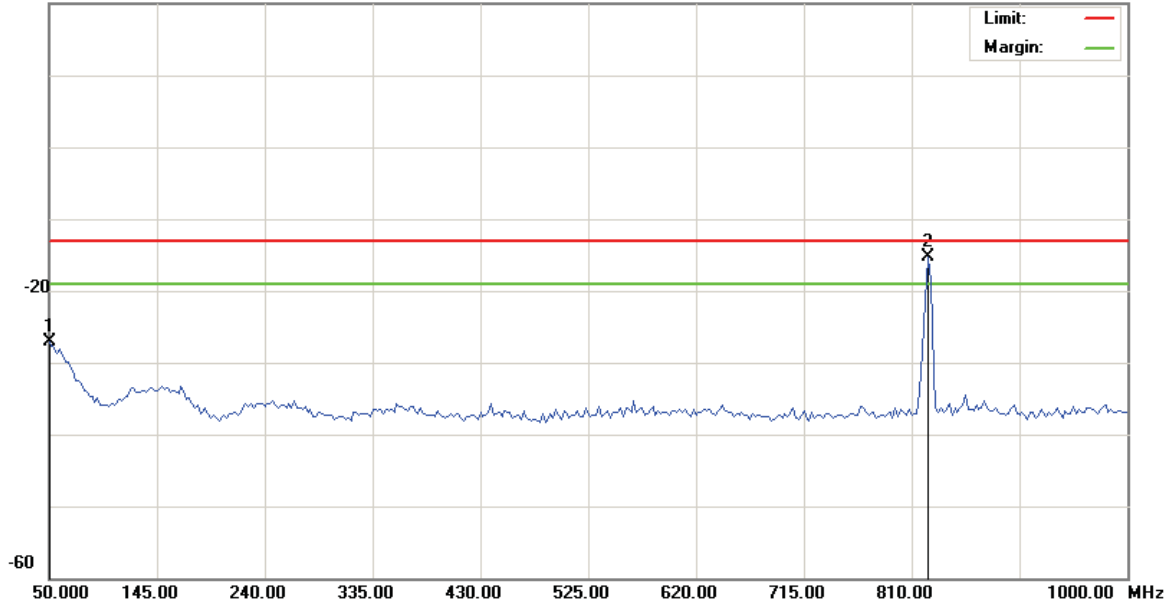

Site site#1 Polarization: **Conducted po** Temperature: 26 °C
 Limit: FCC Part 22 conducted(9k-12.75G) Power: AC 110V/60Hz Humidity: 55 %
 EUT: Distance:
 M/N: ZG5
 Mode: GSM850(GPRS)
 Note: CH128
 加Notch(3TNF-800)

No.	Mk.	Freq.	Reading Level	Correct Factor	Measurement	Limit	Over	Antenna Height	Table Degree	
		MHz	dBm	dB	dBm	dBm	dB	cm	degree	Comment
1		50.0000	-41.79	14.69	-27.10	-13.00	-14.10			peak
2	*	824.2500	-19.09	3.84	-15.25	-13.00	-2.25			peak Main Frequency

*:Maximum data x:Over limit !:over margin

●Reference Only



File :ZG5(CH128)

Data :#3

Date: 2008/8/28

Time: 下午 08:56:37

20.0 dBm

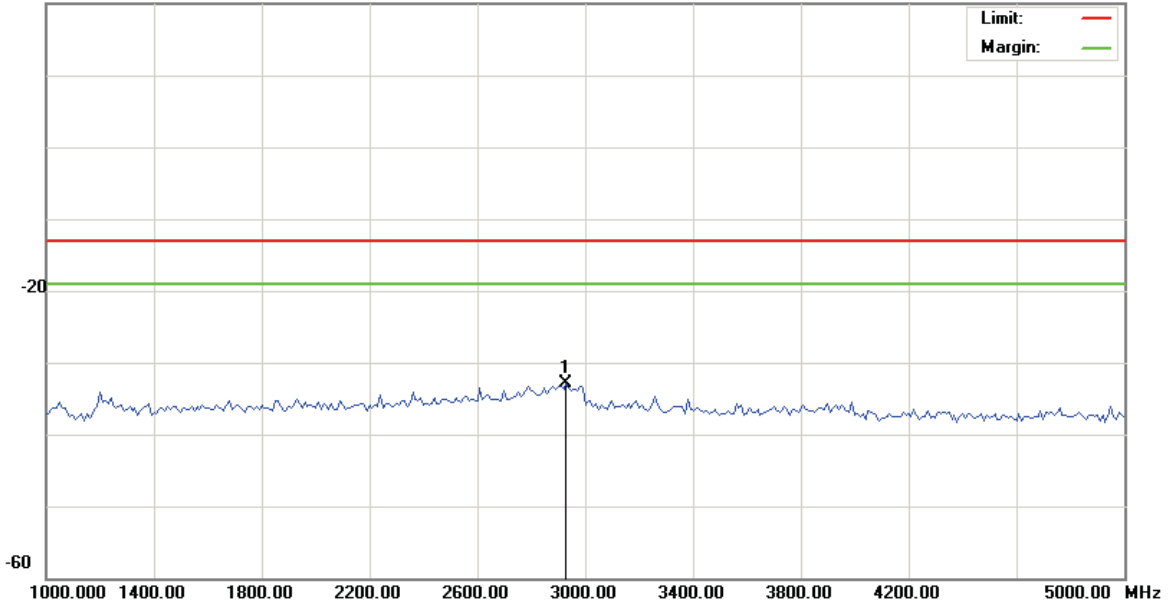

Site site#1

Polarization: *Conducted po*

Temperature: 26 °C

Limit: FCC Part 22 conducted(9k-12.75G)

Power: AC 110V/60Hz

Humidity: 55 %

EUT:

Distance:

M/N: ZG5

Mode: GSM850(GPRS)

Note: CH128

No.	Mk.	Freq.	Reading Level	Correct Factor	Measurement	Limit	Over	Antenna Height	Table Degree	
		MHz	dBm	dB	dBm	dBm	dB	cm	degree	Comment
1	*	2930.000	-37.63	4.65	-32.98	-13.00	-19.98	peak		

*:Maximum data x:Over limit !:over margin

●Reference Only



File :ZG5(CH128)

Data :#4

Date: 2008/8/28

Time: 下午 08:56:58

20.0 dBm

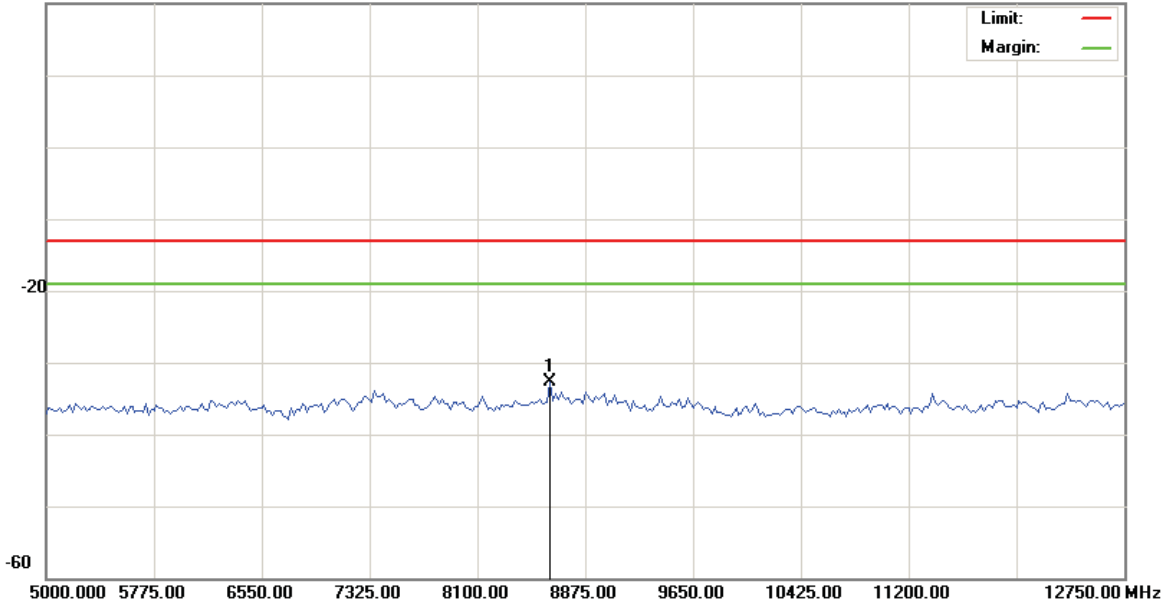

Site site#1 Polarization: **Conducted po** Temperature: 26 °C
 Limit: FCC Part 22 conducted(9k-12.75G) Power: AC 110V/60Hz Humidity: 55 %
 EUT: Distance:
 M/N: ZG5
 Mode: GSM850(GPRS)
 Note: CH128

No.	Mk.	Freq.	Reading Level	Correct Factor	Measurement	Limit	Over	Antenna Height	Table Degree
		MHz	dBm	dB	dBm	dBm	dB	cm	degree
1	*	8623.125	-38.55	5.83	-32.72	-13.00	-19.72	peak	Comment

*:Maximum data x:Over limit !:over margin

●Reference Only



File :ZG5(CH190)

Data :#1

Date: 2008/8/28

Time: 下午 11:00:28

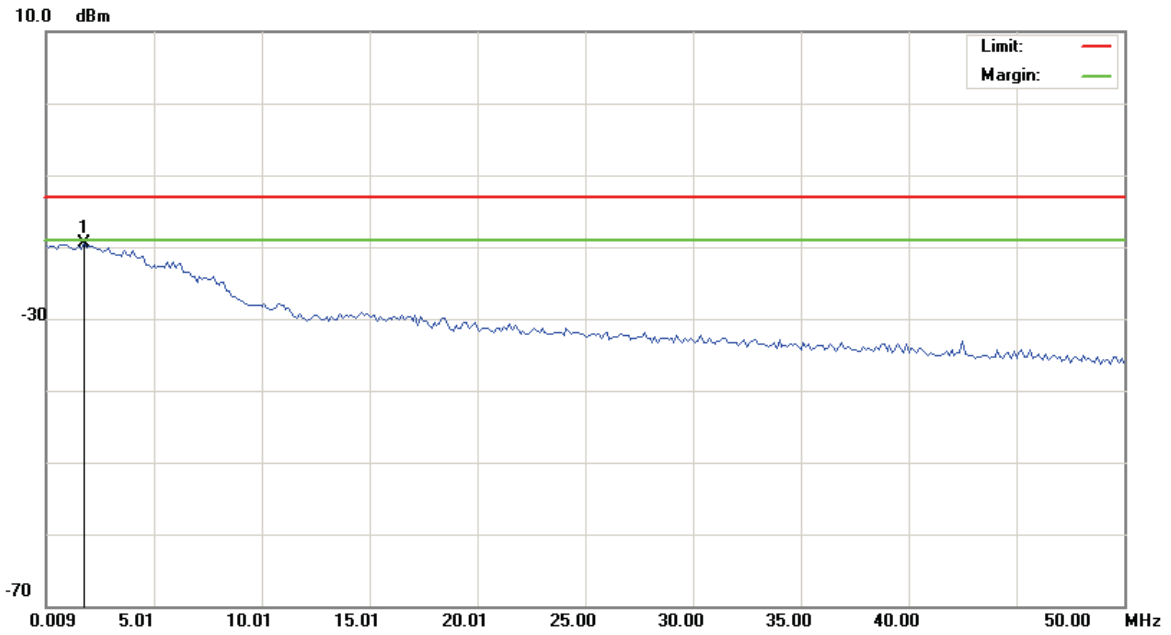

Site site#1
 Limit: FCC Part 22 conducted(9k-12.75G)
 EUT:
 M/N: ZG5
 Mode: GSM850(GPRS)
 Note: CH190
 加Notch(3TNF-800)

Polarization: *Conducted po* Temperature: 26 °C
 Power: AC 110V/60Hz Humidity: 55 %
 Distance:

No.	Mk.	Freq.	Reading Level	Correct Factor	Measurement	Limit	Over	Antenna Height	Table Degree
		MHz	dBm	dB	dBm	dBm	dB	cm	degree
1	*	1.7585	-50.63	31.05	-19.58	-13.00	-6.58	peak	

*:Maximum data x:Over limit !:over margin

●Reference Only



File :ZG5(CH190)

Data :#2

Date: 2008/8/28

Time: 下午 11:00:49

20.0 dBm

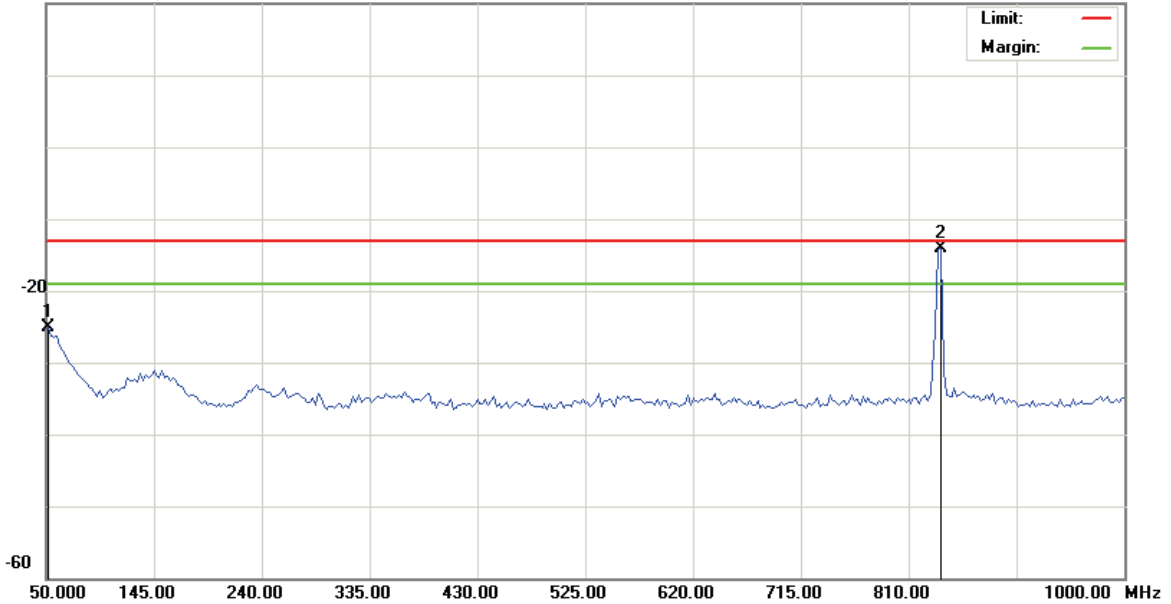

Site site#1 Polarization: **Conducted po** Temperature: 26 °C
 Limit: FCC Part 22 conducted(9k-12.75G) Power: AC 110V/60Hz Humidity: 55 %
 EUT: Distance:
 M/N: ZG5
 Mode: GSM850(GPRS)
 Note: CH190
 加Notch(3TNF-800)

No. Mk.	Freq. MHz	Reading Level dBm	Correct Factor dB	Measure- ment dBm	Limit dBm	Over dB	Antenna Height cm	Table Degree degree	Comment
1	52.3750	-39.30	14.27	-25.03	-13.00	-12.03	peak		
2 *	838.5000	-18.00	3.97	-14.03	-13.00	-1.03	peak		Main Frequency

*:Maximum data x:Over limit !:over margin

●Reference Only



File :ZG5(CH190)

Data :#3

Date: 2008/8/28

Time: 下午 08:57:45

20.0 dBm

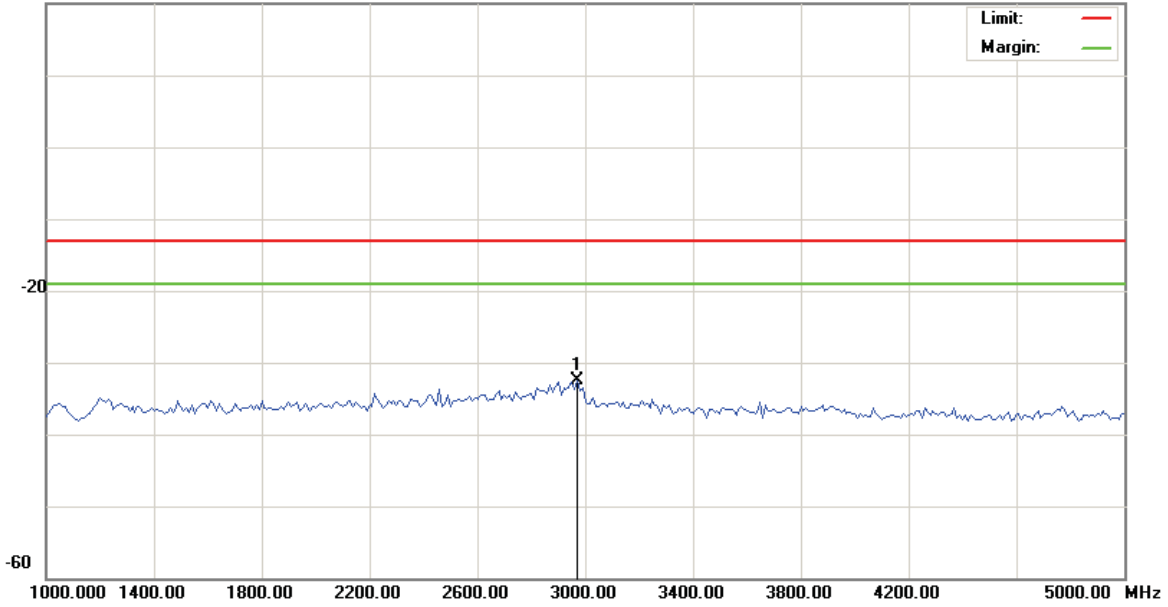

Site site#1
 Limit: FCC Part 22 conducted(9k-12.75G)
 EUT:
 M/N: ZG5
 Mode: GSM850(GPRS)
 Note: CH190

Polarization: **Conducted po**
 Power: AC 110V/60Hz
 Distance:

Temperature: 26 °C
 Humidity: 55 %

No.	Mk.	Freq. MHz	Reading Level dBm	Correct Factor dB	Measure- ment dBm	Limit dBm	Over dB	Antenna Height cm	Table Degree degree	Comment
1	*	2970.000	-36.98	4.56	-32.42	-13.00	-19.42	peak		

*:Maximum data x:Over limit !:over margin

●Reference Only

F



File :ZG5(CH190)

Data :#4

Date: 2008/8/28

Time: 下午 08:58:06

20.0 dBm

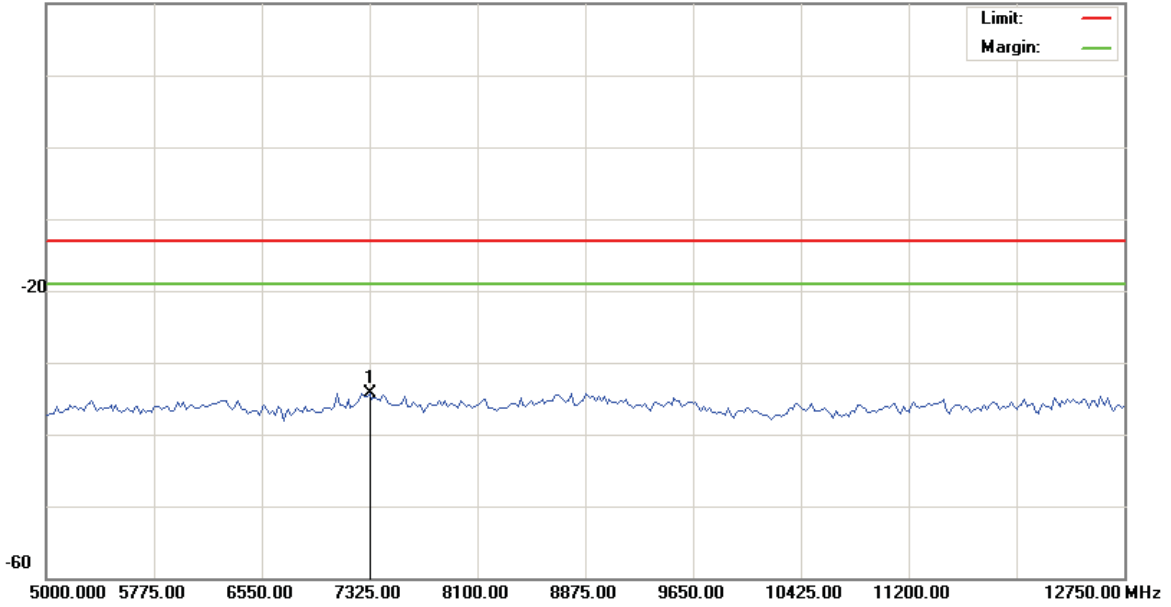

Site site#1

Polarization: *Conducted po*

Temperature: 26 °C

Limit: FCC Part 22 conducted(9k-12.75G)

Power: AC 110V/60Hz

Humidity: 55 %

EUT:

Distance:

M/N: ZG5

Mode: GSM850(GPRS)

Note: CH190

No.	Mk.	Freq.	Reading Level	Correct Factor	Measurement	Limit	Over	Antenna Height	Table Degree	
		MHz	dBm	dB	dBm	dBm	dB	cm	degree	Comment
1	*	7325.000	-39.37	5.10	-34.27	-13.00	-21.27	peak		

*:Maximum data x:Over limit !:over margin

●Reference Only



File :ZG5(CH251)

Data :#1

Date: 2008/8/28

Time: 下午 11:10:02

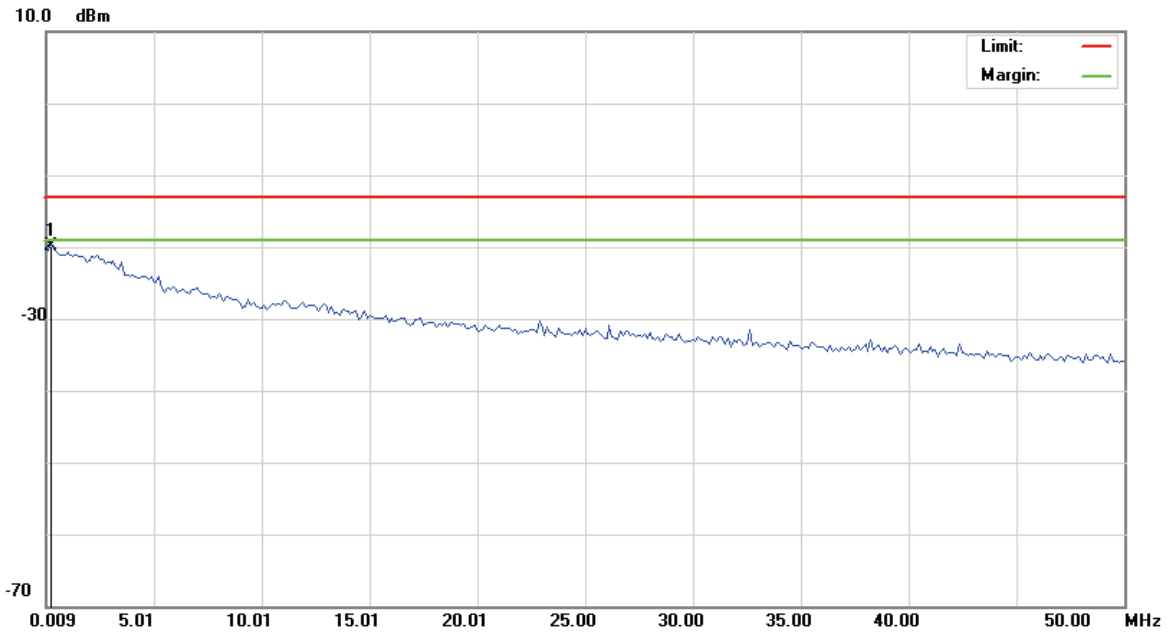

Site site#1
 Limit: FCC Part 22 conducted(9k-12.75G)
 EUT:
 M/N: ZG5
 Mode: GSM850(GPRS)
 Note: CH251
 加Notch(3TNF-800)

Polarization: **Conducted po** Temperature: 26 °C
 Power: AC 110V/60Hz Humidity: 55 %
 Distance:

No.	Mk.	Freq.	Reading Level	Correct Factor	Measurement	Limit	Over	Antenna Height	Table Degree	
		MHz	dBm	dB	dBm	dBm	dB	cm	degree	Comment
1	*	0.2590	-51.20	31.40	-19.80	-13.00	-6.80			peak

*:Maximum data x:Over limit !:over margin

●Reference Only



File :ZG5(CH251)

Data :#2

Date: 2008/8/28

Time: 下午 11:10:23

20.0 dBm

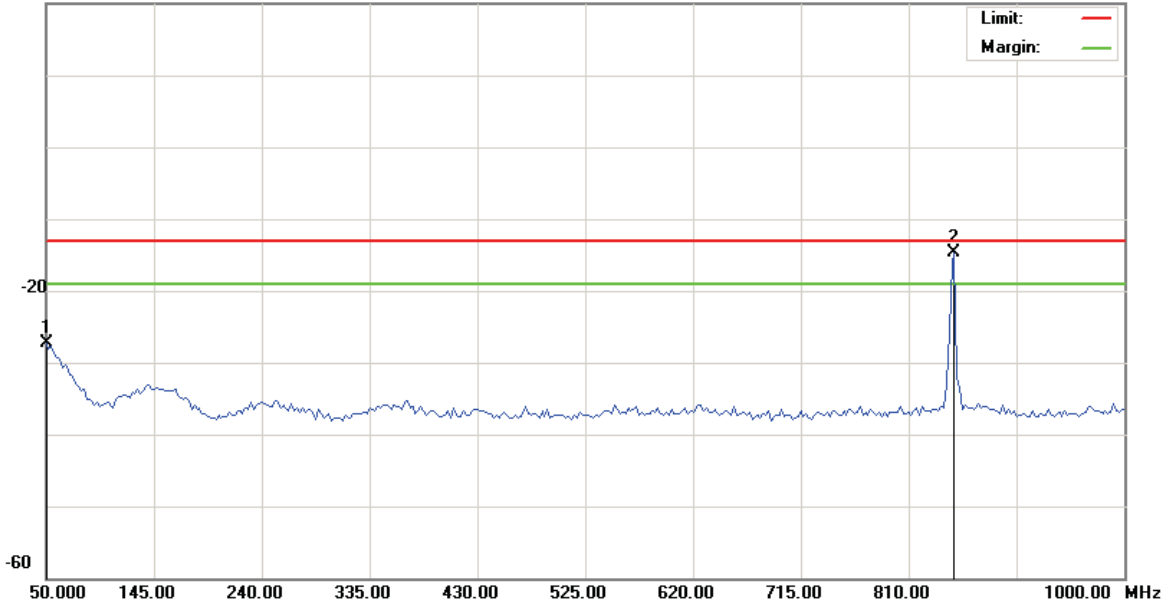

Site site#1

Polarization: *Conducted po*

Temperature: 26 °C

Limit: FCC Part 22 conducted(9k-12.75G)

Power: AC 110V/60Hz

Humidity: 55 %

EUT:

Distance:

M/N: ZG5

Mode: GSM850(GPRS)

Note: CH251

加Notch(3TNF-800)

No.	Mk.	Freq.	Reading Level	Correct Factor	Measurement	Limit	Over	Antenna Height	Table Degree	
		MHz	dBm	dB	dBm	dBm	dB	cm	degree	Comment
1		50.0000	-41.98	14.69	-27.29	-13.00	-14.29	peak		
2	*	850.3750	-18.59	3.98	-14.61	-13.00	-1.61	peak		主頻

*:Maximum data x:Over limit !:over margin

●Reference Only



File :ZG5(CH251)

Data :#3

Date: 2008/8/28

Time: 下午 08:58:45

20.0 dBm

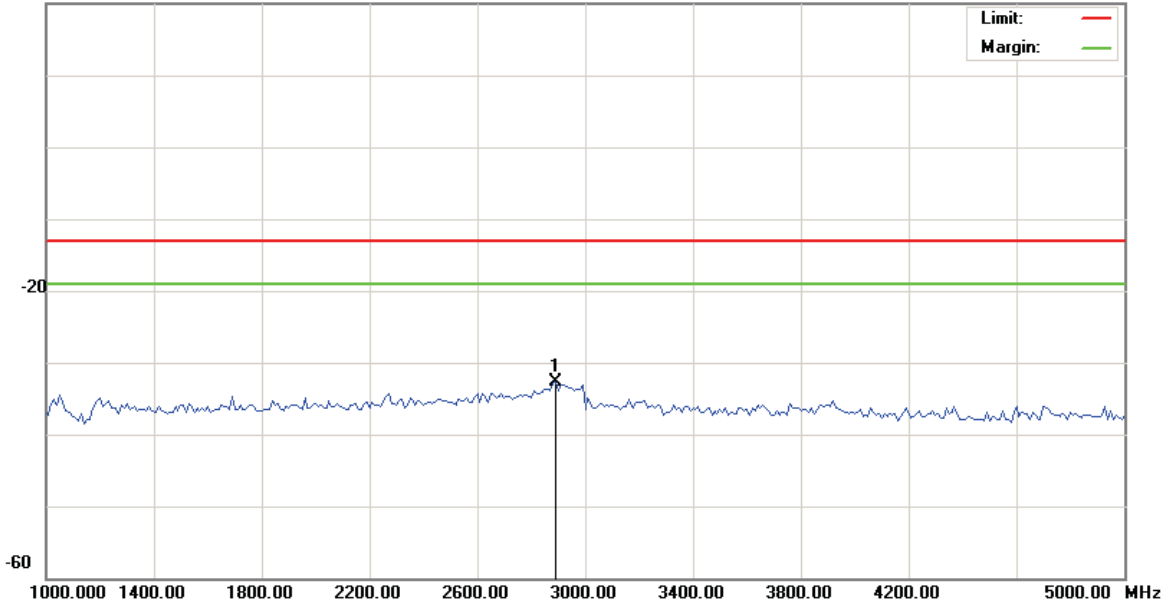

Site site#1

Polarization: **Conducted po**

Temperature: 26 °C

Limit: FCC Part 22 conducted(9k-12.75G)

Power: AC 110V/60Hz

Humidity: 55 %

EUT:

Distance:

M/N: ZG5

Mode: GSM850(GPRS)

Note: CH251

No.	Mk.	Freq.	Reading Level	Correct Factor	Measurement	Limit	Over	Antenna Height	Table Degree
		MHz	dBm	dB	dBm	dBm	dB	cm	degree
1	*	2890.000	-37.48	4.71	-32.77	-13.00	-19.77	peak	Comment

*:Maximum data x:Over limit !:over margin

●Reference Only



File :ZG5(CH251)

Data :#4

Date: 2008/8/28

Time: 下午 08:59:06

20.0 dBm

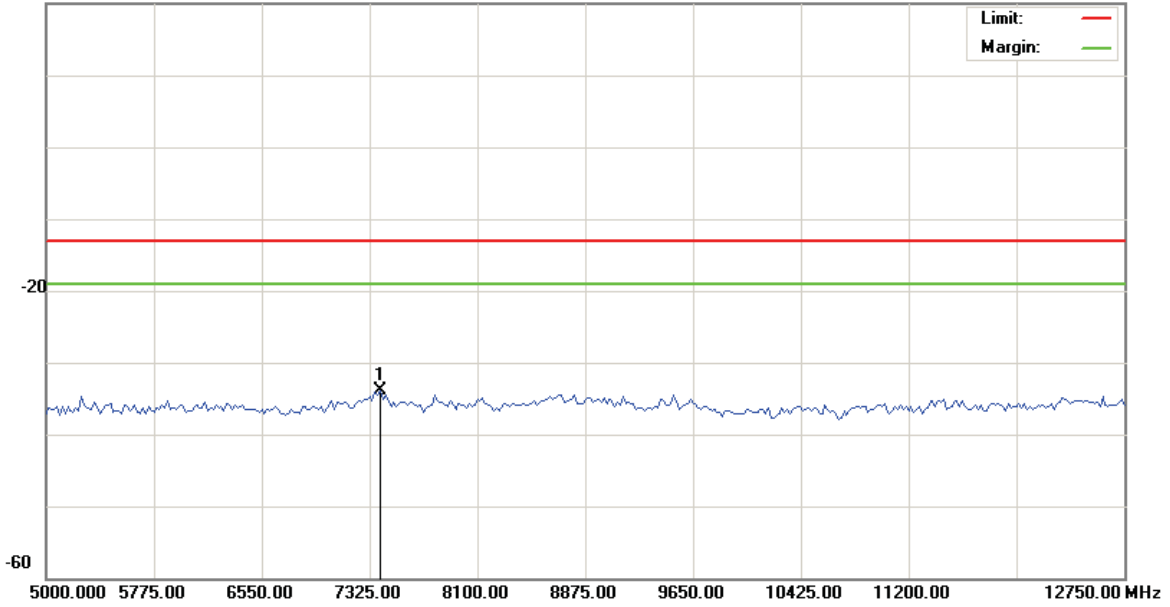

Site site#1
 Limit: FCC Part 22 conducted(9k-12.75G)
 EUT:
 M/N: ZG5
 Mode: GSM850(GPRS)
 Note: CH251

Polarization: **Conducted po**
 Power: AC 110V/60Hz
 Distance:

Temperature: 26 °C
 Humidity: 55 %

No.	Mk.	Freq.	Reading Level	Correct Factor	Measurement	Limit	Over	Antenna Height	Table Degree	
		MHz	dBm	dB	dBm	dBm	dB	cm	degree	Comment
1	*	7402.500	-39.15	5.20	-33.95	-13.00	-20.95			peak

*:Maximum data x:Over limit !:over margin

●Reference Only



4.5.4.2 GPRS 1900 Test Result

Applicant : Acer Incorporated

Model No : ZG5

EUT : Notebook PC

Test Mode : GPRS 1900 (Low CH512 / Middle CH661 / High CH 810)

Test Date : 08/28/2008

Please refer to next pager of detail testing data.

Note: Amplitude= Reading Amplitude + Factor (Cable loss + Filter Amplitude= Insertion loss)

(Auto calculate in spectrum analyzer)



File :ZG5(CH512)

Data :#1

Date: 2008/8/28

Time: 下午 09:34:05

10.0 dBm

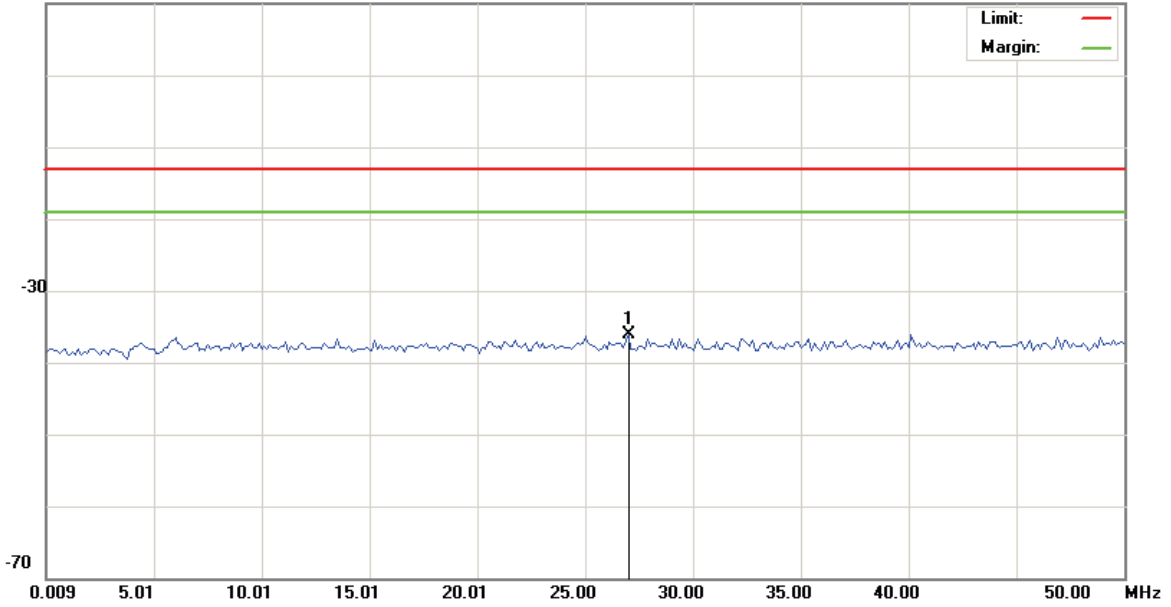

Site site#1 Polarization: **Conducted po** Temperature: 26 °C
 Limit: FCC Part 24 conducted(9k-12.75G) Power: AC 110V/60Hz Humidity: 55 %
 EUT: Distance:
 M/N: ZG5
 Mode: PCS1900(GPRS)
 Note: CH512
 加10db衰减器

No.	Mk.	Freq.	Reading Level	Correct Factor	Measurement	Limit	Over	Antenna Height	Table Degree
		MHz	dBm	dB	dBm	dBm	dB	cm	degree
1	*	27.0041	-49.41	13.27	-36.14	-13.00	-23.14	peak	Comment

*:Maximum data x:Over limit !:over margin

●Reference Only



File :ZG5(CH512)

Data :#2

Date: 2008/8/28

Time: 下午 09:34:26

20.0 dBm

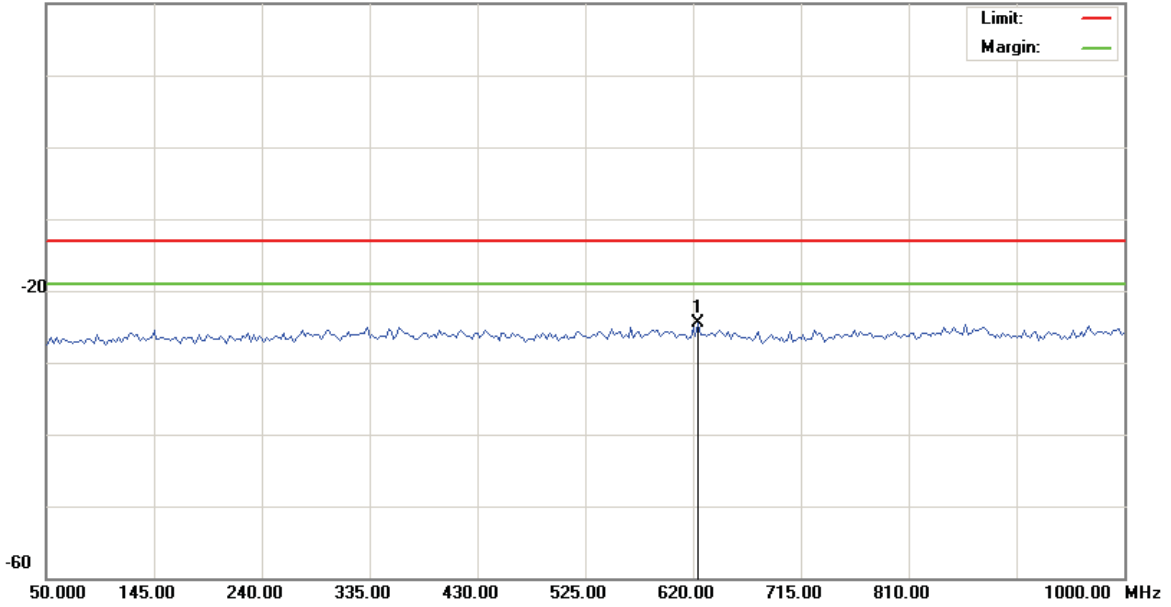

Site site#1

Polarization: **Conducted po**

Temperature: 26 °C

Limit: FCC Part 24 conducted(9k-12.75G)

Power: AC 110V/60Hz

Humidity: 55 %

EUT:

Distance:

M/N: ZG5

Mode: PCS1900(GPRS)

Note: CH512

加10db衰减器

No.	Mk.	Freq.	Reading Level	Correct Factor	Measurement	Limit	Over	Antenna Height	Table Degree	
		MHz	dBm	dB	dBm	dBm	dB	cm	degree	Comment
1	*	624.7500	-37.53	13.10	-24.43	-13.00	-11.43	peak		

*:Maximum data x:Over limit !:over margin

●Reference Only



File :ZG5(CH512)

Data :#3

Date: 2008/8/28

Time: 下午 09:54:14

20.0 dBm



Site site#1 Polarization: **Conducted po** Temperature: 26 °C
 Limit: FCC Part 24 conducted(9k-12.75G) Power: AC 110V/60Hz Humidity: 55 %
 EUT: Distance:
 M/N: ZG5
 Mode: PCS1900(GPRS)
 Note: CH512
 加Notch(5TNF-1700)

No.	Mk.	Freq.	Reading Level	Correct Factor	Measurement	Limit	Over	Antenna Height	Table Degree	
		MHz	dBm	dB	dBm	dBm	dB	cm	degree	Comment
1	*	1850.500	-8.90	4.26	-4.64	-13.00	8.36	peak		Main Frequency
2		2413.000	-37.19	5.16	-32.03	-13.00	-19.03	peak		

*:Maximum data x:Over limit !:over margin

●Reference Only



File :ZG5(CH512)

Data :#4

Date: 2008/8/28

Time: 下午 08:48:10

20.0 dBm

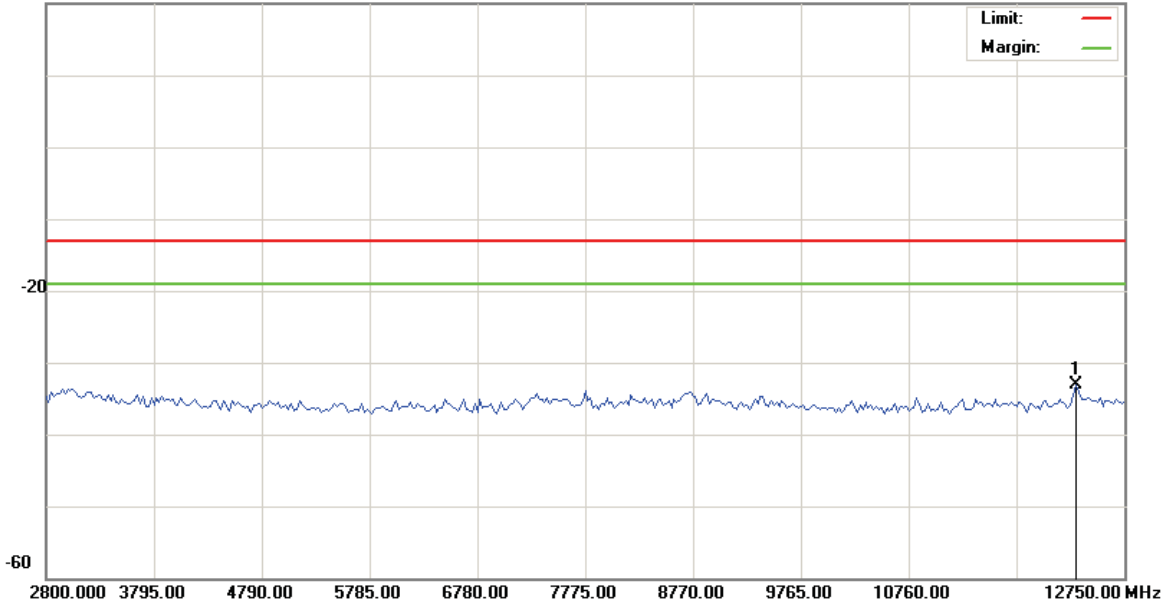

Site site#1 Polarization: **Conducted po** Temperature: 26 °C
 Limit: FCC Part 24 conducted(9k-12.75G) Power: AC 110V/60Hz Humidity: 55 %
 EUT: Distance:
 M/N: ZG5
 Mode: PCS1900(GPRS)
 Note: CH512

No.	Mk.	Freq.	Reading Level	Correct Factor	Measurement	Limit	Over	Antenna Height	Table Degree
		MHz	dBm	dB	dBm	dBm	dB	cm	degree
1	*	12302.25	-38.37	5.19	-33.18	-13.00	-20.18	peak	

*:Maximum data x:Over limit !:over margin

●Reference Only



File :ZG5(CH512)

Data :#5

Date: 2008/8/28

Time: 下午 08:48:31

20.0 dBm

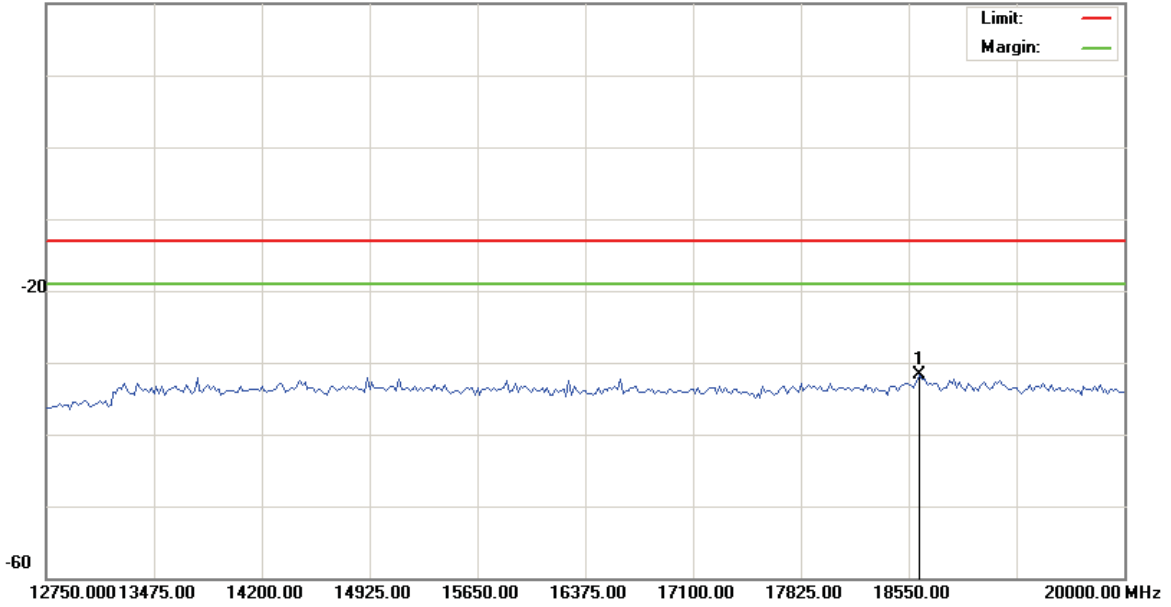

Site site#1
 Limit: FCC Part 24 conducted(9k-12.75G)
 EUT:
 M/N: ZG5
 Mode: PCS1900(GPRS)
 Note: CH512

Polarization: **Conducted po**
 Power: AC 110V/60Hz
 Distance:

Temperature: 26 °C
 Humidity: 55 %

No.	Mk.	Freq. MHz	Reading Level dBm	Correct Factor dB	Measure- ment dBm	Limit dBm	Over dB	Antenna Height cm	Table Degree degree	Comment
1	*	18622.50	-38.74	7.05	-31.69	-13.00	-18.69	peak		

*:Maximum data x:Over limit !:over margin

●Reference Only



File :ZG5(CH661)

Data :#1

Date: 2008/8/28

Time: 下午 09:36:02

10.0 dBm

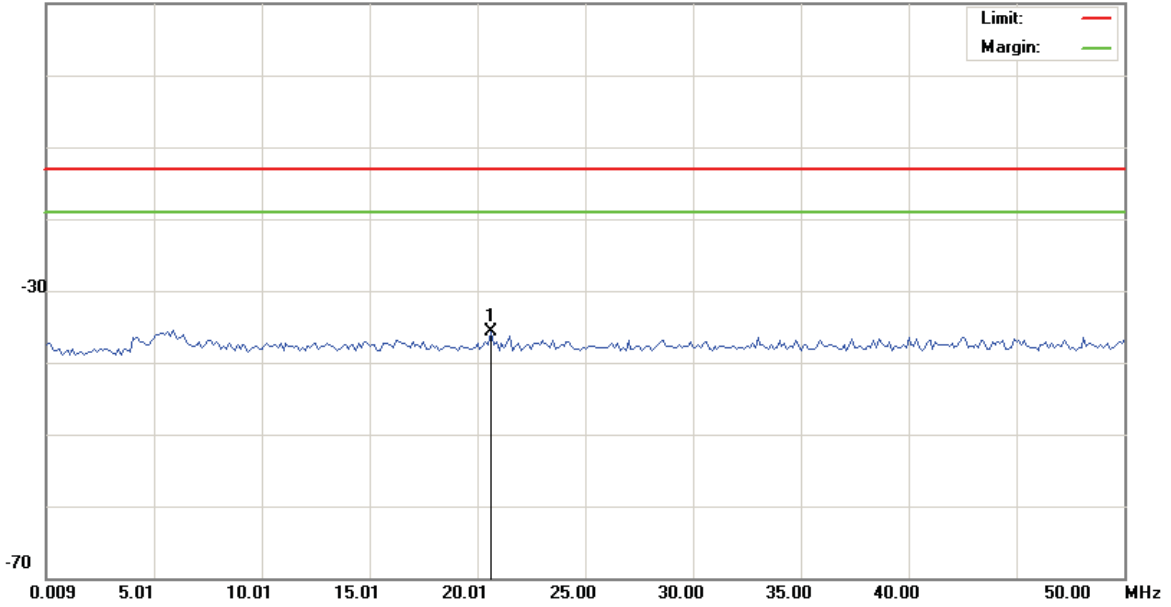

Site site#1

Polarization: *Conducted po*

Temperature: 26 °C

Limit: FCC Part 24 conducted(9k-12.75G)

Power: AC 110V/60Hz

Humidity: 55 %

EUT:

Distance:

M/N: ZG5

Mode: PCS1900(GPRS)

Note: CH661

加10db衰减器

No.	Mk.	Freq.	Reading Level	Correct Factor	Measurement	Limit	Over	Antenna Height	Table Degree	
		MHz	dBm	dB	dBm	dBm	dB	cm	degree	Comment
1	*	20.6302	-48.95	13.28	-35.67	-13.00	-22.67	peak		

*:Maximum data x:Over limit !:over margin

●Reference Only



File :ZG5(CH661)

Data :#2

Date: 2008/8/28

Time: 下午 09:36:23

20.0 dBm

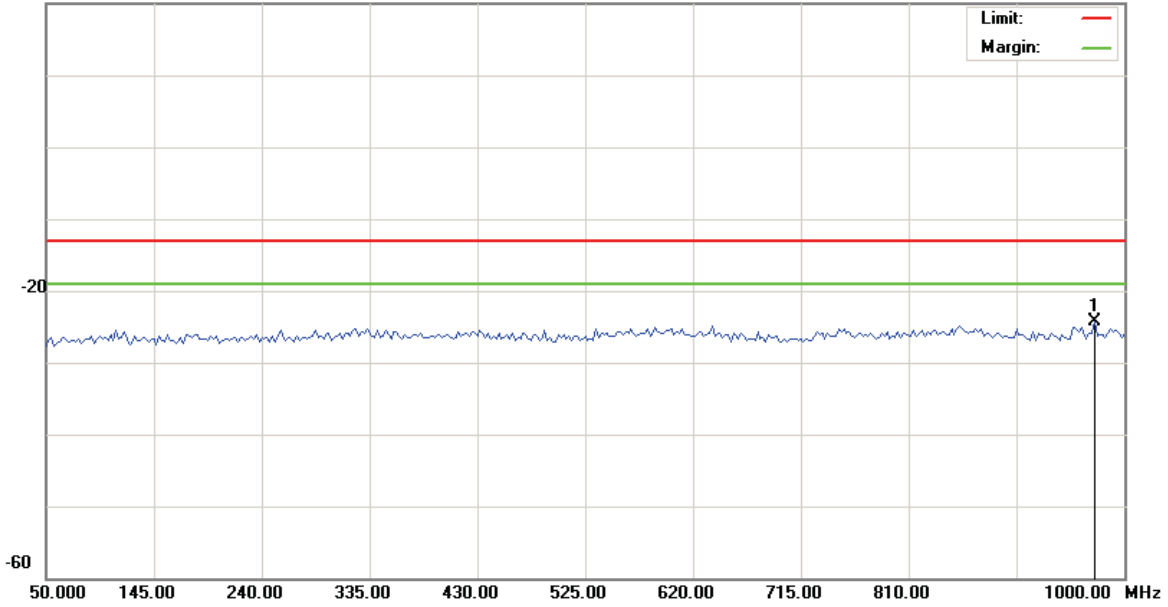

Site site#1 Polarization: **Conducted po** Temperature: 26 °C
 Limit: FCC Part 24 conducted(9k-12.75G) Power: AC 110V/60Hz Humidity: 55 %
 EUT: Distance:
 M/N: ZG5
 Mode: PCS1900(GPRS)
 Note: CH661
 加10db衰减器

No.	Mk.	Freq.	Reading Level	Correct Factor	Measurement	Limit	Over	Antenna Height	Table Degree	
		MHz	dBm	dB	dBm	dBm	dB	cm	degree	Comment
1	*	973.8750	-37.53	13.17	-24.36	-13.00	-11.36	peak		

*:Maximum data x:Over limit !:over margin

●Reference Only



File :ZG5(CH661)

Data :#3

Date: 2008/8/28

Time: 下午 09:57:07

20.0 dBm

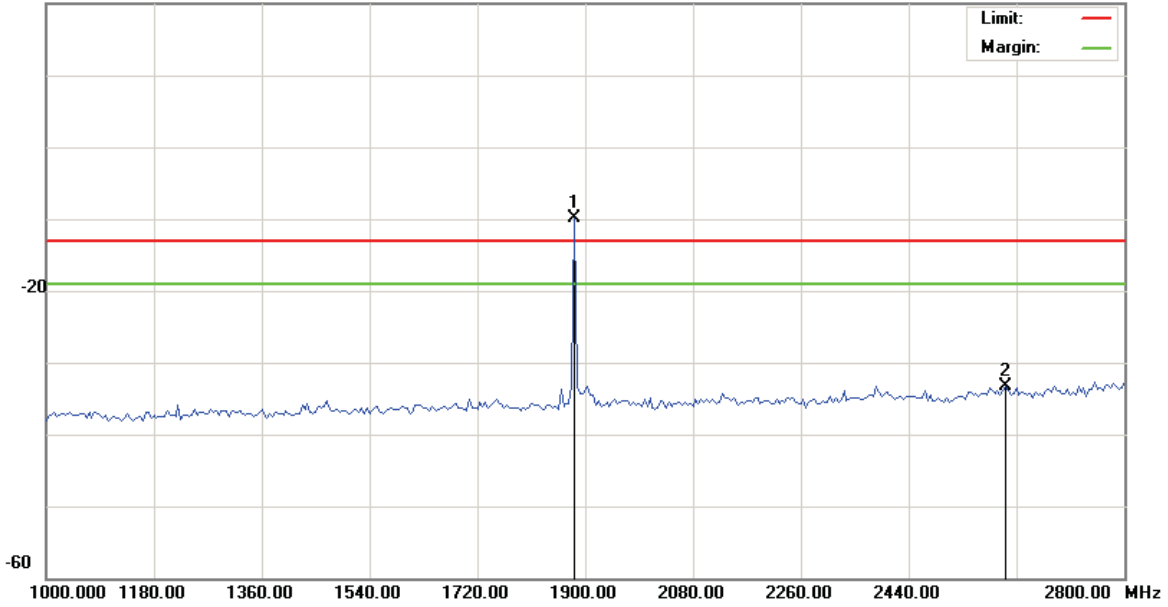

Site site#1 Polarization: **Conducted po** Temperature: 26 °C
 Limit: FCC Part 24 conducted(9k-12.75G) Power: AC 110V/60Hz Humidity: 55 %
 EUT: Distance:
 M/N: ZG5
 Mode: PCS1900(GPRS)
 Note: CH661
 加Notch(5TNF-1700)

No.	Mk.	Freq.	Reading Level	Correct Factor	Measurement	Limit	Over	Antenna Height	Table Degree	
		MHz	dBm	dB	dBm	dBm	dB	cm	degree	Comment
1	*	1882.000	-14.82	4.83	-9.99	-13.00	3.01	peak		Main Frequency
2		2602.000	-38.78	5.45	-33.33	-13.00	-20.33	peak		

*:Maximum data x:Over limit !:over margin

●Reference Only



File :ZG5(CH661)

Data :#4

Date: 2008/8/28

Time: 下午 08:49:38

20.0 dBm

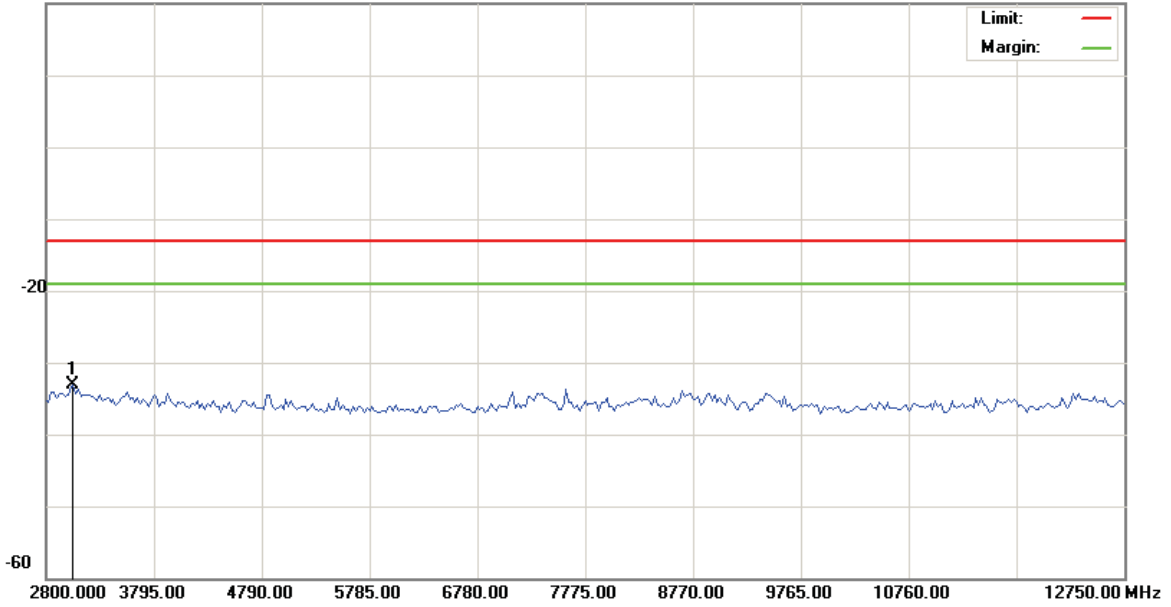

Site site#1
 Limit: FCC Part 24 conducted(9k-12.75G)
 EUT:
 M/N: ZG5
 Mode: PCS1900(GPRS)
 Note: CH661

Polarization: *Conducted po*
 Power: AC 110V/60Hz
 Distance:

Temperature: 26 °C
 Humidity: 55 %

No.	Mk.	Freq.	Reading Level	Correct Factor	Measurement	Limit	Over	Antenna Height	Table Degree	
		MHz	dBm	dB	dBm	dBm	dB	cm	degree	Comment
1	*	3048.750	-38.60	5.47	-33.13	-13.00	-20.13			peak

*:Maximum data x:Over limit !:over margin

●Reference Only



File :ZG5(CH661)

Data :#5

Date: 2008/8/28

Time: 下午 08:49:59

20.0 dBm

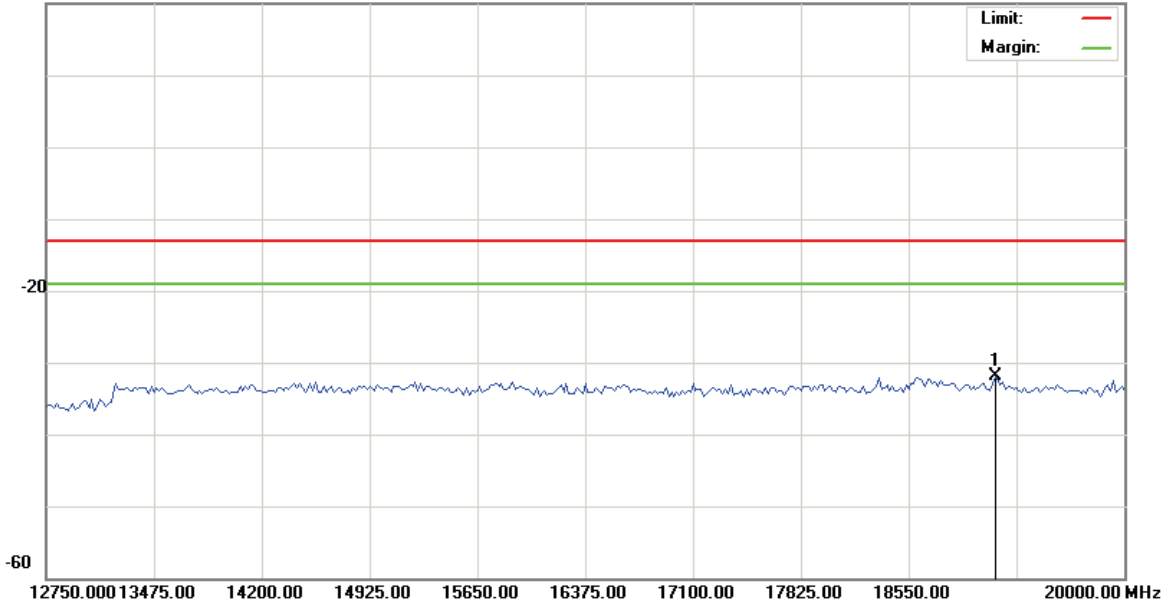

Site site#1
 Limit: FCC Part 24 conducted(9k-12.75G)
 EUT:
 M/N: ZG5
 Mode: PCS1900(GPRS)
 Note: CH661

Polarization: **Conducted po**
 Power: AC 110V/60Hz
 Distance:

Temperature: 26 °C
 Humidity: 55 %

No.	Mk.	Freq. MHz	Reading Level dBm	Correct Factor dB	Measure- ment dBm	Limit dBm	Over dB	Antenna Height cm	Table Degree degree	Comment
1	*	19130.00	-39.02	7.19	-31.83	-13.00	-18.83	peak		

*:Maximum data x:Over limit !:over margin

●Reference Only



File :ZG5(CH810)

Data :#1

Date: 2008/8/28

Time: 下午 09:37:40

10.0 dBm

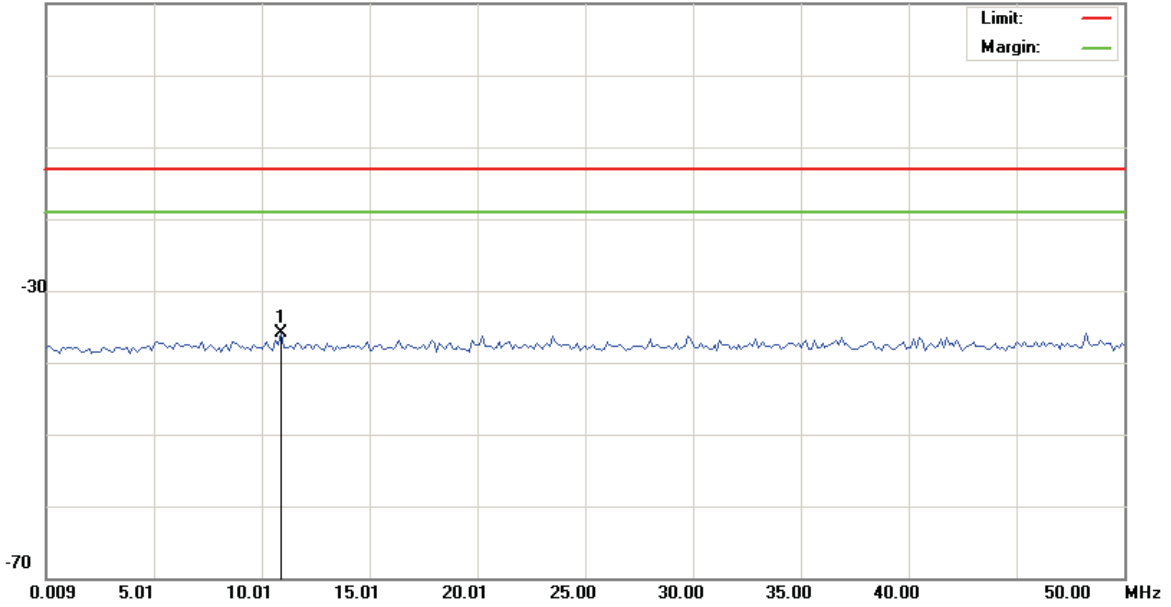

Site site#1

Polarization: **Conducted po**

Temperature: 26 °C

Limit: FCC Part 24 conducted(9k-12.75G)

Power: AC 110V/60Hz

Humidity: 55 %

EUT:

Distance:

M/N: ZG5

Mode: PCS1900(GPRS)

Note: CH810

加10db衰减器

No.	Mk.	Freq.	Reading Level	Correct Factor	Measurement	Limit	Over	Antenna Height	Table Degree	
		MHz	dBm	dB	dBm	dBm	dB	cm	degree	Comment
1	*	10.8819	-49.12	13.29	-35.83	-13.00	-22.83	peak		

*:Maximum data x:Over limit !:over margin

●Reference Only



File :ZG5(CH810)

Data :#2

Date: 2008/8/28

Time: 下午 09:38:02

20.0 dBm

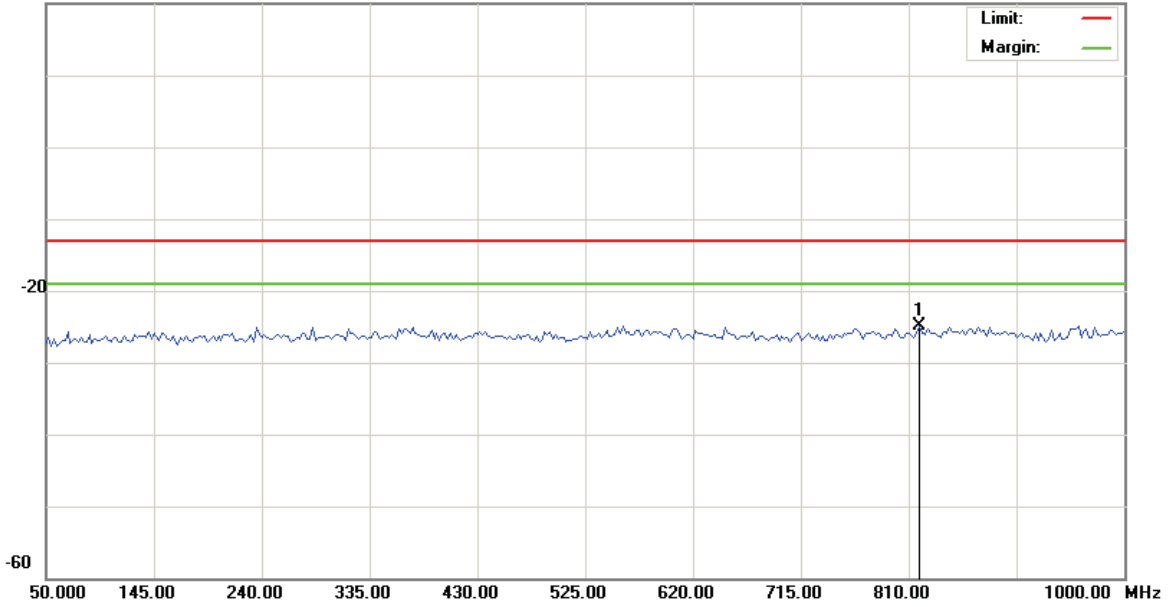

Site site#1 Polarization: **Conducted po** Temperature: 26 °C
 Limit: FCC Part 24 conducted(9k-12.75G) Power: AC 110V/60Hz Humidity: 55 %
 EUT: Distance:
 M/N: ZG5
 Mode: PCS1900(GPRS)
 Note: CH810
 加10db衰减器

No.	Mk.	Freq.	Reading Level	Correct Factor	Measurement	Limit	Over	Antenna Height	Table Degree
		MHz	dBm	dB	dBm	dBm	dB	cm	degree
1	*	819.5000	-38.10	13.20	-24.90	-13.00	-11.90	peak	Comment

*:Maximum data x:Over limit !:over margin

●Reference Only



File :ZG5(CH810)

Data :#3

Date: 2008/8/28

Time: 下午 09:59:33

20.0 dBm

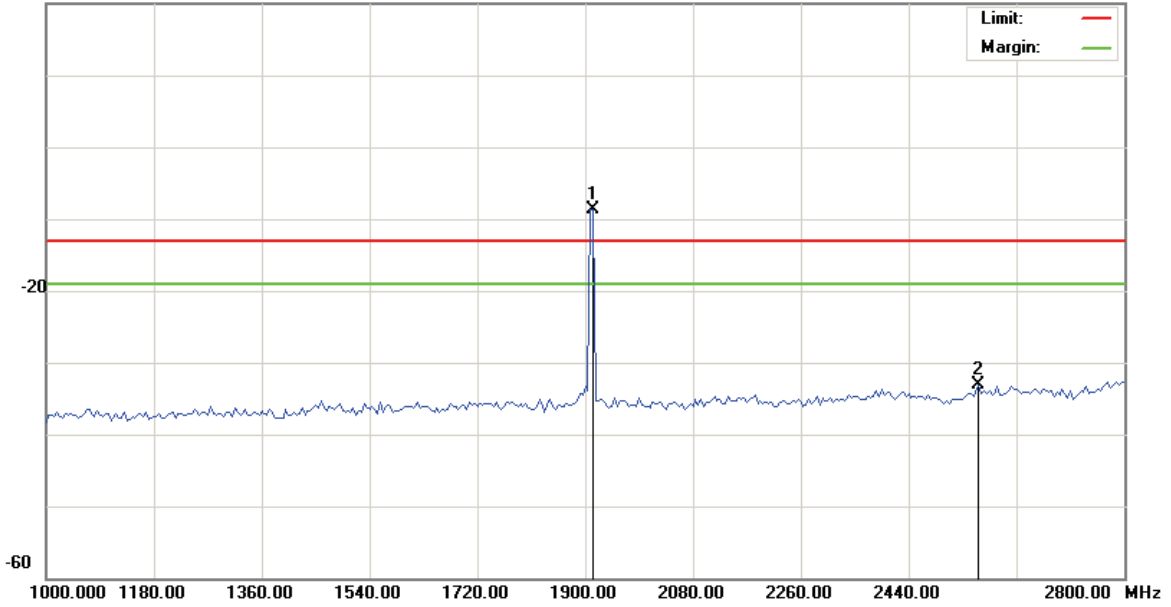

Site site#1 Polarization: *Conducted po* Temperature: 26 °C
 Limit: FCC Part 24 conducted(9k-12.75G) Power: AC 110V/60Hz Humidity: 55 %
 EUT: Distance:
 M/N: ZG5
 Mode: PCS1900(GPRS)
 Note: CH810
 加Notch(5TNF-1700)

No.	Mk.	Freq.	Reading Level	Correct Factor	Measurement	Limit	Over	Antenna Height	Table Degree	Comment
		MHz	dBm	dB	dBm	dBm	dB	cm	degree	
1	*	1913.500	-14.09	5.38	-8.71	-13.00	4.29	peak		Main Frequency
2		2557.000	-38.42	5.27	-33.15	-13.00	-20.15	peak		

*:Maximum data x:Over limit !:over margin

●Reference Only



File :ZG5(CH810)

Data :#4

Date: 2008/8/28

Time: 下午 08:51:42

20.0 dBm

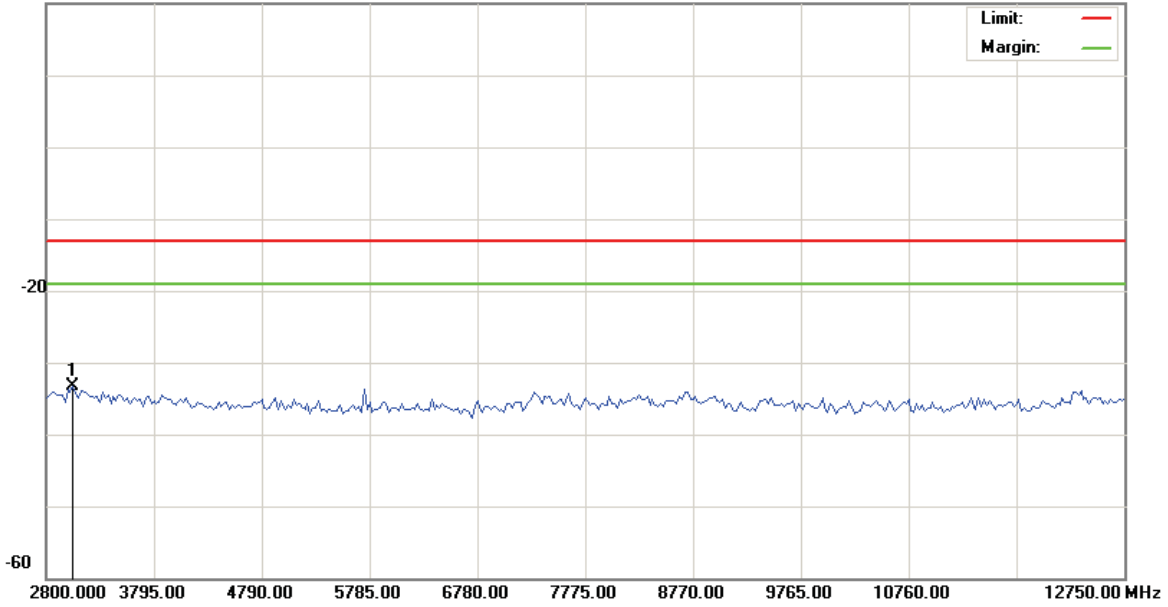

Site site#1
 Limit: FCC Part 24 conducted(9k-12.75G)
 EUT:
 M/N: ZG5
 Mode: PCS1900(GPRS)
 Note: CH810

Polarization: **Conducted po**
 Power: AC 110V/60Hz
 Distance:

Temperature: 26 °C
 Humidity: 55 %

No.	Mk.	Freq.	Reading Level	Correct Factor	Measurement	Limit	Over	Antenna Height	Table Degree
		MHz	dBm	dB	dBm	dBm	dB	cm	degree
1	*	3048.750	-38.86	5.47	-33.39	-13.00	-20.39	peak	

*:Maximum data x:Over limit !:over margin

●Reference Only



File :ZG5(CH810)

Data :#5

Date: 2008/8/28

Time: 下午 08:52:03

20.0 dBm

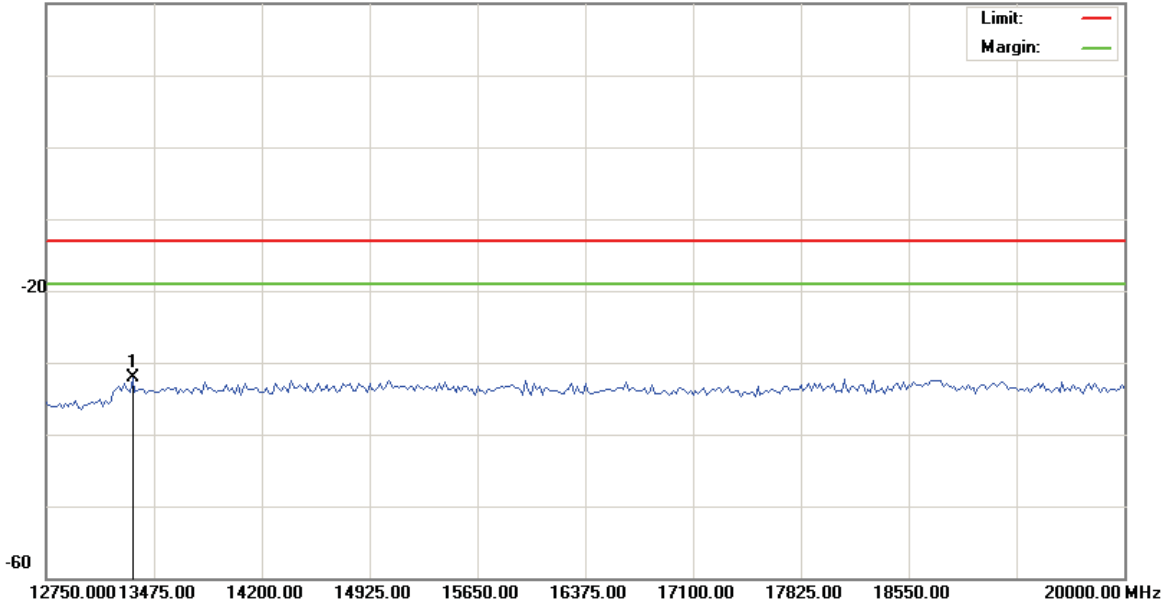

Site site#1 Polarization: **Conducted po** Temperature: 26 °C
 Limit: FCC Part 24 conducted(9k-12.75G) Power: AC 110V/60Hz Humidity: 55 %
 EUT: Distance:
 M/N: ZG5
 Mode: PCS1900(GPRS)
 Note: CH810

No.	Mk.	Freq.	Reading Level	Correct Factor	Measurement	Limit	Over	Antenna Height	Table Degree	
		MHz	dBm	dB	dBm	dBm	dB	cm	degree	Comment
1	*	13330.00	-37.60	5.54	-32.06	-13.00	-19.06			peak

*:Maximum data x:Over limit !:over margin

●Reference Only



4.5.4.3 WCDMA Band V Test Result

Applicant : Acer Incorporated

Model No : ZG5

EUT : Notebook PC

Test Mode : WCDMA Band V (Low CH4132 / Middle CH4182 / High CH 4233)

Test Date : 08/28/2008

Please refer to next pager of detail testing data.

Note: Amplitude= Reading Amplitude + Factor (Cable loss + Filter Amplitude= Insertion loss)

(Auto calculate in spectrum analyzer)



File :ZG5(CH4132)

Data :#1

Date: 2008/8/28

Time: 下午 07:54:27

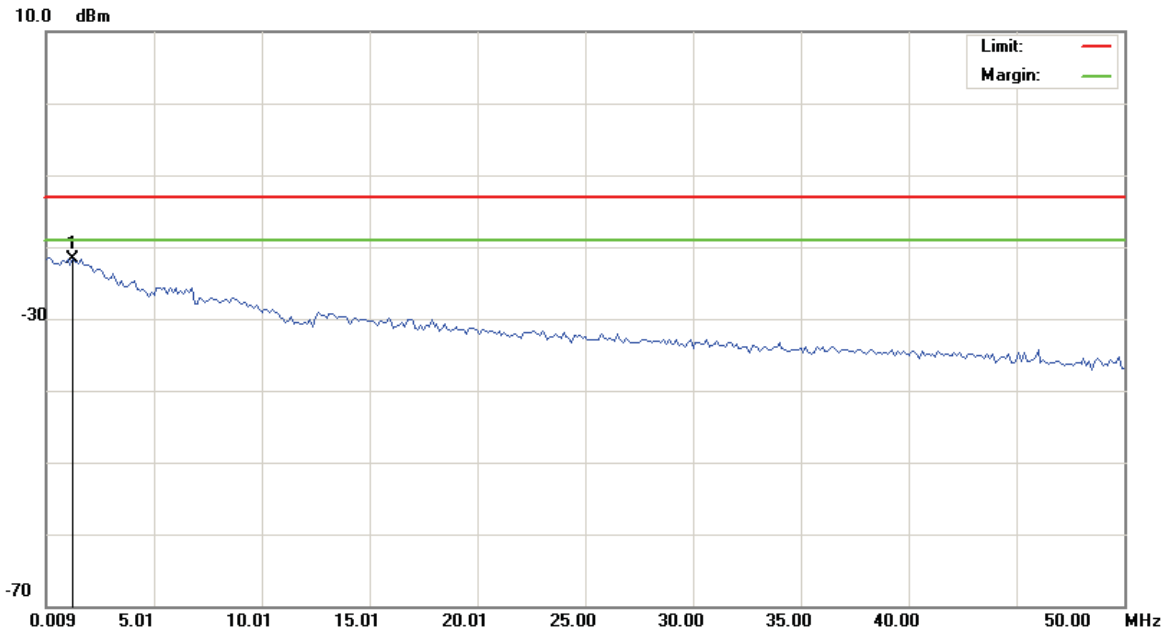

Site site#1
 Limit: FCC Part 22 conducted(9k-12.75G)
 EUT:
 M/N: ZG5
 Mode: WCDMA BandV
 Note: CH4132
 加Notch(3TNF-800)

Polarization: **Conducted po** Temperature: 26 °C
 Power: AC 110V/60Hz Humidity: 55 %
 Distance:

No.	Mk.	Freq.	Reading Level	Correct Factor	Measurement	Limit	Over	Antenna Height	Table Degree
		MHz	dBm	dB	dBm	dBm	dB	cm	degree
1	*	1.2584	-53.19	31.50	-21.69	-13.00	-8.69	peak	

*:Maximum data x:Over limit !:over margin

●Reference Only



File :ZG5(CH4132)

Data :#2

Date: 2008/8/28

Time: 下午 07:54:48

30.0 dBm

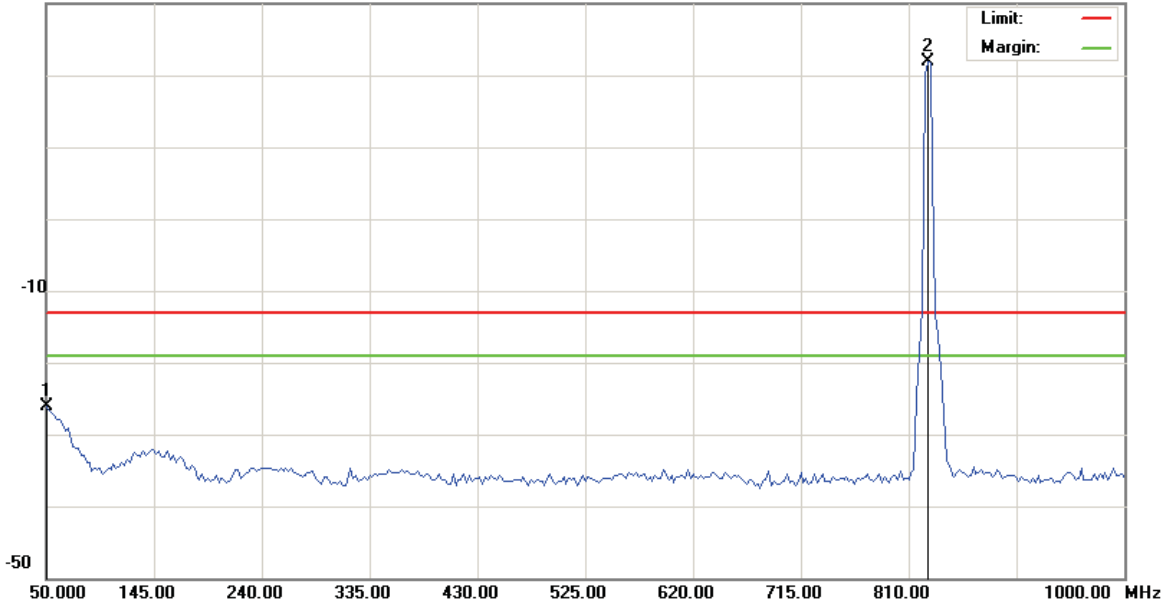

Site site#1

Polarization: *Conducted po*

Temperature: 26 °C

Limit: FCC Part 22 conducted(9k-12.75G)

Power: AC 110V/60Hz

Humidity: 55 %

EUT:

Distance:

M/N: ZG5

Mode: WCDMA BandV

Note: CH4132

加Notch(3TNF-800)

No.	Mk.	Freq.	Reading Level	Correct Factor	Measurement	Limit	Over	Antenna Height	Table Degree
		MHz	dBm	dB	dBm	dBm	dB	cm	degree
1		50.0000	-40.88	14.69	-26.19	-13.00	-13.19	peak	
2	*	826.6250	18.11	3.86	21.97	-13.00	34.97	peak	Main Frequency

*:Maximum data x:Over limit !:over margin

●Reference Only



File :ZG5(CH4132)

Data :#3

Date: 2008/8/28

Time: 下午 08:25:50

20.0 dBm

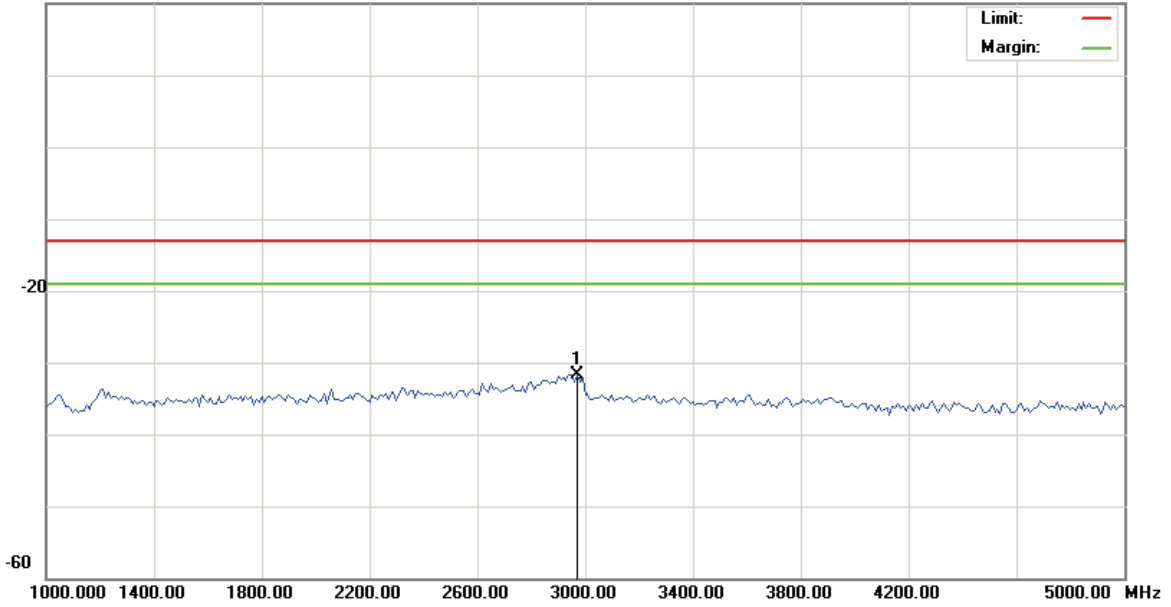

Site site#1

Polarization: *Conducted po*

Temperature: 26 °C

Limit: FCC Part 22 conducted(9k-12.75G)

Power: AC 110V/60Hz

Humidity: 55 %

EUT:

Distance:

M/N: ZG5

Mode: WCDMA BandV

Note: CH4132

No.	Mk.	Freq.	Reading Level	Correct Factor	Measurement	Limit	Over	Antenna Height	Table Degree
		MHz	dBm	dB	dBm	dBm	dB	cm	degree
1	*	2970.000	-36.21	4.56	-31.65	-13.00	-18.65	peak	

*:Maximum data x:Over limit !:over margin

●Reference Only



File :ZG5(CH4132)

Data :#4

Date: 2008/8/28

Time: 下午 08:26:11

20.0 dBm

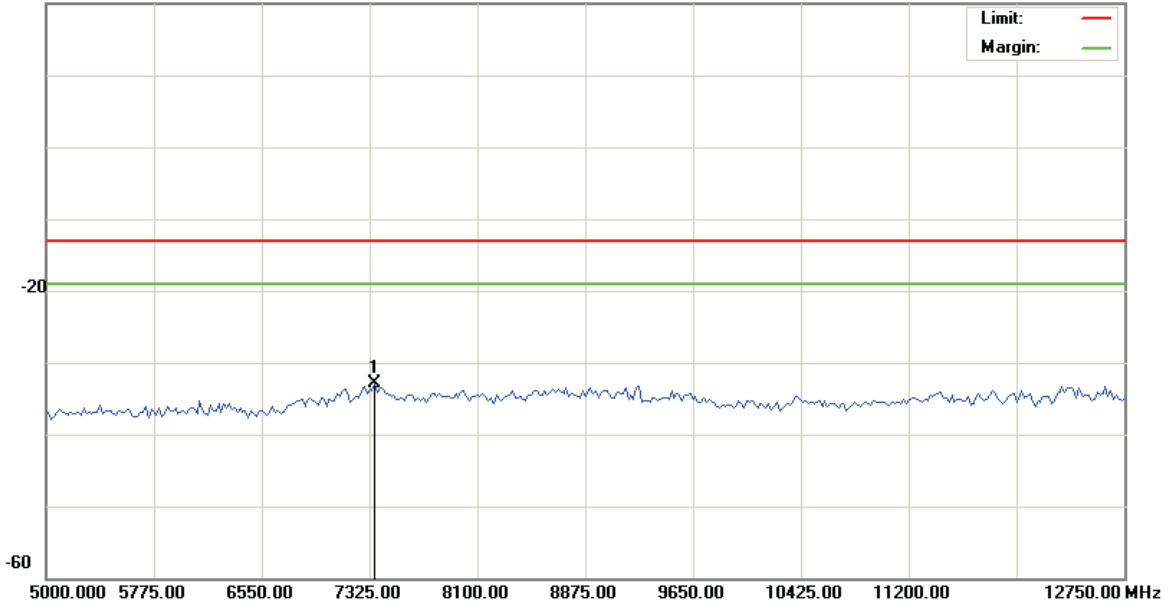

Site site#1

Polarization: *Conducted po*

Temperature: 26 °C

Limit: FCC Part 22 conducted(9k-12.75G)

Power: AC 110V/60Hz

Humidity: 55 %

EUT:

Distance:

M/N: ZG5

Mode: WCDMA BandV

Note: CH4132

No.	Mk.	Freq.	Reading Level	Correct Factor	Measurement	Limit	Over	Antenna Height	Table Degree	
		MHz	dBm	dB	dBm	dBm	dB	cm	degree	Comment
1	*	7363.750	-38.02	5.08	-32.94	-13.00	-19.94			peak

*:Maximum data x:Over limit !:over margin

●Reference Only



File :ZG5(CH4180)

Data :#1

Date: 2008/8/28

Time: 下午 08:03:46

20.0 dBm

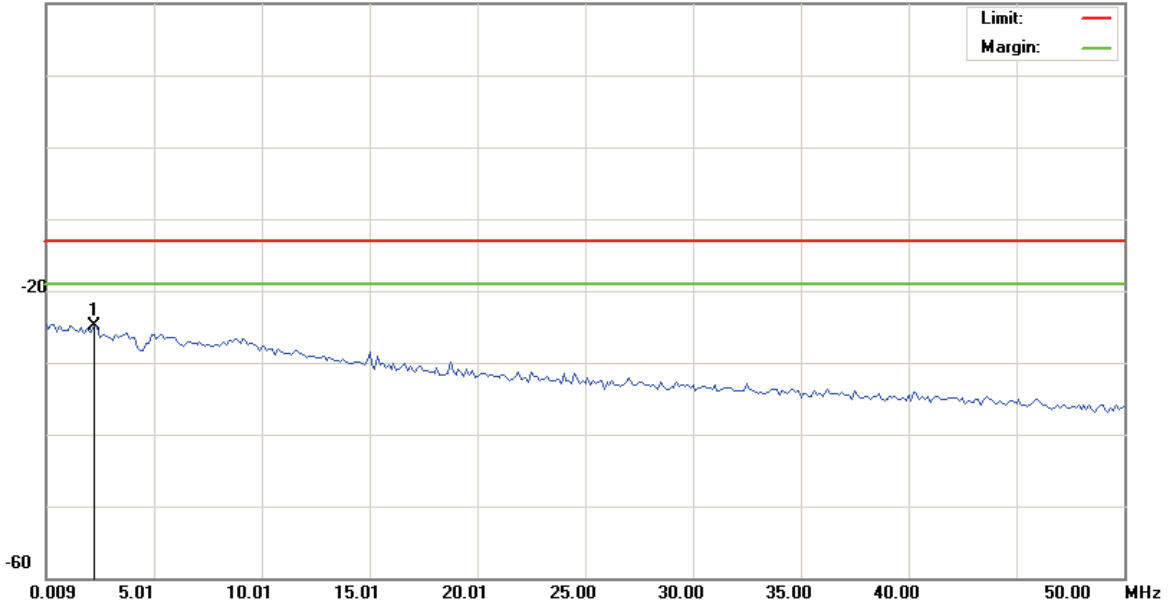

Site site#1 Polarization: **Conducted po** Temperature: 26 °C
 Limit: FCC Part 22 conducted(9k-12.75G) Power: AC 110V/60Hz Humidity: 55 %
 EUT: Distance:
 M/N: ZG5
 Mode: WCDMA BandV
 Note: CH4180
 加Notch(3TNF-800)

No.	Mk.	Freq.	Reading Level	Correct Factor	Measurement	Limit	Over	Antenna Height	Table Degree
		MHz	dBm	dB	dBm	dBm	dB	cm	degree
1	*	2.2585	-56.11	31.14	-24.97	-13.00	-11.97	peak	

*:Maximum data x:Over limit !:over margin

●Reference Only



File :ZG5(CH4180)

Data :#2

Date: 2008/8/28

Time: 下午 08:04:07

30.0 dBm

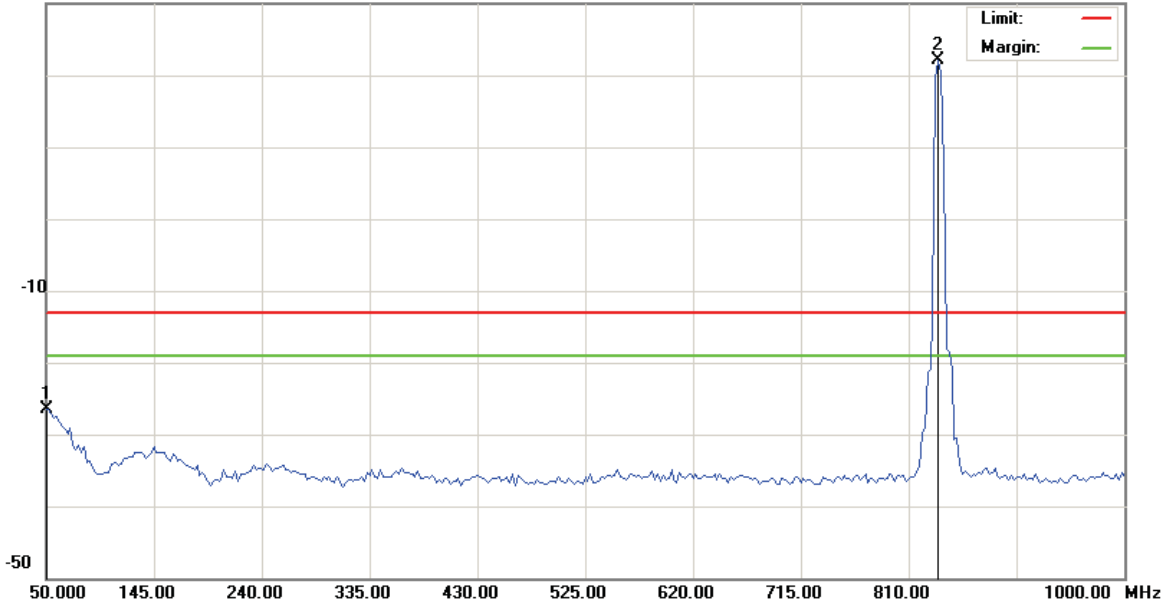

Site site#1 Polarization: **Conducted po** Temperature: 26 °C
 Limit: FCC Part 22 conducted(9k-12.75G) Power: AC 110V/60Hz Humidity: 55 %
 EUT: Distance:
 M/N: ZG5
 Mode: WCDMA BandV
 Note: CH4180
 加Notch(3TNF-800)

No.	Mk.	Freq.	Reading Level	Correct Factor	Measurement	Limit	Over	Antenna Height	Table Degree
		MHz	dBm	dB	dBm	dBm	dB	cm	degree
1		50.0000	-41.15	14.69	-26.46	-13.00	-13.46	peak	
2	*	836.1250	18.21	3.96	22.17	-13.00	35.17	peak	Main Frequency

*:Maximum data x:Over limit !:over margin

●Reference Only

F



File :ZG5(CH4180)

Data :#3

Date: 2008/8/28

Time: 下午 08:27:39

20.0 dBm

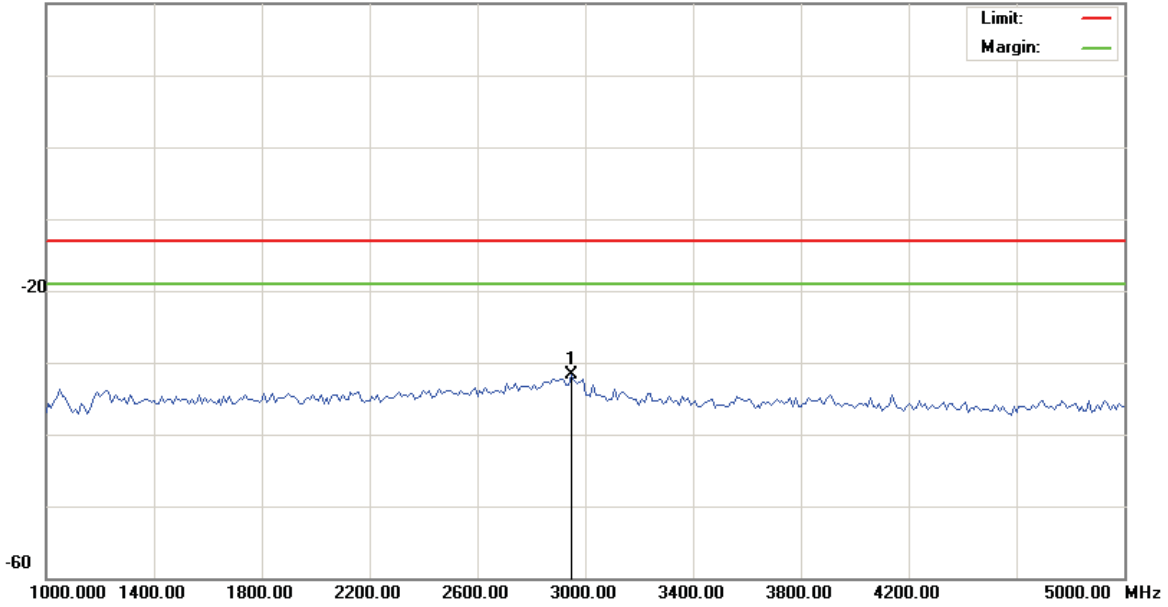

Site site#1 Polarization: **Conducted po** Temperature: 26 °C
 Limit: FCC Part 22 conducted(9k-12.75G) Power: AC 110V/60Hz Humidity: 55 %
 EUT: Distance:
 M/N: ZG5
 Mode: WCDMA BandV
 Note: CH4180

No.	Mk.	Freq.	Reading Level	Correct Factor	Measurement	Limit	Over	Antenna Height	Table Degree
		MHz	dBm	dB	dBm	dBm	dB	cm	degree
1	*	2950.000	-36.20	4.58	-31.62	-13.00	-18.62	peak	

*:Maximum data x:Over limit !:over margin

●Reference Only



File :ZG5(CH4180)

Data :#4

Date: 2008/8/28

Time: 下午 08:28:00

20.0 dBm

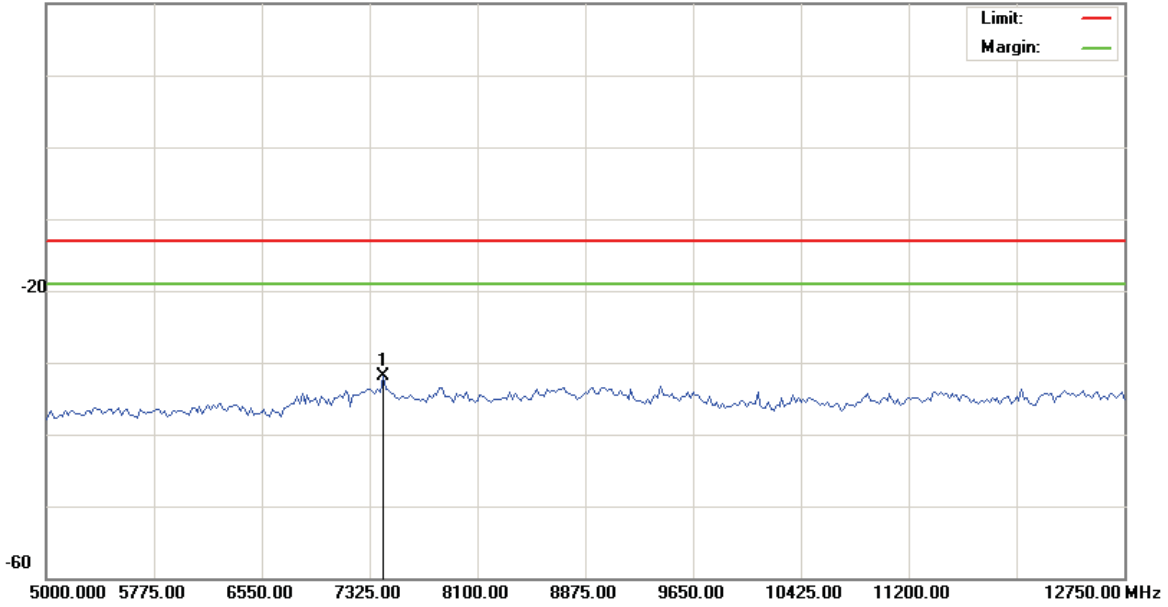

Site site#1
 Limit: FCC Part 22 conducted(9k-12.75G)
 EUT:
 M/N: ZG5
 Mode: WCDMA BandV
 Note: CH4180

Polarization: *Conducted po*
 Power: AC 110V/60Hz
 Distance:

Temperature: 26 °C
 Humidity: 55 %

No.	Mk.	Freq. MHz	Reading Level dBm	Correct Factor dB	Measure- ment dBm	Limit dBm	Over dB	Antenna Height cm	Table Degree degree	Comment
1	*	7421.875	-37.18	5.21	-31.97	-13.00	-18.97	peak		

*:Maximum data x:Over limit !:over margin

●Reference Only



File :ZG5(CH4233)

Data :#1

Date: 2008/8/28

Time: 下午 08:06:49

10.0 dBm

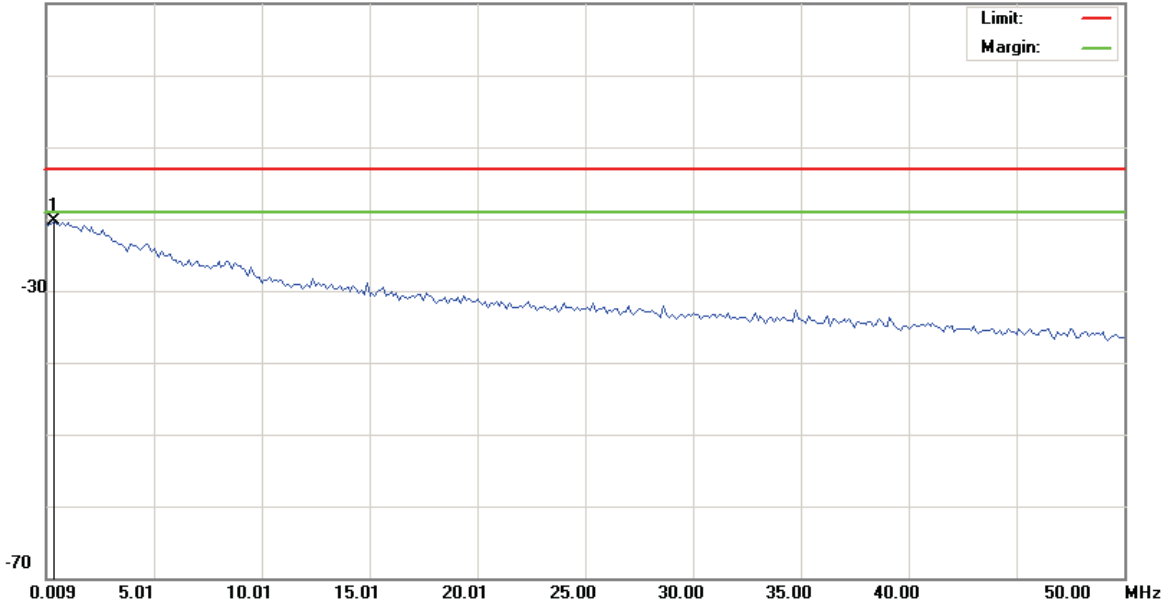

Site site#1 Polarization: **Conducted po** Temperature: 26 °C
 Limit: FCC Part 22 conducted(9k-12.75G) Power: AC 110V/60Hz Humidity: 55 %
 EUT: Distance:
 M/N: ZG5
 Mode: WCDMA BandV
 Note: CH4233
 加Notch(3TNF-800)

No.	Mk.	Freq.	Reading Level	Correct Factor	Measurement	Limit	Over	Antenna Height	Table Degree	
		MHz	dBm	dB	dBm	dBm	dB	cm	degree	Comment
1	*	0.3839	-52.18	31.89	-20.29	-13.00	-7.29	peak		

*:Maximum data x:Over limit !:over margin

●Reference Only



File :ZG5(CH4233)

Data :#2

Date: 2008/8/28

Time: 下午 08:07:10

30.0 dBm

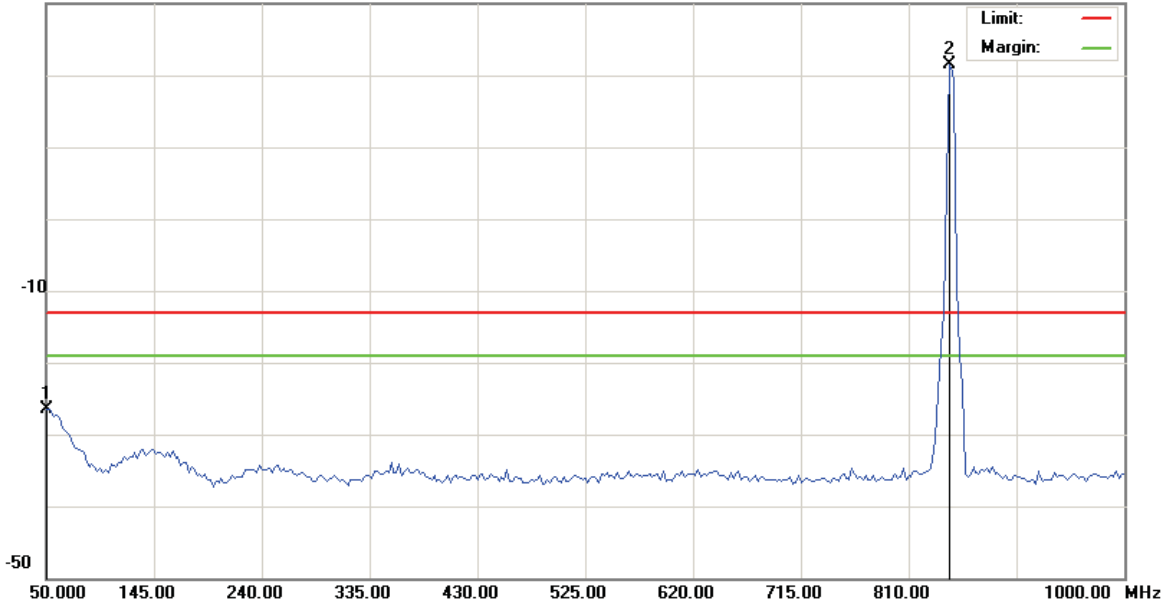

Site site#1 Polarization: **Conducted po** Temperature: 26 °C
 Limit: FCC Part 22 conducted(9k-12.75G) Power: AC 110V/60Hz Humidity: 55 %
 EUT: Distance:
 M/N: ZG5
 Mode: WCDMA BandV
 Note: CH4233
 加Notch(3TNF-800)

No.	Mk.	Freq.	Reading Level	Correct Factor	Measurement	Limit	Over	Antenna Height	Table Degree	
		MHz	dBm	dB	dBm	dBm	dB	cm	degree	Comment
1		50.0000	-41.12	14.69	-26.43	-13.00	-13.43			peak
2	*	845.6250	17.49	3.99	21.48	-13.00	34.48			peak Main Frequency

*:Maximum data x:Over limit !:over margin

●Reference Only



File :ZG5(CH4233)

Data :#3

Date: 2008/8/28

Time: 下午 08:28:59

20.0 dBm

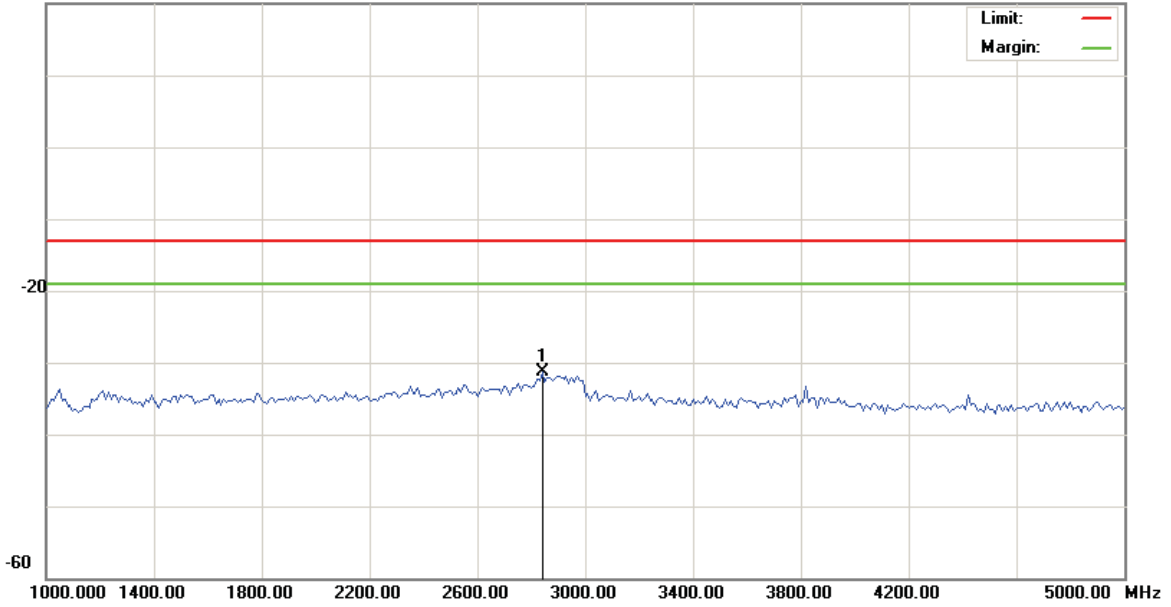

Site site#1
 Limit: FCC Part 22 conducted(9k-12.75G)
 EUT:
 M/N: ZG5
 Mode: WCDMA BandV
 Note: CH4233

Polarization: *Conducted po*
 Power: AC 110V/60Hz
 Distance:

Temperature: 26 °C
 Humidity: 55 %

No.	Mk.	Freq. MHz	Reading Level dBm	Correct Factor dB	Measure- ment dBm	Limit dBm	Over dB	Antenna Height cm	Table Degree degree	Comment
1	*	2840.000	-35.71	4.50	-31.21	-13.00	-18.21	peak		

*:Maximum data x:Over limit !:over margin

●Reference Only



File :ZG5(CH4233)

Data :#4

Date: 2008/8/28

Time: 下午 08:29:20

20.0 dBm

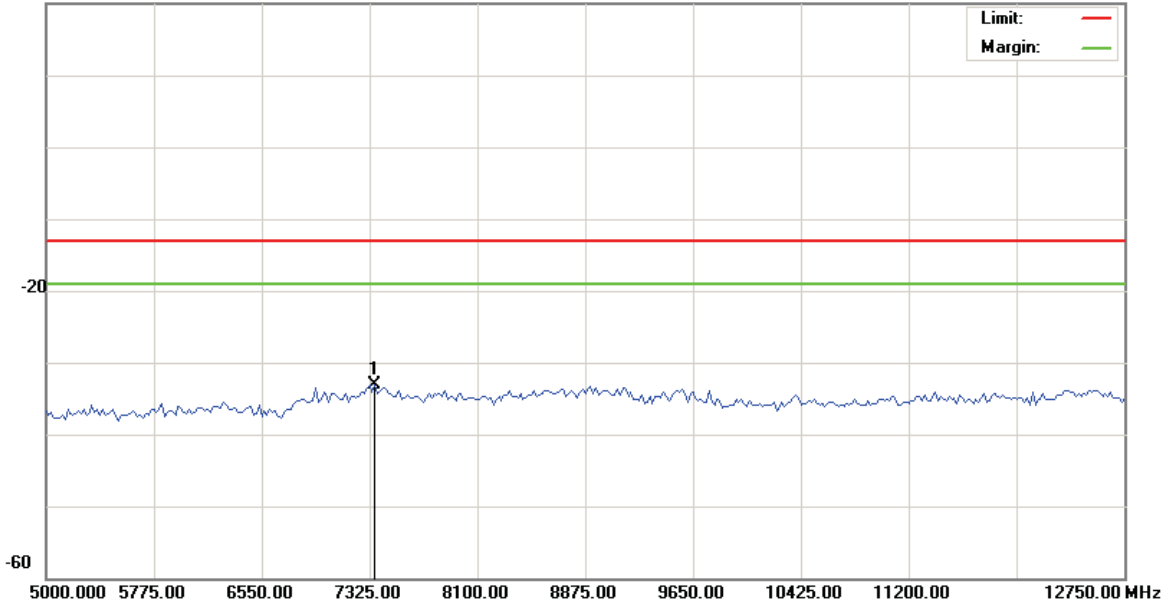

Site site#1
 Limit: FCC Part 22 conducted(9k-12.75G)
 EUT:
 M/N: ZG5
 Mode: WCDMA BandV
 Note: CH4233

Polarization: **Conducted po**
 Power: AC 110V/60Hz
 Distance:

Temperature: 26 °C
 Humidity: 55 %

No.	Mk.	Freq. MHz	Reading Level dBm	Correct Factor dB	Measure- ment dBm	Limit dBm	Over dB	Antenna Height cm	Table Degree degree	Comment
1	*	7363.750	-38.12	5.08	-33.04	-13.00	-20.04	peak		

*:Maximum data x:Over limit !:over margin

●Reference Only



4.5.4.4 WCDMA Band II Test Result

Applicant : Acer Incorporated
Model No : ZG5
EUT : Notebook PC
Test Mode : WCDMA Band II (Low CH9262 / Middle CH9400 / High CH 9536)
Test Date : 08/28/2008

Please refer to next pager of detail testing data.

Note: Amplitude= Reading Amplitude + Factor (Cable loss + Filter Amplitude= Insertion loss)
(Auto calculate in spectrum analyzer)



File :ZG5(CH9262)

Data :#1

Date: 2008/8/28

Time: 上午 03:24:24

10.0 dBm

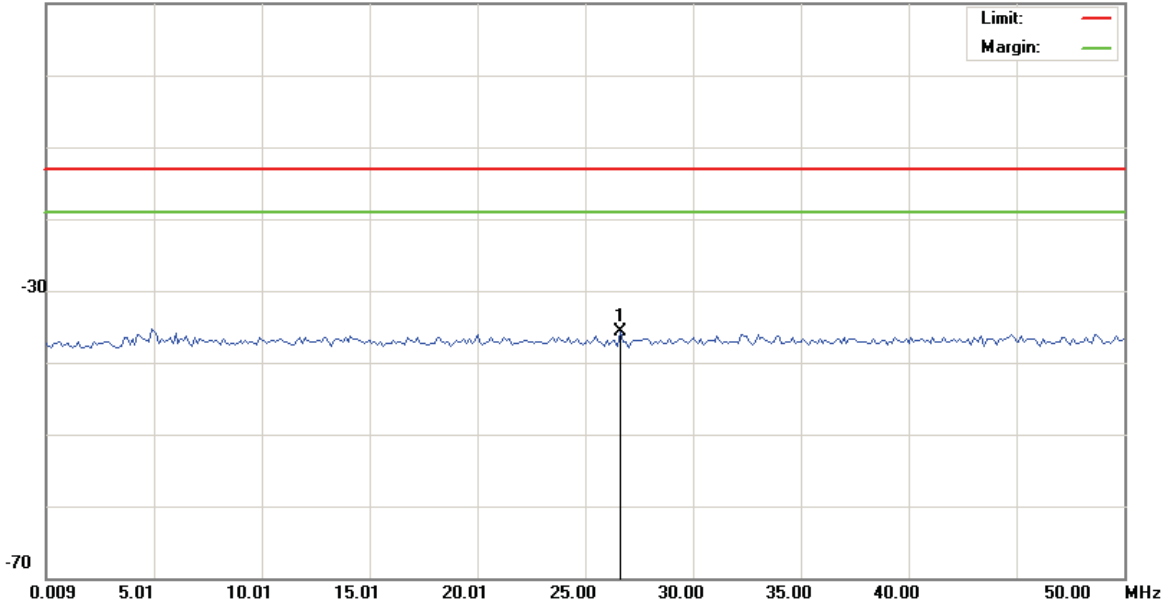

Site site#1 Polarization: **Conducted po** Temperature: 26 °C
 Limit: FCC Part 24 conducted(9k-12.75G) Power: AC 110V/60Hz Humidity: 55 %
 EUT: Distance:
 M/N: ZG5
 Mode: WCDMA BANDII
 Note: CH9262
 加10db衰减器

No.	Mk.	Freq.	Reading Level	Correct Factor	Measurement	Limit	Over	Antenna Height	Table Degree
		MHz	dBm	dB	dBm	dBm	dB	cm	degree
1	*	26.6292	-49.01	13.30	-35.71	-13.00	-22.71	peak	

*:Maximum data x:Over limit !:over margin

●Reference Only



File :ZG5(CH9262)

Data :#2

Date: 2008/8/28

Time: 上午 03:24:46

20.0 dBm

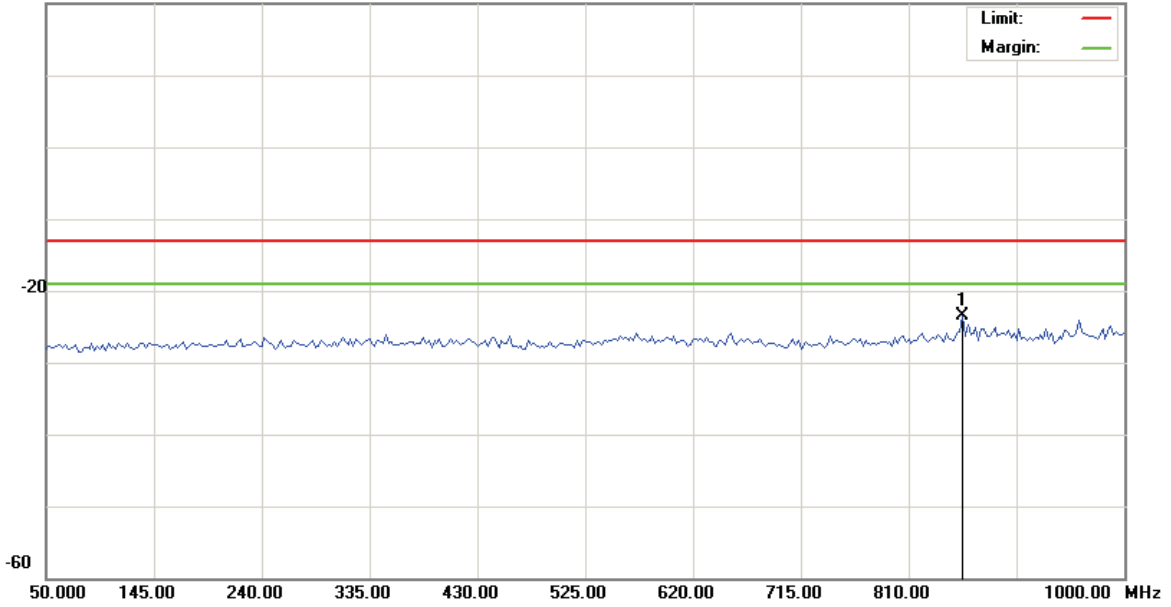

Site site#1 Polarization: **Conducted po** Temperature: 26 °C
 Limit: FCC Part 24 conducted(9k-12.75G) Power: AC 110V/60Hz Humidity: 55 %
 EUT: Distance:
 M/N: ZG5
 Mode: WCDMA BANDII
 Note: CH9262
 加10db衰减器

No.	Mk.	Freq.	Reading Level	Correct Factor	Measurement	Limit	Over	Antenna Height	Table Degree
		MHz	dBm	dB	dBm	dBm	dB	cm	degree
1	*	857.5000	-36.84	13.25	-23.59	-13.00	-10.59	peak	

*:Maximum data x:Over limit !:over margin

●Reference Only



File :ZG5(CH9262)

Data :#3

Date: 2008/8/28

Time: 上午 03:47:56

30.0 dBm

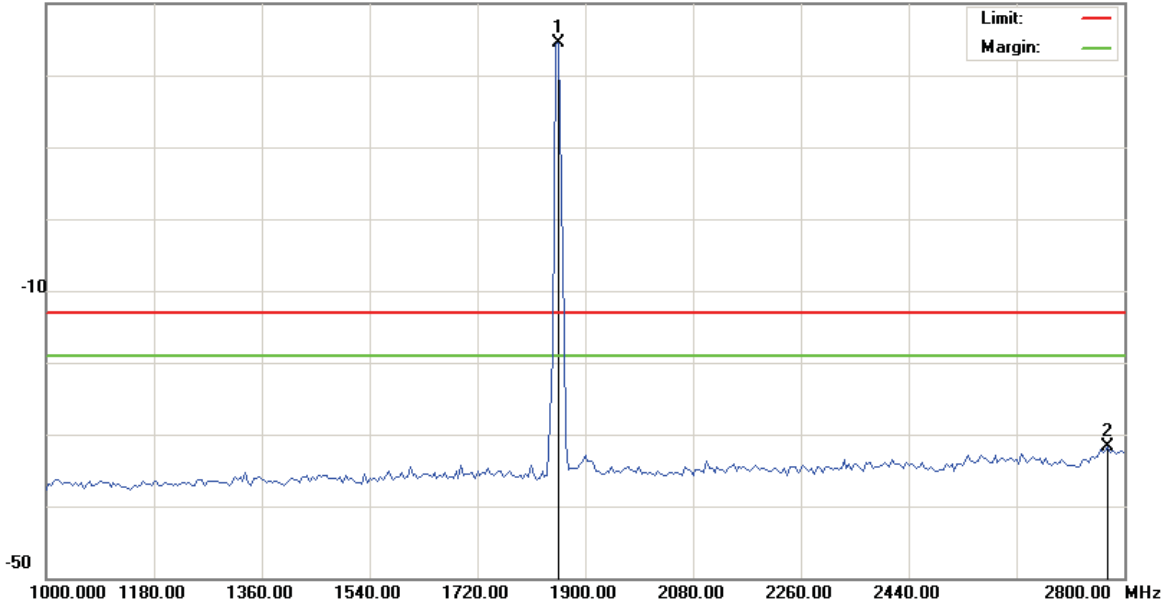

Site site#1

Polarization: **Conducted po**

Temperature: 26 °C

Limit: FCC Part 24 conducted(9k-12.75G)

Power: AC 110V/60Hz

Humidity: 55 %

EUT:

Distance:

M/N: ZG5

Mode: WCDMA BANDII

Note: CH9262

加Notch(5TNF-1700)

No.	Mk.	Freq. MHz	Reading Level dBm	Correct Factor dB	Measure- ment dBm	Limit dBm	Over dB	Antenna Height cm	Table Degree degree	Comment
1	*	1855.000	20.14	4.29	24.43	-13.00	37.43	peak		Main Frequency
2		2773.000	-37.56	5.78	-31.78	-13.00	-18.78	peak		

*:Maximum data x:Over limit !:over margin

●Reference Only



File :ZG5(CH9262)

Data :#4

Date: 2008/8/28

Time: 下午 08:35:40

20.0 dBm

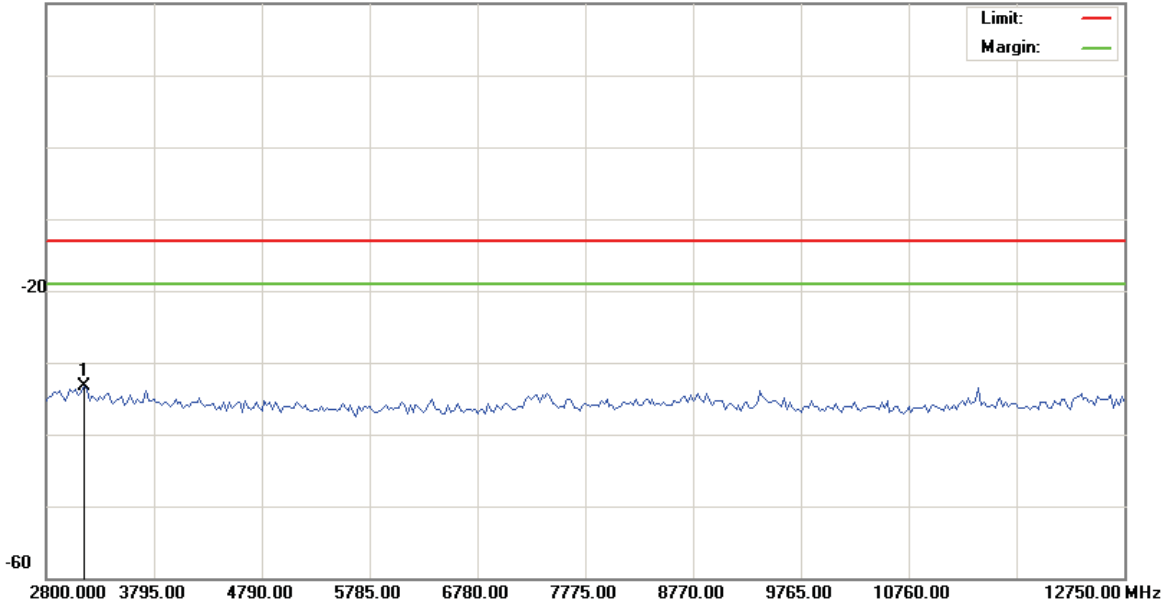

Site site#1
 Limit: FCC Part 24 conducted(9k-12.75G)
 EUT:
 M/N: ZG5
 Mode: WCDMA BANDII
 Note: CH9262

Polarization: *Conducted po*
 Power: AC 110V/60Hz
 Distance:

Temperature: 26 °C
 Humidity: 55 %

No.	Mk.	Freq.	Reading Level	Correct Factor	Measurement	Limit	Over	Antenna Height	Table Degree
		MHz	dBm	dB	dBm	dBm	dB	cm	degree
1	*	3148.250	-38.62	5.27	-33.35	-13.00	-20.35	peak	

*:Maximum data x:Over limit !:over margin

●Reference Only



File :ZG5(CH9262)

Data :#5

Date: 2008/8/28

Time: 下午 08:36:01

20.0 dBm

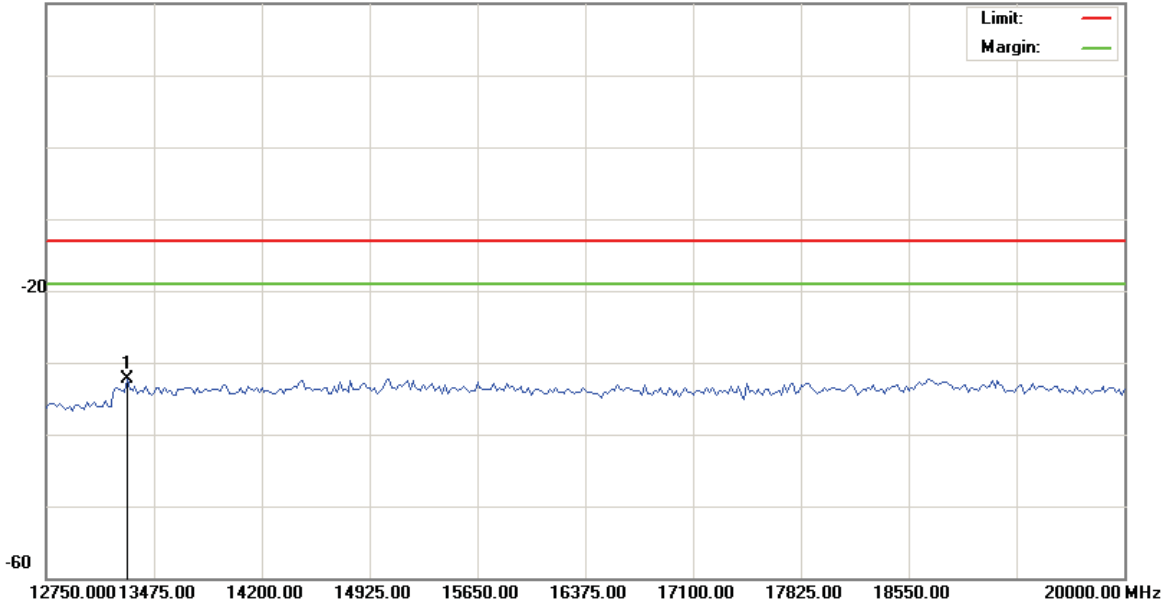

Site site#1
 Limit: FCC Part 24 conducted(9k-12.75G)
 EUT:
 M/N: ZG5
 Mode: WCDMA BANDII
 Note: CH9262

Polarization: **Conducted po**
 Power: AC 110V/60Hz
 Distance:

Temperature: 26 °C
 Humidity: 55 %

No.	Mk.	Freq. MHz	Reading Level dBm	Correct Factor dB	Measure- ment dBm	Limit dBm	Over dB	Antenna Height cm	Table Degree degree	Comment
1	*	13293.75	-37.78	5.53	-32.25	-13.00	-19.25	peak		

*:Maximum data x:Over limit !:over margin

●Reference Only



File :ZG5(CH9400)

Data :#1

Date: 2008/8/28

Time: 上午 03:27:24

10.0 dBm

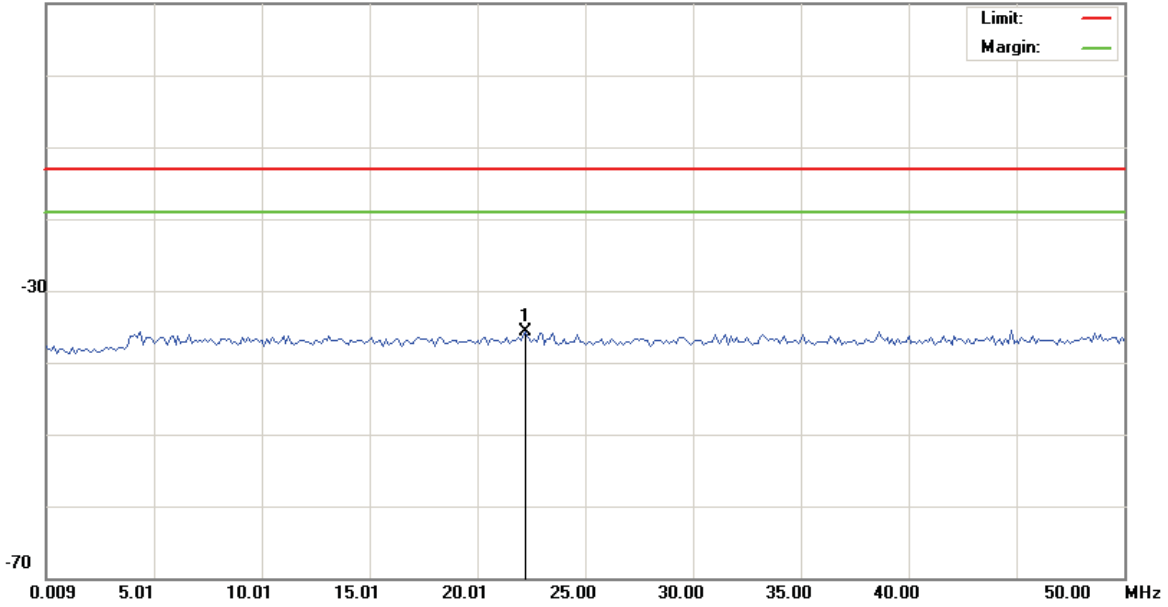

Site site#1

Polarization: **Conducted po**

Temperature: 26 °C

Limit: FCC Part 24 conducted(9k-12.75G)

Power: AC 110V/60Hz

Humidity: 55 %

EUT:

Distance:

M/N: ZG5

Mode: WCDMA BANDII

Note: CH9400

加10db衰减器

No.	Mk.	Freq.	Reading Level	Correct Factor	Measurement	Limit	Over	Antenna Height	Table Degree
		MHz	dBm	dB	dBm	dBm	dB	cm	degree
1	*	22.2547	-48.89	13.29	-35.60	-13.00	-22.60	peak	Comment

*:Maximum data x:Over limit !:over margin

●Reference Only



File :ZG5(CH9400)

Data :#2

Date: 2008/8/28

Time: 上午 03:27:44

20.0 dBm

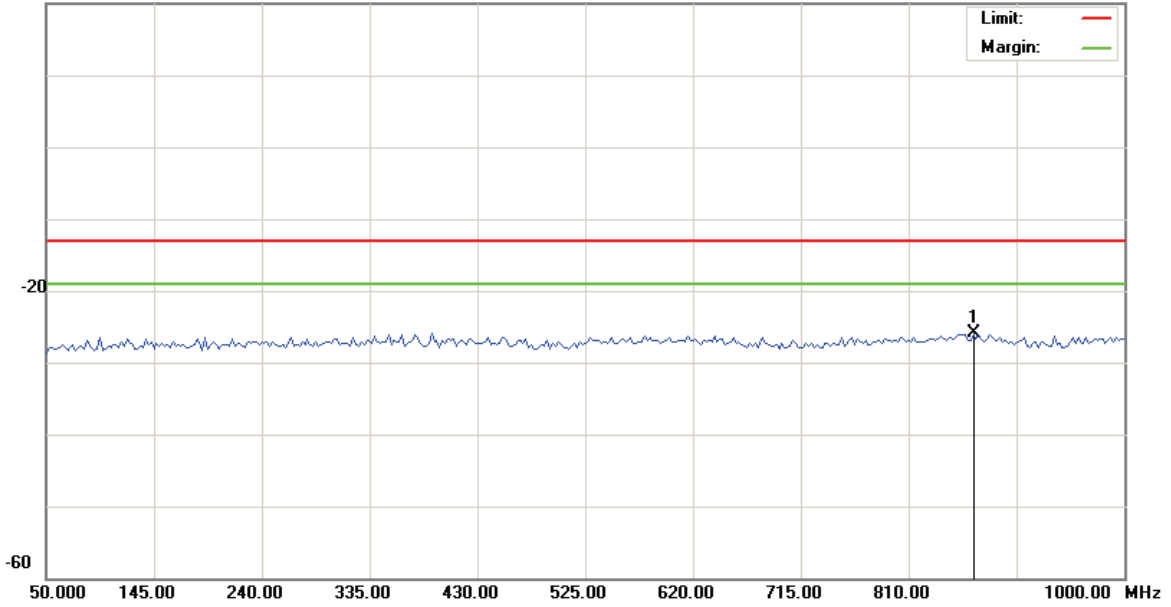

Site site#1 Polarization: **Conducted po** Temperature: 26 °C
 Limit: FCC Part 24 conducted(9k-12.75G) Power: AC 110V/60Hz Humidity: 55 %
 EUT: Distance:
 M/N: ZG5
 Mode: WCDMA BANDII
 Note: CH9400
 加10db衰减器

No.	Mk.	Freq.	Reading Level	Correct Factor	Measurement	Limit	Over	Antenna Height	Table Degree
		MHz	dBm	dB	dBm	dBm	dB	cm	degree
1	*	867.0000	-39.18	13.26	-25.92	-13.00	-12.92	peak	Comment

*:Maximum data x:Over limit !:over margin

●Reference Only



File :ZG5(CH9400)

Data :#3

Date: 2008/8/28

Time: 上午 03:44:45

30.0 dBm

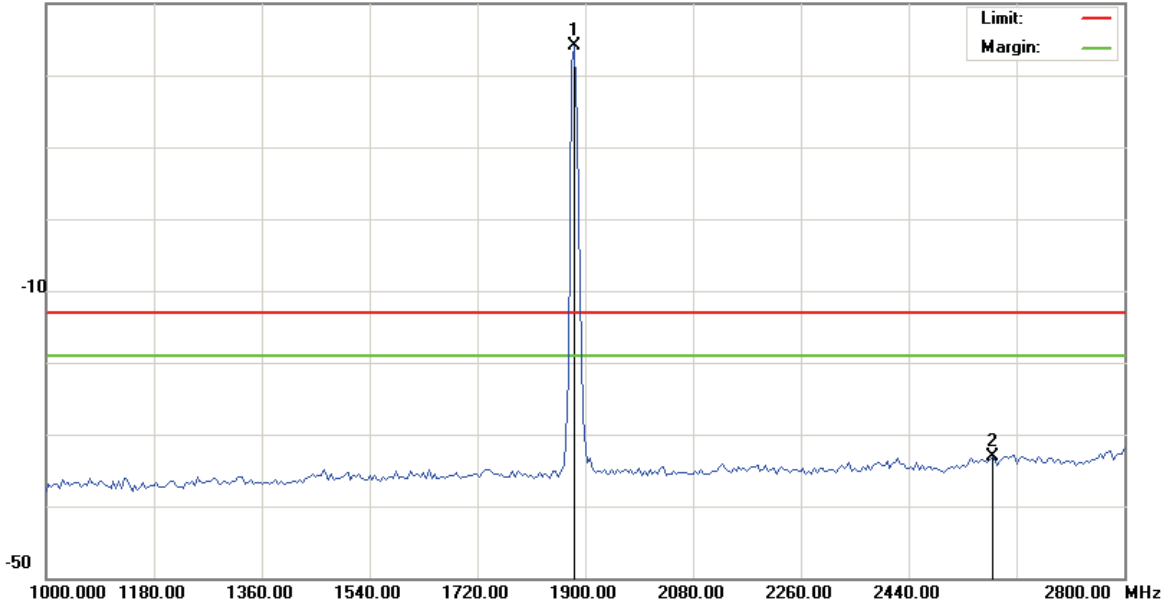

Site site#1

Polarization: **Conducted po**

Temperature: 26 °C

Limit: FCC Part 24 conducted(9k-12.75G)

Power: AC 110V/60Hz

Humidity: 55 %

EUT:

Distance:

M/N: ZG5

Mode: WCDMA BANDII

Note: CH9400

加Notch(5TNF-1700)

No.	Mk.	Freq. MHz	Reading Level dBm	Correct Factor dB	Measure- ment dBm	Limit dBm	Over dB	Antenna Height cm	Table Degree degree	Comment
1	*	1882.000	19.21	4.83	24.04	-13.00	37.04	peak		Main Frequency
2		2579.500	-38.53	5.35	-33.18	-13.00	-20.18	peak		

*:Maximum data x:Over limit !:over margin

●Reference Only



File :ZG5(CH9400)

Data :#4

Date: 2008/8/28

Time: 下午 08:37:13

20.0 dBm

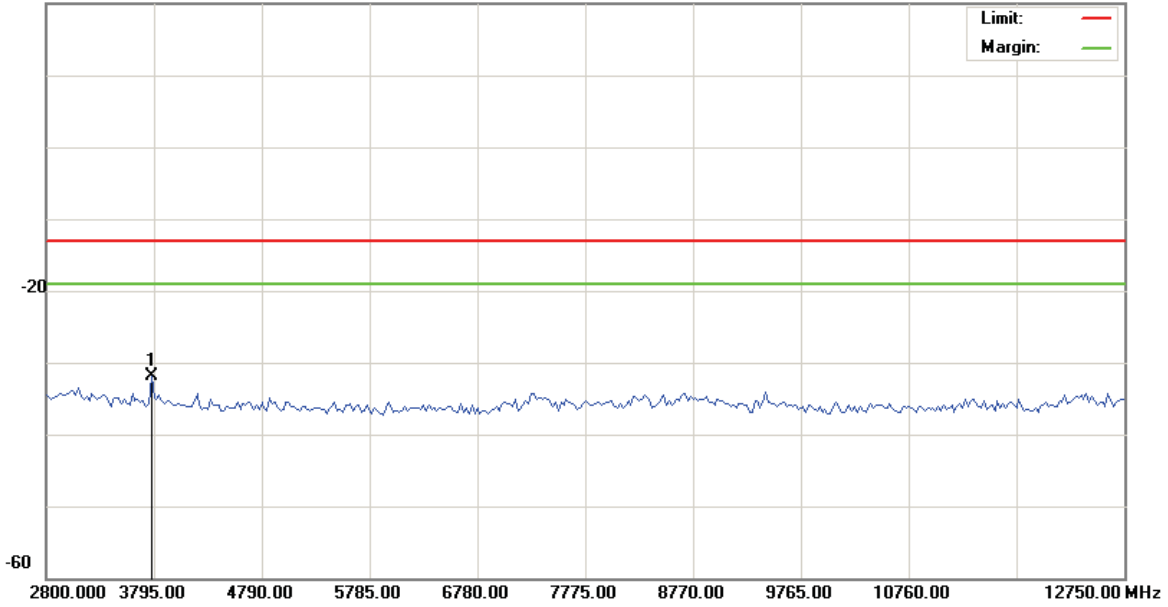

Site site#1

Polarization: *Conducted po*

Temperature: 26 °C

Limit: FCC Part 24 conducted(9k-12.75G)

Power: AC 110V/60Hz

Humidity: 55 %

EUT:

Distance:

M/N: ZG5

Mode: WCDMA BANDII

Note: CH9400

No.	Mk.	Freq. MHz	Reading Level dBm	Correct Factor dB	Measure- ment dBm	Limit dBm	Over dB	Antenna Height cm	Table Degree degree	Comment
1	*	3770.125	-36.86	4.93	-31.93	-13.00	-18.93	peak		

*:Maximum data x:Over limit !:over margin

●Reference Only



File :ZG5(CH9400)

Data :#5

Date: 2008/8/28

Time: 下午 08:37:34

20.0 dBm

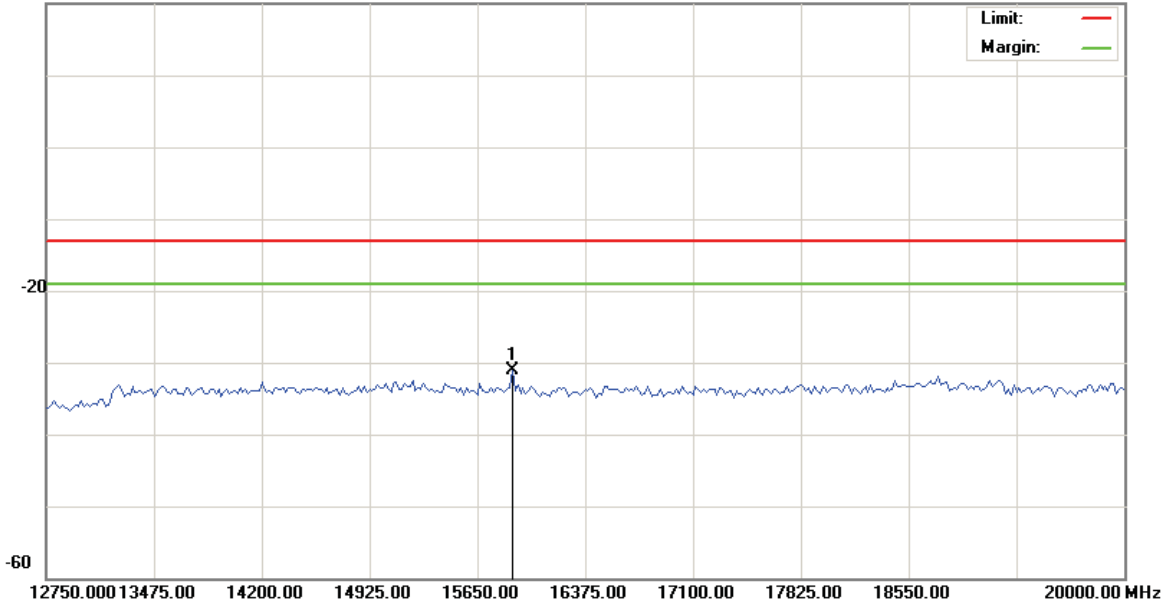

Site site#1
 Limit: FCC Part 24 conducted(9k-12.75G)
 EUT:
 M/N: ZG5
 Mode: WCDMA BANDII
 Note: CH9400

Polarization: **Conducted po**
 Power: AC 110V/60Hz
 Distance:

Temperature: 26 °C
 Humidity: 55 %

No.	Mk.	Freq. MHz	Reading Level dBm	Correct Factor dB	Measure- ment dBm	Limit dBm	Over dB	Antenna Height cm	Table Degree degree	Comment
1	*	15885.62	-37.37	6.27	-31.10	-13.00	-18.10	peak		

*:Maximum data x:Over limit !:over margin

●Reference Only



File :ZG5(CH9538)

Data :#1

Date: 2008/8/28

Time: 上午 03:30:03

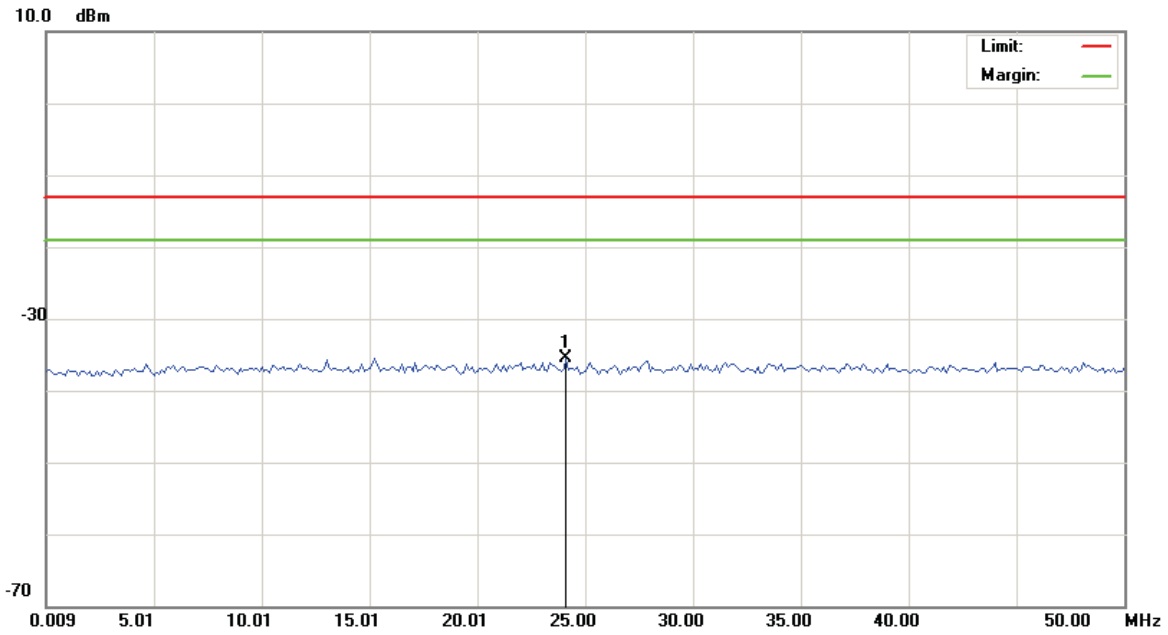

Site site#1
 Limit: FCC Part 24 conducted(9k-12.75G)
 EUT:
 M/N: ZG5
 Mode: WCDMA BANDII
 Note: CH9538
 加10db衰减器

Polarization: **Conducted po**
 Power: AC 110V/60Hz
 Distance:

Temperature: 26 °C
 Humidity: 55 %

No.	Mk.	Freq. MHz	Reading Level dBm	Correct Factor dB	Measure- ment dBm	Limit dBm	Over dB	Antenna Height cm	Table Degree degree	Comment
1	*	24.1295	-48.84	13.30	-35.54	-13.00	-22.54	peak		

*:Maximum data x:Over limit !:over margin

●Reference Only



File :ZG5(CH9538)

Data :#2

Date: 2008/8/28

Time: 上午 03:30:24

20.0 dBm

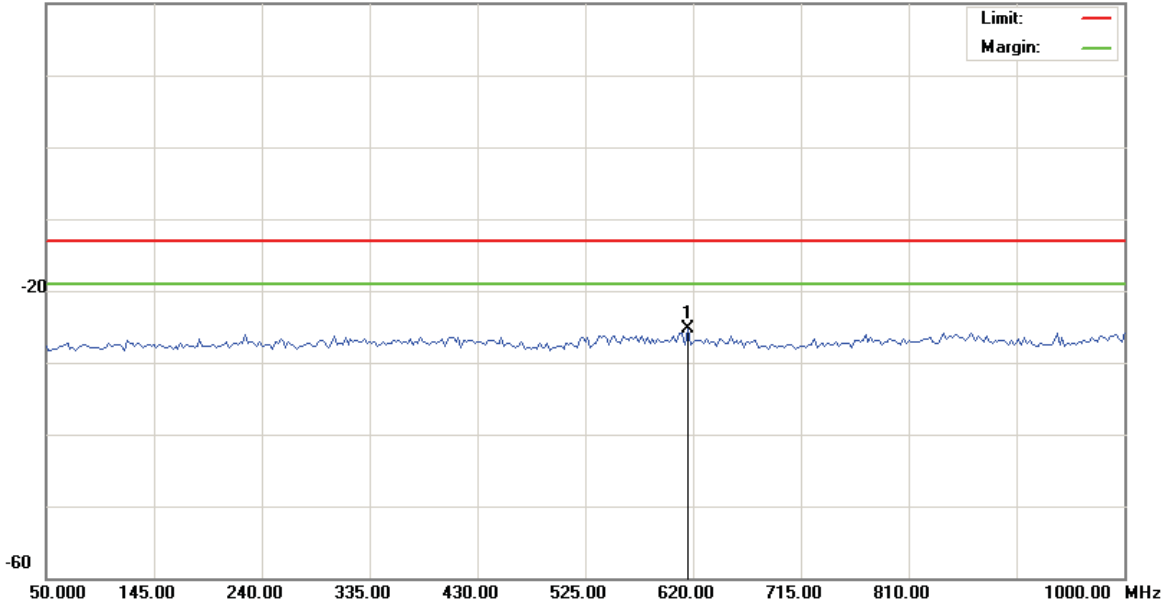

Site site#1 Polarization: **Conducted po** Temperature: 26 °C
 Limit: FCC Part 24 conducted(9k-12.75G) Power: AC 110V/60Hz Humidity: 55 %
 EUT: Distance:
 M/N: ZG5
 Mode: WCDMA BANDII
 Note: CH9538
 加10db衰减器

No.	Mk.	Freq.	Reading Level	Correct Factor	Measurement	Limit	Over	Antenna Height	Table Degree
		MHz	dBm	dB	dBm	dBm	dB	cm	degree
1	*	615.2500	-38.49	13.11	-25.38	-13.00	-12.38	peak	Comment

*:Maximum data x:Over limit !:over margin

●Reference Only



File :ZG5(CH9538)

Data :#3

Date: 2008/8/28

Time: 上午 03:39:30

30.0 dBm

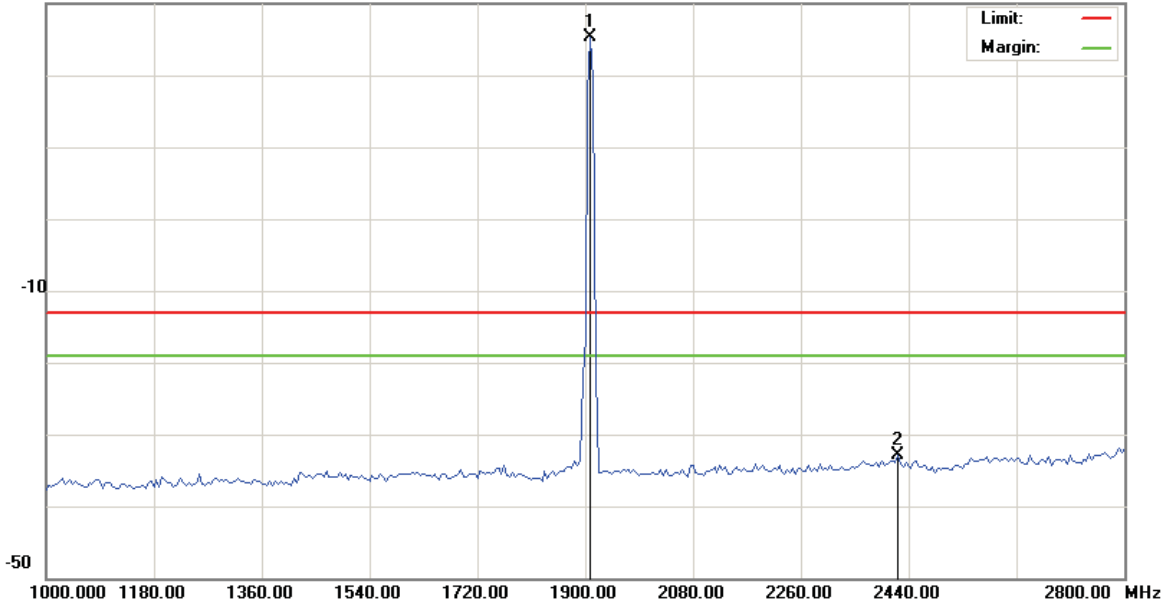

Site site#1 Polarization: **Conducted po** Temperature: 26 °C
 Limit: FCC Part 24 conducted(9k-12.75G) Power: AC 110V/60Hz Humidity: 55 %
 EUT: Distance:
 M/N: ZG5
 Mode: WCDMA BANDII
 Note: CH9538
 加Notch(5TNF-1700)

No.	Mk.	Freq.	Reading Level	Correct Factor	Measurement	Limit	Over	Antenna Height	Table Degree	
		MHz	dBm	dB	dBm	dBm	dB	cm	degree	Comment
1	*	1909.000	19.52	5.80	25.32	-13.00	38.32	peak		Main Frequency
2		2422.000	-37.95	5.13	-32.82	-13.00	-19.82	peak		

*:Maximum data x:Over limit !:over margin

●Reference Only



File :ZG5(CH9538)

Data :#4

Date: 2008/8/28

Time: 下午 08:38:46

20.0 dBm

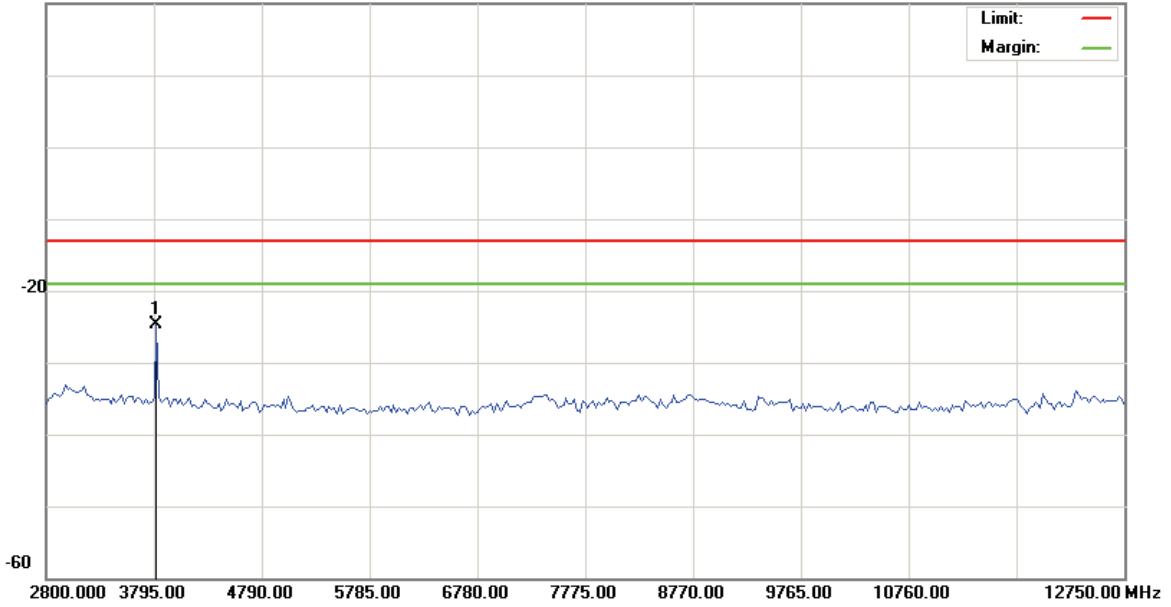

Site site#1 Polarization: **Conducted po** Temperature: 26 °C
 Limit: FCC Part 24 conducted(9k-12.75G) Power: AC 110V/60Hz Humidity: 55 %
 EUT: Distance:
 M/N: ZG5
 Mode: WCDMA BANDII
 Note: CH9538

No.	Mk.	Freq.	Reading Level	Correct Factor	Measurement	Limit	Over	Antenna Height	Table Degree	
		MHz	dBm	dB	dBm	dBm	dB	cm	degree	Comment
1	*	3819.875	-29.56	4.91	-24.65	-13.00	-11.65	peak		

*:Maximum data x:Over limit !:over margin

●Reference Only



File :ZG5(CH9538)

Data :#5

Date: 2008/8/28

Time: 下午 08:39:07

20.0 dBm

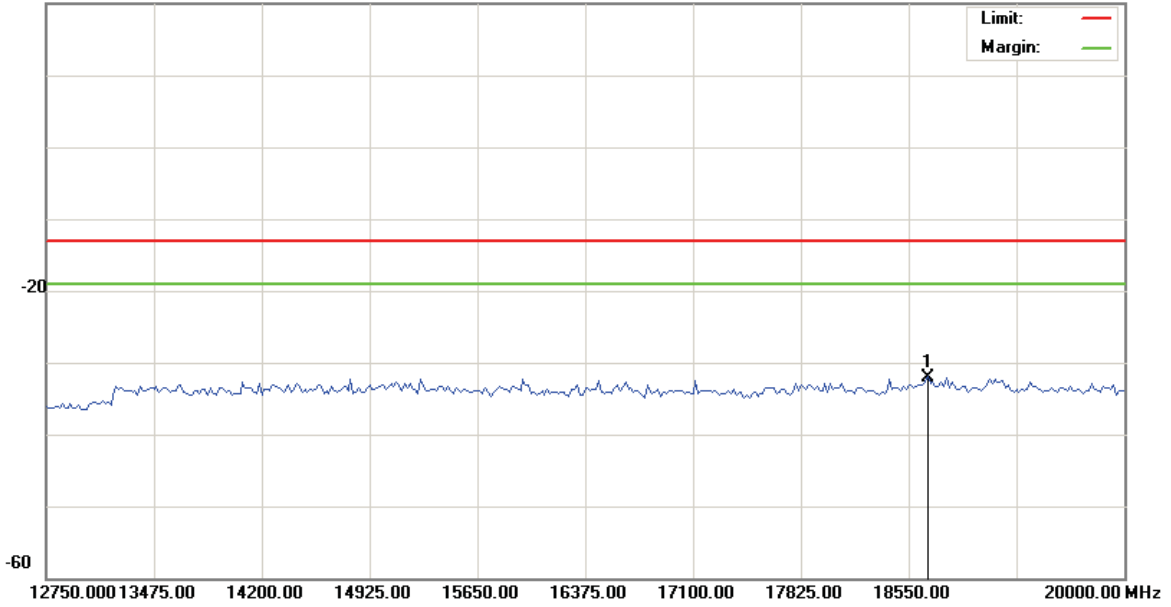

Site site#1 Polarization: **Conducted po** Temperature: 26 °C
 Limit: FCC Part 24 conducted(9k-12.75G) Power: AC 110V/60Hz Humidity: 55 %
 EUT: Distance:
 M/N: ZG5
 Mode: WCDMA BANDII
 Note: CH9538

No.	Mk.	Freq.	Reading Level	Correct Factor	Measurement	Limit	Over	Antenna Height	Table Degree	
		MHz	dBm	dB	dBm	dBm	dB	cm	degree	Comment
1	*	18676.87	-39.06	7.06	-32.00	-13.00	-19.00			peak

*:Maximum data x:Over limit !:over margin

●Reference Only



4.6 Field Strength of Spurious Radiation

Equivalent isotropic radiated Power Measurements by substitution method according to ANSI/TIA/EIA-603-A.

4.6.1 Measurement Instruments

As described in chapter 5 of this test report.

4.6.2 Test Procedure

The measurement is made according to ANSI/TIA-603-C-2004 as follows:

The equipment under test is placed inside the semi-anechoic chamber on a wooden table at the turntable center. For each spurious frequency, the antenna mast is raised and lowered from 1 to 4 meters and the turntable is rotated 360 degrees to obtain a maximum reading on the spectrum analyzer. This is repeated for both horizontal and vertical polarizations of the receive antenna.

The equipment under test is then replaced with a substitution antenna fed by a signal generator. With the signal generator tuned to a particular spurious frequency, the antenna mast is raised and lowered from 1 to 4 meters to obtain a maximum reading at the spectrum analyzer. The output of the signal generator is then adjusted until a reading identical to that obtained with the actual transmitter is achieved.

The power in dBm of each spurious emission is calculated by correcting the signal generator level for cable loss and gain of the substitution antenna referenced to a dipole. A fully charged battery was used for the supply voltage.

The settings of the receiver were as follows:

Units	dBm
Resolution Bandwidth	1 MHz
Video Bandwidth	Auto
Sweep Time	Auto

4.6.3 Test Setup Layout

Substituted Method Test Set-up

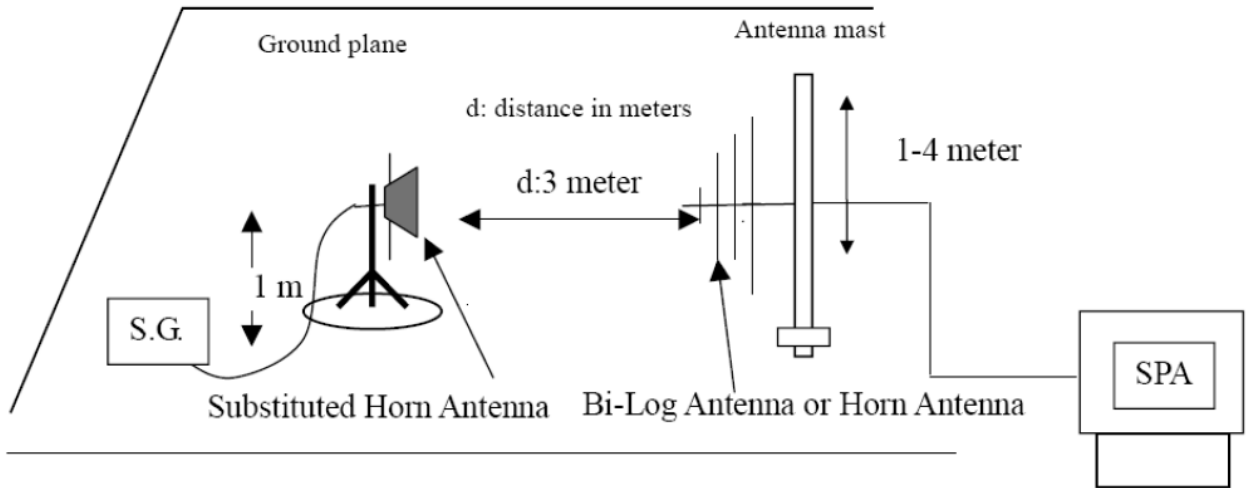



4.6.4 Test Result

4.6.4.1 GPRS 850 Test Result

Applicant : Acer Incorporated
 Model No : ZG5
 EUT : Notebook PC
 Test Mode : GPRS 850 (Low CH128)
 Test Date : 08/28/2008

Harmonic	Frequency (MHz)	Polarization	FCC Max. Limit	S.G Power	Substitution Antenna Gain	Cable Loss	Peak Output Power
			(dBm)	(dBm)	(dBi)	(dBm)	(dBm)
2nd	1648.8	V	-13	-61.29	10.72	0.56	-51.13
3rd	2473.2	V	-13	-53.69	10.66	0.62	-43.65
4th	3297.6	V	-13	-38.60	10.78	0.74	-28.56
5th	4122.0	V	-13	*	*	*	*
6th	4946.4	V	-13	*	*	*	*
7th	5770.8	V	-13	*	*	*	*
8th	6595.2	V	-13	*	*	*	*
9th	7419.6	V	-13	*	*	*	*
10th	8244.0	V	-13	*	*	*	*
2nd	1648.8	H	-13	-59.04	10.72	0.56	-48.88
3rd	2473.2	H	-13	-56.05	10.66	0.62	-46.01
4th	3297.6	H	-13	-57.38	10.78	0.74	-47.34
5th	4122.0	H	-13	*	*	*	*
6th	4946.4	H	-13	*	*	*	*
7th	5770.8	H	-13	*	*	*	*
8th	6595.2	H	-13	*	*	*	*
9th	7419.6	H	-13	*	*	*	*
10th	8244.0	H	-13	*	*	*	*

Notes:

- * Indicates the spurious emission could not be detected due to noise limitations or ambients.
- Each emission reported reflects the highest absolute level at the specific harmonic for the low, mid, and high channels at maximum power.
- The Spectrum was investigated from 30 MHz to the tenth harmonic of the fundamental.
- ERP = S.G Power (dBm) + Substitution Antenna Gain (dBd) - Cable Loss (dB)
 ERP = S.G Power (dBm) + Substitution Antenna Gain (dBi) - Cable Loss (dB)

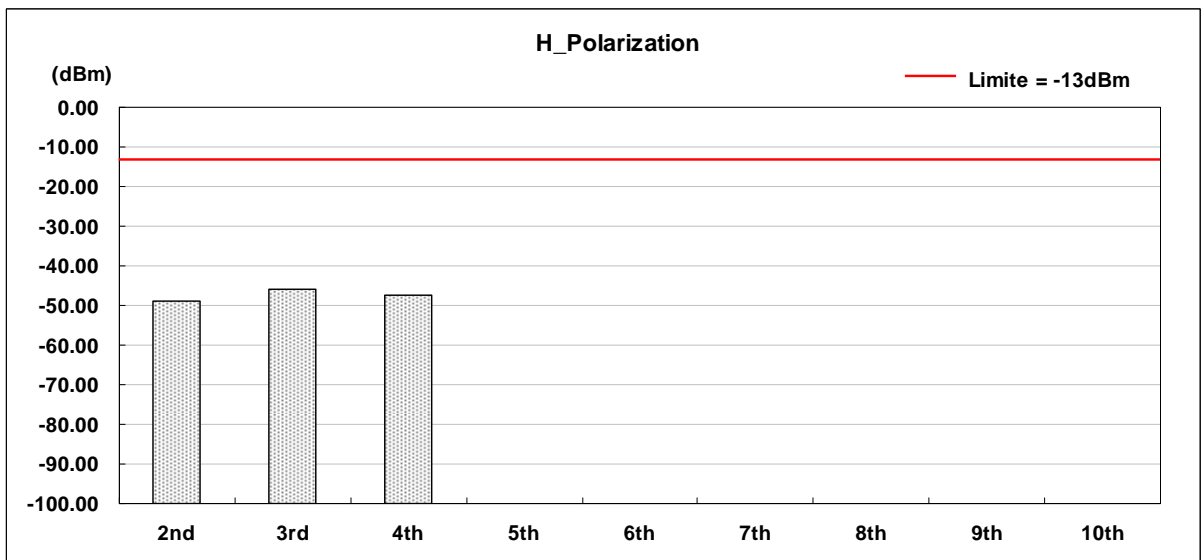
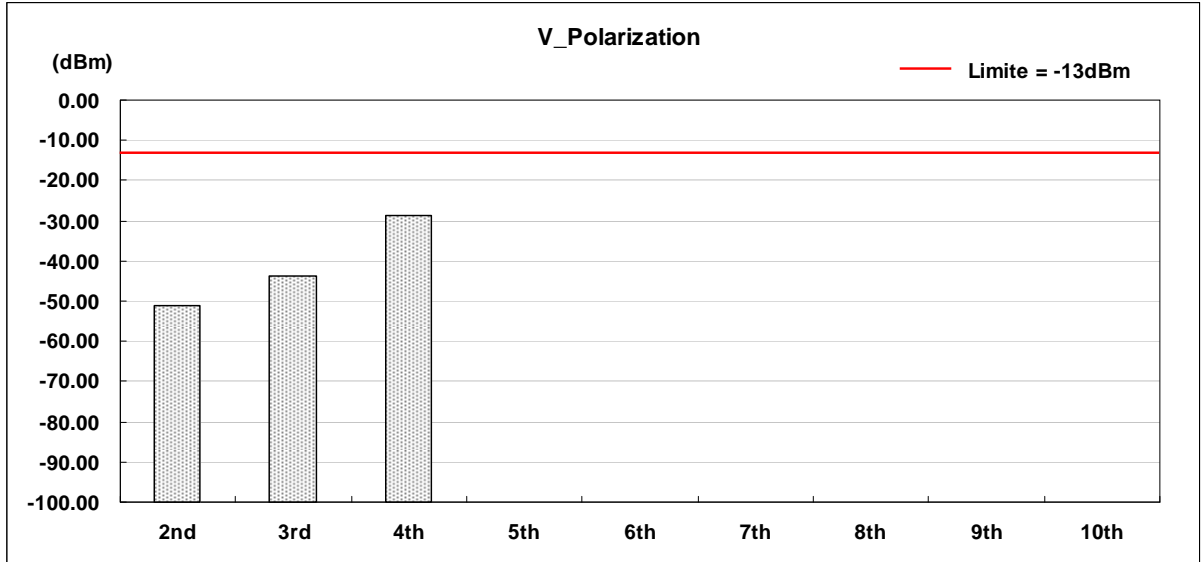



Applicant : Acer Incorporated
 Model No : ZG5
 EUT : Notebook PC
 Test Mode : GPRS 850 (Middle CH190)
 Test Date : 08/28/2008

Harmonic	Frequency (MHz)	Polarization	FCC Max. Limit	S.G Power	Substitution Antenna Gain	Cable Loss	Peak Output Power
			(dBm)	(dBm)	(dBi)	(dBm)	(dBm)
2nd	1673.2	V	-13	-61.43	10.72	0.56	-51.27
3rd	2509.8	V	-13	-53.74	10.66	0.62	-43.70
4th	3346.4	V	-13	-38.38	10.78	0.74	-28.34
5th	4183.0	V	-13	*	*	*	*
6th	5019.6	V	-13	*	*	*	*
7th	5856.2	V	-13	*	*	*	*
8th	6692.8	V	-13	*	*	*	*
9th	7529.4	V	-13	*	*	*	*
10th	8366.0	V	-13	*	*	*	*
2nd	1673.2	H	-13	-58.30	10.72	0.56	-48.14
3rd	2509.8	H	-13	-56.11	10.66	0.62	-46.07
4th	3346.4	H	-13	-56.87	10.78	0.74	-46.83
5th	4183.0	H	-13	*	*	*	*
6th	5019.6	H	-13	*	*	*	*
7th	5856.2	H	-13	*	*	*	*
8th	6692.8	H	-13	*	*	*	*
9th	7529.4	H	-13	*	*	*	*
10th	8366.0	H	-13	*	*	*	*

Notes:

- * Indicates the spurious emission could not be detected due to noise limitations or ambients.
- Each emission reported reflects the highest absolute level at the specific harmonic for the low, mid, and high channels at maximum power.
- The Spectrum was investigated from 30 MHz to the tenth harmonic of the fundamental.
- ERP = S.G Power (dBm) + Substitution Antenna Gain (dBd) - Cable Loss (dB)
 ERP = S.G Power (dBm) + Substitution Antenna Gain (dBi) - Cable Loss (dB)

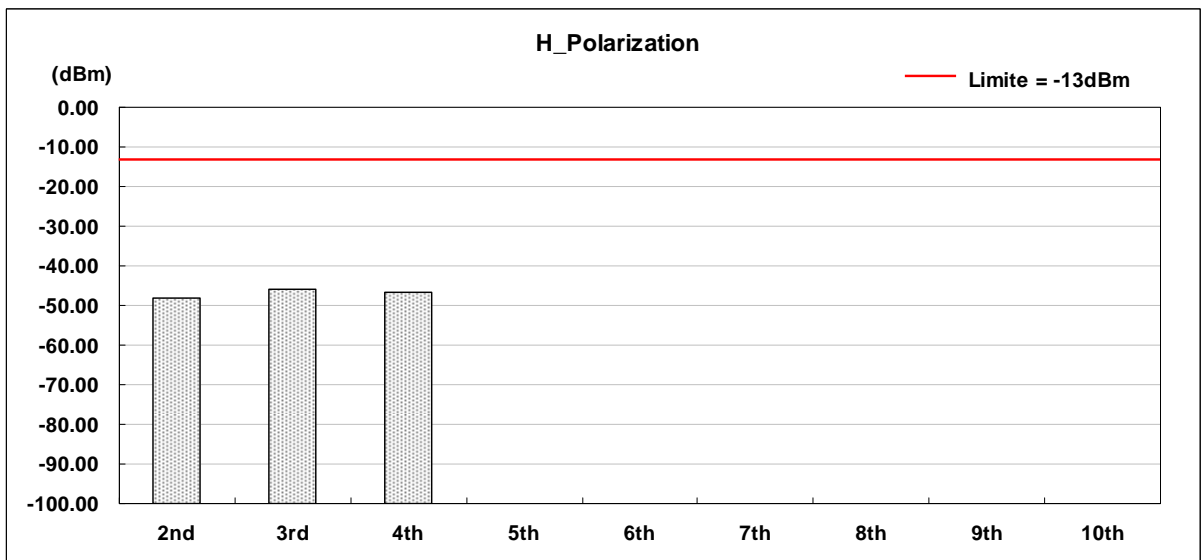
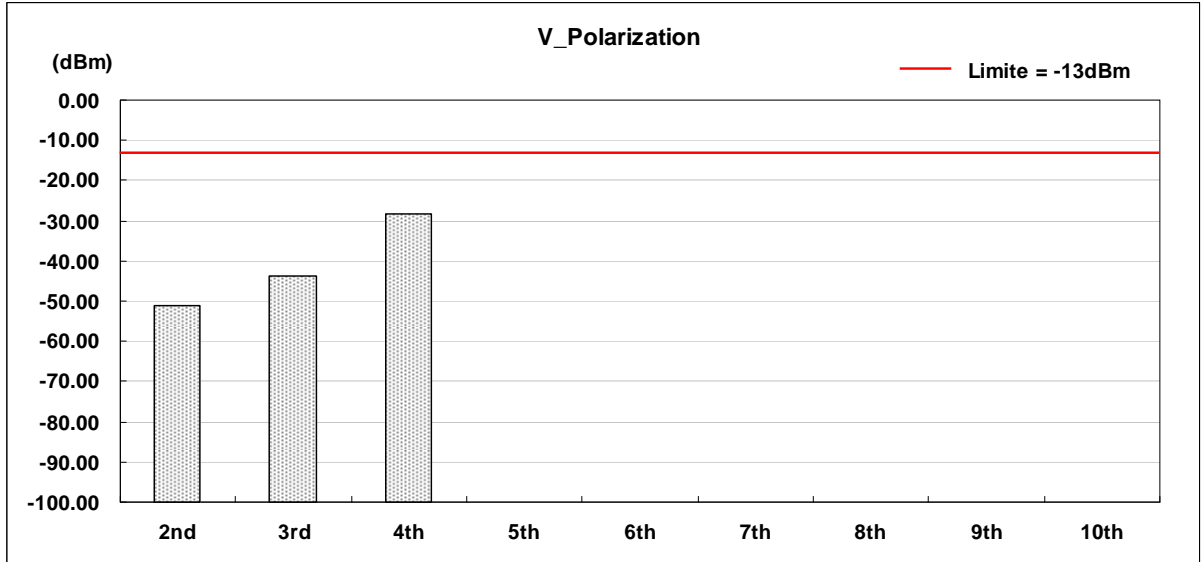



Applicant : Acer Incorporated
 Model No : ZG5
 EUT : Notebook PC
 Test Mode : GPRS 850 (High CH 251)
 Test Date : 08/28/2008

Harmonic	Frequency (MHz)	Polarization	FCC Max. Limit	S.G Power	Substitution Antenna Gain	Cable Loss	Peak Output Power
			(dBm)	(dBm)	(dBi)	(dBm)	(dBm)
2nd	1697.6	V	-13	-61.60	10.72	0.56	-51.44
3rd	2546.4	V	-13	-53.83	10.66	0.62	-43.79
4th	3395.2	V	-13	-38.72	10.78	0.74	-28.68
5th	4244.0	V	-13	*	*	*	*
6th	5092.8	V	-13	*	*	*	*
7th	5941.6	V	-13	*	*	*	*
8th	6790.4	V	-13	*	*	*	*
9th	7639.2	V	-13	*	*	*	*
10th	8488.0	V	-13	*	*	*	*
2nd	1697.6	H	-13	-58.11	10.72	0.56	-47.95
3rd	2546.4	H	-13	-55.93	10.66	0.62	-45.89
4th	3395.2	H	-13	-57.30	10.78	0.74	-47.26
5th	4244.0	H	-13	*	*	*	*
6th	5092.8	H	-13	*	*	*	*
7th	5941.6	H	-13	*	*	*	*
8th	6790.4	H	-13	*	*	*	*
9th	7639.2	H	-13	*	*	*	*
10th	8488.0	H	-13	*	*	*	*

Notes:

- * Indicates the spurious emission could not be detected due to noise limitations or ambients.
- Each emission reported reflects the highest absolute level at the specific harmonic for the low, mid, and high channels at maximum power.
- The Spectrum was investigated from 30 MHz to the tenth harmonic of the fundamental.
- ERP = S.G Power (dBm) + Substitution Antenna Gain (dBd) - Cable Loss (dB)
 ERP = S.G Power (dBm) + Substitution Antenna Gain (dBi) - Cable Loss (dB)

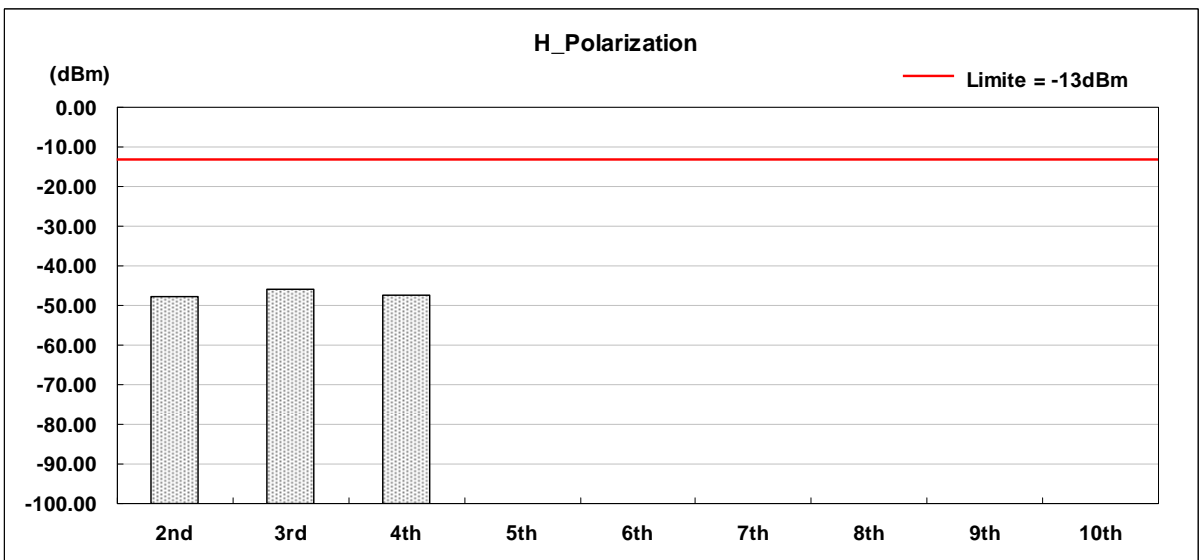
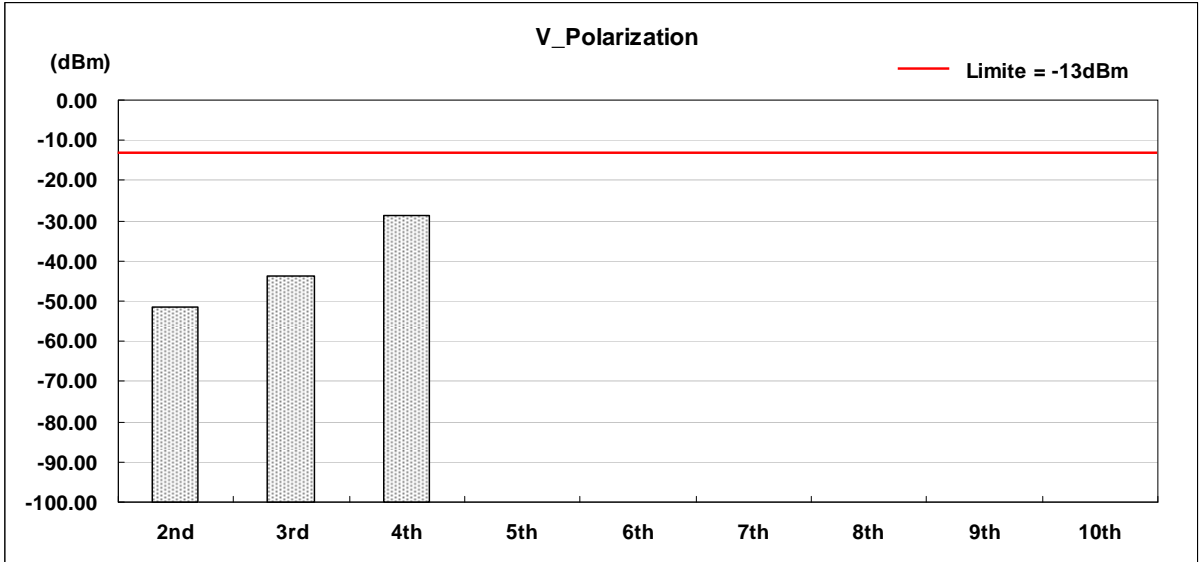



4.6.4.2 GPRS 1900 Test Result

Applicant : Acer Incorporated
 Model No : ZG5
 EUT : Notebook PC
 Test Mode : GPRS 1900 (Low CH512)
 Test Date : 08/28/2008

Harmonic	Frequency (MHz)	Polarization	FCC Max. Limit	S.G Power	Substitution Antenna Gain	Cable Loss	Peak Output Power
			(dBm)	(dBm)	(dBi)	(dBm)	(dBm)
2nd	3700.4	V	-13	-53.50	10.72	0.56	-43.34
3rd	5550.6	V	-13	-48.76	10.66	0.62	-38.72
4th	7400.8	V	-13	-41.61	10.78	0.74	-31.57
5th	9251.0	V	-13	*	*	*	*
6th	11101.2	V	-13	*	*	*	*
7th	12951.4	V	-13	*	*	*	*
8th	14801.6	V	-13	*	*	*	*
9th	16651.8	V	-13	*	*	*	*
10th	18502.0	V	-13	*	*	*	*
2nd	3700.4	H	-13	-56.81	10.72	0.56	-46.65
3rd	5550.6	H	-13	-49.53	10.66	0.62	-39.49
4th	7400.8	H	-13	-55.41	10.78	0.74	-45.37
5th	9251.0	H	-13	*	*	*	*
6th	11101.2	H	-13	*	*	*	*
7th	12951.4	H	-13	*	*	*	*
8th	14801.6	H	-13	*	*	*	*
9th	16651.8	H	-13	*	*	*	*
10th	18502.0	H	-13	*	*	*	*

Notes:

- * Indicates the spurious emission could not be detected due to noise limitations or ambients.
- Each emission reported reflects the highest absolute level at the specific harmonic for the low, mid, and high channels at maximum power.
- The Spectrum was investigated from 30 MHz to the tenth harmonic of the fundamental.
- ERP = S.G Power (dBm) + Substitution Antenna Gain (dBd) - Cable Loss (dB)
 ERP = S.G Power (dBm) + Substitution Antenna Gain (dBi) - Cable Loss (dB)

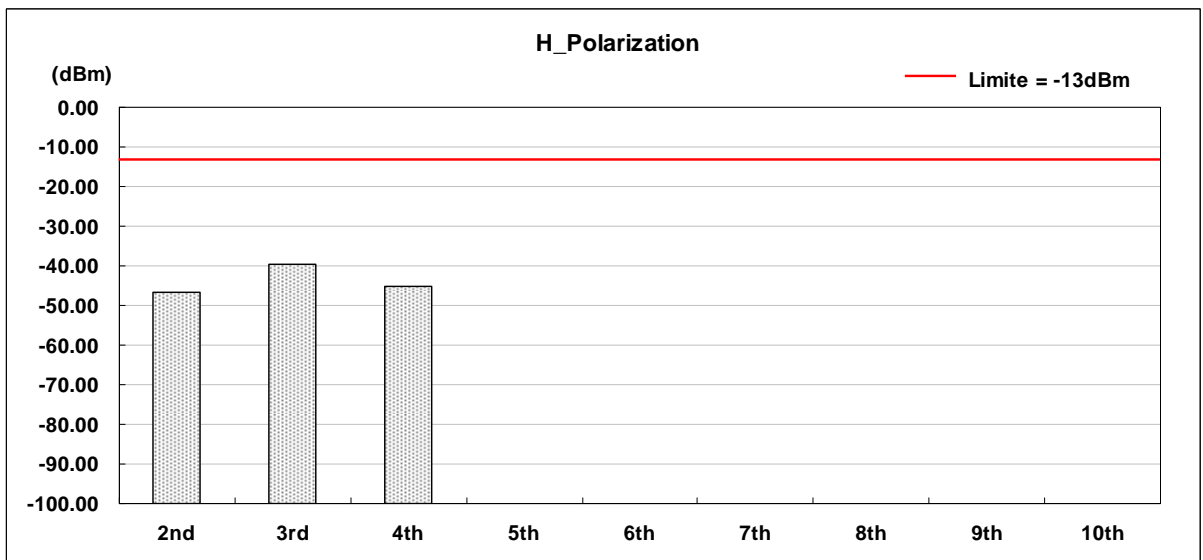
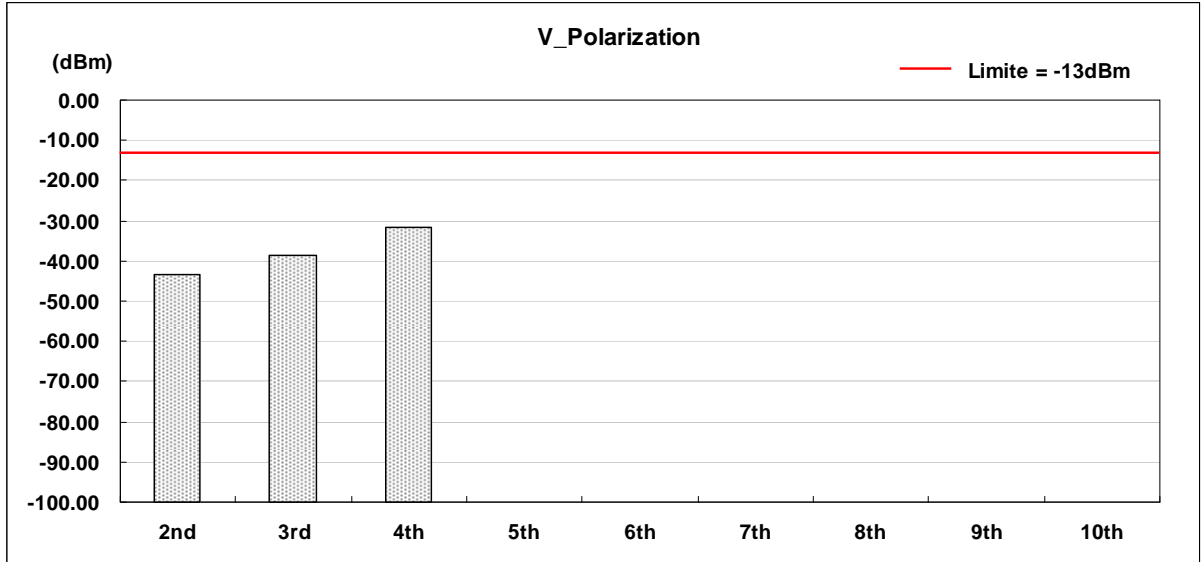



Applicant : Acer Incorporated
 Model No : ZG5
 EUT : Notebook PC
 Test Mode : GPRS 1900 (Middle CH661)
 Test Date : 08/28/2008

Harmonic	Frequency (MHz)	Polarization	FCC Max. Limit	S.G Power	Substitution Antenna Gain	Cable Loss	Peak Output Power
			(dBm)	(dBm)	(dBi)	(dBm)	(dBm)
2nd	3760.0	V	-13	-53.61	10.72	0.56	-43.45
3rd	5640.0	V	-13	-49.50	10.66	0.62	-39.46
4th	7520.0	V	-13	-41.32	10.78	0.74	-31.28
5th	9400.0	V	-13	*	*	*	*
6th	11280.0	V	-13	*	*	*	*
7th	13160.0	V	-13	*	*	*	*
8th	15040.0	V	-13	*	*	*	*
9th	16920.0	V	-13	*	*	*	*
10th	18800.0	V	-13	*	*	*	*
2nd	3760.0	H	-13	-56.93	10.72	0.56	-46.77
3rd	5640.0	H	-13	-46.60	10.66	0.62	-36.56
4th	7520.0	H	-13	-56.24	10.78	0.74	-46.20
5th	9400.0	H	-13	*	*	*	*
6th	11280.0	H	-13	*	*	*	*
7th	13160.0	H	-13	*	*	*	*
8th	15040.0	H	-13	*	*	*	*
9th	16920.0	H	-13	*	*	*	*
10th	18800.0	H	-13	*	*	*	*

Notes:

- * Indicates the spurious emission could not be detected due to noise limitations or ambients.
- Each emission reported reflects the highest absolute level at the specific harmonic for the low, mid, and high channels at maximum power.
- The Spectrum was investigated from 30 MHz to the tenth harmonic of the fundamental.
- $ERP = S.G \text{ Power (dBm)} + \text{Substitution Antenna Gain (dBd)} - \text{Cable Loss (dB)}$
 $ERP = S.G \text{ Power (dBm)} + \text{Substitution Antenna Gain (dBi)} - \text{Cable Loss (dB)}$

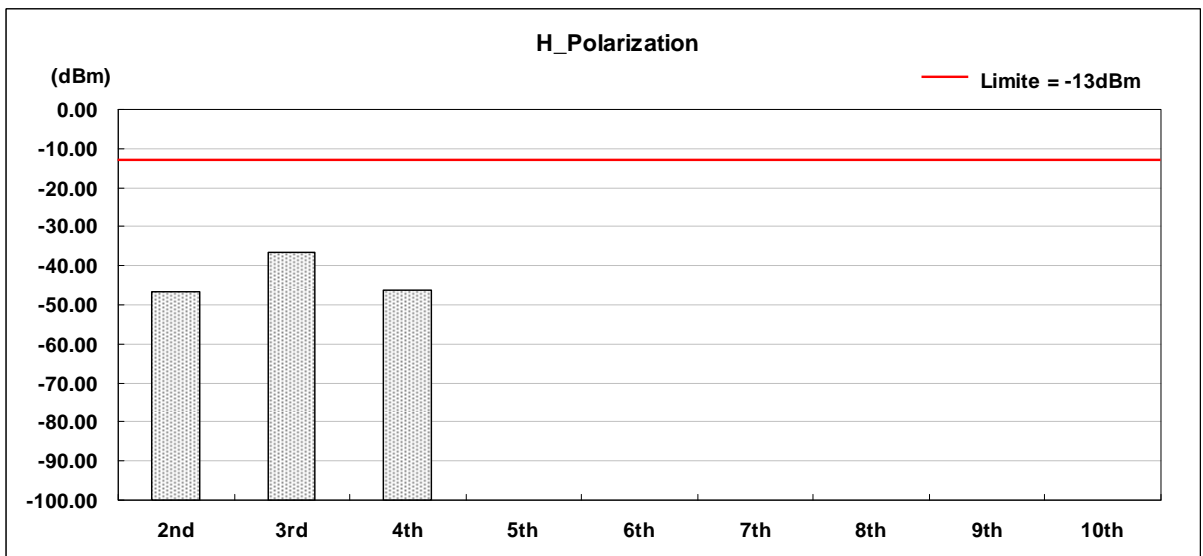
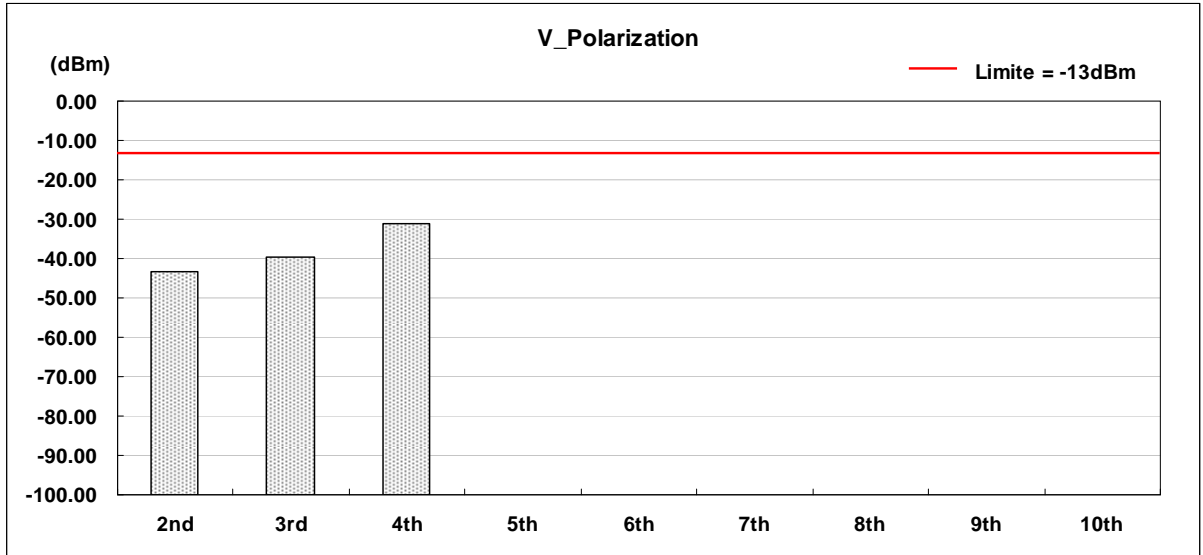



Applicant : Acer Incorporated
 Model No : ZG5
 EUT : Notebook PC
 Test Mode : GPRS 1900 (High CH 810)
 Test Date : 08/28/2008

Harmonic	Frequency (MHz)	Polarization	FCC Max. Limit	S.G Power	Substitution Antenna Gain	Cable Loss	Peak Output Power
			(dBm)	(dBm)	(dBi)	(dBm)	(dBm)
2nd	3819.6	V	-13	-53.51	10.72	0.56	-43.35
3rd	5729.4	V	-13	-49.54	10.66	0.62	-39.50
4th	7639.2	V	-13	-41.64	10.78	0.74	-31.60
5th	9549.0	V	-13	*	*	*	*
6th	11458.8	V	-13	*	*	*	*
7th	13368.6	V	-13	*	*	*	*
8th	15278.4	V	-13	*	*	*	*
9th	17188.2	V	-13	*	*	*	*
10th	19098.0	V	-13	*	*	*	*
2nd	3819.6	H	-13	-56.50	10.72	0.56	-46.34
3rd	5729.4	H	-13	-44.17	10.66	0.62	-34.13
4th	7639.2	H	-13	-55.40	10.78	0.74	-45.36
5th	9549.0	H	-13	*	*	*	*
6th	11458.8	H	-13	*	*	*	*
7th	13368.6	H	-13	*	*	*	*
8th	15278.4	H	-13	*	*	*	*
9th	17188.2	H	-13	*	*	*	*
10th	19098.0	H	-13	*	*	*	*

Notes:

- * Indicates the spurious emission could not be detected due to noise limitations or ambients.
- Each emission reported reflects the highest absolute level at the specific harmonic for the low, mid, and high channels at maximum power.
- The Spectrum was investigated from 30 MHz to the tenth harmonic of the fundamental.
- ERP = S.G Power (dBm) + Substitution Antenna Gain (dBd) - Cable Loss (dB)
 ERP = S.G Power (dBm) + Substitution Antenna Gain (dBi) - Cable Loss (dB)

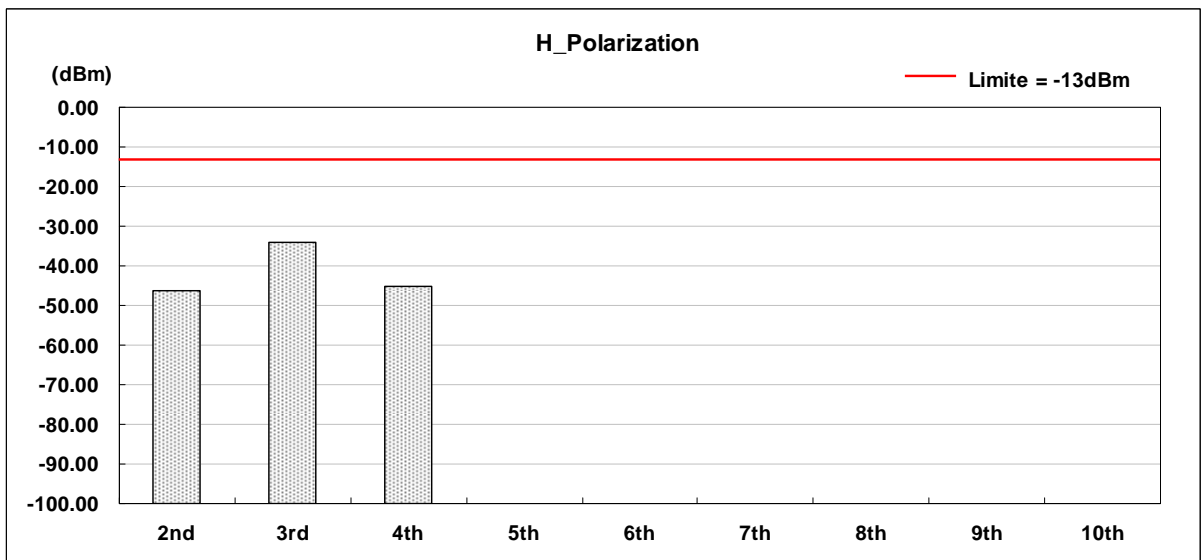
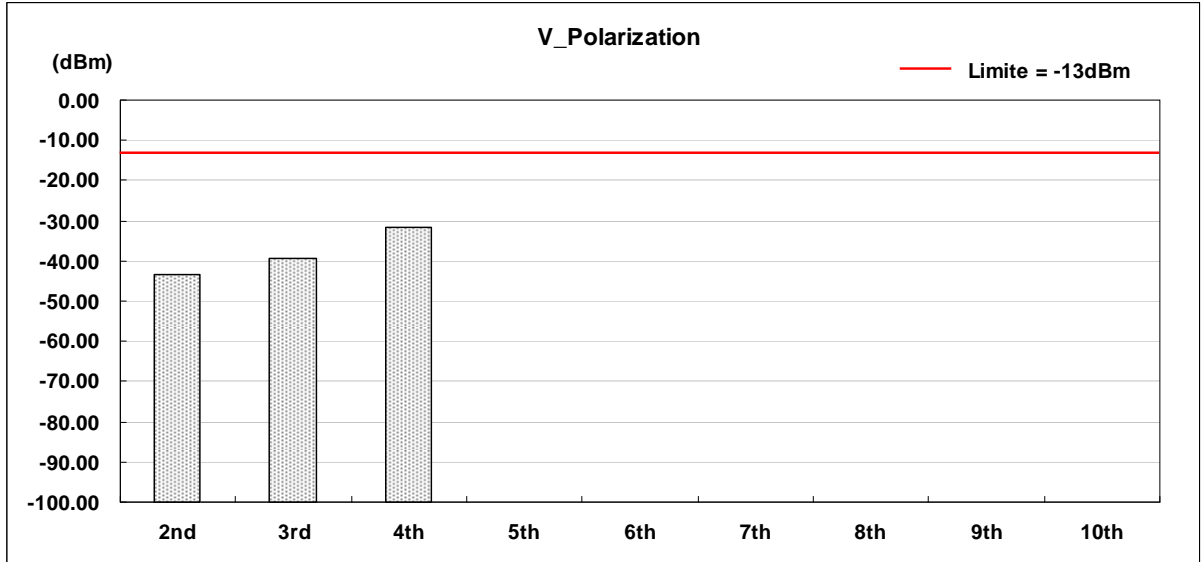



4.6.4.3 WCDMA Band V Test Result

Applicant : Acer Incorporated
 Model No : ZG5
 EUT : Notebook PC
 Test Mode : WCDMA Band V (Low CH4132)
 Test Date : 08/28/2008

Harmonic	Frequency (MHz)	Polarization	FCC Max. Limit	S.G Power	Substitution Antenna Gain	Cable Loss	Peak Output Power
			(dBm)	(dBm)	(dBi)	(dBm)	(dBm)
2nd	1652.8	V	-13	-61.62	10.74	0.59	-51.47
3rd	2479.2	V	-13	-54.06	10.68	0.63	-44.01
4th	3305.6	V	-13	-38.38	10.80	0.78	-28.36
5th	4132.0	V	-13	*	*	*	*
6th	4958.4	V	-13	*	*	*	*
7th	5784.8	V	-13	*	*	*	*
8th	6611.2	V	-13	*	*	*	*
9th	7437.6	V	-13	*	*	*	*
10th	8264.0	V	-13	*	*	*	*
2nd	1652.8	H	-13	-58.39	10.74	0.59	-48.24
3rd	2479.2	H	-13	-56.17	10.68	0.63	-46.12
4th	3305.6	H	-13	-56.69	10.80	0.78	-46.67
5th	4132.0	H	-13	*	*	*	*
6th	4958.4	H	-13	*	*	*	*
7th	5784.8	H	-13	*	*	*	*
8th	6611.2	H	-13	*	*	*	*
9th	7437.6	H	-13	*	*	*	*
10th	8264.0	H	-13	*	*	*	*

Notes:

- * Indicates the spurious emission could not be detected due to noise limitations or ambients.
- Each emission reported reflects the highest absolute level at the specific harmonic for the low, mid, and high channels at maximum power.
- The Spectrum was investigated from 30 MHz to the tenth harmonic of the fundamental.
- ERP = S.G Power (dBm) + Substitution Antenna Gain (dBd) - Cable Loss (dB)
 ERP = S.G Power (dBm) + Substitution Antenna Gain (dBi) - Cable Loss (dB)

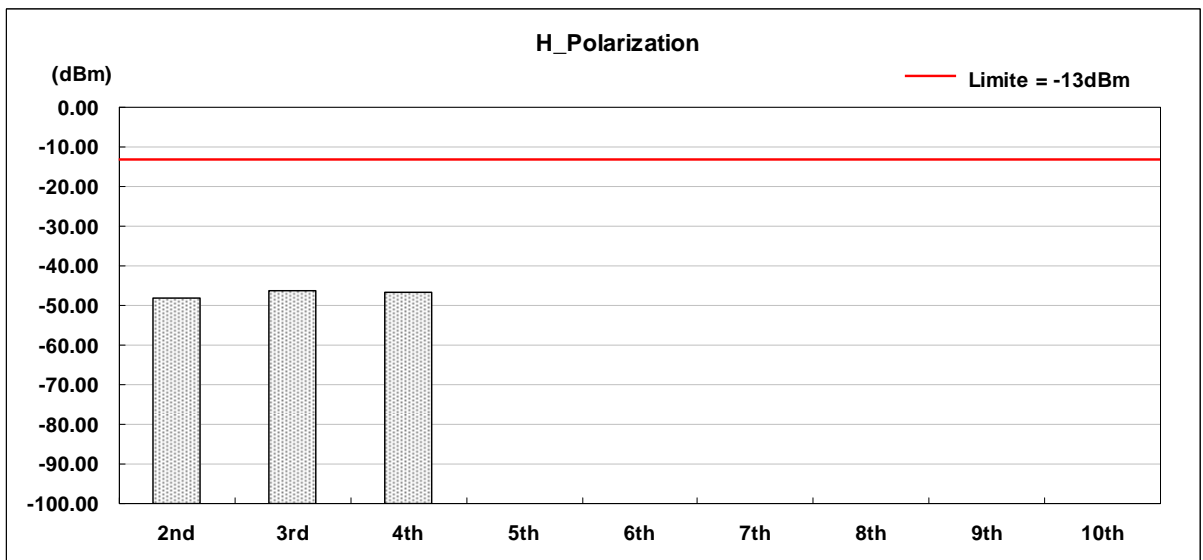
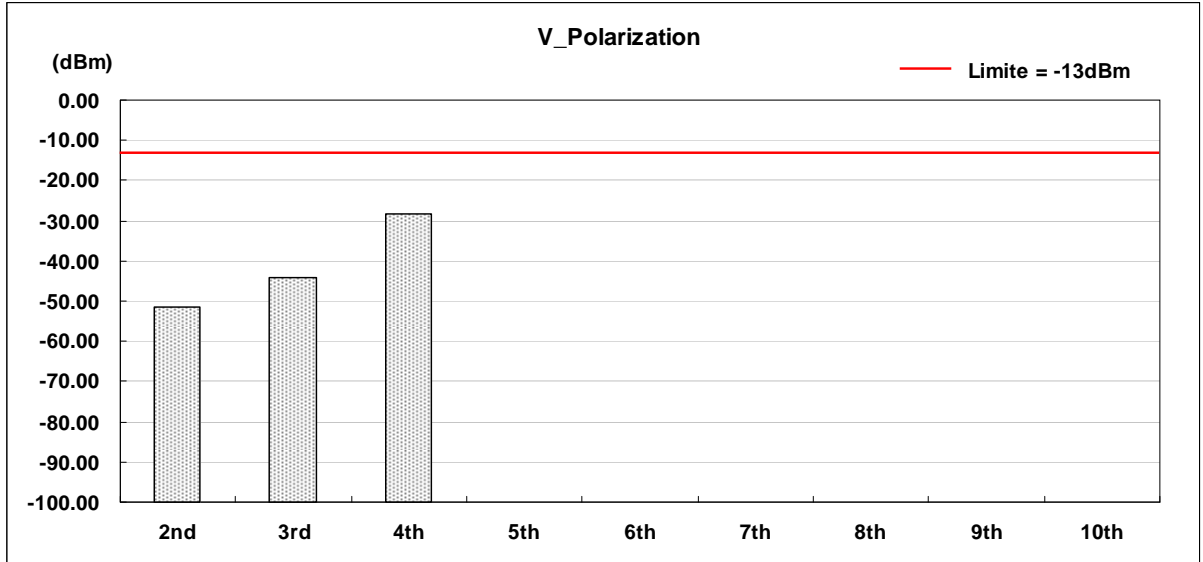



Applicant : Acer Incorporated
 Model No : ZG5
 EUT : Notebook PC
 Test Mode : WCDMA Band V (Middle CH4182)
 Test Date : 08/28/2008

Harmonic	Frequency (MHz)	Polarization	FCC Max. Limit	S.G Power	Substitution Antenna Gain	Cable Loss	Peak Output Power
			(dBm)	(dBm)	(dBi)	(dBm)	(dBm)
2nd	1693.2	V	-13	-60.38	10.74	0.59	-50.23
3rd	2539.8	V	-13	-52.64	10.68	0.63	-42.59
4th	3386.4	V	-13	-39.03	10.80	0.78	-29.01
5th	4233.0	V	-13	*	*	*	*
6th	5079.6	V	-13	*	*	*	*
7th	5926.2	V	-13	*	*	*	*
8th	6772.8	V	-13	*	*	*	*
9th	7619.4	V	-13	*	*	*	*
10th	8466.0	V	-13	*	*	*	*
2nd	1693.2	H	-13	-56.43	10.74	0.59	-46.28
3rd	2539.8	H	-13	-55.20	10.68	0.63	-45.15
4th	3386.4	H	-13	-57.30	10.80	0.78	-47.28
5th	4233.0	H	-13	*	*	*	*
6th	5079.6	H	-13	*	*	*	*
7th	5926.2	H	-13	*	*	*	*
8th	6772.8	H	-13	*	*	*	*
9th	7619.4	H	-13	*	*	*	*
10th	8466.0	H	-13	*	*	*	*

Notes:

- * Indicates the spurious emission could not be detected due to noise limitations or ambients.
- Each emission reported reflects the highest absolute level at the specific harmonic for the low, mid, and high channels at maximum power.
- The Spectrum was investigated from 30 MHz to the tenth harmonic of the fundamental.
- ERP = S.G Power (dBm) + Substitution Antenna Gain (dBd) - Cable Loss (dB)
 ERP = S.G Power (dBm) + Substitution Antenna Gain (dBi) - Cable Loss (dB)

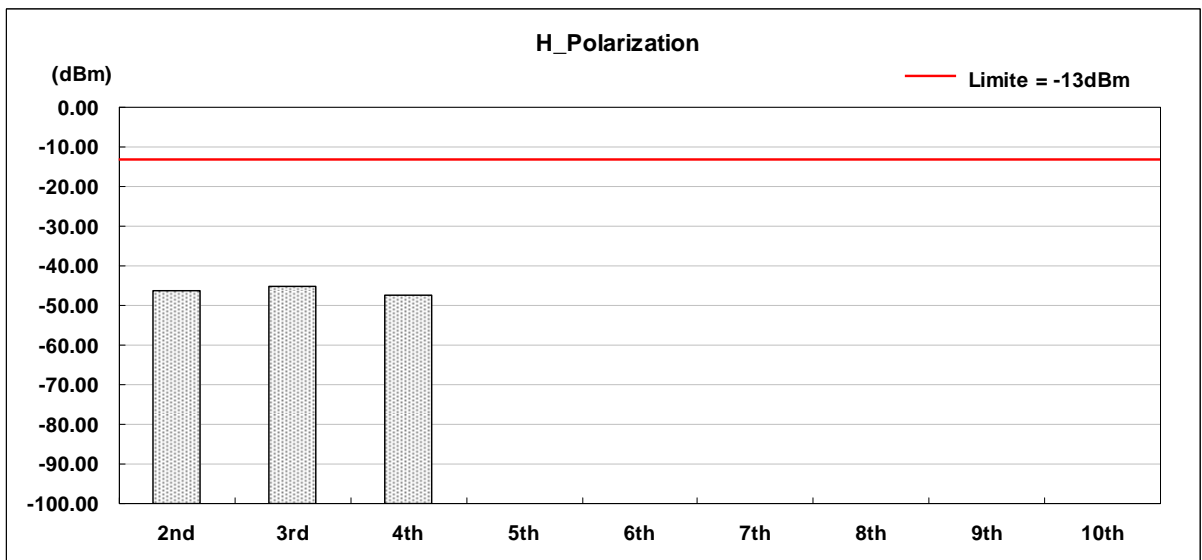
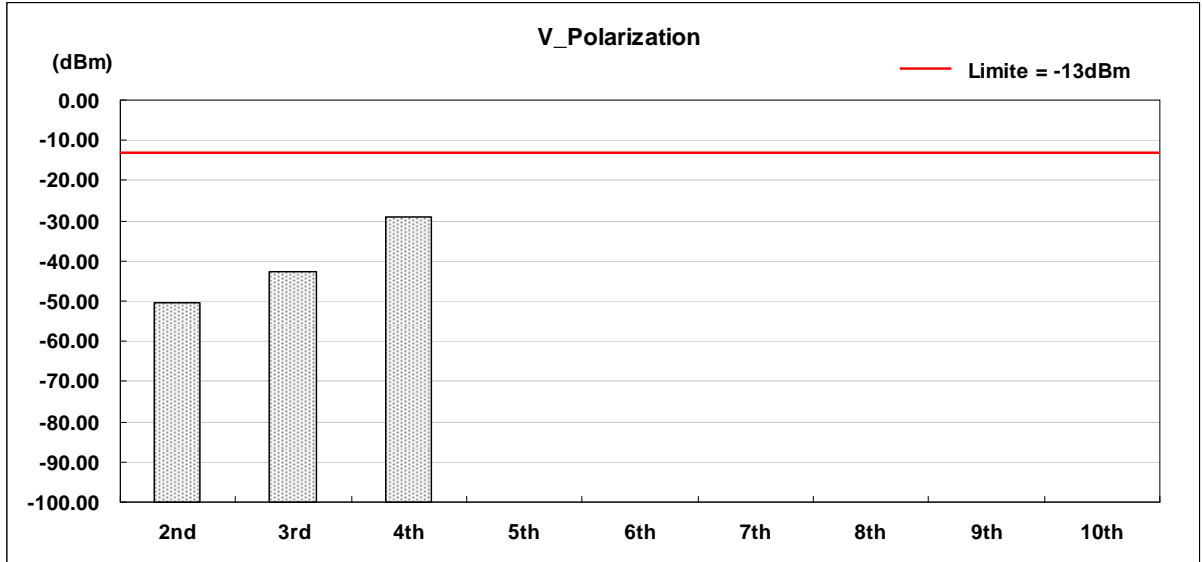



Applicant : Acer Incorporated
 Model No : ZG5
 EUT : Notebook PC
 Test Mode : WCDMA Band V (High CH 4233)
 Test Date : 08/28/2008

Harmonic	Frequency (MHz)	Polarization	FCC Max. Limit	S.G Power	Substitution Antenna Gain	Cable Loss	Peak Output Power
			(dBm)	(dBm)	(dBi)	(dBm)	(dBm)
2nd	1693.2	V	-13	-61.54	10.74	0.59	-51.39
3rd	2539.8	V	-13	-54.34	10.68	0.63	-44.29
4th	3386.4	V	-13	-38.43	10.80	0.78	-28.41
5th	4233.0	V	-13	*	*	*	*
6th	5079.6	V	-13	*	*	*	*
7th	5926.2	V	-13	*	*	*	*
8th	6772.8	V	-13	*	*	*	*
9th	7619.4	V	-13	*	*	*	*
10th	8466.0	V	-13	*	*	*	*
2nd	1693.2	H	-13	-58.28	10.74	0.59	-48.13
3rd	2539.8	H	-13	-56.01	10.68	0.63	-45.96
4th	3386.4	H	-13	-56.56	10.80	0.78	-46.54
5th	4233.0	H	-13	*	*	*	*
6th	5079.6	H	-13	*	*	*	*
7th	5926.2	H	-13	*	*	*	*
8th	6772.8	H	-13	*	*	*	*
9th	7619.4	H	-13	*	*	*	*
10th	8466.0	H	-13	*	*	*	*

Notes:

- * Indicates the spurious emission could not be detected due to noise limitations or ambients.
- Each emission reported reflects the highest absolute level at the specific harmonic for the low, mid, and high channels at maximum power.
- The Spectrum was investigated from 30 MHz to the tenth harmonic of the fundamental.
- ERP = S.G Power (dBm) + Substitution Antenna Gain (dBd) - Cable Loss (dB)
 ERP = S.G Power (dBm) + Substitution Antenna Gain (dBi) - Cable Loss (dB)

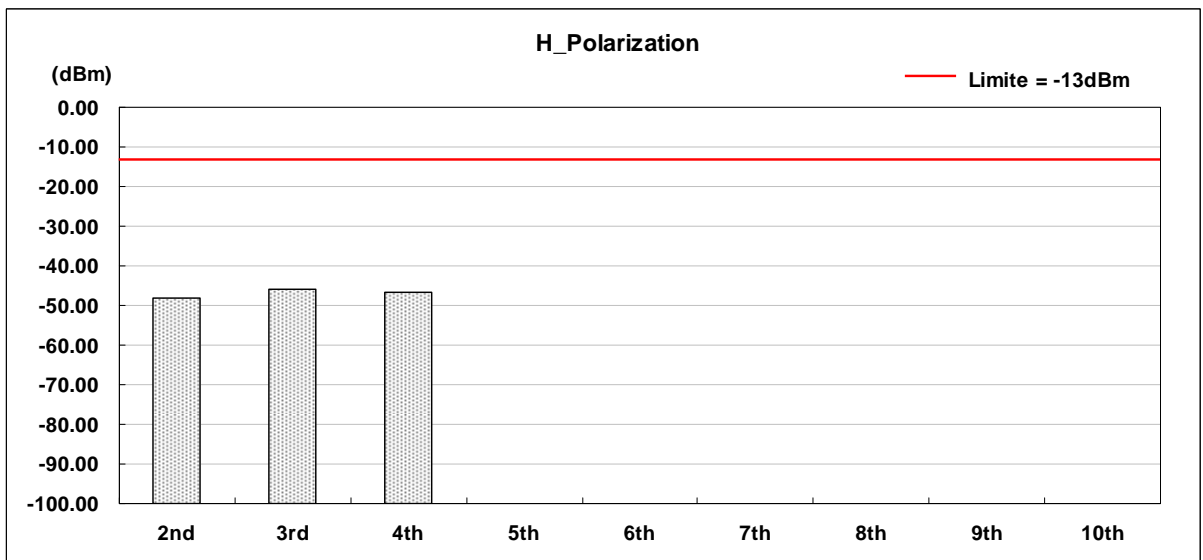
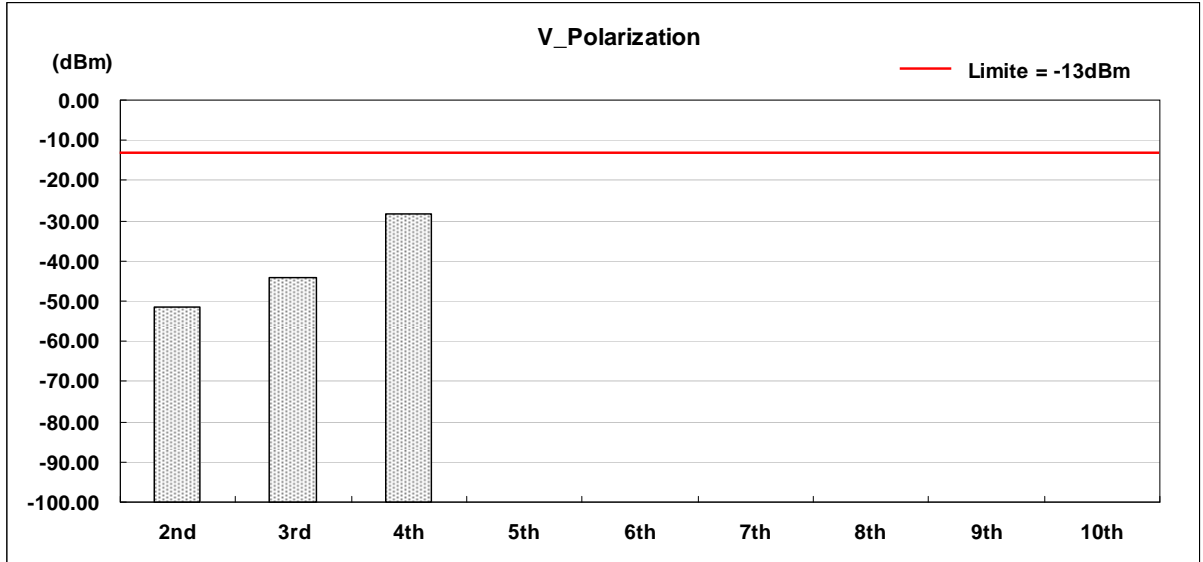



4.6.4.4 WCDMA Band II Test Result

Applicant : Acer Incorporated
 Model No : ZG5
 EUT : Notebook PC
 Test Mode : WCDMA Band II (Low CH9262)
 Test Date : 08/28/2008

Harmonic	Frequency (MHz)	Polarization	FCC Max. Limit	S.G Power	Substitution Antenna Gain	Cable Loss	Peak Output Power
			(dBm)	(dBm)	(dBi)	(dBm)	(dBm)
2nd	3704.8	V	-13	-50.08	10.79	0.58	-39.87
3rd	5557.2	V	-13	-48.74	10.71	0.63	-38.66
4th	7409.6	V	-13	-41.97	10.81	0.78	-31.94
5th	9262.0	V	-13	*	*	*	*
6th	11114.4	V	-13	*	*	*	*
7th	12966.8	V	-13	*	*	*	*
8th	14819.2	V	-13	*	*	*	*
9th	16671.6	V	-13	*	*	*	*
10th	18524.0	V	-13	*	*	*	*
2nd	3704.8	H	-13	-58.13	10.79	0.58	-47.92
3rd	5557.2	H	-13	-58.50	10.71	0.63	-48.42
4th	7409.6	H	-13	-55.09	10.81	0.78	-45.06
5th	9262.0	H	-13	*	*	*	*
6th	11114.4	H	-13	*	*	*	*
7th	12966.8	H	-13	*	*	*	*
8th	14819.2	H	-13	*	*	*	*
9th	16671.6	H	-13	*	*	*	*
10th	18524.0	H	-13	*	*	*	*

Notes:

- * Indicates the spurious emission could not be detected due to noise limitations or ambients.
- Each emission reported reflects the highest absolute level at the specific harmonic for the low, mid, and high channels at maximum power.
- The Spectrum was investigated from 30 MHz to the tenth harmonic of the fundamental.
- ERP = S.G Power (dBm) + Substitution Antenna Gain (dBd) - Cable Loss (dB)
 ERP = S.G Power (dBm) + Substitution Antenna Gain (dBi) - Cable Loss (dB)

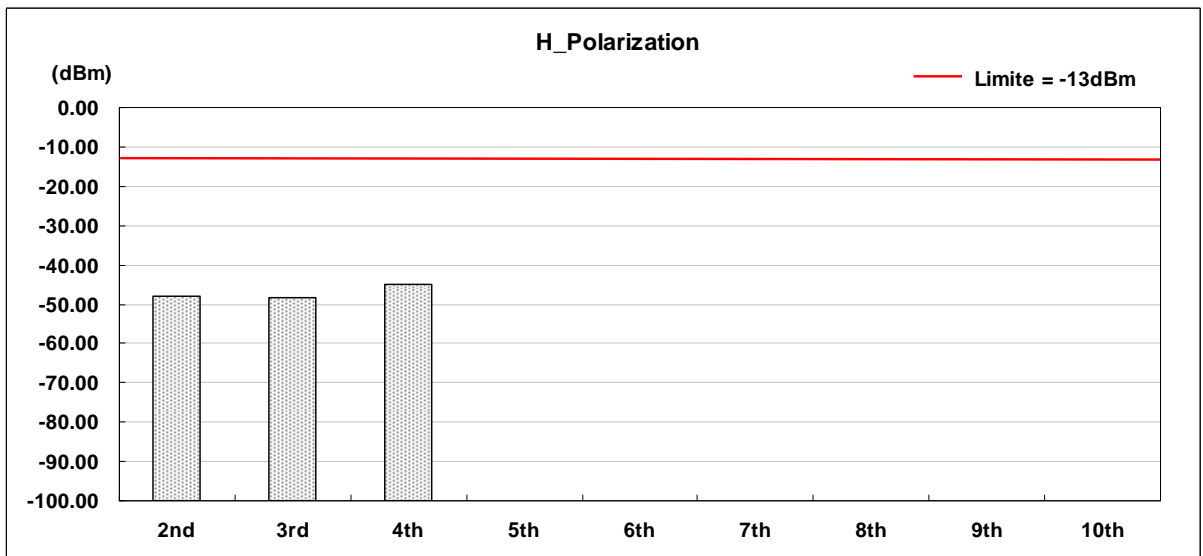
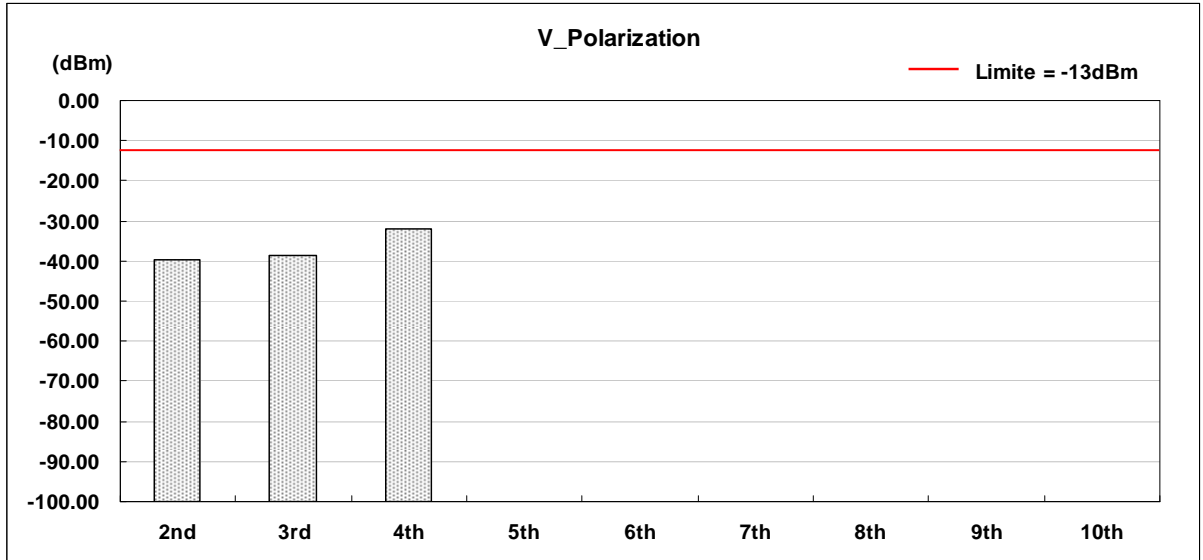



Applicant : Acer Incorporated
 Model No : ZG5
 EUT : Notebook PC
 Test Mode : WCDMA Band II (Middle CH9400)
 Test Date : 08/28/2008

Harmonic	Frequency (MHz)	Polarization	FCC Max. Limit	S.G Power	Substitution Antenna Gain	Cable Loss	Peak Output Power
			(dBm)	(dBm)	(dBi)	(dBm)	(dBm)
2nd	3760.0	V	-13	-43.66	10.79	0.58	-33.45
3rd	5640.0	V	-13	-49.38	10.71	0.63	-39.30
4th	7520.0	V	-13	-41.10	10.81	0.78	-31.07
5th	9400.0	V	-13	*	*	*	*
6th	11280.0	V	-13	*	*	*	*
7th	13160.0	V	-13	*	*	*	*
8th	15040.0	V	-13	*	*	*	*
9th	16920.0	V	-13	*	*	*	*
10th	18800.0	V	-13	*	*	*	*
2nd	3760.0	H	-13	-56.88	10.79	0.58	-46.67
3rd	5640.0	H	-13	-58.03	10.71	0.63	-47.95
4th	7520.0	H	-13	-55.89	10.81	0.78	-45.86
5th	9400.0	H	-13	*	*	*	*
6th	11280.0	H	-13	*	*	*	*
7th	13160.0	H	-13	*	*	*	*
8th	15040.0	H	-13	*	*	*	*
9th	16920.0	H	-13	*	*	*	*
10th	18800.0	H	-13	*	*	*	*

Notes:

5. * Indicates the spurious emission could not be detected due to noise limitations or ambients.
6. Each emission reported reflects the highest absolute level at the specific harmonic for the low, mid, and high channels at maximum power.
7. The Spectrum was investigated from 30 MHz to the tenth harmonic of the fundamental.
8. ERP = S.G Power (dBm) + Substitution Antenna Gain (dBd) - Cable Loss (dB)
 ERP = S.G Power (dBm) + Substitution Antenna Gain (dBi) - Cable Loss (dB)

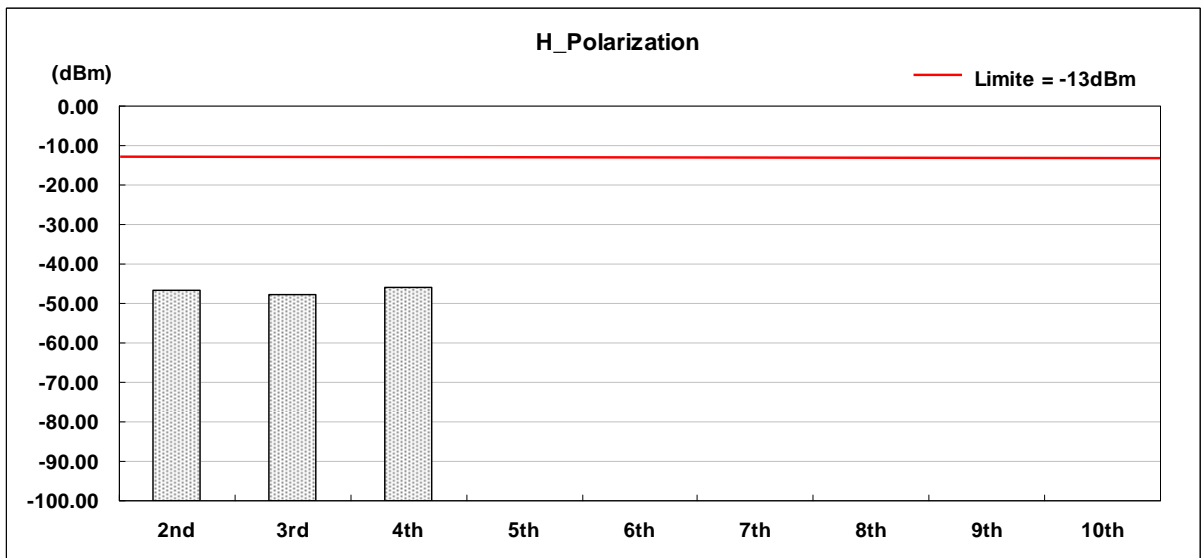
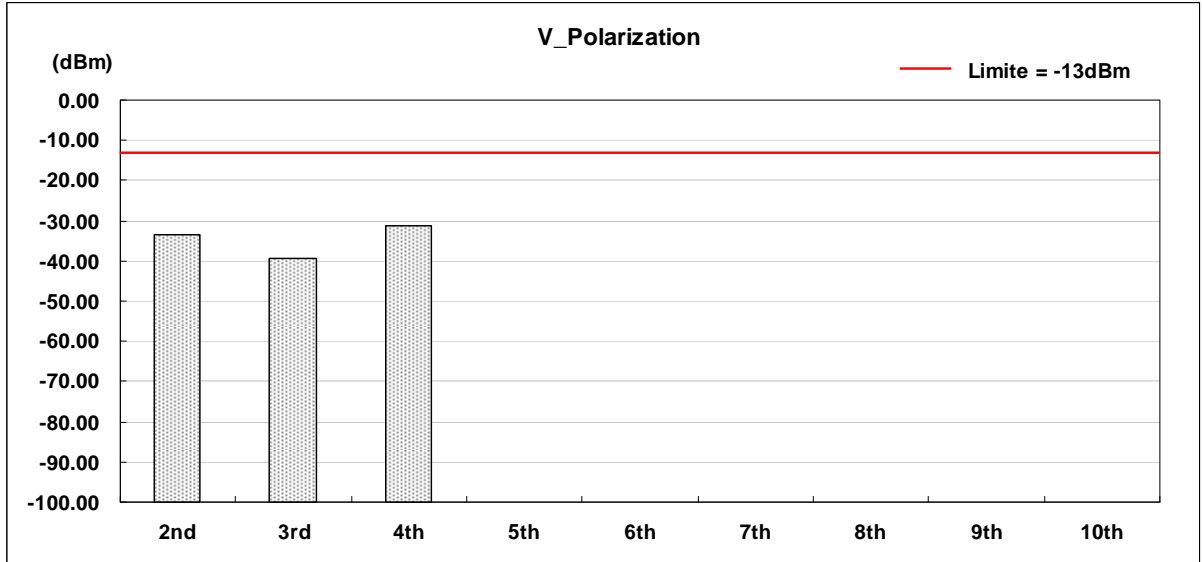



Applicant : Acer Incorporated
 Model No : ZG5
 EUT : Notebook PC
 Test Mode : WCDMA Band II (High CH 9538)
 Test Date : 08/28/2008

Harmonic	Frequency (MHz)	Polarization	FCC Max. Limit	S.G Power	Substitution Antenna Gain	Cable Loss	Peak Output Power
			(dBm)	(dBm)	(dBi)	(dBm)	(dBm)
2nd	3815.2	V	-13	-30.89	10.79	0.58	-20.68
3rd	5722.8	V	-13	-49.86	10.71	0.63	-39.78
4th	7630.4	V	-13	-41.15	10.81	0.78	-31.12
5th	9538.0	V	-13	*	*	*	*
6th	11445.6	V	-13	*	*	*	*
7th	13353.2	V	-13	*	*	*	*
8th	15260.8	V	-13	*	*	*	*
9th	17168.4	V	-13	*	*	*	*
10th	19076.0	V	-13	*	*	*	*
2nd	3815.2	H	-13	-40.75	10.79	0.58	-30.54
3rd	5722.8	H	-13	-58.69	10.71	0.63	-48.61
4th	7630.4	H	-13	-55.80	10.81	0.78	-45.77
5th	9538.0	H	-13	*	*	*	*
6th	11445.6	H	-13	*	*	*	*
7th	13353.2	H	-13	*	*	*	*
8th	15260.8	H	-13	*	*	*	*
9th	17168.4	H	-13	*	*	*	*
10th	19076.0	H	-13	*	*	*	*

Notes:

5. * Indicates the spurious emission could not be detected due to noise limitations or ambients.
6. Each emission reported reflects the highest absolute level at the specific harmonic for the low, mid, and high channels at maximum power.
7. The Spectrum was investigated from 30 MHz to the tenth harmonic of the fundamental.
8. ERP = S.G Power (dBm) + Substitution Antenna Gain (dBd) - Cable Loss (dB)
 ERP = S.G Power (dBm) + Substitution Antenna Gain (dBi) - Cable Loss (dB)

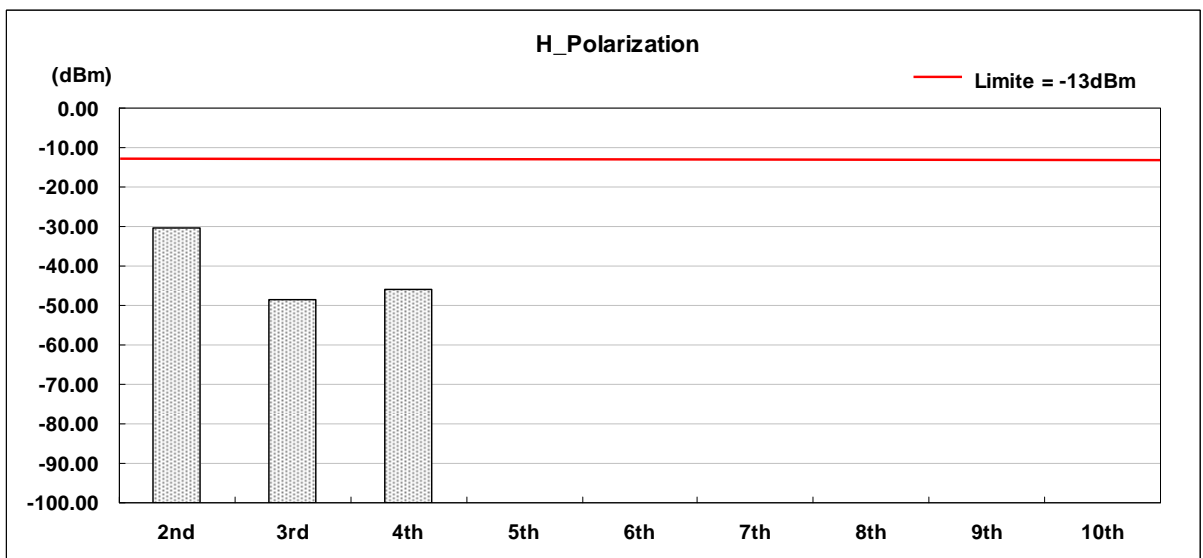
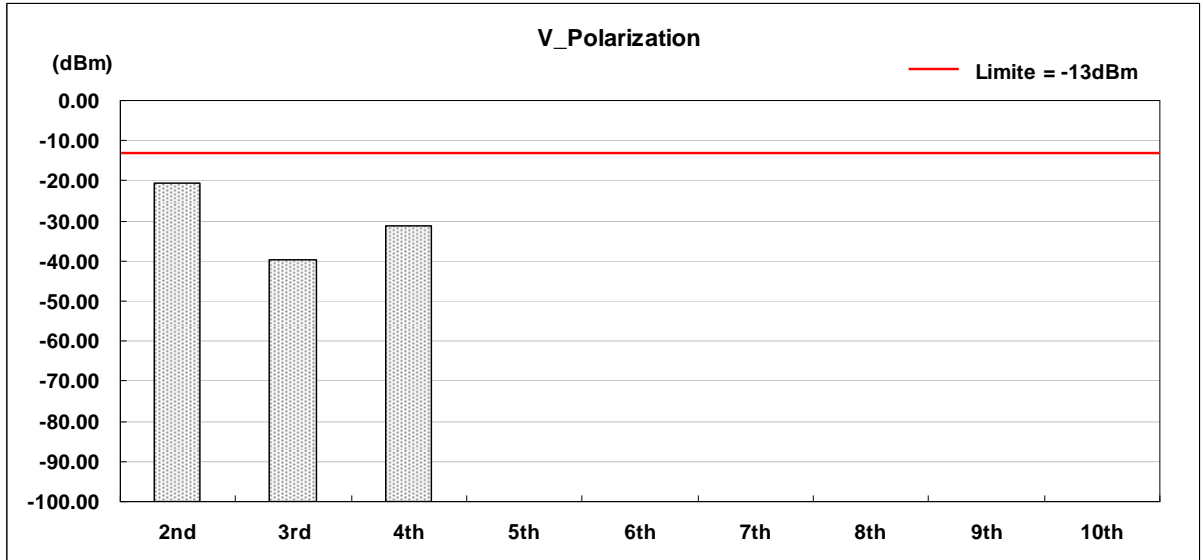

4.7 Frequency Stability (Temperature Variation)

4.7.1 Measurement Instrument

As described in chapter 5 of this test report.

4.7.2 Test Procedure

The measurement is made according to FCC rules part 22 and 24:

1. The EUT and test equipment were set up as shown on the following section.
2. With all power removed, the temperature was decreased to -30°C and permitted to stabilize for three hours. Power was applied and the maximum change in frequency was note within one minute.
3. With power OFF, the temperature was raised in 10°C steps. The sample was permitted to stabilize at each step for at least one-half hour. Power was applied and the maximum frequency change was noted within one minute.
4. The temperature tests were performed for the worst case.
5. Test data was recorded.

4.7.3 Test Setup Layout

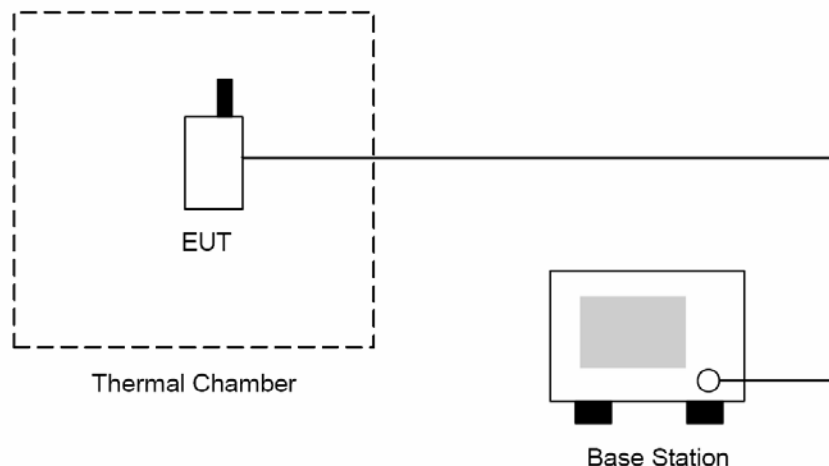



4.7.4 Test Result

Test Mode: GPRS 850 CH190

Temperature (°C)	Deviation (Hz)	Deviation (ppm)	Limit (ppm)
-30	22.19	0.027	0.1
-20	24.38	0.029	0.1
-10	22.61	0.027	0.1
0	18.79	0.022	0.1
10	15.48	0.019	0.1
20	23.23	0.028	0.1
30	29.57	0.035	0.1
40	30.4	0.036	0.1
50	22.18	0.027	0.1

Test Mode: GPRS 1900 CH661

Temperature (°C)	Deviation (Hz)	Deviation (ppm)	Limit (ppm)
-30	30.61	0.016	1
-20	34.27	0.018	1
-10	33.98	0.018	1
0	35.67	0.019	1
10	40.66	0.022	1
20	35.25	0.019	1
30	34.28	0.018	1
40	30.17	0.016	1
50	33.49	0.018	1



Test Mode: WCDMA Band V CH4182

Temperature (°C)	Deviation (Hz)	Deviation (ppm)	Limit (ppm)
-30	24.69	0.030	0.1
-20	35.18	0.042	0.1
-10	20.91	0.025	0.1
0	34.76	0.042	0.1
10	20.15	0.024	0.1
20	22.98	0.027	0.1
30	33.61	0.040	0.1
40	34.12	0.041	0.1
50	30.57	0.037	0.1

Test Mode: WCDMA Band II CH9400

Temperature (°C)	Deviation (Hz)	Deviation (ppm)	Limit (ppm)
-30	42.69	0.023	1
-20	43.85	0.023	1
-10	40.91	0.022	1
0	41.32	0.022	1
10	48.48	0.026	1
20	35.96	0.019	1
30	32.57	0.017	1
40	30.44	0.016	1
50	29.85	0.016	1

4.8 Frequency Stability (Voltage Variation)

4.8.1 Measurement Instrument

As described in chapter 5 of this test report.

4.8.2 Test Procedure

1. The EUT was placed in a temperature chamber at 25 ± 5 °C and connected as the following section.
2. The power supply voltage to the EUT was varied from BEP to 115% of the nominal value measured at the input to the EUT.
3. The variation in frequency was measured for the worst case.

4.8.3 Test Setup Layout

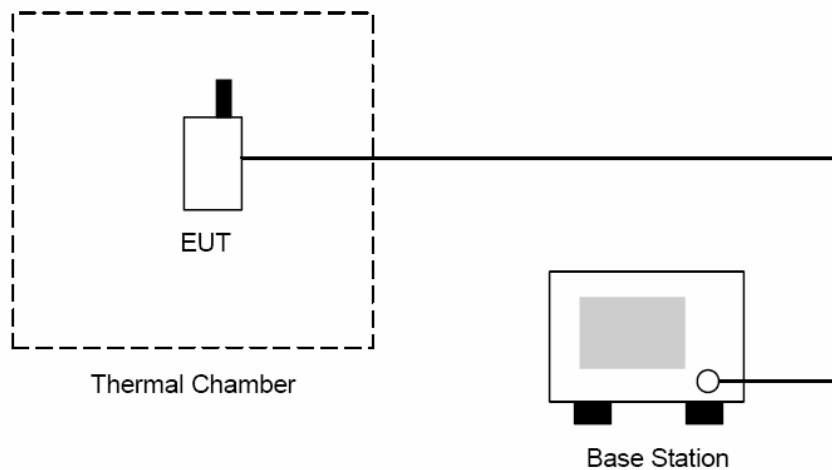



4.8.4 Test Result

Test Mode: GPRS 850 CH190

Level	Voltage [V]	Deviation [Hz]	Deviation [ppm]	Limit [ppm]
Battery full point	126.5	22.75	0.027	0.1
Normal	110.0	15.51	0.019	0.1
Battery cut-off point	93.5	12.69	0.015	0.1

Test Mode: GPRS 1900 CH661

Level	Voltage [V]	Deviation [Hz]	Deviation [ppm]	Limit [ppm]
Battery full point	126.5	39.58	0.021	1
Normal	110.0	33.33	0.018	1
Battery cut-off point	93.5	35.67	0.019	1

Test Mode: WCDMA Band V CH4182

Level	Voltage [V]	Deviation [Hz]	Deviation [ppm]	Limit [ppm]
Battery full point	126.5	22.72	0.027	0.1
Normal	110.0	20.68	0.025	0.1
Battery cut-off point	93.5	36.71	0.044	0.1

Test Mode: WCDMA Band II CH9400

Level	Voltage [V]	Deviation [Hz]	Deviation [ppm]	Limit [ppm]
Battery full point	126.5	45.39	0.024	1
Normal	110.0	48.62	0.026	1
Battery cut-off point	93.5	40.37	0.021	1



4.9 AC Power Conducted Emissions Requirements

4.9.1 Measurement Instrument

As described in chapter 5 of this test report.

4.9.2 Test Procedure

The measurement is made according to FCC rules 15.207:

The power line conducted emission measurements were performed in a shielded enclosure. The EUT was assembled on a wooden table which is 80 centimeters high, was placed 40 centimeters from the back wall and at least 1 meter from the sidewall.

Power was fed to the EUT from the public utility power grid through a line filter and EMCO Model 3162/2 SH Line Impedance Stabilization Networks (LISN). The LISN housing, measuring instrumentation case, ground plane, etc., were electrically bonded together at the same RF potential. The Spectrum analyzer was connected to the AC line through an isolation transformer. The 50-ohm output of the LISN was connected to the spectrum analyzer directly. Conducted emission levels were in the CISPR quasi-peak detection mode. The analyzer's 6 dB bandwidth was set to 9 KHz. No post-detector video filter was used.

The spectrum was scanned from 150 KHz to 30 MHz. The physical arrangement of the test system and associated cabling was varied (within the scope of arrangements likely to be encountered in actual use) to determine the effect on the unit's emanations in amplitude and frequency. All spurious emission frequencies were observed. The highest emission amplitudes relative to the appropriate limit were measured and have been recorded in paragraph 2.6.

4.9.3 Test Configuration:



Figure 1. Front View of the Test Configuration



Figure 2. Rear View of the Test Configuration



4.9.4 Test condition:

EUT tested in accordance with the specifications given by the Manufacturer, and exercised in the most unfavorable manner.

4.9.5 Conducted Emissions Limits:

Frequency range (MHz)	Limits (dBuV)	
	Quasi-peak	Average
0.15 to 0.50	66 to 56	56 to 46
0.50 to 5.0	56	46
5.0 to 30	60	50



4.9.6 Test Result

4.9.6.1 GPRS 850 Test Result

Applicant : Acer Incorporated
Model No : ZG5
EUT : Notebook PC
Test Mode : GPRS 850 (Low CH128 / Middle CH190 / High CH 251)
Test Date : 08/27/2008

Please refer to next pager of detail testing data.



File :ZG5B C TEST(GSM850GPRS)

Data :#1

Date: 2008/8/27

Time: 下午 07:02:46

80.0 dBuV

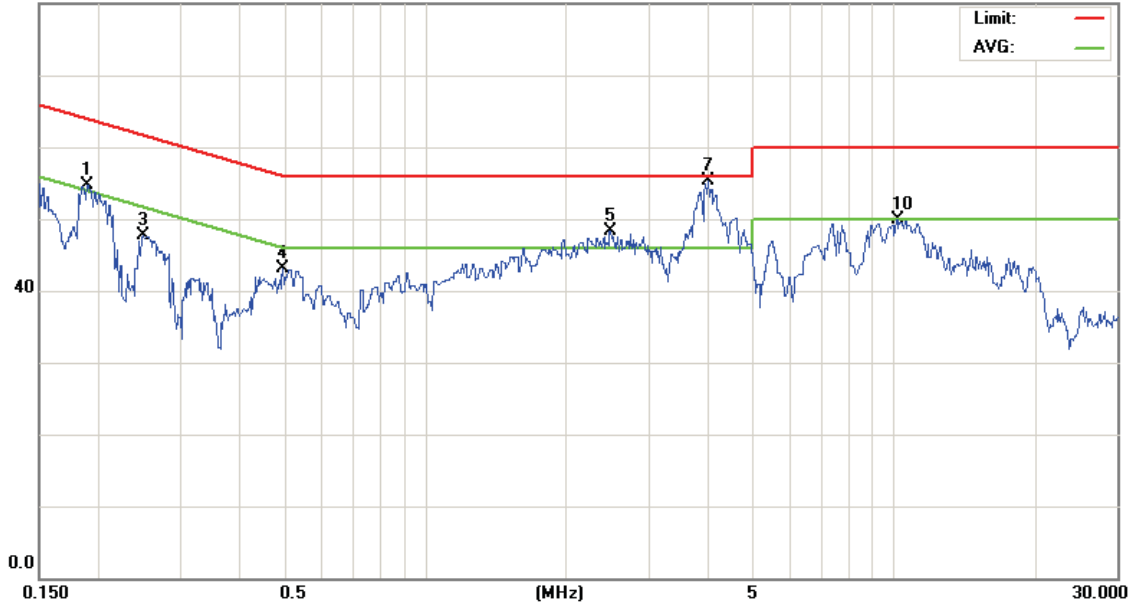

Site site#1

Phase: L1

Temperature: 26 °C

Limit: CISPR22 Class B Conduction(QP)

Power:

Humidity: 55 %

EUT:

M/N: ZG5

Mode: GSM850GPRS

Note: CH128

No.	Mk.	Freq. MHz	Reading Level dBuV	Correct Factor dB	Measure- ment dBuV	Limit dBuV	Over dB	Detector	Comment
1		0.1899	44.98	9.74	54.72	64.04	-9.32	peak	
2		0.1899	22.76	9.74	32.50	54.04	-21.54	AVG	
3		0.2500	37.96	9.75	47.71	61.75	-14.04	peak	
4		0.4964	33.27	9.78	43.05	56.06	-13.01	peak	
5		2.4800	38.40	9.87	48.27	56.00	-7.73	peak	
6		2.4800	22.63	9.87	32.50	46.00	-13.50	AVG	
7	*	4.0100	45.30	9.97	55.27	56.00	-0.73	peak	
8		4.0100	38.33	9.97	48.30	56.00	-7.70	QP	
9		4.0100	26.83	9.97	36.80	46.00	-9.20	AVG	
10		10.1500	39.92	10.07	49.99	60.00	-10.01	peak	
11		10.1500	23.53	10.07	33.60	50.00	-16.40	AVG	

*:Maximum data x:Over limit !:over margin

●Reference Only



File :ZG5B C TEST(GSM850GPRS)

Data :#2

Date: 2008/8/27

Time: 下午 07:18:25

80.0 dBuV



Site site#1

Phase: L2

Temperature: 26 °C

Limit: CISPR22 Class B Conduction(QP)

Power:

Humidity: 55 %

EUT:

M/N: ZG5

Mode: GSM850GPRS

Note: CH128

No.	Mk.	Freq. MHz	Reading Level dBuV	Correct Factor dB	Measure- ment dBuV	Limit dBuV	Over dB	Detector	Comment
1		0.1884	42.21	9.74	51.95	64.10	-12.15	peak	
2		0.1884	23.66	9.74	33.40	54.10	-20.70	AVG	
3		0.2487	35.30	9.75	45.05	61.80	-16.75	peak	
4		0.5630	33.37	9.79	43.16	56.00	-12.84	peak	
5		0.5630	17.81	9.79	27.60	46.00	-18.40	AVG	
6		2.6600	37.78	9.93	47.71	56.00	-8.29	peak	
7		2.6600	22.47	9.93	32.40	46.00	-13.60	AVG	
8	*	3.9560	45.51	9.98	55.49	56.00	-0.51	peak	
9		3.9560	37.82	9.98	47.80	56.00	-8.20	QP	
10		3.9560	26.22	9.98	36.20	46.00	-9.80	AVG	
11		11.2500	42.82	10.11	52.93	60.00	-7.07	peak	
12		11.2500	29.79	10.11	39.90	50.00	-10.10	AVG	

*:Maximum data x:Over limit !:over margin

●Reference Only



File :ZG5B C TEST(GSM850GPRS)

Data :#3

Date: 2008/8/27

Time: 下午 08:03:12

80.0 dBuV

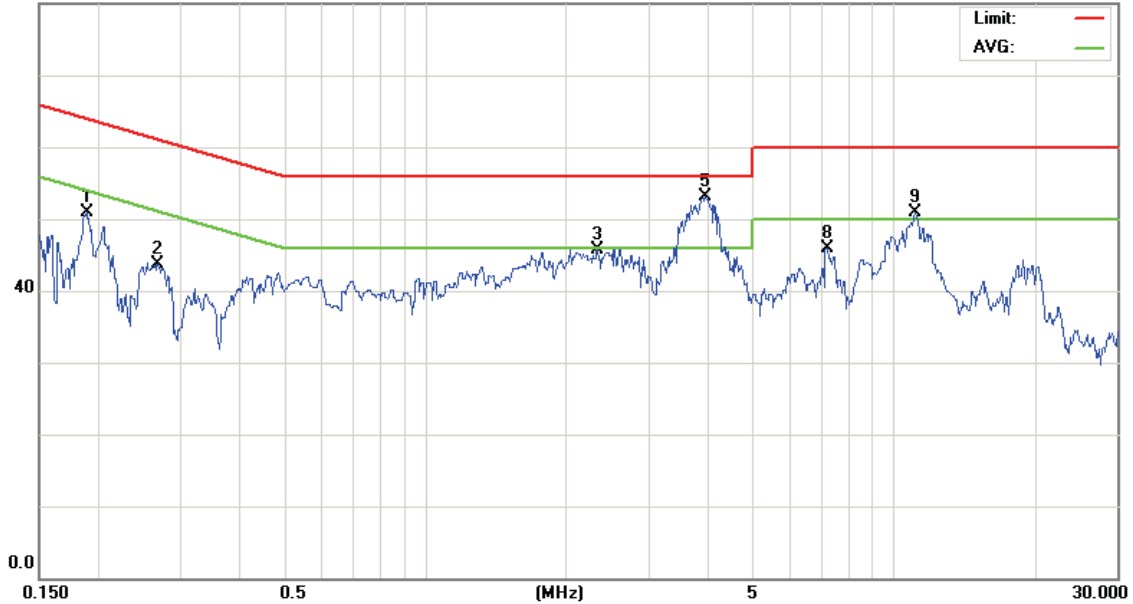

Site site#1

Phase: **L1**

Temperature: 26 °C

Limit: CISPR22 Class B Conduction(QP)

Power:

Humidity: 55 %

EUT:

M/N: ZG5

Mode: GSM850GPRS

Note: CH190

No.	Mk.	Freq. MHz	Reading Level dBuV	Correct Factor dB	Measure- ment dBuV	Limit dBuV	Over dB	Detector	Comment
1		0.1892	41.07	9.74	50.81	64.07	-13.26	peak	
2		0.2676	33.95	9.76	43.71	61.19	-17.48	peak	
3		2.3270	35.92	9.85	45.77	56.00	-10.23	peak	
4		2.3270	21.85	9.85	31.70	46.00	-14.30	AVG	
5	*	3.9560	43.04	9.98	53.02	56.00	-2.98	peak	
6		3.9560	36.12	9.98	46.10	56.00	-9.90	QP	
7		3.9560	24.82	9.98	34.80	46.00	-11.20	AVG	
8		7.2000	35.82	10.09	45.91	60.00	-14.09	peak	
9		11.1000	40.87	10.11	50.98	60.00	-9.02	peak	
10		11.1000	27.19	10.11	37.30	50.00	-12.70	AVG	

*:Maximum data x:Over limit !:over margin

●Reference Only



File :ZG5B C TEST(GSM850GPRS)

Data :#4

Date: 2008/8/27

Time: 下午 08:27:21

80.0 dBuV

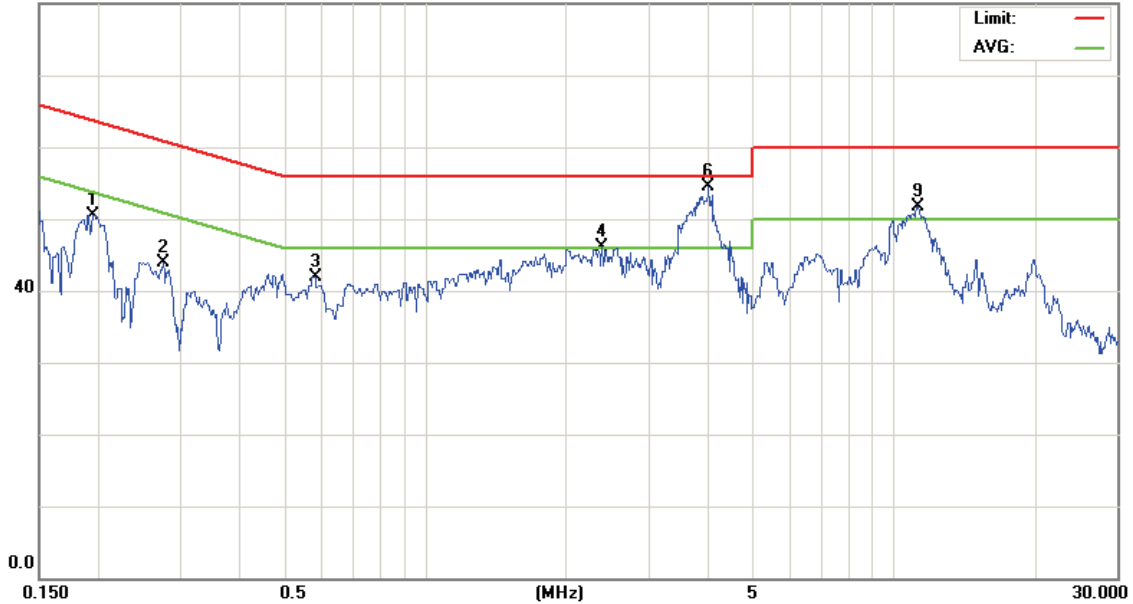

Site site#1

Phase: **L2**

Temperature: 26 °C

Limit: CISPR22 Class B Conduction(QP)

Power:

Humidity: 55 %

EUT:

M/N: ZG5

Mode: GSM850GPRS

Note: CH190

No.	Mk.	Freq. MHz	Reading Level dBuV	Correct Factor dB	Measure- ment dBuV	Limit dBuV	Over dB	Detector	Comment
1		0.1955	40.78	9.74	50.52	63.80	-13.28	peak	
2		0.2753	34.06	9.76	43.82	60.95	-17.13	peak	
3		0.5810	32.05	9.79	41.84	56.00	-14.16	peak	
4		2.3809	36.19	9.84	46.03	56.00	-9.97	peak	
5		2.3809	21.86	9.84	31.70	46.00	-14.30	AVG	
6	*	4.0190	44.49	9.97	54.46	56.00	-1.54	peak	
7		4.0190	36.13	9.97	46.10	56.00	-9.90	QP	
8		4.0190	25.13	9.97	35.10	46.00	-10.90	AVG	
9		11.2000	41.69	10.11	51.80	60.00	-8.20	peak	
10		11.2000	28.09	10.11	38.20	50.00	-11.80	AVG	

*:Maximum data x:Over limit !:over margin

●Reference Only



File :ZG5B C TEST(GSM850GPRS)

Data :#5

Date: 2008/8/27

Time: 下午 08:40:36

80.0 dBuV

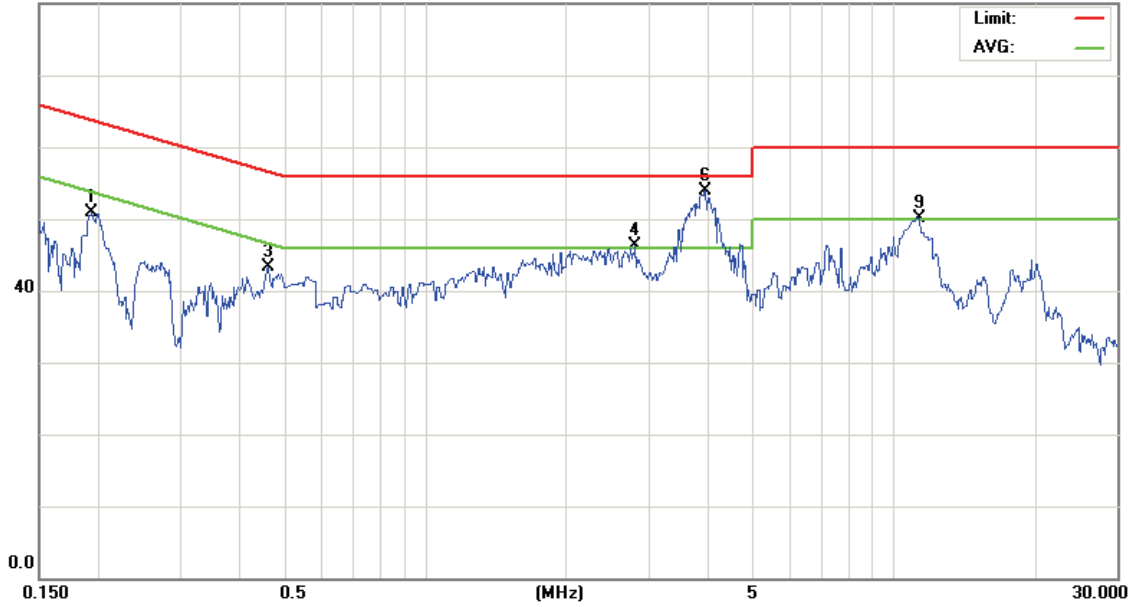

Site site#1

Phase: **L1**

Temperature: 26 °C

Limit: CISPR22 Class B Conduction(QP)

Power:

Humidity: 55 %

EUT:

M/N: ZG5

Mode: GSM850GPRS

Note: CH251

No.	Mk.	Freq. MHz	Reading Level dBuV	Correct Factor dB	Measure- ment dBuV	Limit dBuV	Over dB	Detector	Comment
1		0.1941	41.16	9.74	50.90	63.85	-12.95	peak	
2		0.1941	20.36	9.74	30.10	53.85	-23.75	AVG	
3		0.4615	33.44	9.78	43.22	56.67	-13.45	peak	
4		2.8040	36.34	9.91	46.25	56.00	-9.75	peak	
5		2.8040	18.19	9.91	28.10	46.00	-17.90	AVG	
6	*	3.9470	43.95	9.98	53.93	56.00	-2.07	peak	
7		3.9470	35.92	9.98	45.90	56.00	-10.10	QP	
8		3.9470	24.82	9.98	34.80	46.00	-11.20	AVG	
9		11.3500	40.07	10.12	50.19	60.00	-9.81	peak	
10		11.3500	26.68	10.12	36.80	50.00	-13.20	AVG	

*:Maximum data x:Over limit !:over margin

●Reference Only



File :ZG5B C TEST(GSM850GPRS)

Data :#6

Date: 2008/8/27

Time: 下午 08:54:04

80.0 dBuV

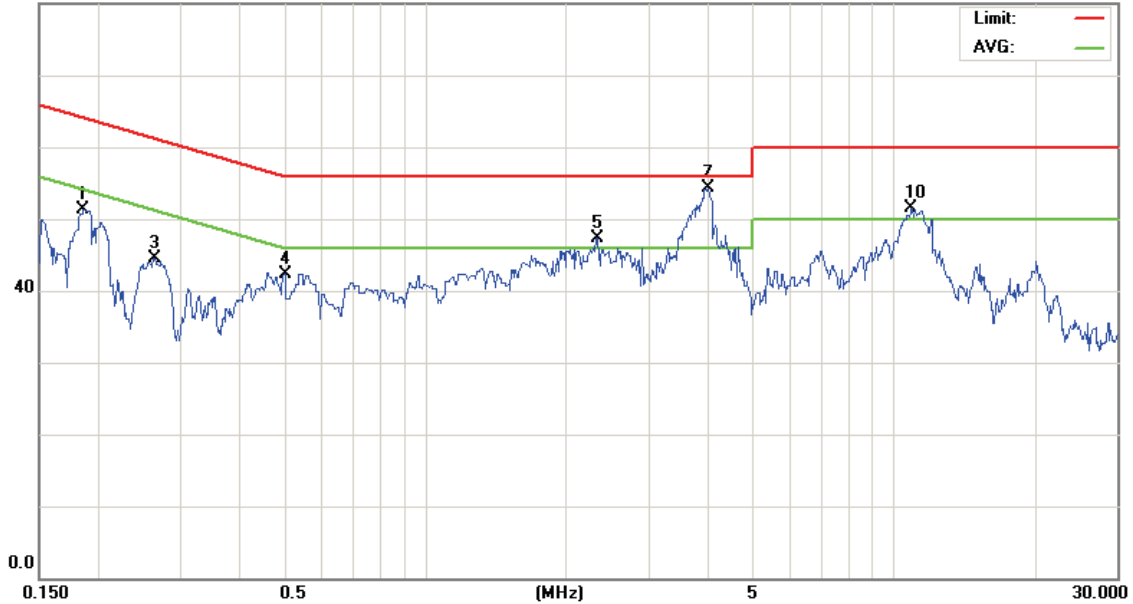

Site site#1

Phase: L2

Temperature: 26 °C

Limit: CISPR22 Class B Conduction(QP)

Power:

Humidity: 55 %

EUT:

M/N: ZG5

Mode: GSM850GPRS

Note: CH251

No.	Mk.	Freq. MHz	Reading Level dBuV	Correct Factor dB	Measure- ment dBuV	Limit dBuV	Over dB	Detector	Comment
1		0.1864	41.54	9.74	51.28	64.19	-12.91	peak	
2		0.1864	22.06	9.74	31.80	54.19	-22.39	AVG	
3		0.2634	34.78	9.75	44.53	61.32	-16.79	peak	
4		0.5000	32.60	9.78	42.38	56.00	-13.62	peak	
5		2.3270	37.41	9.85	47.26	56.00	-8.74	peak	
6		2.3270	21.55	9.85	31.40	46.00	-14.60	AVG	
7	*	4.0100	44.25	9.97	54.22	56.00	-1.78	peak	
8		4.0100	35.93	9.97	45.90	56.00	-10.10	QP	
9		4.0100	24.93	9.97	34.90	46.00	-11.10	AVG	
10		10.9000	41.46	10.09	51.55	60.00	-8.45	peak	
11		10.9000	29.21	10.09	39.30	50.00	-10.70	AVG	

*:Maximum data x:Over limit !:over margin

●Reference Only



4.9.6.2 GPRS 1900 Test Result

Applicant : Acer Incorporated

Model No : ZG5

EUT : Notebook PC

Test Mode : GPRS 1900 (Low CH512 / Middle CH661 / High CH 810)

Test Date : 08/27/2008

Please refer to next pager of detail testing data.



File :ZG5B C TEST(PCS1900GPRS) Data :#1

Date: 2008/8/27

Time: 下午 09:09:21

80.0 dBuV

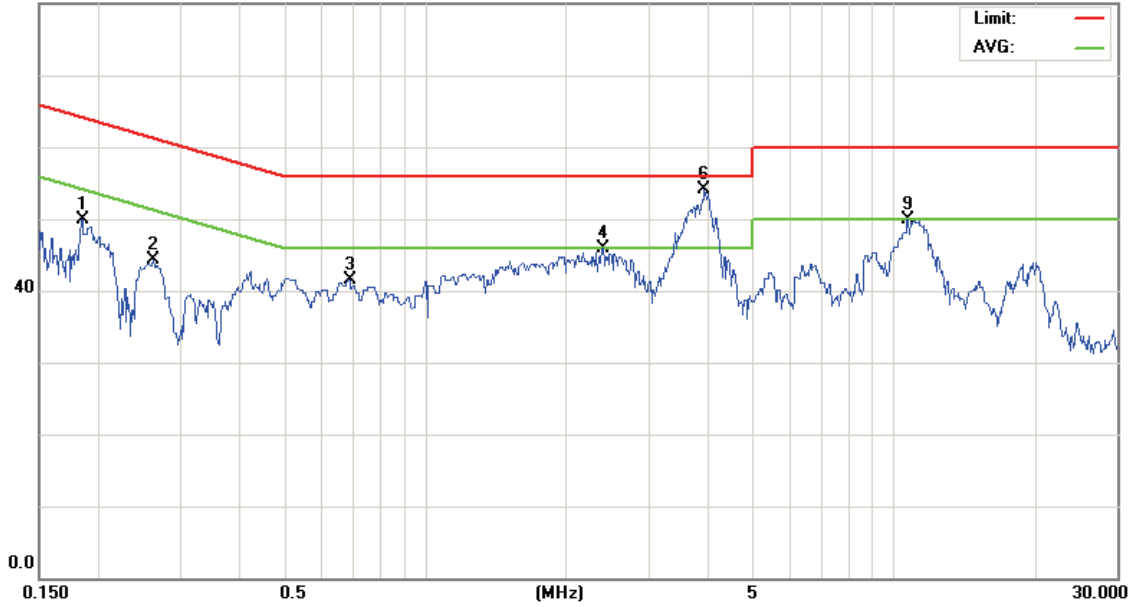

Site site#1

Phase: L1

Temperature: 26 °C

Limit: CISPR22 Class B Conduction(QP)

Power:

Humidity: 55 %

EUT:

M/N: ZG5

Mode: PCS1900GPRS

Note: CH512

No.	Mk.	Freq. MHz	Reading Level dBuV	Correct Factor dB	Measure- ment dBuV	Limit dBuV	Over dB	Detector	Comment
1		0.1850	40.07	9.74	49.81	64.25	-14.44	peak	
2		0.2627	34.50	9.75	44.25	61.34	-17.09	peak	
3		0.6889	31.66	9.79	41.45	56.00	-14.55	peak	
4		2.3900	35.98	9.84	45.82	56.00	-10.18	peak	
5		2.3900	21.66	9.84	31.50	46.00	-14.50	AVG	
6	*	3.9380	44.06	9.98	54.04	56.00	-1.96	peak	
7		3.9380	36.52	9.98	46.50	56.00	-9.50	QP	
8		3.9380	24.62	9.98	34.60	46.00	-11.40	AVG	
9		10.7000	39.85	10.06	49.91	60.00	-10.09	peak	
10		10.7000	27.74	10.06	37.80	50.00	-12.20	AVG	

*:Maximum data x:Over limit !:over margin

●Reference Only



File :ZG5B C TEST(PCS1900GPRS) Data :#2

Date: 2008/8/27

Time: 下午 09:18:05

80.0 dBuV

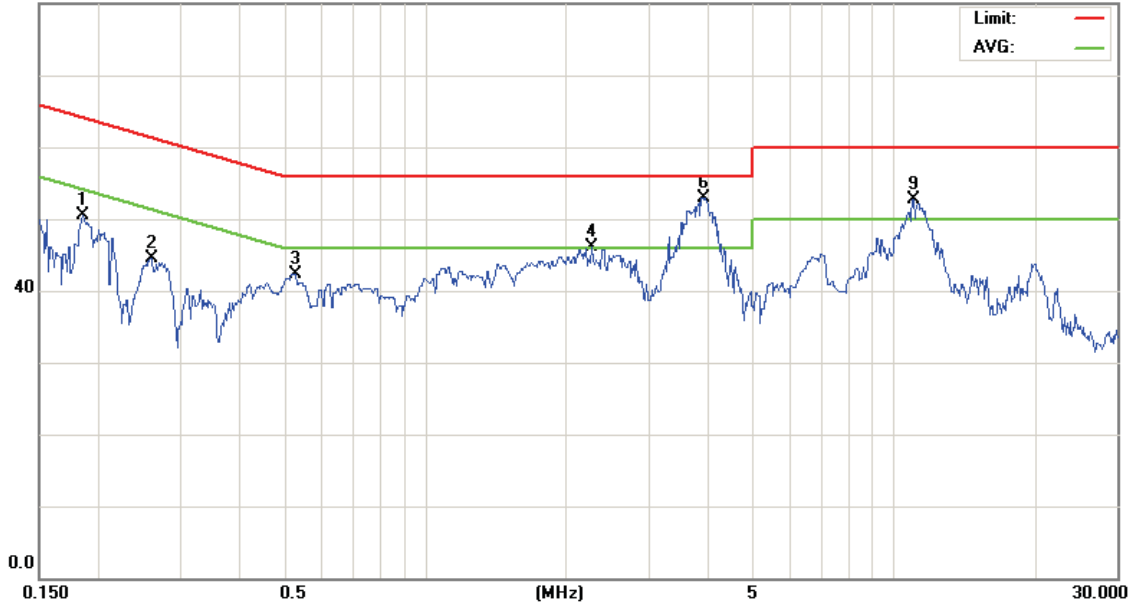

Site site#1

Phase: L2

Temperature: 26 °C

Limit: CISPR22 Class B Conduction(QP)

Power:

Humidity: 55 %

EUT:

M/N: ZG5

Mode: PCS1900GPRS

Note: CH512

No.	Mk.	Freq. MHz	Reading Level dBuV	Correct Factor dB	Measure- ment dBuV	Limit dBuV	Over dB	Detector	Comment
1		0.1857	40.80	9.74	50.54	64.22	-13.68	peak	
2		0.2592	34.71	9.75	44.46	61.45	-16.99	peak	
3		0.5270	32.52	9.79	42.31	56.00	-13.69	peak	
4		2.2640	36.28	9.87	46.15	56.00	-9.85	peak	
5		2.2640	21.53	9.87	31.40	46.00	-14.60	AVG	
6	*	3.9020	43.02	9.97	52.99	56.00	-3.01	peak	
7		3.9020	36.33	9.97	46.30	56.00	-9.70	QP	
8		3.9020	25.13	9.97	35.10	46.00	-10.90	AVG	
9		11.0000	42.51	10.10	52.61	60.00	-7.39	peak	
10		11.0000	29.00	10.10	39.10	50.00	-10.90	AVG	

*:Maximum data x:Over limit !:over margin

●Reference Only



File :ZG5B C TEST(PCS1900GPRS) Data :#3

Date: 2008/8/27

Time: 下午 09:26:07

80.0 dBuV

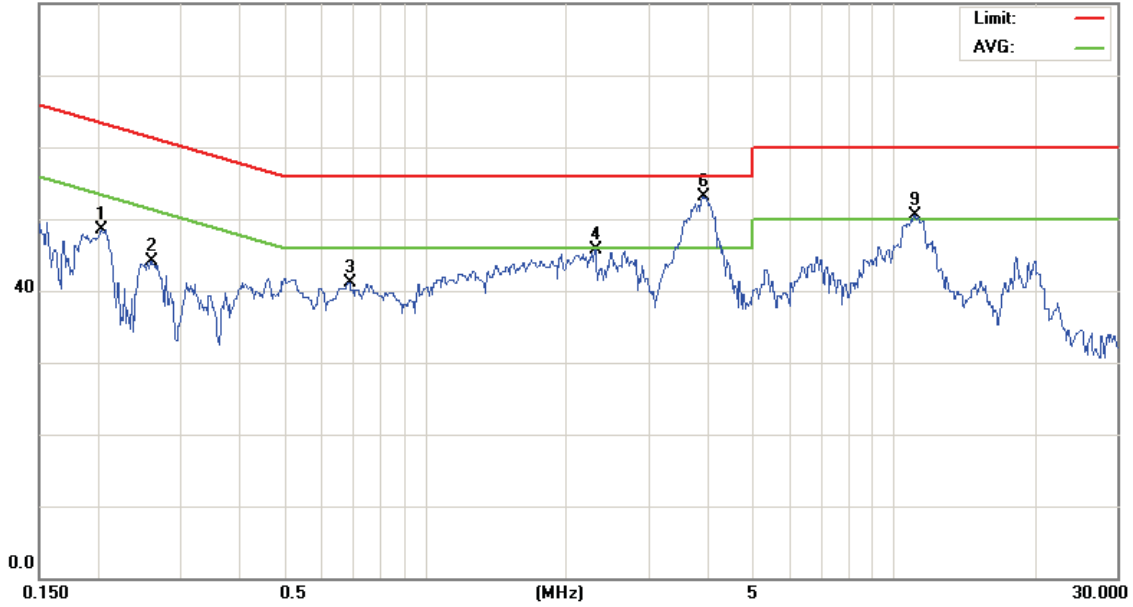

Site site#1

Phase: L1

Temperature: 26 °C

Limit: CISPR22 Class B Conduction(QP)

Power:

Humidity: 55 %

EUT:

M/N: ZG5

Mode: PCS1900GPRS

Note: CH661

No.	Mk.	Freq. MHz	Reading Level dBuV	Correct Factor dB	Measure- ment dBuV	Limit dBuV	Over dB	Detector	Comment
1		0.2039	38.80	9.74	48.54	63.45	-14.91	peak	
2		0.2592	34.33	9.75	44.08	61.45	-17.37	peak	
3		0.6889	31.39	9.79	41.18	56.00	-14.82	peak	
4		2.3000	35.84	9.86	45.70	56.00	-10.30	peak	
5		2.3000	21.64	9.86	31.50	46.00	-14.50	AVG	
6	*	3.9020	43.04	9.97	53.01	56.00	-2.99	peak	
7		3.9020	36.33	9.97	46.30	56.00	-9.70	QP	
8		3.9020	25.03	9.97	35.00	46.00	-11.00	AVG	
9		11.0500	40.48	10.11	50.59	60.00	-9.41	peak	
10		11.0500	27.69	10.11	37.80	50.00	-12.20	AVG	

*:Maximum data x:Over limit !:over margin

●Reference Only



File :ZG5B C TEST(PCS1900GPRS) Data :#4

Date: 2008/8/27

Time: 下午 09:41:12

80.0 dBuV

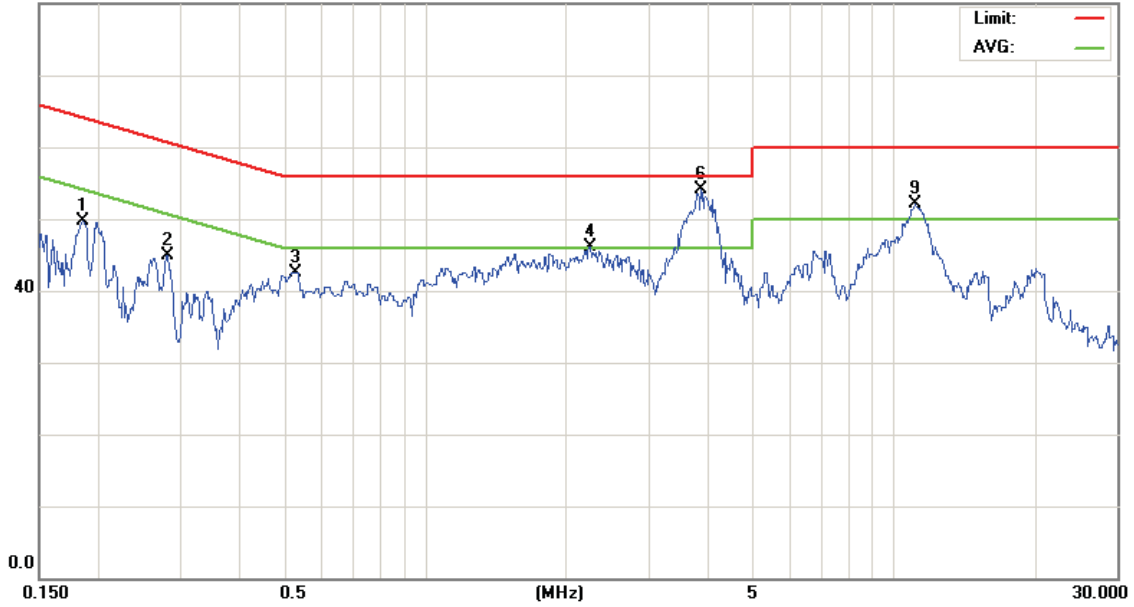

Site site#1

Phase: **L2**

Temperature: 26 °C

Limit: CISPR22 Class B Conduction(QP)

Power:

Humidity: 55 %

EUT:

M/N: ZG5

Mode: PCS1900GPRS

Note: CH661

No.	Mk.	Freq.	Reading Level	Correct Factor	Measurement	Limit	Over	Detector	Comment
		MHz	dBuV	dB	dBuV	dBuV	dB		
1		0.1857	39.97	9.74	49.71	64.22	-14.51	peak	
2		0.2809	35.20	9.76	44.96	60.79	-15.83	peak	
3		0.5270	32.79	9.79	42.58	56.00	-13.42	peak	
4		2.2370	36.23	9.88	46.11	56.00	-9.89	peak	
5		2.2370	21.62	9.88	31.50	46.00	-14.50	AVG	
6	*	3.8750	44.12	9.96	54.08	56.00	-1.92	peak	
7		3.8750	36.34	9.96	46.30	56.00	-9.70	QP	
8		3.8750	25.14	9.96	35.10	46.00	-10.90	AVG	
9		11.1000	41.95	10.11	52.06	60.00	-7.94	peak	
10		11.1000	28.59	10.11	38.70	50.00	-11.30	AVG	

*:Maximum data x:Over limit !:over margin

●Reference Only



File :ZG5B C TEST(PCS1900GPRS) Data :#5

Date: 2008/8/27

Time: 下午 09:59:24

80.0 dBuV

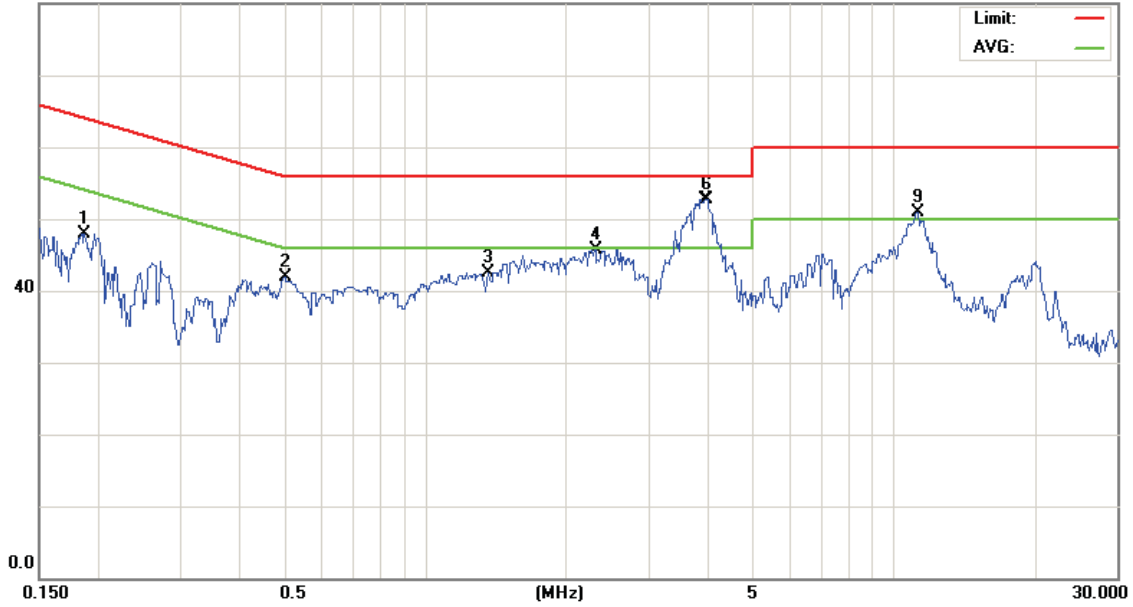

Site site#1

Phase: **L1**

Temperature: 26 °C

Limit: CISPR22 Class B Conduction(QP)

Power:

Humidity: 55 %

EUT:

M/N: ZG5

Mode: PCS1900GPRS

Note: CH810

No.	Mk.	Freq. MHz	Reading Level dBuV	Correct Factor dB	Measure- ment dBuV	Limit dBuV	Over dB	Detector	Comment
1		0.1870	38.13	9.74	47.87	64.16	-16.29	peak	
2		0.5000	32.13	9.78	41.91	56.00	-14.09	peak	
3		1.3640	32.69	9.82	42.51	56.00	-13.49	peak	
4		2.3000	35.77	9.86	45.63	56.00	-10.37	peak	
5		2.3000	21.64	9.86	31.50	46.00	-14.50	AVG	
6	*	3.9650	42.81	9.98	52.79	56.00	-3.21	peak	
7		3.9650	36.42	9.98	46.40	56.00	-9.60	QP	
8		3.9650	25.02	9.98	35.00	46.00	-11.00	AVG	
9		11.2000	40.78	10.11	50.89	60.00	-9.11	peak	
10		11.2000	26.79	10.11	36.90	50.00	-13.10	AVG	

*:Maximum data x:Over limit !:over margin

●Reference Only



File :ZG5B C TEST(PCS1900GPRS) Data :#6

Date: 2008/8/27

Time: 下午 10:06:18

80.0 dBuV

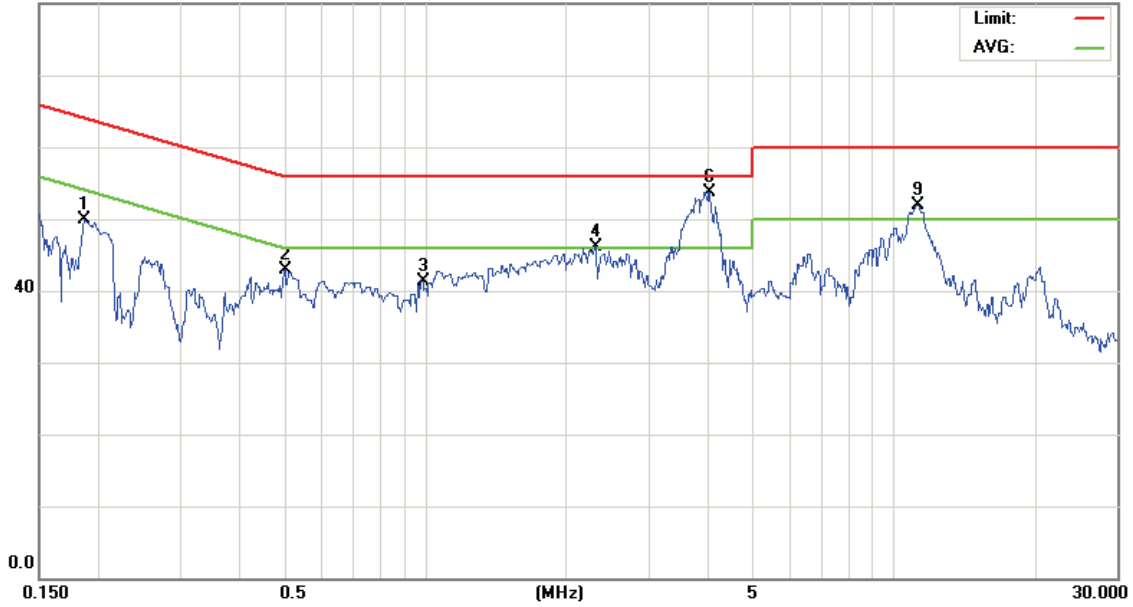

Site site#1

Phase: **L2**

Temperature: 26 °C

Limit: CISPR22 Class B Conduction(QP)

Power:

Humidity: 55 %

EUT:

M/N: ZG5

Mode: PCS1900GPRS

Note: CH810

No.	Mk.	Freq. MHz	Reading Level dBuV	Correct Factor dB	Measure- ment dBuV	Limit dBuV	Over dB	Detector	Comment
1		0.1870	40.15	9.74	49.89	64.16	-14.27	peak	
2		0.5000	33.06	9.78	42.84	56.00	-13.16	peak	
3		0.9860	31.41	9.81	41.22	56.00	-14.78	peak	
4		2.3000	36.28	9.86	46.14	56.00	-9.86	peak	
5		2.3000	21.84	9.86	31.70	46.00	-14.30	AVG	
6	*	4.0280	43.69	9.96	53.65	56.00	-2.35	peak	
7		4.0280	36.44	9.96	46.40	56.00	-9.60	QP	
8		4.0280	25.24	9.96	35.20	46.00	-10.80	AVG	
9		11.2000	41.88	10.11	51.99	60.00	-8.01	peak	
10		11.2000	28.19	10.11	38.30	50.00	-11.70	AVG	

*:Maximum data x:Over limit !:over margin

●Reference Only



4.9.6.3 WCDMA Band V Test Result

Applicant : Acer Incorporated
Model No : ZG5
EUT : Notebook PC
Test Mode : WCDMA Band V (Low CH4132 / Middle CH4182 / High CH 4233)
Test Date : 08/21~22/2008

Please refer to next pager of detail testing data.



File :ZG5B C TEST(WCDMA)

Data :#1

Date: 2008/8/21

Time:

80.0 dBuV

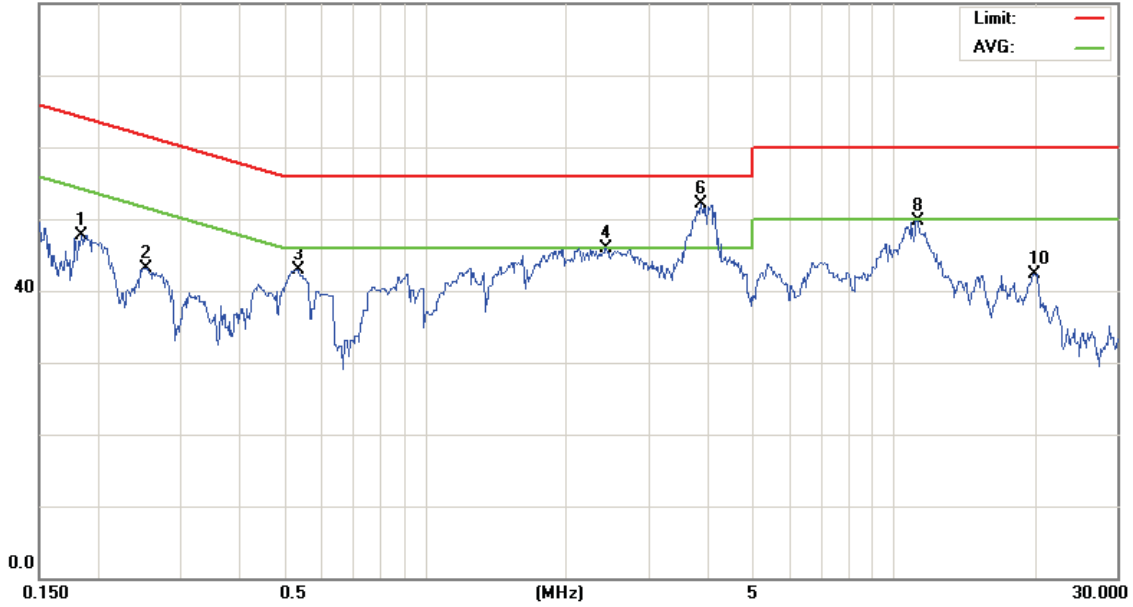

Site site#1

Phase: **L1**

Temperature: 26 °C

Limit: CISPR22 Class B Conduction(QP)

Power:

Humidity: 55 %

EUT:

M/N: ZG5

Mode: WCDMA

Note: CH4132

No.	Mk.	Freq. MHz	Reading Level dBuV	Correct Factor dB	Measure- ment dBuV	Limit dBuV	Over dB	Detector	Comment
1		0.1842	38.04	9.74	47.78	64.29	-16.51	peak	
2		0.2529	33.39	9.75	43.14	61.66	-18.52	peak	
3		0.5360	33.02	9.79	42.81	56.00	-13.19	peak	
4		2.4258	36.14	9.84	45.98	56.00	-10.02	peak	
5		2.4258	24.85	9.84	34.69	46.00	-11.31	AVG	
6	*	3.8748	42.13	9.96	52.09	56.00	-3.91	peak	
7		3.8748	25.95	9.96	35.91	46.00	-10.09	AVG	
8		11.2000	39.64	10.11	49.75	60.00	-10.25	peak	
9		11.2000	28.51	10.11	38.62	50.00	-11.38	AVG	
10		19.8500	32.13	10.24	42.37	60.00	-17.63	peak	

*:Maximum data x:Over limit !:over margin

●Reference Only



File :ZG5B C TEST(WCDMA)

Data :#2

Date: 2008/8/21

Time:

80.0 dBuV

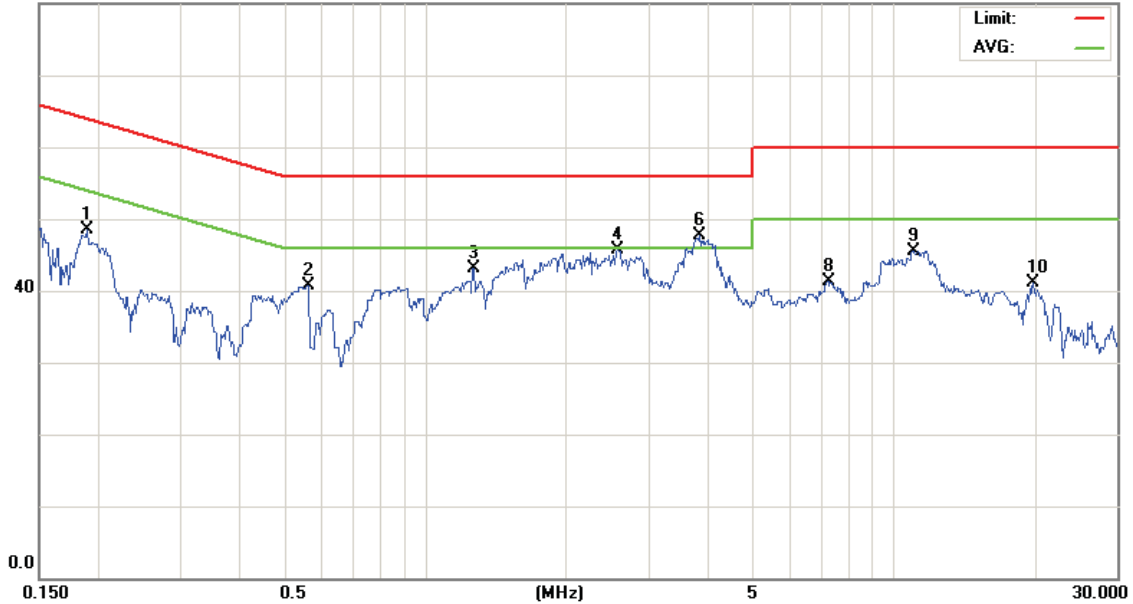

Site site#1

Phase: **L2**

Temperature: 26 °C

Limit: CISPR22 Class B Conduction(QP)

Power:

Humidity: 55 %

EUT:

M/N: ZG5

Mode: WCDMA

Note: CH4132

No.	Mk.	Freq. MHz	Reading Level dBuV	Correct Factor dB	Measure- ment dBuV	Limit dBuV	Over dB	Detector	Comment
1		0.1900	38.71	9.74	48.45	64.03	-15.58	peak	
2		0.5627	30.90	9.79	40.69	56.00	-15.31	peak	
3		1.2646	33.28	9.81	43.09	56.00	-12.91	peak	
4		2.5700	35.80	9.93	45.73	56.00	-10.27	peak	
5		2.5700	22.85	9.93	32.78	46.00	-13.22	AVG	
6	*	3.8567	37.70	9.95	47.65	56.00	-8.35	peak	
7		3.8567	24.39	9.95	34.34	46.00	-11.66	AVG	
8		7.2500	31.16	10.09	41.25	60.00	-18.75	peak	
9		11.0000	35.48	10.10	45.58	60.00	-14.42	peak	
10		19.8000	30.84	10.25	41.09	60.00	-18.91	peak	

*:Maximum data x:Over limit !:over margin

●Reference Only



File :ZG5B C TEST(WCDMA)

Data :#3

Date: 2008/8/21

Time:

80.0 dBuV

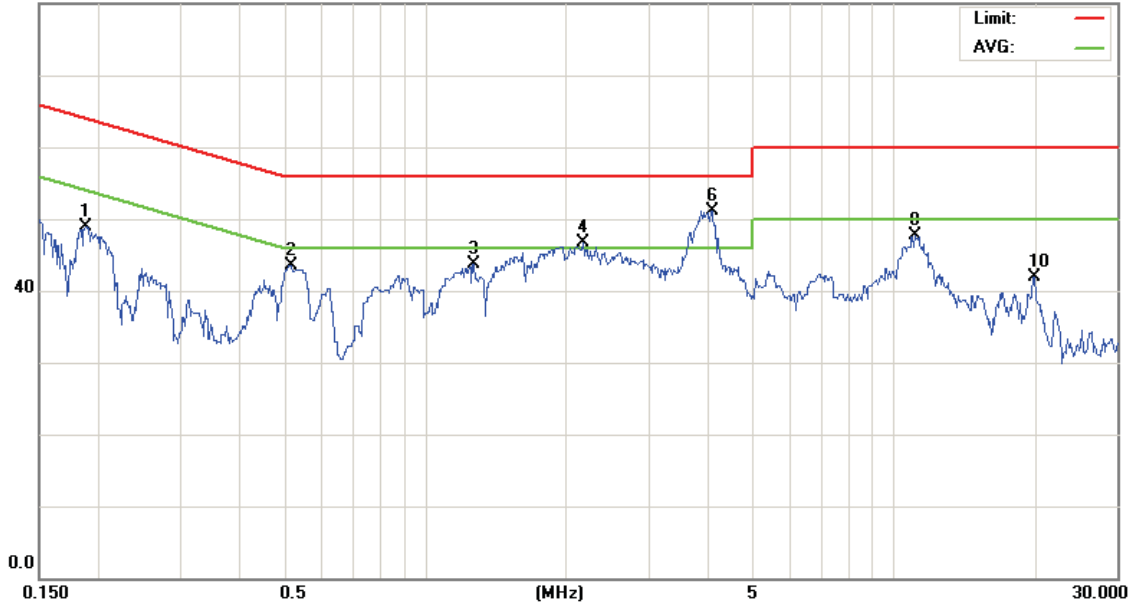

Site site#1

Phase: L1

Temperature: 26 °C

Limit: CISPR22 Class B Conduction(QP)

Power:

Humidity: 55 %

EUT:

M/N: ZG5

Mode: WCDMA

Note: CH4182

No.	Mk.	Freq. MHz	Reading Level dBuV	Correct Factor dB	Measure- ment dBuV	Limit dBuV	Over dB	Detector	Comment
1		0.1884	39.16	9.74	48.90	64.10	-15.20	peak	
2		0.5180	33.72	9.79	43.51	56.00	-12.49	peak	
3		1.2647	33.80	9.81	43.61	56.00	-12.39	peak	
4		2.1739	36.77	9.88	46.65	56.00	-9.35	peak	
5		2.1739	25.91	9.88	35.79	46.00	-10.21	AVG	
6	*	4.0819	41.20	9.96	51.16	56.00	-4.84	peak	
7		4.0819	24.86	9.96	34.82	46.00	-11.18	AVG	
8		11.1000	37.57	10.11	47.68	60.00	-12.32	peak	
9		11.1000	27.43	10.11	37.54	50.00	-12.46	AVG	
10		19.8500	31.61	10.24	41.85	60.00	-18.15	peak	

*:Maximum data x:Over limit !:over margin

●Reference Only



File :ZG5B C TEST(WCDMA)

Data :#4

Date: 2008/8/21

Time:

80.0 dBuV

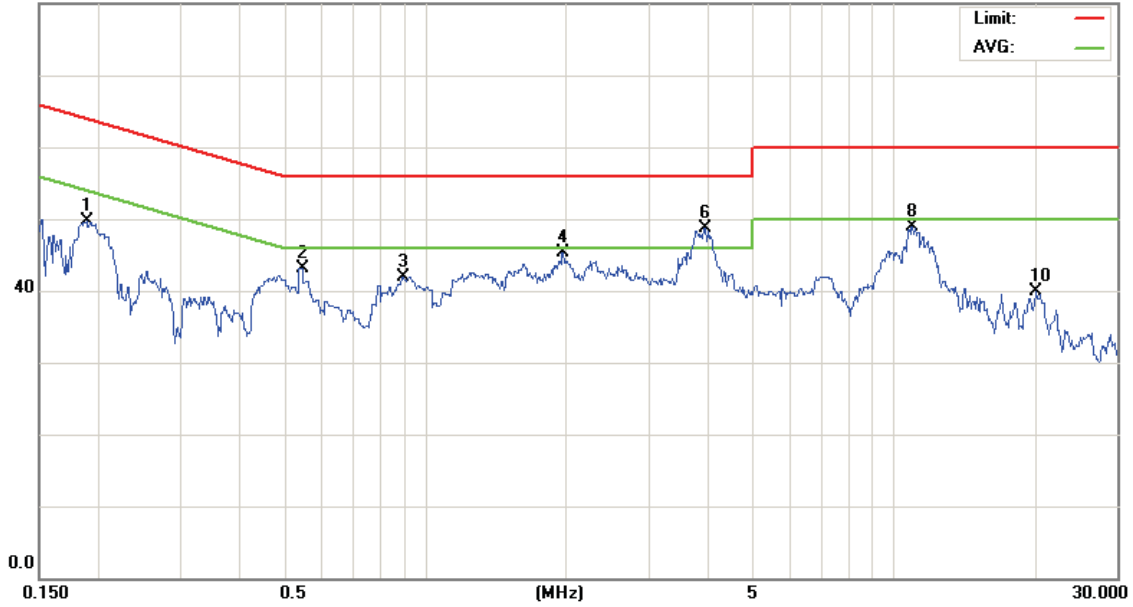

Site site#1

Phase: **L2**

Temperature: 26 °C

Limit: CISPR22 Class B Conduction(QP)

Power:

Humidity: 55 %

EUT:

M/N: ZG5

Mode: WCDMA

Note: CH4182

No.	Mk.	Freq. MHz	Reading Level dBuV	Correct Factor dB	Measure- ment dBuV	Limit dBuV	Over dB	Detector	Comment
1		0.1892	40.05	9.74	49.79	64.07	-14.28	peak	
2		0.5450	33.33	9.79	43.12	56.00	-12.88	peak	
3		0.8960	32.05	9.80	41.85	56.00	-14.15	peak	
4		1.9669	35.41	9.84	45.25	56.00	-10.75	peak	
5		1.9669	24.47	9.84	34.31	46.00	-11.69	AVG	
6	*	3.9468	38.63	9.98	48.61	56.00	-7.39	peak	
7		3.9468	23.71	9.98	33.69	46.00	-12.31	AVG	
8		10.9500	38.90	10.10	49.00	60.00	-11.00	peak	
9		10.9500	28.66	10.10	38.76	50.00	-11.24	AVG	
10		20.1000	29.58	10.24	39.82	60.00	-20.18	peak	

*:Maximum data x:Over limit !:over margin

●Reference Only



File :ZG5B C TEST(WCDMA)

Data :#5

Date: 2008/8/22

Time:

80.0 dBuV

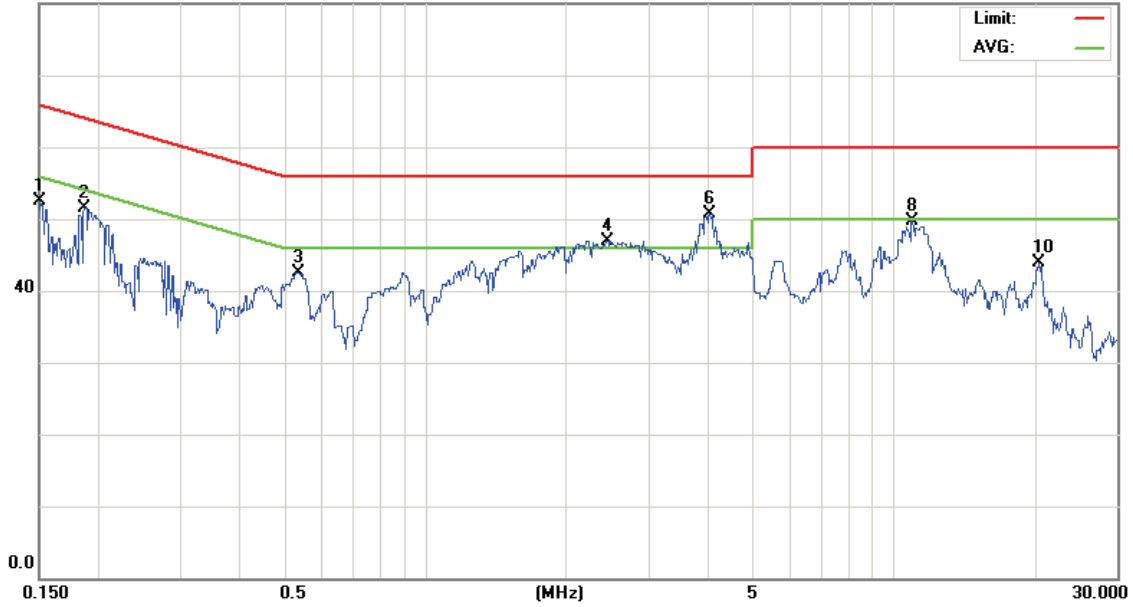

Site site#1 Phase: **L1** Temperature: 26 °C
 Limit: CISPR22 Class B Conduction(QP) Power: Humidity: 55 %
 EUT:
 M/N: ZG5
 Mode: WCDMA
 Note: CH4233

No.	Mk.	Freq. MHz	Reading Level dBuV	Correct Factor dB	Measure- ment dBuV	Limit dBuV	Over dB	Detector	Comment
1		0.1507	42.78	9.73	52.51	65.96	-13.45	peak	
2		0.1869	41.85	9.74	51.59	64.17	-12.58	peak	
3		0.5360	32.66	9.79	42.45	56.00	-13.55	peak	
4		2.4348	37.14	9.84	46.98	56.00	-9.02	peak	
5		2.4348	23.28	9.84	33.12	46.00	-12.88	AVG	
6	*	4.0457	40.71	9.96	50.67	56.00	-5.33	peak	
7		4.0457	24.85	9.96	34.81	46.00	-11.19	AVG	
8		10.9500	39.67	10.10	49.77	60.00	-10.23	peak	
9		10.9500	25.69	10.10	35.79	50.00	-14.21	AVG	
10		20.3500	33.60	10.36	43.96	60.00	-16.04	peak	

*:Maximum data x:Over limit !:over margin

●Reference Only



File :ZG5B C TEST(WCDMA)

Data :#6

Date: 2008/8/22

Time:

80.0 dBuV

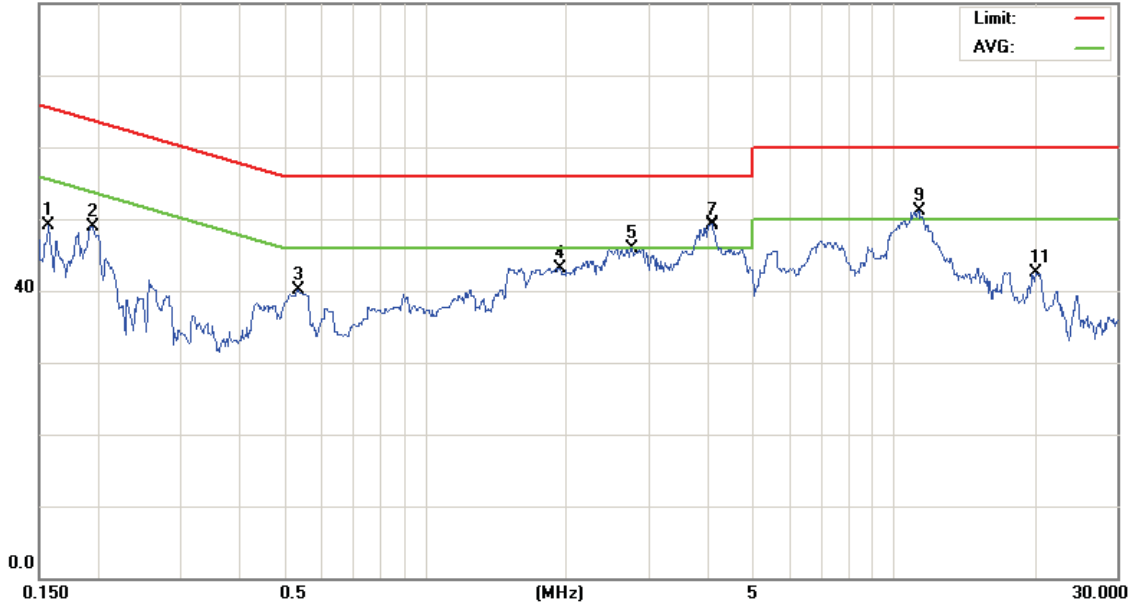

Site site#1

Phase: L2

Temperature: 26 °C

Limit: CISPR22 Class B Conduction(QP)

Power:

Humidity: 55 %

EUT:

M/N: ZG5

Mode: WCDMA

Note: CH4233

No.	Mk.	Freq. MHz	Reading Level dBuV	Correct Factor dB	Measure- ment dBuV	Limit dBuV	Over dB	Detector	Comment
1		0.1570	39.44	9.73	49.17	65.62	-16.45	peak	
2		0.1948	39.13	9.74	48.87	63.83	-14.96	peak	
3		0.5360	30.32	9.79	40.11	56.00	-15.89	peak	
4		1.9309	33.29	9.84	43.13	56.00	-12.87	peak	
5		2.7589	36.00	9.90	45.90	56.00	-10.10	peak	
6		2.7589	24.48	9.90	34.38	46.00	-11.62	AVG	
7	*	4.0727	39.24	9.96	49.20	56.00	-6.80	peak	
8		4.0727	25.23	9.96	35.19	46.00	-10.81	AVG	
9		11.3000	41.08	10.11	51.19	60.00	-8.81	peak	
10		11.3000	23.62	10.11	33.73	50.00	-16.27	AVG	
11		20.0000	32.26	10.23	42.49	60.00	-17.51	peak	

*:Maximum data x:Over limit !:over margin

●Reference Only



4.9.6.4 WCDMA Band II Test Result

Applicant : Acer Incorporated

Model No : ZG5

EUT : Notebook PC

Test Mode : WCDMA Band II (Low CH9262 / Middle CH9400 / High CH 9536)

Test Date : 08/21~22/2008

Please refer to next pager of detail testing data.



File :ZG5B C TEST(WCDMA)

Data :#1

Date: 2008/8/21

Time:

80.0 dBuV

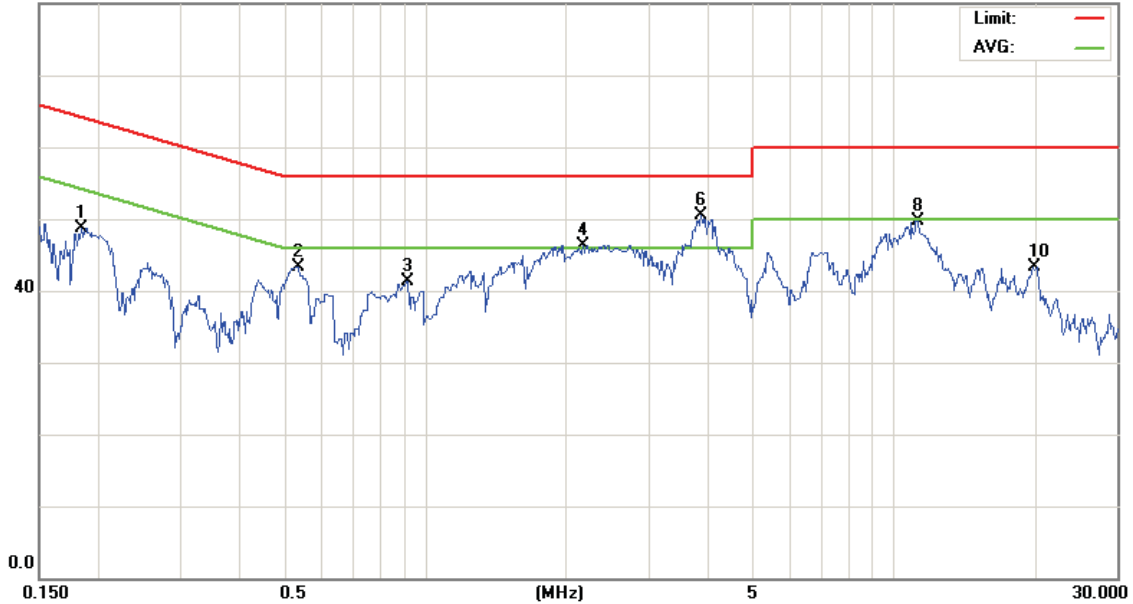

Site site#1

Phase: **L1**

Temperature: 26 °C

Limit: CISPR22 Class B Conduction(QP)

Power:

Humidity: 55 %

EUT:

M/N: ZG5

Mode: WCDMA

Note: CH9262

No.	Mk.	Freq. MHz	Reading Level dBuV	Correct Factor dB	Measure- ment dBuV	Limit dBuV	Over dB	Detector	Comment
1		0.1842	39.04	9.74	48.78	64.29	-15.51	peak	
2		0.5360	33.52	9.79	43.31	56.00	-12.69	peak	
3		0.9140	31.52	9.81	41.33	56.00	-14.67	peak	
4		2.1739	36.47	9.88	46.35	56.00	-9.65	peak	
5		2.1739	20.78	9.88	30.66	46.00	-15.34	AVG	
6	*	3.8748	40.63	9.96	50.59	56.00	-5.41	peak	
7		3.8748	22.75	9.96	32.71	46.00	-13.29	AVG	
8		11.2000	39.64	10.11	49.75	60.00	-10.25	peak	
9		11.2000	22.73	10.11	32.84	50.00	-17.16	AVG	
10		19.8500	33.13	10.24	43.37	60.00	-16.63	peak	

*:Maximum data x:Over limit !:over margin

●Reference Only



File :ZG5B C TEST(WCDMA)

Data :#2

Date: 2008/8/21

Time:

80.0 dBuV

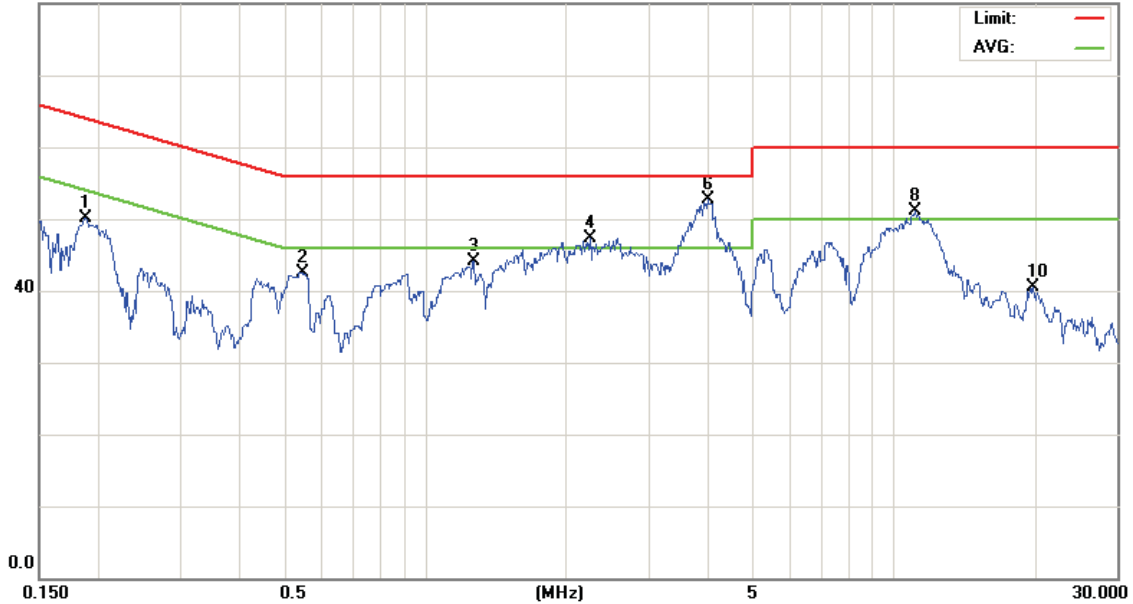

Site site#1

Phase: **L2**

Temperature: 26 °C

Limit: CISPR22 Class B Conduction(QP)

Power:

Humidity: 55 %

EUT:

M/N: ZG5

Mode: WCDMA

Note: CH9262

No.	Mk.	Freq. MHz	Reading Level dBuV	Correct Factor dB	Measure- ment dBuV	Limit dBuV	Over dB	Detector	Comment
1		0.1877	40.31	9.74	50.05	64.13	-14.08	peak	
2		0.5450	32.66	9.79	42.45	56.00	-13.55	peak	
3		1.2646	34.28	9.81	44.09	56.00	-11.91	peak	
4		2.2458	37.41	9.88	47.29	56.00	-8.71	peak	
5		2.2458	24.30	9.88	34.18	46.00	-11.82	AVG	
6	*	4.0007	42.68	9.97	52.65	56.00	-3.35	peak	
7		4.0007	22.69	9.97	32.66	46.00	-13.34	AVG	
8		11.1000	41.05	10.11	51.16	60.00	-8.84	peak	
9		11.1000	26.48	10.11	36.59	50.00	-13.41	AVG	
10		19.8000	30.34	10.25	40.59	60.00	-19.41	peak	

*:Maximum data x:Over limit !:over margin

●Reference Only



File :ZG5B C TEST(WCDMA)

Data :#3

Date: 2008/8/21

Time:

80.0 dBuV

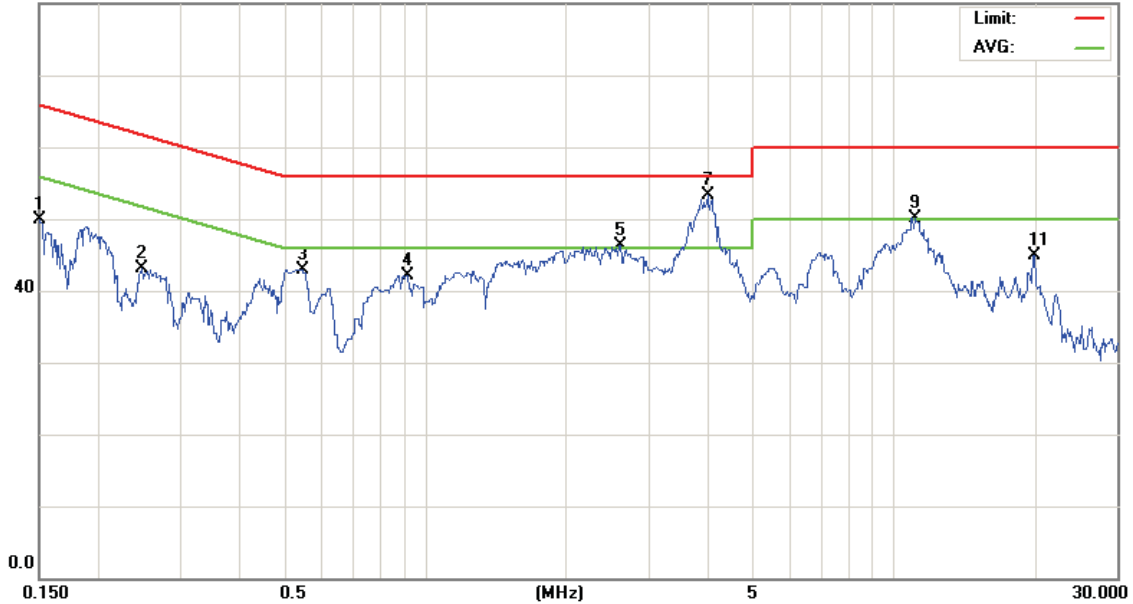

Site site#1

Phase: **L1**

Temperature: 26 °C

Limit: CISPR22 Class B Conduction(QP)

Power:

Humidity: 55 %

EUT:

M/N: ZG5

Mode: WCDMA

Note: CH9400

No.	Mk.	Freq. MHz	Reading Level dBuV	Correct Factor dB	Measure- ment dBuV	Limit dBuV	Over dB	Detector	Comment
1		0.1500	40.24	9.73	49.97	65.99	-16.02	peak	
2		0.2479	33.27	9.75	43.02	61.82	-18.80	peak	
3		0.5450	33.14	9.79	42.93	56.00	-13.07	peak	
4		0.9140	32.32	9.81	42.13	56.00	-13.87	peak	
5		2.5969	36.30	9.93	46.23	56.00	-9.77	peak	
6		2.5969	22.39	9.93	32.32	46.00	-13.68	AVG	
7	*	4.0007	43.37	9.97	53.34	56.00	-2.66	peak	
8		4.0007	24.18	9.97	34.15	46.00	-11.85	AVG	
9		11.1000	40.07	10.11	50.18	60.00	-9.82	peak	
10		11.1000	27.85	10.11	37.96	50.00	-12.04	AVG	
11		19.8500	34.61	10.24	44.85	60.00	-15.15	peak	

*:Maximum data x:Over limit !:over margin

●Reference Only



File :ZG5B C TEST(WCDMA)

Data :#4

Date: 2008/8/21

Time:

80.0 dBuV

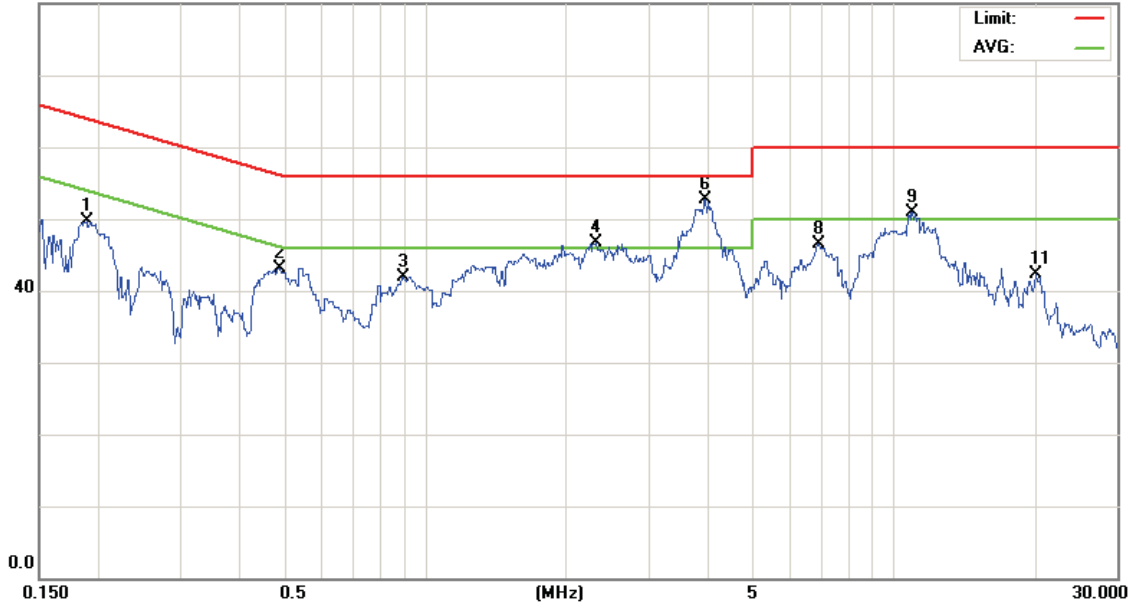

Site site#1

Phase: L2

Temperature: 26 °C

Limit: CISPR22 Class B Conduction(QP)

Power:

Humidity: 55 %

EUT:

M/N: ZG5

Mode: WCDMA

Note: CH9400

No.	Mk.	Freq.	Reading Level	Correct Factor	Measurement	Limit	Over	Detector	Comment
		MHz	dBuV	dB	dBuV	dBuV	dB		
1		0.1892	40.05	9.74	49.79	64.07	-14.28	peak	
2		0.4873	33.40	9.78	43.18	56.21	-13.03	peak	
3		0.8960	32.05	9.80	41.85	56.00	-14.15	peak	
4		2.3178	36.78	9.85	46.63	56.00	-9.37	peak	
5		2.3178	24.31	9.85	34.16	46.00	-11.84	AVG	
6	*	3.9468	42.63	9.98	52.61	56.00	-3.39	peak	
7		3.9468	23.61	9.98	33.59	46.00	-12.41	AVG	
8		6.9000	36.47	10.09	46.56	60.00	-13.44	peak	
9		10.9500	40.90	10.10	51.00	60.00	-9.00	peak	
10		10.9500	28.83	10.10	38.93	50.00	-11.07	AVG	
11		20.1000	32.08	10.24	42.32	60.00	-17.68	peak	

*:Maximum data x:Over limit !:over margin

●Reference Only



File :ZG5B C TEST(WCDMA)

Data :#5

Date: 2008/8/22

Time:

80.0 dBuV



Site site#1

Phase: **L1**

Temperature: 26 °C

Limit: CISPR22 Class B Conduction(QP)

Power:

Humidity: 55 %

EUT:

M/N: ZG5

Mode: WCDMA

Note: CH9538

No.	Mk.	Freq. MHz	Reading Level dBuV	Correct Factor dB	Measure- ment dBuV	Limit dBuV	Over dB	Detector	Comment
1		0.1507	43.28	9.73	53.01	65.96	-12.95	peak	
2		0.1869	41.85	9.74	51.59	64.17	-12.58	peak	
3		0.2479	36.13	9.75	45.88	61.82	-15.94	peak	
4		0.5360	32.66	9.79	42.45	56.00	-13.55	peak	
5		2.8128	37.40	9.91	47.31	56.00	-8.69	peak	
6		2.8128	22.51	9.91	32.42	46.00	-13.58	AVG	
7	*	4.0457	42.21	9.96	52.17	56.00	-3.83	peak	
8		4.0457	23.75	9.96	33.71	46.00	-12.29	AVG	
9		10.9500	41.17	10.10	51.27	60.00	-8.73	peak	
10		10.9500	25.74	10.10	35.84	50.00	-14.16	AVG	
11		20.3500	34.60	10.36	44.96	60.00	-15.04	peak	

*:Maximum data x:Over limit !:over margin

●Reference Only



File :ZG5B C TEST(WCDMA)

Data :#6

Date: 2008/8/22

Time:

80.0 dBuV

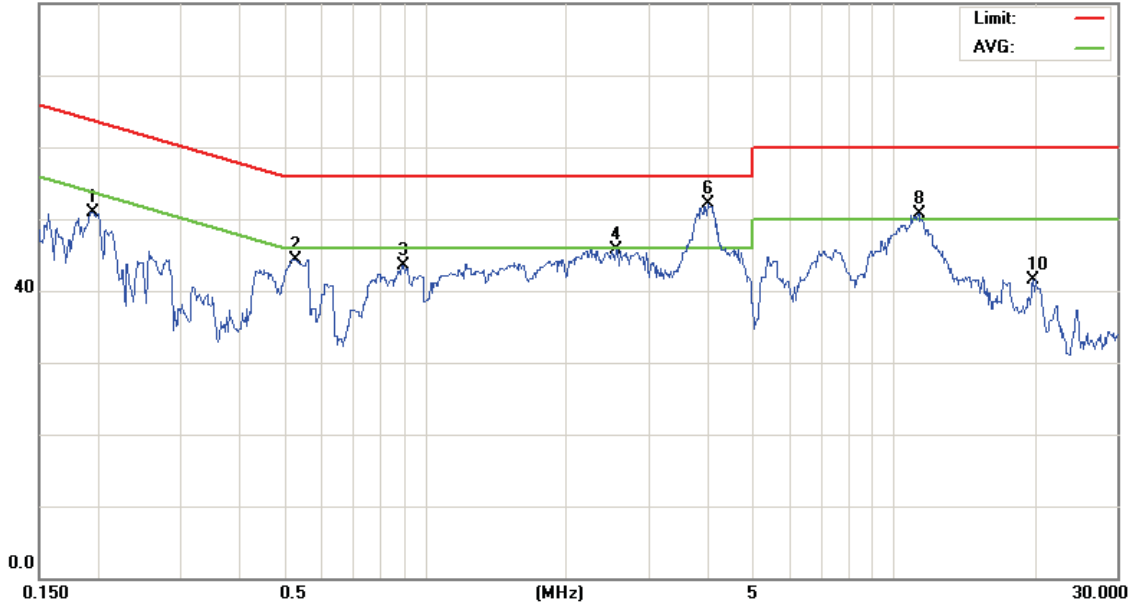

Site site#1

Phase: **L2**

Temperature: 26 °C

Limit: CISPR22 Class B Conduction(QP)

Power:

Humidity: 55 %

EUT:

M/N: ZG5

Mode: WCDMA

Note: CH9538

No.	Mk.	Freq. MHz	Reading Level dBuV	Correct Factor dB	Measure- ment dBuV	Limit dBuV	Over dB	Detector	Comment
1		0.1948	41.13	9.74	50.87	63.83	-12.96	peak	
2		0.5270	34.43	9.79	44.22	56.00	-11.78	peak	
3		0.8960	33.66	9.80	43.46	56.00	-12.54	peak	
4		2.5517	35.73	9.93	45.66	56.00	-10.34	peak	
5		2.5517	22.79	9.93	32.72	46.00	-13.28	AVG	
6	*	4.0100	42.09	9.97	52.06	56.00	-3.94	peak	
7		4.0100	24.81	9.97	34.78	46.00	-11.22	AVG	
8		11.3000	40.58	10.11	50.69	60.00	-9.31	peak	
9		11.3000	28.68	10.11	38.79	50.00	-11.21	AVG	
10		19.8000	31.33	10.25	41.58	60.00	-18.42	peak	

*:Maximum data x:Over limit !:over margin

●Reference Only



5. List of Measurement Equipments

Manufacturer	Name of Equipment	Type/Model	Serial Number	Calibration	
				Last Cal.	Due Date
Agilent	Spectrum analyzer	E4408B	MY45107753	Jun. 05, 2008	Jun. 05, 2009
R&S	Receiver	ESCI	100367	Jun. 05, 2008	Jun. 05, 2009
SCHWARZBECK	Trilog Broadband Antenna	VULB 9163	9163-270	Jun. 26, 2008	Jun. 26, 2009
SCHWARZBECK	Broadband Horn Antenna	BBHA 9120D	9120D-550	Jun. 26, 2008	Jun. 26, 2009
SCHWARZBECK	Broadband Horn Antenna	BBHA 9170	9170-320	Jun. 09, 2008	Aug. 07, 2009
Agilent	Amplifier	8447D	2944A10961	Jun. 10, 2008	Jun. 10, 2009
Universal Radio Communication Tester	ROHDE & SCHWARZ	CMU200	112387	Oct. 24, 2007	Oct. 24, 2008
Spectrum Analyzer	Agilent	E4445A	MY45300744	Nov. 29, 2007	Nov. 29, 2008
Loop Dipole	ETS-Lindgren	3127-1880	00052640	Jul. 02, 2008	Jul. 02, 2009
Loop Dipole	ETS-Lindgren	3127-836	00055272	Jun. 29, 2008	Jun. 29, 2009
Sleeve Dipole	ETS-Lindgren	3126-1845	00056670	Jun. 29, 2008	Jun. 29, 2009
Sleeve Dipole	ETS-Lindgren	3126-880	00052705	Jun. 29, 2008	Jun. 29, 2009
Anechoic Chamber	ETS-Lindgren	AMS 8500	S/N 102165	NA	
High Pass Filter	MICRO-TRONICS	HPM50108	020	NA	
High Pass Filter	MICRO-TRONICS	HPM50111	021	NA	
Circularly Polarized Communication Antennas	EMCO	3102	00051714	NA	
Pattern Measurement Software	ETS-Lindgren	EMQuest™ EMQ-100	NA	NA	
Desktop Computer with Windows XP		Dell Computers	NA	NA	
Antenna Positioner Controller	EMCO	2090	00052447	NA	
MAPS Positioner	EMCO	2010/2015	NA	NA	
Filter	K&L	5TNF-1700/ 2000-0.1N/N	166	NA	
Filter	K&L	3TNF-800/ 1000-0.2N/N	274	NA	
Attenuator	RADIALL	R41572000	0603033073	NA	
Splitter	Powercom	SGR-GFQ-2-D	41106609	NA	
Power divider	Agilent	87302C	3239A00760	NA	



6. Uncertainty Evaluation

Uncertainty of Radiated Emission Measurement (30MHz ~ 1000MHz)

Contribution	Uncertainty of x_i		$U(x_i)$
	dB	Probability Distribution	
Receiver reading	0.41	Normal(k=2)	0.21
Antenna factor calibration	0.83	Normal(k=2)	0.42
Cable loss calibration	0.25	Normal(k=2)	0.13
Pre Amplifier Gain calibration	0.27	Normal(k=2)	0.14
RCV/SPA specification	2.50	Rectangular	0.72
Antenna Factor Interpolation for Frequency	1.00	Rectangular	0.29
Site imperfection	1.43	Rectangular	0.83
Mismatch	+0.39/-0.41	U-shaped	0.28
combined standard uncertainty Uc(y)	1.27		
Measuring uncertainty for a level of confidence of 95% U=2Uc(y)	2.54		

Uncertainty of Radiated Emission Measurement (1GHz ~ 40GHz)

Contribution	Uncertainty of x_i		$U(x_i)$	C_i	$C_i * U(x_i)$
	dB	Probability Distributio			
Receiver reading	±0.10	Normal(k=1)	0.10	1	0.10
Antenna factor calibration	±1.70	Normal(k=2)	0.85	1	0.85
Cable loss calibration	±0.50	Normal(k=2)	0.25	1	0.25
Receiver Correction	±2.00	Rectangular	1.15	1	1.15
Antenna Factor Directional	±1.50	Rectangular	0.87	1	0.87
Site imperfection	±2.80	Triangular	1.14	1	1.14
Mismatch Receiver VSWR $\sqrt{1} = 0.197$ Antenna VSWR $\sqrt{2} = 0.194$ Uncertainty= $20\log(1-\sqrt{1} * \sqrt{2} * \sqrt{3})$	+0.34/-0.35	U-shaped	0.244	1	0.244
Combined standard uncertainty Uc(y)	2.36				
Measuring uncertainty for a level of confidence of 95% U=2Ue(y)	4.72				