

# Partial FCC Test Report

**EQUIPMENT** : Notebook Computer  
**BRAND NAME** : acer  
**MODEL NAME** : KAV10, Aspire one, AOD150  
**FCC ID** : HLZZG5  
**STANDARD** : FCC Part 15 Subpart C §15.247  
**CLASSIFICATION** : Digital Transmission System (DTS)  
**APPLICANT** : Acer Inc.

8F, 88, Sec.1, Hsin Tai Wu Rd. Hsichih Taipei  
Hsien 221 Taiwan, R.O.C.

The product sample received on Jan. 23, 2009 and completely tested on Jan. 24, 2009. We, SPORTON INTERNATIONAL INC., would like to declare that the tested sample has been evaluated in accordance with the procedures given in ANSI C63.4-2003 and shown the compliance with the applicable technical standards.

The test results in this report apply exclusively to the tested model / sample. Without written approval of SPORTON INTERNATIONAL INC., the test report shall not be reproduced except in full.

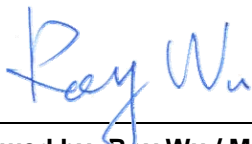

Reviewed by: Roy Wu / Manager



## **SPORTON INTERNATIONAL INC.**

**No. 52, Hwa Ya 1<sup>st</sup> Rd., Hwa Ya Technology Park, Kwei-Shan Hsiang, Tao Yuan Hsien, Taiwan, R.O.C.**



# TABLE OF CONTENTS

**REVISION HISTORY..... 3**

**SUMMARY OF TEST RESULT ..... 4**

**1 GENERAL DESCRIPTION ..... 5**

    1.1 Applicant ..... 5

    1.2 Manufacturer..... 5

    1.3 Feature of Equipment Under Test ..... 5

    1.4 Testing Site..... 7

    1.5 Applied Standards ..... 7

    1.6 Ancillary Equipment List ..... 7

**2 TEST CONFIGURATION OF EQUIPMENT UNDER TEST ..... 8**

    2.1 Test Mode..... 8

    2.2 Connection Diagram of Test System..... 8

    2.3 RF Utility ..... 8

**3 TEST RESULT..... 9**

    3.1 Radiated Emission Measurement..... 9

    3.2 Antenna Requirements..... 35

**4 LIST OF MEASURING EQUIPMENTS ..... 36**

**5 UNCERTAINTY OF EVALUATION ..... 37**

**6 CERTIFICATION OF TAF ACCREDITATION ..... 38**

**APPENDIX A. PHOTOGRAPHS OF EUT**

**APPENDIX B. SETUP PHOTOGRAPHS**



## REVISION HISTORY

REPORT NO.	VERSION	DESCRIPTION	ISSUED DATE
FR912401	Rev. 01	Initial issue of report	Jan. 24, 2009

## SUMMARY OF TEST RESULT

Report Section	FCC Rule	IC Rule	Description	Limit	Result	Remark
3.1	15.247(a)(2)	A8.2(a)	6dB Bandwidth	$\geq 0.5\text{MHz}$	Not Applicable	-
3.2	15.247(b)	A8.4	Power Output	$\leq 30\text{dBm}$	Not Applicable	-
3.3	15.247(d)	A8.5	Frequency Band Edges	$\leq 20\text{dBc}$	Not Applicable	-
3.4	15.247(e)	A8.2(b)	Power Spectral Density	$\leq 8\text{dBm}$	Not Applicable	-
3.5	15.207	Gen 7.2.2	AC Conducted Emission	15.207(a)	Not Applicable	-
3.6	15.247(d)	A8.5	Transmitter Radiated Emission	15.209(a) & 15.247(d)	Pass	Under limit 1.40 dB at 2286.00 MHz
3.7	15.203 & 15.247(b)	A8.4	Antenna Requirement	N/A	Pass	-

# 1 General Description

## 1.1 Applicant

**Acer Inc.**

8F, 88, Sec.1, Hsin Tai Wu Rd. Hsichih Taipei Hsien 221 Taiwan, R.O.C.

## 1.2 Manufacturer

**1. Compal Electronics (China) Co., Ltd**

988 Tong Feng East Rd., Kunshan Economics & Technical Development Zone, Kunshan, Jiangsu, P.R. China

**2. Compal Information (Kunshan) Co., Ltd.**

The Third Street, Kunshan Export Processing Zone, Jiangsu, P.R. China

**3. Compal Information Technology (Kunshan) Co., Ltd.**

No. 58, The 1<sup>st</sup> Street, Kunshan Export Processing Zone, Jiangsu, P.R. China

**4. Compal Electronics Technology (Kunshan) Co., Ltd.**

No. 25, The Third Street, Kunshan Export Processing Zone, Jiangsu, P.R. China

**5. Kunshang Botai Electronics Co., Ltd.**

988 Tong Feng East Rd., Kunshan Economic & Technical Development Zone, Kunshan, Jiangsu, P.R. China

## 1.3 Feature of Equipment Under Test

Product Feature & Specification	
<b>Equipment</b>	Notebook Computer
<b>Brand Name</b>	acer
<b>Model Name</b>	KAV10, Aspire one, AOD150
<b>Tx/Rx Frequency Range</b>	2400 MHz ~ 2483.5 MHz
<b>Number of Channels</b>	11
<b>Carrier Frequency of Each Channel</b>	2412+(n-1)*5 MHz; n=1~11
<b>Channel Spacing</b>	5 MHz
<b>Antenna Type</b>	Fixed Internal Antenna
<b>Antenna Gain</b>	1.53 dBi
<b>Type of Antenna Connector</b>	HRS
<b>Type of Modulation</b>	802.11b : DSSS (BPSK / QPSK / CCK) 802.11g : OFDM (BPSK / QPSK / 16QAM / 64QAM)
<b>EUT Stage</b>	Production Unit



Accessories List:

Accessories Specification		
AC Adapter	Brand Name	Delta
	Model Name	ADP-30JH B
	Power Rating	I/P:100-240Vac, 50-60Hz, 1.2A; O/P: 19Vdc, 1.58A
	DC Power Cord Type	1.5 meter shielded cable with ferrite core
Battery	Brand Name	Simplo
	Model Name	UM08B73
	Part Number	934T3310F
	Power Rating	11.1Vdc, 5200mAh
	Type	Li-ion

Remark:

1. The above EUT's information was declared by manufacturer. Please refer to the specifications or user's manual for more detailed description.
2. For accessories equipped with this EUT, please refer to the appendix of the external photo.

## 1.4 Testing Site

<b>Test Site</b>	SPORTON INTERNATIONAL INC.	
<b>Test Site Location</b>	No. 52, Hwa Ya 1 <sup>st</sup> Rd., Hwa Ya Technology Park, Kwei-Shan Hsiang, Tao Yuan Hsien, Taiwan, R.O.C TEL: +886-3-3273456 / FAX: +886-3-3284978	
<b>Test Site No.</b>	<b>Sporton Site No.</b>	<b>FCC/IC Registration No.</b>
	03CH07-HY	TW1022/4086B-1

## 1.5 Applied Standards

According to the specifications of the manufacturer, the EUT must comply with the requirements of the following standards:

- ♦ FCC Part 15 Subpart C §15.247
- ♦ FCC KDB Publication No. 558074 (Measurement Guidelines of DTS)
- ♦ ANSI C63.4-2003
- ♦ IC RSS-210 Issue 7

**Remark:**

1. All test items were verified and recorded according to the standards and without any deviation during the test.
2. This EUT has also been tested and complied with the requirements of FCC Part 15, Subpart B (DoC), recorded in a separate test report.

## 1.6 Ancillary Equipment List

Item	Equipment	Trade Name	Model Name	FCC ID	Data Cable	Power Cord
1.	LCD Monitor	lenovo	6135-AB1	FCC DoC	Shielded, 1.6 m	Unshielded, 1.8 m
2.	Earphone + Mic	Sampo	EK-Y652CS	FCC DoC	Shielded, 1.8 m	N/A
3.	i-pod	Apple	A1199	FCC DoC	Unshielded, 1.0 m	N/A
4.	i-pod	Apple	A1236	FCC DoC	Unshielded, 1.0 m	N/A

## 2 Test Configuration of Equipment Under Test

### 2.1 Test Mode

The EUT has been associated with peripherals pursuant to ANSI C63.4-2003 and configuration operated in a manner tended to maximize its emission characteristics in a typical application. Frequency range investigated: radiated emission (30 MHz to the 10th harmonic of the highest fundamental frequency or to 40 GHz, whichever is lower). The following tables are showing the test modes as the worst cases and recorded in this report.

Test Cases		
Test Item	802.11b Modulation : DSSS	802.11g Modulation : OFDM
Radiated TCs	<ul style="list-style-type: none"> <li>■ Mode 1: CH01_2412 MHz</li> <li>■ Mode 2: CH06_2437 MHz</li> <li>■ Mode 3: CH11_2462 MHz</li> </ul>	<ul style="list-style-type: none"> <li>■ Mode 4: CH01_2412 MHz</li> <li>■ Mode 5: CH06_2437 MHz</li> <li>■ Mode 6: CH11_2462 MHz</li> </ul>

### 2.2 Connection Diagram of Test System

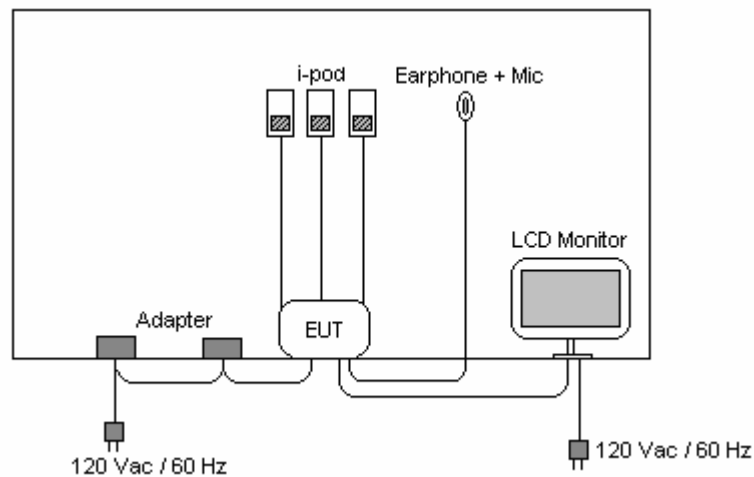

### 2.3 RF Utility

Programmed RF utility "art \id=3067" installed in EUT provides functions like channel selection and power level for continuous transmitting and receiving signal.



### 3 Test Result

#### 3.1 Radiated Emission Measurement

##### 3.1.1 Limit of Radiated Emission

In any 100 kHz bandwidth outside the intentional radiator frequency band, all harmonics/spurious must be at least 20 dB below the highest emission level within the authorized band. If the output power of this device was measured by spectrum analyzer, the attenuation under this paragraph shall be 30 dB instead of 20 dB. In addition, radiated emissions which fall in the restricted bands must also comply with the FCC section 15.209 limits as below.

Frequency (MHz)	Field Strength (microvolts/meter)	Measurement Distance (meters)
0.009 – 0.490	2400/F(kHz)	300
0.490 – 1.705	24000/F(kHz)	30
1.705 – 30.0	30	30
30 – 88	100	3
88 – 216	150	3
216 - 960	200	3
Above 960	500	3

##### 3.1.2 Measuring Instruments

See list of measuring instruments of this test report.

##### 3.1.3 Test Procedures

1. The testing follows the guidelines in FCC KDB Publication No. 558074 (Measurement Guidelines of DTS).
2. Use the following spectrum analyzer settings:  
Span = wide enough to fully capture the emission being measured; RBW = 1 MHz for  $f \geq 1$  GHz, 100 kHz for  $f < 1$  GHz; VBW  $\geq$  RBW; Sweep = auto; Detector function = peak; Trace = max hold.
3. Follow the guidelines in ANSI C63.4-2003 with respect to maximizing the emission by rotating the EUT, measuring the emission for three EUT orthogonal planes, and adjusting the measurement antenna height and polarization. A pre-amp and a high pass filter are used for this test in order to get the good signal level.

### 3.1.4 Test Setup

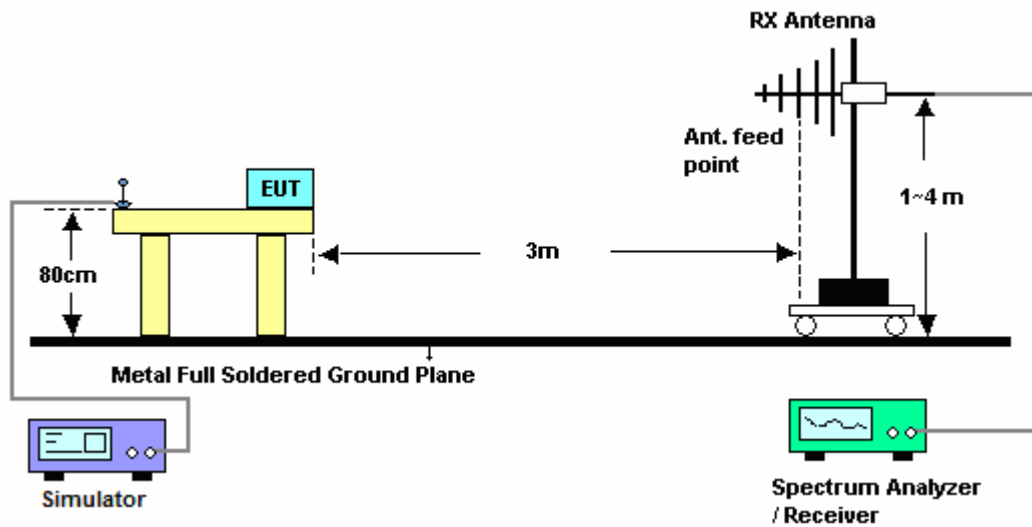



3.1.5 Test Result of Radiated Emission < 1GHz

Test Mode :	Mode 1	Temperature :	22~23°C
Test Channel :	01	Relative Humidity :	42~43%
Test Engineer :	Kay Wu	Polarization :	Horizontal
Remark :			

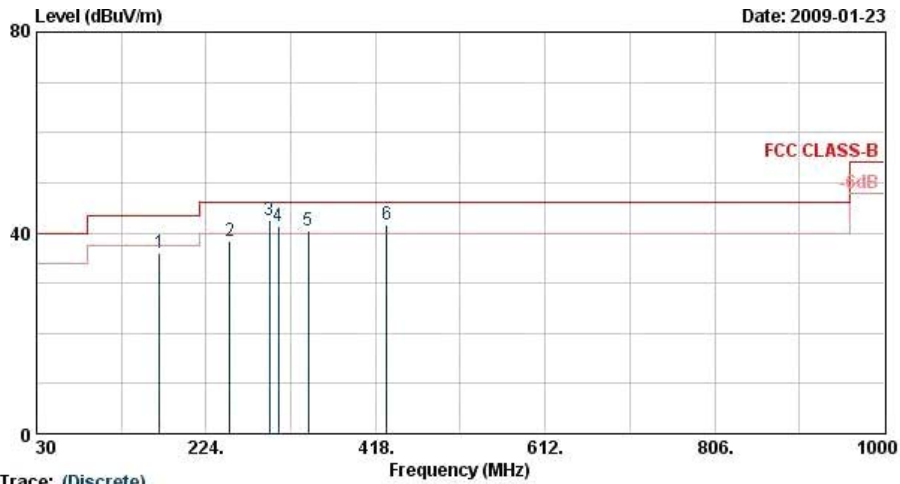

Trace: (Discrete)  
 Site : 03CH07-HY  
 Condition : 3m LF-ANT(080228) HORIZONTAL  
 Project : FR 912401  
 Mode : Mode 1

	Freq	Level	Over	Limit	ReadAntenna	Cable	Preamp	Ant	Table	Remark
	MHz	dBuV/m	Limit	Line	Level	Loss	Factor	Pos	Pos	
			dB	dBuV/m	dBuV	dB	dB	cm	deg	
1	170.94	36.02	-7.48	43.50	56.37	9.43	1.55	31.33	---	Peak
2	250.86	38.25	-7.75	46.00	55.83	11.94	1.92	31.45	---	Peak
3 !	296.22	42.57	-3.43	46.00	59.00	12.88	2.11	31.42	100	60 QP
4 !	307.00	41.41	-4.59	46.00	57.46	13.18	2.16	31.39	---	Peak
5 !	341.30	40.33	-5.67	46.00	55.32	14.13	2.31	31.42	---	Peak
6 !	430.90	41.69	-4.31	46.00	53.84	16.43	2.73	31.30	---	Peak



Test Mode :	Mode 1	Temperature :	22~23°C
Test Channel :	01	Relative Humidity :	42~43%
Test Engineer :	Kay Wu	Polarization :	Vertical
Remark :			

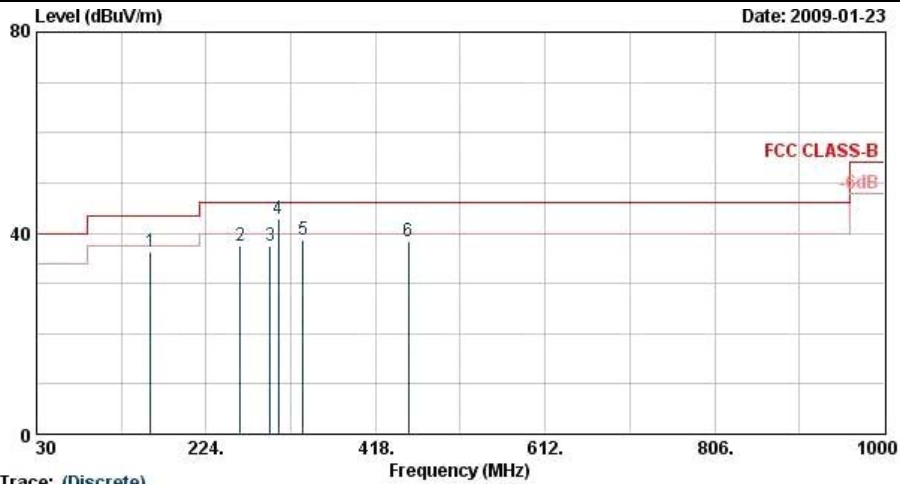

Trace: (Discrete)  
 Site : 03CH07-HY  
 Condition : 3m LF-ANT(080228) VERTICAL  
 Project : FR 912401  
 Mode : Mode 1

	Freq	Level	Over	Limit	ReadAntenna	Cable	Preamp	Ant	Table	Remark	
	MHz	dBuV/m	dB	dBuV/m	dBuV	dB/m	dB	dB	cm	deg	
1	160.14	36.34	-7.16	43.50	56.01	10.13	1.51	31.31	---	---	Peak
2	262.74	37.51	-8.49	46.00	54.82	12.19	1.96	31.46	---	---	Peak
3	297.30	37.42	-8.58	46.00	53.80	12.92	2.12	31.41	100	303	QP
4	307.00	42.76	-3.24	46.00	58.81	13.18	2.16	31.39	---	---	Peak
5	335.00	38.64	-7.36	46.00	53.82	13.94	2.28	31.39	---	---	Peak
6	455.40	38.42	-7.58	46.00	49.85	16.97	2.82	31.22	---	---	Peak



Test Mode :	Mode 2	Temperature :	22~23°C
Test Channel :	06	Relative Humidity :	42~43%
Test Engineer :	Kay Wu	Polarization :	Horizontal
Remark :			

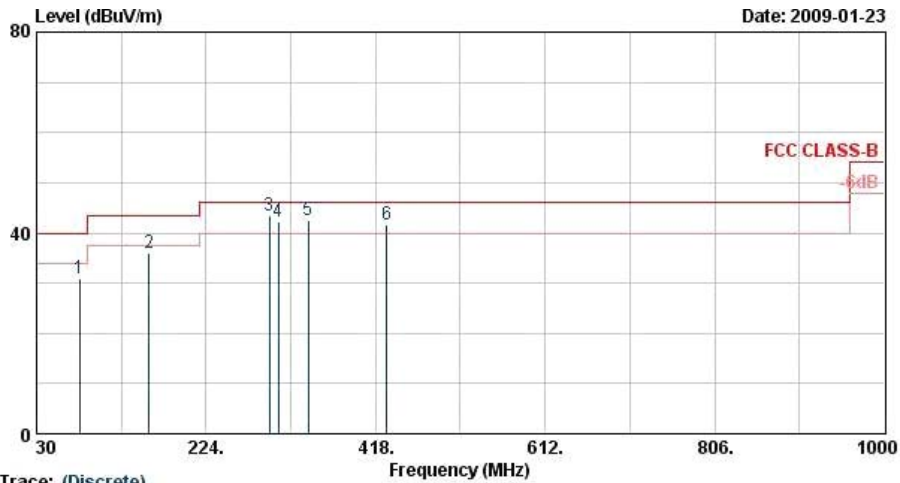

Trace: (Discrete)  
 Site : 03CH07-HY  
 Condition : 3m LF-ANT(080228) HORIZONTAL  
 Project : FR 912401  
 Mode : Mode 2

	Freq	Level	Over	Limit	Read	Antenna	Cable	Preamp	Ant	Table	Remark
	MHz	dBuV/m	dB	dBuV/m	dBuV	dB/m	dB	dB	cm	deg	
1	79.41	31.05	-8.95	40.00	54.39	7.02	1.00	31.35	---	---	Peak
2	159.06	36.10	-7.40	43.50	55.72	10.19	1.51	31.32	---	---	Peak
3 !	296.22	43.37	-2.63	46.00	59.80	12.88	2.11	31.42	100	72	QP
4 !	307.00	42.22	-3.78	46.00	58.27	13.18	2.16	31.39	---	---	Peak
5 !	340.60	42.58	-3.42	46.00	57.59	14.10	2.30	31.42	---	---	Peak
6 !	430.90	41.64	-4.36	46.00	53.79	16.43	2.73	31.30	---	---	Peak



Test Mode :	Mode 2	Temperature :	22~23°C
Test Channel :	06	Relative Humidity :	42~43%
Test Engineer :	Kay Wu	Polarization :	Vertical
Remark :			

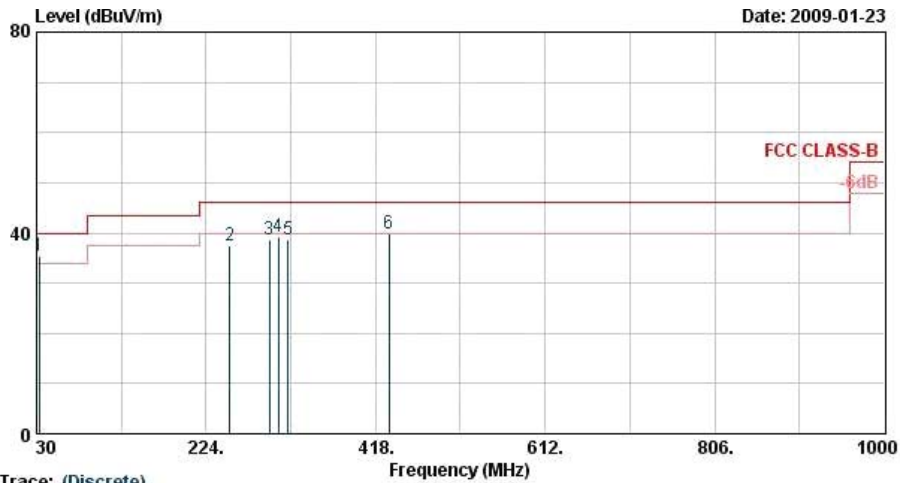

Trace: (Discrete)  
 Site : 03CH07-HY  
 Condition : 3m LF-ANT(080228) VERTICAL  
 Project : FR 912401  
 Mode : Mode 2

	Freq	Level	Over	Limit	Read	Antenna	Cable	Preamp	Ant	Table	Remark
	MHz	dBuV/m	dB	dBuV/m	dBuV	dB/m	dB	dB	cm	deg	
1 !	32.97	35.36	-4.64	40.00	49.16	16.76	0.66	31.23	---	---	Peak
2	251.13	37.35	-8.65	46.00	54.94	11.94	1.92	31.45	---	---	Peak
3	296.49	38.60	-7.40	46.00	55.00	12.90	2.11	31.42	100	250	QP
4	307.00	39.37	-6.63	46.00	55.42	13.18	2.16	31.39	---	---	Peak
5	318.20	38.55	-7.45	46.00	54.23	13.48	2.21	31.37	---	---	Peak
6	433.00	39.79	-6.21	46.00	51.88	16.47	2.73	31.29	---	---	Peak



Test Mode :	Mode 3	Temperature :	22~23°C
Test Channel :	11	Relative Humidity :	42~43%
Test Engineer :	Kay Wu	Polarization :	Horizontal
Remark :			

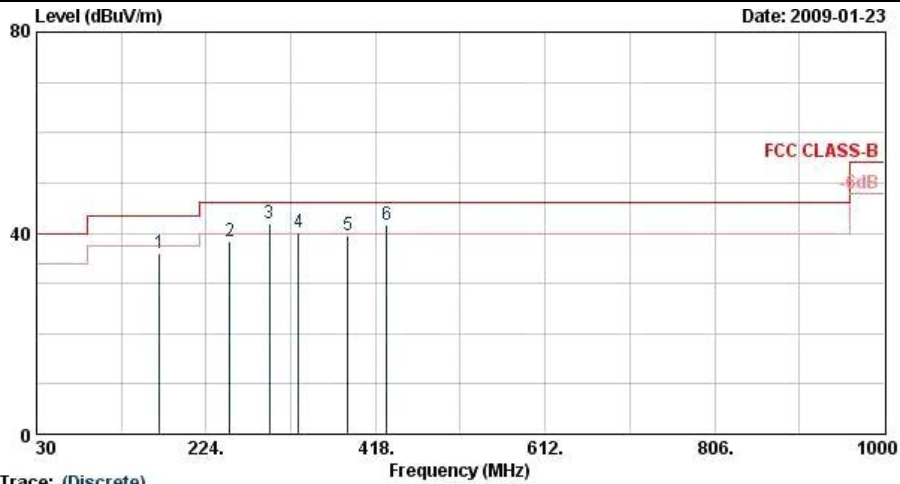

Trace: (Discrete)  
 Site : 03CH07-HY  
 Condition : 3m LF-ANT(080228) HORIZONTAL  
 Project : FR 912401  
 Mode : Mode 3

	Freq	Level	Over	Limit	ReadAntenna	Cable	Preamp	Ant	Table	Remark	
	MHz	dBuV/m	dB	dBuV/m	dBuV	dB/m	dB	dB	cm	deg	
1	170.94	35.99	-7.51	43.50	56.34	9.43	1.55	31.33	---	---	Peak
2	250.86	38.35	-7.65	46.00	55.94	11.94	1.92	31.45	---	---	Peak
3 !	296.22	41.87	-4.13	46.00	58.30	12.88	2.11	31.42	100	30	QP
4 !	329.40	40.00	-6.00	46.00	55.31	13.80	2.26	31.37	---	---	Peak
5	386.10	39.69	-6.31	46.00	53.10	15.38	2.50	31.29	---	---	Peak
6 !	430.90	41.58	-4.42	46.00	53.73	16.43	2.73	31.30	---	---	Peak



Test Mode :	Mode 3	Temperature :	22~23°C
Test Channel :	11	Relative Humidity :	42~43%
Test Engineer :	Kay Wu	Polarization :	Vertical
Remark :			

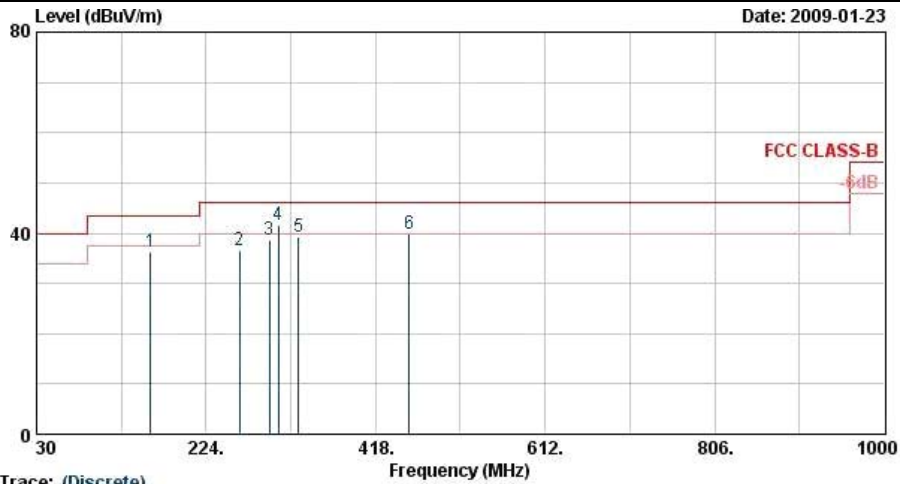

Trace: (Discrete)  
 Site : 03CH07-HY  
 Condition : 3m LF-ANT(080228) VERTICAL  
 Project : FR 912401  
 Mode : Mode 3

	Freq	Level	Over	Limit	ReadAntenna	Cable	Preamp	Ant	Table	Remark	
	MHz	dBuV/m	dB	dBuV/m	dBuV	dB/m	dB	dB	cm	deg	
1	160.14	36.42	-7.08	43.50	56.09	10.13	1.51	31.31	---	---	Peak
2	261.93	36.61	-9.39	46.00	53.95	12.16	1.96	31.45	---	---	Peak
3	296.49	38.60	-7.40	46.00	55.00	12.90	2.11	31.42	100	230	QP
4	307.00	41.66	-4.34	46.00	57.71	13.18	2.16	31.39	---	---	Peak
5	330.10	39.16	-6.84	46.00	54.47	13.80	2.26	31.37	---	---	Peak
6	456.10	39.87	-6.13	46.00	51.30	16.97	2.82	31.22	---	---	Peak





Test Mode :	Mode 4	Temperature :	22~23°C
Test Channel :	01	Relative Humidity :	42~43%
Test Engineer :	Kay Wu	Polarization :	Horizontal
Remark :			

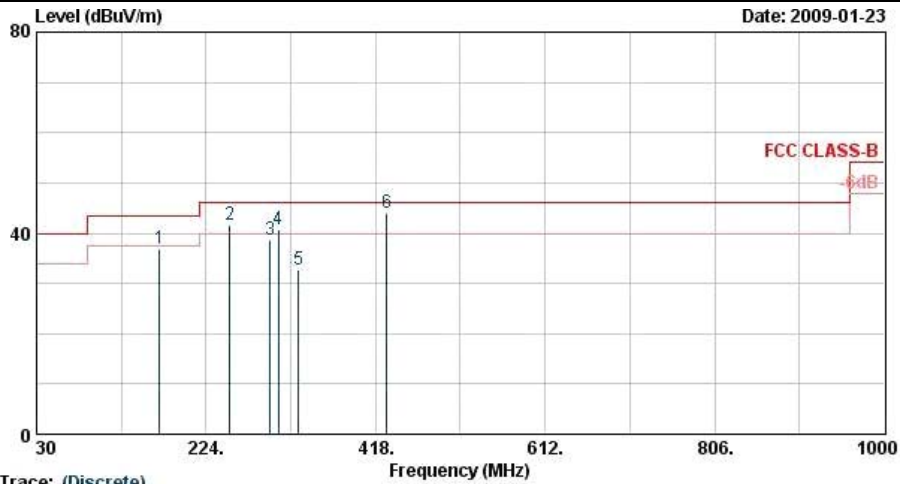

Site : 03CH07-HY  
 Condition : 3m LF-ANT(080228) HORIZONTAL  
 Project : FR 912401  
 Mode : Mode 4

	Freq	Level	Over	Limit	ReadAntenna	Cable	Preamp	Ant	Table	Remark
	MHz	dBuV/m	Limit	Line	Level	Loss	Factor	Pos	Pos	
			dB	dBuV/m	dBuV	dB	dB	cm	deg	
1	170.94	36.88	-6.62	43.50	57.23	9.43	1.55	31.33	---	Peak
2 !	250.86	41.70	-4.30	46.00	59.29	11.94	1.92	31.45	---	Peak
3	297.30	38.62	-7.38	46.00	55.00	12.92	2.12	31.41	110	25 QP
4 !	307.00	40.73	-5.27	46.00	56.78	13.18	2.16	31.39	---	Peak
5	329.40	32.69	-13.31	46.00	48.00	13.80	2.26	31.37	120	84 QP
6 !	430.90	44.15	-1.85	46.00	56.30	16.43	2.73	31.30	100	42 QP



Test Mode :	Mode 4	Temperature :	22~23°C
Test Channel :	01	Relative Humidity :	42~43%
Test Engineer :	Kay Wu	Polarization :	Vertical
Remark :			

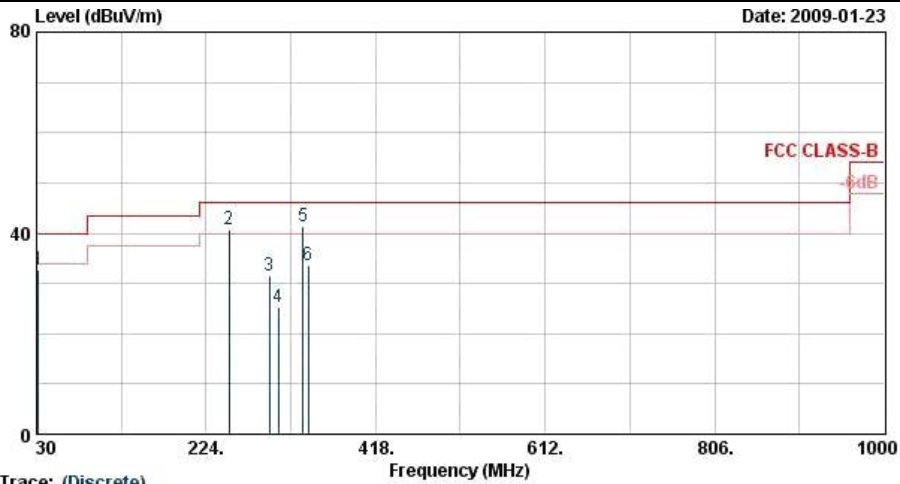

Site : 03CH07-HY  
 Condition : 3m LF-ANT(080228) VERTICAL  
 Project : FR 912401  
 Mode : Mode 4

	Freq	Level	Over	Limit	Read	Antenna	Cable	Preamp	Ant	Table	Remark
	MHz	dBuV/m	dB	dBuV/m	dBuV	dB/m	dB	dB	cm	deg	
1	31.89	32.77	-7.23	40.00	45.99	17.38	0.66	31.26	---	---	Peak
2 !	250.05	40.82	-5.18	46.00	58.43	11.92	1.92	31.45	---	---	Peak
3	296.22	31.57	-14.43	46.00	48.00	12.88	2.11	31.42	100	87	QP
4	307.00	25.35	-20.65	46.00	41.40	13.18	2.16	31.39	172	359	QP
5 !	335.00	41.39	-4.61	46.00	56.57	13.94	2.28	31.39	---	---	Peak
6	341.30	33.61	-12.39	46.00	48.60	14.13	2.31	31.42	175	348	QP



Test Mode :	Mode 5	Temperature :	22~23°C
Test Channel :	06	Relative Humidity :	42~43%
Test Engineer :	Kay Wu	Polarization :	Horizontal
Remark :			

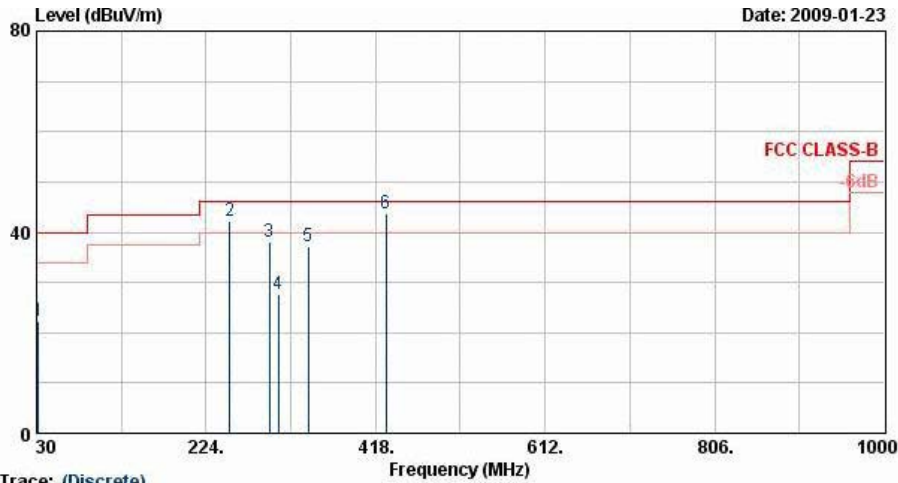

Trace: (Discrete)  
 Site : 03CH07-HY  
 Condition : 3m LF-ANT(080228) HORIZONTAL  
 Project : FR 912401  
 Mode : Mode 5

	Freq	Level	Over	Limit	Read	Antenna	Cable	Preamp	Ant	Table	Remark
	MHz	dBuV/m	dB	dBuV/m	dBuV	dB/m	dB	dB	cm	deg	
1	31.89	22.18	-17.82	40.00	35.40	17.38	0.66	31.26	128	4	QP
2 !	250.86	42.36	-3.64	46.00	59.95	11.94	1.92	31.45	---	---	Peak
3	296.22	37.97	-8.03	46.00	54.40	12.88	2.11	31.42	107	64	QP
4	307.00	27.55	-18.45	46.00	43.60	13.18	2.16	31.39	100	102	QP
5	340.60	37.09	-8.91	46.00	52.10	14.10	2.30	31.42	100	261	QP
6 !	430.00	43.73	-2.27	46.00	55.90	16.41	2.72	31.30	100	40	QP



Test Mode :	Mode 5	Temperature :	22~23°C
Test Channel :	06	Relative Humidity :	42~43%
Test Engineer :	Kay Wu	Polarization :	Vertical
Remark :			

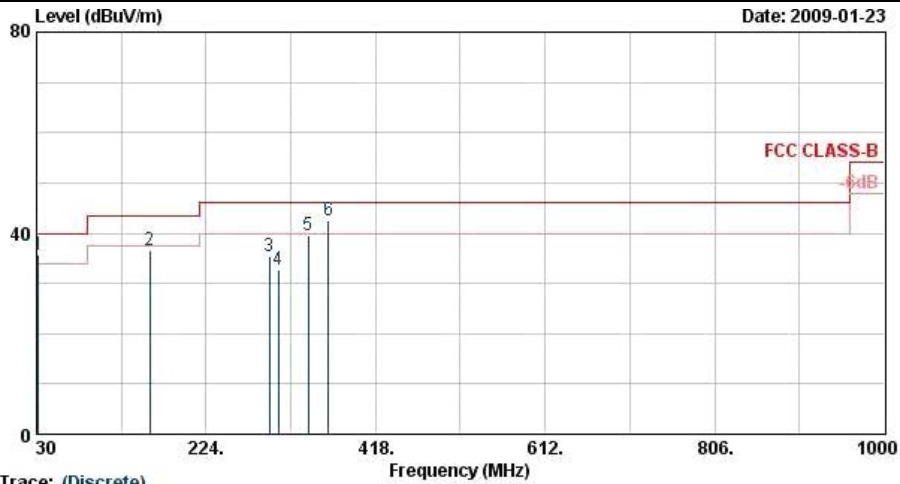

Trace: (Discrete)  
 Site : 03CH07-HY  
 Condition : 3m LF-ANT(080228) VERTICAL  
 Project : FR 912401  
 Mode : Mode 5

	Freq	Level	Over	Limit	Read	Antenna	Cable	Preamp	Ant	Table	Remark
	MHz	dBuV/m	dB	dBuV/m	dBuV	dB/m	dB	dB	cm	deg	
1 !	31.89	35.66	-4.34	40.00	48.89	17.38	0.66	31.26	---	---	Peak
2	159.33	36.45	-7.05	43.50	56.07	10.19	1.51	31.32	---	---	Peak
3	296.22	35.37	-10.63	46.00	51.80	12.88	2.11	31.42	190	241	QP
4	307.00	32.65	-13.35	46.00	48.70	13.18	2.16	31.39	171	280	QP
5	340.60	39.69	-6.31	46.00	54.70	14.10	2.30	31.42	151	3	QP
6 !	363.70	42.67	-3.33	46.00	56.90	14.75	2.41	31.39	129	17	QP



Test Mode :	Mode 6	Temperature :	22~23°C
Test Channel :	11	Relative Humidity :	42~43%
Test Engineer :	Kay Wu	Polarization :	Horizontal
Remark :			

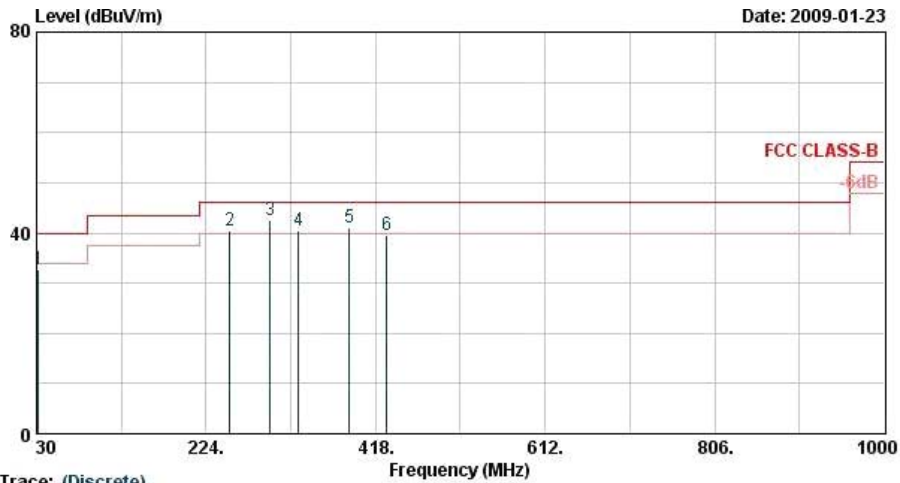

Trace: (Discrete)  
 Site : 03CH07-HY  
 Condition : 3m LF-ANT(080228) HORIZONTAL  
 Project : FR 912401  
 Mode : Mode 6

	Freq	Level	Over	Limit	Read	Antenna	Cable	Preamp	Ant	Table	Remark
	MHz	dBuV/m	dB	dBuV/m	dBuV	dB/m	dB	dB	cm	deg	
1	31.89	32.73	-7.27	40.00	45.95	17.38	0.66	31.26	137	66	QP
2 !	251.13	40.58	-5.42	46.00	58.16	11.94	1.92	31.45	---	---	Peak
3 !	297.30	42.62	-3.38	46.00	59.00	12.92	2.12	31.41	100	322	QP
4 !	329.40	40.36	-5.64	46.00	55.67	13.80	2.26	31.37	---	---	Peak
5 !	388.20	41.19	-4.81	46.00	54.53	15.43	2.51	31.28	---	---	Peak
6	430.90	39.65	-6.35	46.00	51.80	16.43	2.73	31.30	100	328	QP



Test Mode :	Mode 6	Temperature :	22~23°C
Test Channel :	11	Relative Humidity :	42~43%
Test Engineer :	Kay Wu	Polarization :	Vertical
Remark :			

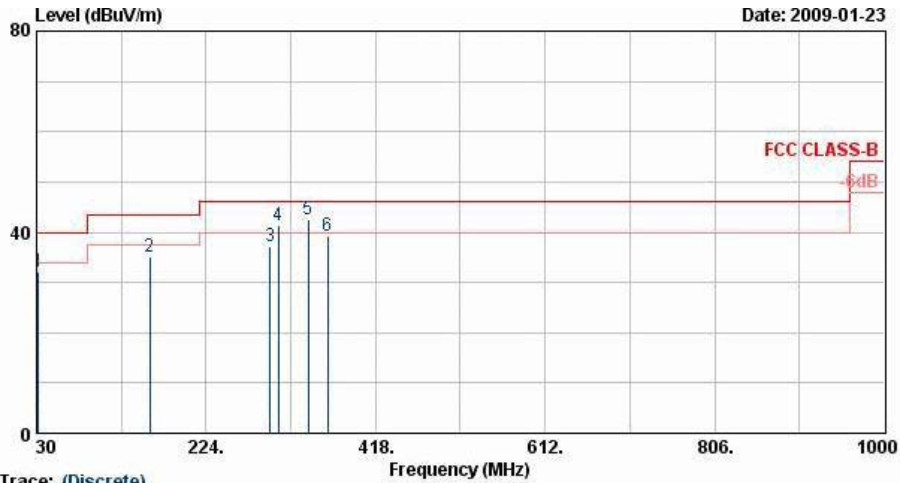

Trace: (Discrete)  
 Site : 03CH07-HY  
 Condition : 3m LF-ANT(080228) VERTICAL  
 Project : FR 912401  
 Mode : Mode 6

	Freq	Level	Over	Limit	Read	Antenna	Cable	Preamp	Ant	Table	Remark
	MHz	dBuV/m	dB	dBuV/m	dBuV	dB/m	dB	dB	cm	deg	
1	31.89	32.08	-7.92	40.00	45.30	17.38	0.66	31.26	100	22	QP
2	159.33	35.18	-8.32	43.50	54.79	10.19	1.51	31.32	---	---	Peak
3	297.30	37.22	-8.78	46.00	53.60	12.92	2.12	31.41	100	247	QP
4 !	307.00	41.37	-4.63	46.00	57.42	13.18	2.16	31.39	---	---	Peak
5 !	341.30	42.51	-3.49	46.00	57.50	14.13	2.31	31.42	---	---	Peak
6	363.00	39.12	-6.88	46.00	53.38	14.73	2.41	31.40	---	---	Peak



3.1.6 Test Result of Radiated Emission  $\geq 1$ GHz

Test Mode :	Mode 1	Temperature :	22~23°C
Test Channel :	01	Relative Humidity :	42~43%
Test Engineer :	Kay Wu	Polarization :	Horizontal
Remark :	#3 and #4 are Fundamental Signals		

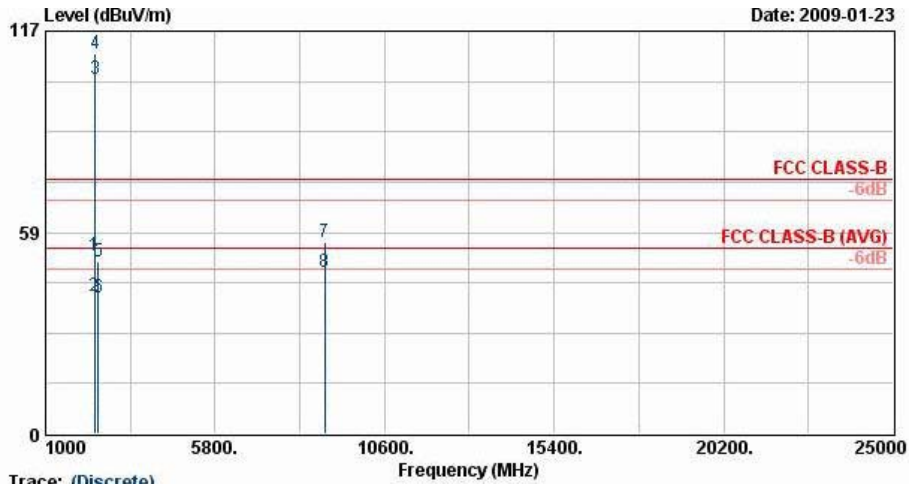

Trace: (Discrete)  
 Site : 03CH07-HY  
 Condition : 3m SHF-EHF HORN HORIZONTAL  
 Project : FR 912401  
 Mode : Mode 1

	Freq	Level	Over	Limit	Read	Antenna	Cable	Preamp	Ant	Table	Remark
	MHz	dBuV/m	Limit	Line	Level	Factor	Loss	Factor	Pos	Pos	
			dB	dBuV/m	dBuV	dB/m	dB	dB	cm	deg	
1	2389.99	51.65	-22.35	74.00	49.55	32.32	5.46	35.68	100	0	Peak
2	2389.99	39.90	-14.10	54.00	37.80	32.32	5.46	35.68	100	306	Average
3 @	2412.00	102.87			100.79	32.32	5.44	35.68	100	306	Average
4 X	2412.00	110.68			108.61	32.32	5.44	35.68	100	0	Peak
5	2494.00	50.00	-24.00	74.00	48.03	32.30	5.37	35.70	100	0	Peak
6	2494.00	39.56	-14.44	54.00	37.59	32.30	5.37	35.70	100	306	Average
7	8913.00	55.88	-18.12	74.00	43.47	38.64	10.31	36.54	100	0	Peak
8	8913.00	47.08	-6.92	54.00	34.67	38.64	10.31	36.54	100	189	Average



Test Mode :	Mode 1	Temperature :	22~23°C
Test Channel :	01	Relative Humidity :	42~43%
Test Engineer :	Kay Wu	Polarization :	Vertical
Remark :	#3 and #4 are Fundamental Signals		

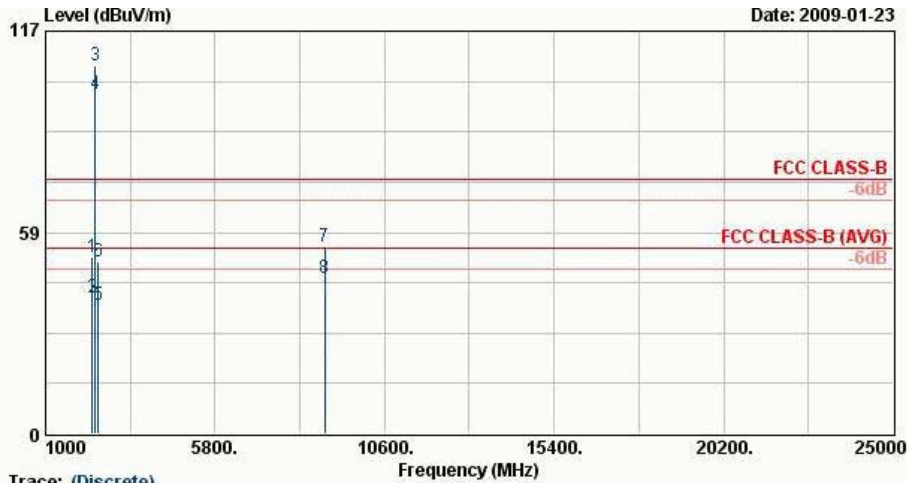

Trace: (Discrete)  
 Site : 03CH07-HY  
 Condition : 3m SHF-EHF HORN VERTICAL  
 Project : FR 912401  
 Mode : Mode 1

	Freq	Level	Over	Limit	Read	Antenna	Cable	Preamp	Ant	Table	
	MHz	dBuV/m	dB	dBuV/m	dBuV	dB/m	dB	dB	cm	deg	Remark
1	2325.58	51.29	-22.71	74.00	49.14	32.30	5.51	35.67	100	0	Peak
2	2325.58	39.78	-14.22	54.00	37.63	32.30	5.51	35.67	130	338	Average
3 X	2412.00	107.01			104.95	32.30	5.44	35.68	100	0	Peak
4 @	2412.00	98.79			96.73	32.30	5.44	35.68	130	338	Average
5	2500.00	37.44	-16.56	54.00	35.47	32.30	5.37	35.70	130	338	Average
6	2500.00	49.86	-24.14	74.00	47.89	32.30	5.37	35.70	100	0	Peak
7	8910.00	54.22	-19.78	74.00	42.91	37.54	10.31	36.54	100	0	Peak
8	8910.00	45.30	-8.70	54.00	33.99	37.54	10.31	36.54	100	247	Average





Test Mode :	Mode 2	Temperature :	22~23°C
Test Channel :	06	Relative Humidity :	42~43%
Test Engineer :	Kay Wu	Polarization :	Horizontal
Remark :	#3 and #4 are Fundamental Signals		

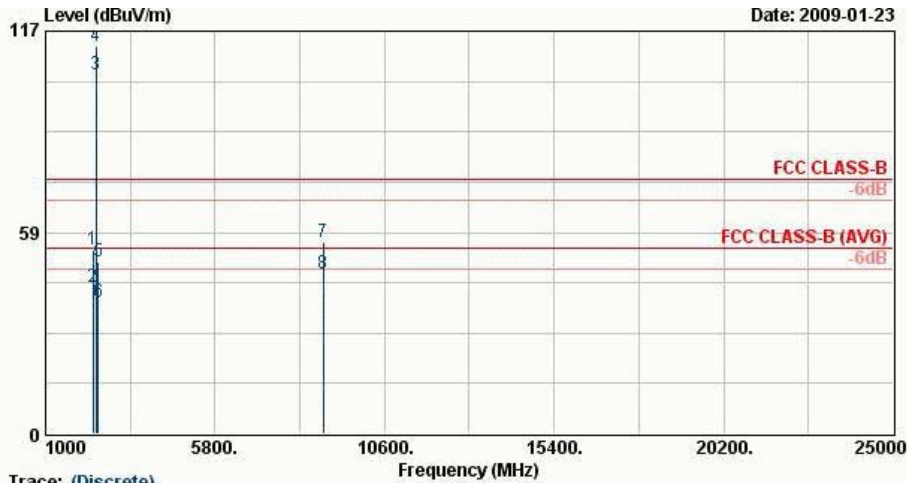

Trace: (Discrete)  
 Site : 03CH07-HY  
 Condition : 3m SHF-EHF HORN HORIZONTAL  
 Project : FR 912401  
 Mode : Mode 2

	Freq	Level	Over	Limit	Read	Antenna	Cable	Preamp	Ant	Table	Remark
	MHz	dBuV/m	dB	dBuV/m	dBuV	dB/m	dB	dB	cm	deg	
1	2348.00	53.48	-20.52	74.00	51.32	32.33	5.50	35.67	100	0	Peak
2	2348.00	42.81	-11.19	54.00	40.65	32.33	5.50	35.67	100	309	Average
3 @	2437.00	104.57			102.53	32.31	5.41	35.69	100	309	Average
4 X	2437.00	112.63			110.57	32.31	5.43	35.69	100	0	Peak
5	2484.00	49.90	-24.10	74.00	47.90	32.30	5.38	35.70	100	0	Peak
6	2484.00	38.37	-15.63	54.00	36.38	32.30	5.38	35.70	100	309	Average
7	8853.00	55.52	-18.48	74.00	43.12	38.61	10.29	36.51	100	0	Peak
8	8853.00	46.41	-7.59	54.00	34.02	38.61	10.29	36.51	100	110	Average



Test Mode :	Mode 2	Temperature :	22~23°C
Test Channel :	06	Relative Humidity :	42~43%
Test Engineer :	Kay Wu	Polarization :	Vertical
Remark :	#3 and #4 are Fundamental Signals		

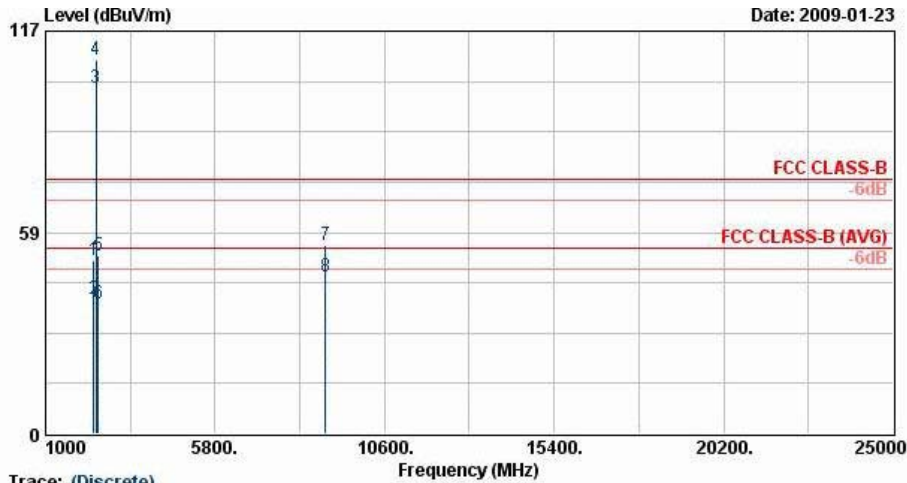

Trace: (Discrete)  
 Site : 03CH07-HY  
 Condition : 3m SHF-EHF HORN VERTICAL  
 Project : FR 912401  
 Mode : Mode 2

	Freq	Level	Over	Limit	Read	Antenna	Cable	Preamp	Ant	Table	Remark
	MHz	dBuV/m	dB	dBuV/m	dBuV	dB/m	dB	dB	cm	deg	
1	2356.00	50.64	-23.36	74.00	48.53	32.30	5.49	35.67	100	0	Peak
2	2356.00	39.18	-14.82	54.00	37.06	32.30	5.49	35.67	103	14	Average
3 @	2437.00	100.64			98.61	32.30	5.41	35.69	103	14	Average
4 X	2437.00	108.74			106.71	32.30	5.41	35.69	100	0	Peak
5	2494.00	51.89	-22.11	74.00	49.92	32.30	5.37	35.70	100	0	Peak
6	2494.00	37.64	-16.36	54.00	35.67	32.30	5.37	35.70	103	14	Average
7	8922.00	54.94	-19.06	74.00	43.64	37.55	10.31	36.56	100	0	Peak
8	8922.00	45.79	-8.21	54.00	34.48	37.55	10.31	36.56	100	132	Average



Test Mode :	Mode 3	Temperature :	22~23°C
Test Channel :	11	Relative Humidity :	42~43%
Test Engineer :	Kay Wu	Polarization :	Horizontal
Remark :	#5 and #6 are Fundamental Signals		

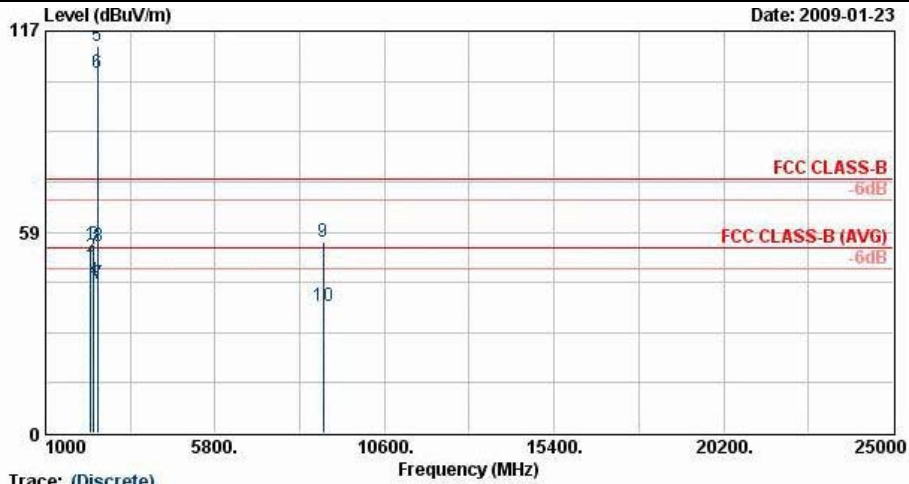

Site : 03CH07-HY  
 Condition : 3m SHF-EHF HORN HORIZONTAL  
 Project : FR 912401  
 Mode : Mode 3

	Freq	Level	Over	Limit	Read	Antenna	Cable	Preamp	Ant	Table	Remark
	MHz	dBuV/m	dB	dBuV/m	dBuV	dB/m	dB	dB	cm	deg	
1	2286.00	54.60	-19.40	74.00	52.37	32.34	5.54	35.66	100	0	Peak
2 !	2286.00	51.22	-2.78	54.00	48.99	32.34	5.54	35.66	130	21	Average
3	2374.00	54.69	-19.31	74.00	52.57	32.32	5.47	35.68	100	0	Peak
4	2374.00	44.37	-9.63	54.00	42.25	32.32	5.47	35.68	100	307	Average
5 X	2462.00	112.44			110.43	32.31	5.40	35.69	100	0	Peak
6 @	2462.00	104.70			102.68	32.31	5.40	35.69	100	307	Average
7	2483.50	43.31	-10.69	54.00	41.32	32.30	5.38	35.70	100	307	Average
8	2483.50	54.53	-19.47	74.00	52.54	32.30	5.38	35.70	100	0	Peak
9	8865.00	55.75	-18.25	74.00	43.34	38.62	10.30	36.51	100	0	Peak
10	8865.00	36.88	-17.12	54.00	24.47	38.62	10.30	36.51	100	13	Average



Test Mode :	Mode 3	Temperature :	22~23°C
Test Channel :	11	Relative Humidity :	42~43%
Test Engineer :	Kay Wu	Polarization :	Vertical
Remark :	#3 and #4 are Fundamental Signals		

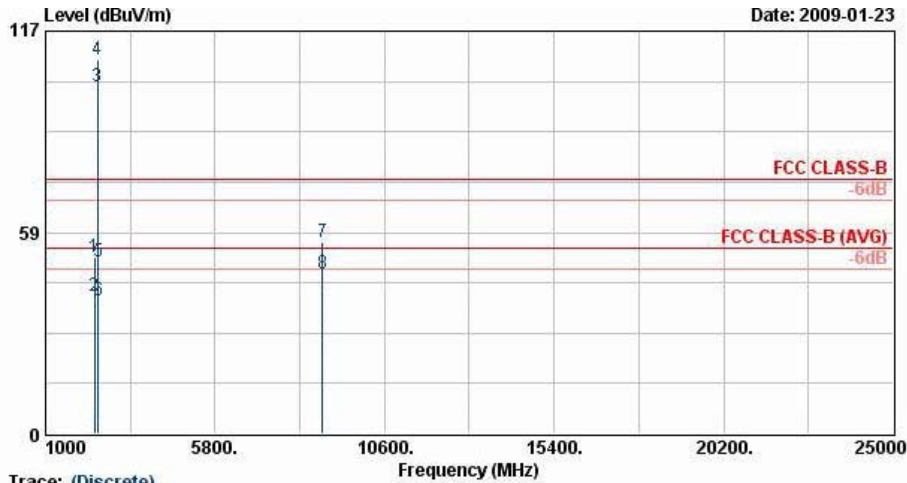

Trace: (Discrete)  
 Site : 03CH07-HY  
 Condition : 3m SHF-EHF HORN VERTICAL  
 Project : FR 912401  
 Mode : Mode 3

	Freq	Level	Over	Limit	Read	Antenna	Cable	Preamp	Ant	Table	Remark
	MHz	dBuV/m	dB	dBuV/m	dBuV	dB/m	dB	dB	cm	deg	
1	2380.00	51.17	-22.83	74.00	49.08	32.30	5.47	35.68	100	0	Peak
2	2380.00	39.96	-14.04	54.00	37.86	32.30	5.47	35.68	100	290	Average
3 @	2462.00	100.72			98.71	32.30	5.40	35.69	100	290	Average
4 X	2462.00	108.68			106.67	32.30	5.40	35.69	100	0	Peak
5	2483.50	49.94	-24.06	74.00	47.95	32.30	5.38	35.70	100	0	Peak
6	2483.50	38.81	-15.19	54.00	36.82	32.30	5.38	35.70	100	290	Average
7	8841.00	55.58	-18.42	74.00	44.29	37.50	10.29	36.50	100	0	Peak
8	8841.00	46.47	-7.53	54.00	35.18	37.50	10.29	36.50	100	311	Average



Test Mode :	Mode 4	Temperature :	22~23°C
Test Channel :	01	Relative Humidity :	42~43%
Test Engineer :	Kay Wu	Polarization :	Horizontal
Remark :	#5 and #6 are Fundamental Signals		

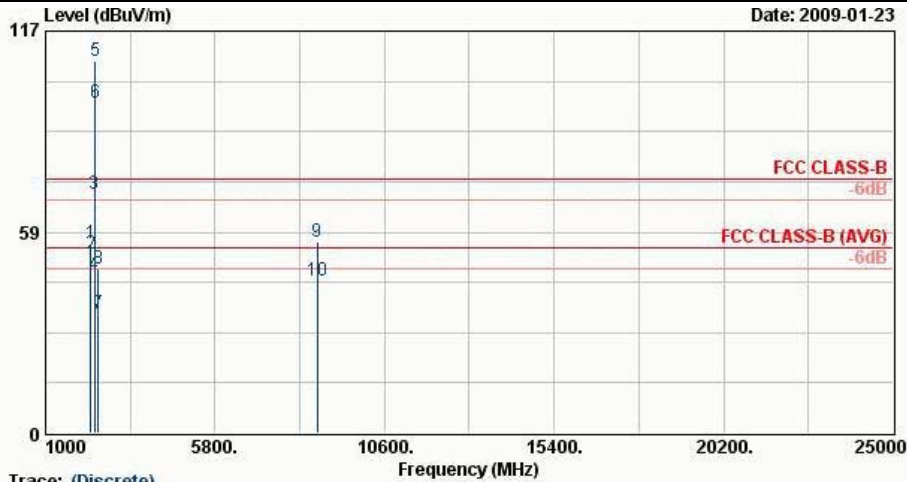

Trace: (Discrete)

Site : 03CH07-HY  
 Condition : 3m SHF-EHF HORN HORIZONTAL  
 Project : FR 912401  
 Mode : Mode 4

	Freq	Level	Over	Limit	Read	Antenna	Cable	Preamp	Ant	Table	Remark
	MHz	dBuV/m	dB	dBuV/m	dBuV	dB/m	dB	dB	cm	deg	
1	2286.00	55.28	-18.72	74.00	53.05	32.34	5.54	35.66	100	0	Peak
2 !	2286.00	52.05	-1.95	54.00	49.82	32.34	5.54	35.66	100	18	Average
3 !	2389.99	69.64	-4.36	74.00	67.54	32.32	5.46	35.68	100	0	Peak
4	2389.99	45.98	-8.02	54.00	43.88	32.32	5.46	35.68	105	307	Average
5 X	2412.00	108.40			106.32	32.32	5.44	35.68	100	0	Peak
6 @	2412.00	95.93			93.83	32.32	5.46	35.68	105	307	Average
7	2494.00	34.85	-19.15	54.00	32.88	32.30	5.37	35.70	105	307	Average
8	2494.00	47.83	-26.17	74.00	45.86	32.30	5.37	35.70	100	0	Peak
9	8694.00	55.51	-18.49	74.00	43.35	38.37	10.09	36.30	100	0	Peak
10	8694.00	44.32	-9.68	54.00	32.16	38.37	10.09	36.30	100	224	Average



Test Mode :	Mode 4	Temperature :	22~23°C
Test Channel :	01	Relative Humidity :	42~43%
Test Engineer :	Kay Wu	Polarization :	Vertical
Remark :	#5 and #6 are Fundamental Signals		

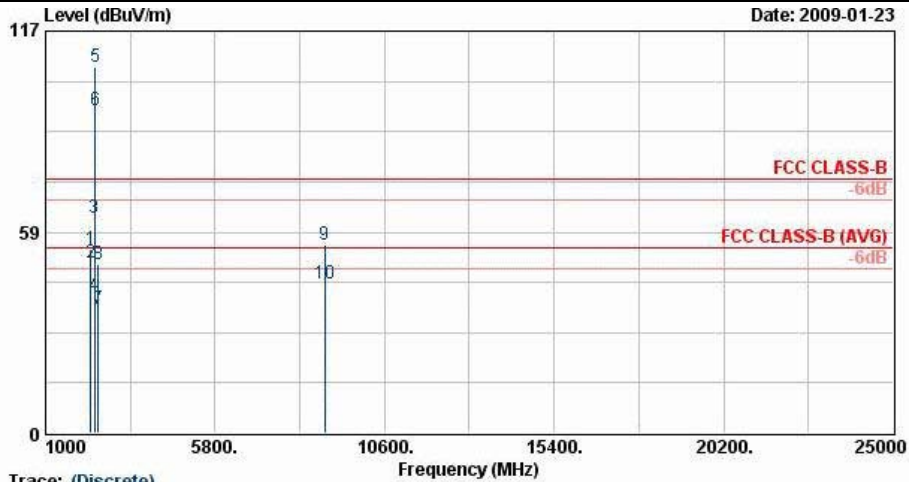

Trace: (Discrete)

Site : 03CH07-HY  
 Condition : 3m SHF-EHF HORN VERTICAL  
 Project : FR 912401  
 Mode : Mode 4

	Freq	Level	Over	Limit	Read	Antenna	Cable	Preamp	Ant	Table	Remark
	MHz	dBuV/m	dB	dBuV/m	dBuV	dB/m	dB	dB	cm	deg	
1	2286.00	53.42	-20.58	74.00	51.23	32.30	5.54	35.66	100	0	Peak
2 !	2286.00	49.71	-4.29	54.00	47.52	32.30	5.54	35.66	100	292	Average
3	2389.99	62.62	-11.38	74.00	60.54	32.30	5.46	35.68	100	0	Peak
4	2389.99	39.98	-14.02	54.00	37.90	32.30	5.46	35.68	117	69	Average
5 X	2412.00	106.59			104.53	32.30	5.44	35.68	100	0	Peak
6 @	2412.00	93.80			91.74	32.30	5.44	35.68	117	69	Average
7	2494.00	36.14	-17.86	54.00	34.17	32.30	5.37	35.70	117	69	Average
8	2494.00	49.03	-24.97	74.00	47.06	32.30	5.37	35.70	100	0	Peak
9	8913.00	54.69	-19.31	74.00	43.66	37.23	10.10	36.30	100	0	Peak
10	8913.00	43.46	-10.54	54.00	32.43	37.23	10.10	36.30	100	234	Average



Test Mode :	Mode 5	Temperature :	22~23°C
Test Channel :	06	Relative Humidity :	42~43%
Test Engineer :	Kay Wu	Polarization :	Horizontal
Remark :	#5 and #6 are Fundamental Signals		

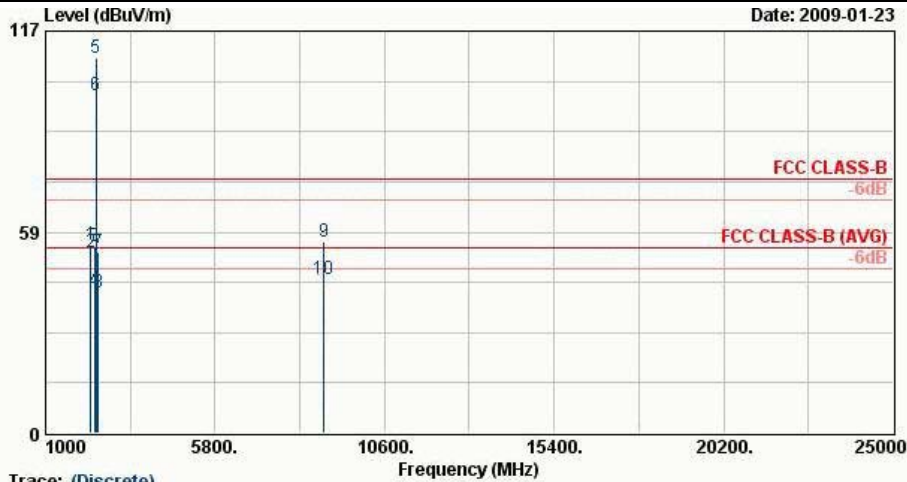

Trace: (Discrete)

Site : 03CH07-HY  
 Condition : 3m SHF-EHF HORN HORIZONTAL  
 Project : FR 912401  
 Mode : Mode 5

	Freq	Level	Over	Limit	Read	Antenna	Cable	Preamp	Ant	Table	Remark
	MHz	dBuV/m	dB	dBuV/m	dBuV	dB/m	dB	dB	cm	deg	
1	2286.00	54.91	-19.09	74.00	52.68	32.34	5.54	35.66	100	0	Peak
2 !	2286.00	52.44	-1.56	54.00	50.21	32.34	5.54	35.66	103	19	Average
3	2390.00	54.35	-19.65	74.00	52.26	32.32	5.46	35.68	100	0	Peak
4	2390.00	41.26	-12.74	54.00	39.16	32.32	5.46	35.68	100	309	Average
5 X	2437.00	109.24			107.20	32.31	5.41	35.69	100	0	Peak
6 @	2437.00	98.37			96.33	32.31	5.41	35.69	100	309	Average
7	2486.00	52.72	-21.28	74.00	50.73	32.30	5.38	35.70	100	0	Peak
8	2486.00	40.89	-13.11	54.00	38.90	32.30	5.38	35.70	100	309	Average
9	8874.00	55.62	-18.38	74.00	43.23	38.62	10.30	36.53	100	0	Peak
10	8874.00	44.83	-9.17	54.00	32.44	38.62	10.30	36.53	100	321	Average



Test Mode :	Mode 5	Temperature :	22~23°C
Test Channel :	06	Relative Humidity :	42~43%
Test Engineer :	Kay Wu	Polarization :	Vertical
Remark :	#5 and #6 are Fundamental Signals		

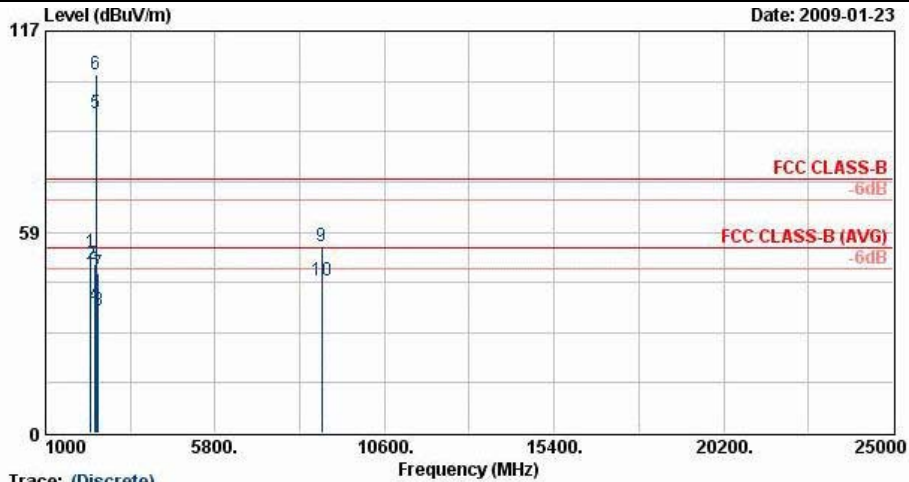

Trace: (Discrete)

Site : 03CH07-HY  
 Condition : 3m SHF-EHF HORN VERTICAL  
 Project : FR 912401  
 Mode : Mode 5

	Freq	Level	Over	Limit	Read	Antenna	Cable	Preamp	Ant	Table	Remark
	MHz	dBuV/m	dB	dBuV/m	dBuV	dB/m	dB	dB	cm	deg	
1	2286.00	52.52	-21.48	74.00	50.33	32.30	5.54	35.66	100	0	Peak
2 !	2286.00	49.28	-4.72	54.00	47.09	32.30	5.54	35.66	100	293	Average
3	2388.00	49.13	-24.87	74.00	47.05	32.30	5.46	35.68	100	0	Peak
4	2388.00	36.91	-17.09	54.00	34.83	32.30	5.46	35.68	101	287	Average
5 @	2437.00	93.18			91.15	32.30	5.41	35.69	101	287	Average
6 X	2437.00	104.55			102.51	32.30	5.43	35.69	100	0	Peak
7	2486.00	46.67	-27.33	74.00	44.68	32.30	5.38	35.70	100	0	Peak
8	2486.00	35.84	-18.16	54.00	33.85	32.30	5.38	35.70	101	287	Average
9	8817.00	54.46	-19.54	74.00	43.35	37.27	10.14	36.30	100	0	Peak
10	8817.00	44.39	-9.61	54.00	33.28	37.27	10.14	36.30	100	226	Average





Test Mode :	Mode 6	Temperature :	22~23°C
Test Channel :	11	Relative Humidity :	42~43%
Test Engineer :	Kay Wu	Polarization :	Horizontal
Remark :	#5 and #6 are Fundamental Signals		

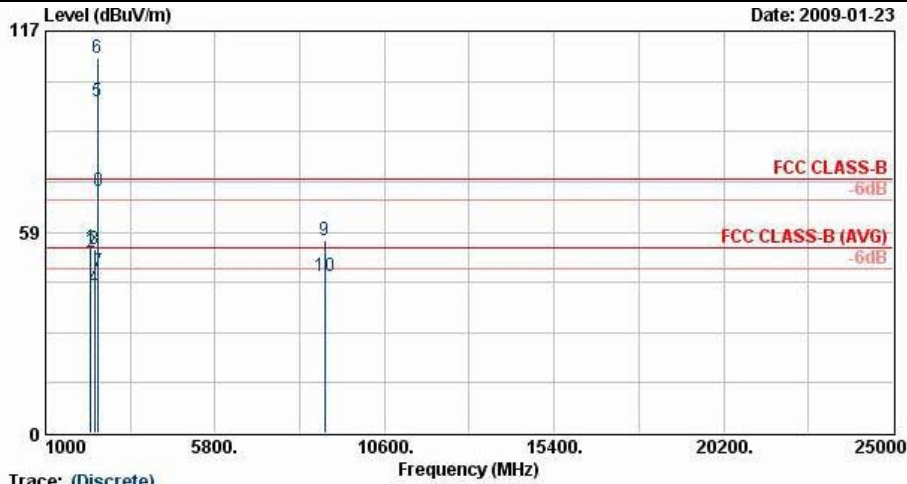

Trace: (Discrete)

Site : 03CH07-HY  
 Condition : 3m SHF-EHF HORN HORIZONTAL  
 Project : FR 912401  
 Mode : Mode 6

	Freq	Level	Over	Limit	Read	Antenna	Cable	Preamp	Ant	Table	Remark
	MHz	dBuV/m	dB	dBuV/m	dBuV	dB/m	dB	dB	cm	deg	
1	2286.00	54.07	-19.93	74.00	51.84	32.34	5.54	35.66	100	0	Peak
2 !	2286.00	52.60	-1.40	54.00	50.37	32.34	5.54	35.66	100	35	Average
3	2380.00	53.64	-20.36	74.00	51.52	32.32	5.47	35.68	100	0	Peak
4	2380.00	42.39	-11.61	54.00	40.27	32.32	5.47	35.68	100	309	Average
5 @	2462.00	96.52			94.50	32.31	5.40	35.69	100	309	Average
6 X	2462.00	109.26			107.24	32.31	5.40	35.69	100	0	Peak
7	2483.66	46.98	-7.02	54.00	44.99	32.30	5.38	35.70	100	309	Average
8 !	2483.66	70.50	-3.50	74.00	68.51	32.30	5.38	35.70	100	0	Peak
9	8898.00	56.14	-17.86	74.00	43.73	38.64	10.31	36.54	100	0	Peak
10	8898.00	45.70	-8.30	54.00	33.29	38.64	10.31	36.54	100	224	Average



Test Mode :	Mode 6	Temperature :	22~23°C
Test Channel :	11	Relative Humidity :	42~43%
Test Engineer :	Kay Wu	Polarization :	Vertical
Remark :	#5 and #6 are Fundamental Signals		

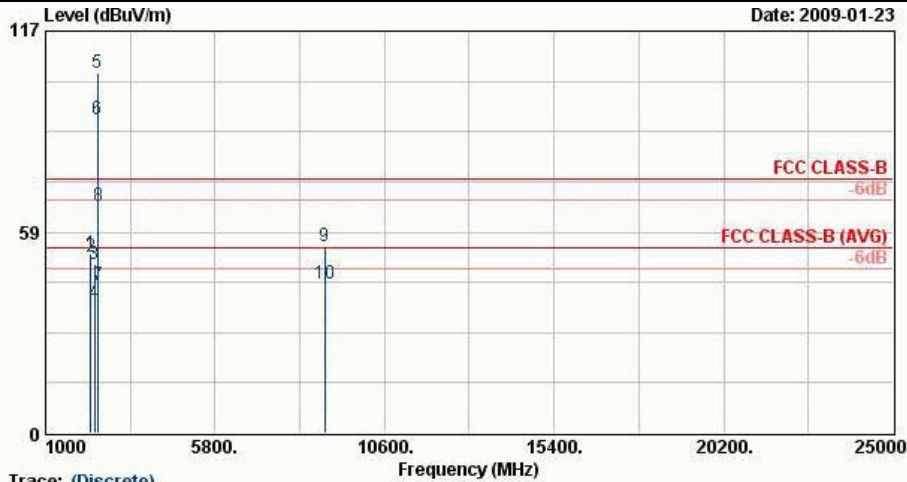

Trace: (Discrete)

Site : 03CH07-HY  
 Condition : 3m SHF-EHF HORN VERTICAL  
 Project : FR 912401  
 Mode : Mode 6

	Freq	Level	Over	Limit	Read	Antenna	Cable	Preamp	Ant	Table	Remark
	MHz	dBuV/m	dB	dBuV/m	dBuV	dB/m	dB	dB	cm	deg	
1	2286.00	52.29	-21.71	74.00	50.10	32.30	5.54	35.66	100	0	Peak
2 !	2286.00	51.14	-2.86	54.00	48.95	32.30	5.54	35.66	100	66	Average
3	2380.00	49.18	-24.82	74.00	47.08	32.30	5.47	35.68	100	0	Peak
4	2380.00	37.90	-16.10	54.00	35.80	32.30	5.47	35.68	100	336	Average
5 X	2462.00	104.74			102.73	32.30	5.40	35.69	100	0	Peak
6 @	2462.00	91.53			89.52	32.30	5.40	35.69	100	336	Average
7	2483.50	43.26	-10.74	54.00	41.27	32.30	5.38	35.70	100	336	Average
8	2483.50	65.93	-8.07	74.00	63.94	32.30	5.38	35.70	100	0	Peak
9	8901.00	54.36	-19.64	74.00	43.05	37.54	10.31	36.54	100	0	Peak
10	8901.00	43.69	-10.31	54.00	32.38	37.54	10.31	36.54	100	314	Average



## **3.2 Antenna Requirements**

### **3.2.1 Standard Applicable**

If directional gain of transmitting antennas is greater than 6dBi, the power shall be reduced by the same level in dB comparing to gain minus 6dBi. For the fixed point-to-point operation, the power shall be reduced by one dB for every 3 dB that the directional gain of the antenna exceeds 6 dBi.

The use of a permanently attached antenna or of an antenna that uses a unique coupling to the intentional radiator shall be considered sufficient to comply with the FCC rule.

### **3.2.2 Antenna Connected Construction**

The antennas type used in this product is Fixed Internal Antenna with HRS connector and it is considered to meet antenna requirement.

### **3.2.3 Antenna Gain**

The antenna peak gain of EUT is less than 6 dBi. Therefore, it is not necessary to reduce maximum peak output power limit.



### 4 List of Measuring Equipments

Instrument	Manufacturer	Model No.	Serial No.	Characteristics	Calibration Date	Due Date	Remark
Bilog Antenna	SCHAFFNER	CBL6111C	2726	30MHz~1GHz	Nov. 20, 2008	Nov. 19, 2009	Radiation (03CH07-HY)
Spectrum Analyzer	R&S	FSP	101067	9kHz~30GHz	Dec. 02, 2008	Dec. 01, 2009	Radiation (03CH07-HY)
Double Ridge Horn Antenna	ESCO	3117	75962	1G~18GHz	Aug. 13, 2008	Aug. 12, 2009	Radiation (03CH07-HY)
Pre Amplifier	Agilent	8449B	3008A01917	1G~26.5GHz	Dec. 17, 2008	Dec. 16, 2009	Radiation (03CH07-HY)
Pre Amplifier	COM-POWER	PA-103A	161241	10~1000MHz. 32dB.GAIN	Mar. 31, 2008	Mar. 30, 2009	Radiation (03CH07-HY)
Double Ridge Horn Antenna	ESCO	3117	66584	1G~18GHz	Aug. 06, 2008	Aug. 05, 2009	Radiation (03CH07-HY)
SHF-EHF Horn Antenna	SCHWARZBECK	BBHA 9170	BBHA9170251	15G - 40GHz	Oct. 16, 2008	Oct. 15, 2009	Radiation (03CH07-HY)
Band Notch filter	WI	2.4G Notch	N/A	2400/2483 MHz	N/A	N/A	Radiation (03CH07-HY)

## 5 Uncertainty of Evaluation

### Uncertainty of Radiated Emission Measurement (30MHz ~ 1000MHz)

Contribution	Uncertainty of $x_i$		$u(x_i)$
	dB	Probability Distribution	
Receiver reading	0.41	Normal(k=2)	0.21
Antenna factor calibration	0.83	Normal(k=2)	0.42
Cable loss calibration	0.25	Normal(k=2)	0.13
Pre Amplifier Gain calibration	0.27	Normal(k=2)	0.14
RCV/SPA specification	2.50	Rectangular	0.72
Antenna Factor Interpolation for Frequency	1.00	Rectangular	0.29
Site imperfection	1.43	Rectangular	0.83
Mismatch	+0.39/-0.41	U-shaped	0.28
<b>Combined standard uncertainty Uc(y)</b>	<b>1.27</b>		
<b>Measuring uncertainty for a level of confidence of 95% U=2Uc(y)</b>	<b>2.54</b>		

### Uncertainty of Radiated Emission Measurement (1GHz ~ 40GHz)

Contribution	Uncertainty of $x_i$		$u(x_i)$	$C_i$	$C_i * u(x_i)$
	dB	Probability Distribution			
Receiver reading	±0.10	Normal(k=1)	0.10	1	0.10
Antenna factor calibration	±1.70	Normal(k=2)	0.85	1	0.85
Cable loss calibration	±0.50	Normal(k=2)	0.25	1	0.25
Receiver Correction	±2.00	Rectangular	1.15	1	1.15
Antenna Factor Directional	±1.50	Rectangular	0.87	1	0.87
Site imperfection	±2.80	Triangular	1.14	1	1.14
Mismatch Receiver VSWR $\Gamma_1= 0.197$ Antenna VSWR $\Gamma_2= 0.194$ Uncertainty= $20\log(1-\Gamma_1*\Gamma_2)$	+0.34/-0.35	U-shaped	0.244	1	0.244
<b>Combined standard uncertainty Uc(y)</b>	<b>2.36</b>				
<b>Measuring uncertainty for a level of confidence of 95% U=2Uc(y)</b>	<b>4.72</b>				

## 6 Certification of TAF Accreditation



Certificate No. : L1190-081212

財團法人全國認證基金會  
Taiwan Accreditation Foundation

### Certificate of Accreditation

This is to certify that

**Sporton International Inc.**  
**EMC & Wireless Communications Laboratory**  
No.52, Hwa Ya 1st Rd., Hwa Ya Technology Park, Kwei-Shan Hsiang, Tao Yuan Hsien,  
Taiwan, R.O.C.

**is accredited in respect of laboratory**

<b>Accreditation Criteria</b>	: ISO/IEC 17025:2005
<b>Accreditation Number</b>	: 1190
<b>Originally Accredited</b>	: December 15, 2003
<b>Effective Period</b>	: January 10, 2007 to January 09, 2010
<b>Accredited Scope</b>	: Testing Field, see described in the Appendix
<b>Specific Accreditation Program</b>	: Accreditation Program for Designated Testing Laboratory for Commodities Inspection Accreditation Program for Telecommunication Equipment Testing Laboratory Accreditation Program for BSMI Mutual Recognition Arrangement with Foreign Authorities



Jay-San Chen  
President, Taiwan Accreditation Foundation  
Date : December 12, 2008

PI, total 18 pages

The Appendix forms an integral part of this Certificate, which shall be invalid when use without the Appendix



## **Appendix A. Photographs of EUT**

Please refer to Sporton report number EP912401 as below.