



<b>Prüfbericht-Nr.:</b> <i>Test report no.:</i>	CN23ML3X (P15C-WiFi) 001	<b>Auftrags-Nr.:</b> <i>Order no.:</i>	238549436	Seite 1 von 32 Page 1 of 32
<b>Kunden-Referenz-Nr.:</b> <i>Client reference no.:</i>	N/A	<b>Auftragsdatum:</b> <i>Order date:</i>	2022-12-21	
<b>Auftraggeber:</b> <i>Client:</i>	Acer Incorporated 8F, 88, Sec. 1, Xintai 5th Rd. Xizhi, New Taipei City 221 Taiwan			
<b>Prüfgegenstand:</b> <i>Test item:</i>	Predator Connect Wi-Fi Router			
<b>Bezeichnung / Typ-Nr.:</b> <i>Identification / Type no.:</i>	W6d			
<b>Auftrags-Inhalt:</b> <i>Order content:</i>	FCC Part 15C Test report (WiFi 2.4GHz)			
<b>Prüfgrundlage:</b> <i>Test specification:</i>	FCC 47CFR Part 15: Subpart C Section 15.247			
<b>Wareneingangsdatum:</b> <i>Date of sample receipt:</i>	2022-10-26			
<b>Prüfmuster-Nr.:</b> <i>Test sample no.:</i>	A003360434-017 A003360434-026			
<b>Prüfzeitraum:</b> <i>Testing period:</i>	2022-12-13 - 2023-03-02			
<b>Ort der Prüfung:</b> <i>Place of testing:</i>	EMC/RF Taipei Testing Site			
<b>Prüflaboratorium:</b> <i>Testing laboratory:</i>	Taipei Testing Laboratories			
<b>Prüfergebnis*:</b> <i>Test result*:</i>	Pass			
<b>überprüft von:</b> <i>compiled by:</i>	 Ethan Shao	<b>genehmigt von:</b> <i>authorized by:</i>	 Brenda Chen	
<b>Datum:</b> <i>Date:</i>	2023-03-15	<b>Ausstellungsdatum:</b> <i>Issue date:</i>	2023-03-15	
<b>Stellung / Position:</b>	Assistant Project Engineer	<b>Stellung / Position:</b>	Senior Project Manager	
<b>Sonstiges / Other:</b>				
<b>Zustand des Prüfgegenstandes bei Anlieferung:</b> <i>Condition of the test item at delivery:</i>		Prüfmuster vollständig und unbeschädigt <i>Test item complete and undamaged</i>		
* Legende:	1 = sehr gut P(ass) = entspricht o.g. Prüfgrundlage(n)	2 = gut F(ail) = entspricht nicht o.g. Prüfgrundlage(n)	3 = befriedigend N/A = nicht anwendbar	4 = ausreichend N/T = nicht getestet
* Legend:	1 = very good P(ass) = passed a.m. test specification(s)	2 = good F(ail) = failed a.m. test specification(s)	3 = satisfactory N/A = not applicable	4 = sufficient N/T = not tested
<p><b>Dieser Prüfbericht bezieht sich nur auf das o.g. Prüfmuster und darf ohne Genehmigung der Prüfstelle nicht auszugsweise vervielfältigt werden. Dieser Bericht berechtigt nicht zur Verwendung eines Prüfzeichens.</b> <i>This test report only relates to the a. m. test sample. Without permission of the test center this test report is not permitted to be duplicated in extracts. This test report does not entitle to carry any test mark.</i></p>				

## TEST SUMMARY

Report Section	FCC Clause	Test Item	Result
5.1.1	15.247(b) & 15.203	Antenna Requirement	Pass
5.1.2	15.247(b)(3)	Peak Output Power	Pass
5.1.3	15.247(a)(2)	6 dB Bandwidth	Pass
5.1.3	2.1049	99% Occupied Bandwidth	Pass
5.1.4	15.247(e)	Power Spectral Density	Pass
5.1.5	15.247(d)	Conducted Spurious Emissions and Band Edges	Pass
5.1.6	15.247(d) & 15.205 & 15.209	Radiated Spurious Emissions and Band Edges	Pass
5.2.1	15.207	Mains Conducted Emission	Pass

**Note:** Determining compliance based on the results of the compliance measurement, not taking into account measurement instrumentation uncertainty.

## Contents

<b>HISTORY OF THIS TEST REPORT .....</b>	<b>5</b>
<b>1. GENERAL REMARKS .....</b>	<b>6</b>
<b>1.1 COMPLEMENTARY MATERIALS.....</b>	<b>6</b>
<b>1.2 DECISION RULE OF CONFORMITY .....</b>	<b>6</b>
<b>2. TEST SITES .....</b>	<b>7</b>
<b>2.1 TEST LABORATORY .....</b>	<b>7</b>
<b>2.2 TEST FACILITY.....</b>	<b>7</b>
<b>2.3 TRACEABILITY .....</b>	<b>8</b>
<b>2.4 CALIBRATION .....</b>	<b>8</b>
<b>2.5 MEASUREMENT UNCERTAINTY .....</b>	<b>8</b>
<b>3. GENERAL PRODUCT INFORMATION.....</b>	<b>9</b>
<b>3.1 PRODUCT FUNCTION AND INTENDED USE .....</b>	<b>9</b>
<b>3.2 SYSTEM DETAILS AND RATINGS.....</b>	<b>9</b>
<b>3.3 NOISE GENERATING AND NOISE SUPPRESSING PARTS .....</b>	<b>10</b>
<b>3.4 SUBMITTED DOCUMENTS.....</b>	<b>10</b>
<b>4. TEST SET-UP AND OPERATION MODES.....</b>	<b>11</b>
<b>4.1 PRINCIPLE OF CONFIGURATION SELECTION .....</b>	<b>11</b>
<b>4.2 CARRIER FREQUENCY AND CHANNEL.....</b>	<b>12</b>
<b>4.3 TEST OPERATION AND TEST SOFTWARE.....</b>	<b>13</b>
<b>4.4 SPECIAL ACCESSORIES AND AUXILIARY EQUIPMENT .....</b>	<b>15</b>
<b>4.5 TEST SETUP DIAGRAM .....</b>	<b>15</b>
<b>4.6 DUTY CYCLE OF TEST SIGNAL .....</b>	<b>17</b>
<b>5. TEST RESULTS .....</b>	<b>19</b>
<b>5.1 TRANSMITTER REQUIREMENT &amp; TEST SUITES.....</b>	<b>19</b>
5.1.1 <i>Antenna Requirement .....</i>	<i>19</i>
5.1.2 <i>Peak Output Power .....</i>	<i>20</i>
5.1.3 <i>6 dB Bandwidth and 99% Occupied Bandwidth.....</i>	<i>23</i>
5.1.4 <i>Power Spectral Density.....</i>	<i>24</i>
5.1.5 <i>Conducted Spurious Emissions and Frequency Band Edges Measured in 100 kHz Bandwidth.....</i>	<i>25</i>
5.1.6 <i>Radiated Spurious Emissions and Band Edges .....</i>	<i>26</i>
<b>5.2 MAINS EMISSION .....</b>	<b>31</b>
5.2.1 <i>Mains Conducted Emission.....</i>	<i>31</i>

**Prüfbericht - Nr.: CN23ML3X (P15C-WiFi) 001**

*Test Report No.*

**Seite 4 von 32**  
*Page 4 of 32*

**APPENDIX A - TEST RESULT OF CONDUCTED\_CDD**

**APPENDIX B - TEST RESULT OF CONDUCTED\_BEAMFORMING**

**APPENDIX C - TEST RESULT OF RADIATED EMISSIONS & MAINS CONDUCTED  
EMISSION\_CDD**

**APPENDIX D - TEST RESULT OF RADIATED EMISSIONS\_BEAMFORMING**

**APPENDIX SP - PHOTOGRAPHS OF TEST SETUP**

**APPENDIX EP - PHOTOGRAPHS OF EUT**

**Prüfbericht - Nr.: CN23ML3X (P15C-WiFi) 001**  
Test Report No.

**Seite 5 von 32**  
Page 5 of 32

## HISTORY OF THIS TEST REPORT

Report No.	Description	Date Issued
CN23ML3X (P15C-WiFi) 001	Original Release	2023-03-15

## 1. General Remarks

### 1.1 Complementary Materials

All attachments are integral parts of this test report. This applies especially to the following appendix:

**Appendix A - Test Result of Conducted\_CDD**

**Appendix B - Test Result of Conducted\_Beamforming**

**Appendix C - Test Result of Radiated Emissions & Mains Conducted Emission\_CDD**

**Appendix D - Test Result of Radiated Emissions\_Beamforming**

**Appendix SP - Photographs of Test Setup**

**Appendix EP - Photographs of EUT**

### Applied Standard and Test Levels

Radio
FCC 47CFR Part 15: Subpart C Section 15.247
FCC 47CFR Part 2: Subpart J Section 2.1049
ANSI C63.10:2013
KDB 558074 D01 15.247 Meas Guidance v05r02
KDB 662911 D01 Multiple Transmitter Output v02r01

### 1.2 Decision Rule of Conformity

The decision rule of conformity of this test report is following the requirements of the requested standard in the quotation, and agreed among testing laboratory and manufacturer (applicant) to exclude the consideration of Measurement Uncertainty, unless it is required by the specific standard.

## 2. Test Sites

### 2.1 Test Laboratory

Taipei Testing Laboratories

11F. No.758, Sec. 4, Bade Rd., Songshan Dist.  
Taipei City 105  
Taiwan (R.O.C.)

### 2.2 Test Facility

Taipei Testing Laboratories

No.458-18, Sec. 2, Fenliao Rd., Linkou Dist.,  
New Taipei City 244  
Taiwan (R.O.C.)  
FCC Registration No.: 180491  
ISED Registration No.: 25563

## 2.3 Traceability

All measurement equipment calibrations are traceable to NML(Taiwan)/NIST(USA) or where calibration is performed outside Taiwan, to equivalent nationally recognized standards organizations.

## 2.4 Calibration

Equipment requiring calibration is calibrated periodically in a suitably accredited Calibration Lab. Additionally all equipment is verified for proper performance on a regular basis using in house standards or comparisons.

## 2.5 Measurement Uncertainty

All measurement uncertainty values are shown with a coverage factor of  $k=2$  to indicate a 95% level of confidence.

### Emission Measurement Uncertainty

Parameter	Uncertainty
Radiated Emission (9 kHz ~ 30 MHz)	$\pm 1.15$ dB
Radiated Emission (30 MHz ~ 200 MHz)	$\pm 1.30$ dB
Radiated Emission (200 MHz ~ 1 GHz)	$\pm 1.30$ dB
Radiated Emission (1 GHz ~ 18 GHz)	$\pm 1.54$ dB
Radiated Emission (18 GHz ~ 40 GHz)	$\pm 2.52$ dB
Mains Conducted Emission	$\pm 1.65$ dB



### 3. General Product Information

#### 3.1 Product Function and Intended Use

The EUT is a Predator Connect Wi-Fi Router. It contains a WLAN compatible module enabling the user to communicate data through a Wireless interface.

For details refer to the User Guide, Data Sheet and Circuit Diagram.

#### 3.2 System Details and Ratings

##### Basic Information of EUT

Item	EUT information
Kind of Equipment/Test Item	Predator Connect Wi-Fi Router
Type Identification	W6d
FCC ID	HLZW6D

##### Technical Specification of EUT

Item	EUT information	
Operating Frequency	2412 MHz ~ 2462 MHz	
Channel Number	802.11b/g/n/ax HT20/HE20: 11 802.11n/ax HT40/HE40: 7	
Data Rate	802.11b: 11.0 / 5.5 / 2.0 / 1.0 Mbps 802.11g: 54.0 / 48.0 / 36.0 / 24.0 / 18.0 / 12.0 / 9.0 / 6.0 Mbps 802.11n/ax: up to MCS11	
Operation Voltage	Adapter input 100-240 Vac, output 12 Vdc	
Modulation	DSSS (DBPSK, DQPSK, CCK) OFDM (BPSK, QPSK, 16QAM, 64QAM, 256QAM) OFDMA (1024QAM)	
Maximum Output Power (mW)	CDD Mode	802.11b: 431.51
		802.11g: 518.26
		802.11n HT20: 424.77
		802.11n HT40: 221.51
		802.11ax HE20: 443.66
	802.11ax HE40: 228.47	
	Beamforming Mode	802.11ax HE20: 250.31
		802.11ax HE40: 260.16
Antenna Information	Refer to 5.1.1	
Accessory Device	Refer to 4.4	

### 3.3 Noise Generating and Noise Suppressing Parts

Refer to the Circuit Diagram.

### 3.4 Submitted Documents

- Circuit Diagram
- Instruction Manual
- Rating Label
- Technical Description

## 4. Test Set-up and Operation Modes

### 4.1 Principle of Configuration Selection

The test modes were adapted accordingly in reference to the instructions for use.

During testing, Channel and Power Controlling Software provided by the customer was used to control the operating channel as well as the output power level. The RF output power selection is for the setting of RF output expected by the customer and is going to be fixed on the firmware of the final end product.

**Table for Parameters of Test Software Setting**

CDD							
802.11b		802.11g		802.11n HT20 802.11ax HE20		802.11n HT40 802.11ax HE40	
Channel	Power Setting	Channel	Power Setting	Channel	Power Setting	Channel	Power Setting
1	13.5	1	14	1	13.5	3	11.5
6	15	2	16	2	15	4	11.5
11	13	6	17.5	6	17	5	12
		10	15.5	9	15	6	14
		11	13.5	10	14.5	8	12
				11	13.5	9	11.5
Beamforming							
802.11ax HE20		802.11ax HE40					
Channel	Power Setting	Channel	Power Setting				
1	27	3	22				
6	29	4	25				
11	27	6	29				
		9	25				

## 4.2 Carrier Frequency and Channel

802.11b, 802.11g, 802.11n HT20, 802.11ax HE20:

Channel	Frequency (MHz)	Channel	Frequency (MHz)
1	2412	8	2447
2	2417	9	2452
3	2422	10	2457
4	2427	11	2462
5	2432		
6	2437		
7	2442		

802.11n HT40, 802.11ax HE40:

Channel	Frequency (MHz)	Channel	Frequency (MHz)
3	2422	7	2442
4	2427	8	2447
5	2432	9	2452
6	2437		

### 4.3 Test Operation and Test Software

Setup for testing: Test samples are provided with LAN interface which makes it possible to control them through a test software installed on a notebook computer.

This software was running on the laptop computer connected to the EUT. It was used to enable the operation modes listed as below.

Test Software	MT7986 QA 0.0.28 for Test mode MTK commend for Beamforming
---------------	---

The samples were used as follows:

A003360434-017

A003360434-026

Full test was applied on all test modes, but only worst case was shown.

The EUT incorporates a MIMO function. Physically, the EUT provides four completed transmitters and receivers.

Modulation Mode	Tx Function
802.11b	4TX (MIMO)
802.11g	4TX (MIMO)
802.11n HT20	4TX (MIMO)
802.11n HT40	4TX (MIMO)
802.11ax HE20	4TX (MIMO)
802.11ax HE40	4TX (MIMO)

\* The modulation and bandwidth are similar for 802.11n mode HT20/HT40 and 802.11ax HE20/HE40, therefore, only investigated worse case as representative mode in test report.

EUT Configure Mode	Applicable To				Description
	Antenna Port Conducted Measurement	Radiated Spurious Emissions above 1 GHz	Radiated Spurious Emissions below 1 GHz	Mains Conducted Emission	
-	√	√	√	√	-

Note:

1. The EUT had been pre-tested on the positioned of each 3 axis. The worst case was found when position on **Y-plane**.
2. "-" means no effect.

#### Antenna Port Conducted Measurement

- Pre-Scan full test was applied on all test modes, but only worst case was shown.
- Following channel(s) was (were) selected for the final test as listed below.

EUT Configure Mode	Mode	Available Channel	Tested Channel	Date Rate (Mbps)
CDD	802.11b	1 to 11	1, 6, 11	1.0
	802.11g	1 to 11	1, 2, 6, 10, 11	6.0
	802.11n HT20 (Power only)	1 to 11	1, 2, 6, 9, 10, 11	MCS0
	802.11n HT40 (Power only)	3 to 9	3, 4, 5, 6, 8, 9	MCS0
	802.11ax HE20	1 to 11	1, 2, 6, 9, 10, 11	NSS1 MCS0
	802.11ax HE40	3 to 9	3, 4, 5, 6, 8, 9	NSS1 MCS0
Beamforming	802.11ax HE20	1 to 11	1, 6, 11	NSS1 MCS0
	802.11ax HE40	3 to 9	3, 4, 6, 9	NSS1 MCS0

**Radiated Spurious Emissions (Above 1 GHz)**

- Pre-Scan full test was applied on all test modes, but only worst case was shown.  
 Following channel(s) was (were) selected for the final test as listed below.

EUT Configure Mode	Mode	Available Channel	Tested Channel	Date Rate (Mbps)
CDD	802.11b	1 to 11	1, 6, 11	1.0
	802.11g	1 to 11	1, 6, 11	6.0
	802.11ax HE20	1 to 11	1, 6, 11	NSS1 MCS0
	802.11ax HE40	3 to 9	3, 6, 9	NSS1 MCS0
Beamforming	802.11ax HE20	1 to 11	1, 6, 11	NSS1 MCS0
	802.11ax HE40	3 to 9	3, 6, 9	NSS1 MCS0

**Radiated Spurious Emissions (Below 1 GHz)**

- Pre-Scan full test was applied on all test modes, but only worst case was shown.  
 Following channel(s) was (were) selected for the final test as listed below.

EUT Configure Mode	Mode	Available Channel	Tested Channel	Date Rate (Mbps)
CDD	802.11b	1 to 11	1	1.0
Beamforming	802.11ax HE40	3 to 9	3	NSS1 MCS0

**Mains Conducted Emission**

- Pre-Scan full test was applied on all test modes, but only worst case was shown.  
 Following channel(s) was (were) selected for the final test as listed below.

EUT Configure Mode	Mode
EUT with Adapter 1	WLAN 2.4 GHz + WLAN 5 GHz
EUT with Adapter 2	WLAN 2.4 GHz + WLAN 5 GHz

**Test Condition**

Test Item	Ambient Temperature	Relative Humidity	Tested by
Conducted Measurement	16-25 °C	40-62 %	Nick Guan
Radiated Spurious Emissions above 1 GHz	23.4-24.9 °C	61-63 %	Ray Huang
Radiated Spurious Emissions below 1 GHz	23.4-24.9 °C	61-63 %	Ray Huang
Mains Conducted Emission	21.6 °C	54.9 %	Ray Huang

## 4.4 Special Accessories and Auxiliary Equipment

The product has been tested together with the following additional accessories:

### Accessory of EUT

No.	Product	Brand	Model	Description
A	Adapter 1	Asian	WB-24M12FU	I/P: 100-240 Vac, 50/60 Hz, 0.7 A O/P: 12 Vdc, 2 A
B	Adapter 2	Asian	WA-36W12FU	I/P: 100-240 Vac, 50/60 Hz, 0.9 A O/P: 12 Vdc, 3 A

### Support Unit

Support Unit								
No	Description	Brand	Model	S/N	Shielded	Ferrite Core (Qty)	Length (cm)	Remark
1	LAN Cable	TUV	TUV-001	NO	NO	NO	300	Radiated
2	Notebook	HP	15s-du0007TX	CND93662WV	-	-	-	
1	Notebook	Lenovo	81BL	MP1DCD6Y	-	-	-	Mains Conducted
2	LAN Cable	TUV	TUV-01	NO	NO	NO	300	

## 4.5 Test Setup Diagram

<Radiated Spurious Emissions mode>

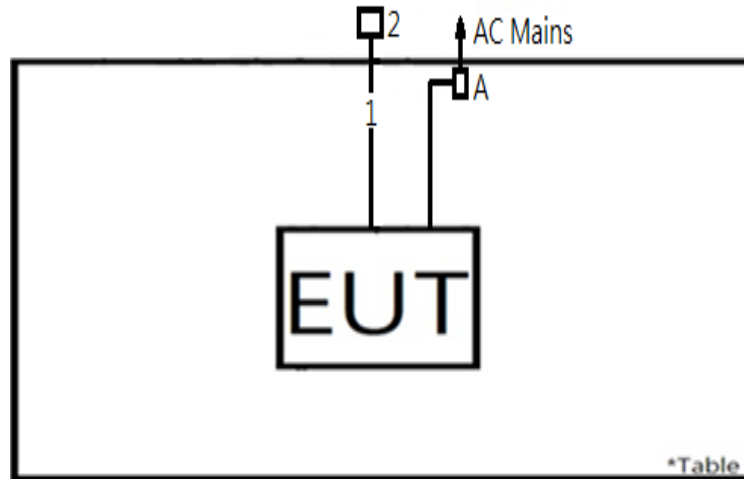

<Mains Conducted Emission mode>

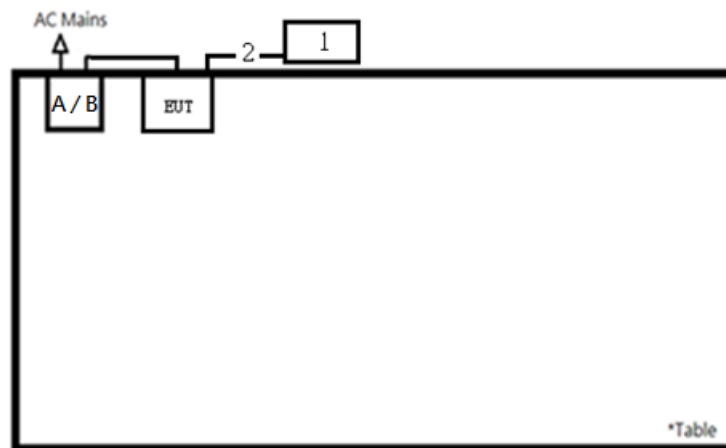



## 4.6 Duty Cycle of Test Signal

Mode	Band	On + Off Time (ms)	On Time (ms)	Duty Cycle (%)	Duty Factor (dB)
CDD	802.11b	8.48	8.42	99.29	0.03
	802.11g	1.46	1.40	95.88	0.18
	802.11ax HE20	0.52	0.47	88.93	0.51
	802.11ax HE40	0.48	0.42	87.92	0.56
Beamforming	802.11ax HE20	3.81	3.78	99.21	0.03
	802.11ax HE40	2.21	1.93	87.30	0.59

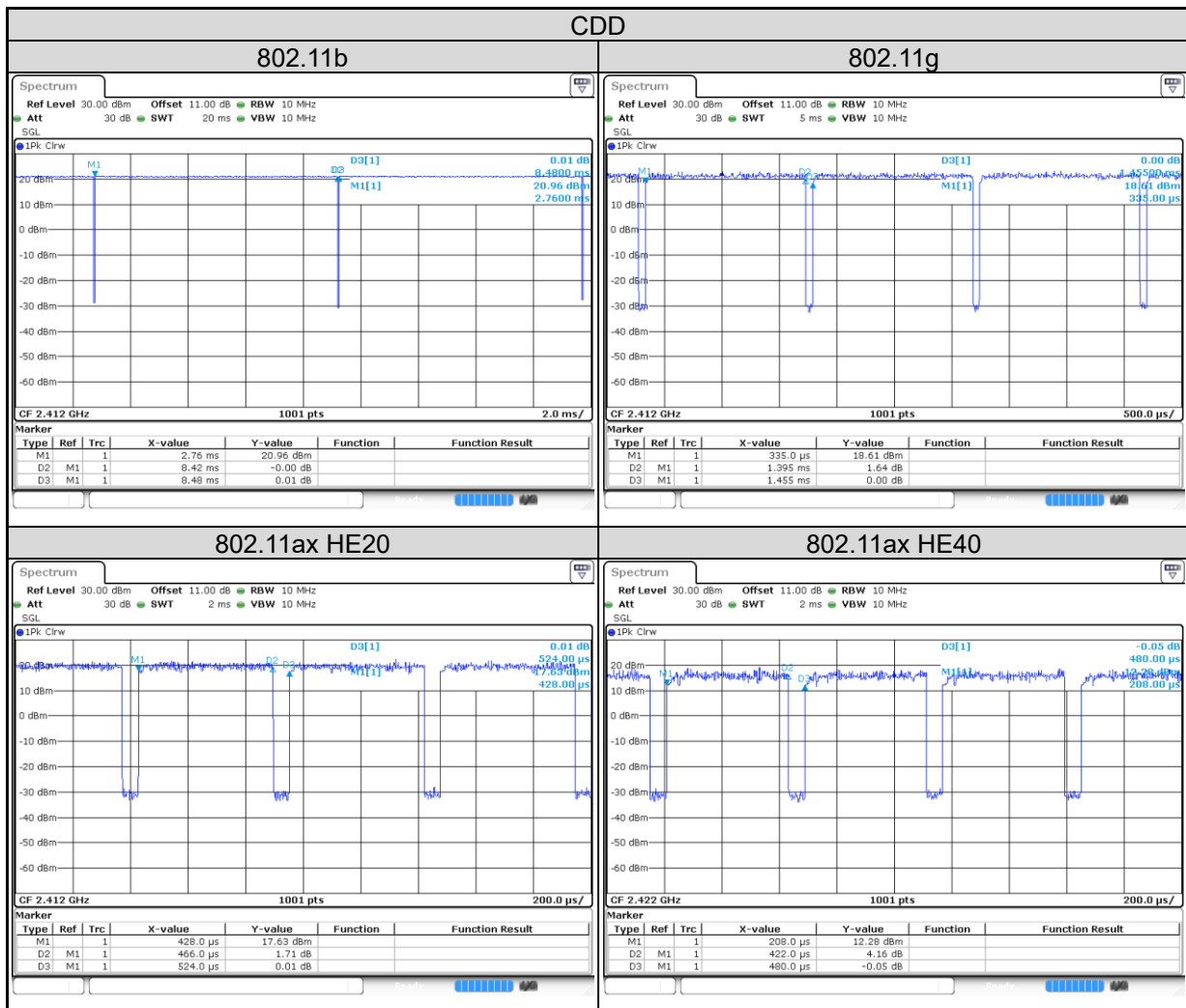

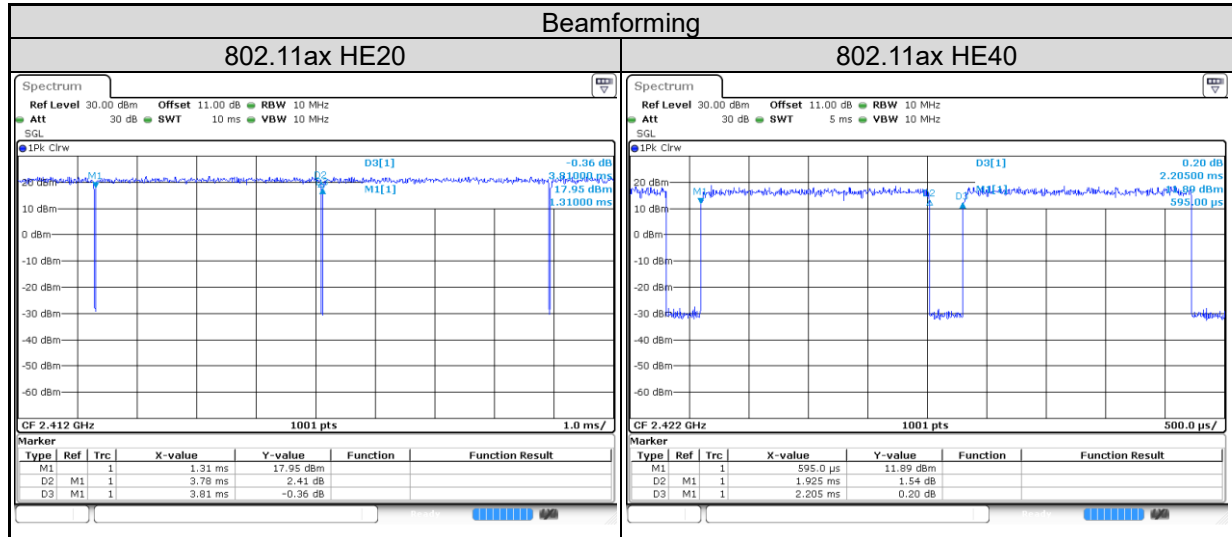

## 5. Test Results

### 5.1 Transmitter Requirement & Test Suites

#### 5.1.1 Antenna Requirement

**Requirement** Use of approved antennas only

The gain value is derived from Antenna datasheet, the EUT's antenna specifications are described as below. The antenna is used with no possibility of replacement with a non-approved antenna by the end-user. Therefore, the EUT is considered to comply with this provision.

ANT		Gain (dBi)	Antenna Type
0		4.68	Dipole
1		3.98	Dipole
2		4.66	Dipole
3		4.94	Dipole
Max Peak Gain		4.94	-
CDD Mode	Power Directional Gain	4.94	-
	PSD Directional Gain	10.59	-
Beamforming Mode	Power Directional Gain	10.59	-
	PSD Directional Gain	10.59	-

Note: PSD Directional Gain =  $10\log[(10^{G1/20} + 10^{G2/20} + \dots + 10^{GN/20})^2 / N_{ANT}]$

Refer to EUT photo for details.

### 5.1.2 Peak Output Power

**Limit** 1 watt (30 dBm)

**Kind of Test Site** Shielded room

**Test Setup**

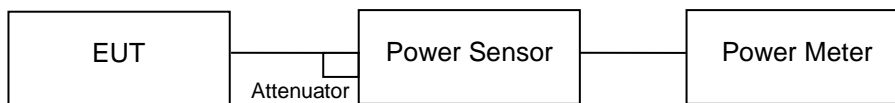

**Test Instruments**

Kind of Equipment	Manufacturer	Type	S/N	Calibration Date	Calibration Due Date	Test Date	
						From	Until
Power Meter	Anritsu	ML2495A	1901008	2022/3/15	2023/3/14	2022/12/13	2023/3/2
Power Sensor	Anritsu	MA2411B	1725269	2022/3/15	2023/3/14	2022/12/13	2023/3/2

**Test Procedures**

Average power sensor was used to perform output power measurement, trigger and gating function of wide band power meter is enabled to measure max output power of TX on burst. Duty factor is not added to measured value.

**Test Result**
**Average Output Power**
**CDD Mode**
**<802.11b>**

Channel	Channel Frequency (MHz)	Average Output Power (dBm)				Total Power		Limit (dBm)
		Chain 0	Chain1	Chain 2	Chain 3	(dBm)	(mW)	
1	2412	18.80	18.98	19.04	18.89	24.95	312.54	30
6	2437	20.06	20.36	20.60	20.28	26.35	431.51	30
11	2462	18.45	18.39	18.55	18.09	24.39	275.04	30

**<802.11g>**

Channel	Channel Frequency (MHz)	Average Output Power (dBm)				Total Power		Limit (dBm)
		Chain 0	Chain1	Chain 2	Chain 3	(dBm)	(mW)	
1	2412	17.71	17.80	18.03	17.76	23.85	242.51	30
2	2417	19.65	19.77	20.01	19.78	25.83	382.39	30
6	2437	20.92	21.17	21.32	21.08	27.15	518.26	30
10	2457	19.02	19.28	19.38	18.92	25.17	329.20	30
11	2462	16.98	17.34	17.45	16.95	23.21	209.22	30

**<802.11n HT20>**

Channel	Channel Frequency (MHz)	Average Output Power (dBm)				Total Power		Limit (dBm)
		Chain 0	Chain1	Chain 2	Chain 3	(dBm)	(mW)	
1	2412	17.01	17.02	17.28	17.03	23.11	204.51	30
2	2417	18.38	18.25	18.46	18.39	24.39	274.87	30
6	2437	20.05	20.38	20.47	20.13	26.28	424.77	30
9	2452	18.06	18.42	18.66	18.08	24.33	271.20	30
10	2457	17.48	17.77	18.02	17.51	23.72	235.57	30
11	2462	16.48	16.82	16.86	16.40	22.67	184.73	30

**<802.11n HT40>**

Channel	Channel Frequency (MHz)	Average Output Power (dBm)				Total Power		Limit (dBm)
		Chain 0	Chain1	Chain 2	Chain 3	(dBm)	(mW)	
3	2422	15.02	15.05	15.37	15.01	21.14	129.89	30
4	2427	14.89	15.03	15.26	15.02	21.07	128.02	30
5	2432	15.42	15.59	15.63	15.44	21.54	142.61	30
6	2437	17.29	17.52	17.66	17.25	23.45	221.51	30
8	2447	15.29	15.47	15.59	15.22	21.42	138.53	30
9	2452	14.73	14.92	15.12	14.68	20.89	122.65	30

**<802.11ax HE20>**

Channel	Channel Frequency (MHz)	Average Output Power (dBm)				Total Power		Limit (dBm)
		Chain 0	Chain1	Chain 2	Chain 3	(dBm)	(mW)	
1	2412	17.13	17.25	17.40	17.22	23.27	212.41	30
2	2417	18.60	18.47	18.65	18.58	24.60	288.14	30
6	2437	20.28	20.53	20.64	20.34	26.47	443.66	30
9	2452	18.22	18.61	18.76	18.27	24.49	281.29	30
10	2457	17.69	18.02	18.24	17.68	23.93	247.43	30
11	2462	16.61	16.97	17.04	16.56	22.82	191.46	30

**<802.11ax HE40>**

Channel	Channel Frequency (MHz)	Average Output Power (dBm)				Total Power		Limit (dBm)
		Chain 0	Chain1	Chain 2	Chain 3	(dBm)	(mW)	
3	2422	15.18	15.26	15.46	15.15	21.28	134.42	30
4	2427	15.10	15.23	15.41	15.18	21.25	133.42	30
5	2432	15.58	15.69	15.85	15.64	21.71	148.31	30
6	2437	17.43	17.65	17.77	17.41	23.59	228.47	30
8	2447	15.47	15.65	15.85	15.40	21.62	145.10	30
9	2452	14.90	15.12	15.29	14.85	21.06	127.77	30

**Beamforming Mode**
**<802.11ax HE20>**

Channel	Channel Frequency (MHz)	Average Output Power (dBm)				Total Power		Limit (dBm)
		Chain 0	Chain1	Chain 2	Chain 3	(dBm)	(mW)	
1	2412	16.99	17.04	17.20	17.08	23.10	204.12	25.41
6	2437	17.87	18.05	18.11	17.82	23.98	250.31	25.41
11	2462	16.55	16.79	16.83	16.49	22.69	185.70	25.41

**<802.11ax HE40>**

Channel	Channel Frequency (MHz)	Average Output Power (dBm)				Total Power		Limit (dBm)
		Chain 0	Chain1	Chain 2	Chain 3	(dBm)	(mW)	
3	2422	14.74	14.85	15.01	14.71	20.85	121.61	25.41
4	2427	16.09	16.23	16.44	16.13	22.25	167.70	25.41
6	2437	18.01	18.16	18.32	18.03	24.15	260.16	25.41
9	2452	16.04	16.27	16.43	15.86	22.18	165.05	25.41

### 5.1.3 6 dB Bandwidth and 99% Occupied Bandwidth

**Limit** The minimum 6 dB bandwidth shall be at least 500 kHz.

**Kind of Test Site** Shielded room

#### Test Setup

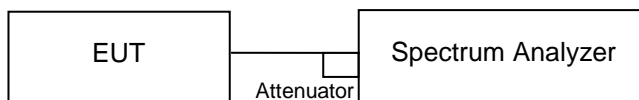

#### Test Instruments

Kind of Equipment	Manufacturer	Type	S/N	Calibration Date	Calibration Due Date	Test Date	
						From	Until
Spectrum Analyzer	R&S	FSV40	100921	2022/7/7	2023/7/6	2022/12/13	2023/3/2

#### Test Procedure

- Set resolution bandwidth (RBW) = 100 kHz
- Set the video bandwidth (VBW)  $\geq 3 \times$  RBW, Detector = Peak.
- Trace mode = max hold.
- Sweep = auto couple.
- Measure the maximum width of the emission that is constrained by the frequencies associated with the two amplitude points (upper and lower) that are attenuated by 6 dB relative to the maximum level measured in the fundamental emission.
- For 99% occupied bandwidth measurement, the transmitter output was connected to the spectrum analyzer through an attenuator. The bandwidth of the fundamental frequency was measured by spectrum analyzer with resolution bandwidth in the range of 1% to 5% of the anticipated emission bandwidth, and a video bandwidth at least 3x the resolution bandwidth and set the detector to PEAK. The width of a frequency band such that, below the lower and above the upper frequency limits, the mean powers emitted are each equal to a specified percentage 0.5% of the total mean power of a given emission.

#### Test Results

Please refer to Appendix A~B.

### 5.1.4 Power Spectral Density

#### Limit

The power spectral density shall not be greater than 8 dBm in any 3 kHz band.

**Kind of Test Site**                      Shielded room

#### Test Setup

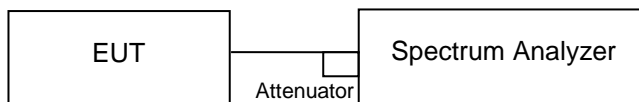

#### Test Instruments

Kind of Equipment	Manufacturer	Type	S/N	Calibration Date	Calibration Due Date	Test Date	
						From	Until
Spectrum Analyzer	R&S	FSV40	100921	2022/7/7	2023/7/6	2022/12/13	2023/3/2

#### Test Procedure

- a. Set analyzer center frequency to DTS channel center frequency.
- b. Set the span to 1.5 times the DTS bandwidth.
- c. Set the RBW to:  $3 \text{ kHz} \leq \text{RBW} \leq 100 \text{ kHz}$ .
- d. Set the VBW  $\geq 3 \times \text{RBW}$ .
- e. Detector = peak.
- f. Sweep time = auto couple.
- g. Trace mode = max hold.
- h. Allow trace to fully stabilize.
- i. Use the peak marker function to determine the maximum amplitude level within the RBW.

#### Test Results

Please refer to Appendix A~B.



## 5.1.5 Conducted Spurious Emissions and Frequency Band Edges Measured in 100 kHz Bandwidth

### Limit

20 dB (below that in the 100 kHz bandwidth within the band that contains the highest level of the desired power.)

**Kind of Test Site**                      Shielded room

### Test Setup

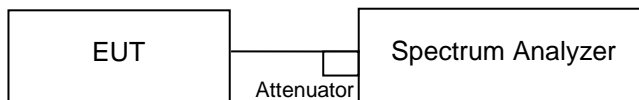

### Test Instruments

Kind of Equipment	Manufacturer	Type	S/N	Calibration Date	Calibration Due Date	Test Date	
						From	Until
Spectrum Analyzer	R&S	FSV40	100921	2022/7/7	2023/7/6	2022/12/13	2023/3/2

### Test Procedure

Measurement procedure REF

1. Set the RBW = 100 kHz.
2. Set the VBW  $\geq$  300 kHz.
3. Detector = peak.
4. Sweep time = auto couple.
5. Trace mode = max hold.
6. Allow trace to fully stabilize.
7. Use the peak marker function to determine the maximum power level in any 100 kHz band segment within the fundamental EBW.

Measurement procedure OOBE

1. Set RBW = 100 kHz.
2. Set VBW  $\geq$  300 kHz.
3. Detector = peak.
4. Sweep = auto couple.
5. Trace Mode = max hold.
6. Allow trace to fully stabilize.
7. Use the peak marker function to determine the maximum amplitude level.

### Test Results

Please refer to Appendix A~B.

## 5.1.6 Radiated Spurious Emissions and Band Edges

### Limit

Radiated emissions which fall in the restricted bands, as defined in §15.205(a), must comply with the radiated emission limits specified in §15.209(a).

Emissions radiated outside the restricted and authorized frequency bands must either comply with the radiated emission limits specified for the restricted bands or in §15.247(d).

**Kind of Test Site** 3m Semi-Anechoic Chamber

### Test Setup

<Radiated Emissions below 30 MHz>

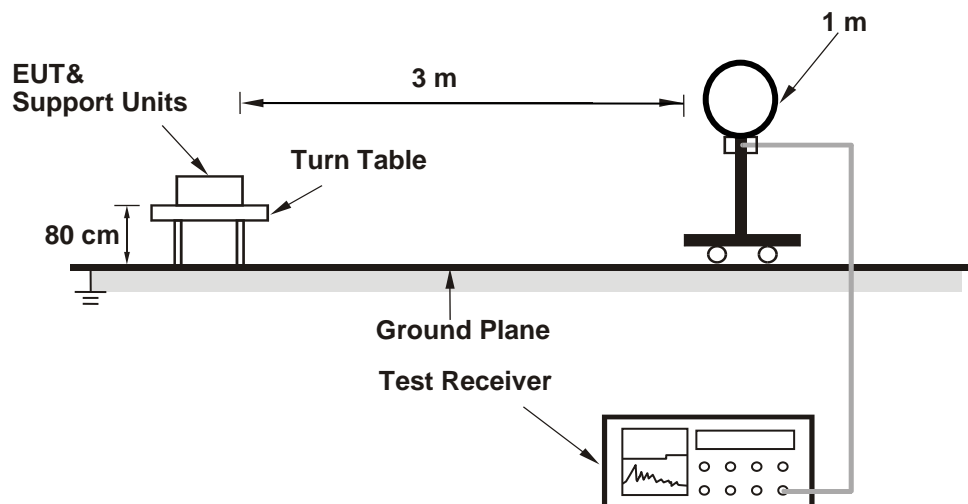

<Radiated Emissions 30 MHz to 1 GHz>

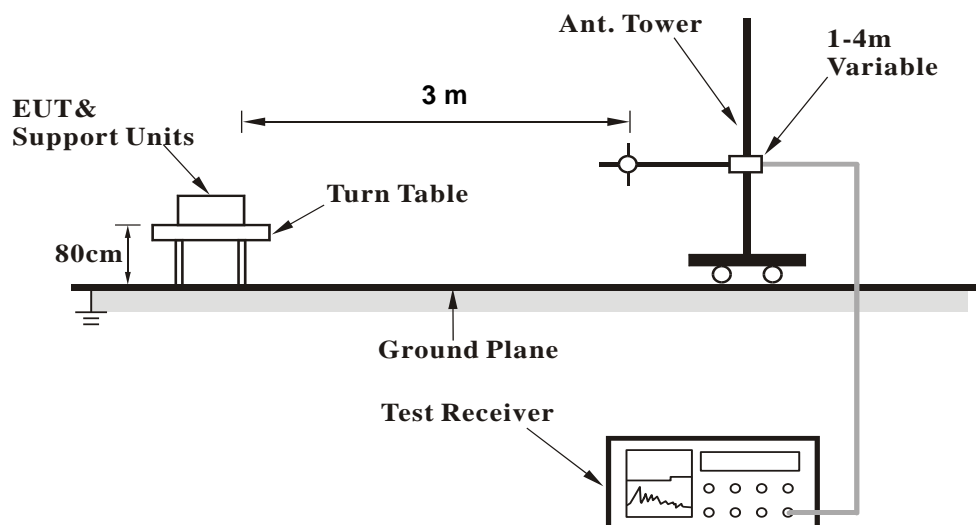

## &lt;Radiated Emissions above 1 GHz&gt;

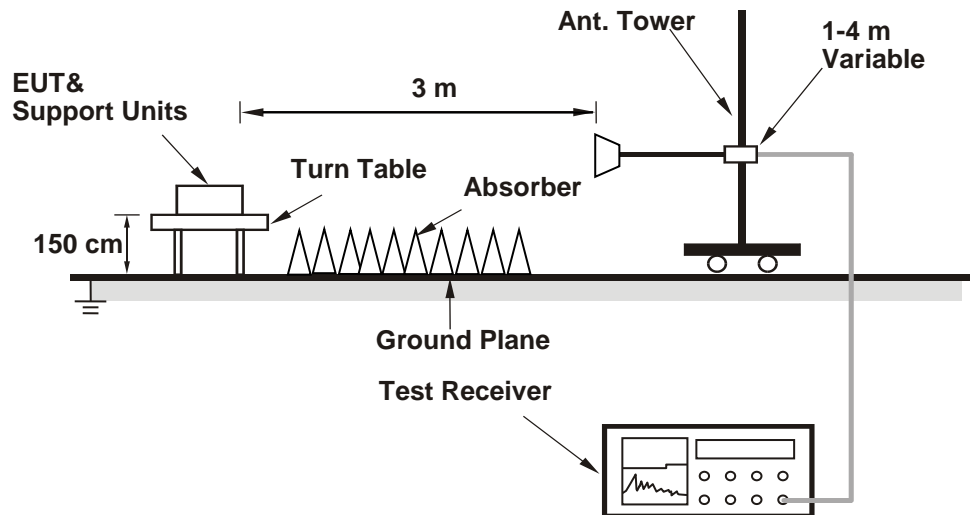

For the actual test configuration, please refer to the attached file (Test Setup Photo).

**Test Instruments**

Test period: 2023-02-04 ~ 2023-02-18

Kind of Equipment	Manufacturer	Type	S/N	Calibration Date	Calibration Due Date
<b>Above 1 GHz</b>					
Signal Analyzer	R&S	FSV40	101508	2022/4/13	2023/4/12
Horn Antenna	ETS-Lindgren	3117	00218929	2022/12/8	2023/12/7
HF-AMP + AC source	EMCI	EMC051845SE	980656	2023/1/16	2024/1/15
HF-AMP + AC source	EM	EM01G18GA	060905	2022/11/28	2023/11/27
Horn Antenna	SCHWARZBECK	BBHA 9170	00887	2022/3/29	2023/3/28
Test Software	Audix E3	15914a_20191106 tuv	PK-001087	N/A	N/A
<b>30 MHz ~ 1 GHz</b>					
Receiver	R&S	ESR7	102108	2022/4/28	2023/4/27
Bilog Antenna	SCHWARZBECK	VULB-9168	00950	2022/4/6	2023/4/5
LF-AMP	Agilent	8447D	2944A107722	2022/3/22	2023/3/21
Test Software	Audix E3	15914a_20191106 tuv	PK-001087	N/A	N/A
<b>Below 30 MHz</b>					
Receiver	R&S	ESR7	102108	2022/4/28	2023/4/27
Loop Antenna	EMCI	LPA600	287	2022/7/8	2023/7/7
Test Software	Audix E3	15914a_20191106 tuv	PK-001087	N/A	N/A

**Test Procedures****For Radiated Emissions below 30 MHz**

- a. The EUT was placed on the top of a rotating table 0.8 meters above the ground at a 3 meter chamber room. The table was rotated 360 degrees to determine the position of the highest radiation.
- b. The EUT was set 3 meters away from the interference-receiving antenna, which was mounted on the top of a variable-height antenna tower.
- c. Parallel (OPEN), perpendicular (CLOSE), and ground-parallel (GROUND) orientations of the antenna are set to make the measurement.
- d. For each suspected emission, the EUT was arranged to its worst case and the rotatable table was turned from 0 degrees to 360 degrees to find the maximum reading.
- e. The test-receiver system was set to Quasi-Peak Detect Function and Specified Bandwidth with Maximum Hold Mode.

## Note:

1. The resolution bandwidth and video bandwidth of test receiver/spectrum analyzer is 9 kHz at frequency below 30 MHz.
2. All modes of operation were investigated and the worst-case emissions are reported.

**For Radiated Emissions above 30 MHz**

- a. The EUT was placed on the top of a rotating table 0.8 meters (for 30 MHz ~ 1 GHz) / 1.5 meters (for above 1 GHz) above the ground at 3 meter chamber room for test. The table was rotated 360 degrees to determine the position of the highest radiation.
- b. The EUT was set 3 meters away from the interference-receiving antenna, which was mounted on the top of a variable-height antenna tower.
- c. The height of antenna is varied from one meter to four meters above the ground to determine the maximum value of the field strength. Both horizontal and vertical polarizations of the antenna are set to make the measurement.
- d. For each suspected emission, the EUT was arranged to its worst case and then the antenna was tuned to heights from 1 meter to 4 meters and the rotatable table was turned from 0 degrees to 360 degrees to find the maximum reading.
- e. The test-receiver system was set to quasi-peak detect function and specified bandwidth with maximum hold mode when the test frequency is below 1 GHz.
- f. The test-receiver system was set to peak and average detected function and specified bandwidth with maximum hold mode when the test frequency is above 1 GHz. If the peak reading value also meets average limit, measurement with the average detector is unnecessary.

## Note:

1. The resolution bandwidth and video bandwidth of test receiver/spectrum analyzer is 120 kHz for Quasi-peak detection (QP) or Peak detection (PK) at frequency below 1 GHz.
2. The resolution bandwidth of test receiver/spectrum analyzer is 1 MHz and the video bandwidth is 3 MHz for Peak detection (PK) at frequency above 1 GHz.
3. The resolution bandwidth of test receiver/spectrum analyzer is 1 MHz and the video bandwidth is  $\geq 1/T$  (Duty cycle < 98 %) or 10 Hz (Duty cycle  $\geq 98$  %) for Average detection (AV) at frequency above 1 GHz.
4. All modes of operation were investigated and the worst-case emissions are reported.
5. The Radiated Emissions testing was performed in the X(E1), Y(H) and Z(E2) axis orientation. The worst-case Axis orientation is recorded in this test report.

**Prüfbericht - Nr.: CN23ML3X (P15C-WiFi) 001**  
*Test Report No.*

**Seite 30 von 32**  
*Page 30 of 32*

**Test Results**

Factor (dB/m) = Antenna Factor (dB/m) + Cable Loss (dB)  
Level (dBuV/m) = Reading (dBuV) + Factor (dB/m)

Please refer to Appendix C~D.

## 5.2 Mains Emission

### 5.2.1 Mains Conducted Emission

**Limit**

Mains Conducted Emission as defined in §15.207 must comply with the mains conducted emission limits.

**Kind of Test Site**                      Shielded room

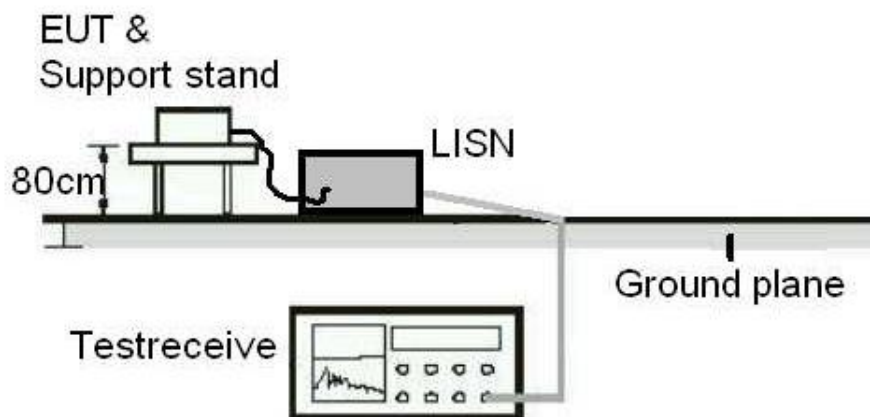
**Test Setup**

**Test Instruments**

Test period: 2022-12-28

Kind of Equipment	Manufacturer	Type	S/N	Calibration Date	Calibration Due Date
Two-Line V-Network	Rohde & Schwarz	ENV216	101938	2022/9/22	2023/9/21
EMI Test Receiver	R&S	ESCI	100797	2022/6/19	2023/6/18

#### **Test Procedures**

- a. The EUT was placed 0.4 meters from the conducting wall of the shielded room with EUT being connected to the power mains through a line impedance stabilization network (LISN). Other support units were connected to the power mains through another LISN. The two LISNs provide 50 ohm/50 uH of coupling impedance for the measuring instrument.
- b. Both lines of the power mains connected to the EUT were checked for maximum conducted interference.
- c. The frequency range from 150 kHz to 30 MHz was searched. Emission levels under (Limit – 20 dB) was not recorded.

Note: The resolution bandwidth and video bandwidth of test receiver is 9 kHz for quasi-peak detection (QP) and average detection (AV) at frequency 0.15 MHz – 30 MHz.

#### **Test Results**

Please refer to Appendix C.