



Prüfbericht-Nr.: <i>Test report no.:</i>	CN22QGFA (P15E-WiFi) 001	Auftrags-Nr.: <i>Order no.:</i>	238545743	Seite 1 von 140 <i>Page 1 of 140</i>
Kunden-Referenz-Nr.: <i>Client reference no.:</i>	N/A	Auftragsdatum: <i>Order date:</i>	2022-07-15	
Auftraggeber: <i>Client:</i>	Acer Incorporated 8F, 88, Sec. 1, Xintai 5th Rd. Xizhi, New Taipei City 221 Taiwan			
Prüfgegenstand: <i>Test item:</i>	Predator Connect Wi-Fi Router			
Bezeichnung / Typ-Nr.: <i>Identification / Type no.:</i>	W6			
Auftrags-Inhalt: <i>Order content:</i>	FCC Part 15E Test report (WiFi 5GHz)			
Prüfgrundlage: <i>Test specification:</i>	FCC 47CFR Part 15: Subpart E Section 15.407			
Wareneingangsdatum: <i>Date of sample receipt:</i>	2022-07-11			
Prüfmuster-Nr.: <i>Test sample no.:</i>	A003297660-017 A003297660-015			
Prüfzeitraum: <i>Testing period:</i>	2022-08-18 - 2022-10-06			
Ort der Prüfung: <i>Place of testing:</i>	EMC/RF Taipei Testing Site			
Prüflaboratorium: <i>Testing laboratory:</i>	Taipei Testing Laboratories			
Prüfergebnis*: <i>Test result*:</i>	Pass			
überprüft von: <i>compiled by:</i>	 Ethan Shao		genehmigt von: <i>authorized by:</i>	 Brenda Chen
Datum: <i>Date:</i>	2022-10-20		Ausstellungsdatum: <i>Issue date:</i>	2022-10-20
Stellung / Position:	Assistant Project Engineer		Stellung / Position:	Senior Project Manager
Sonstiges / Other:				
Zustand des Prüfgegenstandes bei Anlieferung: <i>Condition of the test item at delivery:</i>	Prüfmuster vollständig und unbeschädigt <i>Test item complete and undamaged</i>			
* Legende:	1 = sehr gut P(ass) = entspricht o.g. Prüfgrundlage(n)	2 = gut F(ail) = entspricht nicht o.g. Prüfgrundlage(n)	3 = befriedigend N/A = nicht anwendbar	4 = ausreichend N/T = nicht getestet
* Legend:	1 = very good P(ass) = passed a.m. test specification(s)	2 = good F(ail) = failed a.m. test specification(s)	3 = satisfactory N/A = not applicable	4 = sufficient N/T = not tested
Dieser Prüfbericht bezieht sich nur auf das o.g. Prüfmuster und darf ohne Genehmigung der Prüfstelle nicht auszugsweise vervielfältigt werden. Dieser Bericht berechtigt nicht zur Verwendung eines Prüfzeichens. <i>This test report only relates to the a. m. test sample. Without permission of the test center this test report is not permitted to be duplicated in extracts. This test report does not entitle to carry any test mark.</i>				

TEST SUMMARY

Report Section	FCC Clause	Test Item	Result
5.1.1	15.407(a) & 15.203	Antenna Requirement	Pass
5.1.2	15.407(a)	Maximum Conducted Output Power	Pass
5.1.3	15.407(h)(1)	Transmit Power Control (TPC)	Pass
5.1.4	15.407(a)	26 dB Bandwidth	Pass
5.1.4	2.1049	99% Occupied Bandwidth	Pass
5.1.5	15.407(e)	6 dB Bandwidth (U-NII-3 Band only)	Pass
5.1.6	15.407(g)	Frequency Stability	Pass
5.1.7	15.407(a)	Power Spectral Density	Pass
5.1.8	15.407(b) & 15.205 & 15.209	Radiated Spurious Emissions and Band Edges	Pass
5.1.9	15.407(h) & KDB 905462 D02	Dynamic Frequency Selection	Pass
5.2.1	15.207	Mains Conducted Emission	Pass

Note: Determining compliance based on the results of the compliance measurement, not taking into account measurement instrumentation uncertainty.

Contents

HISTORY OF THIS TEST REPORT	5
1. GENERAL REMARKS	6
1.1 COMPLEMENTARY MATERIALS.....	6
1.2 DECISION RULE OF CONFORMITY	6
2. TEST SITES	7
2.1 TEST LABORATORY	7
2.2 TEST FACILITY.....	7
2.3 TRACEABILITY	8
2.4 CALIBRATION	8
2.5 MEASUREMENT UNCERTAINTY	8
3. GENERAL PRODUCT INFORMATION.....	9
3.1 PRODUCT FUNCTION AND INTENDED USE	9
3.2 SYSTEM DETAILS AND RATINGS.....	9
3.3 NOISE GENERATING AND NOISE SUPPRESSING PARTS	11
3.4 SUBMITTED DOCUMENTS.....	11
4. TEST SET-UP AND OPERATION MODES.....	12
4.1 PRINCIPLE OF CONFIGURATION SELECTION	12
4.2 CARRIER FREQUENCY AND CHANNEL.....	13
4.3 TEST OPERATION AND TEST SOFTWARE.....	14
4.4 SPECIAL ACCESSORIES AND AUXILIARY EQUIPMENT	17
4.5 TEST SETUP DIAGRAM	18
4.6 DUTY CYCLE OF TEST SIGNAL	19
5. TEST RESULTS	21
5.1 TRANSMITTER REQUIREMENT & TEST SUITES.....	21
5.1.1 <i>Antenna Requirement</i>	<i>21</i>
5.1.2 <i>Maximum Conducted Output Power</i>	<i>22</i>
5.1.3 <i>Transmit Power Control (TPC).....</i>	<i>30</i>
5.1.4 <i>26 dB Bandwidth and 99% Occupied Bandwidth.....</i>	<i>31</i>
5.1.5 <i>6 dB Bandwidth (5725-5850MHz).....</i>	<i>32</i>
5.1.6 <i>Frequency Stability Measurement.....</i>	<i>33</i>
5.1.7 <i>Power Spectral Density.....</i>	<i>35</i>
5.1.8 <i>Radiated Spurious Emissions</i>	<i>37</i>
5.1.9 <i>Dynamic Frequency Selection</i>	<i>42</i>
5.2 MAINS EMISSION	139
5.2.1 <i>Mains Conducted Emission.....</i>	<i>139</i>

Prüfbericht - Nr.: CN22QGFA (P15E-WiFi) 001
Test Report No.

Seite 4 von 140
Page 4 of 140

APPENDIX A - TEST RESULT OF CONDUCTED_CDD

APPENDIX B - TEST RESULT OF CONDUCTED_BEAMFORMING

**APPENDIX C - TEST RESULT OF RADIATED EMISSIONS & MAINS CONDUCTED
EMISSION_CDD**

APPENDIX D - TEST RESULT OF RADIATED EMISSIONS_BEAMFORMING

APPENDIX E - DYNAMIC FREQUENCY SELECTION RADAR TEST WAVEFORM

APPENDIX SP - PHOTOGRAPHS OF TEST SETUP

APPENDIX EP - PHOTOGRAPHS OF EUT

HISTORY OF THIS TEST REPORT

Report No.	Description	Date Issued
CN22QGFA (P15E-WiFi) 001	Original Release	2022-10-20

1. General Remarks

1.1 Complementary Materials

All attachments are integral parts of this test report. This applies especially to the following appendix:

Appendix A - Test Result of Conducted_CDD

Appendix B - Test Result of Conducted_Beamforming

Appendix C - Test Result of Radiated Emissions & Mains Conducted Emission_CDD

Appendix D - Test Result of Radiated Emissions_Beamforming

Appendix E - Dynamic Frequency Selection Radar Test waveform

Appendix SP - Photographs of Test Setup

Appendix EP - Photographs of EUT

Applied Standard and Test Levels

Radio
FCC 47CFR Part 15: Subpart E Section 15.407
FCC 47CFR Part 2: Subpart J Section 2.1049
ANSI C63.10:2013
KDB 789033 D02 General UNII Test Procedures New Rules v02r01
KDB 905462 D02 UNII DFS Compliance Procedures New Rules v02
KDB 662911 D01 Multiple Transmitter Output v02r01

1.2 Decision Rule of Conformity

The decision rule of conformity of this test report is following the requirements of the requested standard in the quotation, and agreed among testing laboratory and manufacturer (applicant) to exclude the consideration of Measurement Uncertainty, unless it is required by the specific standard.

2. Test Sites

2.1 Test Laboratory

Taipei Testing Laboratories

11F. No.758, Sec. 4, Bade Rd., Songshan Dist.
Taipei City 105
Taiwan (R.O.C.)

2.2 Test Facility

Taipei Testing Laboratories

No.458-18, Sec. 2, Fenliao Rd., Linkou Dist.,
New Taipei City 244
Taiwan (R.O.C.)
FCC Registration No.: 180491
ISED Registration No.: 25563

2.3 Traceability

All measurement equipment calibrations are traceable to NML(Taiwan)/NIST(USA) or where calibration is performed outside Taiwan, to equivalent nationally recognized standards organizations.

2.4 Calibration

Equipment requiring calibration is calibrated periodically in a suitably accredited Calibration Lab. Additionally all equipment is verified for proper performance on a regular basis using in house standards or comparisons.

2.5 Measurement Uncertainty

All measurement uncertainty values are shown with a coverage factor of $k=2$ to indicate a 95% level of confidence.

Emission Measurement Uncertainty

Parameter	Uncertainty
Radiated Emission (9 kHz ~ 30 MHz)	± 1.15 dB
Radiated Emission (30 MHz ~ 200 MHz)	± 1.30 dB
Radiated Emission (200 MHz ~ 1 GHz)	± 1.30 dB
Radiated Emission (1 GHz ~ 18 GHz)	± 1.54 dB
Radiated Emission (18 GHz ~ 40 GHz)	± 2.52 dB
Mains Conducted Emission	± 1.65 dB

3. General Product Information

3.1 Product Function and Intended Use

The EUT is a Predator Connect Wi-Fi Router. It contains a WLAN compatible module enabling the user to communicate data through a Wireless interface.

For details refer to the User Guide, Data Sheet and Circuit Diagram.

3.2 System Details and Ratings

Basic Information of EUT

Item	EUT information
Kind of Equipment/Test Item	Predator Connect Wi-Fi Router
Type Identification	W6
FCC ID	HLZW6

Technical Specification of EUT

Item	EUT information
Operating Frequency	Band 1: 5180 MHz ~ 5240 MHz Band 2: 5260 MHz ~ 5320 MHz Band 3: 5500 MHz ~ 5700 MHz Band 4: 5745 MHz ~ 5825 MHz
Channel Number	<5180 MHz ~ 5320 MHz> 8 for 802.11a, 802.11n HT20, 802.11ac VHT20, 802.11ax HE20 4 for 802.11n HT40, 802.11ac VHT40, 802.11ax HE40 2 for 802.11ac VHT80, 802.11ax HE80 1 for 802.11ac VHT160, 802.11ax HE160 <5500 MHz ~ 5700 MHz> 11 for 802.11a, 802.11n HT20, 802.11ac VHT20, 802.11ax HE20 5 for 802.11n HT40, 802.11ac VHT40, 802.11ax HE40 2 for 802.11ac VHT80, 802.11ax HE80 1 for 802.11ac VHT160, 802.11ax HE160 <5745 MHz ~ 5825 MHz> 5 for 802.11a, 802.11n HT20, 802.11ac VHT20, 802.11ax HE20 2 for 802.11n HT40, 802.11ac VHT40, 802.11ax HE40 1 for 802.11ac VHT80, 802.11ax HE80
Data Rate	802.11a: 54.0 / 48.0 / 36.0 / 24.0 / 18.0 / 12.0 / 9.0 / 6.0 Mbps 802.11n: up to MCS7 802.11ac: up to MCS9 802.11ax: up to MCS11
Operation Voltage	Adapter input 100-240 Vac, output 12 Vdc
Modulation	OFDM (BPSK, QPSK, 16QAM, 64QAM, 256QAM) OFDMA (1024QAM)

Item	EUT information	
Maximum Output Power (mW)	CDD	5180 ~ 5250 MHz: 275.83 5250 ~ 5320 MHz: 135.21 5500 ~ 5720 MHz: 138.62 5745 ~ 5825 MHz: 136.88
	Beamforming	5180 ~ 5250 MHz: 216.32 5250 ~ 5320 MHz: 80.90 5500 ~ 5720 MHz: 86.12 5745 ~ 5825 MHz: 125.18
Maximum EIRP (mW)	5250 ~ 5320 MHz: 965.95 5500 ~ 5720 MHz: 993.38	
DFS Mode	Master	
Antenna Information	Refer to 5.1.1	
Accessory Device	Refer to 4.4	

3.3 Noise Generating and Noise Suppressing Parts

Refer to the Circuit Diagram.

3.4 Submitted Documents

- Circuit Diagram
- Instruction Manual
- Rating Label
- Technical Description

4. Test Set-up and Operation Modes

4.1 Principle of Configuration Selection

The test modes were adapted accordingly in reference to the instructions for use.

During testing, Channel and Power Controlling Software provided by the customer was used to control the operating channel as well as the output power level. The RF output power selection is for the setting of RF output expected by the customer and is going to be fixed on the firmware of the final end product.

Table for Parameters of Test Software Setting

<CDD>

802.11a		802.11n HT20 802.11ac VHT20 802.11ax HE20		802.11n HT40 802.11ac VHT40 802.11ax HE40		802.11ac VHT80 802.11ax HE80		802.11ac VHT160 802.11ax HE160	
Channel	Power Setting	Channel	Power Setting	Channel	Power Setting	Channel	Power Setting	Channel	Power Setting
36	14	36	14	38	15	42	12.5	50	13
40	14	40	15	46	15.5	58	12	114	8
48	14.5	48	15.5	54	9.5	106	10		
52	8	52	8.5	62	10	122	12		
60	8.5	60	8.5	102	8.5	155	12		
64	8.5	64	9	110	7.5				
100	6.5	100	7	134	8.5				
116	7	116	7	151	11.5				
140	7.5	140	7.5	159	10				
149	11	149	11						
157	10	157	11						
165	11.5	165	11						

<Beamforming>

802.11ac VHT20 802.11ax HE20		802.11ac VHT40 802.11ax HE40		802.11ac VHT80 802.11ax HE80		802.11ac VHT160 802.11ax HE160	
Channel	Power Setting	Channel	Power Setting	Channel	Power Setting	Channel	Power Setting
36	30	38	26	42	23	50	22
40	30	46	30	58	21	114	13
48	30	54	19	106	17		
52	16	62	21	122	17		
60	17	102	18	155	24		
64	17	110	16				
100	14	134	19				
116	15	151	25				
140	17	159	23				
149	22						
157	20						
165	21						

4.2 Carrier Frequency and Channel

Channel	Frequency (MHz)	802.11a 802.11n HT20 802.11ac VHT20 802.11ax HE20	802.11n HT40 802.11ac VHT40 802.11ax HE40	802.11ac VHT80 802.11ax HE80	802.11ac VHT160 802.11ax HE160
36	5180	V			
38	5190		V		
40	5200	V			
42	5210			V	
44	5220	V			
46	5230		V		
48	5240	V			
50	5250				V
52	5260	V			
54	5270		V		
56	5280	V			
58	5290			V	
60	5300	V			
62	5310		V		
64	5320	V			
100	5500	V			
102	5510		V		
104	5520	V			
106	5530			V	
108	5540	V			
110	5550		V		
112	5560	V			
114	5570				V
116	5580	V			
118	5590		V		
120	5600	V			
122	5610			V	
124	5620	V			
126	5630		V		
128	5640	V			
132	5660	V			
134	5670		V		
136	5680	V			
140	5700	V			
149	5745	V			
151	5755		V		
153	5765	V			
155	5775			V	
157	5785	V			
159	5795		V		
161	5805	V			
165	5825	V			

4.3 Test Operation and Test Software

Setup for testing: Test samples are provided with LAN interface which makes it possible to control them through a test software installed on a notebook computer.

This software was running on the laptop computer connected to the EUT. It was used to enable the operation modes listed as below.

Test Software	MT7906 QA 0.0.2.88 for Test mode MTK commend for Beamforming
---------------	---

The samples were used as follows:

A003297660-017

A003297660-015

Full test was applied on all test modes, but only worst case was shown.

The EUT incorporates a MIMO function. Physically, the EUT provides four completed transmitters and receivers.

Modulation Mode	Tx Function
802.11a	4TX (MIMO)
802.11n HT20	4TX (MIMO)
802.11n HT40	4TX (MIMO)
802.11ac VHT20	4TX (MIMO)
802.11ac VHT40	4TX (MIMO)
802.11ac VHT80	4TX (MIMO)
802.11ac VHT160	4TX (MIMO)
802.11ax HE20	4TX (MIMO)
802.11ax HE40	4TX (MIMO)
802.11ax HE80	4TX (MIMO)
802.11ax HE160	4TX (MIMO)

* The modulation and bandwidth are similar for 802.11n mode HT20/HT40 and 802.11ac VHT20/VHT40/VHT80/VHT160 and 802.11ax HE20/HE40/HE80/HE160, therefore, only investigated worse case as representative mode in test report.

EUT Configure Mode	Applicable To				Description
	Antenna Port Conducted Measurement	Radiated Spurious Emissions above 1 GHz	Radiated Spurious Emissions below 1 GHz	Mains Conducted Emission	
-	√	√	√	√	-

Note:

1. The EUT had been pre-tested on the positioned of each 3 axis. The worst case was found when position on **Z-plane**.
2. "-" means no effect.

Antenna Port Conducted Measurement

- Pre-Scan full test was applied on all test modes, but only worst case was shown.
- Following channel(s) was (were) selected for the final test as listed below.

EUT Configure Mode	Mode	Frequency (MHz)	Available Channel	Tested Channel	Date Rate (Mbps)
CDD	802.11a	5180-5250	36 to 48	36, 40, 48	6.0
		5250-5320	52 to 64	52, 60, 64	
		5500-5700	100 to 140	100, 116, 140	
		5745-5825	149 to 165	149, 157, 165	
	802.11n HT20 (Power only)	5180-5250	36 to 48	36, 40, 48	MCS0
		5250-5320	52 to 64	52, 60, 64	
		5500-5700	100 to 140	100, 116, 140	
		5745-5825	149 to 165	149, 157, 165	
	802.11n HT40 (Power only)	5180-5250	38 to 46	38, 46	MCS0
		5250-5320	54 to 62	54, 62	
		5500-5700	102 to 134	102, 110, 134	
		5745-5825	151 to 159	151, 159	
	802.11ac VHT20 (Power only)	5180-5250	36 to 48	36, 40, 48	NSS1 MCS0
		5250-5320	52 to 64	52, 60, 64	
		5500-5700	100 to 140	100, 116, 140	
		5745-5825	149 to 165	149, 157, 165	
	802.11ac VHT40 (Power only)	5180-5250	38 to 46	38, 46	NSS1 MCS0
		5250-5320	54 to 62	54, 62	
		5500-5700	102 to 134	102, 110, 134	
		5745-5825	151 to 159	151, 159	
	802.11ac VHT80 (Power only)	5180-5250	42	42	NSS1 MCS0
		5250-5320	58	58	
		5500-5700	106 to 122	106, 122	
		5745-5825	155	155	
	802.11ac VHT160 (Power only)	5180-5320	50	50	NSS1 MCS0
		5500-5700	114	114	
	802.11ax HE20	5180-5250	36 to 48	36, 40, 48	NSS1 MCS0
		5250-5320	52 to 64	52, 60, 64	
		5500-5700	100 to 140	100, 116, 140	
		5745-5825	149 to 165	149, 157, 165	
	802.11ax HE40	5180-5250	38 to 46	38, 46	NSS1 MCS0
		5250-5320	54 to 62	54, 62	
5500-5700		102 to 134	102, 110, 134		
5745-5825		151 to 159	151, 159		
802.11ax HE80	5180-5250	42	42	NSS1 MCS0	
	5250-5320	58	58		
	5500-5700	106 to 122	106, 122		
	5745-5825	155	155		
802.11ax HE160	5180-5320	50	50	NSS1 MCS0	
	5500-5700	114	114		

EUT Configure Mode	Mode	Frequency (MHz)	Available Channel	Tested Channel	Date Rate (Mbps)
Beamforming	802.11ax HE20	5180-5250	36 to 48	36, 40, 48	NSS1 MCS0
		5250-5320	52 to 64	52, 60, 64	
		5500-5700	100 to 140	100, 116, 140	
		5745-5825	149 to 165	149, 157, 165	
	802.11ax HE40	5180-5250	38 to 46	38, 46	NSS1 MCS0
		5250-5320	54 to 62	54, 62	
		5500-5700	102 to 134	102, 110, 134	
		5745-5825	151 to 159	151, 159	
	802.11ax HE80	5180-5250	42	42	NSS1 MCS0
		5250-5320	58	58	
		5500-5700	106 to 122	106, 122	
		5745-5825	155	155	
	802.11ax HE160	5180-5320	50	50	NSS1 MCS0
		5500-5700	114	114	

Radiated Spurious Emissions (Above 1 GHz)

- Pre-Scan full test was applied on all test modes, but only worst case was shown.
- Following channel(s) was (were) selected for the final test as listed below.

EUT Configure Mode	Mode	Frequency (MHz)	Available Channel	Tested Channel	Date Rate (Mbps)	
CDD	802.11a	5180-5250	36 to 48	36, 40, 48	6.0	
		5250-5320	52 to 64	52, 60, 64		
		5500-5700	100 to 140	100, 116, 140		
		5745-5825	149 to 165	149, 157, 165		
	802.11ax HE20	5180-5250	36 to 48	36, 40, 48	NSS1 MCS0	
		5250-5320	52 to 64	52, 60, 64		
		5500-5700	100 to 140	100, 116, 140		
		5745-5825	149 to 165	149, 157, 165		
	802.11ax HE40	5180-5250	38 to 46	38, 46	NSS1 MCS0	
		5250-5320	54 to 62	54, 62		
		5500-5700	102 to 134	102, 110, 134		
		5745-5825	151 to 159	151, 159		
	802.11ax HE80	5180-5250	42	42	NSS1 MCS0	
		5250-5320	58	58		
		5500-5700	106 to 122	106, 122		
		5745-5825	155	155		
	802.11ax HE160	5180-5320	50	50	NSS1 MCS0	
		5500-5700	114	114		
	Beamforming	802.11ax HE20	5180-5250	36 to 48	36, 40, 48	NSS1 MCS0
			5250-5320	52 to 64	52, 60, 64	
5500-5700			100 to 140	100, 116, 140		
5745-5825			149 to 165	149, 157, 165		
802.11ax HE40		5180-5250	38 to 46	38, 46	NSS1 MCS0	
		5250-5320	54 to 62	54, 62		
		5500-5700	102 to 134	102, 110, 134		
		5745-5825	151 to 159	151, 159		
802.11ax HE80		5180-5250	42	42	NSS1 MCS0	
		5250-5320	58	58		
		5500-5700	106 to 122	106, 122		
		5745-5825	155	155		
802.11ax HE160		5180-5320	50	50	NSS1 MCS0	
		5500-5700	114	114		

Radiated Spurious Emissions (Below 1 GHz)

- Pre-Scan full test was applied on all test modes, but only worst case was shown.
 Following channel(s) was (were) selected for the final test as listed below.

EUT Configure Mode	Mode	Frequency (MHz)	Available Channel	Tested Channel	Date Rate (Mbps)
CDD	802.11n HT40	5180-5250	38 to 46	46	NSS1 MCS0
Beamforming	802.11n HT40	5180-5250	38 to 46	46	NSS1 MCS0

Mains Conducted Emission Test

- Pre-Scan full test was applied on all test modes, but only worst case was shown.
 Following channel(s) was (were) selected for the final test as listed below.

EUT Configure Mode	Mode
-	WLAN 2.4 GHz + WLAN 5 GHz + WLAN 6E

Test Condition

Test Item	Ambient Temperature	Relative Humidity	Tested by
Conducted Measurement	23.8-25.5 °C	59-68 %	Nick Guan & Andy Chen
Radiated Spurious Emissions above 1 GHz	24.4-26.3 °C	56-68 %	Ivan Chiang
Radiated Spurious Emissions below 1 GHz	24.4-26.3 °C	56-68 %	Ivan Chiang
Mains Conducted Emission	21 °C	50 %	Ray Huang

4.4 Special Accessories and Auxiliary Equipment

The product has been tested together with the following additional accessories:

Accessory of EUT

No.	Product	Brand	Model	Description
A	Adapter	Asian Power Devices INC.	WA-36W12FU	I/P: 100-240 Vac, 50/60 Hz, 0.9 A O/P: 12 Vdc, 3 A

Support Unit

Support Unit								
No	Description	Brand	Model	S/N	Shielded	Ferrite Core (Qty)	Length (cm)	Remark
1	LAN Cable	TUV	TUV-001	NO	YES	NO	300	Radiated
2	Notebook	HP	15s-du0007TX	CND93662WV	-	-	-	
1	Notebook	Lenovo	81BL	MP1DCD6Y	-	-	-	Mains Conducted
2	LAN Cable	TUV	TUV-01	NO	NO	NO	300	

4.5 Test Setup Diagram

<Radiated Spurious Emissions mode>

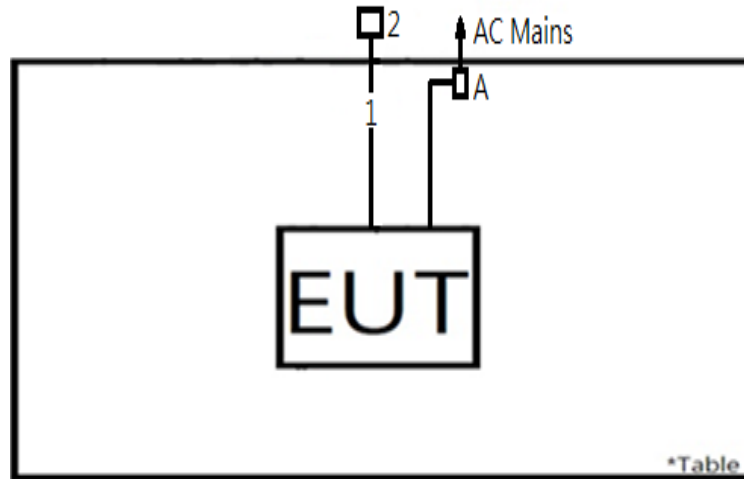

<Mains Conducted Emission mode>

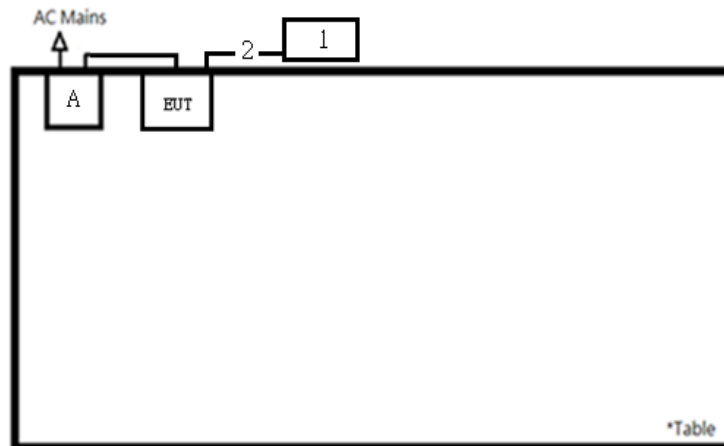

4.6 Duty Cycle of Test Signal

Mode	Band	On + Off Time (ms)	On Time (ms)	Duty Cycle (%)	Duty Factor (dB)
CDD	802.11a	1.46	1.39	95.53	0.20
	802.11ax HE20	0.53	0.47	89.35	0.49
	802.11ax HE40	0.48	0.42	87.92	0.56
	802.11ax HE80	0.44	0.38	86.70	0.62
	802.11ax HE160	0.43	0.37	86.85	0.61
Beamforming	802.11ax HE20	3.82	3.79	99.21	0.03
	802.11ax HE40	1.96	1.92	98.21	0.08
	802.11ax HE80	0.98	0.95	96.92	0.14
	802.11ax HE160	0.79	0.50	63.22	1.99

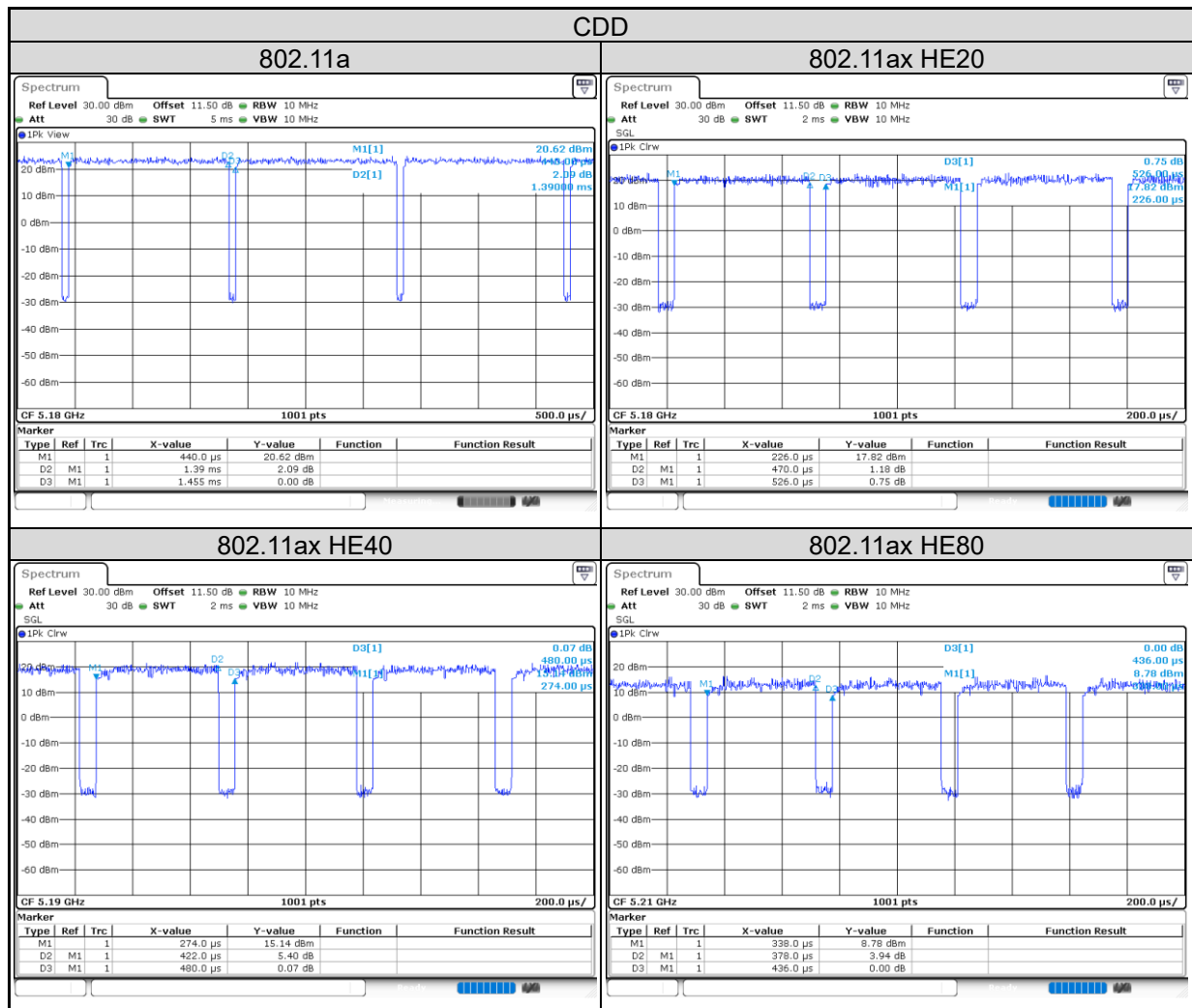

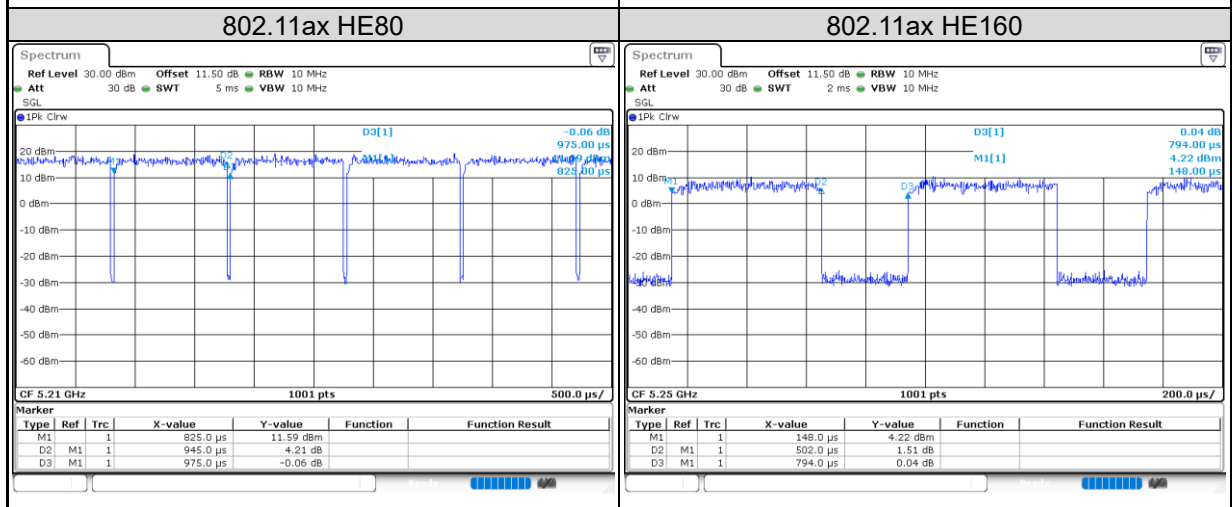
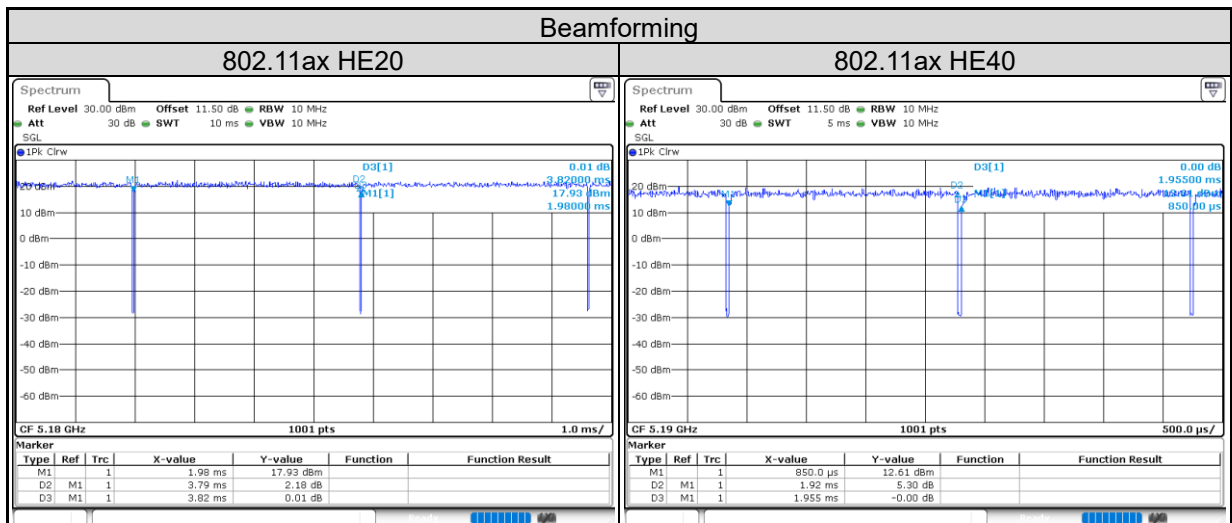
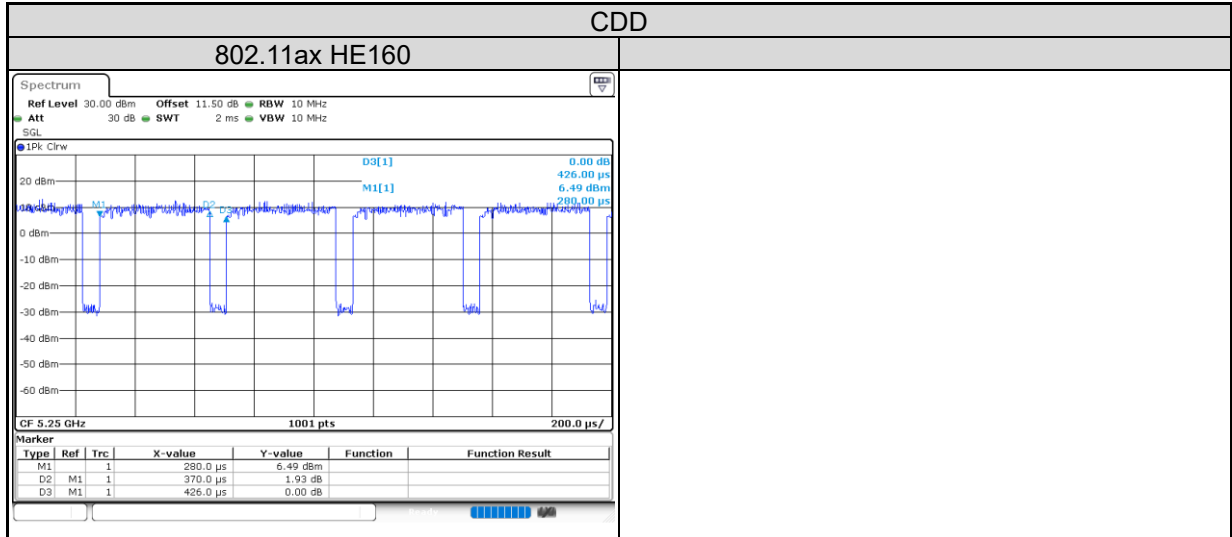

5. Test Results

5.1 Transmitter Requirement & Test Suites

5.1.1 Antenna Requirement

Requirement Use of approved antennas only

The gain value is derived from Antenna datasheet, the EUT's antenna specifications are described as below. The antenna is used with no possibility of replacement with a non-approved antenna by the end-user. Therefore, the EUT is considered to comply with this provision.

ANT		Gain (dBi)				Antenna Type
		Band 1	Band 2	Band 3	Band 4	
4		4.74	4.74	4.60	4.15	Dipole
5		5.75	5.72	5.33	5.01	Dipole
6		4.88	4.45	4.52	4.71	Dipole
7		3.94	4.00	3.89	3.79	Dipole
Max Peak Gain		5.75	5.72	5.33	5.01	-
CDD Mode	Power Directional Gain	5.75	5.72	5.33	5.01	-
	PSD Directional Gain	10.87	10.77	10.62	10.45	-
Beamforming Mode	Power Directional Gain	10.87	10.77	10.62	10.45	-
	PSD Directional Gain	10.87	10.77	10.62	10.45	-

Note: PSD Directional Gain = $10\log[(10^{G1/20} + 10^{G2/20} + \dots + 10^{GN/20})^2 / N_{ANT}]$

Refer to EUT photo for details.

5.1.2 Maximum Conducted Output Power

Limit

Operation Band	EUT Category	Limit
U-NII-1	Outdoor Access Point	1 Watt (30 dBm) (Max. e.i.r.p \leq 125 mW (21 dBm) at any elevation angle above 30 degrees as measured from the horizon)
	Fixed point-to-point Access Point	1 Watt (30 dBm)
	Indoor Access Point	1 Watt (30 dBm)
	Mobile and Portable client device	250 mW (24 dBm)
U-NII-2A	---	250 mW (24 dBm) or 11 dBm + 10 log B*
U-NII-2C	---	250 mW (24 dBm) or 11 dBm + 10 log B*
U-NII-3	---	1 Watt (30 dBm)

Note: B* is the 26 dB emission bandwidth in megahertz

Per KDB 662911 Method of conducted output power measurement on IEEE 802.11 devices,

Array Gain = 0 dB (i.e., no array gain) for $N_{ANT} \leq 4$;

Array Gain = 0 dB (i.e., no array gain) for channel widths ≥ 40 MHz for any N_{ANT} ;

Array Gain = 5 log(N_{ANT}/N_{SS}) dB or 3 dB, whichever is less for 20 MHz channel widths with $N_{ANT} \geq 5$.

For power measurements on all other devices: Array Gain = 10 log(N_{ANT}/N_{SS}) dB.

Kind of Test Site Shielded room

Test Setup



Test Instruments

Kind of Equipment	Manufacturer	Type	S/N	Calibration Date	Calibration Due Date	Test Date	
						From	Until
Power Meter	Anritsu	ML2495A	1901008	2022/3/15	2023/3/14	2022/8/18	2022/10/6
Power Sensor	Anritsu	MA2411B	1725269	2022/3/15	2023/3/14	2022/8/18	2022/10/6

Test Procedures

Method PM is used to perform output power measurement, trigger and gating function of wide band power meter is enabled to measure max output power of TX on burst and set the detector to AVERAGE. Duty factor is not added to measured value.

Test Result
CDD
<802.11a>

Channel	Channel Frequency (MHz)	Average Output Power (dBm)				Total Power		Limit (dBm)
		Ant 4	Ant 5	Ant 6	Ant 7	(dBm)	(mW)	
36	5180	16.41	15.62	15.44	16.01	21.91	155.12	30.00
40	5200	16.54	15.91	15.98	16.83	22.35	171.90	30.00
48	5240	15.45	14.75	16.91	17.06	22.17	164.84	30.00
52	5260	11.52	10.24	10.83	11.93	17.20	52.46	24.00
60	5300	11.24	11.25	10.29	11.49	17.11	51.42	24.00
64	5320	10.84	11.36	9.74	11.03	16.80	47.91	24.00
100	5500	11.64	10.63	11.13	10.52	17.02	50.39	24.00
116	5580	10.22	9.81	11.92	10.07	16.61	45.81	24.00
140	5700	10.36	11.44	10.85	10.96	16.94	49.43	24.00
149	5745	14.19	14.26	14.32	13.71	20.15	103.45	30.00
157	5785	13.63	13.77	15.23	13.83	20.19	104.39	30.00
165	5825	14.78	15.41	15.08	15.19	21.14	130.06	30.00

Note:
For U-NII-2A, U-NII-2C Band:

1. $11 \text{ dBm} + 10\log(20.66) = 24.15 \text{ dBm} > 24 \text{ dBm}$.
2. $11 \text{ dBm} + 10\log(25.05) = 24.99 \text{ dBm} > 24 \text{ dBm}$.
3. $11 \text{ dBm} + 10\log(25.13) = 25.00 \text{ dBm} > 24 \text{ dBm}$.
4. $11 \text{ dBm} + 10\log(24.50) = 24.89 \text{ dBm} > 24 \text{ dBm}$.
5. $11 \text{ dBm} + 10\log(20.74) = 24.17 \text{ dBm} > 24 \text{ dBm}$.
6. $11 \text{ dBm} + 10\log(23.02) = 24.62 \text{ dBm} > 24 \text{ dBm}$.

<802.11n HT20>

Channel	Channel Frequency (MHz)	Average Output Power (dBm)				Total Power		Limit (dBm)
		Ant 4	Ant 5	Ant 6	Ant 7	(dBm)	(mW)	
36	5180	16.65	16.13	16.04	16.51	22.36	172.21	30.00
40	5200	17.14	16.77	16.73	17.25	23.00	199.48	30.00
48	5240	15.82	15.73	17.81	17.88	22.95	197.38	30.00
52	5260	12.28	11.13	11.69	12.35	17.91	61.81	24.00
60	5300	11.51	11.46	10.80	11.63	17.38	54.73	24.00
64	5320	11.92	12.23	10.85	11.72	17.73	59.29	24.00
100	5500	12.46	11.69	12.13	11.42	17.96	62.57	24.00
116	5580	11.00	10.46	12.48	10.55	17.22	52.76	24.00
140	5700	10.02	10.94	10.41	10.49	16.50	44.65	24.00
149	5745	13.81	13.97	14.05	13.36	19.83	96.08	30.00
157	5785	14.02	14.22	15.38	14.39	20.56	113.65	30.00
165	5825	14.12	14.61	14.44	14.58	20.46	111.23	30.00

<802.11n HT40>

Channel	Channel Frequency (MHz)	Average Output Power (dBm)				Total Power		Limit (dBm)
		Ant 4	Ant 5	Ant 6	Ant 7	(dBm)	(mW)	
38	5190	17.25	18.67	18.81	17.50	24.13	258.98	30.00
46	5230	17.35	19.02	18.68	17.66	24.25	266.26	30.00
54	5270	13.41	14.15	12.26	13.18	19.32	85.55	24.00
62	5310	13.01	13.79	12.04	13.02	19.03	79.97	24.00
102	5510	13.11	13.58	13.64	12.52	19.26	84.25	24.00
110	5550	12.52	13.41	13.94	11.79	19.01	79.67	24.00
134	5670	11.13	12.46	13.37	12.29	18.40	69.26	24.00
151	5755	14.28	14.41	14.57	14.46	20.45	110.96	30.00
159	5795	13.45	13.47	14.01	13.32	19.59	91.02	30.00

<802.11ac VHT20>

Channel	Channel Frequency (MHz)	Average Output Power (dBm)				Total Power		Limit (dBm)
		Ant 4	Ant 5	Ant 6	Ant 7	(dBm)	(mW)	
36	5180	16.73	16.24	16.11	16.58	22.44	175.50	30.00
40	5200	17.26	16.83	16.81	17.34	23.09	203.58	30.00
48	5240	15.91	15.82	17.88	17.93	23.02	200.65	30.00
52	5260	12.33	11.25	11.76	12.42	17.99	62.89	24.00
60	5300	11.58	11.57	10.90	11.70	17.47	55.84	24.00
64	5320	12.01	12.32	10.97	11.77	17.82	60.48	24.00
100	5500	12.55	11.76	12.29	11.48	18.06	63.99	24.00
116	5580	11.03	10.52	12.61	10.69	17.32	53.91	24.00
140	5700	10.07	11.02	10.46	10.51	16.55	45.17	24.00
149	5745	13.88	14.03	14.17	13.50	19.92	98.24	30.00
157	5785	14.06	14.34	15.51	14.52	20.66	116.51	30.00
165	5825	14.18	14.74	14.58	14.66	20.57	113.92	30.00

<802.11ac VHT40>

Channel	Channel Frequency (MHz)	Average Output Power (dBm)				Total Power		Limit (dBm)
		Ant 4	Ant 5	Ant 6	Ant 7	(dBm)	(mW)	
38	5190	17.37	18.72	18.88	17.61	24.22	263.99	30.00
46	5230	17.41	19.13	18.77	17.75	24.34	271.83	30.00
54	5270	13.48	14.26	12.41	13.25	19.42	87.51	24.00
62	5310	13.11	13.95	12.12	13.04	19.12	81.73	24.00
102	5510	13.25	13.71	13.73	12.58	19.36	86.35	24.00
110	5550	12.59	13.46	14.02	11.88	19.08	80.99	24.00
134	5670	11.27	12.54	13.43	12.41	18.50	70.79	24.00
151	5755	14.36	14.55	14.66	14.58	20.56	113.75	30.00
159	5795	13.61	13.54	14.05	13.38	19.67	92.74	30.00

<802.11ac VHT80>

Channel	Channel Frequency (MHz)	Average Output Power (dBm)				Total Power		Limit (dBm)
		Ant 4	Ant 5	Ant 6	Ant 7	(dBm)	(mW)	
42	5210	15.23	16.51	16.04	14.75	21.71	148.15	30.00
58	5290	15.01	16.09	14.35	14.42	21.05	127.24	24.00
106	5530	14.96	15.47	15.61	13.94	21.06	127.74	24.00
122	5610	14.28	16.02	15.88	14.91	21.35	136.49	24.00
155	5775	15.25	15.22	15.35	15.22	21.28	134.31	30.00

<802.11ac VHT160>

Channel	Channel Frequency (MHz)	Average Output Power (dBm)				Total Power		Limit (dBm)
		Ant 4	Ant 5	Ant 6	Ant 7	(dBm)	(mW)	
50	5250	14.05	16.11	15.62	14.75	21.22	132.57	24.00
114	5570	11.69	12.88	13.36	11.81	18.51	71.01	24.00

<802.11ax HE20>

Channel	Channel Frequency (MHz)	Average Output Power (dBm)				Total Power		Limit (dBm)
		Ant 4	Ant 5	Ant 6	Ant 7	(dBm)	(mW)	
36	5180	16.82	16.30	16.22	16.73	22.55	179.72	30.00
40	5200	17.34	16.92	16.89	17.42	23.17	207.48	30.00
48	5240	15.98	15.91	17.94	17.98	23.09	203.66	30.00
52	5260	12.46	11.34	11.81	12.47	18.07	64.07	24.00
60	5300	11.69	11.63	10.96	11.81	17.56	56.96	24.00
64	5320	12.07	12.38	11.03	11.83	17.88	61.32	24.00
100	5500	12.64	11.89	12.38	11.59	18.16	65.54	24.00
116	5580	11.08	10.62	12.70	10.77	17.40	54.92	24.00
140	5700	10.15	11.06	10.58	10.62	16.64	46.08	24.00
149	5745	13.95	14.11	14.25	13.58	20.00	100.01	30.00
157	5785	14.14	14.44	15.58	14.63	20.75	118.92	30.00
165	5825	14.29	14.86	14.67	14.76	20.67	116.70	30.00

Note:
For U-NII-2A, U-NII-2C Band:

- 11 dBm + 10log (21.74) = 24.37 dBm > 24 dBm.
- 11 dBm + 10log (23.06) = 24.63 dBm > 24 dBm.
- 11 dBm + 10log (24.06) = 24.81 dBm > 24 dBm.
- 11 dBm + 10log (25.09) = 25.00 dBm > 24 dBm.
- 11 dBm + 10log (21.94) = 24.41 dBm > 24 dBm.
- 11 dBm + 10log (22.66) = 24.55 dBm > 24 dBm.

<802.11ax HE40>

Channel	Channel Frequency (MHz)	Average Output Power (dBm)				Total Power		Limit (dBm)
		Ant 4	Ant 5	Ant 6	Ant 7	(dBm)	(mW)	
38	5190	17.43	18.83	18.93	17.67	24.29	268.36	30.00
46	5230	17.46	19.21	18.82	17.82	24.41	275.83	30.00
54	5270	13.62	14.32	12.49	13.31	19.50	89.22	24.00
62	5310	13.24	14.04	12.17	13.15	19.22	83.57	24.00
102	5510	13.42	13.82	13.81	12.63	19.47	88.44	24.00
110	5550	12.71	13.53	14.06	11.94	19.15	82.31	24.00
134	5670	11.38	12.67	13.51	12.47	18.59	72.33	24.00
151	5755	14.42	14.59	14.79	14.71	20.65	116.15	30.00
159	5795	13.69	13.64	14.16	13.43	19.76	94.60	30.00

Note:
For U-NII-2A, U-NII-2C Band:

1. $11 \text{ dBm} + 10\log(39.40) = 26.96 \text{ dBm} > 24 \text{ dBm}$.
2. $11 \text{ dBm} + 10\log(39.56) = 26.97 \text{ dBm} > 24 \text{ dBm}$.
3. $11 \text{ dBm} + 10\log(39.64) = 26.98 \text{ dBm} > 24 \text{ dBm}$.
4. $11 \text{ dBm} + 10\log(39.40) = 26.96 \text{ dBm} > 24 \text{ dBm}$.
5. $11 \text{ dBm} + 10\log(39.48) = 26.96 \text{ dBm} > 24 \text{ dBm}$.

<802.11ax HE80>

Channel	Channel Frequency (MHz)	Average Output Power (dBm)				Total Power		Limit (dBm)
		Ant 4	Ant 5	Ant 6	Ant 7	(dBm)	(mW)	
42	5210	15.29	16.58	16.11	14.89	21.79	150.97	30.00
58	5290	15.06	16.15	14.42	14.48	21.11	129.00	24.00
106	5530	15.04	15.54	15.70	14.02	21.14	130.11	24.00
122	5610	14.34	16.08	15.95	14.99	21.42	138.62	24.00
155	5775	15.39	15.30	15.41	15.27	21.36	136.88	30.00

Note:
For U-NII-2A, U-NII-2C Band:

1. $11 \text{ dBm} + 10\log(80.08) = 30.04 \text{ dBm} > 24 \text{ dBm}$.
2. $11 \text{ dBm} + 10\log(80.24) = 30.04 \text{ dBm} > 24 \text{ dBm}$.
3. $11 \text{ dBm} + 10\log(79.76) = 30.02 \text{ dBm} > 24 \text{ dBm}$.

<802.11ax HE160>

Channel	Channel Frequency (MHz)	Average Output Power (dBm)				Total Power		Limit (dBm)
		Ant 4	Ant 5	Ant 6	Ant 7	(dBm)	(mW)	
50	5250	14.10	16.19	15.70	14.88	21.31	135.21	24.00
114	5570	11.76	12.97	13.49	11.85	18.60	72.46	24.00

Note:
For U-NII-2A, U-NII-2C Band:

1. $11 \text{ dBm} + 10\log(80.88) = 30.08 \text{ dBm} > 24 \text{ dBm}$.
2. $11 \text{ dBm} + 10\log(163.36) = 33.13 \text{ dBm} > 24 \text{ dBm}$.

Beamforming
<802.11ac VHT20>

Channel	Channel Frequency (MHz)	Average Output Power (dBm)				Total Power		Limit (dBm)
		Ant 4	Ant 5	Ant 6	Ant 7	(dBm)	(mW)	
36	5180	17.52	17.01	16.84	17.22	23.18	207.76	25.13
40	5200	16.78	16.13	16.36	17.00	22.60	182.03	25.13
48	5240	15.03	14.84	16.98	16.77	22.03	159.74	25.13
52	5260	11.25	10.13	10.68	11.37	16.91	49.04	19.23
60	5300	11.07	11.02	10.48	11.19	16.97	49.76	19.23
64	5320	10.91	11.24	10.05	10.76	16.78	47.66	19.23
100	5500	12.04	11.25	11.86	10.84	17.54	56.81	19.38
116	5580	10.01	10.02	12.41	10.13	16.79	47.79	19.38
140	5700	10.32	11.13	10.74	10.65	16.74	47.21	19.38
149	5745	13.22	13.26	13.53	12.79	19.23	83.73	25.55
157	5785	12.88	12.95	14.52	12.80	19.37	86.50	25.55
165	5825	13.02	13.61	13.44	13.59	19.44	87.94	25.55

<802.11ac VHT40>

Channel	Channel Frequency (MHz)	Average Output Power (dBm)				Total Power		Limit (dBm)
		Ant 4	Ant 5	Ant 6	Ant 7	(dBm)	(mW)	
38	5190	15.05	16.13	16.24	14.82	21.63	145.42	25.13
46	5230	16.24	18.13	17.69	16.64	23.26	211.97	25.13
54	5270	13.01	13.72	11.96	12.55	18.88	77.24	19.23
62	5310	12.55	14.02	12.06	12.04	18.77	75.29	19.23
102	5510	13.13	13.66	13.71	12.27	19.25	84.15	19.38
110	5550	12.48	13.33	14.02	11.75	19.00	79.43	19.38
134	5670	11.71	12.89	13.75	12.70	18.84	76.61	19.38
151	5755	14.62	14.88	15.03	14.93	20.89	122.69	25.55
159	5795	14.14	14.18	14.36	14.17	20.23	105.54	25.55

<802.11ac VHT80>

Channel	Channel Frequency (MHz)	Average Output Power (dBm)				Total Power		Limit (dBm)
		Ant 4	Ant 5	Ant 6	Ant 7	(dBm)	(mW)	
42	5210	14.89	16.42	16.01	14.79	21.61	144.72	25.13
58	5290	13.02	14.05	12.31	12.22	18.98	79.15	19.23
106	5530	12.79	13.38	13.67	11.84	19.00	79.34	19.38
122	5610	10.23	12.15	12.11	11.02	17.47	55.85	19.38
155	5775	14.58	14.51	14.78	14.69	20.66	116.46	25.55

<802.11ac VHT160>

Channel	Channel Frequency (MHz)	Average Output Power (dBm)				Total Power		Limit (dBm)
		Ant 4	Ant 5	Ant 6	Ant 7	(dBm)	(mW)	
50	5250	11.61	13.73	13.24	12.03	18.76	75.14	19.23
114	5570	10.85	11.08	13.44	10.15	17.59	57.42	19.38

<802.11ax HE20>

Channel	Channel Frequency (MHz)	Average Output Power (dBm)				Total Power		Limit (dBm)
		Ant 4	Ant 5	Ant 6	Ant 7	(dBm)	(mW)	
36	5180	17.61	17.04	16.92	17.30	23.25	211.17	25.13
40	5200	16.83	16.25	16.45	17.04	22.67	185.10	25.13
48	5240	15.15	14.92	17.03	16.83	22.11	162.44	25.13
52	5260	11.31	10.22	10.78	11.46	16.99	50.00	19.23
60	5300	11.15	11.07	10.54	11.28	17.04	50.58	19.23
64	5320	10.97	11.32	10.09	10.82	16.84	48.34	19.23
100	5500	12.10	11.34	11.91	10.91	17.61	57.69	19.38
116	5580	10.09	10.06	12.54	10.22	16.89	48.82	19.38
140	5700	10.45	11.22	10.82	10.71	16.83	48.19	19.38
149	5745	13.30	13.42	13.62	12.91	19.34	85.92	25.55
157	5785	12.95	13.02	14.61	12.87	19.45	88.04	25.55
165	5825	13.11	13.69	13.53	13.67	19.53	89.68	25.55

Note:
For U-NII-2A, U-NII-2C Band:

1. $11 \text{ dBm} + 10\log(22.18) = 24.46 \text{ dBm} > 24 \text{ dBm}$.
2. $11 \text{ dBm} + 10\log(25.41) = 25.05 \text{ dBm} > 24 \text{ dBm}$.
3. $11 \text{ dBm} + 10\log(22.54) = 24.53 \text{ dBm} > 24 \text{ dBm}$.
4. $11 \text{ dBm} + 10\log(23.94) = 24.79 \text{ dBm} > 24 \text{ dBm}$.
5. $11 \text{ dBm} + 10\log(21.70) = 24.36 \text{ dBm} > 24 \text{ dBm}$.
6. $11 \text{ dBm} + 10\log(22.70) = 24.56 \text{ dBm} > 24 \text{ dBm}$.

<802.11ax HE40>

Channel	Channel Frequency (MHz)	Average Output Power (dBm)				Total Power		Limit (dBm)
		Ant 4	Ant 5	Ant 6	Ant 7	(dBm)	(mW)	
38	5190	15.12	16.26	16.39	14.91	21.74	149.30	25.13
46	5230	16.31	18.20	17.81	16.73	23.35	216.32	25.13
54	5270	13.04	13.78	12.02	12.62	18.93	78.22	19.23
62	5310	12.65	14.07	12.14	12.12	18.84	76.60	19.23
102	5510	13.27	13.75	13.78	12.38	19.35	86.12	19.38
110	5550	12.60	13.47	14.06	11.83	19.09	81.14	19.38
134	5670	11.82	13.01	13.84	12.81	18.95	78.51	19.38
151	5755	14.74	14.93	15.11	15.03	20.98	125.18	25.55
159	5795	14.21	14.28	14.48	14.26	20.33	107.88	25.55

Note:
For U-NII-2A, U-NII-2C Band:

1. $11 \text{ dBm} + 10\log(39.40) = 26.96 \text{ dBm} > 24 \text{ dBm}$.
2. $11 \text{ dBm} + 10\log(39.56) = 26.97 \text{ dBm} > 24 \text{ dBm}$.
3. $11 \text{ dBm} + 10\log(39.48) = 26.96 \text{ dBm} > 24 \text{ dBm}$.
4. $11 \text{ dBm} + 10\log(39.48) = 26.96 \text{ dBm} > 24 \text{ dBm}$.
5. $11 \text{ dBm} + 10\log(39.48) = 26.96 \text{ dBm} > 24 \text{ dBm}$.

<802.11ax HE80>

Channel	Channel Frequency (MHz)	Average Output Power (dBm)				Total Power		Limit (dBm)
		Ant 4	Ant 5	Ant 6	Ant 7	(dBm)	(mW)	
42	5210	15.09	16.56	16.17	14.92	21.76	150.02	25.13
58	5290	13.13	14.16	12.38	12.30	19.08	80.90	19.23
106	5530	12.87	13.43	13.78	11.98	19.09	81.05	19.38
122	5610	10.27	12.28	12.24	11.11	17.57	57.21	19.38
155	5775	14.61	14.63	14.82	14.72	20.72	117.93	25.55

Note:
For U-NII-2A, U-NII-2C Band:

1. $11 \text{ dBm} + 10\log(80.08) = 30.04 \text{ dBm} > 24 \text{ dBm}$.
2. $11 \text{ dBm} + 10\log(79.92) = 30.03 \text{ dBm} > 24 \text{ dBm}$.
3. $11 \text{ dBm} + 10\log(79.76) = 30.02 \text{ dBm} > 24 \text{ dBm}$.

<802.11ax HE160>

Channel	Channel Frequency (MHz)	Average Output Power (dBm)				Total Power		Limit (dBm)
		Ant 4	Ant 5	Ant 6	Ant 7	(dBm)	(mW)	
50	5250	11.72	13.81	13.32	12.09	18.84	76.56	19.23
114	5570	10.91	11.19	13.53	10.19	17.67	58.47	19.38

Note:
For U-NII-2A, U-NII-2C Band:

1. $11 \text{ dBm} + 10\log(80.56) = 30.06 \text{ dBm} > 24 \text{ dBm}$.
2. $11 \text{ dBm} + 10\log(162.08) = 33.10 \text{ dBm} > 24 \text{ dBm}$.

5.1.3 Transmit Power Control (TPC)

U-NII devices operating in the 5.25-5.35 GHz band and the 5.47-5.725 GHz band shall employ a TPC mechanism. The U-NII device is required to have capability to operate at least 6 dB below the mean EIRP value of 30 dBm. A TPC mechanism is not required for systems with an e.i.r.p of less than 500 mW.

Maximum EIRP of this device is 993.12 mW which is less than 500mW, therefore it's not require TPC function.

TPC	E.I.R.P	15.407(h)(1)
V	> 500mW	The TPC mechanism is required for system with an E.I.R.P. of above 500mW
	< 500mW	-

5.1.4 26 dB Bandwidth and 99% Occupied Bandwidth

Kind of Test Site Shielded room

Test Setup

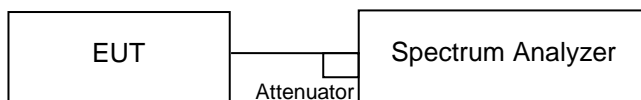

Test Instruments

Kind of Equipment	Manufacturer	Type	S/N	Calibration Date	Calibration Due Date	Test Date	
						From	Until
Spectrum Analyzer	Agilent	N9010A	MY53470241	2022/6/15	2023/6/14	2022/8/18	2022/10/6

Test Procedure

- a. Set RBW = approximately 1% of the emission bandwidth.
- b. Set the VBW > RBW.
- c. Detector = Peak.
- d. Trace mode = max hold.
- e. Measure the maximum width of the emission that is 26 dB down from the peak of the emission. Compare this with the RBW setting of the analyzer. Readjust RBW and repeat measurement as needed until the RBW/EBW ratio is approximately 1%.
- f. For 99% Bandwidth Measurement, the transmitter output was connected to the spectrum analyzer through an attenuator. The bandwidth of the fundamental frequency was measured by spectrum analyzer with resolution bandwidth in the range of 1% to 5% of the anticipated emission bandwidth, and a video bandwidth at least 3x the resolution bandwidth and set the detector to PEAK. The width of a frequency band such that, below the lower and above the upper frequency limits, the mean powers emitted are each equal to a specified percentage 0.5% of the total mean power of a given emission.

Test Results

Please refer to Appendix A~B.

5.1.5 6 dB Bandwidth (5725-5850MHz)

Kind of Test Site Shielded room

Test Setup

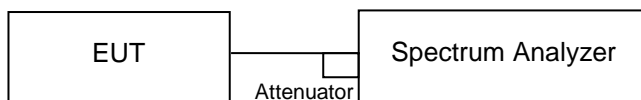

Test Instruments

Kind of Equipment	Manufacturer	Type	S/N	Calibration Date	Calibration Due Date	Test Date	
						From	Until
Spectrum Analyzer	Agilent	N9010A	MY53470241	2022/6/15	2023/6/14	2022/8/18	2022/10/6

Test Procedure

MEASUREMENT PROCEDURE REF

- a. Set resolution bandwidth (RBW) = 100 kHz
- b. Set the video bandwidth (VBW) $\geq 3 \times$ RBW, Detector = Peak.
- c. Trace mode = max hold.
- d. Sweep = auto couple.
- e. Measure the maximum width of the emission that is constrained by the frequencies associated with the two amplitude points (upper and lower) that are attenuated by 6 dB relative to the maximum level measured in the fundamental emission.

Test Results

Please refer to Appendix A~B.

5.1.6 Frequency Stability Measurement

Kind of Test Site Shielded room

Test Setup

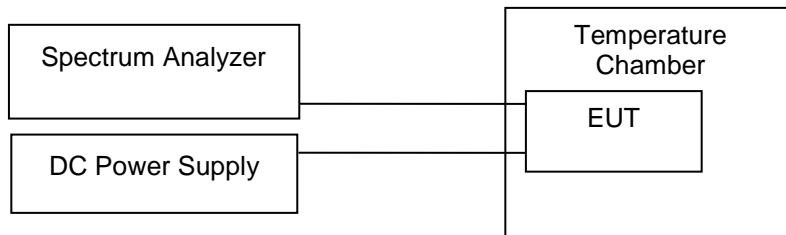

Test Instruments

Kind of Equipment	Manufacturer	Type	S/N	Calibration Date	Calibration Due Date	Test Date	
						From	Until
Spectrum Analyzer	Agilent	N9010A	MY53470241	2022/6/15	2023/6/14	2022/8/18	2022/10/6

Test Procedure

- a. To ensure emission at the band edge is maintained within the authorized band, those values shall be measured by radiation emissions at upper and lower frequency points, and finally compensated by frequency deviation as procedures below.
- b. The EUT was operated at the maximum output power, and connected to the spectrum analyzer, which is set to maximum hold function and peak detector. The peak value of the power envelope was measured and noted. The upper and lower frequency points were respectively measured relatively 10 dB lower than the measured peak value.
- c. The frequency deviation was calculated by adding the upper frequency point and the lower frequency point divided by two. Those detailed values of frequency deviation are provided in table below.

Test Results

Frequency (MHz)	5180			
Voltage (Vac)	Measurement Frequency (MHz)			Max. Deviation (ppm)
121	5179.98032			3.799
110	5179.97829			4.191
99	5179.98292			3.297
Temperature (°C)	Measurement Frequency (MHz)			
	0 Minute	2 Minute	5 Minute	10 Minute
40	5179.98119	5179.97395	5179.96961	5179.96758
30	5179.978394	5179.979896	5179.980524	5179.981179
20	5179.97829	5179.97135	5179.96787	5179.96758
10	5179.978718	5179.983307	5179.996168	5179.998917
0	5180.001576	5180.011897	5180.022077	5180.027345
-10	5180.03589	5180.03821	5180.03965	5180.04139
Max. Deviation (ppm)	6.929	7.376	7.654	7.990

5.1.7 Power Spectral Density

Limit

For the 5.15~5.25GHz Bands:

For mobile and portable client devices in the 5.15~5.25GHz band, the Maximum Power spectral density shall not exceed 11dBm/MHz. For an indoor access point operating in the band 5.15~5.25GHz, the maximum power spectral density shall not exceed 17dBm/MHz.

For the 5.25~5.35GHz and 5.47~5.725GHz Bands:

The maximum power spectral density shall not exceed 11dBm/MHz.

For the 5.745~5.85GHz Bands:

The maximum power spectral density shall not exceed 30dBm/500kHz.

Kind of Test Site Shielded room

Test Setup

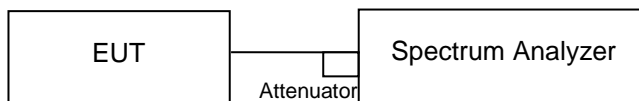

Test Instruments

Kind of Equipment	Manufacturer	Type	S/N	Calibration Date	Calibration Due Date	Test Date	
						From	Until
Spectrum Analyzer	Agilent	N9010A	MY53470241	2022/6/15	2023/6/14	2022/8/18	2022/10/6

Test Procedure**For U-NII-1, U-NII-2A, U-NII-2C band:**

Using method SA-2

1. Set span to encompass the entire emission bandwidth (EBW) of the signal.
2. Set RBW = 1 MHz, Set VBW \geq 3 MHz, Detector = RMS
3. Sweep time = auto, trigger set to "free run".
4. Trace average at least 100 traces in power averaging mode.
5. Record the max value and add 10 log (1/duty cycle)

※For U-NII-3:

1. Set span to encompass the entire emission bandwidth (EBW) of the signal.
2. Set RBW = 500 kHz, Set VBW \geq 3 RBW, Detector = RMS
3. Use the peak marker function to determine the maximum power level in any 500 kHz band segment within the fundamental EBW.
4. Sweep time = auto, trigger set to "free run".
5. Trace average at least 100 traces in power averaging mode.
6. Record the max value and add 10 log (1/duty cycle)

For MIMO mode, calculation method follows FCC KDB 662911 Method 2) a) of power density measurement using for calculating total power density. Total power density is summing entire spectra across corresponding frequency bins on the various outputs by computer.

Test Results

Please refer to Appendix A~B.

5.1.8 Radiated Spurious Emissions

Limit

Radiated emissions which fall in the restricted bands, as defined in §15.205(a), must comply with the radiated emission limits specified in §15.209(a).

Emissions radiated outside the restricted and authorized frequency bands must either comply with the radiated emission limits specified for the restricted bands or in §15.407(b).

Kind of Test Site 3m Semi-Anechoic Chamber

Test Setup

<Radiated Emissions below 30 MHz>

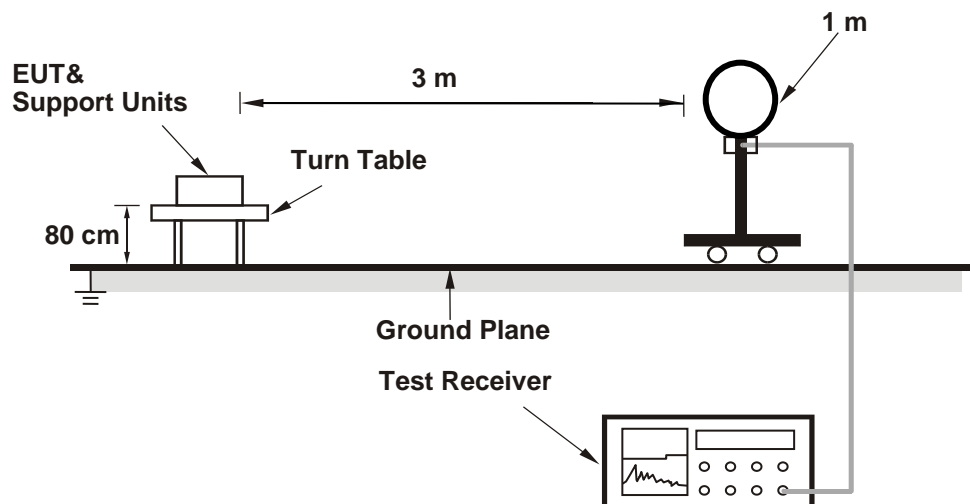

<Radiated Emissions 30 MHz to 1 GHz>

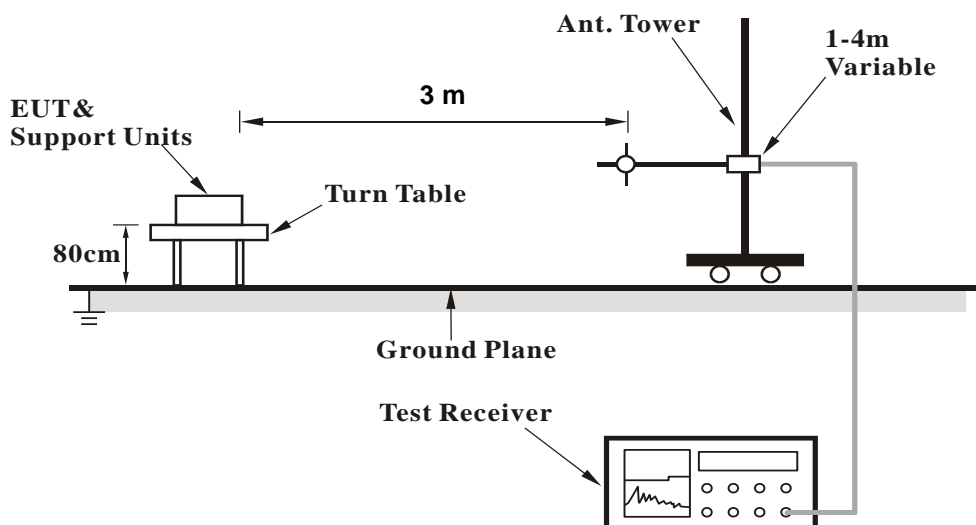

<Radiated Emissions above 1 GHz>

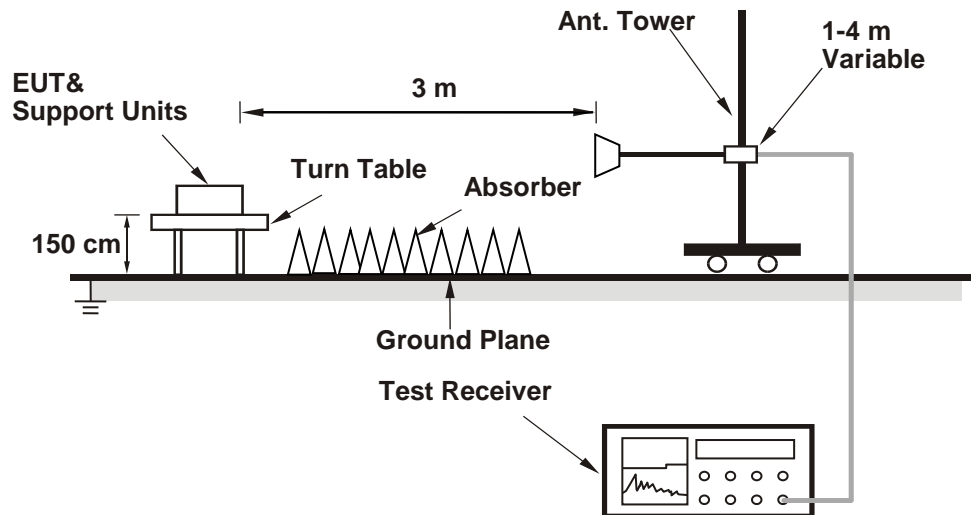

For the actual test configuration, please refer to the attached file (Test Setup Photo).

Test Instruments

Kind of Equipment	Manufacturer	Type	S/N	Calibration Date	Calibration Due Date
Above 1 GHz					
Signal Analyzer	R&S	FSV40	101508	2022/4/13	2023/4/12
Horn Antenna	ETS-Lindgren	3117	00218929	2021/11/25	2022/11/24
HF-AMP + AC source	EMCI	EMC051845SE	980635	2022/1/20	2023/1/19
HF-AMP + AC source	EMCI	EMC184045SE	980656	2022/1/20	2023/1/19
Horn Antenna	SCHWARZBECK	BBHA 9170	00887	2022/3/29	2023/3/28
Test Software	Audix E3	15914a_20191106 tuv	PK-001087	N/A	N/A
30 MHz ~ 1 GHz					
Receiver	R&S	ESR7	102108	2022/4/28	2023/4/27
Bilog Antenna	SCHWARZBECK	VULB-9168	00950	2022/4/6	2023/4/5
LF-AMP	Agilent	8447D	2944A107722	2022/3/22	2023/3/21
Test Software	Audix E3	15914a_20191106 tuv	PK-001087	N/A	N/A
Below 30 MHz					
Receiver	R&S	ESR7	102108	2022/4/28	2023/4/27
Loop Antenna	SCHWARZBECK	FMZB 1519B	00215	2021/12/8	2022/12/7
Test Software	Audix E3	15914a_20191106 tuv	PK-001087	N/A	N/A

Test Procedures**For Radiated Emissions below 30 MHz**

- a. The EUT was placed on the top of a rotating table 0.8 meters above the ground at a 3 meter chamber room. The table was rotated 360 degrees to determine the position of the highest radiation.
- b. The EUT was set 3 meters away from the interference-receiving antenna, which was mounted on the top of a variable-height antenna tower.
- c. Parallel (OPEN), perpendicular (CLOSE), and ground-parallel (GROUND) orientations of the antenna are set to make the measurement.
- d. For each suspected emission, the EUT was arranged to its worst case and the rotatable table was turned from 0 degrees to 360 degrees to find the maximum reading.
- e. The test-receiver system was set to Quasi-Peak Detect Function and Specified Bandwidth with Maximum Hold Mode.

Note:

1. The resolution bandwidth and video bandwidth of test receiver/spectrum analyzer is 9 kHz at frequency below 30 MHz.
2. All modes of operation were investigated and the worst-case emissions are reported.

For Radiated Emissions above 30 MHz

- a. The EUT was placed on the top of a rotating table 0.8 meters (for 30 MHz ~ 1 GHz) / 1.5 meters (for above 1 GHz) above the ground at 3 meter chamber room for test. The table was rotated 360 degrees to determine the position of the highest radiation.
- b. The EUT was set 3 meters away from the interference-receiving antenna, which was mounted on the top of a variable-height antenna tower.
- c. The height of antenna is varied from one meter to four meters above the ground to determine the maximum value of the field strength. Both horizontal and vertical polarizations of the antenna are set to make the measurement.
- d. For each suspected emission, the EUT was arranged to its worst case and then the antenna was tuned to heights from 1 meter to 4 meters and the rotatable table was turned from 0 degrees to 360 degrees to find the maximum reading.
- e. The test-receiver system was set to quasi-peak detect function and specified bandwidth with maximum hold mode when the test frequency is below 1 GHz.
- f. The test-receiver system was set to peak and average detected function and specified bandwidth with maximum hold mode when the test frequency is above 1 GHz. If the peak reading value also meets average limit, measurement with the average detector is unnecessary.

Note:

1. The resolution bandwidth and video bandwidth of test receiver/spectrum analyzer is 120 kHz for Quasi-peak detection (QP) or Peak detection (PK) at frequency below 1 GHz.
2. The resolution bandwidth of test receiver/spectrum analyzer is 1 MHz and the video bandwidth is 3 MHz for Peak detection (PK) at frequency above 1 GHz.
3. The resolution bandwidth of test receiver/spectrum analyzer is 1 MHz and the video bandwidth is $\geq 1/T$ (Duty cycle < 98 %) or 10 Hz (Duty cycle ≥ 98 %) for Average detection (AV) at frequency above 1 GHz.
4. All modes of operation were investigated and the worst-case emissions are reported.
5. The Radiated Emissions testing was performed in the X(E1), Y(H) and Z(E2) axis orientation. The worst-case Axis orientation is recorded in this test report.

Prüfbericht - Nr.: CN22QGFA (P15E-WiFi) 001
Test Report No.

Seite 41 von 140
Page 41 of 140

Test Results

Factor (dB/m) = Antenna Factor (dB/m) + Cable Loss (dB)
Level (dBuV/m) = Reading (dBuV) + Factor (dB/m)

Please refer to Appendix C-D.

5.1.9 Dynamic Frequency Selection

Limit

<DFS Detection Thresholds for Master Devices and Client Devices with Radar Detection>

Maximum Transmit Power	Value (See Notes 1, 2, and 3)
EIRP \geq 200 milliwatt	-64 dBm
EIRP < 200 milliwatt and power spectral density < 10 dBm/MHz	-62 dBm
EIRP < 200 milliwatt that do not meet the power spectral density requirement	-64 dBm

Note 1: This is the level at the input of the receiver assuming a 0 dBi receive antenna.
 Note 2: Throughout these test procedures an additional 1 dB has been added to the amplitude of the test transmission waveforms to account for variations in measurement equipment. This will ensure that the test signal is at or above the detection threshold level to trigger a DFS response.
 Note 3: EIRP is based on the highest antenna gain. For MIMO devices refer to KDB Publication 662911 D01.

<DFS Response Requirement Values>

Parameter	Value
<i>Non-occupancy period</i>	Minimum 30 minutes
<i>Channel Availability Check Time</i>	60 seconds
<i>Channel Move Time</i>	10 seconds See Note 1.
<i>Channel Closing Transmission Time</i>	200 milliseconds + an aggregate of 60 milliseconds over remaining 10 second period. See Notes 1 and 2.
<i>U-NII Detection Bandwidth</i>	Minimum 100% of the U-NII 99% transmission power bandwidth. See Note 3.

Note 1: *Channel Move Time* and the *Channel Closing Transmission Time* should be performed with Radar Type 0. The measurement timing begins at the end of the Radar Type 0 burst.
 Note 2: The *Channel Closing Transmission Time* is comprised of 200 milliseconds starting at the beginning of the *Channel Move Time* plus any additional intermittent control signals required to facilitate a *Channel* move (an aggregate of 60 milliseconds) during the remainder of the 10 second period. The aggregate duration of control signals will not count quiet periods in between transmissions.
 Note 3: During the *U-NII Detection Bandwidth* detection test, radar type 0 should be used. For each frequency step the minimum percentage of detection is 90 percent. Measurements are performed with no data traffic.

Kind of Test Site Shielded room

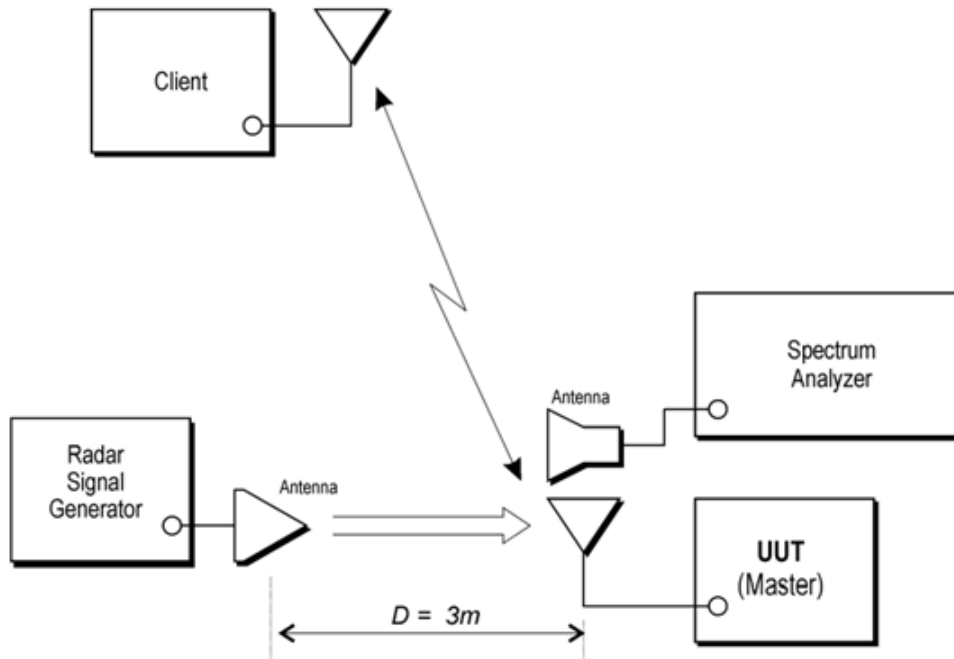
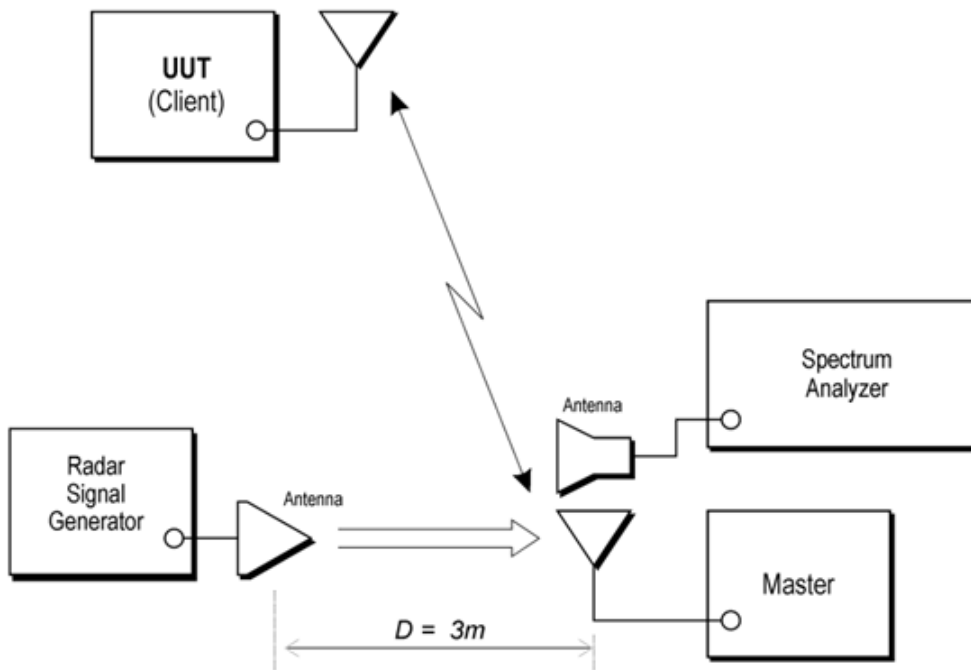
Test Setup
<Setup for Master with injection at the Master>

<Setup for Client with injection at the Master>

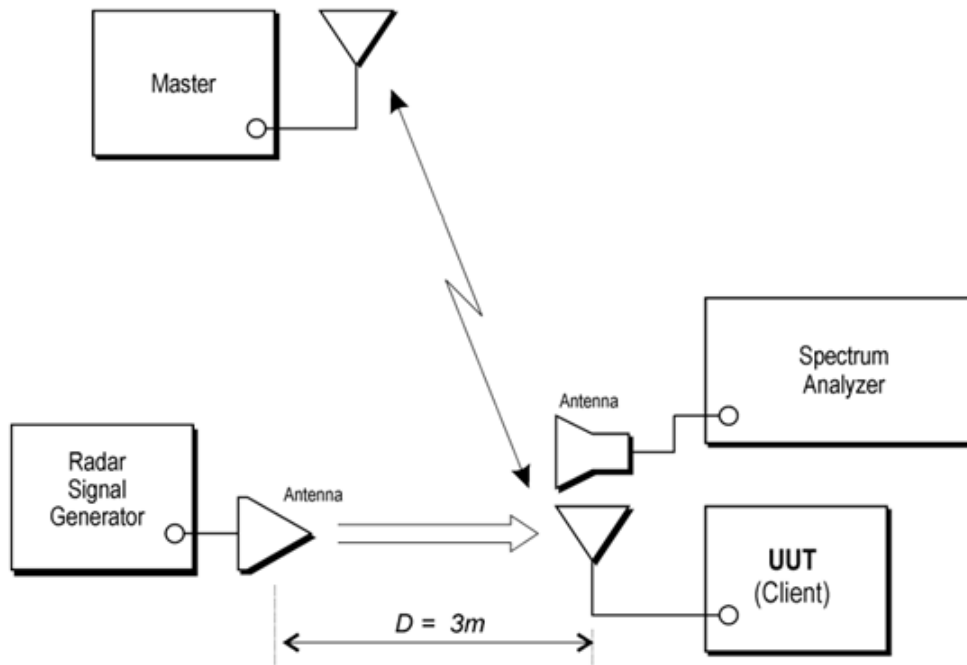
<Setup for Client with injection at the Client>



Test Instruments

Kind of Equipment	Manufacturer	Type	S/N	Calibration Date	Calibration Due Date	Test Date	
						From	Until
Spectrum Analyzer	Agilent	N9010A	MY52221334	2022/3/9	2023/3/8	2022/9/21	2022/10/3
MXG Vector Signal Generator	Agilent	N5182B	MY53050524	2022/3/9	2023/3/8	2022/9/21	2022/10/3

Requirement

<Applicability of DFS Requirements Prior to Use of a Channel>

Requirement	Operational Mode		
	Master	Client Without Radar Detection	Client With Radar Detection
<i>DFS Detection Threshold</i>	Yes	Not required	Yes
<i>Channel Closing Transmission Time</i>	Yes	Yes	Yes
<i>Channel Move Time</i>	Yes	Yes	Not required
<i>U-NII Detection Bandwidth</i>	Yes	Not required	Yes

<Applicability of DFS requirements during normal operation>

Requirement	Operational Mode	
	Master Device or Client with Radar Detection	Client Without Radar Detection
<i>DFS Detection Threshold</i>	Yes	Not required
<i>Channel Closing Transmission Time</i>	Yes	Yes
<i>Channel Move Time</i>	Yes	Yes
<i>U-NII Detection Bandwidth</i>	Yes	Not required

Additional requirements for devices with multiple bandwidth modes	Master Device or Client with Radar Detection	Client Without Radar Detection
<i>U-NII Detection Bandwidth and Statistical Performance Check</i>	All BW modes must be tested	Not required
<i>Channel Move Time and Channel Closing Transmission Time</i>	Test using widest BW mode available	Test using the widest BW mode available for the link
<i>All other tests</i>	Any single BW mode	Not required

Note: Frequencies selected for statistical performance check (Section 7.8.4) should include several frequencies within the radar detection bandwidth and frequencies near the edge of the radar detection bandwidth. For 802.11 devices it is suggested to select frequencies in each of the bonded 20 MHz channels and the channel center frequency.

Channel Loading

<input type="checkbox"/>	a) The data file must be of a type that is typical for the device (i.e., MPEG-2, MPEG-4, WAV, MP3, MP4, AVI, etc.) and must generally be transmitting in a streaming mode.
<input type="checkbox"/>	b) Software to ping the client is permitted to simulate data transfer but must have random ping intervals.
<input checked="" type="checkbox"/>	c) Timing plots are required with calculations demonstrating a minimum channel loading of approximately 17% or greater.
<input type="checkbox"/>	d) Unicast or Multicast protocols are preferable but other protocols may be used. The appropriate protocol used must be described in the test procedures.

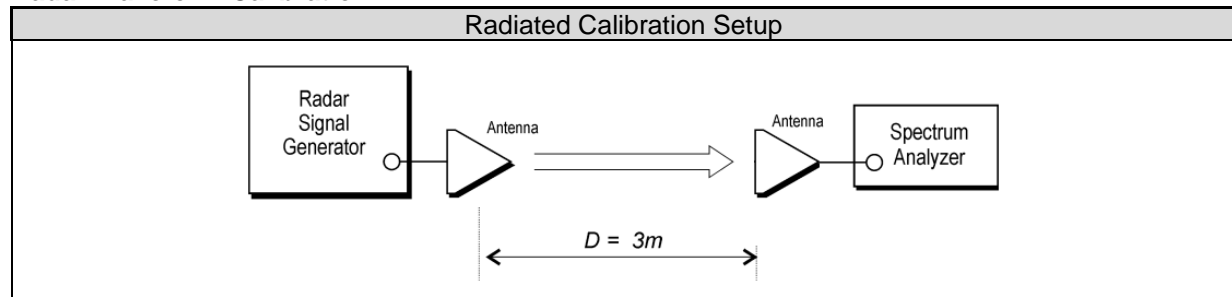
Test Procedures
Radar Waveform Calibration

The Interference Radar Detection Threshold Level is $-64\text{dBm} + 0 [\text{dBi}] + 1 \text{ dB} = -63 \text{ dBm}$ that had beentaken into account the output power range and antenna gain. the tested level is lower than required level for 1dB, hence it provides margin to the limit.

U-NII Detection Bandwidth

- a) Adjust the equipment to produce a single Burst of the Short Pulse Radar Types 0 at the center frequency of the UUT Operating Channel at the specified DFS Detection Threshold level.
- b) Set the UUT up as a standalone device (no associated Client or Master, as appropriate) and no traffic. Frame based systems will be set to a talk/listen ratio reflecting the worst case (maximum) that is user configurable during this test.
- c) Generate a single radar Burst, and note the response of the UUT. Repeat for a minimum of 10 trials. The UUT must detect the Radar Waveform within the DFS band using the specified U-NII Detection Bandwidth criterion. In cases where the channel bandwidth may exceed past the DFS band edge on specific channels (i.e., 802.11ac or wideband frame based systems) select a channel that has the entire emission bandwidth within the DFS band. If this is not possible, test the detection BW to the DFS band edge.
- d) Starting at the center frequency of the UUT operating Channel, increase the radar frequency in 5 MHz steps, repeating the above test sequence, until the detection rate falls below the U-NII Detection Bandwidth criterion specified in this section limit. Repeat this measurement in 1MHz steps at frequencies 5 MHz below where the detection rate begins to fall. Record the highest frequency (denote as F_H) at which detection is greater than or equal to the U-NII Detection Bandwidth criterion. Recording the detection rate at frequencies above F_H is not required to demonstrate compliance.
- e) Starting at the center frequency of the UUT operating Channel, decrease the radar frequency in 5 MHz steps, repeating the above test sequence, until the detection rate falls below the U-NII Detection Bandwidth criterion specified in this section limit. Repeat this measurement in 1MHz steps at frequencies 5 MHz above where the detection rate begins to fall. Record the lowest frequency (denote as F_L) at which detection is greater than or equal to the U-NII Detection Bandwidth criterion. Recording the detection rate at frequencies below F_L is not required to demonstrate compliance.
- f) The U-NII Detection Bandwidth is calculated as follows:

$$\text{U-NII Detection Bandwidth} = F_H - F_L$$

Channel Availability Check Time

<Initial Channel Availability Check Time>

This test does not use any Radar Waveforms and only needs to be performed one time.

- a) The U-NII devices will be powered on and be instructed to operate on the appropriate U-NII Channel that must incorporate DFS functions. At the same time the UUT is powered on, the spectrum analyzer will be set to zero span mode with a 3 MHz RBW and 3 MHz VBW on the Channel occupied by the radar (Chr) with a 2.5 minute sweep time. The spectrum analyzer's sweep will be started at the same time power is applied to the U-NII device.
- b) The UUT should not transmit any beacon or data transmissions until at least 1 minute after the completion of the power-on cycle.
- c) Confirm that the UUT initiates transmission on the channel.

< Radar Burst at the Beginning of the Channel Availability Check Time Measurement>

The steps below define the procedure to verify successful radar detection on the test Channel during a period equal to the Channel Availability Check Time and avoidance of operation on that Channel when a radar Burst with a level equal to the DFS Detection Threshold + 1 dB occurs at the beginning of the Channel Availability Check Time.

- a) The UUT is powered on at T_0 . T_1 denotes the instant when the UUT has completed its power-up sequence ($T_{\text{power_up}}$). The Channel Availability Check Time commences on Chr at instant T_1 and will end no sooner than $T_1 + T_{\text{ch_avail_check}}$.
- b) A single Burst of one of the Short Pulse Radar Types 0-4 will commence within a 6 second window starting at T_1 . An additional 1 dB is added to the radar test signal to ensure it is at or above the DFS Detection Threshold, accounting for equipment variations/errors.
- c) Visual indication or measured results on the UUT of successful detection of the radar Burst will be recorded and reported. Observation of Chr for UUT emissions will continue for 2.5 minutes after the radar Burst has been generated.
- d) Verify that during the 2.5 minute measurement window no UUT transmissions occurred on Chr. The Channel Availability Check results will be recorded.

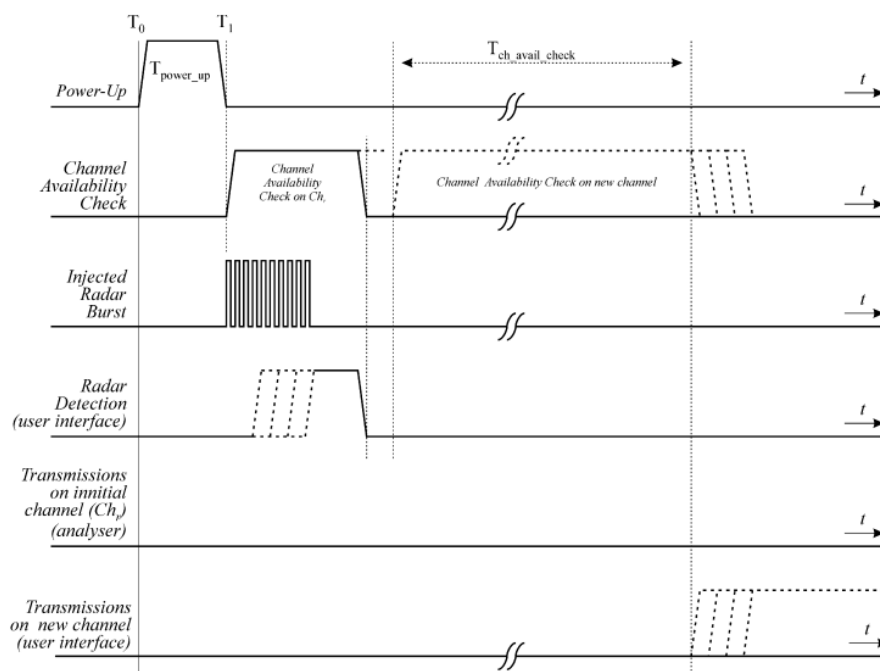

< Radar Burst at the End of the Channel Availability Check Time >

The steps below define the procedure to verify successful radar detection on the test Channel during a period equal to the Channel Availability Check Time and avoidance of operation on that Channel when a radar Burst with a level equal to the DFS Detection Threshold + 1dB occurs at the end of the Channel Availability Check Time.

- The UUT is powered on at T_0 . T_1 denotes the instant when the UUT has completed its power-up sequence ($T_{\text{power_up}}$). The Channel Availability Check Time commences on Chr at instant T_1 and will end no sooner than $T_1 + T_{\text{ch_avail_check}}$.
- A single Burst of one of the Short Pulse Radar Types 0-4 will commence within a 6 second window starting at $T_1 + 54$ seconds. An additional 1 dB is added to the radar test signal to ensure it is at or above the DFS Detection Threshold, accounting for equipment variations/errors.
- Visual indication or measured results on the UUT of successful detection of the radar Burst will be recorded and reported. Observation of Chr for UUT emissions will continue for 2.5 minutes after the radar Burst has been generated.
- Verify that during the 2.5 minute measurement window no UUT transmissions occurred on Chr. The Channel Availability Check results will be recorded.

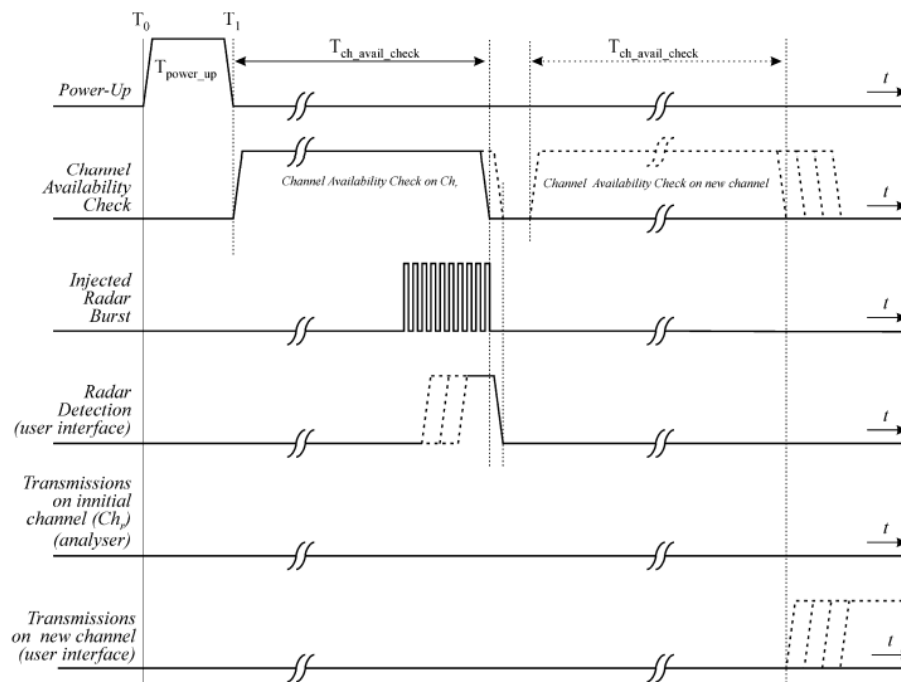

In-service Monitoring

- a) One frequency will be chosen from the Operating Channels of the UUT within the 5250-5350 MHz or 5470-5725 MHz bands. For 802.11 devices, the test frequency must contain control signals. This can be verified by disabling channel loading and monitoring the spectrum analyzer. If no control signals are detected, another frequency must be selected within the emission bandwidth where control signals are detected.
- b) In case the UUT is a U-NII device operating as a Client Device (with or without DFS), a U-NII device operating as a Master Device will be used to allow the UUT (Client device) to Associate with the Master Device. In case the UUT is a Master Device, a U-NII device operating as a Client Device will be used and it is assumed that the Client will *Associate* with the UUT (Master). In both cases for conducted tests, the Radar Waveform generator will be connected to the Master Device. For radiated tests, the emissions of the Radar Waveform generator will be directed towards the Master Device. If the Master Device has antenna gain, the main beam of the antenna will be directed toward the radar emitter. Vertical polarization is used for testing.
- c) Stream the channel loading test file from the Master Device to the Client Device on the test Channel for the entire period of the test.
- d) At time T_0 the Radar Waveform generator sends a Burst of pulses for one of the Radar Type 0 at levels defined, on the Operating Channel. An additional 1 dB is added to the radar test signal to ensure it is at or above the DFS Detection Threshold, accounting for equipment variations/errors.
- e) Observe the transmissions of the UUT at the end of the radar Burst on the Operating Channel for duration greater than 10 seconds. Measure and record the transmissions from the UUT during the observation time (Channel Move Time). Measure and record the Channel Move Time and Channel Closing Transmission Time if radar detection occurs.
- f) When operating as a Master Device, monitor the UUT for more than 30 minutes following instant T_2 to verify that the UUT does not resume any transmissions on this Channel. Perform this test once and record the measurement result.
- g) In case the UUT is a U-NII device operating as a Client Device with In-Service Monitoring, perform steps a) to f).

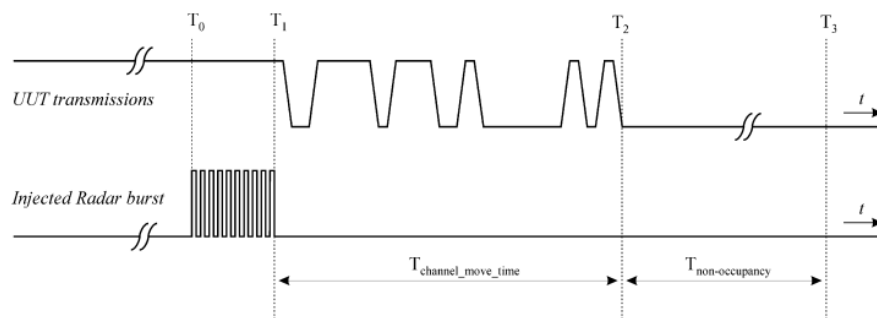

Statistical Performance Check

- a) One frequency will be chosen from the Operating Channels of the UUT within the 5250-5350 MHz or 5470-5725 MHz bands.
- b) In case the UUT is a U-NII device operating as a Client Device (with or without Radar Detection), a U-NII device operating as a Master Device will be used to allow the UUT (Client device) to Associate with the Master Device. In case the UUT is a Master Device, a U-NII device operating as a Client Device will be used and it is assumed that the Client will Associate with the UUT (Master). In both cases for conducted tests, the Radar Waveform generator will be connected to the Master Device. For radiated tests, the emissions of the Radar Waveform generator will be directed towards the Master Device. If the Master Device has antenna gain, the main beam of the antenna will be directed toward the radar emitter. Vertical polarization is used for testing.
- c) The TCP or UDP protocol unicast data stream was generated by the throughput software command line with at least 17% activity ratio over any 100ms period. Stream the channel loading traffic from the Master Device to the Client Device on the test Channel for the entire period of the test.
- d) At time T0 the Radar Waveform generator sends the individual waveform for each of the Radar Types 1- 6, at DFS Detection Threshold level on the Operating Channel. An additional 1 dB is added to the radar test signal to ensure it is at or above the DFS Detection Threshold, accounting for equipment variations/errors.
- e) Observe the transmissions of the EUT at the end of the Burst on the Operating Channel for duration greater than 10 seconds for Short Pulse Radar Types 0 to ensure detection occurs.
- f) Observe the transmissions of the EUT at the end of the Burst on the Operating Channel for duration greater than 22 seconds for Long Pulse Radar Type 5 to ensure detection occurs.
- g) In case the UUT is a U-NII device operating as a Client Device with In-Service Monitoring, perform steps a) to f).

Test Results

<Radar Waveform calibration>

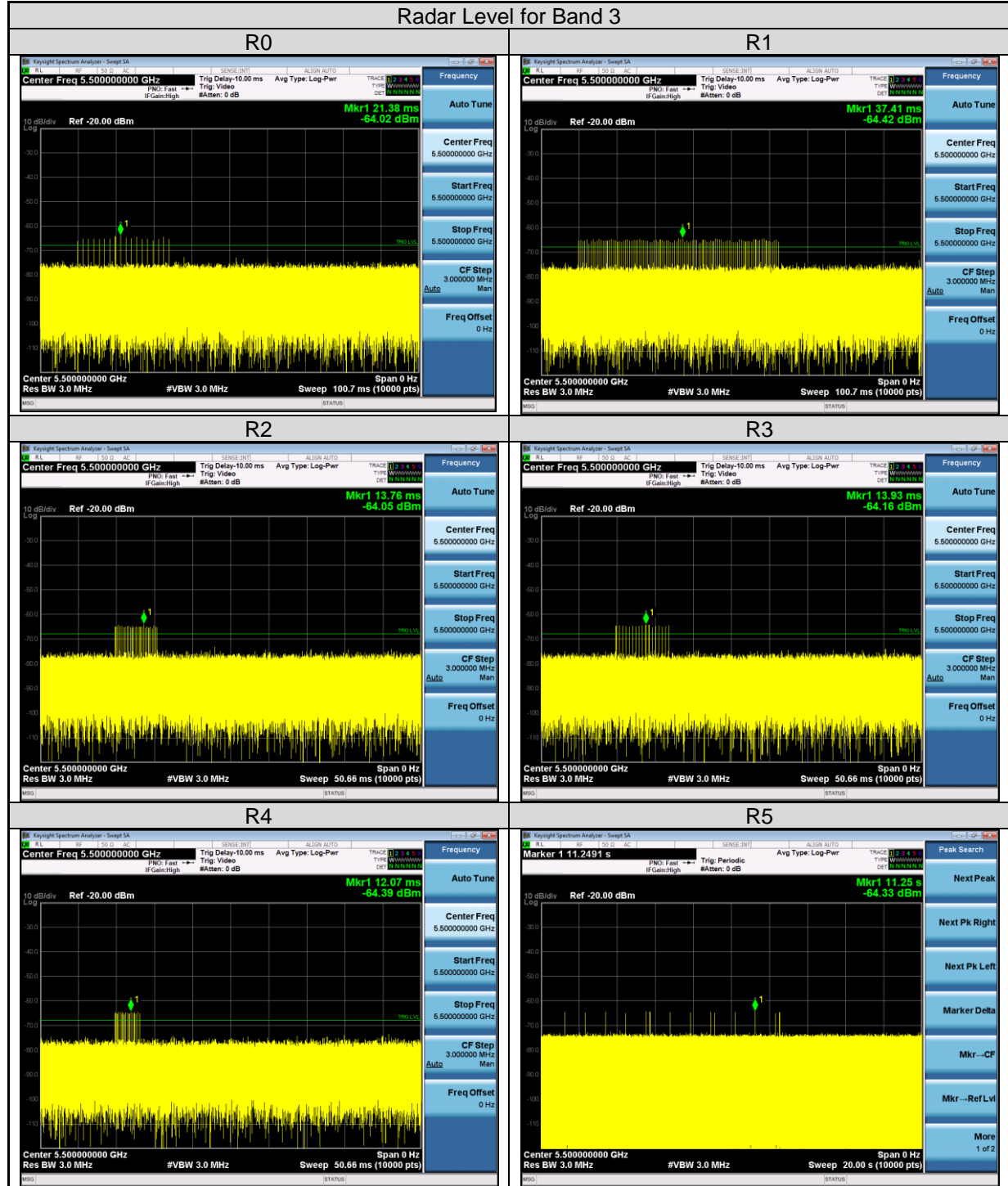

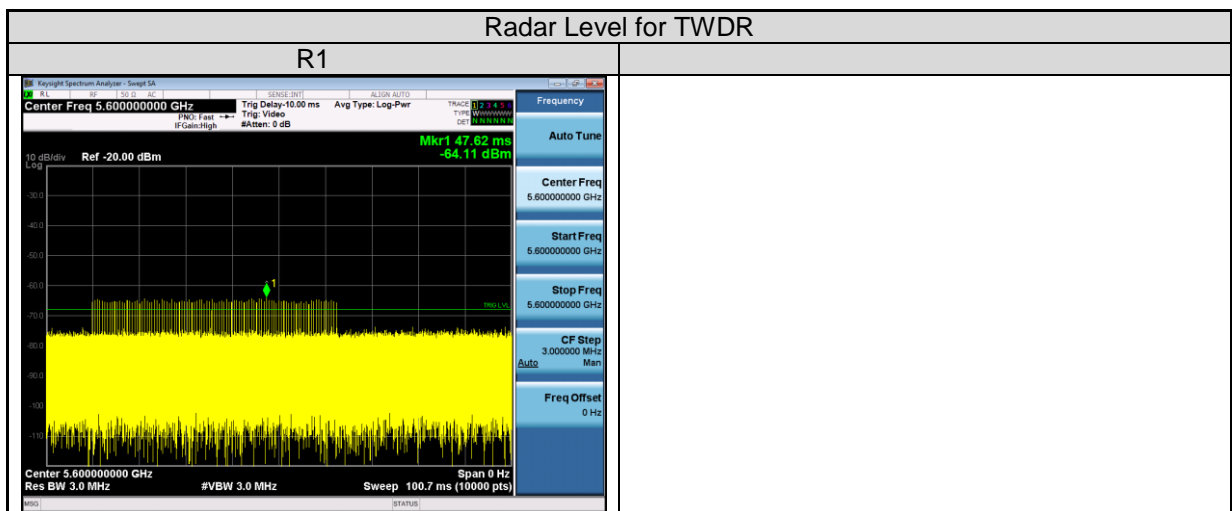
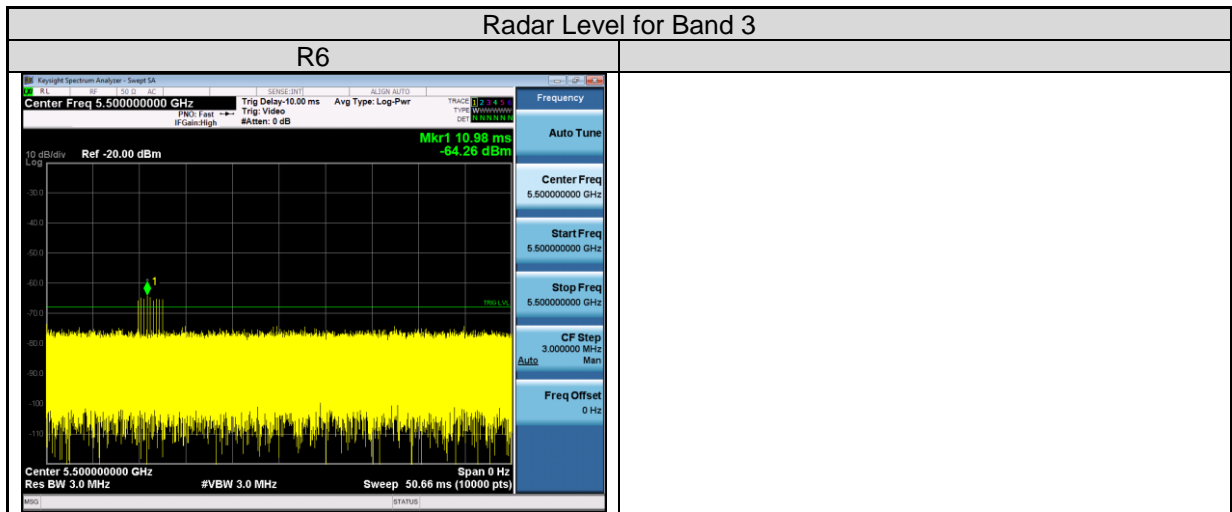

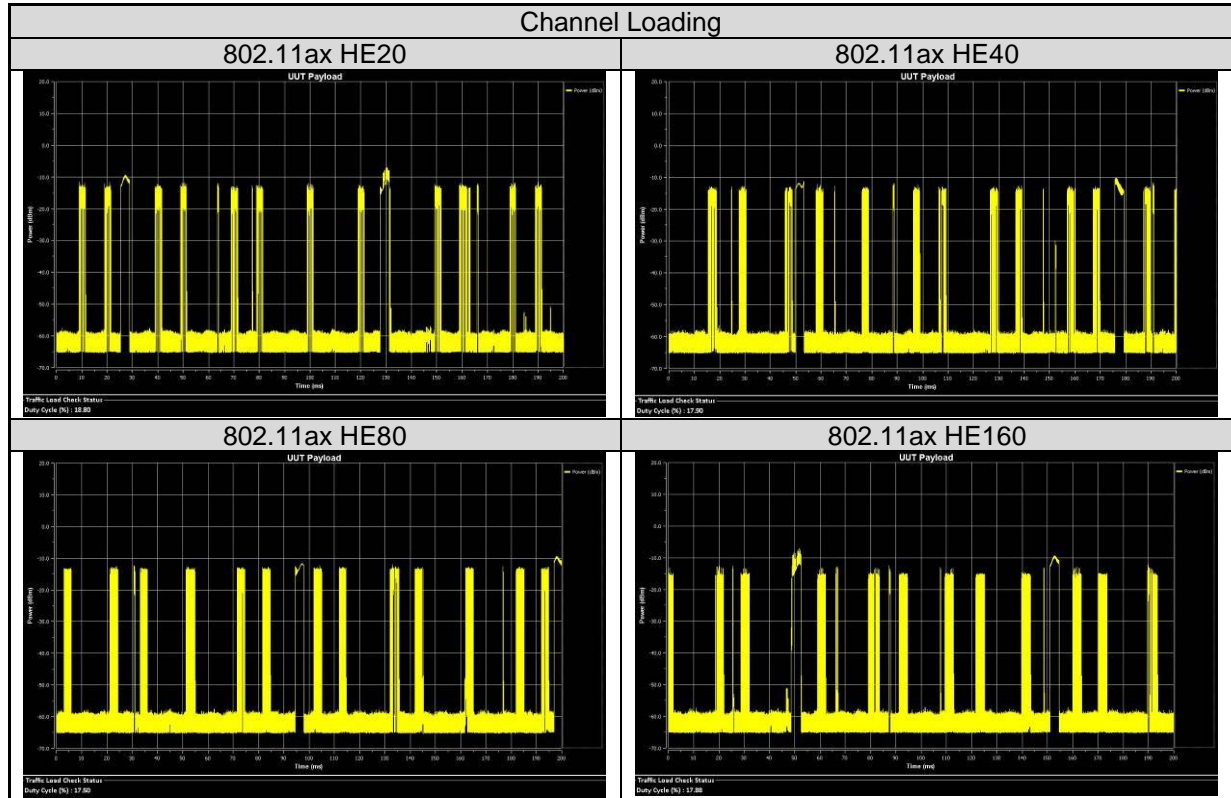

<802.11ax HE160 >
Channel Moving Time (CMT):

Radar Type	Channel (MHz)	Channel Move Time (s)	Limit (s)	Result
R0	5570	1.364	10	Pass

Channel Closing Transmission Time (CCTT):

Radar Type	Channel (MHz)	Channel Closing Transmission Time (s)	Limit (ms)	Result
R0	5570	0.034	< 60	Pass

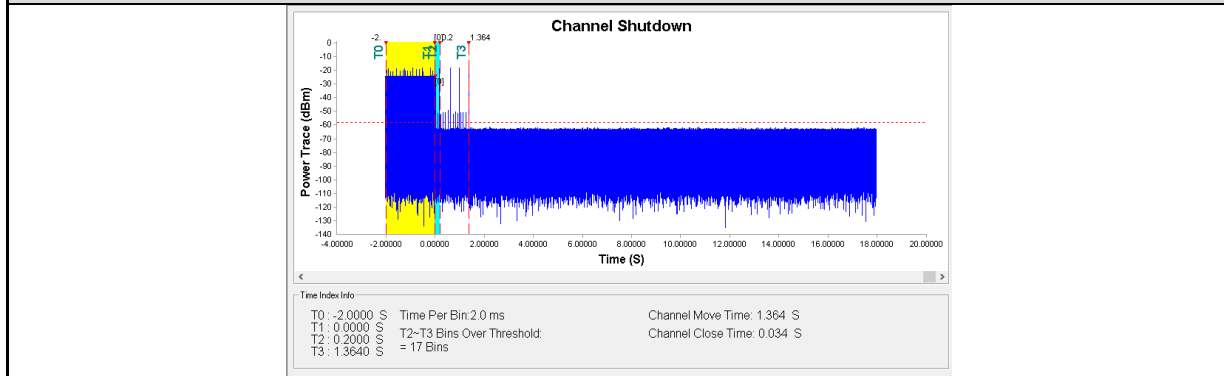
5570MHz

<802.11ax HE20 >
Non-occupancy period

Channel (MHz)	Limit (minute)	Result
5500	≥ 30	Pass

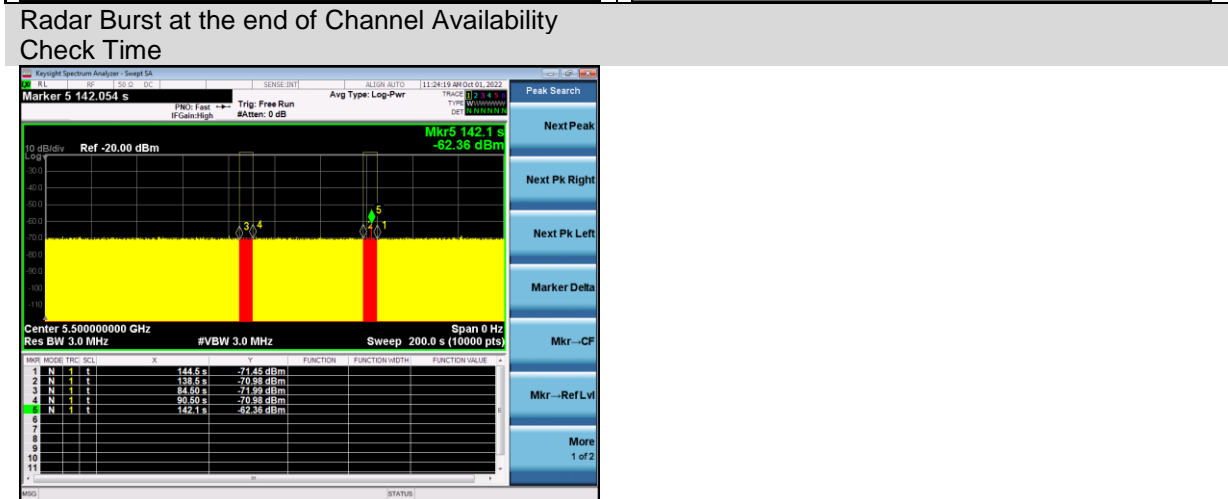
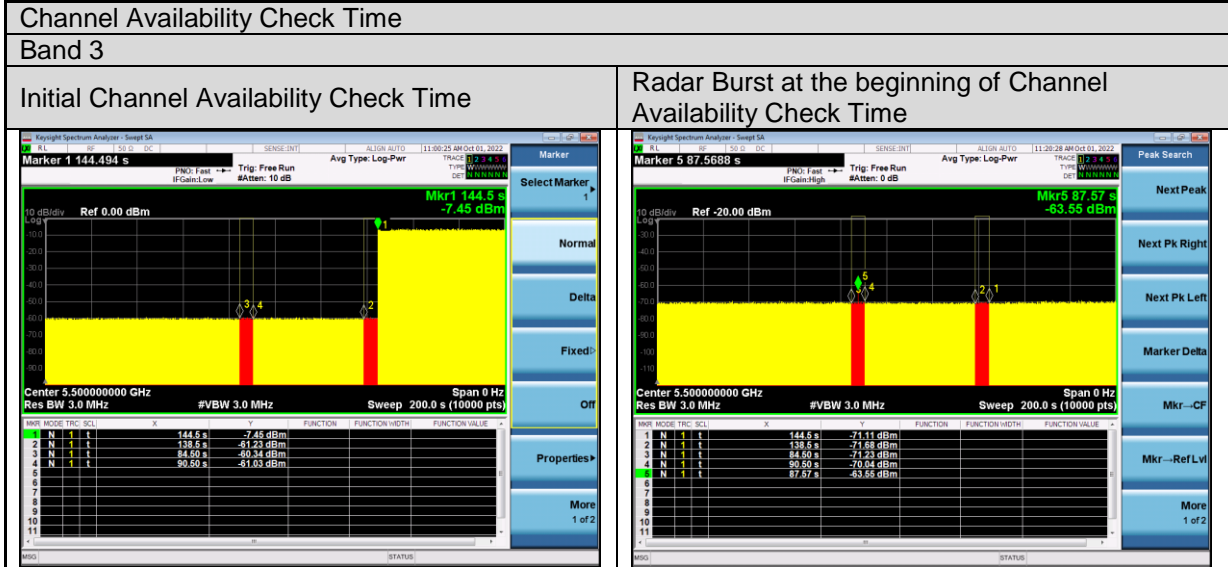
Non-occupancy period
Band 3

<U-NII Detection Bandwidth>

20 MHz Signal Bandwidth											
EUT Frequency = 5320MHz											
Radar Frequency (MHz)	DFS Detection Trials (1=Detection, Blank= No Detection)										Detection Rate (%)
	1	2	3	4	5	6	7	8	9	10	
5305	0	0	0	0	0	0	0	0	0	0	0%
5306(FL)	1	1	1	1	1	1	1	1	1	1	100%
5307	1	1	1	1	1	1	1	1	1	1	100%
5308	1	1	1	1	1	1	1	1	1	1	100%
5309	1	1	1	1	1	1	1	1	1	1	100%
5310	1	1	1	1	1	1	1	1	1	1	100%
5311	1	1	1	1	1	1	1	1	1	1	100%
5312	1	1	1	1	1	1	1	1	1	1	100%
5313	1	1	1	1	1	1	1	1	1	1	100%
5314	1	1	1	1	1	1	1	1	1	1	100%
5315	1	1	1	1	1	1	1	1	1	1	100%
5316	1	1	1	1	1	1	1	1	1	1	100%
5317	1	1	1	1	1	1	1	1	1	1	100%
5318	1	1	1	1	1	1	1	1	1	1	100%
5319	1	1	1	1	1	1	1	1	1	1	100%
5320	1	1	1	1	1	1	1	1	1	1	100%
5321	1	1	1	1	1	1	1	1	1	1	100%
5322	1	1	1	1	1	1	1	1	1	1	100%
5323	1	1	1	1	1	1	1	1	1	1	100%
5324	1	1	1	1	1	1	1	1	1	1	100%
5325	1	1	1	1	1	1	1	1	1	1	100%
5326	1	1	1	1	1	1	1	1	1	1	100%
5327	1	1	1	1	1	1	1	1	1	1	100%
5328	1	1	1	1	1	1	1	1	1	1	100%
5329	1	1	1	1	1	1	1	1	1	1	100%
5330	1	1	1	1	1	1	1	1	1	1	100%
5331	1	1	1	1	1	1	1	1	1	1	100%
5332	1	1	1	1	1	1	1	1	1	1	100%
5333	1	1	1	1	1	1	1	1	1	1	100%
5334(FH)	1	1	1	1	1	1	1	1	1	1	100%
5335	0	0	0	0	0	0	0	0	0	0	0%
20 MHz Detection Bandwidth = Fh - Fl = 5334MHz - 5306MHz = 28MHz											
EUT 99% Bandwidth = 19.3MHz											

20 MHz Signal Bandwidth											
EUT Frequency = 5500MHz											
Radar Frequency (MHz)	DFS Detection Trials (1=Detection, Blank= No Detection)										Detection Rate (%)
	1	2	3	4	5	6	7	8	9	10	
5488	0	0	0	0	0	0	0	0	0	0	0%
5489(FL)	1	1	1	1	1	1	1	1	1	1	100%
5490	1	1	1	1	1	1	1	1	1	1	100%
5491	1	1	1	1	1	1	1	1	1	1	100%
5492	1	1	1	1	1	1	1	1	1	1	100%
5493	1	1	1	1	1	1	1	1	1	1	100%
5494	1	1	1	1	1	1	1	1	1	1	100%
5495	1	1	1	1	1	1	1	1	1	1	100%
5496	1	1	1	1	1	1	1	1	1	1	100%
5497	1	1	1	1	1	1	1	1	1	1	100%
5498	1	1	1	1	1	1	1	1	1	1	100%
5499	1	1	1	1	1	1	1	1	1	1	100%
5500	1	1	1	1	1	1	1	1	1	1	100%
5501	1	1	1	1	1	1	1	1	1	1	100%
5502	1	1	1	1	1	1	1	1	1	1	100%
5503	1	1	1	1	1	1	1	1	1	1	100%
5504	1	1	1	1	1	1	1	1	1	1	100%
5505	1	1	1	1	1	1	1	1	1	1	100%
5506	1	1	1	1	1	1	1	1	1	1	100%
5507	1	1	1	1	1	1	1	1	1	1	100%
5508	1	1	1	1	1	1	1	1	1	1	100%
5509	1	1	1	1	1	1	1	1	1	1	100%
5510	1	1	1	1	1	1	1	1	1	1	100%
5511	1	1	1	1	1	1	1	1	1	1	100%
5512(FH)	1	1	1	1	1	1	1	1	1	1	100%
5513	0	0	0	0	0	0	0	0	0	0	0%
20 MHz Detection Bandwidth = Fh - Fl = 5512MHz - 5489MHz = 23MHz											
EUT 99% Bandwidth = 19.3MHz											

5317	1	1	1	1	1	1	1	1	1	1	100%
5318	1	1	1	1	1	1	1	1	1	1	100%
5319	1	1	1	1	1	1	1	1	1	1	100%
5320	1	1	1	1	1	1	1	1	1	1	100%
5321	1	1	1	1	1	1	1	1	1	1	100%
5322	1	1	1	1	1	1	1	1	1	1	100%
5323	1	1	1	1	1	1	1	1	1	1	100%
5324	1	1	1	1	1	1	1	1	1	1	100%
5325	1	1	1	1	1	1	1	1	1	1	100%
5326	1	1	1	1	1	1	1	1	1	1	100%
5327	1	1	1	1	1	1	1	1	1	1	100%
5328	1	1	1	1	1	1	1	1	1	1	100%
5329	1	1	1	1	1	1	1	1	1	1	100%
5330	1	1	1	1	1	1	1	1	1	1	100%
5331	1	1	1	1	1	1	1	1	1	1	100%
5332	1	1	1	1	1	1	1	1	1	1	100%
5333	1	1	1	1	1	1	1	1	1	1	100%
5334	1	1	1	1	1	1	1	1	1	1	100%
5335	1	1	1	1	1	1	1	1	1	1	100%
5336(FH)	1	1	1	1	1	1	1	1	1	1	100%
5337	0	0	0	0	0	0	0	0	0	0	0%

40 MHz Detection Bandwidth = $F_h - F_l = 5336\text{MHz} - 5282\text{MHz} = 54\text{MHz}$

EUT 99% Bandwidth = 38.8MHz

5520	1	1	1	1	1	1	1	1	1	1	100%
5521	1	1	1	1	1	1	1	1	1	1	100%
5522	1	1	1	1	1	1	1	1	1	1	100%
5523	1	1	1	1	1	1	1	1	1	1	100%
5524	1	1	1	1	1	1	1	1	1	1	100%
5525	1	1	1	1	1	1	1	1	1	1	100%
5526	1	1	1	1	1	1	1	1	1	1	100%
5527	1	1	1	1	1	1	1	1	1	1	100%
5528	1	1	1	1	1	1	1	1	1	1	100%
5529	1	1	1	1	1	1	1	1	1	1	100%
5530	1	1	1	1	1	1	1	1	1	1	100%
5531	1	1	1	1	1	1	1	1	1	1	100%
5532	1	1	1	1	1	1	1	1	1	1	100%
5533	1	1	1	1	1	1	1	1	1	1	100%
5534	1	1	1	1	1	1	1	1	1	1	100%
5535(FH)	1	1	1	1	1	1	1	1	1	1	100%
5336	0	0	0	0	0	0	0	0	0	0	0%

40 MHz Detection Bandwidth = $F_h - F_l = 5535\text{MHz} - 5485\text{MHz} = 50\text{MHz}$

EUT 99% Bandwidth = 38.8MHz

5315	1	1	1	1	1	1	1	1	1	1	100%
5316	1	1	1	1	1	1	1	1	1	1	100%
5317	1	1	1	1	1	1	1	1	1	1	100%
5318	1	1	1	1	1	1	1	1	1	1	100%
5319	1	1	1	1	1	1	1	1	1	1	100%
5320	1	1	1	1	1	1	1	1	1	1	100%
5321	1	1	1	1	1	1	1	1	1	1	100%
5322	1	1	1	1	1	1	1	1	1	1	100%
5323	1	1	1	1	1	1	1	1	1	1	100%
5324	1	1	1	1	1	1	1	1	1	1	100%
5325	1	1	1	1	1	1	1	1	1	1	100%
5326	1	1	1	1	1	1	1	1	1	1	100%
5327	1	1	1	1	1	1	1	1	1	1	100%
5328	1	1	1	1	1	1	1	1	1	1	100%
5329	1	1	1	1	1	1	1	1	1	1	100%
5330	1	1	1	1	1	1	1	1	1	1	100%
5331	1	1	1	1	1	1	1	1	1	1	100%
5332	1	1	1	1	1	1	1	1	1	1	100%
5333	1	1	1	1	1	1	1	1	1	1	100%
5334	1	1	1	1	1	1	1	1	1	1	100%
5335	1	1	1	1	1	1	1	1	1	1	100%
5336	1	1	1	1	1	1	1	1	1	1	100%
5337	1	1	1	1	1	1	1	1	1	1	100%
5338	1	1	1	1	1	1	1	1	1	1	100%
5339(FH)	1	1	1	1	1	1	1	1	0	1	90%
5340	1	1	0	1	1	1	0	1	1	0	70%

80 MHz Detection Bandwidth = $F_h - F_l = 5339\text{MHz} - 5238\text{MHz} = 101\text{MHz}$

EUT 99% Bandwidth = 77.3MHz

5559	1	1	1	1	1	1	1	1	1	1	100%
5560	1	1	1	1	1	1	1	1	1	1	100%
5561	1	1	1	1	1	1	1	1	1	1	100%
5562	1	1	1	1	1	1	1	1	1	1	100%
5563	1	1	1	1	1	1	1	1	1	1	100%
5564	1	1	1	1	1	1	1	1	1	1	100%
5565	1	1	1	1	1	1	1	1	1	1	100%
5566	1	1	1	1	1	1	1	1	1	1	100%
5567	1	1	1	1	1	1	1	1	1	1	100%
5568	1	1	1	1	1	1	1	1	1	1	100%
5569	1	1	1	1	1	1	1	1	1	1	100%
5570	1	1	1	1	1	1	1	1	1	1	100%
5571	1	1	1	1	1	1	1	1	1	1	100%
5572	1	1	1	1	1	1	1	1	1	1	100%
5573	1	1	1	1	1	1	1	1	1	1	100%
5574	1	1	1	1	1	1	1	1	1	1	100%
5575	1	1	1	1	1	1	1	1	1	1	100%
5576	1	1	1	1	1	1	1	1	1	1	100%
5577	1	1	1	1	1	1	1	1	1	1	100%
5578	1	1	1	1	1	1	1	1	1	1	100%
5579(FH)	1	1	1	1	1	1	1	1	1	1	100%
5580	0	0	0	0	0	0	0	0	0	0	0%

80 MHz Detection Bandwidth = $F_h - F_l = 5579\text{MHz} - 5482\text{MHz} = 97\text{MHz}$

EUT 99% Bandwidth = 77.3MHz

5352	1	1	1	1	1	1	1	1	1	1	100%
5353	1	1	1	1	1	1	1	1	1	1	100%
5354(HF)	1	1	1	1	1	1	1	1	1	1	100%
5355	0	0	0	0	0	0	0	0	0	0	0%
160 MHz Detection Bandwidth = $F_h - F_l = 5355\text{MHz} - 5152\text{MHz} = 203\text{MHz}$											
EUT 99% Bandwidth = 156MHz											

5635	1	1	1	1	1	1	1	1	1	1	100%
5636	1	1	1	1	1	1	1	1	1	1	100%
5637	1	1	1	1	1	1	1	1	1	1	100%
5638	1	1	1	1	1	1	1	1	1	1	100%
5639	1	1	1	1	1	1	1	1	1	1	100%
5640	1	1	1	1	1	1	1	1	1	1	100%
5641	1	1	1	1	1	1	1	1	1	1	100%
5642	1	1	1	1	1	1	1	1	1	1	100%
5643	1	1	1	1	1	1	1	1	1	1	100%
5644	1	1	1	1	1	1	1	1	1	1	100%
5645	1	1	1	1	1	1	1	1	1	1	100%
5646	1	1	1	1	1	1	1	1	1	1	100%
5647	1	1	1	1	1	1	1	1	1	1	100%
5648	1	1	1	1	1	1	1	1	1	1	100%
5649	1	1	1	1	1	1	1	1	1	1	100%
5650	1	1	1	1	1	1	1	1	1	1	100%
5651	1	1	1	1	1	1	1	1	1	1	100%
5652	1	1	1	1	1	1	1	1	1	1	100%
5653	1	1	1	1	1	1	1	1	1	1	100%
5654	1	1	1	1	1	1	1	1	1	1	100%
5655	1	1	1	1	1	1	1	1	1	1	100%
5656	1	1	1	1	1	1	1	1	1	1	100%
5657	1	1	1	1	1	1	1	1	1	1	100%
5658	1	1	1	1	1	1	1	1	1	1	100%
5659	1	1	1	1	1	1	1	1	1	1	100%
5660	1	1	1	1	1	1	1	1	1	1	100%
5661	1	1	1	1	1	1	1	1	1	1	100%
5662	1	1	1	1	1	1	1	1	1	1	100%
5663	1	1	1	1	1	1	1	1	1	1	100%
5664	1	1	1	1	1	1	1	1	1	1	100%
5665	1	1	1	1	1	1	1	1	1	1	100%
5666	1	1	1	1	1	1	1	1	1	1	100%
5667	1	1	1	1	1	1	1	1	1	1	100%
5668	1	1	1	1	1	1	1	1	1	1	100%
5669(HF)	1	1	1	1	1	1	1	1	1	1	100%
5670	0	0	0	0	0	1	0	0	0	0	10%

160 MHz Detection Bandwidth = $F_h - F_l = 5669\text{MHz} - 5476\text{MHz} = 193\text{MHz}$

EUT 99% Bandwidth = 156MHz

<Statistical Performance Check for Traffic Mode>

Modulation Mode: 802.11ax HE20 (Band 2)

Radar Type	Number of Trials	Number of Successful Detections	Probability	Limit	Result
1	30	30	100%	60%	Pass
2	30	26	87%	60%	Pass
3	30	23	77%	60%	Pass
4	30	20	67%	60%	Pass
Average			83%	80%	Pass
5	30	30	100%	80%	Pass
6	30	30	100%	70%	Pass

Type 1 Radar Statistical Performance

Trial Number	Pulse Width (us)	PRI (us)	Number of Pulses	Waveform Length(us)	1=Detection Blank=No Detection
1	1	938	57	53466	1
2	1	698	76	53048	1
3	1	618	86	53148	1
4	1	538	99	53262	1
5	1	878	61	53558	1
6	1	3066	18	55188	1
7	1	638	83	52954	1
8	1	918	58	53244	1
9	1	838	63	52794	1
10	1	858	62	53196	1
11	1	798	67	53466	1
12	1	718	74	53132	1
13	1	578	92	53176	1
14	1	598	89	53222	1
15	1	558	95	53010	1
16	1	2536	21	53256	1
17	1	966	55	53130	1
18	1	827	64	52928	1
19	1	2501	22	55022	1
20	1	2595	21	54495	1
21	1	1114	48	53472	1
22	1	1302	41	53382	1
23	1	3045	18	54810	1
24	1	1624	33	53592	1
25	1	2878	19	54682	1
26	1	1027	52	53404	1
27	1	2485	22	54670	1
28	1	1600	33	52800	1
29	1	1172	46	53912	1
30	1	1177	45	52965	1
Detection Percentage				Limit >60%	100%

Type 2 Radar Statistical Performance

Trial Number	Pulse Width (us)	PRI (us)	Number of Pulses	Waveform Length(us)	1=Detection Blank=No Detection
1	3.2	179	26	4654	1
2	1.1	207	23	4761	1
3	2.1	230	24	5520	1
4	4.8	200	29	5800	1
5	3.9	214	28	5992	1
6	2.9	222	26	5772	1
7	3.2	204	26	5304	0
8	2.5	192	25	4800	1
9	3.1	164	26	4264	1
10	1.2	156	23	3588	0
11	3.9	210	27	5670	1
12	4.6	201	29	5829	1
13	3.2	162	26	4212	1
14	2.2	197	25	4925	1
15	4.5	163	29	4727	1
16	3	203	26	5278	1
17	5	168	29	4872	1
18	2.4	217	25	5425	1
19	2.9	191	26	4966	1
20	2.3	166	25	4150	1
21	3.7	150	27	4050	0
22	2.2	176	25	4400	1
23	4.9	195	29	5655	1
24	2.9	202	26	5252	1
25	2.5	178	25	4450	1
26	1.1	206	23	4738	1
27	3.8	155	27	4185	0
28	4.7	157	29	4553	1
29	2.4	224	25	5600	1
30	4.2	159	28	4452	1
Detection Percentage				Limit >60%	87%

Type 3 Radar Statistical Performance

Trial Number	Pulse Width (us)	PRI (us)	Number of Pulses	Waveform Length(us)	1=Detection Blank=No Detection
1	8.2	355	17	6035	1
2	6.1	487	16	7792	1
3	7.1	344	16	5504	1
4	9.8	288	18	5184	1
5	8.9	230	18	4140	0
6	7.9	432	17	7344	1
7	8.2	207	17	3519	0
8	7.5	443	17	7531	1
9	8.1	439	17	7463	1
10	6.2	223	16	3568	1
11	8.9	208	18	3744	1
12	9.6	463	18	8334	1
13	8.2	441	17	7497	1
14	7.2	323	16	5168	1
15	9.5	297	18	5346	0
16	8	412	17	7004	1
17	10	324	18	5832	1
18	7.4	271	17	4607	0
19	7.9	349	17	5933	0
20	7.3	409	16	6544	1
21	8.7	373	18	6714	1
22	7.2	254	16	4064	1
23	9.9	274	18	4932	1
24	7.9	278	17	4726	1
25	7.5	317	17	5389	0
26	6.1	260	16	4160	1
27	8.8	211	18	3798	1
28	9.7	272	18	4896	0
29	7.4	264	17	4488	1
30	9.2	284	18	5112	1
Detection Percentage				Limit >60%	77%

Type 4 Radar Statistical Performance

Trial Number	Pulse Width (us)	PRI (us)	Number of Pulses	Waveform Length(us)	1=Detection Blank=No Detection
1	16	355	14	4970	1
2	11.3	487	12	5844	1
3	13.5	344	13	4472	1
4	19.4	288	16	4608	0
5	17.5	230	15	3450	0
6	15.3	432	14	6048	1
7	15.9	207	14	2898	1
8	14.3	443	13	5759	0
9	15.8	439	14	6146	1
10	11.5	223	12	2676	1
11	17.4	208	15	3120	0
12	19	463	16	7408	1
13	16	441	14	6174	1
14	13.8	323	13	4199	1
15	18.9	297	16	4752	0
16	15.5	412	14	5768	1
17	19.9	324	16	5184	1
18	14.1	271	13	3523	0
19	15.2	349	14	4886	1
20	13.8	409	13	5317	0
21	17.1	373	15	5595	1
22	13.8	254	13	3302	0
23	19.8	274	16	4384	1
24	15.3	278	14	3892	1
25	14.5	317	13	4121	0
26	11.3	260	12	3120	1
27	17.3	211	15	3165	1
28	19.2	272	16	4352	0
29	14.2	264	13	3432	1
30	18.2	284	15	4260	1
Detection Percentage				Limit >60%	67%

Type 5 Radar Statistical Performance

Trial Number	Number of Bursts	Test Radar Signal Name	Center Frequency (GHz)	1=Detection Blank=No Detection
1	15	LPluse_Radar_No.01	5.32	1
2	8	LPluse_Radar_No.02	5.32	1
3	11	LPluse_Radar_No.03	5.32	1
4	20	LPluse_Radar_No.04	5.32	1
5	17	LPluse_Radar_No.05	5.32	1
6	14	LPluse_Radar_No.06	5.32	1
7	15	LPluse_Radar_No.07	5.32	1
8	12	LPluse_Radar_No.08	5.32	1
9	14	LPluse_Radar_No.09	5.32	1
10	8	LPluse_Radar_No.10	5.32	1
11	17	LPluse_Radar_No.11	5.317	1
12	19	LPluse_Radar_No.12	5.318	1
13	15	LPluse_Radar_No.13	5.315	1
14	12	LPluse_Radar_No.14	5.314	1
15	19	LPluse_Radar_No.15	5.317	1
16	14	LPluse_Radar_No.16	5.315	1
17	20	LPluse_Radar_No.17	5.318	1
18	12	LPluse_Radar_No.18	5.314	1
19	14	LPluse_Radar_No.19	5.315	1
20	12	LPluse_Radar_No.20	5.314	1
21	16	LPluse_Radar_No.21	5.324	1
22	12	LPluse_Radar_No.22	5.326	1
23	20	LPluse_Radar_No.23	5.322	1
24	14	LPluse_Radar_No.24	5.325	1
25	13	LPluse_Radar_No.25	5.325	1
26	8	LPluse_Radar_No.26	5.328	1
27	17	LPluse_Radar_No.27	5.323	1
28	19	LPluse_Radar_No.28	5.322	1
29	12	LPluse_Radar_No.29	5.326	1
30	18	LPluse_Radar_No.30	5.323	1
Detection Percentage			Limit >80%	100%

Note: Type 5 radar parameter data sheet, please refer to Appendix E

Type 6 Radar Statistical Performance

Trial Number	Pulse Width (us)	PRI (us)	Number of Pulses	Waveform Length(us)	1=Detection Blank=No Detection
1	1	333.335	9	0.3333	1
2	1	333.335	9	0.3333	1
3	1	333.335	9	0.3333	1
4	1	333.335	9	0.3333	1
5	1	333.335	9	0.3333	1
6	1	333.335	9	0.3333	1
7	1	333.335	9	0.3333	1
8	1	333.335	9	0.3333	1
9	1	333.335	9	0.3333	1
10	1	333.335	9	0.3333	1
11	1	333.335	9	0.3333	1
12	1	333.335	9	0.3333	1
13	1	333.335	9	0.3333	1
14	1	333.335	9	0.3333	1
15	1	333.335	9	0.3333	1
16	1	333.335	9	0.3333	1
17	1	333.335	9	0.3333	1
18	1	333.335	9	0.3333	1
19	1	333.335	9	0.3333	1
20	1	333.335	9	0.3333	1
21	1	333.335	9	0.3333	1
22	1	333.335	9	0.3333	1
23	1	333.335	9	0.3333	1
24	1	333.335	9	0.3333	1
25	1	333.335	9	0.3333	1
26	1	333.335	9	0.3333	1
27	1	333.335	9	0.3333	1
28	1	333.335	9	0.3333	1
29	1	333.335	9	0.3333	1
30	1	333.335	9	0.3333	1
Detection Percentage				Limit >70%	100%

Modulation Mode: 802.11ax HE20 (Band 3)

Radar Type	Number of Trials	Number of Successful Detections	Probability	Limit	Result
1	30	29	97%	60%	Pass
2	30	25	83%	60%	Pass
3	30	23	77%	60%	Pass
4	30	21	70%	60%	Pass
Average			82%	80%	Pass
5	30	26	87%	80%	Pass
6	30	30	100%	70%	Pass

Type 1 Radar Statistical Performance

Trial Number	Pulse Width (us)	PRI (us)	Number of Pulses	Waveform Length(us)	1=Detection Blank=No Detection
1	1	938	57	53466	1
2	1	698	76	53048	1
3	1	618	86	53148	1
4	1	538	99	53262	1
5	1	878	61	53558	0
6	1	3066	18	55188	1
7	1	638	83	52954	1
8	1	918	58	53244	1
9	1	838	63	52794	1
10	1	858	62	53196	1
11	1	798	67	53466	1
12	1	718	74	53132	1
13	1	578	92	53176	1
14	1	598	89	53222	1
15	1	558	95	53010	1
16	1	2536	21	53256	1
17	1	966	55	53130	1
18	1	827	64	52928	1
19	1	2501	22	55022	1
20	1	2595	21	54495	1
21	1	1114	48	53472	1
22	1	1302	41	53382	1
23	1	3045	18	54810	1
24	1	1624	33	53592	1
25	1	2878	19	54682	1
26	1	1027	52	53404	1
27	1	2485	22	54670	1
28	1	1600	33	52800	1
29	1	1172	46	53912	1
30	1	1177	45	52965	1
Detection Percentage				Limit >60%	97%

Type 2 Radar Statistical Performance

Trial Number	Pulse Width (us)	PRI (us)	Number of Pulses	Waveform Length(us)	1=Detection Blank=No Detection
1	3.2	179	26	4654	1
2	1.1	207	23	4761	0
3	2.1	230	24	5520	1
4	4.8	200	29	5800	1
5	3.9	214	28	5992	1
6	2.9	222	26	5772	1
7	3.2	204	26	5304	1
8	2.5	192	25	4800	1
9	3.1	164	26	4264	1
10	1.2	156	23	3588	1
11	3.9	210	27	5670	1
12	4.6	201	29	5829	1
13	3.2	162	26	4212	1
14	2.2	197	25	4925	1
15	4.5	163	29	4727	1
16	3	203	26	5278	0
17	5	168	29	4872	1
18	2.4	217	25	5425	1
19	2.9	191	26	4966	1
20	2.3	166	25	4150	0
21	3.7	150	27	4050	1
22	2.2	176	25	4400	1
23	4.9	195	29	5655	0
24	2.9	202	26	5252	1
25	2.5	178	25	4450	1
26	1.1	206	23	4738	1
27	3.8	155	27	4185	1
28	4.7	157	29	4553	0
29	2.4	224	25	5600	1
30	4.2	159	28	4452	1
Detection Percentage				Limit >60%	83%

Type 3 Radar Statistical Performance

Trial Number	Pulse Width (us)	PRI (us)	Number of Pulses	Waveform Length(us)	1=Detection Blank=No Detection
1	8.2	355	17	6035	1
2	6.1	487	16	7792	0
3	7.1	344	16	5504	1
4	9.8	288	18	5184	1
5	8.9	230	18	4140	1
6	7.9	432	17	7344	0
7	8.2	207	17	3519	1
8	7.5	443	17	7531	1
9	8.1	439	17	7463	1
10	6.2	223	16	3568	1
11	8.9	208	18	3744	1
12	9.6	463	18	8334	1
13	8.2	441	17	7497	0
14	7.2	323	16	5168	1
15	9.5	297	18	5346	1
16	8	412	17	7004	1
17	10	324	18	5832	1
18	7.4	271	17	4607	0
19	7.9	349	17	5933	0
20	7.3	409	16	6544	1
21	8.7	373	18	6714	1
22	7.2	254	16	4064	1
23	9.9	274	18	4932	1
24	7.9	278	17	4726	1
25	7.5	317	17	5389	1
26	6.1	260	16	4160	1
27	8.8	211	18	3798	1
28	9.7	272	18	4896	0
29	7.4	264	17	4488	1
30	9.2	284	18	5112	0
Detection Percentage				Limit >60%	77%

Type 4 Radar Statistical Performance

Trial Number	Pulse Width (us)	PRI (us)	Number of Pulses	Waveform Length(us)	1=Detection Blank=No Detection
1	16	355	14	4970	0
2	11.3	487	12	5844	0
3	13.5	344	13	4472	1
4	19.4	288	16	4608	1
5	17.5	230	15	3450	1
6	15.3	432	14	6048	0
7	15.9	207	14	2898	1
8	14.3	443	13	5759	0
9	15.8	439	14	6146	1
10	11.5	223	12	2676	1
11	17.4	208	15	3120	1
12	19	463	16	7408	1
13	16	441	14	6174	1
14	13.8	323	13	4199	1
15	18.9	297	16	4752	0
16	15.5	412	14	5768	1
17	19.9	324	16	5184	1
18	14.1	271	13	3523	1
19	15.2	349	14	4886	0
20	13.8	409	13	5317	0
21	17.1	373	15	5595	1
22	13.8	254	13	3302	1
23	19.8	274	16	4384	1
24	15.3	278	14	3892	1
25	14.5	317	13	4121	1
26	11.3	260	12	3120	0
27	17.3	211	15	3165	1
28	19.2	272	16	4352	0
29	14.2	264	13	3432	1
30	18.2	284	15	4260	1
Detection Percentage				Limit >60%	70%

Type 5 Radar Statistical Performance

Trial Number	Number of Bursts	Test Radar Signal Name	Center Frequency (GHz)	1=Detection Blank=No Detection
1	15	LPluse_Radar_No.01	5.5	1
2	8	LPluse_Radar_No.02	5.5	1
3	11	LPluse_Radar_No.03	5.5	1
4	20	LPluse_Radar_No.04	5.5	1
5	17	LPluse_Radar_No.05	5.5	1
6	14	LPluse_Radar_No.06	5.5	1
7	15	LPluse_Radar_No.07	5.5	1
8	12	LPluse_Radar_No.08	5.5	1
9	14	LPluse_Radar_No.09	5.5	1
10	8	LPluse_Radar_No.10	5.5	1
11	17	LPluse_Radar_No.11	5.497	1
12	19	LPluse_Radar_No.12	5.498	1
13	15	LPluse_Radar_No.13	5.496	1
14	12	LPluse_Radar_No.14	5.494	0
15	19	LPluse_Radar_No.15	5.498	1
16	14	LPluse_Radar_No.16	5.495	1
17	20	LPluse_Radar_No.17	5.498	1
18	12	LPluse_Radar_No.18	5.494	0
19	14	LPluse_Radar_No.19	5.495	0
20	12	LPluse_Radar_No.20	5.494	1
21	16	LPluse_Radar_No.21	5.504	1
22	12	LPluse_Radar_No.22	5.506	1
23	20	LPluse_Radar_No.23	5.502	1
24	14	LPluse_Radar_No.24	5.505	1
25	13	LPluse_Radar_No.25	5.505	1
26	8	LPluse_Radar_No.26	5.508	0
27	17	LPluse_Radar_No.27	5.503	1
28	19	LPluse_Radar_No.28	5.502	1
29	12	LPluse_Radar_No.29	5.506	1
30	18	LPluse_Radar_No.30	5.503	1
Detection Percentage			Limit >80%	87%

Note: Type 5 radar parameter data sheet, please refer to Appendix E

Type 6 Radar Statistical Performance

Trial Number	Pulse Width (us)	PRI (us)	Number of Pulses	Waveform Length(us)	1=Detection Blank=No Detection
1	1	333.335	9	0.3333	1
2	1	333.335	9	0.3333	1
3	1	333.335	9	0.3333	1
4	1	333.335	9	0.3333	1
5	1	333.335	9	0.3333	1
6	1	333.335	9	0.3333	1
7	1	333.335	9	0.3333	1
8	1	333.335	9	0.3333	1
9	1	333.335	9	0.3333	1
10	1	333.335	9	0.3333	1
11	1	333.335	9	0.3333	1
12	1	333.335	9	0.3333	1
13	1	333.335	9	0.3333	1
14	1	333.335	9	0.3333	1
15	1	333.335	9	0.3333	1
16	1	333.335	9	0.3333	1
17	1	333.335	9	0.3333	1
18	1	333.335	9	0.3333	1
19	1	333.335	9	0.3333	1
20	1	333.335	9	0.3333	1
21	1	333.335	9	0.3333	1
22	1	333.335	9	0.3333	1
23	1	333.335	9	0.3333	1
24	1	333.335	9	0.3333	1
25	1	333.335	9	0.3333	1
26	1	333.335	9	0.3333	1
27	1	333.335	9	0.3333	1
28	1	333.335	9	0.3333	1
29	1	333.335	9	0.3333	1
30	1	333.335	9	0.3333	1
Detection Percentage				Limit >70%	100%

Modulation Mode: 802.11ax HE40 (Band 2)

Radar Type	Number of Trials	Number of Successful Detections	Probability	Limit	Result
1	30	28	93%	60%	Pass
2	30	24	80%	60%	Pass
3	30	23	77%	60%	Pass
4	30	23	77%	60%	Pass
Average			82%	80%	Pass
5	30	30	100%	80%	Pass
6	30	30	100%	70%	Pass

Type 1 Radar Statistical Performance

Trial Number	Pulse Width (us)	PRI (us)	Number of Pulses	Waveform Length(us)	1=Detection Blank=No Detection
1	1	938	57	53466	1
2	1	698	76	53048	1
3	1	618	86	53148	1
4	1	538	99	53262	1
5	1	878	61	53558	1
6	1	3066	18	55188	1
7	1	638	83	52954	0
8	1	918	58	53244	1
9	1	838	63	52794	1
10	1	858	62	53196	1
11	1	798	67	53466	0
12	1	718	74	53132	1
13	1	578	92	53176	1
14	1	598	89	53222	1
15	1	558	95	53010	1
16	1	2536	21	53256	1
17	1	966	55	53130	1
18	1	827	64	52928	1
19	1	2501	22	55022	1
20	1	2595	21	54495	1
21	1	1114	48	53472	1
22	1	1302	41	53382	1
23	1	3045	18	54810	1
24	1	1624	33	53592	1
25	1	2878	19	54682	1
26	1	1027	52	53404	1
27	1	2485	22	54670	1
28	1	1600	33	52800	1
29	1	1172	46	53912	1
30	1	1177	45	52965	1
Detection Percentage				Limit >60%	93%

Type 2 Radar Statistical Performance

Trial Number	Pulse Width (us)	PRI (us)	Number of Pulses	Waveform Length(us)	1=Detection Blank=No Detection
1	3.2	179	26	4654	0
2	1.1	207	23	4761	1
3	2.1	230	24	5520	1
4	4.8	200	29	5800	1
5	3.9	214	28	5992	1
6	2.9	222	26	5772	0
7	3.2	204	26	5304	1
8	2.5	192	25	4800	1
9	3.1	164	26	4264	1
10	1.2	156	23	3588	1
11	3.9	210	27	5670	1
12	4.6	201	29	5829	1
13	3.2	162	26	4212	0
14	2.2	197	25	4925	1
15	4.5	163	29	4727	0
16	3	203	26	5278	1
17	5	168	29	4872	1
18	2.4	217	25	5425	1
19	2.9	191	26	4966	0
20	2.3	166	25	4150	1
21	3.7	150	27	4050	1
22	2.2	176	25	4400	1
23	4.9	195	29	5655	1
24	2.9	202	26	5252	1
25	2.5	178	25	4450	1
26	1.1	206	23	4738	1
27	3.8	155	27	4185	0
28	4.7	157	29	4553	1
29	2.4	224	25	5600	1
30	4.2	159	28	4452	1
Detection Percentage				Limit >60%	80%

Type 3 Radar Statistical Performance

Trial Number	Pulse Width (us)	PRI (us)	Number of Pulses	Waveform Length(us)	1=Detection Blank=No Detection
1	8.2	355	17	6035	1
2	6.1	487	16	7792	0
3	7.1	344	16	5504	1
4	9.8	288	18	5184	0
5	8.9	230	18	4140	1
6	7.9	432	17	7344	1
7	8.2	207	17	3519	1
8	7.5	443	17	7531	1
9	8.1	439	17	7463	1
10	6.2	223	16	3568	0
11	8.9	208	18	3744	1
12	9.6	463	18	8334	1
13	8.2	441	17	7497	1
14	7.2	323	16	5168	1
15	9.5	297	18	5346	1
16	8	412	17	7004	0
17	10	324	18	5832	1
18	7.4	271	17	4607	1
19	7.9	349	17	5933	1
20	7.3	409	16	6544	1
21	8.7	373	18	6714	1
22	7.2	254	16	4064	1
23	9.9	274	18	4932	1
24	7.9	278	17	4726	0
25	7.5	317	17	5389	1
26	6.1	260	16	4160	0
27	8.8	211	18	3798	1
28	9.7	272	18	4896	0
29	7.4	264	17	4488	1
30	9.2	284	18	5112	1
Detection Percentage				Limit >60%	77%

Type 4 Radar Statistical Performance

Trial Number	Pulse Width (us)	PRI (us)	Number of Pulses	Waveform Length(us)	1=Detection Blank=No Detection
1	16	355	14	4970	1
2	11.3	487	12	5844	0
3	13.5	344	13	4472	1
4	19.4	288	16	4608	1
5	17.5	230	15	3450	1
6	15.3	432	14	6048	1
7	15.9	207	14	2898	1
8	14.3	443	13	5759	0
9	15.8	439	14	6146	1
10	11.5	223	12	2676	1
11	17.4	208	15	3120	0
12	19	463	16	7408	1
13	16	441	14	6174	1
14	13.8	323	13	4199	1
15	18.9	297	16	4752	1
16	15.5	412	14	5768	1
17	19.9	324	16	5184	1
18	14.1	271	13	3523	0
19	15.2	349	14	4886	1
20	13.8	409	13	5317	1
21	17.1	373	15	5595	0
22	13.8	254	13	3302	1
23	19.8	274	16	4384	1
24	15.3	278	14	3892	1
25	14.5	317	13	4121	1
26	11.3	260	12	3120	0
27	17.3	211	15	3165	1
28	19.2	272	16	4352	0
29	14.2	264	13	3432	1
30	18.2	284	15	4260	1
Detection Percentage				Limit >60%	77%

Type 5 Radar Statistical Performance

Trial Number	Number of Bursts	Test Radar Signal Name	Center Frequency (GHz)	1=Detection Blank=No Detection
1	15	LPluse_Radar_No.01	5.31	1
2	8	LPluse_Radar_No.02	5.31	1
3	11	LPluse_Radar_No.03	5.31	1
4	20	LPluse_Radar_No.04	5.31	1
5	17	LPluse_Radar_No.05	5.31	1
6	14	LPluse_Radar_No.06	5.31	1
7	15	LPluse_Radar_No.07	5.31	1
8	12	LPluse_Radar_No.08	5.31	1
9	14	LPluse_Radar_No.09	5.31	1
10	8	LPluse_Radar_No.10	5.31	1
11	17	LPluse_Radar_No.11	5.297	1
12	19	LPluse_Radar_No.12	5.298	1
13	15	LPluse_Radar_No.13	5.296	1
14	12	LPluse_Radar_No.14	5.295	1
15	19	LPluse_Radar_No.15	5.298	1
16	14	LPluse_Radar_No.16	5.296	1
17	20	LPluse_Radar_No.17	5.299	1
18	12	LPluse_Radar_No.18	5.295	1
19	14	LPluse_Radar_No.19	5.296	1
20	12	LPluse_Radar_No.20	5.295	1
21	16	LPluse_Radar_No.21	5.323	1
22	12	LPluse_Radar_No.22	5.326	1
23	20	LPluse_Radar_No.23	5.321	1
24	14	LPluse_Radar_No.24	5.324	1
25	13	LPluse_Radar_No.25	5.325	1
26	8	LPluse_Radar_No.26	5.327	1
27	17	LPluse_Radar_No.27	5.323	1
28	19	LPluse_Radar_No.28	5.322	1
29	12	LPluse_Radar_No.29	5.325	1
30	18	LPluse_Radar_No.30	5.322	1
Detection Percentage			Limit >80%	100%

Note: Type 5 radar parameter data sheet, please refer to Appendix E

Type 6 Radar Statistical Performance

Trial Number	Pulse Width (us)	PRI (us)	Number of Pulses	Waveform Length(us)	1=Detection Blank=No Detection
1	1	333.335	9	0.3333	1
2	1	333.335	9	0.3333	1
3	1	333.335	9	0.3333	1
4	1	333.335	9	0.3333	1
5	1	333.335	9	0.3333	1
6	1	333.335	9	0.3333	1
7	1	333.335	9	0.3333	1
8	1	333.335	9	0.3333	1
9	1	333.335	9	0.3333	1
10	1	333.335	9	0.3333	1
11	1	333.335	9	0.3333	1
12	1	333.335	9	0.3333	1
13	1	333.335	9	0.3333	1
14	1	333.335	9	0.3333	1
15	1	333.335	9	0.3333	1
16	1	333.335	9	0.3333	1
17	1	333.335	9	0.3333	1
18	1	333.335	9	0.3333	1
19	1	333.335	9	0.3333	1
20	1	333.335	9	0.3333	1
21	1	333.335	9	0.3333	1
22	1	333.335	9	0.3333	1
23	1	333.335	9	0.3333	1
24	1	333.335	9	0.3333	1
25	1	333.335	9	0.3333	1
26	1	333.335	9	0.3333	1
27	1	333.335	9	0.3333	1
28	1	333.335	9	0.3333	1
29	1	333.335	9	0.3333	1
30	1	333.335	9	0.3333	1
Detection Percentage				Limit >70%	100%

Modulation Mode: 802.11ax HE40 (Band 3)

Radar Type	Number of Trials	Number of Successful Detections	Probability	Limit	Result
1	30	30	100%	60%	Pass
2	30	27	90%	60%	Pass
3	30	25	83%	60%	Pass
4	30	24	80%	60%	Pass
Average			88%	80%	Pass
5	30	27	90%	80%	Pass
6	30	30	100%	70%	Pass

Type 1 Radar Statistical Performance

Trial Number	Pulse Width (us)	PRI (us)	Number of Pulses	Waveform Length(us)	1=Detection Blank=No Detection
1	1	938	57	53466	1
2	1	698	76	53048	1
3	1	618	86	53148	1
4	1	538	99	53262	1
5	1	878	61	53558	1
6	1	3066	18	55188	1
7	1	638	83	52954	1
8	1	918	58	53244	1
9	1	838	63	52794	1
10	1	858	62	53196	1
11	1	798	67	53466	1
12	1	718	74	53132	1
13	1	578	92	53176	1
14	1	598	89	53222	1
15	1	558	95	53010	1
16	1	2536	21	53256	1
17	1	966	55	53130	1
18	1	827	64	52928	1
19	1	2501	22	55022	1
20	1	2595	21	54495	1
21	1	1114	48	53472	1
22	1	1302	41	53382	1
23	1	3045	18	54810	1
24	1	1624	33	53592	1
25	1	2878	19	54682	1
26	1	1027	52	53404	1
27	1	2485	22	54670	1
28	1	1600	33	52800	1
29	1	1172	46	53912	1
30	1	1177	45	52965	1
Detection Percentage				Limit >60%	100%

Type 2 Radar Statistical Performance

Trial Number	Pulse Width (us)	PRI (us)	Number of Pulses	Waveform Length(us)	1=Detection Blank=No Detection
1	3.2	179	26	4654	1
2	1.1	207	23	4761	1
3	2.1	230	24	5520	1
4	4.8	200	29	5800	1
5	3.9	214	28	5992	1
6	2.9	222	26	5772	1
7	3.2	204	26	5304	1
8	2.5	192	25	4800	1
9	3.1	164	26	4264	1
10	1.2	156	23	3588	0
11	3.9	210	27	5670	1
12	4.6	201	29	5829	1
13	3.2	162	26	4212	1
14	2.2	197	25	4925	1
15	4.5	163	29	4727	1
16	3	203	26	5278	1
17	5	168	29	4872	1
18	2.4	217	25	5425	0
19	2.9	191	26	4966	1
20	2.3	166	25	4150	1
21	3.7	150	27	4050	1
22	2.2	176	25	4400	1
23	4.9	195	29	5655	1
24	2.9	202	26	5252	1
25	2.5	178	25	4450	1
26	1.1	206	23	4738	1
27	3.8	155	27	4185	1
28	4.7	157	29	4553	1
29	2.4	224	25	5600	0
30	4.2	159	28	4452	1
Detection Percentage				Limit >60%	90%

Type 3 Radar Statistical Performance

Trial Number	Pulse Width (us)	PRI (us)	Number of Pulses	Waveform Length(us)	1=Detection Blank=No Detection
1	8.2	355	17	6035	1
2	6.1	487	16	7792	1
3	7.1	344	16	5504	1
4	9.8	288	18	5184	0
5	8.9	230	18	4140	1
6	7.9	432	17	7344	1
7	8.2	207	17	3519	0
8	7.5	443	17	7531	1
9	8.1	439	17	7463	1
10	6.2	223	16	3568	1
11	8.9	208	18	3744	1
12	9.6	463	18	8334	1
13	8.2	441	17	7497	1
14	7.2	323	16	5168	1
15	9.5	297	18	5346	1
16	8	412	17	7004	1
17	10	324	18	5832	1
18	7.4	271	17	4607	1
19	7.9	349	17	5933	0
20	7.3	409	16	6544	1
21	8.7	373	18	6714	1
22	7.2	254	16	4064	0
23	9.9	274	18	4932	1
24	7.9	278	17	4726	1
25	7.5	317	17	5389	1
26	6.1	260	16	4160	1
27	8.8	211	18	3798	0
28	9.7	272	18	4896	1
29	7.4	264	17	4488	1
30	9.2	284	18	5112	1
Detection Percentage				Limit >60%	83%

Type 4 Radar Statistical Performance

Trial Number	Pulse Width (us)	PRI (us)	Number of Pulses	Waveform Length(us)	1=Detection Blank=No Detection
1	16	355	14	4970	1
2	11.3	487	12	5844	1
3	13.5	344	13	4472	1
4	19.4	288	16	4608	1
5	17.5	230	15	3450	1
6	15.3	432	14	6048	1
7	15.9	207	14	2898	1
8	14.3	443	13	5759	0
9	15.8	439	14	6146	1
10	11.5	223	12	2676	0
11	17.4	208	15	3120	1
12	19	463	16	7408	1
13	16	441	14	6174	1
14	13.8	323	13	4199	1
15	18.9	297	16	4752	1
16	15.5	412	14	5768	0
17	19.9	324	16	5184	1
18	14.1	271	13	3523	0
19	15.2	349	14	4886	1
20	13.8	409	13	5317	1
21	17.1	373	15	5595	1
22	13.8	254	13	3302	1
23	19.8	274	16	4384	0
24	15.3	278	14	3892	1
25	14.5	317	13	4121	1
26	11.3	260	12	3120	1
27	17.3	211	15	3165	0
28	19.2	272	16	4352	1
29	14.2	264	13	3432	1
30	18.2	284	15	4260	1
Detection Percentage				Limit >60%	80%

Type 5 Radar Statistical Performance

Trial Number	Number of Bursts	Test Radar Signal Name	Center Frequency (GHz)	1=Detection n Blank=No Detection
1	15	LPluse_Radar_No.01	5.51	1
2	8	LPluse_Radar_No.02	5.51	1
3	11	LPluse_Radar_No.03	5.51	1
4	20	LPluse_Radar_No.04	5.51	1
5	17	LPluse_Radar_No.05	5.51	1
6	14	LPluse_Radar_No.06	5.51	1
7	15	LPluse_Radar_No.07	5.51	1
8	12	LPluse_Radar_No.08	5.51	1
9	14	LPluse_Radar_No.09	5.51	1
10	8	LPluse_Radar_No.10	5.51	1
11	17	LPluse_Radar_No.11	5.497	1
12	19	LPluse_Radar_No.12	5.499	1
13	15	LPluse_Radar_No.13	5.496	1
14	12	LPluse_Radar_No.14	5.495	0
15	19	LPluse_Radar_No.15	5.498	1
16	14	LPluse_Radar_No.16	5.496	1
17	20	LPluse_Radar_No.17	5.499	1
18	12	LPluse_Radar_No.18	5.495	1
19	14	LPluse_Radar_No.19	5.496	1
20	12	LPluse_Radar_No.20	5.495	0
21	16	LPluse_Radar_No.21	5.523	1
22	12	LPluse_Radar_No.22	5.525	1
23	20	LPluse_Radar_No.23	5.521	1
24	14	LPluse_Radar_No.24	5.524	1
25	13	LPluse_Radar_No.25	5.525	1
26	8	LPluse_Radar_No.26	5.527	0
27	17	LPluse_Radar_No.27	5.523	1
28	19	LPluse_Radar_No.28	5.521	1
29	12	LPluse_Radar_No.29	5.525	1
30	18	LPluse_Radar_No.30	5.522	1
Detection Percentage			Limit >80%	90%

Note: Type 5 radar parameter data sheet, please refer to Appendix E

Type 6 Radar Statistical Performance

Trial Number	Pulse Width (us)	PRI (us)	Number of Pulses	Waveform Length(us)	1=Detection Blank=No Detection
1	1	333.335	9	0.3333	1
2	1	333.335	9	0.3333	1
3	1	333.335	9	0.3333	1
4	1	333.335	9	0.3333	1
5	1	333.335	9	0.3333	1
6	1	333.335	9	0.3333	1
7	1	333.335	9	0.3333	1
8	1	333.335	9	0.3333	1
9	1	333.335	9	0.3333	1
10	1	333.335	9	0.3333	1
11	1	333.335	9	0.3333	1
12	1	333.335	9	0.3333	1
13	1	333.335	9	0.3333	1
14	1	333.335	9	0.3333	1
15	1	333.335	9	0.3333	1
16	1	333.335	9	0.3333	1
17	1	333.335	9	0.3333	1
18	1	333.335	9	0.3333	1
19	1	333.335	9	0.3333	1
20	1	333.335	9	0.3333	1
21	1	333.335	9	0.3333	1
22	1	333.335	9	0.3333	1
23	1	333.335	9	0.3333	1
24	1	333.335	9	0.3333	1
25	1	333.335	9	0.3333	1
26	1	333.335	9	0.3333	1
27	1	333.335	9	0.3333	1
28	1	333.335	9	0.3333	1
29	1	333.335	9	0.3333	1
30	1	333.335	9	0.3333	1
Detection Percentage				Limit >70%	100%

Modulation Mode: 802.11ax HE80 (Band 2)

Radar Type	Number of Trials	Number of Successful Detections	Probability	Limit	Result
1	30	28	93%	60%	Pass
2	30	25	83%	60%	Pass
3	30	23	77%	60%	Pass
4	30	22	73%	60%	Pass
Average			82%	80%	Pass
5	30	27	90%	80%	Pass
6	30	30	100%	70%	Pass

Type 1 Radar Statistical Performance

Trial Number	Pulse Width (us)	PRI (us)	Number of Pulses	Waveform Length(us)	1=Detection Blank=No Detection
1	1	938	57	53466	1
2	1	698	76	53048	1
3	1	618	86	53148	1
4	1	538	99	53262	1
5	1	878	61	53558	1
6	1	3066	18	55188	1
7	1	638	83	52954	0
8	1	918	58	53244	1
9	1	838	63	52794	1
10	1	858	62	53196	1
11	1	798	67	53466	1
12	1	718	74	53132	1
13	1	578	92	53176	1
14	1	598	89	53222	1
15	1	558	95	53010	1
16	1	2536	21	53256	1
17	1	966	55	53130	1
18	1	827	64	52928	1
19	1	2501	22	55022	1
20	1	2595	21	54495	1
21	1	1114	48	53472	1
22	1	1302	41	53382	1
23	1	3045	18	54810	1
24	1	1624	33	53592	1
25	1	2878	19	54682	1
26	1	1027	52	53404	1
27	1	2485	22	54670	0
28	1	1600	33	52800	1
29	1	1172	46	53912	1
30	1	1177	45	52965	1
Detection Percentage				Limit >60%	93%

Type 2 Radar Statistical Performance

Trial Number	Pulse Width (us)	PRI (us)	Number of Pulses	Waveform Length(us)	1=Detection Blank=No Detection
1	3.2	179	26	4654	1
2	1.1	207	23	4761	1
3	2.1	230	24	5520	1
4	4.8	200	29	5800	1
5	3.9	214	28	5992	1
6	2.9	222	26	5772	0
7	3.2	204	26	5304	1
8	2.5	192	25	4800	1
9	3.1	164	26	4264	1
10	1.2	156	23	3588	1
11	3.9	210	27	5670	1
12	4.6	201	29	5829	1
13	3.2	162	26	4212	1
14	2.2	197	25	4925	1
15	4.5	163	29	4727	1
16	3	203	26	5278	0
17	5	168	29	4872	1
18	2.4	217	25	5425	1
19	2.9	191	26	4966	1
20	2.3	166	25	4150	0
21	3.7	150	27	4050	1
22	2.2	176	25	4400	1
23	4.9	195	29	5655	1
24	2.9	202	26	5252	1
25	2.5	178	25	4450	0
26	1.1	206	23	4738	0
27	3.8	155	27	4185	1
28	4.7	157	29	4553	1
29	2.4	224	25	5600	1
30	4.2	159	28	4452	1
Detection Percentage				Limit >60%	83%

Type 3 Radar Statistical Performance

Trial Number	Pulse Width (us)	PRI (us)	Number of Pulses	Waveform Length(us)	1=Detection Blank=No Detection
1	8.2	355	17	6035	1
2	6.1	487	16	7792	1
3	7.1	344	16	5504	0
4	9.8	288	18	5184	1
5	8.9	230	18	4140	1
6	7.9	432	17	7344	0
7	8.2	207	17	3519	1
8	7.5	443	17	7531	1
9	8.1	439	17	7463	1
10	6.2	223	16	3568	1
11	8.9	208	18	3744	0
12	9.6	463	18	8334	1
13	8.2	441	17	7497	0
14	7.2	323	16	5168	1
15	9.5	297	18	5346	1
16	8	412	17	7004	1
17	10	324	18	5832	1
18	7.4	271	17	4607	1
19	7.9	349	17	5933	0
20	7.3	409	16	6544	1
21	8.7	373	18	6714	1
22	7.2	254	16	4064	1
23	9.9	274	18	4932	1
24	7.9	278	17	4726	1
25	7.5	317	17	5389	1
26	6.1	260	16	4160	0
27	8.8	211	18	3798	1
28	9.7	272	18	4896	1
29	7.4	264	17	4488	0
30	9.2	284	18	5112	1
Detection Percentage				Limit >60%	77%

Type 4 Radar Statistical Performance

Trial Number	Pulse Width (us)	PRI (us)	Number of Pulses	Waveform Length(us)	1=Detection Blank=No Detection
1	16	355	14	4970	1
2	11.3	487	12	5844	1
3	13.5	344	13	4472	1
4	19.4	288	16	4608	0
5	17.5	230	15	3450	0
6	15.3	432	14	6048	1
7	15.9	207	14	2898	1
8	14.3	443	13	5759	0
9	15.8	439	14	6146	1
10	11.5	223	12	2676	1
11	17.4	208	15	3120	1
12	19	463	16	7408	1
13	16	441	14	6174	1
14	13.8	323	13	4199	1
15	18.9	297	16	4752	1
16	15.5	412	14	5768	1
17	19.9	324	16	5184	0
18	14.1	271	13	3523	1
19	15.2	349	14	4886	0
20	13.8	409	13	5317	1
21	17.1	373	15	5595	1
22	13.8	254	13	3302	0
23	19.8	274	16	4384	1
24	15.3	278	14	3892	0
25	14.5	317	13	4121	1
26	11.3	260	12	3120	1
27	17.3	211	15	3165	1
28	19.2	272	16	4352	1
29	14.2	264	13	3432	0
30	18.2	284	15	4260	1
Detection Percentage				Limit >60%	73%

Type 5 Radar Statistical Performance

Trial Number	Number of Bursts	Test Radar Signal Name	Center Frequency (GHz)	1=Detection Blank=No Detection
1	15	LPluse_Radar_No.01	5.29	1
2	8	LPluse_Radar_No.02	5.29	1
3	11	LPluse_Radar_No.03	5.29	1
4	20	LPluse_Radar_No.04	5.29	1
5	17	LPluse_Radar_No.05	5.29	1
6	14	LPluse_Radar_No.06	5.29	1
7	15	LPluse_Radar_No.07	5.29	1
8	12	LPluse_Radar_No.08	5.29	1
9	14	LPluse_Radar_No.09	5.29	1
10	8	LPluse_Radar_No.10	5.29	1
11	17	LPluse_Radar_No.11	5.258	1
12	19	LPluse_Radar_No.12	5.259	1
13	15	LPluse_Radar_No.13	5.256	1
14	12	LPluse_Radar_No.14	5.255	1
15	19	LPluse_Radar_No.15	5.258	1
16	14	LPluse_Radar_No.16	5.256	1
17	20	LPluse_Radar_No.17	5.259	1
18	12	LPluse_Radar_No.18	5.255	1
19	14	LPluse_Radar_No.19	5.256	1
20	12	LPluse_Radar_No.20	5.255	1
21	16	LPluse_Radar_No.21	5.323	1
22	12	LPluse_Radar_No.22	5.325	0
23	20	LPluse_Radar_No.23	5.321	1
24	14	LPluse_Radar_No.24	5.324	1
25	13	LPluse_Radar_No.25	5.324	1
26	8	LPluse_Radar_No.26	5.327	0
27	17	LPluse_Radar_No.27	5.322	1
28	19	LPluse_Radar_No.28	5.321	1
29	12	LPluse_Radar_No.29	5.325	0
30	18	LPluse_Radar_No.30	5.322	1
Detection Percentage			Limit >80%	90%

Note: Type 5 radar parameter data sheet, please refer to Appendix E

Type 6 Radar Statistical Performance

Trial Number	Pulse Width (us)	PRI (us)	Number of Pulses	Waveform Length(us)	1=Detection Blank=No Detection
1	1	333.335	9	0.3333	1
2	1	333.335	9	0.3333	1
3	1	333.335	9	0.3333	1
4	1	333.335	9	0.3333	1
5	1	333.335	9	0.3333	1
6	1	333.335	9	0.3333	1
7	1	333.335	9	0.3333	1
8	1	333.335	9	0.3333	1
9	1	333.335	9	0.3333	1
10	1	333.335	9	0.3333	1
11	1	333.335	9	0.3333	1
12	1	333.335	9	0.3333	1
13	1	333.335	9	0.3333	1
14	1	333.335	9	0.3333	1
15	1	333.335	9	0.3333	1
16	1	333.335	9	0.3333	1
17	1	333.335	9	0.3333	1
18	1	333.335	9	0.3333	1
19	1	333.335	9	0.3333	1
20	1	333.335	9	0.3333	1
21	1	333.335	9	0.3333	1
22	1	333.335	9	0.3333	1
23	1	333.335	9	0.3333	1
24	1	333.335	9	0.3333	1
25	1	333.335	9	0.3333	1
26	1	333.335	9	0.3333	1
27	1	333.335	9	0.3333	1
28	1	333.335	9	0.3333	1
29	1	333.335	9	0.3333	1
30	1	333.335	9	0.3333	1
Detection Percentage				Limit >70%	100%

Modulation Mode: 802.11ax HE80 (Band 3)

Radar Type	Number of Trials	Number of Successful Detections	Probability	Limit	Result
1	30	30	100%	60%	Pass
2	30	24	80%	60%	Pass
3	30	24	80%	60%	Pass
4	30	24	80%	60%	Pass
Average			85%	80%	Pass
5	30	26	87%	80%	Pass
6	30	30	100%	70%	Pass

Type 1 Radar Statistical Performance

Trial Number	Pulse Width (us)	PRI (us)	Number of Pulses	Waveform Length(us)	1=Detection Blank=No Detection
1	1	938	57	53466	1
2	1	698	76	53048	1
3	1	618	86	53148	1
4	1	538	99	53262	1
5	1	878	61	53558	1
6	1	3066	18	55188	1
7	1	638	83	52954	1
8	1	918	58	53244	1
9	1	838	63	52794	1
10	1	858	62	53196	1
11	1	798	67	53466	1
12	1	718	74	53132	1
13	1	578	92	53176	1
14	1	598	89	53222	1
15	1	558	95	53010	1
16	1	2536	21	53256	1
17	1	966	55	53130	1
18	1	827	64	52928	1
19	1	2501	22	55022	1
20	1	2595	21	54495	1
21	1	1114	48	53472	1
22	1	1302	41	53382	1
23	1	3045	18	54810	1
24	1	1624	33	53592	1
25	1	2878	19	54682	1
26	1	1027	52	53404	1
27	1	2485	22	54670	1
28	1	1600	33	52800	1
29	1	1172	46	53912	1
30	1	1177	45	52965	1
Detection Percentage				Limit >60%	100%

Type 2 Radar Statistical Performance

Trial Number	Pulse Width (us)	PRI (us)	Number of Pulses	Waveform Length(us)	1=Detection Blank=No Detection
1	3.2	179	26	4654	1
2	1.1	207	23	4761	1
3	2.1	230	24	5520	1
4	4.8	200	29	5800	1
5	3.9	214	28	5992	1
6	2.9	222	26	5772	1
7	3.2	204	26	5304	1
8	2.5	192	25	4800	1
9	3.1	164	26	4264	1
10	1.2	156	23	3588	1
11	3.9	210	27	5670	1
12	4.6	201	29	5829	1
13	3.2	162	26	4212	1
14	2.2	197	25	4925	1
15	4.5	163	29	4727	0
16	3	203	26	5278	1
17	5	168	29	4872	1
18	2.4	217	25	5425	1
19	2.9	191	26	4966	0
20	2.3	166	25	4150	1
21	3.7	150	27	4050	1
22	2.2	176	25	4400	0
23	4.9	195	29	5655	1
24	2.9	202	26	5252	0
25	2.5	178	25	4450	1
26	1.1	206	23	4738	0
27	3.8	155	27	4185	1
28	4.7	157	29	4553	0
29	2.4	224	25	5600	1
30	4.2	159	28	4452	1
Detection Percentage				Limit >60%	80%

Type 3 Radar Statistical Performance

Trial Number	Pulse Width (us)	PRI (us)	Number of Pulses	Waveform Length(us)	1=Detection Blank=No Detection
1	8.2	355	17	6035	1
2	6.1	487	16	7792	1
3	7.1	344	16	5504	1
4	9.8	288	18	5184	1
5	8.9	230	18	4140	1
6	7.9	432	17	7344	1
7	8.2	207	17	3519	1
8	7.5	443	17	7531	1
9	8.1	439	17	7463	1
10	6.2	223	16	3568	1
11	8.9	208	18	3744	1
12	9.6	463	18	8334	1
13	8.2	441	17	7497	1
14	7.2	323	16	5168	0
15	9.5	297	18	5346	1
16	8	412	17	7004	1
17	10	324	18	5832	1
18	7.4	271	17	4607	1
19	7.9	349	17	5933	1
20	7.3	409	16	6544	1
21	8.7	373	18	6714	0
22	7.2	254	16	4064	0
23	9.9	274	18	4932	1
24	7.9	278	17	4726	1
25	7.5	317	17	5389	1
26	6.1	260	16	4160	0
27	8.8	211	18	3798	0
28	9.7	272	18	4896	0
29	7.4	264	17	4488	1
30	9.2	284	18	5112	1
Detection Percentage				Limit >60%	80%

Type 4 Radar Statistical Performance

Trial Number	Pulse Width (us)	PRI (us)	Number of Pulses	Waveform Length(us)	1=Detection Blank=No Detection
1	16	355	14	4970	1
2	11.3	487	12	5844	1
3	13.5	344	13	4472	1
4	19.4	288	16	4608	1
5	17.5	230	15	3450	0
6	15.3	432	14	6048	1
7	15.9	207	14	2898	1
8	14.3	443	13	5759	1
9	15.8	439	14	6146	1
10	11.5	223	12	2676	0
11	17.4	208	15	3120	1
12	19	463	16	7408	1
13	16	441	14	6174	1
14	13.8	323	13	4199	1
15	18.9	297	16	4752	1
16	15.5	412	14	5768	1
17	19.9	324	16	5184	1
18	14.1	271	13	3523	1
19	15.2	349	14	4886	1
20	13.8	409	13	5317	0
21	17.1	373	15	5595	1
22	13.8	254	13	3302	0
23	19.8	274	16	4384	1
24	15.3	278	14	3892	1
25	14.5	317	13	4121	1
26	11.3	260	12	3120	1
27	17.3	211	15	3165	1
28	19.2	272	16	4352	0
29	14.2	264	13	3432	0
30	18.2	284	15	4260	1
Detection Percentage				Limit >60%	80%

Type 5 Radar Statistical Performance

Trial Number	Number of Bursts	Test Radar Signal Name	Center Frequency (GHz)	1=Detection Blank=No Detection
1	15	LPluse_Radar_No.01	5.53	1
2	8	LPluse_Radar_No.02	5.53	1
3	11	LPluse_Radar_No.03	5.53	1
4	20	LPluse_Radar_No.04	5.53	1
5	17	LPluse_Radar_No.05	5.53	1
6	14	LPluse_Radar_No.06	5.53	1
7	15	LPluse_Radar_No.07	5.53	1
8	12	LPluse_Radar_No.08	5.53	1
9	14	LPluse_Radar_No.09	5.53	1
10	8	LPluse_Radar_No.10	5.53	1
11	17	LPluse_Radar_No.11	5.498	1
12	19	LPluse_Radar_No.12	5.499	1
13	15	LPluse_Radar_No.13	5.496	1
14	12	LPluse_Radar_No.14	5.495	1
15	19	LPluse_Radar_No.15	5.498	1
16	14	LPluse_Radar_No.16	5.496	1
17	20	LPluse_Radar_No.17	5.499	1
18	12	LPluse_Radar_No.18	5.495	1
19	14	LPluse_Radar_No.19	5.496	1
20	12	LPluse_Radar_No.20	5.495	1
21	16	LPluse_Radar_No.21	5.563	1
22	12	LPluse_Radar_No.22	5.565	0
23	20	LPluse_Radar_No.23	5.561	1
24	14	LPluse_Radar_No.24	5.564	1
25	13	LPluse_Radar_No.25	5.564	0
26	8	LPluse_Radar_No.26	5.567	0
27	17	LPluse_Radar_No.27	5.562	1
28	19	LPluse_Radar_No.28	5.561	1
29	12	LPluse_Radar_No.29	5.565	0
30	18	LPluse_Radar_No.30	5.562	1
Detection Percentage			Limit >80%	87%

Note: Type 5 radar parameter data sheet, please refer to Appendix E

Type 6 Radar Statistical Performance

Trial Number	Pulse Width (us)	PRI (us)	Number of Pulses	Waveform Length(us)	1=Detection Blank=No Detection
1	1	333.335	9	0.3333	1
2	1	333.335	9	0.3333	1
3	1	333.335	9	0.3333	1
4	1	333.335	9	0.3333	1
5	1	333.335	9	0.3333	1
6	1	333.335	9	0.3333	1
7	1	333.335	9	0.3333	1
8	1	333.335	9	0.3333	1
9	1	333.335	9	0.3333	1
10	1	333.335	9	0.3333	1
11	1	333.335	9	0.3333	1
12	1	333.335	9	0.3333	1
13	1	333.335	9	0.3333	1
14	1	333.335	9	0.3333	1
15	1	333.335	9	0.3333	1
16	1	333.335	9	0.3333	1
17	1	333.335	9	0.3333	1
18	1	333.335	9	0.3333	1
19	1	333.335	9	0.3333	1
20	1	333.335	9	0.3333	1
21	1	333.335	9	0.3333	1
22	1	333.335	9	0.3333	1
23	1	333.335	9	0.3333	1
24	1	333.335	9	0.3333	1
25	1	333.335	9	0.3333	1
26	1	333.335	9	0.3333	1
27	1	333.335	9	0.3333	1
28	1	333.335	9	0.3333	1
29	1	333.335	9	0.3333	1
30	1	333.335	9	0.3333	1
Detection Percentage				Limit >70%	100%

Modulation Mode: 802.11ax HE160 (Band 2)

Radar Type	Number of Trials	Number of Successful Detections	Probability	Limit	Result
1	30	30	100%	60%	Pass
2	30	28	93%	60%	Pass
3	30	25	83%	60%	Pass
4	30	23	77%	60%	Pass
Average			88%	80%	Pass
5	30	29	97%	80%	Pass
6	30	30	100%	70%	Pass

Type 1 Radar Statistical Performance

Trial Number	Pulse Width (us)	PRI (us)	Number of Pulses	Waveform Length(us)	1=Detection Blank=No Detection
1	1	938	57	53466	1
2	1	698	76	53048	1
3	1	618	86	53148	1
4	1	538	99	53262	1
5	1	878	61	53558	1
6	1	3066	18	55188	1
7	1	638	83	52954	1
8	1	918	58	53244	1
9	1	838	63	52794	1
10	1	858	62	53196	1
11	1	798	67	53466	1
12	1	718	74	53132	1
13	1	578	92	53176	1
14	1	598	89	53222	1
15	1	558	95	53010	1
16	1	2536	21	53256	1
17	1	966	55	53130	1
18	1	827	64	52928	1
19	1	2501	22	55022	1
20	1	2595	21	54495	1
21	1	1114	48	53472	1
22	1	1302	41	53382	1
23	1	3045	18	54810	1
24	1	1624	33	53592	1
25	1	2878	19	54682	1
26	1	1027	52	53404	1
27	1	2485	22	54670	1
28	1	1600	33	52800	1
29	1	1172	46	53912	1
30	1	1177	45	52965	1
Detection Percentage				Limit >60%	100%

Type 2 Radar Statistical Performance

Trial Number	Pulse Width (us)	PRI (us)	Number of Pulses	Waveform Length(us)	1=Detection Blank=No Detection
1	3.2	179	26	4654	1
2	1.1	207	23	4761	1
3	2.1	230	24	5520	1
4	4.8	200	29	5800	1
5	3.9	214	28	5992	1
6	2.9	222	26	5772	1
7	3.2	204	26	5304	1
8	2.5	192	25	4800	1
9	3.1	164	26	4264	1
10	1.2	156	23	3588	1
11	3.9	210	27	5670	1
12	4.6	201	29	5829	1
13	3.2	162	26	4212	1
14	2.2	197	25	4925	0
15	4.5	163	29	4727	1
16	3	203	26	5278	1
17	5	168	29	4872	1
18	2.4	217	25	5425	1
19	2.9	191	26	4966	1
20	2.3	166	25	4150	1
21	3.7	150	27	4050	0
22	2.2	176	25	4400	1
23	4.9	195	29	5655	1
24	2.9	202	26	5252	1
25	2.5	178	25	4450	1
26	1.1	206	23	4738	1
27	3.8	155	27	4185	1
28	4.7	157	29	4553	1
29	2.4	224	25	5600	1
30	4.2	159	28	4452	1
Detection Percentage				Limit >60%	93%

Type 3 Radar Statistical Performance

Trial Number	Pulse Width (us)	PRI (us)	Number of Pulses	Waveform Length(us)	1=Detection Blank=No Detection
1	8.2	355	17	6035	1
2	6.1	487	16	7792	1
3	7.1	344	16	5504	0
4	9.8	288	18	5184	1
5	8.9	230	18	4140	1
6	7.9	432	17	7344	1
7	8.2	207	17	3519	1
8	7.5	443	17	7531	1
9	8.1	439	17	7463	1
10	6.2	223	16	3568	1
11	8.9	208	18	3744	0
12	9.6	463	18	8334	1
13	8.2	441	17	7497	1
14	7.2	323	16	5168	0
15	9.5	297	18	5346	1
16	8	412	17	7004	1
17	10	324	18	5832	1
18	7.4	271	17	4607	1
19	7.9	349	17	5933	1
20	7.3	409	16	6544	1
21	8.7	373	18	6714	1
22	7.2	254	16	4064	1
23	9.9	274	18	4932	0
24	7.9	278	17	4726	1
25	7.5	317	17	5389	1
26	6.1	260	16	4160	1
27	8.8	211	18	3798	1
28	9.7	272	18	4896	1
29	7.4	264	17	4488	0
30	9.2	284	18	5112	1
Detection Percentage				Limit >60%	83%

Type 4 Radar Statistical Performance

Trial Number	Pulse Width (us)	PRI (us)	Number of Pulses	Waveform Length(us)	1=Detection Blank=No Detection
1	16	355	14	4970	1
2	11.3	487	12	5844	1
3	13.5	344	13	4472	1
4	19.4	288	16	4608	0
5	17.5	230	15	3450	1
6	15.3	432	14	6048	1
7	15.9	207	14	2898	1
8	14.3	443	13	5759	0
9	15.8	439	14	6146	0
10	11.5	223	12	2676	1
11	17.4	208	15	3120	1
12	19	463	16	7408	1
13	16	441	14	6174	1
14	13.8	323	13	4199	1
15	18.9	297	16	4752	1
16	15.5	412	14	5768	0
17	19.9	324	16	5184	1
18	14.1	271	13	3523	1
19	15.2	349	14	4886	1
20	13.8	409	13	5317	1
21	17.1	373	15	5595	1
22	13.8	254	13	3302	0
23	19.8	274	16	4384	1
24	15.3	278	14	3892	1
25	14.5	317	13	4121	1
26	11.3	260	12	3120	0
27	17.3	211	15	3165	0
28	19.2	272	16	4352	1
29	14.2	264	13	3432	1
30	18.2	284	15	4260	1
Detection Percentage				Limit >60%	77%

Type 5 Radar Statistical Performance

Trial Number	Number of Bursts	Test Radar Signal Name	Center Frequency (GHz)	1=Detection Blank=No Detection
1	15	LPluse_Radar_No.01	5.29	1
2	8	LPluse_Radar_No.02	5.29	1
3	11	LPluse_Radar_No.03	5.29	1
4	20	LPluse_Radar_No.04	5.29	1
5	17	LPluse_Radar_No.05	5.29	1
6	14	LPluse_Radar_No.06	5.29	1
7	15	LPluse_Radar_No.07	5.29	1
8	12	LPluse_Radar_No.08	5.29	1
9	14	LPluse_Radar_No.09	5.29	1
10	8	LPluse_Radar_No.10	5.29	1
11	17	LPluse_Radar_No.11	5.256	1
12	19	LPluse_Radar_No.12	5.258	1
13	15	LPluse_Radar_No.13	5.255	1
14	12	LPluse_Radar_No.14	5.254	1
15	19	LPluse_Radar_No.15	5.257	1
16	14	LPluse_Radar_No.16	5.255	1
17	20	LPluse_Radar_No.17	5.258	1
18	12	LPluse_Radar_No.18	5.254	1
19	14	LPluse_Radar_No.19	5.255	1
20	12	LPluse_Radar_No.20	5.254	1
21	16	LPluse_Radar_No.21	5.324	1
22	12	LPluse_Radar_No.22	5.326	1
23	20	LPluse_Radar_No.23	5.322	1
24	14	LPluse_Radar_No.24	5.325	1
25	13	LPluse_Radar_No.25	5.326	1
26	8	LPluse_Radar_No.26	5.328	0
27	17	LPluse_Radar_No.27	5.324	1
28	19	LPluse_Radar_No.28	5.322	1
29	12	LPluse_Radar_No.29	5.326	1
30	18	LPluse_Radar_No.30	5.323	1
Detection Percentage			Limit >80%	97%

Note: Type 5 radar parameter data sheet, please refer to Appendix E

Type 6 Radar Statistical Performance

Trial Number	Pulse Width (us)	PRI (us)	Number of Pulses	Waveform Length(us)	1=Detection Blank=No Detection
1	1	333.335	9	0.3333	1
2	1	333.335	9	0.3333	1
3	1	333.335	9	0.3333	1
4	1	333.335	9	0.3333	1
5	1	333.335	9	0.3333	1
6	1	333.335	9	0.3333	1
7	1	333.335	9	0.3333	1
8	1	333.335	9	0.3333	1
9	1	333.335	9	0.3333	1
10	1	333.335	9	0.3333	1
11	1	333.335	9	0.3333	1
12	1	333.335	9	0.3333	1
13	1	333.335	9	0.3333	1
14	1	333.335	9	0.3333	1
15	1	333.335	9	0.3333	1
16	1	333.335	9	0.3333	1
17	1	333.335	9	0.3333	1
18	1	333.335	9	0.3333	1
19	1	333.335	9	0.3333	1
20	1	333.335	9	0.3333	1
21	1	333.335	9	0.3333	1
22	1	333.335	9	0.3333	1
23	1	333.335	9	0.3333	1
24	1	333.335	9	0.3333	1
25	1	333.335	9	0.3333	1
26	1	333.335	9	0.3333	1
27	1	333.335	9	0.3333	1
28	1	333.335	9	0.3333	1
29	1	333.335	9	0.3333	1
30	1	333.335	9	0.3333	1
Detection Percentage				Limit >70%	100%

Modulation Mode: 802.11ax HE160 (Band 3)

Radar Type	Number of Trials	Number of Successful Detections	Probability	Limit	Result
1	30	30	100%	60%	Pass
2	30	21	70%	60%	Pass
3	30	25	83%	60%	Pass
4	30	24	80%	60%	Pass
Average			83%	80%	Pass
5	30	30	100%	60%	Pass
6	30	21	70%	60%	Pass

Type 1 Radar Statistical Performance

Trial Number	Pulse Width (us)	PRI (us)	Number of Pulses	Waveform Length(us)	1=Detection Blank=No Detection
1	1	938	57	53466	1
2	1	698	76	53048	1
3	1	618	86	53148	1
4	1	538	99	53262	1
5	1	878	61	53558	1
6	1	3066	18	55188	1
7	1	638	83	52954	1
8	1	918	58	53244	1
9	1	838	63	52794	1
10	1	858	62	53196	1
11	1	798	67	53466	1
12	1	718	74	53132	1
13	1	578	92	53176	1
14	1	598	89	53222	1
15	1	558	95	53010	1
16	1	2536	21	53256	1
17	1	966	55	53130	1
18	1	827	64	52928	1
19	1	2501	22	55022	1
20	1	2595	21	54495	1
21	1	1114	48	53472	1
22	1	1302	41	53382	1
23	1	3045	18	54810	1
24	1	1624	33	53592	1
25	1	2878	19	54682	1
26	1	1027	52	53404	1
27	1	2485	22	54670	1
28	1	1600	33	52800	1
29	1	1172	46	53912	1
30	1	1177	45	52965	1
Detection Percentage				Limit >60%	100%

Type 2 Radar Statistical Performance

Trial Number	Pulse Width (us)	PRI (us)	Number of Pulses	Waveform Length(us)	1=Detection Blank=No Detection
1	3.2	179	26	4654	1
2	1.1	207	23	4761	1
3	2.1	230	24	5520	1
4	4.8	200	29	5800	1
5	3.9	214	28	5992	1
6	2.9	222	26	5772	1
7	3.2	204	26	5304	1
8	2.5	192	25	4800	1
9	3.1	164	26	4264	0
10	1.2	156	23	3588	0
11	3.9	210	27	5670	1
12	4.6	201	29	5829	0
13	3.2	162	26	4212	0
14	2.2	197	25	4925	1
15	4.5	163	29	4727	1
16	3	203	26	5278	0
17	5	168	29	4872	0
18	2.4	217	25	5425	1
19	2.9	191	26	4966	1
20	2.3	166	25	4150	1
21	3.7	150	27	4050	1
22	2.2	176	25	4400	1
23	4.9	195	29	5655	1
24	2.9	202	26	5252	1
25	2.5	178	25	4450	0
26	1.1	206	23	4738	1
27	3.8	155	27	4185	0
28	4.7	157	29	4553	1
29	2.4	224	25	5600	1
30	4.2	159	28	4452	0
Detection Percentage				Limit >60%	70%

Type 3 Radar Statistical Performance

Trial Number	Pulse Width (us)	PRI (us)	Number of Pulses	Waveform Length(us)	1=Detection Blank=No Detection
1	8.2	355	17	6035	1
2	6.1	487	16	7792	1
3	7.1	344	16	5504	1
4	9.8	288	18	5184	1
5	8.9	230	18	4140	1
6	7.9	432	17	7344	0
7	8.2	207	17	3519	0
8	7.5	443	17	7531	1
9	8.1	439	17	7463	1
10	6.2	223	16	3568	1
11	8.9	208	18	3744	0
12	9.6	463	18	8334	1
13	8.2	441	17	7497	1
14	7.2	323	16	5168	1
15	9.5	297	18	5346	1
16	8	412	17	7004	1
17	10	324	18	5832	0
18	7.4	271	17	4607	1
19	7.9	349	17	5933	1
20	7.3	409	16	6544	1
21	8.7	373	18	6714	1
22	7.2	254	16	4064	1
23	9.9	274	18	4932	1
24	7.9	278	17	4726	0
25	7.5	317	17	5389	1
26	6.1	260	16	4160	1
27	8.8	211	18	3798	1
28	9.7	272	18	4896	1
29	7.4	264	17	4488	1
30	9.2	284	18	5112	1
Detection Percentage				Limit >60%	83%

Type 4 Radar Statistical Performance

Trial Number	Pulse Width (us)	PRI (us)	Number of Pulses	Waveform Length(us)	1=Detection Blank=No Detection
1	16	355	14	4970	1
2	11.3	487	12	5844	1
3	13.5	344	13	4472	0
4	19.4	288	16	4608	1
5	17.5	230	15	3450	1
6	15.3	432	14	6048	1
7	15.9	207	14	2898	1
8	14.3	443	13	5759	0
9	15.8	439	14	6146	1
10	11.5	223	12	2676	0
11	17.4	208	15	3120	0
12	19	463	16	7408	1
13	16	441	14	6174	1
14	13.8	323	13	4199	1
15	18.9	297	16	4752	1
16	15.5	412	14	5768	1
17	19.9	324	16	5184	1
18	14.1	271	13	3523	1
19	15.2	349	14	4886	0
20	13.8	409	13	5317	1
21	17.1	373	15	5595	1
22	13.8	254	13	3302	1
23	19.8	274	16	4384	0
24	15.3	278	14	3892	1
25	14.5	317	13	4121	1
26	11.3	260	12	3120	1
27	17.3	211	15	3165	1
28	19.2	272	16	4352	1
29	14.2	264	13	3432	1
30	18.2	284	15	4260	1
Detection Percentage				Limit >60%	80%

Type 5 Radar Statistical Performance

Trial Number	Number of Bursts	Test Radar Signal Name	Center Frequency (GHz)	1=Detection Blank=No Detection
1	15	LPluse_Radar_No.01	5.57	1
2	8	LPluse_Radar_No.02	5.57	1
3	11	LPluse_Radar_No.03	5.57	1
4	20	LPluse_Radar_No.04	5.57	1
5	17	LPluse_Radar_No.05	5.57	1
6	14	LPluse_Radar_No.06	5.57	1
7	15	LPluse_Radar_No.07	5.57	1
8	12	LPluse_Radar_No.08	5.57	1
9	14	LPluse_Radar_No.09	5.57	1
10	8	LPluse_Radar_No.10	5.57	1
11	17	LPluse_Radar_No.11	5.498	1
12	19	LPluse_Radar_No.12	5.499	1
13	15	LPluse_Radar_No.13	5.497	1
14	12	LPluse_Radar_No.14	5.496	0
15	19	LPluse_Radar_No.15	5.499	1
16	14	LPluse_Radar_No.16	5.496	1
17	20	LPluse_Radar_No.17	5.5	1
18	12	LPluse_Radar_No.18	5.496	0
19	14	LPluse_Radar_No.19	5.496	1
20	12	LPluse_Radar_No.20	5.496	0
21	16	LPluse_Radar_No.21	5.642	1
22	12	LPluse_Radar_No.22	5.645	1
23	20	LPluse_Radar_No.23	5.64	1
24	14	LPluse_Radar_No.24	5.644	1
25	13	LPluse_Radar_No.25	5.644	1
26	8	LPluse_Radar_No.26	5.646	0
27	17	LPluse_Radar_No.27	5.642	1
28	19	LPluse_Radar_No.28	5.641	1
29	12	LPluse_Radar_No.29	5.644	1
30	18	LPluse_Radar_No.30	5.642	1
Detection Percentage			Limit >80%	87%

Note: Type 5 radar parameter data sheet, please refer to Appendix E

Type 6 Radar Statistical Performance

Trial Number	Pulse Width (us)	PRI (us)	Number of Pulses	Waveform Length(us)	1=Detection Blank=No Detection
1	1	333.335	9	0.3333	1
2	1	333.335	9	0.3333	1
3	1	333.335	9	0.3333	1
4	1	333.335	9	0.3333	1
5	1	333.335	9	0.3333	1
6	1	333.335	9	0.3333	1
7	1	333.335	9	0.3333	1
8	1	333.335	9	0.3333	1
9	1	333.335	9	0.3333	1
10	1	333.335	9	0.3333	1
11	1	333.335	9	0.3333	1
12	1	333.335	9	0.3333	1
13	1	333.335	9	0.3333	1
14	1	333.335	9	0.3333	1
15	1	333.335	9	0.3333	1
16	1	333.335	9	0.3333	1
17	1	333.335	9	0.3333	1
18	1	333.335	9	0.3333	1
19	1	333.335	9	0.3333	1
20	1	333.335	9	0.3333	1
21	1	333.335	9	0.3333	1
22	1	333.335	9	0.3333	1
23	1	333.335	9	0.3333	1
24	1	333.335	9	0.3333	1
25	1	333.335	9	0.3333	1
26	1	333.335	9	0.3333	1
27	1	333.335	9	0.3333	1
28	1	333.335	9	0.3333	1
29	1	333.335	9	0.3333	1
30	1	333.335	9	0.3333	1
Detection Percentage				Limit >70%	100%

Modulation Mode: TDWR 802.11ax HE20 (Band 3)

Radar Type	Number of Trials	Number of Successful Detections	Probability	Limit	Result
1	30	30	100%	60%	Pass

Type 1 Radar Statistical Performance

Trial Number	Pulse Width (us)	PRI (us)	Number of Pulses	Waveform Length(us)	1=Detection Blank=No Detection
1	1	938	57	53466	1
2	1	698	76	53048	1
3	1	618	86	53148	1
4	1	538	99	53262	1
5	1	878	61	53558	1
6	1	3066	18	55188	1
7	1	638	83	52954	1
8	1	918	58	53244	1
9	1	838	63	52794	1
10	1	858	62	53196	1
11	1	798	67	53466	1
12	1	718	74	53132	1
13	1	578	92	53176	1
14	1	598	89	53222	1
15	1	558	95	53010	1
16	1	2536	21	53256	1
17	1	966	55	53130	1
18	1	827	64	52928	1
19	1	2501	22	55022	1
20	1	2595	21	54495	1
21	1	1114	48	53472	1
22	1	1302	41	53382	1
23	1	3045	18	54810	1
24	1	1624	33	53592	1
25	1	2878	19	54682	1
26	1	1027	52	53404	1
27	1	2485	22	54670	1
28	1	1600	33	52800	1
29	1	1172	46	53912	1
30	1	1177	45	52965	1
Detection Percentage				Limit >60%	100%

Modulation Mode: TDWR 802.11ax HE40

Radar Type	Number of Trials	Number of Successful Detections	Probability	Limit	Result
1	30	30	100%	60%	Pass

Type 1 Radar Statistical Performance

Trial Number	Pulse Width (us)	PRI (us)	Number of Pulses	Waveform Length(us)	1=Detection Blank=No Detection
1	1	938	57	53466	1
2	1	698	76	53048	1
3	1	618	86	53148	1
4	1	538	99	53262	1
5	1	878	61	53558	1
6	1	3066	18	55188	1
7	1	638	83	52954	1
8	1	918	58	53244	1
9	1	838	63	52794	1
10	1	858	62	53196	1
11	1	798	67	53466	1
12	1	718	74	53132	1
13	1	578	92	53176	1
14	1	598	89	53222	1
15	1	558	95	53010	1
16	1	2536	21	53256	1
17	1	966	55	53130	1
18	1	827	64	52928	1
19	1	2501	22	55022	1
20	1	2595	21	54495	1
21	1	1114	48	53472	1
22	1	1302	41	53382	1
23	1	3045	18	54810	1
24	1	1624	33	53592	1
25	1	2878	19	54682	1
26	1	1027	52	53404	1
27	1	2485	22	54670	1
28	1	1600	33	52800	1
29	1	1172	46	53912	1
30	1	1177	45	52965	1
Detection Percentage				Limit >60%	100%

Modulation Mode: TDWR 802.11ax HE80

Radar Type	Number of Trials	Number of Successful Detections	Probability	Limit	Result
1	30	30	100%	60%	Pass

Type 1 Radar Statistical Performance

Trial Number	Pulse Width (us)	PRI (us)	Number of Pulses	Waveform Length(us)	1=Detection Blank=No Detection
1	1	938	57	53466	1
2	1	698	76	53048	1
3	1	618	86	53148	1
4	1	538	99	53262	1
5	1	878	61	53558	1
6	1	3066	18	55188	1
7	1	638	83	52954	1
8	1	918	58	53244	1
9	1	838	63	52794	1
10	1	858	62	53196	1
11	1	798	67	53466	1
12	1	718	74	53132	1
13	1	578	92	53176	1
14	1	598	89	53222	1
15	1	558	95	53010	1
16	1	2536	21	53256	1
17	1	966	55	53130	1
18	1	827	64	52928	1
19	1	2501	22	55022	1
20	1	2595	21	54495	1
21	1	1114	48	53472	1
22	1	1302	41	53382	1
23	1	3045	18	54810	1
24	1	1624	33	53592	1
25	1	2878	19	54682	1
26	1	1027	52	53404	1
27	1	2485	22	54670	1
28	1	1600	33	52800	1
29	1	1172	46	53912	1
30	1	1177	45	52965	1
Detection Percentage				Limit >60%	100%

Modulation Mode: TDWR 802.11ax HE160

Radar Type	Number of Trials	Number of Successful Detections	Probability	Limit	Result
1	30	30	100%	60%	Pass

Type 1 Radar Statistical Performance

Trial Number	Pulse Width (us)	PRI (us)	Number of Pulses	Waveform Length(us)	1=Detection Blank=No Detection
1	1	938	57	53466	1
2	1	698	76	53048	1
3	1	618	86	53148	1
4	1	538	99	53262	1
5	1	878	61	53558	1
6	1	3066	18	55188	1
7	1	638	83	52954	1
8	1	918	58	53244	1
9	1	838	63	52794	1
10	1	858	62	53196	1
11	1	798	67	53466	1
12	1	718	74	53132	1
13	1	578	92	53176	1
14	1	598	89	53222	1
15	1	558	95	53010	1
16	1	2536	21	53256	1
17	1	966	55	53130	1
18	1	827	64	52928	1
19	1	2501	22	55022	1
20	1	2595	21	54495	1
21	1	1114	48	53472	1
22	1	1302	41	53382	1
23	1	3045	18	54810	1
24	1	1624	33	53592	1
25	1	2878	19	54682	1
26	1	1027	52	53404	1
27	1	2485	22	54670	1
28	1	1600	33	52800	1
29	1	1172	46	53912	1
30	1	1177	45	52965	1
Detection Percentage				Limit >60%	100%

Please refer to Appendix E for Radar Test Waveform.

5.2 Mains Emission

5.2.1 Mains Conducted Emission

Limit

Mains Conducted emissions as defined in §15.207 must comply with the mains conducted emission limits.

Kind of Test Site Shielded room

Test Setup

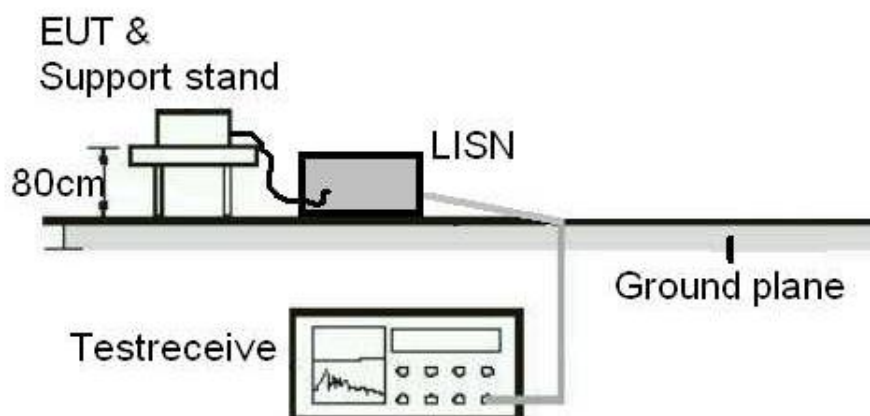

Test Instruments

Test Period: 2022-10-06

Kind of Equipment	Manufacturer	Type	S/N	Calibration Date	Calibration Due Date
Two-Line V-Network	Rohde & Schwarz	ENV216	101938	2022/9/22	2023/9/21
EMI Test Receiver	R&S	ESCI	1816063	2021/11/15	2022/11/14

Test Procedures

- a. The EUT was placed 0.4 meters from the conducting wall of the shielded room with EUT being connected to the power mains through a line impedance stabilization network (LISN). Other support units were connected to the power mains through another LISN. The two LISNs provide 50 ohm/50 uH of coupling impedance for the measuring instrument.
- b. Both lines of the power mains connected to the EUT were checked for maximum conducted interference.
- c. The frequency range from 150 kHz to 30 MHz was searched. Emission levels under (Limit – 20 dB) was not recorded.

Note: The resolution bandwidth and video bandwidth of test receiver is 9 kHz for quasi-peak detection (QP) and average detection (AV) at frequency 0.15 MHz – 30 MHz.

Test Results

Please refer to Appendix C.