

3G SIM Card Installation

Install your SIM card



.....
Note: Illustrations are for reference only. Actual product specifications may vary.

- 1 Turn off the power and disconnect the AC adapter.
- 2 Remove the battery.

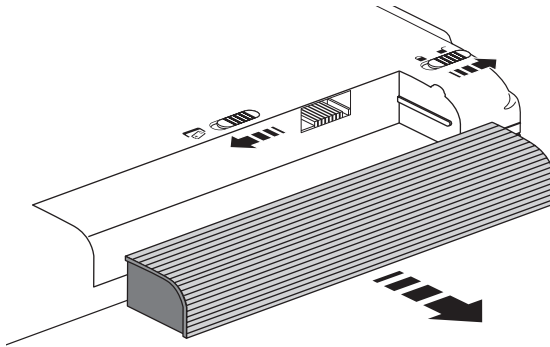

- 3 Put the new SIM card into the SIM card slot.

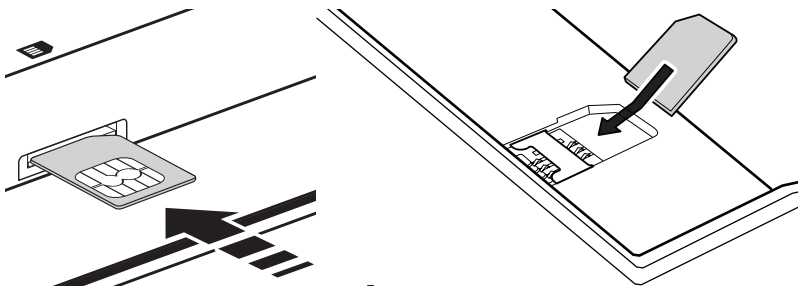

- 4 Insert battery and power on the computer.

Enable 3G

- 1 Extend the antenna to improve the reception quality.
(* only for certain models)

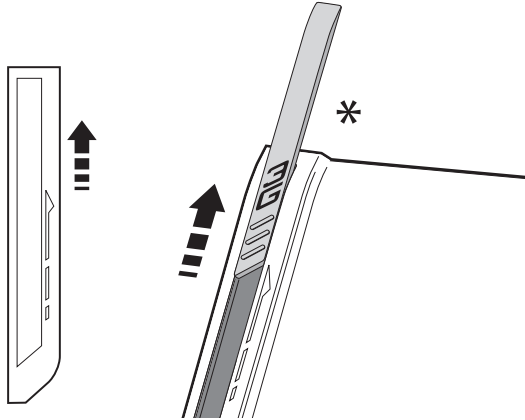

- 2 Push the switch to the left. The LED lights up when 3G is enabled.

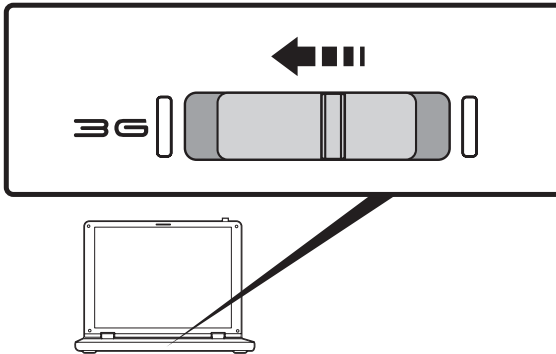

- 3 Repeat the same step to disable 3G, the LED will turn off.



.....
Important: Please read and observe the manufacturer's precautions and safety information provided with your SIM card.

How to use the 3G Connection Manager software



Note: Illustrations are for reference only. Actual product specifications may vary.

The 3G Connection Manager allows you to connect to a 3G network and includes tools that allow you to manage your usage, send and receive SMS messages from your computer and choose your network preferences.



Note: Please ensure the 3G function is enabled on your system.

Set up the 3G Connection Manager for the first time

When you first use the 3G Connection Manager you will be asked to select a 3G operator. Select your 3G operator profile from the scroll-down list and then click **OK**. The software will then set up the 3G Connection Manager software to suit your 3G network.

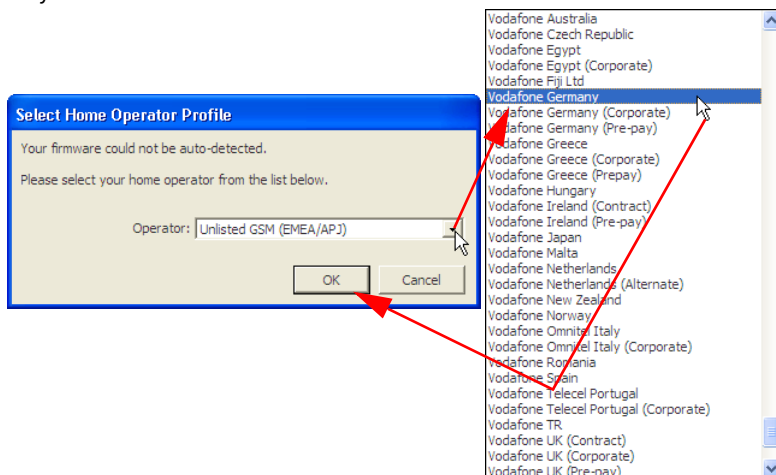

Start the 3G Connection Manager software

Double-click the **3G Connection Manager** icon (1) on the desktop, or click on **Start > All Programs > xxx 3G Connection Manager > xxx 3G Connection Manager** (2) in the Windows Taskbar.

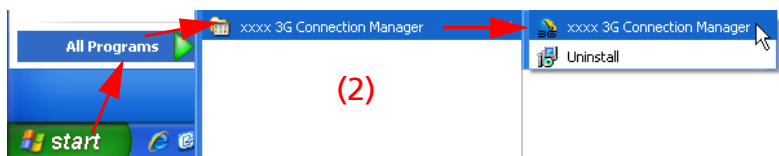
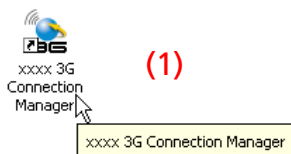

In the 3G Connection Manager main window, click **Connect** to connect.

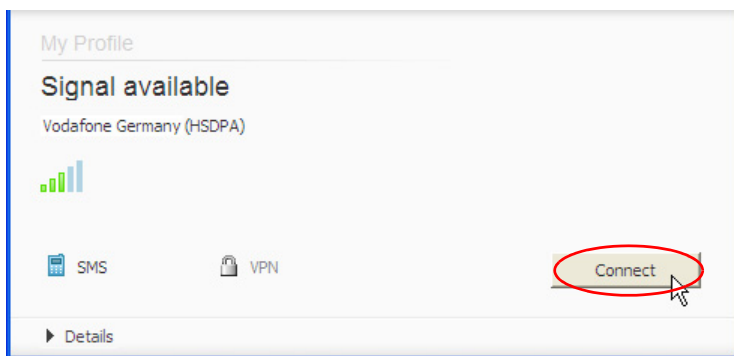

Connect to the internet with the Access Point Name

An APN (Access Point Name) is the point where a mobile device can enter an IP network. Some telecom companies offer a public APN that lets all customers access the Internet. Detailed APN information will be available when you purchase your 3G SIM.

To connect to the internet with the APN, you should follow the instructions below:

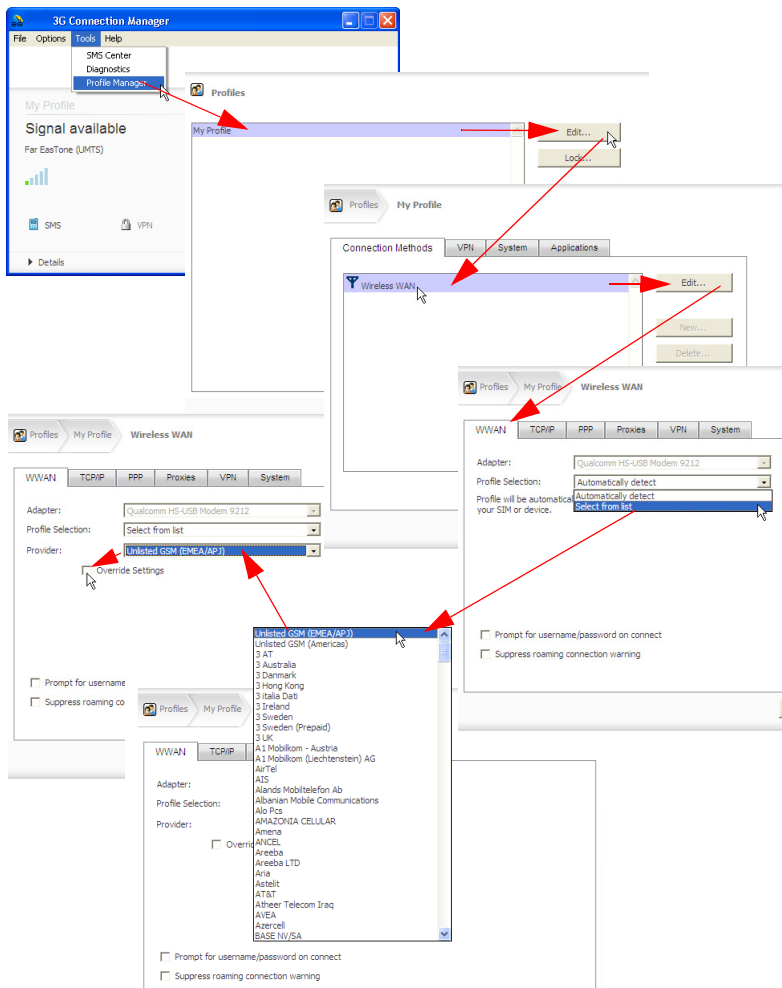

Please enter your User Name, Password and Access Point Name in the WWAN tab and return to the main window. Click **Connect** to connect to the Internet.

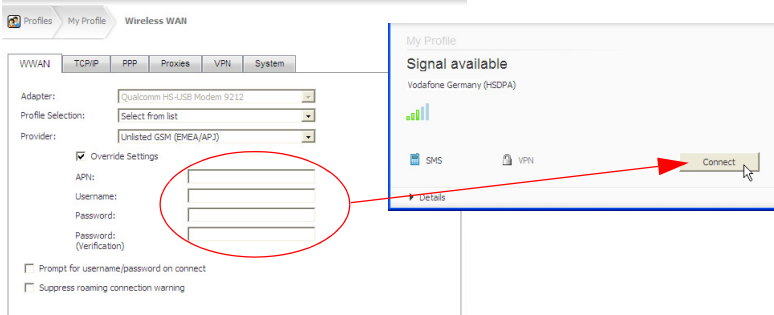

For more information refer to the Help file by clicking on **Help** in the **3G Connection Manager** main window.

Use SMS Text Messaging

With the 3G Connection Manager software, you can send and receive SMS (Short Message Service) text messages straight from your computer.

SMS Inbox

The program provides an easy way to view messages you have received, create new messages and manage contact details for frequently-used SMS numbers.

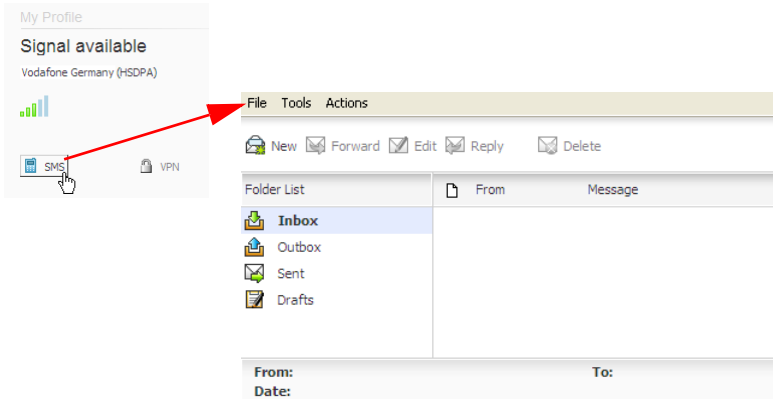

New SMS

When you click on the SMS button, you will see a pop-up window: SMS Message Center. Click **New** at the left-hand end of the toolbar to create a new SMS text message.

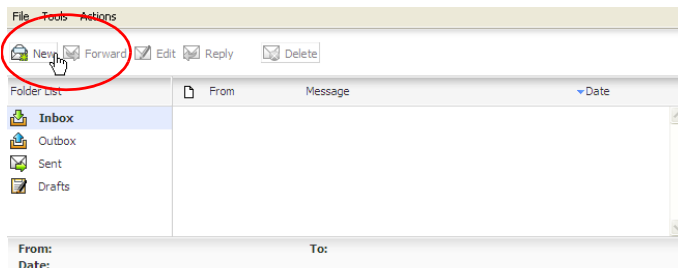

After your SMS has been sent, it will be stored in the **Sent** list.

