

Universal Notebook Data Platform (UNDP) Conducted Test Report

FCC Part 22 & 24 Certification	
FCC ID:	J9CUNDP-1
Model:	UNDP-1

STATEMENT OF CERTIFICATION

The data, data evaluation and equipment configuration represented herein are a true and accurate representation of the measurements of the sample's radio frequency interference emissions characteristics as of the dates and at the times of the test under the conditions herein specified.

Test performed by:	QUALCOMM Incorporated 5775 Morehouse Drive San Diego, CA 92121-1714
--------------------	---

Report Prepared by:	QUALCOMM Incorporated 5775 Morehouse Drive San Diego, CA 92121-1714
---------------------	---

Tests that required an OATS site were performed by Nemko Product Services.



Table of Contents

1. INTRODUCTION AND PURPOSE	3
2. DESCRIPTION OF DEVICE UNDER TEST	3
3. TEST SUMMARY	3
4. RF POWER OUTPUT VERIFICATION.....	3
4.1 BASE STATION EMULATOR SETTINGS AND MEASUREMENT PROCEDURES	3
4.1.1 For CDMA2000 1xEV-DO.....	4
4.1.2 For WCDMA/HSDPA/HSUPA	6
4.1.3 For GSM/GPRS/EDGE	8
4.2 TEST RESULTS	8
5. OCCUPIED BANDWIDTH.....	9
5.1 TEST PROCEDURES.....	9
5.2 TEST RESULTS	11
5.3 PLOTS.....	13
6. BLOCK EDGE COMPLIANCE.....	24
6.1 TEST PROCEDURES.....	24
6.2 TEST RESULTS	24
6.3 PLOTS.....	26
7. OUT OF BAND EMISSION AT ANTENNA TERMINALS.....	33
7.1 TEST PROCEDURE	33
7.2 TEST RESULT	34
7.3 PLOTS.....	35
8. FREQUENCY STABILITY	47
8.1 TEST PROCEDURE	47
8.2 TEST RESULTS	48
9. TEST EQUIPMENT AND FIRMWARE	56

1. Introduction and Purpose

This document provides the FCC test data for Qualcomm UNDP-1 wireless embedded modem. The tests included in this report are limited to all conducted tests required. The radiated tests were performed at Nemko USA, Inc. in San Diego, CA, and are reported in a separate document.

2. Description of Device Under Test

The product consists of a universal embedded-data-connectivity modem in the form of a PCI Express mini-card and the associated software suite for the notebook PC application. The UNDP-1 has the features of CDMA2000/1xEVDO data at 850 MHz and 1900 MHz with diversity support for both bands; WCDMA/HSDPA/HSUPA data at 850 MHz, 1900 MHz, and 2100 MHz with diversity support for all three bands; GSM/GPRS/EDGE data at 850 MHz, 900 MHz, 1800 MHz and 1900 MHz.

In the US and Canada, only 850 MHz (Cellular) and 1900 MHz (PCS) bands are used for CDMA2000, WCDMA and GSM operation. The UNDP-1 was only tested in those two bands for FCC application. The DUT is a pre-production sample.

3. Test Summary

FCC/IC Rule	Description of Test	Result	Page
§2.1046	RF Power Output	Complies	3
§2.1049	Occupied Bandwidth	Complies	10
§22.359, 24.238	Block Edge Requirement	Complies	24
§2.1051, 22.917, 24.238(a)	Out of Band Emission at Antenna Terminals	Complies	34
§2.1055, 22.355, 24.235	Frequency Stability vs. Temperature vs. Voltage	Complies	48
§1.1310, 2.1091	RF Exposure	Complies	See Exhibit 4
§2.1053, 22.917, 24.238(a)	Field Strength of Spurious Radiation	Complies	See Exhibit 3

4. RF Power Output Verification

FCC:	§ 2.1046
Limit:	n/a
DUT SN	N10DGGVRD

4.1 Base Station Emulator Settings and Measurement Procedures

As shown in the figure below, connect the transmitter output of the UNDP-1 to the communication test set (8820B or 8960) and configure it to operate at maximum power in a call. Measure the power at three equally spaced operating frequencies for each band.

Use the build-in power measurement capability in the 8960 box to measure CDMA 1x/1xEVDO conducted power outputs, and 8820B to measure UMTS conducted power outputs.

The relevant cable loss is measured for the specific frequencies under test and added as a correction factor for all the tests.



4.1.1 For CDMA2000 1xEV-DO

Measure the power at Ch1013, 384 and 777 for US cell; Ch25, 600 and 1175 for US PCS band.

1xRTT

Use CDMA2000 Rev 6 protocol in the call box 8960.

- 1) Test for Reverse/Forward TCH RC1, Reverse/Forward TCH RC2, and RC3 Reverse FCH and demodulation of RC 3, 4 and 5.
 - a. Set up a call using Fundamental Channel Test Mode 1 (RC1, SO 2) with 9600 bps data rate only.
 - b. As per C.S0011 or TIA/EIA-98-F Table 4.4.5.2-1, set the test parameters as shown in Table 4-1.
 - c. Send continuously ‘0’ power control bits to the UNDP-1.
 - d. Measure the output power at UNDP-1 antenna connector as recorded on the power meter with values corrected for cables losses.
 - e. Repeat step b through d for Fundamental Channel Test Mode:
 - i. RC1, SO55
 - ii. RC2, SO9
 - iii. RC2, SO55
 - iv. RC3, SO55

- 2) Test for RC 3 Reverse FCH, RC3 Reverse SCH0 and demodulation of RC 3, 4 and 5.
 - a. Set up a call using Supplemental Channel Test Mode 3 (RC 3, SO 32) with 9600 bps Fundamental Channel and 9600 bps SCH0 data rate.
 - b. As per C.S0011 or TIA/EIA-98-F Table 4.4.5.2-2, set the test parameters as shown in Table 4-2.
 - c. Send alternating ‘0’ and ‘1’ power control bit to the UNDP-1
 - d. Determine the active channel configuration. If the desired channel configuration is not the active channel configuration, increase \hat{I}_{or} by 1 dB and repeat the verification. Repeat this step until the desired channel configuration becomes active.
 - e. Measure the output power at the UNDP-1 antenna connector.
 - f. Decrease \hat{I}_{or} by 0.5 dB.
 - g. Determine the active channel configuration. If the active channel configuration is the desired channel configuration, measure the output power at the UNDP-1 antenna connector.
 - h. Repeat step f and g until the output power no longer increases or the desired channel configuration is no longer active. Record the highest output power achieved with the desired channel configuration active.
 - i. Repeat step a through h ten times and average the result.

Table 4-1 Parameters for Max. Power with a single traffic code channel, SR1

Parameter	Units	Value
\hat{I}_{or}	dBm/1.23 MHz	-104
$\frac{\text{Pilot } E_c}{\hat{I}_{or}}$	dB	-7
$\frac{\text{Traffic } E_c}{\hat{I}_{or}}$	dB	-7.4

Table 4-2 Parameters for Max. Power with multiple traffic code channel, SR1

Parameter	Units	Value
$\frac{\text{Pilot } E_c}{I_{or}}$	dB	-7
$\frac{\text{Traffic } E_c}{I_{or}}$	dB	-7.4

1xEV-DO

- 1) Use 1xEV-DO Rel 0 protocol in the call box 8960.
 - a. FTAP
 - Select Test Application Protocol to FTAP
 - Set FTAP Rate to 307.2 kbps (2 Slot, QPSK)
 - Generator Info -> Termination Parameters -> Max Forward Packet Duration -> 16 Slots
 - Set \hat{I}_{or} to -60 dBm/1.23 MHz
 - Send continuously '0' power control bits
 - Measure the power at UNDP-1 antenna connector
 - b. RTAP
 - Select Test Application Protocol to RTAP
 - Set RTAP Rate to 9.6 kbps
 - Generator Info -> Termination Parameters -> Max Forward Packet Duration -> 16 Slots
 - Set \hat{I}_{or} to -60 dBm/1.23 MHz
 - Send continuously '0' power control bits
 - Measure the power at UNDP-1 antenna connector
 - Repeat above steps for RTAP Rate = 19.2 kbps, 38.4 kbps, 76.8 kbps and 153.6 kbps respectively

- 2) Use 1xEV-DO Rev A protocol in the call box 8960
 - a. FETAP
 - Select Test Application Protocol to FETAP
 - Set FETAP Rate to 307.2 kbps (2 Slot, QPSK)
 - Generator Info -> Termination Parameters -> Max Forward Packet Duration -> 16 Slots
 - Set \hat{I}_{or} to -60 dBm/1.23 MHz
 - Send continuously '0' power control bits
 - Measure the power at UNDP-1 antenna connector
 - b. RETAP
 - Select Test Application Protocol to RETAP
 - F-Traffic Format -> 4 (1024, 2, 128) Canonical (307.2k, QPSK)
 - Set R-Data Pkt Size to 128
 - Protocol Subtype Config -> Release A Physical Layer Subtype -> Subtype 2
->PL Subtype 2 Access Channel MAC Subtype -> Default (Subtype 0)
 - Generator Info -> Termination Parameters -> Max Forward Packet Duration -> 16 Slots
->ACK R-Data After -> Subpacket 0 (All ACK)

- Set \hat{I}_{or} to -60 dBm/1.23 MHz
- Send continuously '0' power control bits
- Measure the power at UNDP-1 antenna connector
- Repeat above steps for R-Data Pkt Size = 256, 512, 768, 1024, 1536, 2048, 3072, 4096, 6144, 8192, 12288 respectively.

4.1.2 For WCDMA/HSDPA/HSUPA

Configure the call box 8820B to support all WCDMA tests in respect to the 3GPP 34.121 (listed in Table 4-3). Measure the power at Ch4132, 4182 and 4233 for US cell; Ch9262, 9400 and 9538 for US PCS band.

For Rel99

- Set a Test Mode 1 loop back with a 12.2kbps Reference Measurement Channel (RMC)
- Set and send continuously Up power control commands to the UNDP-1
- Measure the power at the UNDP-1 antenna connector using the power meter with average detector

For HSDPA Rel 6

- Establish a Test Mode 1 loop back with both 1 12.2kbps RMC channel and a H-Set1 Fixed Reference Channel (FRC). With the 8820 this is accomplished by setting the signal Channel Coding to "Fixed Reference Channel" and configuring for HSET-1 QKSP.
- Set beta values and HSDPA settings for HSDPA Subtest1 according to Table 4-3
- Send continuously Up power control commands to the UNDP-1
- Measure the power at the UNDP-1 antenna connector using the power meter with modulated average detector
- Repeat the measurement for the HSDPA Subtest2, 3 and 4 as given in Table 4-3

For HSUPA Rel 6

- Use UL RMC 12.2kbps and FRC H-Set1 QPSK, Test Mode 1 loop back. With the 8820 this is accomplished by setting the signal Channel Coding to "E-DCH Test Channel" and configuring the equipment category to Cat5_10ms.
- Set the Absolute Grant for HSUPA Subtest1 according to Table 4-3
- Set the UNDP power to be at least 5dB lower than the Maximum output power
- Send power control bits to give one TPC_cmd = +1 command to the UNDP. If UNDP doesn't send any E-DPCH data with decreased E-TFCI within 500ms, then repeat this process until the decreased E-TFCI is reported.
- Confirm that the E-TFCI transmitted by the UNDP is equal to the target E-TFCI in Table 4-3. If the E-TFCI transmitted by the UNDP is not equal to the target E-TFCI, then send power control bits to give one TPC_cmd = -1 command to the UE. If UE sends any E-DPCH data with decreased E-TFCI within 500 ms, send new power control bits to give one TPC_cmd = -1 command to the UE. Then confirm that the E-TFCI transmitted by the UE is equal to the target E-TFCI in Table 4-3. If the E-TFCI transmitted by the UE is not equal to the target E-TFCI, then fail the UE
- Measure the power using the power meter with modulated average detector
- Repeat the measurement for the HSUPA Subtest2, 3, 4 and 5 as given in Table 4-3

Table 4-3 3GPP Rel99/HSPA Subtest Settings

Subtest	Mode	Loopback Mode	Rel99 RMC	HSDPA FRC	HSUPA Test	Common Settings		CM	MPR	Power Class 3 limit	HSDPA Specific Settings						HSUPA Specific Settings			HSUPA Additional Info					
						β_c	β_d				ΔACK	ΔNAK	ΔCQI	Ack-Nack repetition factor	CQI Feedback [Table 5.2B.4]	CQI Repetition Factor [Table 5.2B.4]	Ahs = β_{hs}/β_c	$\Delta E-DPCCH$	$\Delta HARQ$	AG Index	ETFCI (from 34.121 Table C.11.1.3)	Associated Max UL Data Rate kbps			
1	Rel99	Test Mode 1	12.2kbps	-	-			-		24 (+1.7/-3.7 dB)															-
1	Rel6 HSDPA	Test Mode 1	12.2kbps	H-Set1	-	2/15	15/15	0	0	24 (+1.7/-3.7 dB)	8	8	8	3	4ms	2	30/15								-
2	Rel6 HSDPA	Test Mode 1	12.2kbps	H-Set1	-	12/15	15/15	1	0	24 (+1.7/-3.7 dB)	8	8	8	3	4ms	2	30/15								-
3	Rel6 HSDPA	Test Mode 1	12.2kbps	H-Set1	-	15/15	8/15	1.5	0.5	23.5 (+2.2/-3.7 dB)	8	8	8	3	4ms	2	30/15								-
4	Rel6 HSDPA	Test Mode 1	12.2kbps	H-Set1	-	15/15	4/15	1.5	0.5	23.5 (+2.2/-3.7 dB)	8	8	8	3	4ms	2	30/15								-
1	Rel6 HSUPA	Test Mode 1	12.2kbps	H-Set1	HSUPA Loopback	11/15	15/15	1	0	24 (+1.7/-3.7 dB)	8	8	8	3	4ms	2	30/15	6	0	20	75				242.1
2	Rel6 HSUPA	Test Mode 1	12.2kbps	H-Set1	HSUPA Loopback	6/15	15/15	3	2	22 (+3.7/-3.7 dB)	8	8	8	3	4ms	2	30/15	8	0	12	67				174.9
3	Rel6 HSUPA	Test Mode 1	12.2kbps	H-Set1	HSUPA Loopback	15/15	9/15	2	1	23 (+2.7/-3.7 dB)	8	8	8	3	4ms	2	30/15	8	0	15	92				482.8
4	Rel6 HSUPA	Test Mode 1	12.2kbps	H-Set1	HSUPA Loopback	2/15	15/15	3	2	22 (+3.7/-3.7 dB)	8	8	8	3	4ms	2	30/15	5	0	17	71				205.8
5	Rel6 HSUPA	Test Mode 1	12.2kbps	H-Set1	HSUPA Loopback	15/15	15/15	1	0	24 (+1.7/-3.7 dB)	8	8	8	3	4ms	2	30/15	7	0	21	81				308.9

HSUPA Subtest 1,2,4,5

- Reference E-TFCIs	5 E-TFCIs
- Reference E-TFCI	11
- Reference E-TFCI PO	4
- Reference E-TFCI	67
- Reference E-TFCI PO	18
- Reference E-TFCI	71
- Reference E-TFCI PO	23
- Reference E-TFCI	75
- Reference E-TFCI PO	26
- Reference E-TFCI	81
- Reference E-TFCI PO	27

HSUPA Subtest 3

- Reference E-TFCIs	2 E-TFCIs
- Reference E-TFCI	11
- Reference E-TFCI PO	4
- Reference E-TFCI	92
- Reference E-TFCI PO	18

4.1.3 For GSM/GPRS/EDGE

Configure the 8820B box to support GMSK and 8PSK call respectively, and set one timeslot transmission for GMSK GSM/GPRS and 8PSK EDGE. Measure and record power outputs for both modulations.

4.2 Test Results

CDMA2000 1xEV-DO

Mode	Test Case			Cell Channel			PCS Channel		
	#	FWD RC/TAP	REV RC/TAP	1013	384	777	25	600	1175
1x	1	RC1	RC1 (SO2)	24.81	24.85	24.61	24.56	24.42	24.14
	2	RC1	RC1 (SO55)	24.77	24.81	24.74	24.61	24.49	24.29
	3	RC2	RC2 (SO9)	24.68	24.85	24.64	24.59	24.45	24.26
	4	RC2	RC2 (SO55)	24.82	24.83	24.72	24.61	24.53	24.36
	5	RC3	RC3 (SO55)	24.89	24.87	24.78	24.55	24.45	24.25
	6	RC3	RC3 (SO32)	23.26	23.31	23.38	23.09	23.20	23.17
1xEVDO Rel0	7a	FTAP Rate = 307kbps (2 slot, QPSK)	RTAP rate = 9.6kbps	24.78	24.75	24.70	24.21	24.27	23.94
	7b		RTAP rate = 19.2kbps	24.75	24.83	24.50	24.25	24.26	23.87
	7c		RTAP rate = 38.4kbps	24.79	24.71	24.62	24.21	24.20	23.92
	7d		RTAP rate = 76.8kbps	24.73	24.72	24.59	24.18	24.27	23.80
	7e		RTAP rate = 153.6kbps	24.92	24.89	24.73	24.53	24.40	23.99
1xEVDO RevA	8a	FETAP rate = 307kbps (2 slot, ACK channel is transmitted at all the slots)	RETAP - payload size = 128	24.89	24.92	24.72	24.44	24.49	24.08
	8b		RETAP - payload size = 256	24.75	24.88	24.76	24.54	24.31	24.11
	8c		RETAP - payload size = 512	24.81	24.90	24.80	24.40	24.41	24.07
	8d		RETAP - payload size = 768	24.82	24.75	24.77	24.42	24.52	24.10
	8e		RETAP - payload size = 1024	24.84	24.92	24.73	24.50	24.46	24.08
	8f		RETAP - payload size = 1536	24.84	24.86	24.67	24.48	24.51	24.03
	8g		RETAP - payload size = 2048	24.91	24.88	24.71	24.56	24.41	24.02
	8h		RETAP - payload size = 3072	24.89	24.85	24.68	24.48	24.51	24.09
	8i		RETAP - payload size = 4096	24.73	24.85	24.80	24.55	24.40	24.12
	8j		RETAP - payload size = 6144	24.82	24.86	24.66	24.50	24.38	24.04
	8k		RETAP - payload size = 8192	24.78	24.90	24.83	24.52	24.49	24.15
8l	RETAP - payload size = 12288	24.82	24.91	24.73	24.34	24.37	24.14		

WCDMA/HSDPA/HSUPA

Mode	3GPP Subtest	Band V Channel			Band II Channel			MPR
		4132	4182	4233	9262	9400	9538	
Rel99	1	24.22	24.42	24.20	24.54	24.25	24.08	
Rel6 HSDPA	1	24.24	24.28	24.07	24.30	24.24	23.92	0
	2	24.15	24.37	24.03	24.38	24.14	23.84	0
	3	23.81	23.73	23.57	24.34	24.07	23.94	0.5
	4	23.74	23.62	23.63	23.81	23.69	23.47	0.5
Rel6 HSUPA	1	23.85	24.12	23.88	24.48	23.95	24.03	0
	2	21.98	21.99	21.91	22.60	21.90	21.97	2
	3	22.70	22.96	22.50	23.50	22.88	22.89	1
	4	21.93	21.84	21.88	22.82	22.08	21.90	2
	5	24.03	23.91	24.00	24.57	24.20	24.06	0

Note: The MPR has been implemented into the UNDP-1 per the 3GPP standard.

GSM/GPRS/EDGE

Mode	GSM850 Channel			GSM1900 Channel			Modulation
	128	190	251	512	661	810	
GSM	32.92	32.96	32.93	29.33	29.47	29.35	GMSK
GPRS	32.98	32.70	32.64	29.34	29.41	29.30	GMSK
EGPRS	27.50	27.83	27.71	26.65	26.81	26.53	8PSK

5. Occupied Bandwidth

FCC:	§2.1049		
Limit:	n/a		
DUT SN	N10DGGVRD		
Modes Tested	CDMA 1x / 1x-EVDO	WCDMA/HSPA	GSM/GPRS/EDGE
	<ul style="list-style-type: none"> ▪ RC3 SO55 ▪ Rel 0, RTAP rate = 153.6kbps ▪ Rev A, RETAP payload = 4096 	<ul style="list-style-type: none"> ▪ Rel 99 ▪ Rel 6 HSUPA, Subtest 5 	<ul style="list-style-type: none"> ▪ GSM ▪ EDGE

5.1 Test Procedures

As Figure below indicates, connected the transmitter output to a calibrated coaxial cable and coupler. The other end of coupler was connected to the spectrum analyzer. Measured the occupied bandwidth (defined as the 99% power bandwidth) with the appropriate personality features integrated in the PSA.

Used 8960 call box for CDMA 1x/1x-EVDO measurement, and 8820B for UMTS testing.

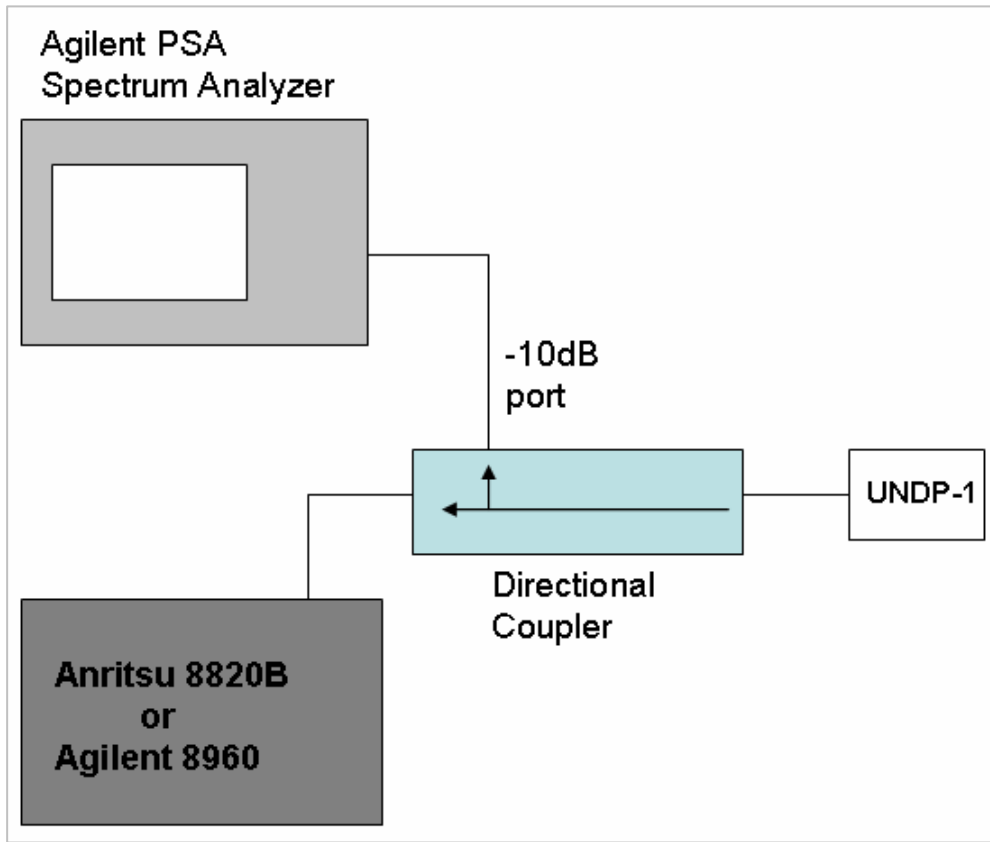

5.2 Test Results

The occupied bandwidth was measured at low, mid and high channel in each band.

Mode		Frequency (MHz)	Channel	99% Occupied Bandwidth (kHz)	Corresponding Plot number
GSM/ GPRS/ EDGE	GMSK	824.2	128	238.1	Plot 5.2 - 1
		836.6	190	241.2	Plot 5.2 - 2
		848.8	251	247.8	Plot 5.2 - 3
		1850.2	512	245.4	Plot 5.2 - 4
		1880	661	243.4	Plot 5.2 - 5
		1909.8	810	249.9	Plot 5.2 - 6
	8PSK	824.2	128	241.9	Plot 5.2 - 7
		836.6	190	243.7	Plot 5.2 - 8
		848.8	251	247.5	Plot 5.2 - 9
		1850.2	512	241.6	Plot 5.2 - 10
		1880	661	241.5	Plot 5.2 - 11
		1909.8	810	245.2	Plot 5.2 - 12

Mode		Frequency (MHz)	Channel	99% Occupied Bandwidth (MHz)	Plot number
WCDMA/ HSDPA/ HSUPA	Rel 99	826.4	4132	4.1625	Plot 5.2 - 13
		836.4	4182	4.1510	Plot 5.2 - 14
		846.6	4233	4.1619	Plot 5.2 - 15
		1852.4	9262	4.1632	Plot 5.2 - 16
		1880	9400	4.1628	Plot 5.2 - 17
		1907.5	9538	4.1475	Plot 5.2 - 18
	HSUPA Rel 6 Subtest 5	826.4	4132	4.1767	Plot 5.2 - 19
		836.4	4182	4.1689	Plot 5.2 - 20
		846.6	4233	4.1547	Plot 5.2 - 21
		1852.4	9262	4.1783	Plot 5.2 - 22
		1880	9400	4.1930	Plot 5.2 - 23
		1907.5	9538	4.1765	Plot 5.2 - 24

Mode		Frequency (MHz)	Channel	99% Occupied Bandwidth (MHz)	Plot number
CDMA1x/ 1x-EVDO	RC3 SO55	824.7	1013	1.2837	Plot 5.2 - 25
		836.52	384	1.2768	Plot 5.2 - 26
		848.31	777	1.2734	Plot 5.2 - 27
		1851.25	25	1.2742	Plot 5.2 - 28
		1880	600	1.2750	Plot 5.2 - 29
		1908.75	1175	1.2778	Plot 5.2 - 30
	Rel 0 RTAP rate = 153.6kbps	824.7	1013	1.2773	Plot 5.2 - 31
		836.52	384	1.2745	Plot 5.2 - 32
		848.31	777	1.2803	Plot 5.2 - 33
		1851.25	25	1.2755	Plot 5.2 - 34
		1880	600	1.2734	Plot 5.2 - 35
		1908.75	1175	1.2700	Plot 5.2 - 36
	Rev A RETAP Payload size = 4096	824.7	1013	1.2748	Plot 5.2 - 37
		836.52	384	1.2777	Plot 5.2 - 38
		848.31	777	1.2819	Plot 5.2 - 39
		1851.25	25	1.2806	Plot 5.2 - 40
		1880	600	1.2822	Plot 5.2 - 41
		1908.75	1175	1.2797	Plot 5.2 - 42

5.3 Plots

Plot 5.2 -1 (Ch128, GMSK)

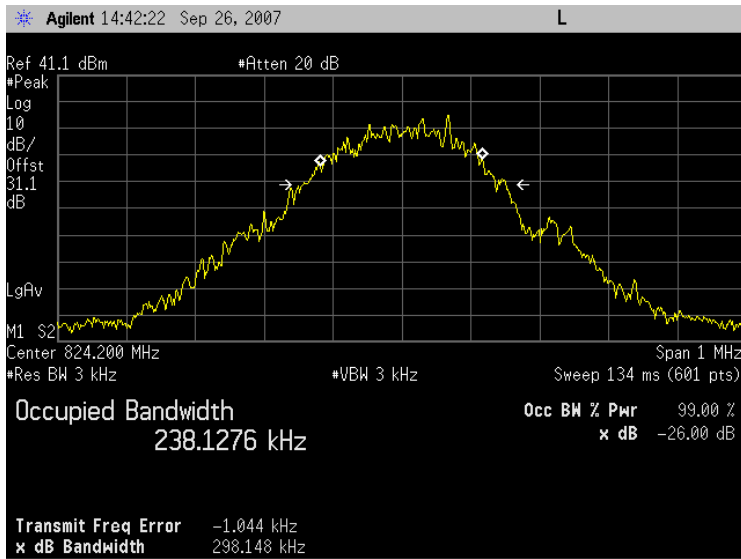

Plot 5.2 -2 (Ch190, GMSK)



Plot 5.2 -3 (CH251, GMSK)



Plot 5.2 -4 (Ch512, GMSK)

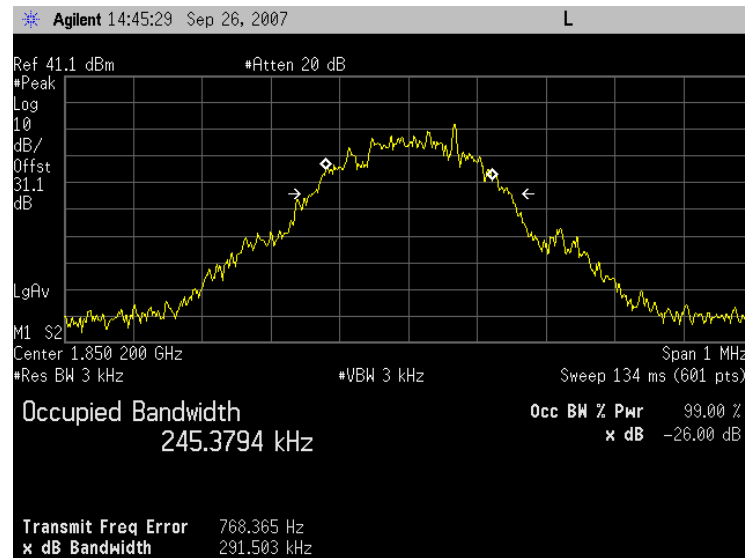

Plot 5.2 - 5 (Ch661, GMSK)

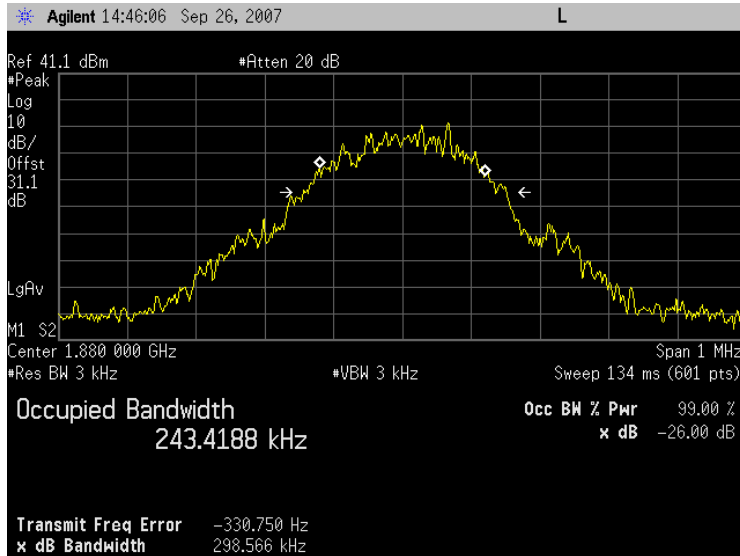

Plot 5.2 - 6 (Ch810, GMSK)

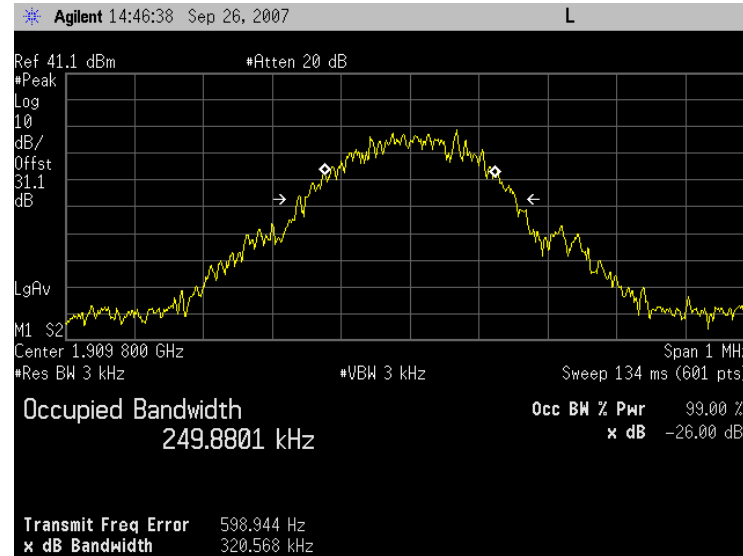

Plot 5.2 - 7 (Ch128, 8PSK)

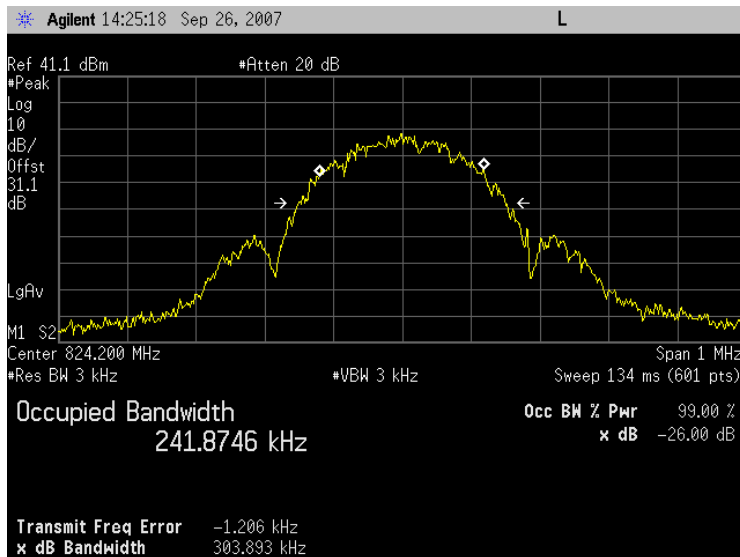

Plot 5.2 - 8 (Ch190, 8PSK)

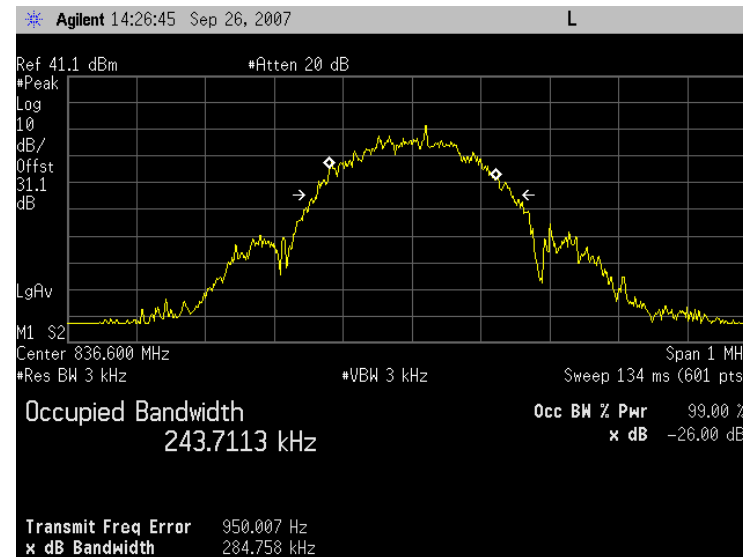

Plot 5.2 - 9 (Ch251, 8PSK)

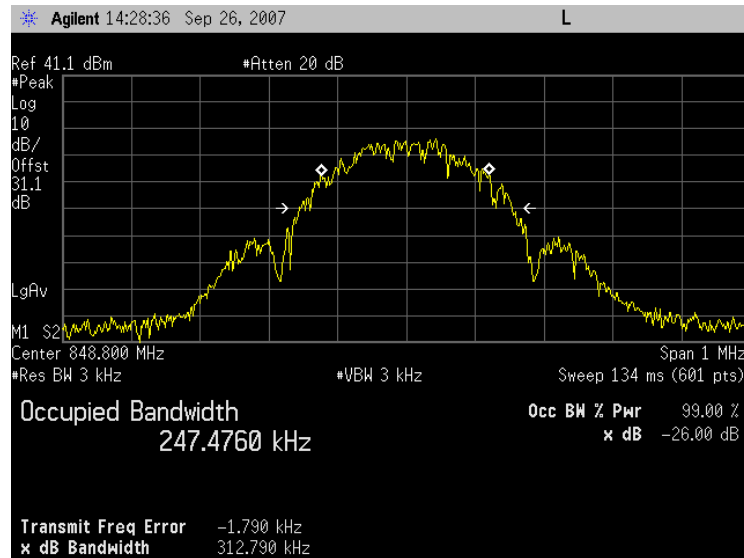

Plot 5.2 - 10 (Ch512, 8PSK)

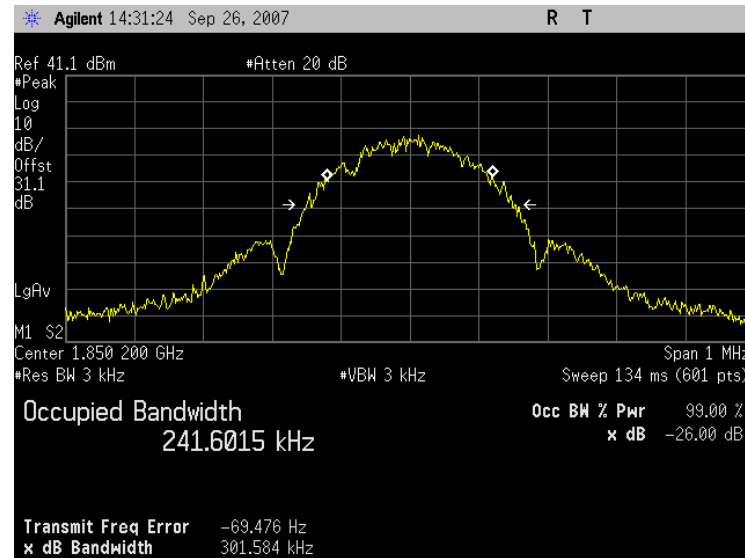

Plot 5.2 - 11 (Ch661, 8PSK)

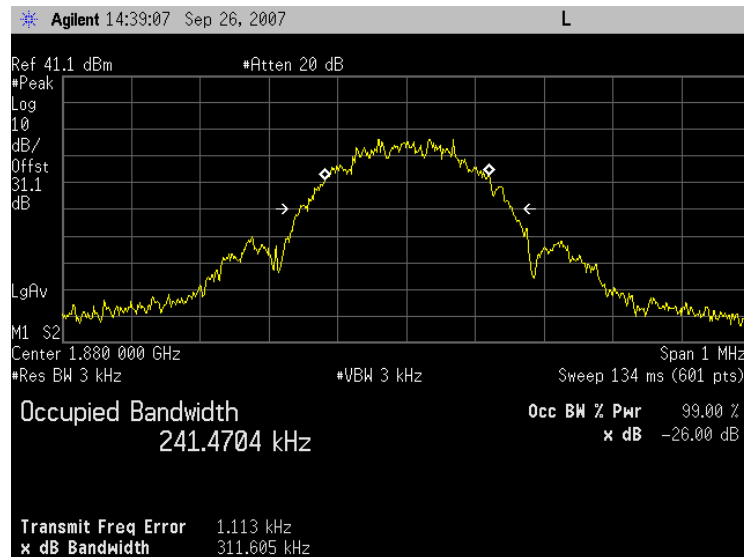

Plot 5.2 - 12 (Ch810, 8PSK)

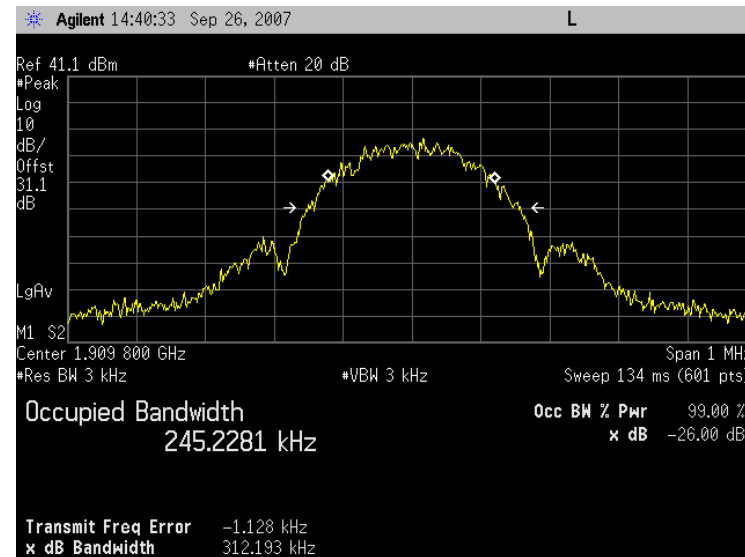

Plot 5.2 - 13 (Ch4132, Rel 99)

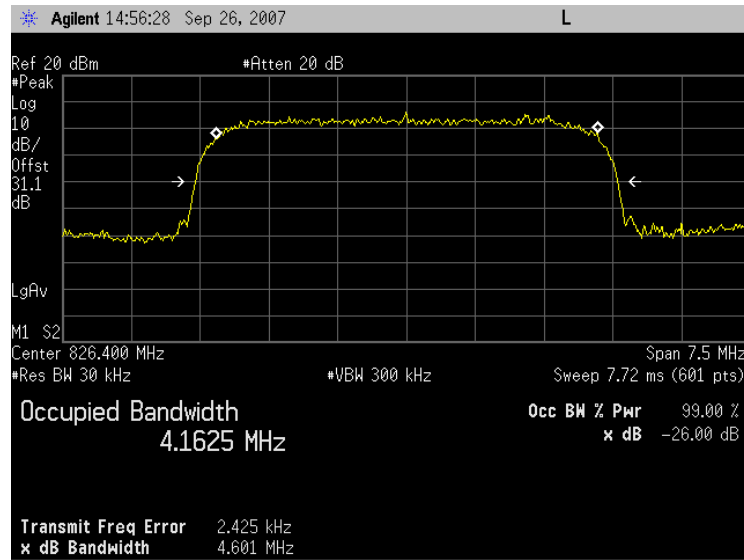

Plot 5.2 - 14 (Ch4182, Rel 99)

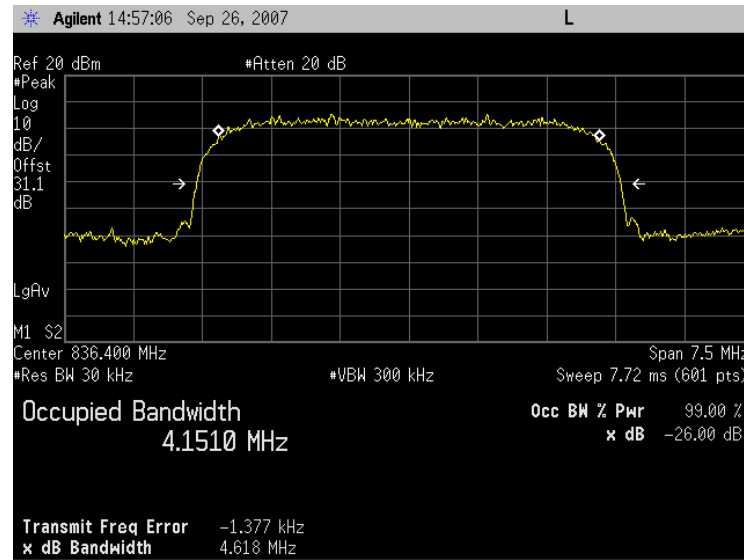

Plot 5.2 - 15 (Ch4233, Rel 99)

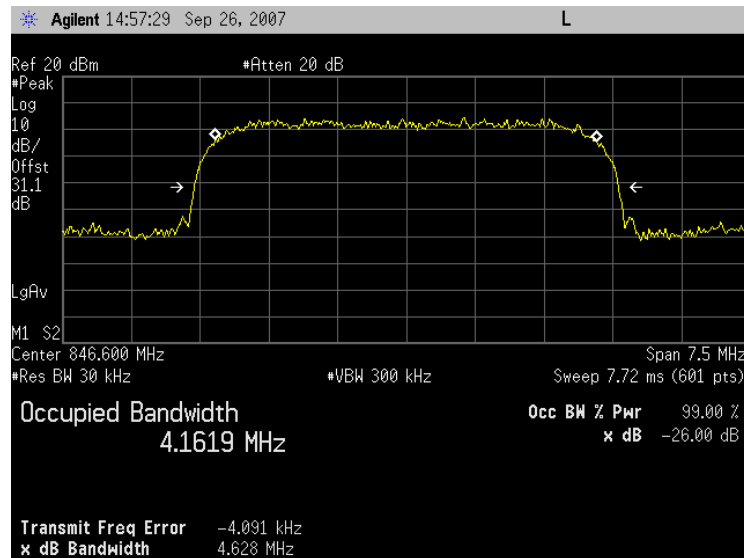

Plot 5.2 - 16 (Ch9262, Rel 99)

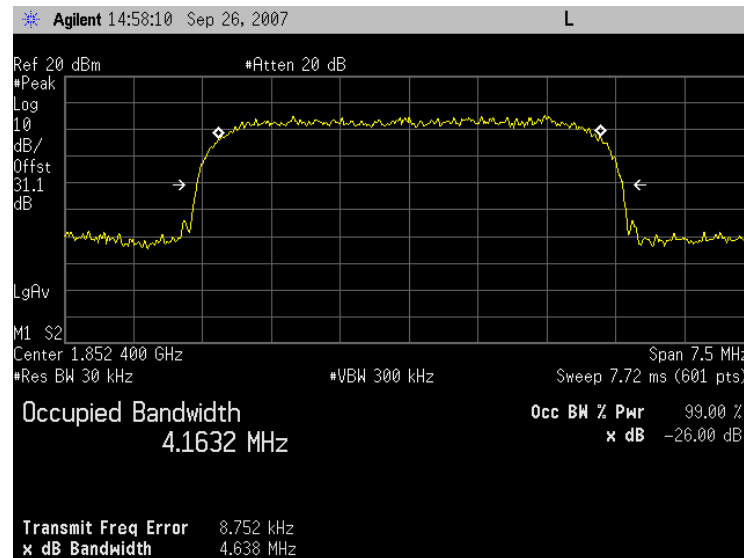

Plot 5.2 - 17 (Ch9400, Rel 99)

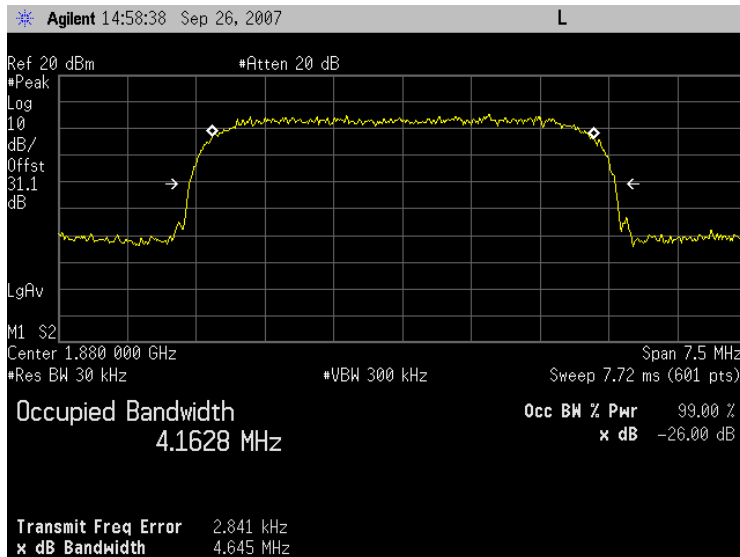

Plot 5.2 - 18 (Ch9538, Rel 99)

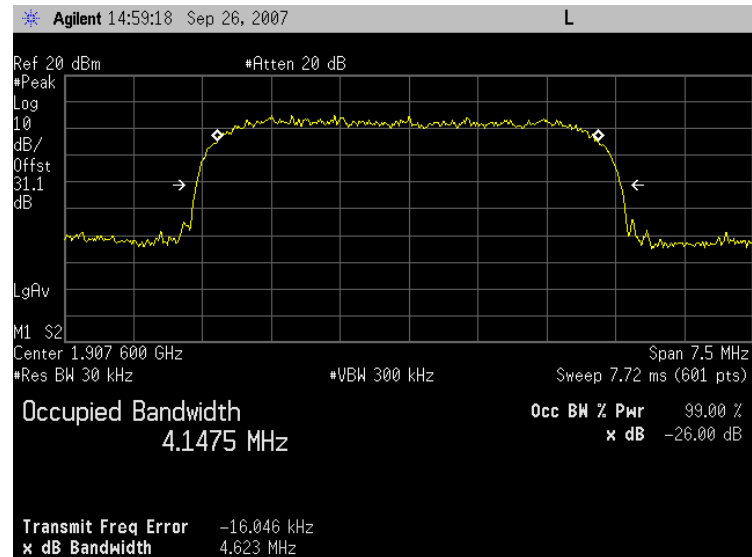

Plot 5.2 - 19 (Ch4132, HSUPA Subtest 5)

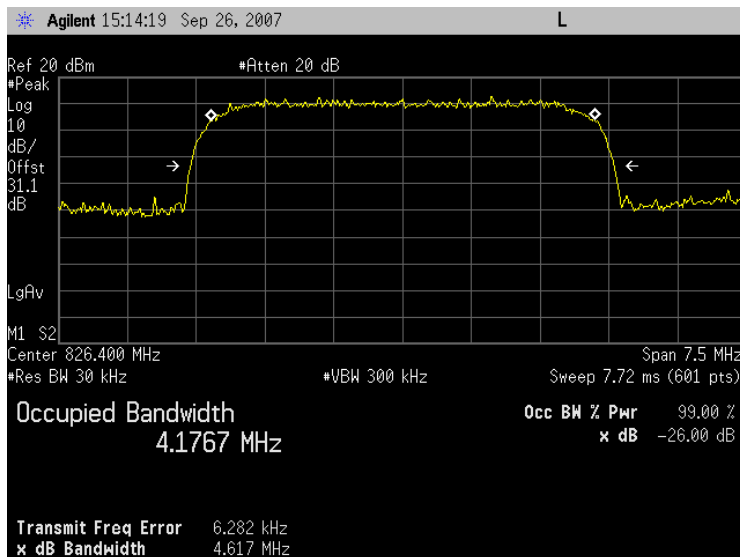

Plot 5.2 - 20 (Ch4182, HSUPA Subtest 5)

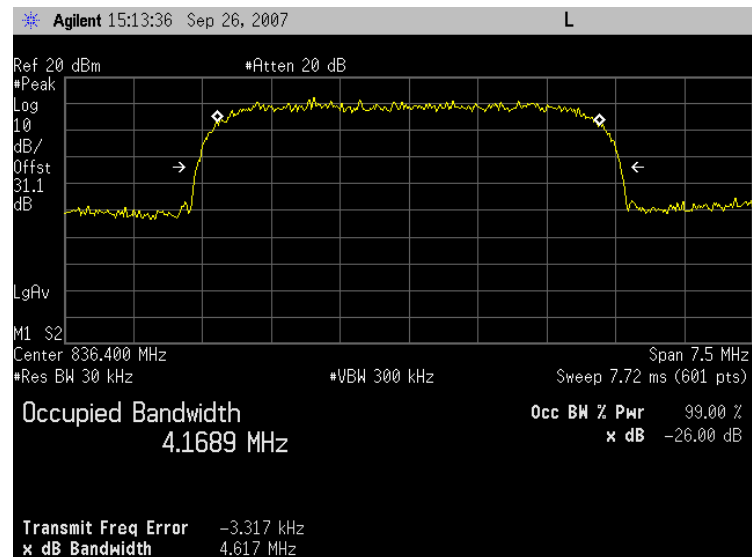

Plot 5.2 - 21 (Ch4233, HSUPA Subtest 5)

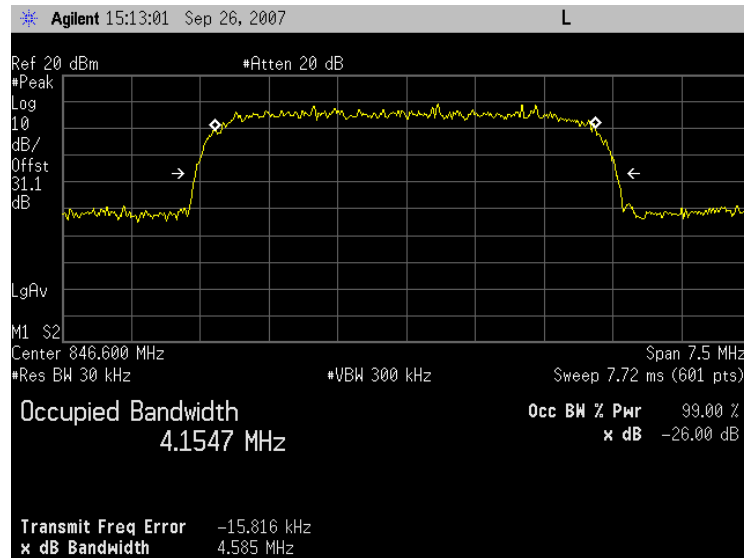

Plot 5.2 - 22 (Ch9262, HSUPA Subtest 5)

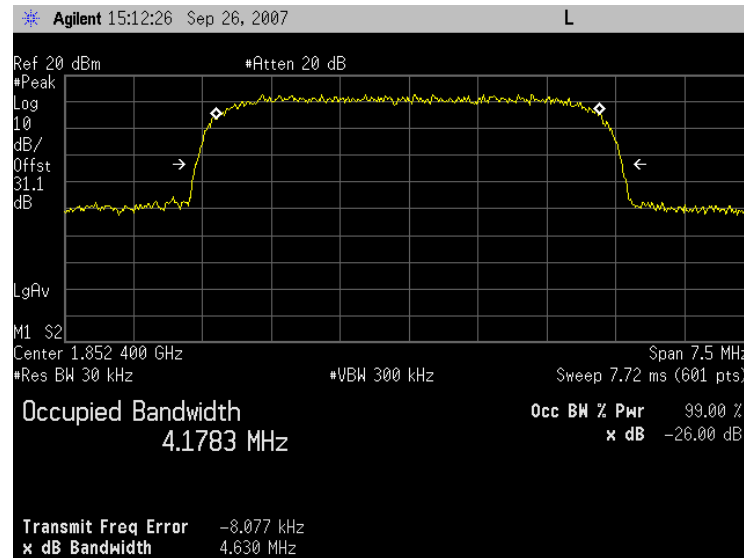

Plot 5.2 - 23 (Ch9400, HSUPA Subtest 5)

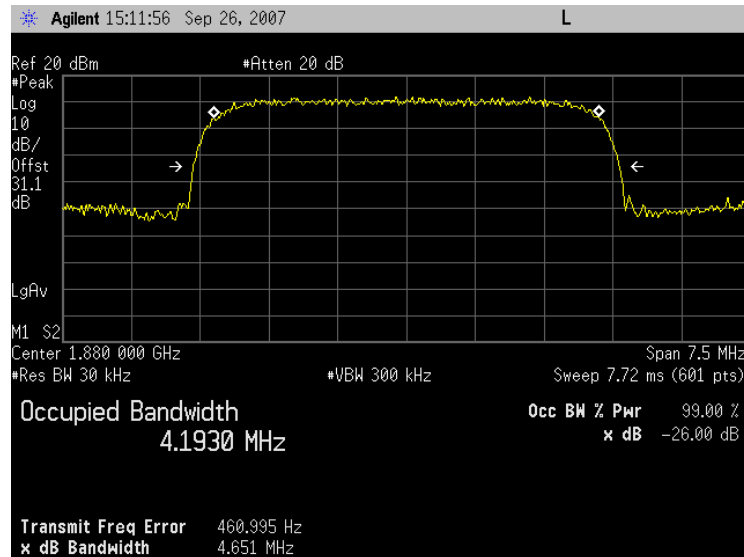

Plot 5.2 - 24 (Ch9538, HSUPA Subtest 5)

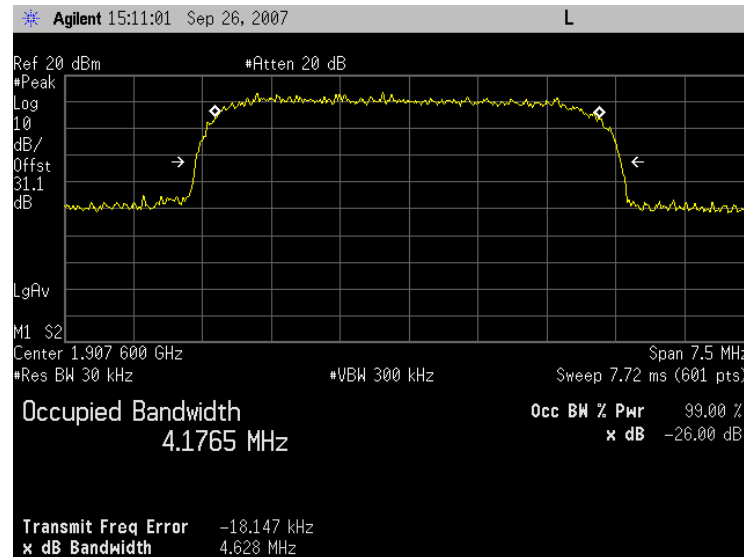

Plot 5.2 - 25 (Ch1013, RC3 SO55)

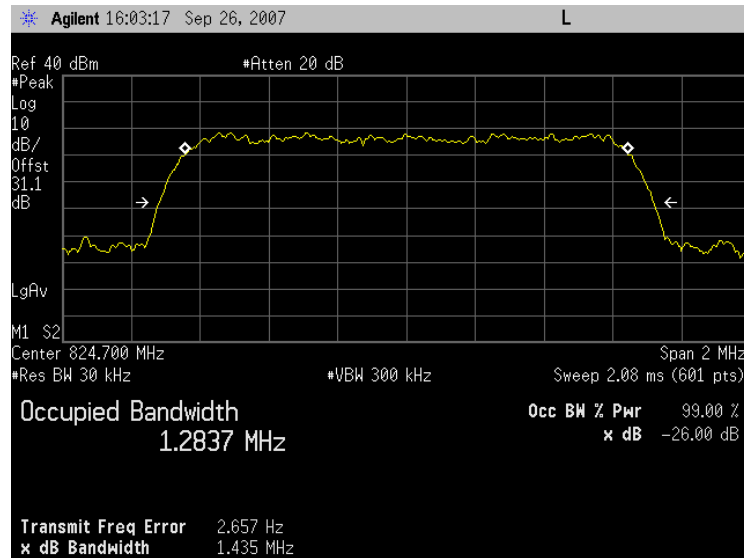

Plot 5.2 - 26 (Ch384, RC3 SO55)

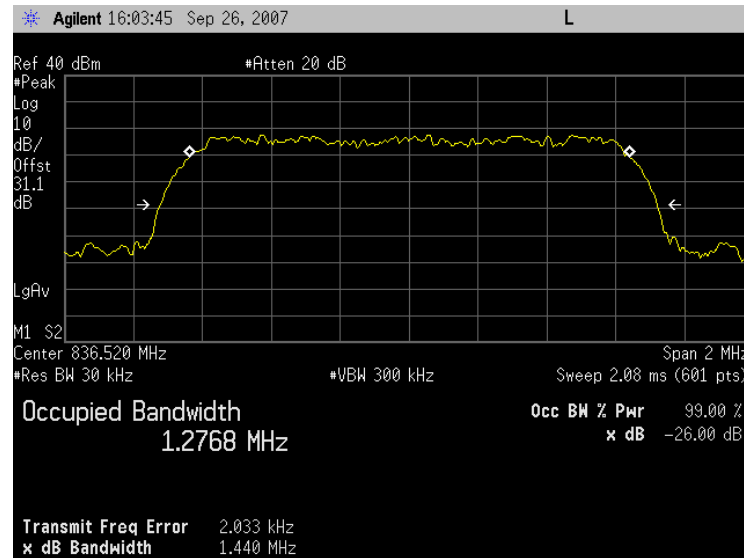

Plot 5.2 - 27 (Ch777, RC3 SO55)

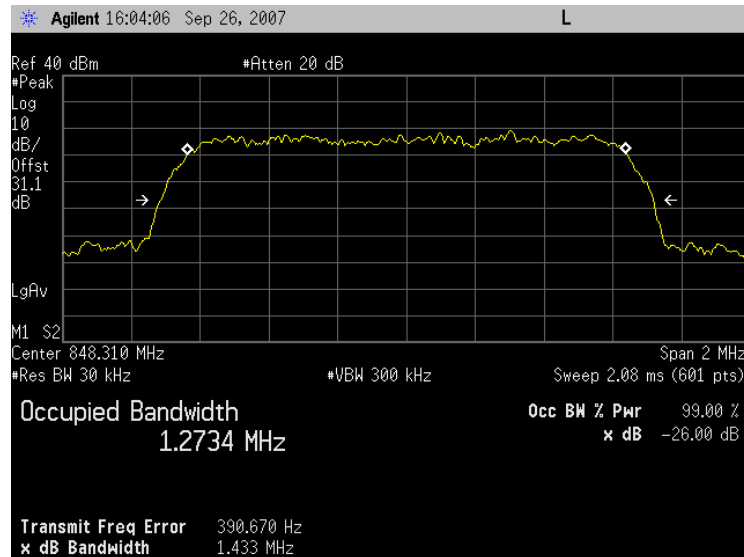

Plot 5.2 - 28 (Ch25, RC3 SO55)

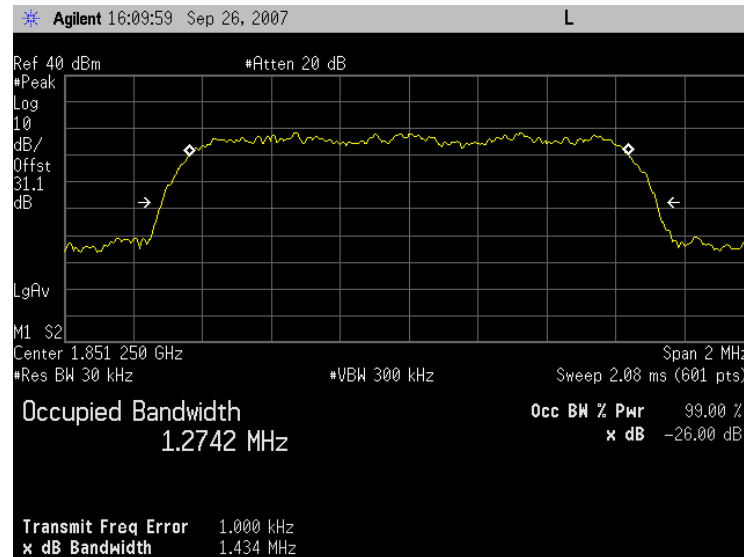

Plot 5.2 - 29 (Ch600, RC3 SO55)

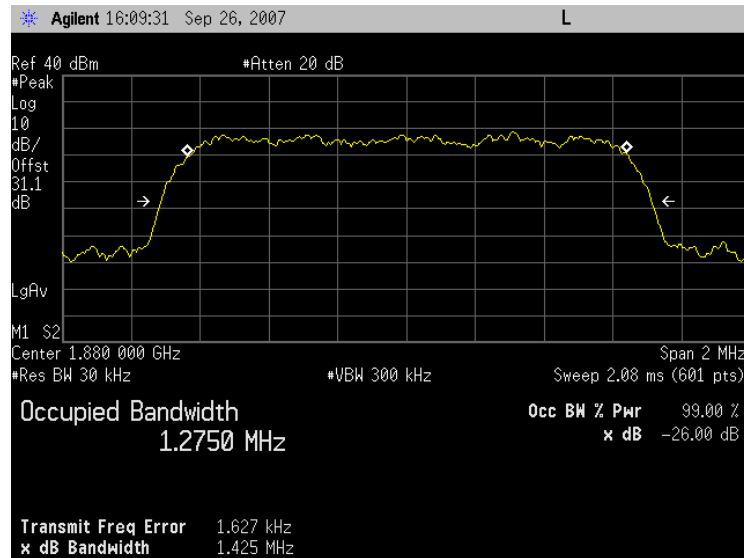

Plot 5.2 - 30 (Ch1175, RC3 SO55)

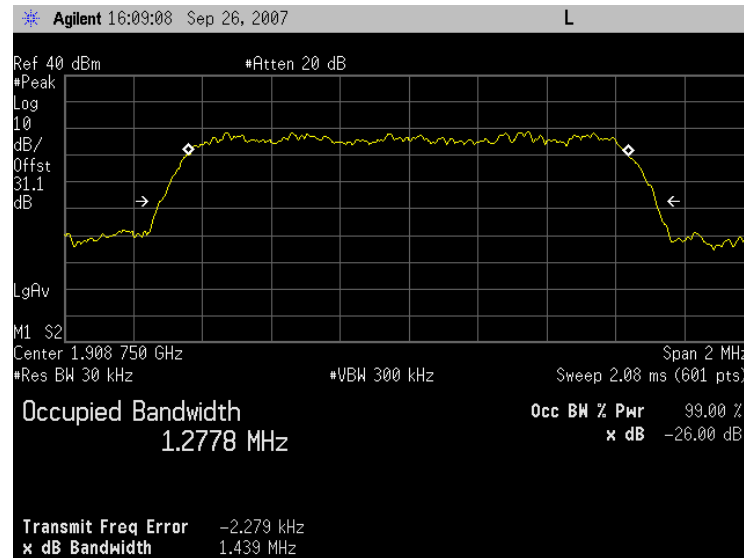

Plot 5.2 - 31 (Ch1013, Rel 0, 153.6kbps)

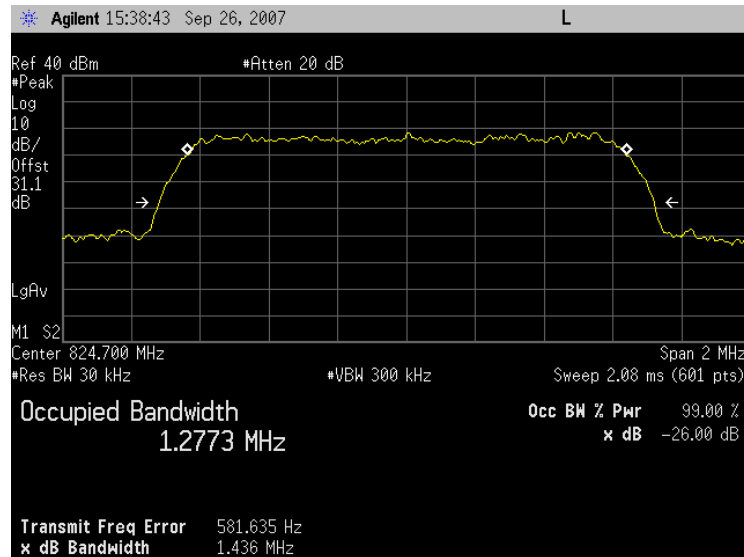

Plot 5.2 - 32 (Ch384, Rel 0, 153.6kbps)

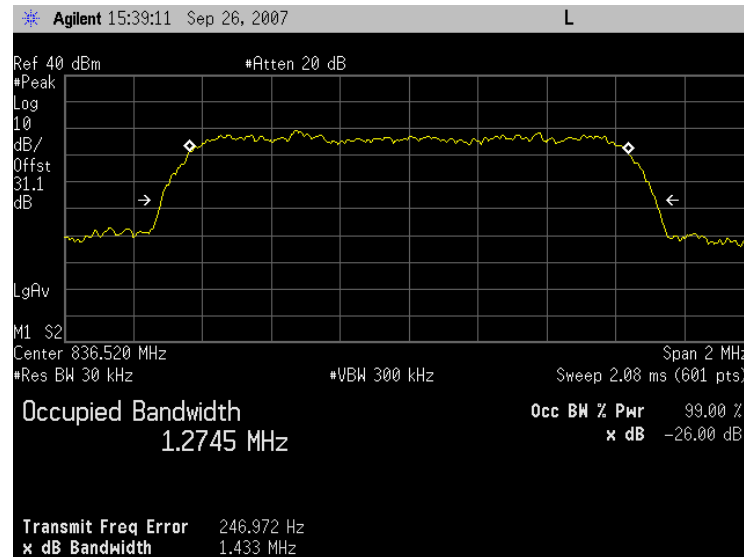

Plot 5.2 - 33 (Ch777, Rel 0, 153.6kbps)

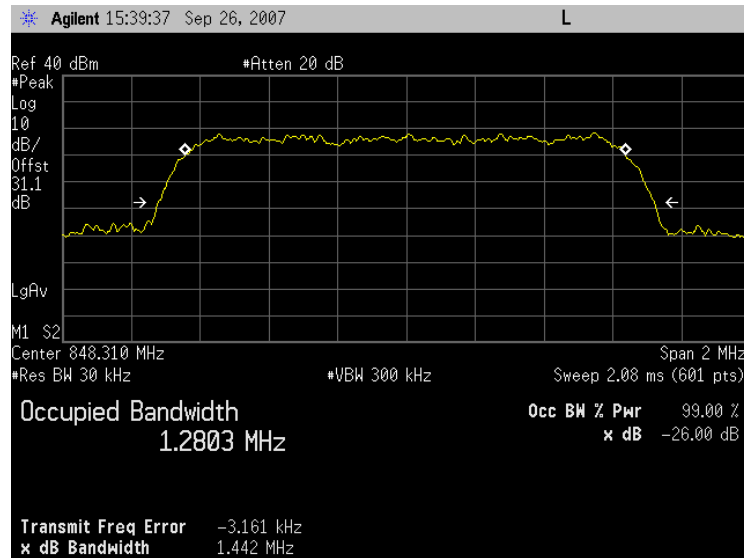

Plot 5.2 - 34 (Ch25, Rel 0, 153.6kbps)

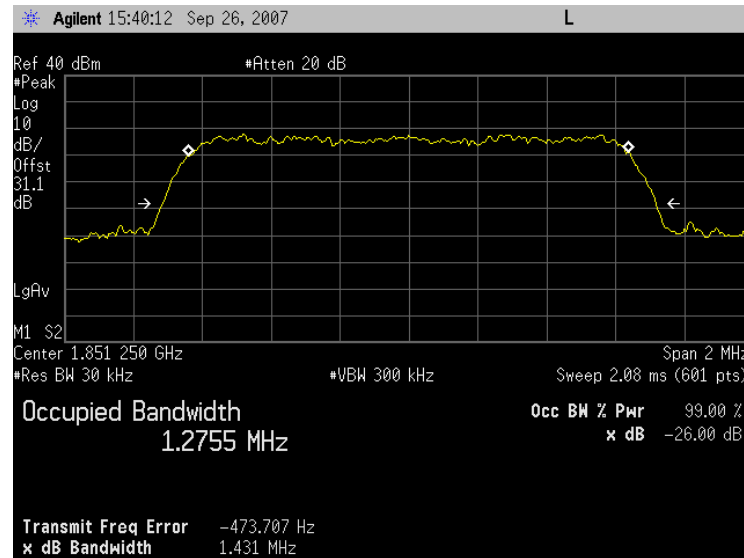

Plot 5.2 - 35 (Ch600, Rel 0, 153.6kbps)

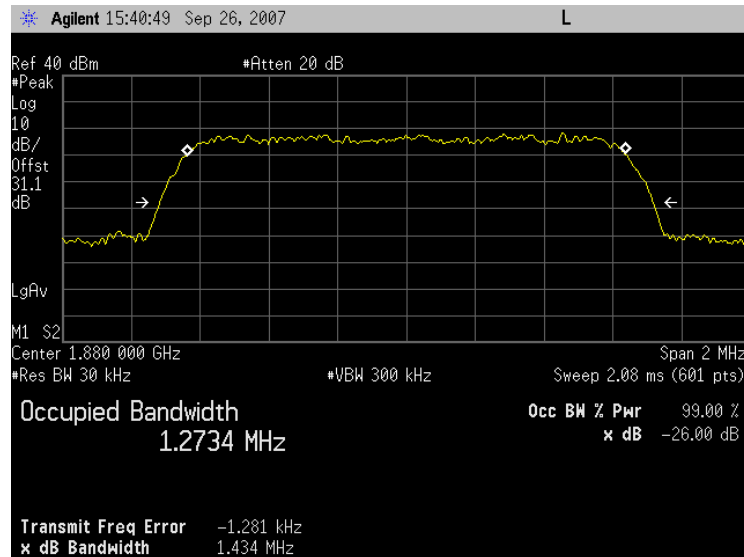

Plot 5.2 - 36 (Ch1175, Rel 0, 153.6kbps)

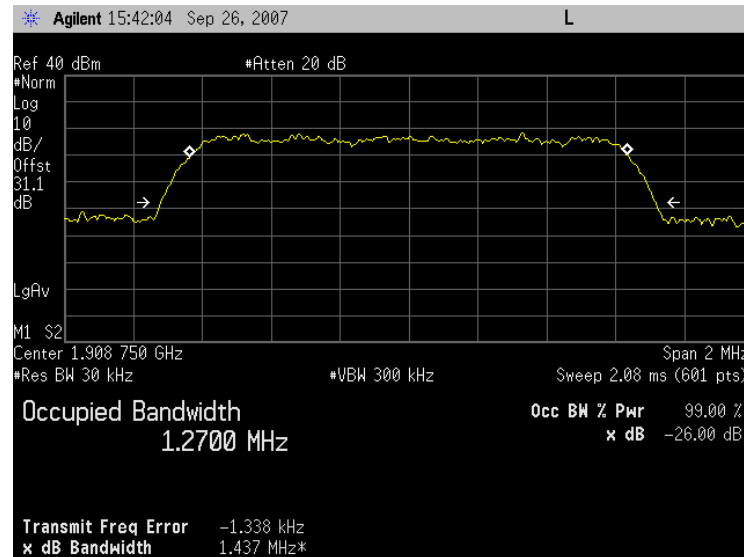

Plot 5.2 - 37 (Ch1013, Rel A, 4096 payload size)

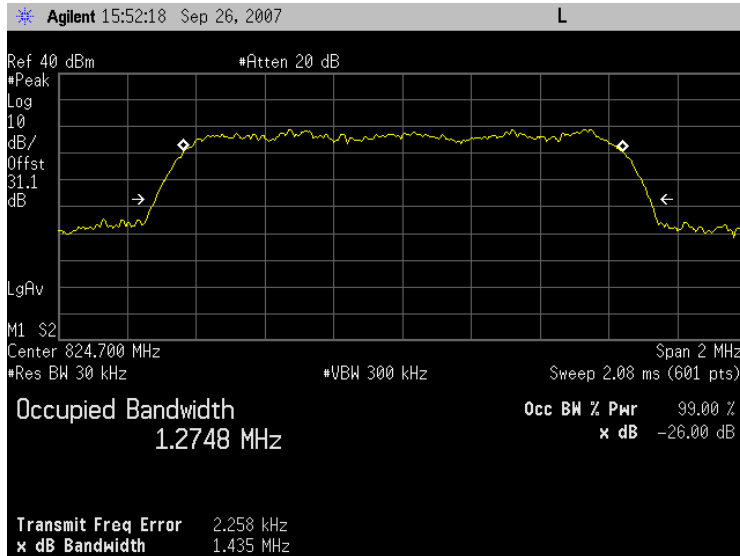

Plot 5.2 - 38 (Ch384, Rel A, 4096 payload size)

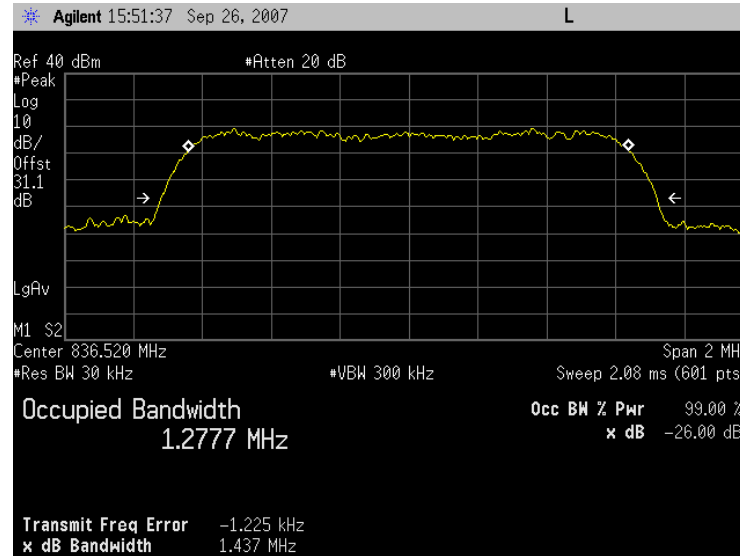

Plot 5.2 - 39 (Ch777, Rel A, 4096 payload size)

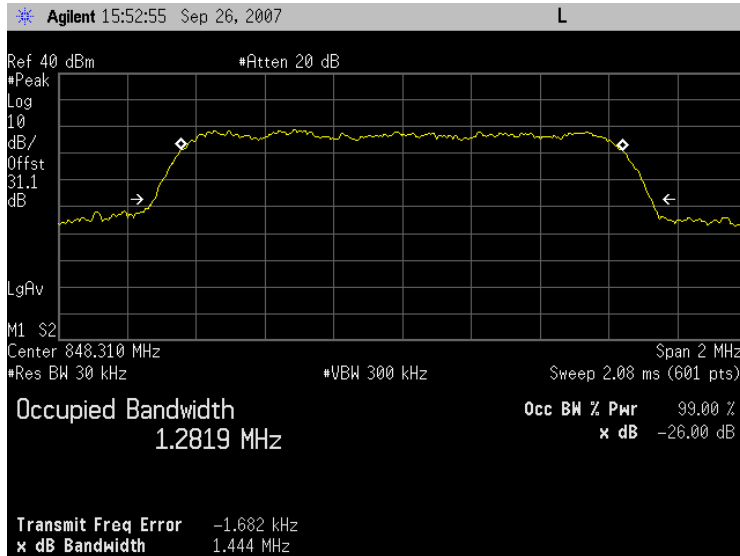

Plot 5.2 - 40 (Ch25, Rel A, 4096 payload size)

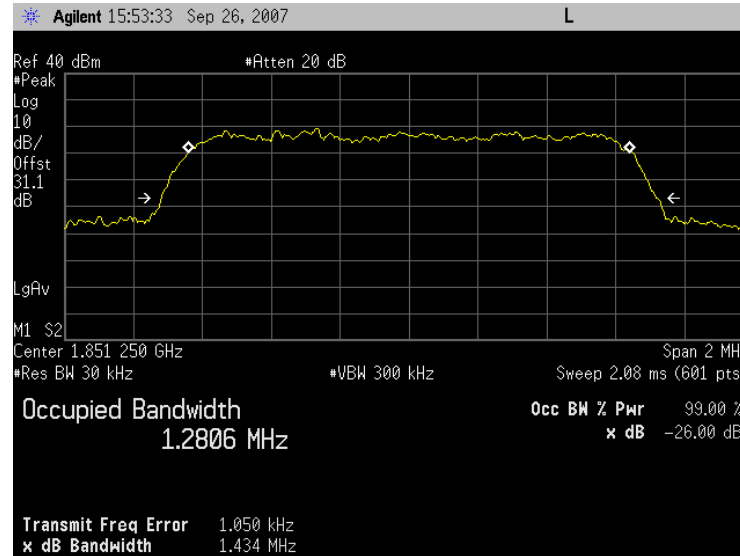

Plot 5.2 - 41 (Ch600, Rel A, 4096 payload size)

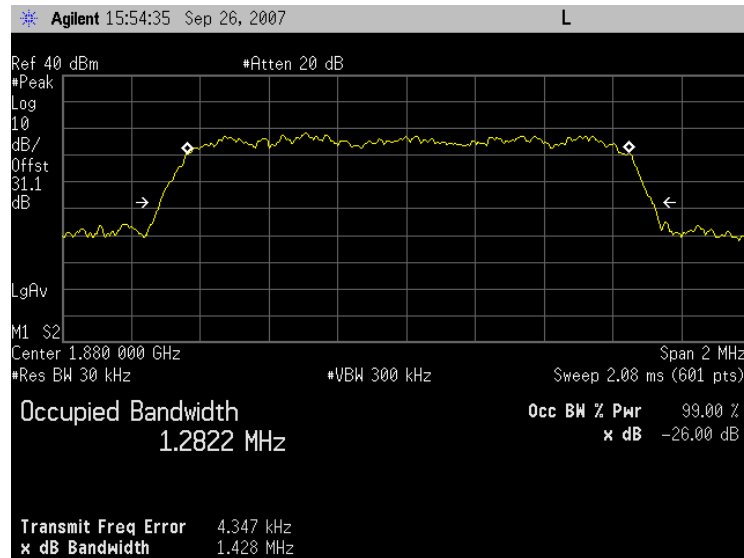

Plot 5.2 - 42 (Ch1175, Rel A, 4096 payload size)

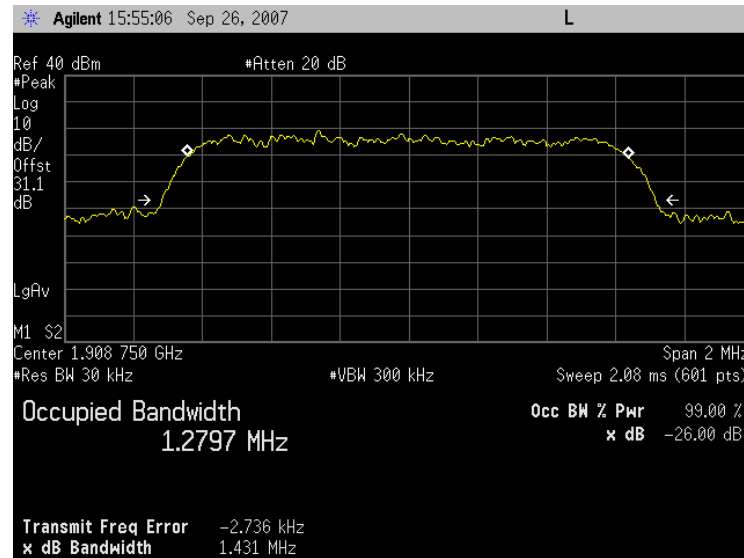

6. Block Edge Compliance

FCC:	§22.359, 24.238		
Limit:	-13dBm		
DUT SN	N10DGGVRD		
Modes Tested	CDMA 1x / 1x-EVDO	WCDMA/HSPA	GSM/GPRS/EDGE
	<ul style="list-style-type: none"> ▪ RC3 SO55 ▪ Rel 0, RTAP rate = 153.6kbps ▪ Rev A, RETAP payload = 4096 	<ul style="list-style-type: none"> ▪ Rel 99 ▪ Rel 6 HSUPA, Subtest 5 	<ul style="list-style-type: none"> ▪ GSM ▪ EDGE

6.1 Test Procedures

As shown in Figure below, connected the RF output to 8960 or 8820B, configured the UPDP-1 to operate at maximum power. Measured the block edge emissions at the required operating frequencies in each band on the spectrum analyzer.

For Each block edge measurement:

- Set the spectrum analyzer span to include the block edge frequency (824, 848, 1850, 1910MHz)
- Set a marker to point the corresponding block edge frequency in each test case
- Set display line at -13dBm
- Set resolution bandwidth to at least 1% of emission BW
- For CDMA/WCDMA measurement, set video averaging to 10 samples

Used 8960 call box for CDMA 1x/1x-EVDO measurement, and 8820B for UMTS testing.

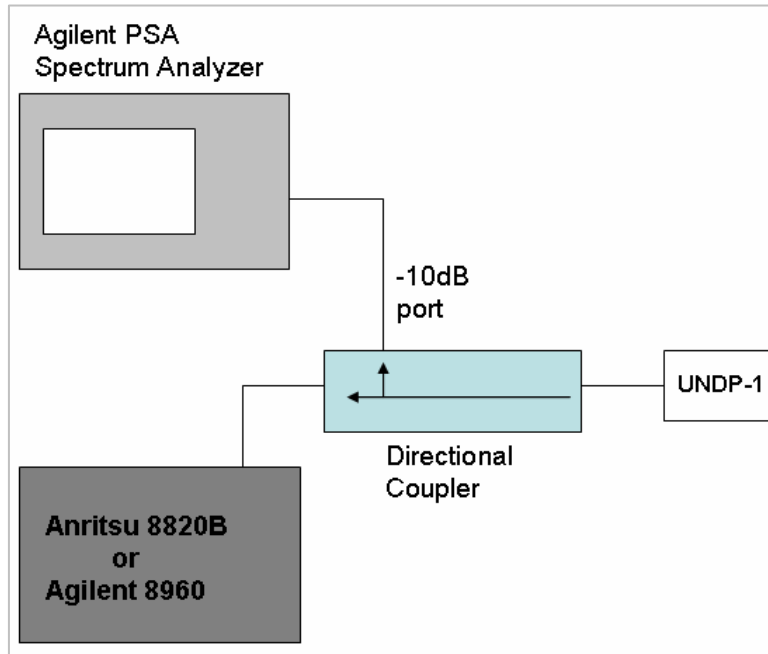

6.2 Test Results

The test was conducted at block edges in each band.

Mode		Frequency (MHz)	Channel Tested	Corresponding Plot number	Test Result
GSM/ GPRS/ EDGE	GMSK	824	128	Plot 6.2 - 1	Complies
		849	251	Plot 6.2 - 2	Complies
		1850	512	Plot 6.2 - 3	Complies
		1910	810	Plot 6.2 - 4	Complies
	8PSK	824	128	Plot 6.2 - 5	Complies
		849	251	Plot 6.2 - 6	Complies
		1850	512	Plot 6.2 - 7	Complies
		1910	810	Plot 6.2 - 8	Complies

Mode		Frequency (MHz)	Channel Tested	Corresponding Plot number	Test Result
WCDMA/ HSDPA/ HSUPA	Rel 99	824	4132	Plot 6.2 - 9	Complies
		849	4233	Plot 6.2 - 10	Complies
		1850	9262	Plot 6.2 - 11	Complies
		1910	9538	Plot 6.2 - 12	Complies
	HSUPA Rel 6 Subtest 5	824	4132	Plot 6.2 - 13	Complies
		849	4233	Plot 6.2 - 14	Complies
		1850	9262	Plot 6.2 - 15	Complies
		1910	9538	Plot 6.2 - 16	Complies

Mode		Frequency (MHz)	Channel Tested	Corresponding Plot number	Test Result
CDMA1x/ 1x-EVDO	RC3 SO55	824	1013	Plot 6.2 - 17	Complies
		849	777	Plot 6.2 - 18	Complies
		1850	25	Plot 6.2 - 19	Complies
		1910	1175	Plot 6.2 - 20	Complies
	Rel 0 RTAP rate = 153.6kbps	824	1013	Plot 6.2 - 21	Complies
		849	777	Plot 6.2 - 22	Complies
		1850	25	Plot 6.2 - 23	Complies
		1910	1175	Plot 6.2 - 24	Complies
	Rev A RETAP Payload size = 4096	824	1013	Plot 6.2 - 25	Complies
		849	777	Plot 6.2 - 26	Complies
		1850	25	Plot 6.2 - 27	Complies
		1910	1175	Plot 6.2 - 28	Complies

6.3 Plots

Plot 6.2 - 1 (Ch128, GSM850)

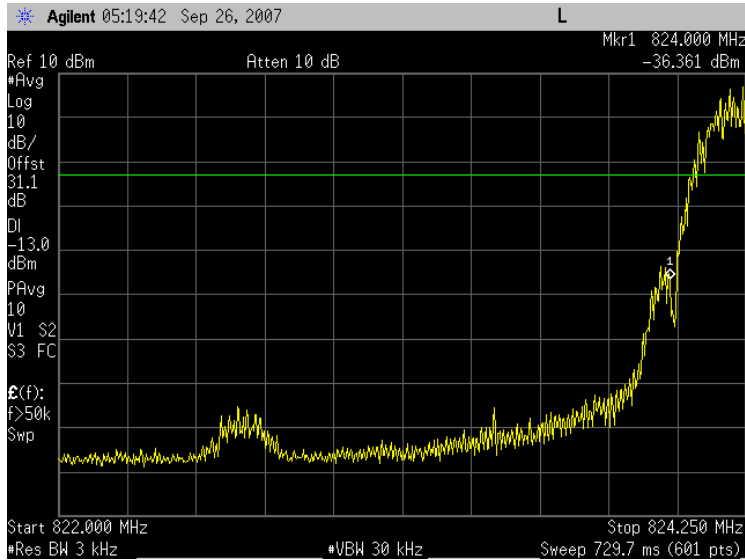

Plot 6.2 - 2 (Ch251, GSM850)

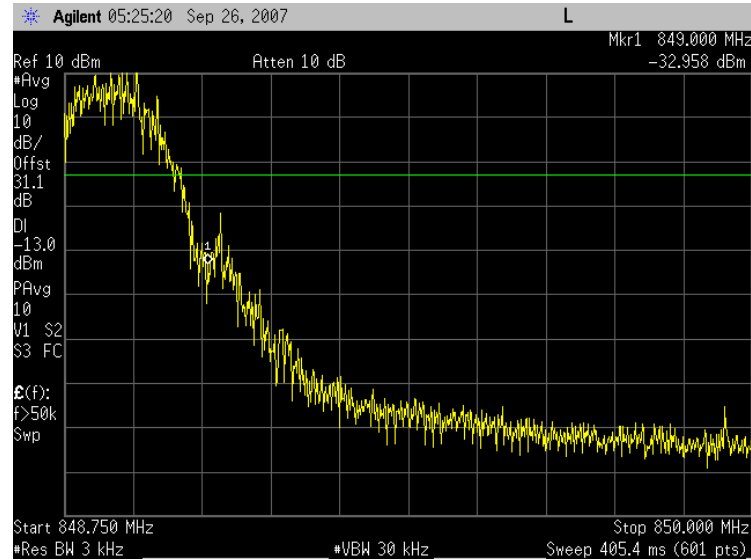

Plot 6.2 - 3 (Ch512, GSM1900)

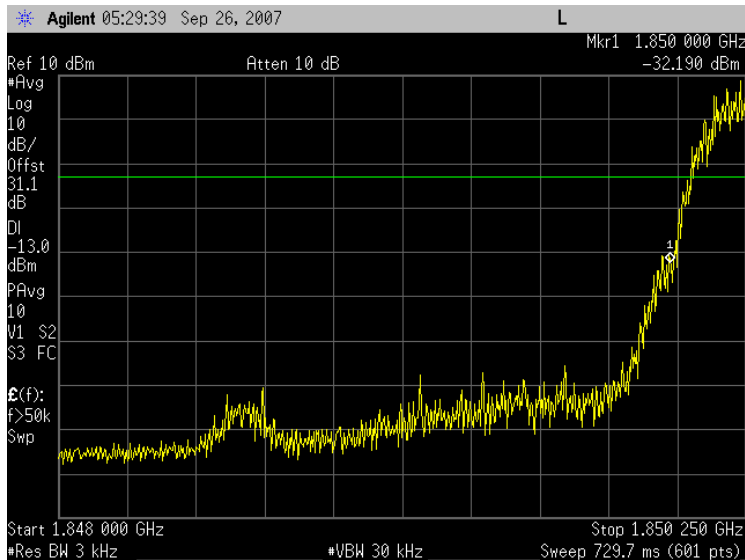

Plot 6.2 - 4 (Ch810, GSM1900)



Plot 6.2 - 5 (Ch128, EGPRS 850)

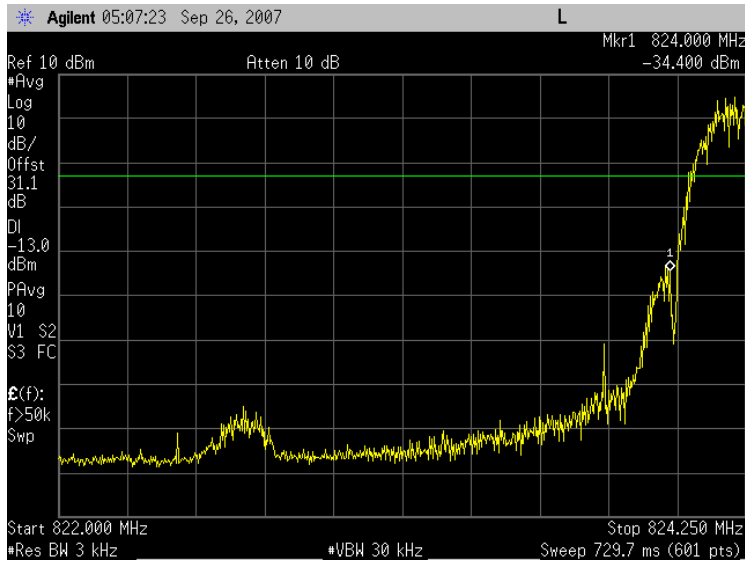

Plot 6.2 - 6 (Ch251, EGPRS 850)

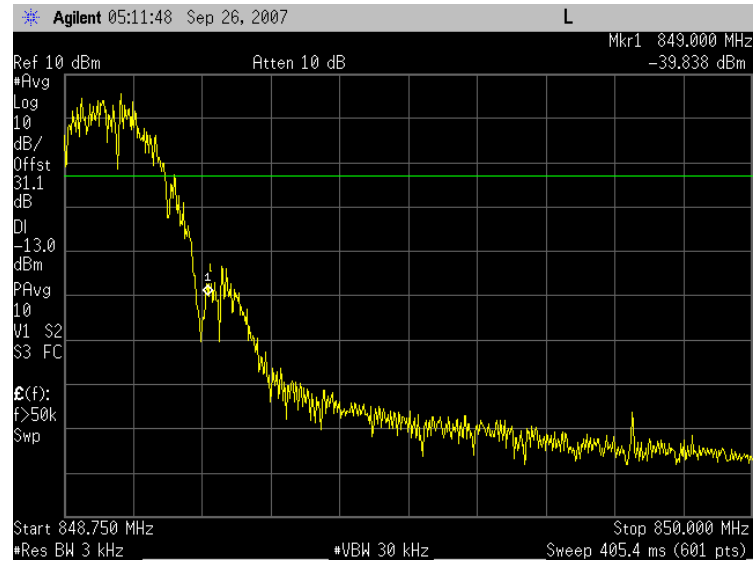

Plot 6.2 - 7 (Ch512, EGPRS 1900)

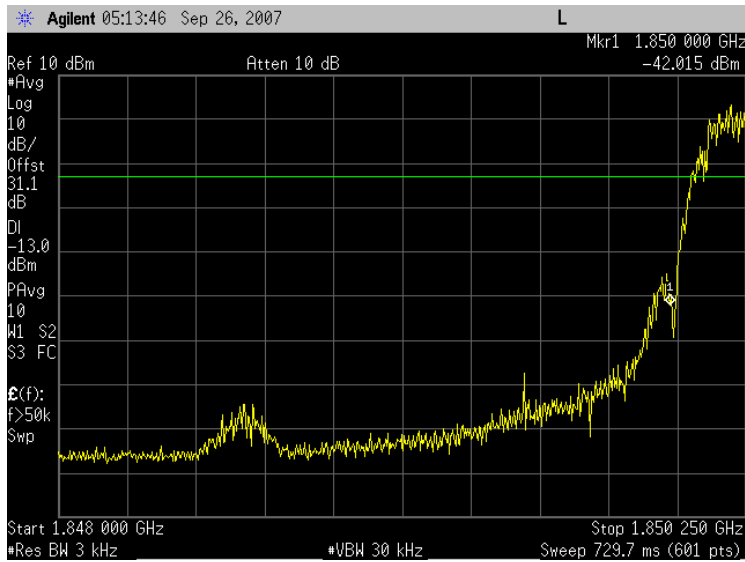

Plot 6.2 - 8 (Ch810, EGPRS 1900)

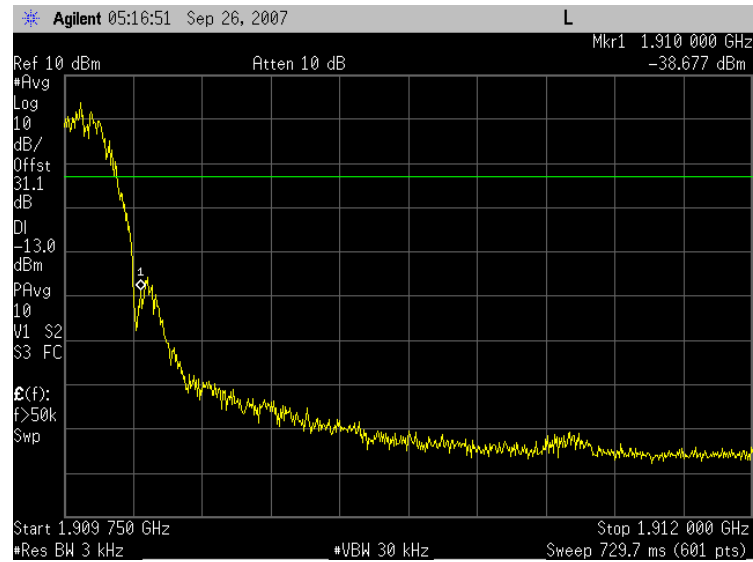

Plot 6.2 - 9 (Ch4132, WCDMA Rel 99)

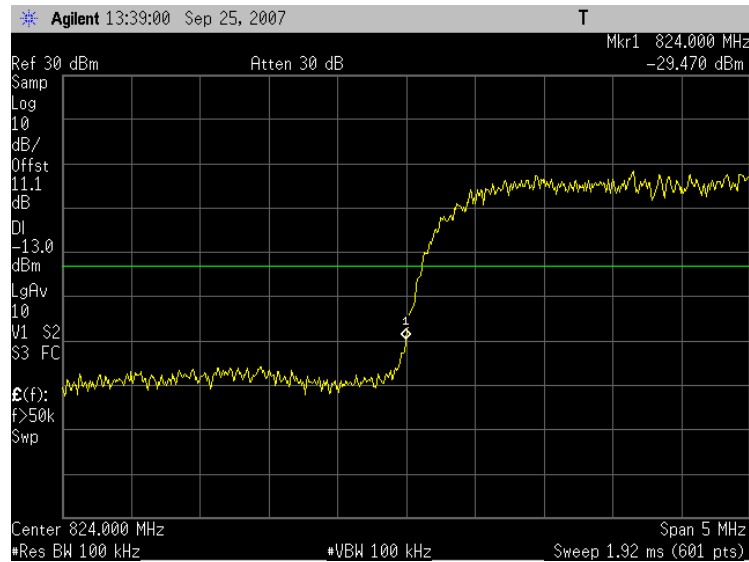

Plot 6.2 - 10 (Ch4233, WCDMA Rel 99)

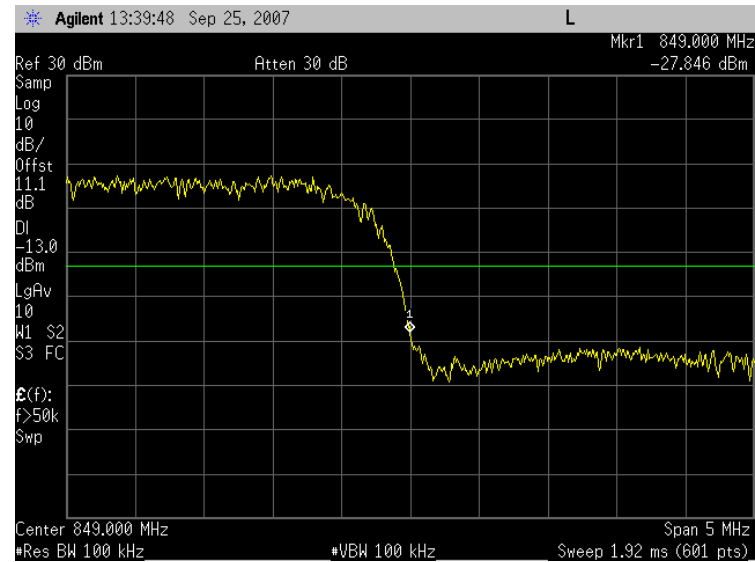

Plot 6.2 - 11 (Ch9262, WCDMA Rel 99)

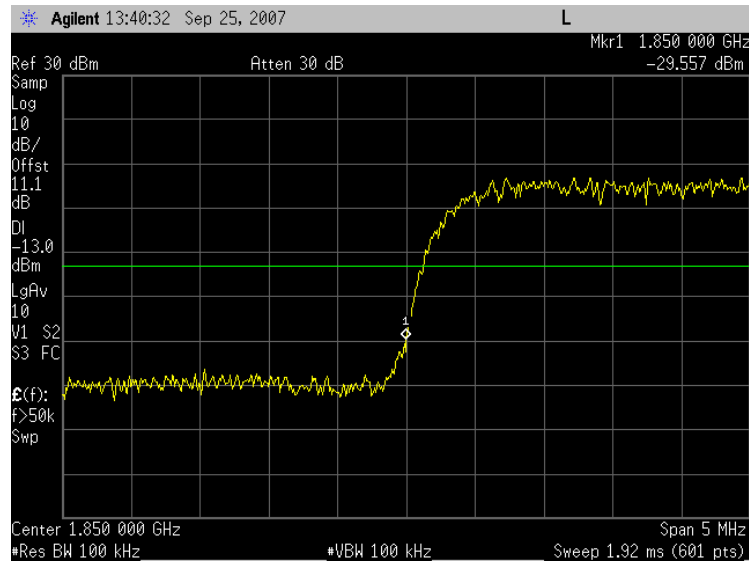

Plot 6.2 - 12 (Ch9538, WCDMA Rel 99)

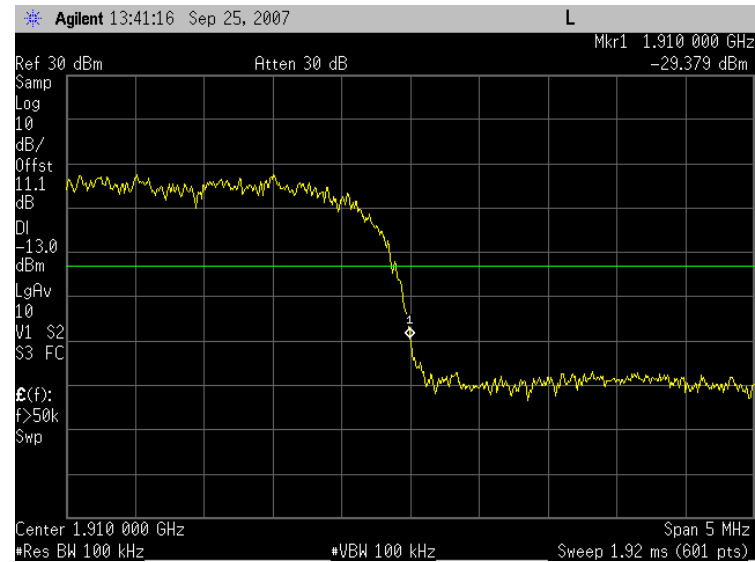

Plot 6.2 - 13 (Ch4132, HSUPA Subtest 5)

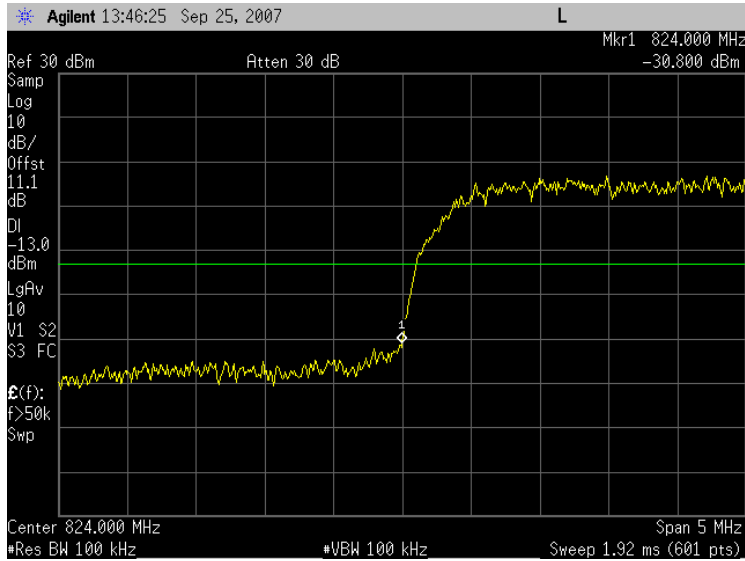

Plot 6.2 - 14 (Ch4233, HSUPA Subtest 5)

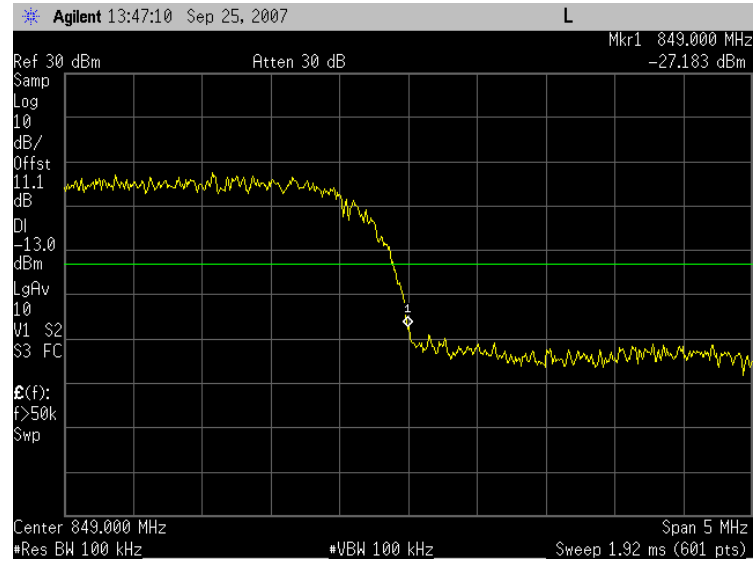

Plot 6.2 - 15 (Ch9262, HSUPA Subtest 5)

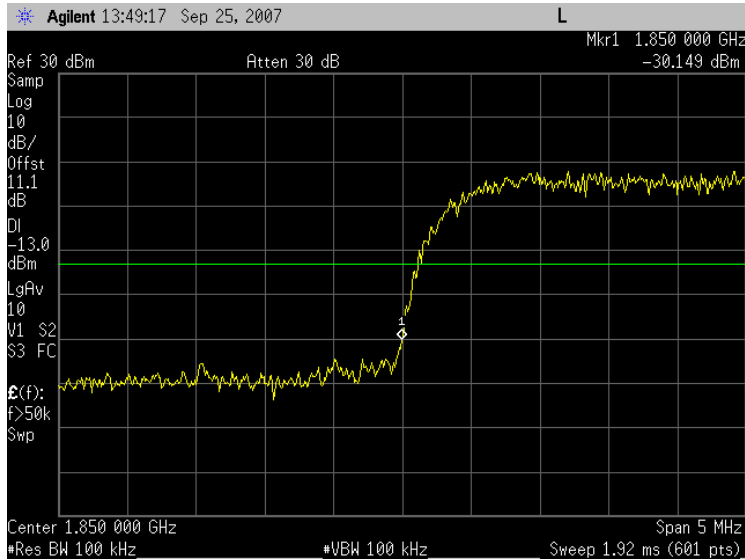

Plot 6.2 - 16 (Ch9538, HSUPA Subtest 5)

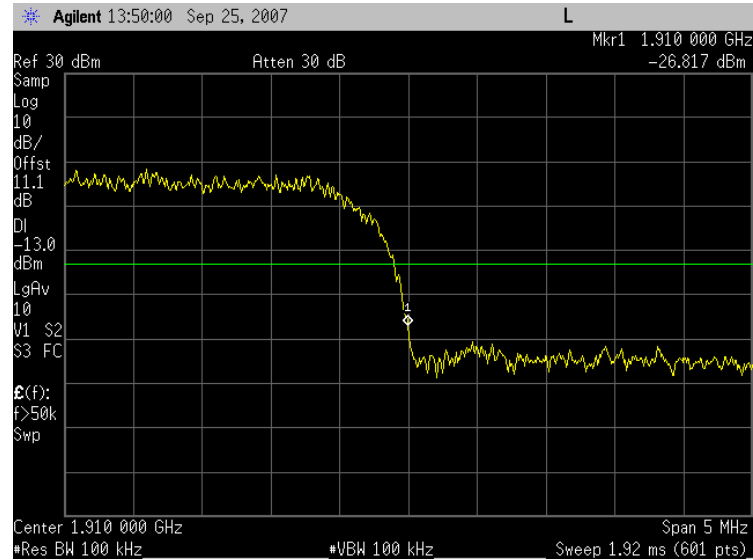

Plot 6.2 - 17 (Ch1013, 1x RC3 SO55)

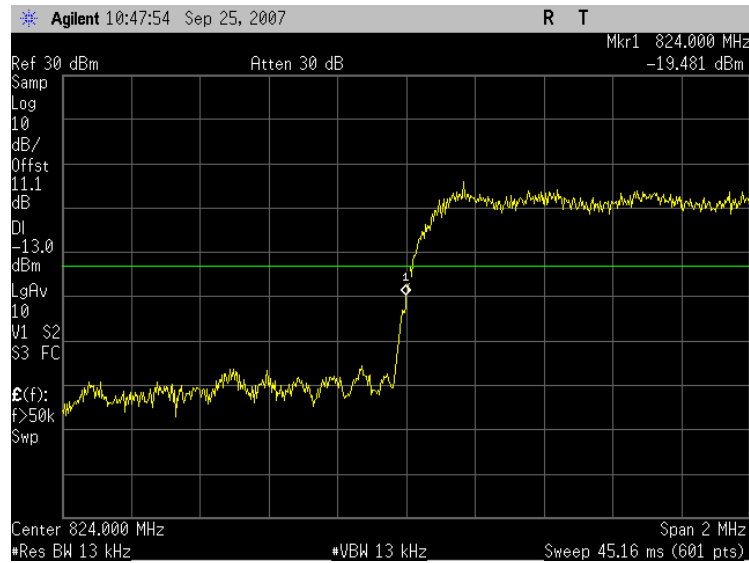

Plot 6.2 - 18 (Ch777, 1x RC3 SO55)

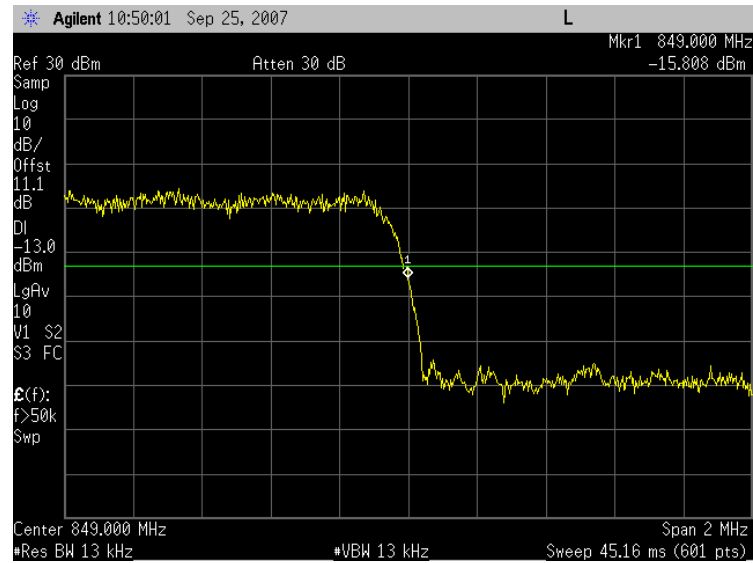

Plot 6.2 - 19 (Ch25, 1x RC3 SO55)



Plot 6.2 - 20 (Ch1175, 1x RC3 SO55)



Plot 6.2 - 21 (Ch1013, 1xEVDO Rel 0, 153.6kbps)

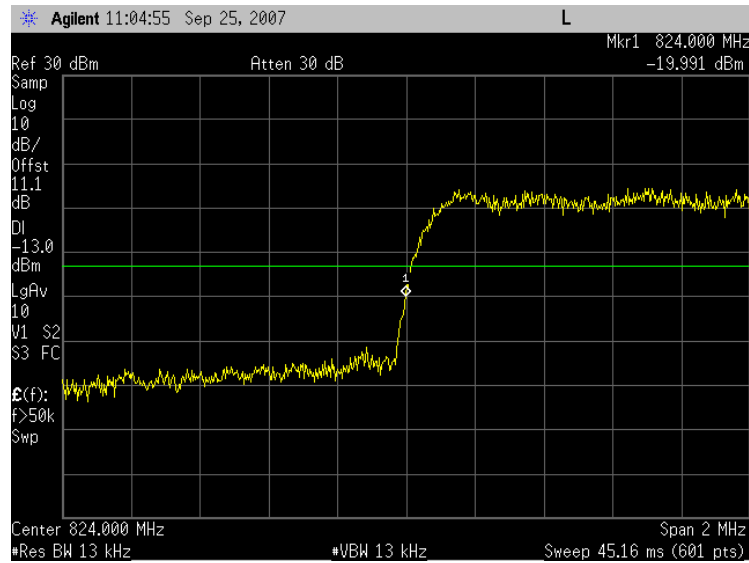

Plot 6.2 - 22 (Ch777, 1xEVDO Rel 0, 153.6kbps)

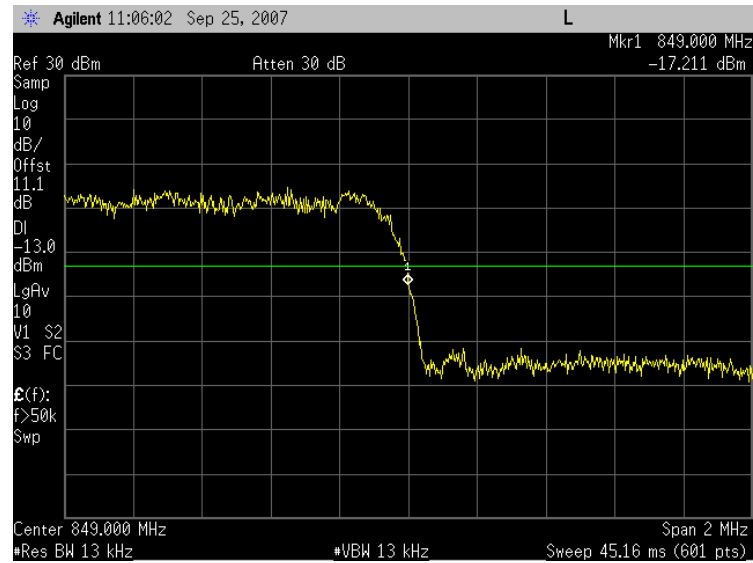

Plot 6.2 - 23 (Ch25, 1xEVDO Rel 0, 153.6kbps)



Plot 6.2 - 24 (Ch1175, 1xEVDO Rel 0, 153.6kbps)



Plot 6.2 - 25 (Ch1013, 1xEVDO Rev A, 4096 payload)

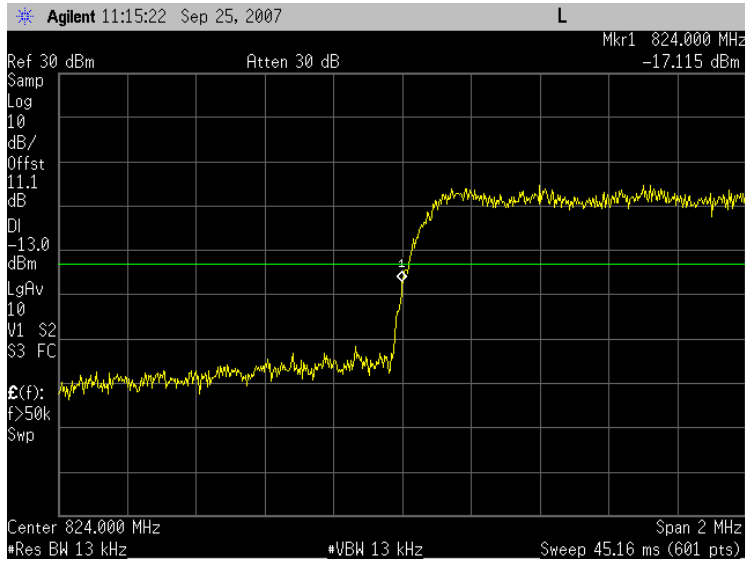

Plot 6.2 - 26 (Ch777, 1xEVDO Rev A, 4096 payload)

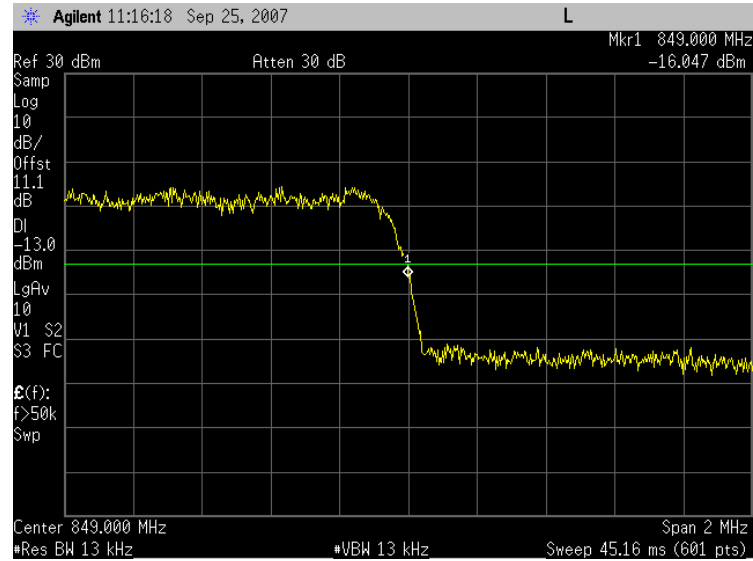

Plot 6.2 - 27 (Ch25, 1xEVDO Rev A, 4096 payload)

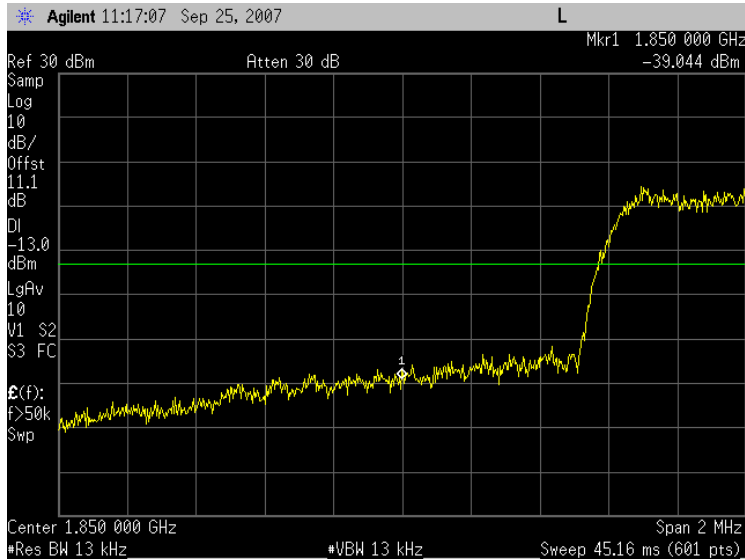

Plot 6.2 - 28 (Ch1175, 1xEVDO Rev A, 4096 payload)



7. Out of Band Emission at Antenna Terminals

FCC:	§22.901(d), 22.917, 24.238 (a)		
Limit:	-13dBm		
DUT SN	N10DGGVRD		
Modes Tested	CDMA 1x / 1x-EVDO	WCDMA/HSPA	GSM/GPRS/EDGE
	▪ Rel 0, RTAP rate = 153.6kbps	▪ Rel 99	▪ GSM ▪ EDGE

7.1 Test Procedure

As Figure below indicates, connected the RF output to the spectrum analyzer through a calibrated coaxial cable. Scan the out-of-band emission up to 10th harmonics. Set RBW and VBW as 100kHz for the measurement below 1GHz, and 1MHz for testing above 1GHz. Recorded multiple sweeps in maximum hold mode using a peak detector to ensure that the worst case emission was caught.

Used 8960 call box for CDMA 1x/1x-EVDO measurement, and 8820B for UMTS testing.

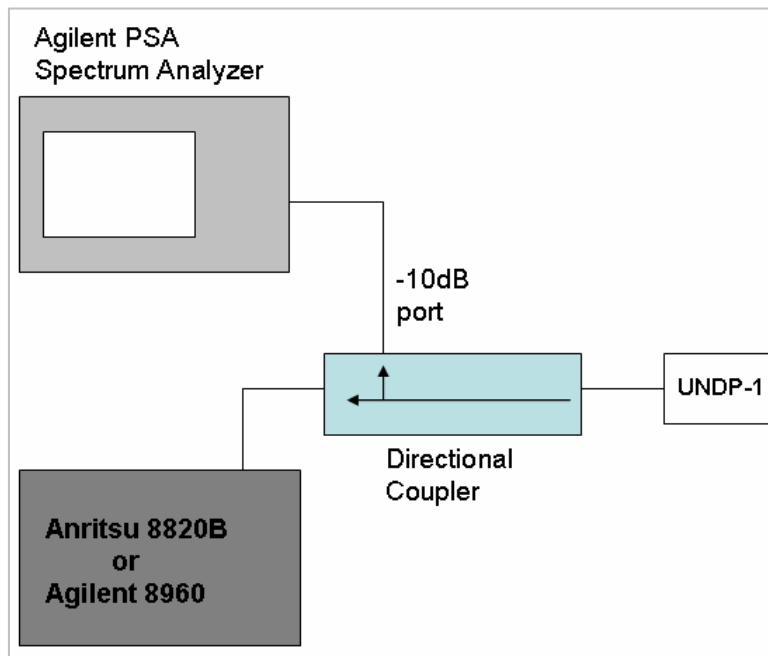

7.2 Test Result

The test was conducted at low, mid and high channel in each band.

Mode		Frequency Range Tested	Tx Channel	Corresponding Plot number	Test Result
GSM/ GPRS/ EDGE	GMSK	0 ~ 20 GHz	128	Plot 7.2 - 1, 2	Complies
		0 ~ 20 GHz	190	Plot 7.2 - 3, 4	Complies
		0 ~ 20 GHz	251	Plot 7.2 - 5, 6	Complies
		0 ~ 20 GHz	512	Plot 7.2 - 7, 8	Complies
		0 ~ 20 GHz	661	Plot 7.2 - 9, 10	Complies
		0 ~ 20 GHz	810	Plot 7.2 - 11, 12	Complies
	8PSK	0 ~ 20 GHz	128	Plot 7.2 - 13, 14	Complies
		0 ~ 20 GHz	190	Plot 7.2 - 15, 16	Complies
		0 ~ 20 GHz	251	Plot 7.2 - 17, 18	Complies
		0 ~ 20 GHz	512	Plot 7.2 - 19, 20	Complies
		0 ~ 20 GHz	661	Plot 7.2 - 21, 22	Complies
		0 ~ 20 GHz	810	Plot 7.2 - 23, 24	Complies

Mode		Frequency Range Tested	Tx Channel	Corresponding Plot number	Test Result
WCDMA/ HSDPA/ HSUPA	Rel 99	0 ~ 20 GHz	4132	Plot 7.2 - 25, 26	Complies
		0 ~ 20 GHz	4182	Plot 7.2 - 27, 28	Complies
		0 ~ 20 GHz	4233	Plot 7.2 - 29, 30	Complies
		0 ~ 20 GHz	9262	Plot 7.2 - 31, 32	Complies
		0 ~ 20 GHz	9400	Plot 7.2 - 33, 34	Complies
		0 ~ 20 GHz	9538	Plot 7.2 - 35, 36	Complies

Mode		Frequency (MHz)	Channel Tested	Corresponding Plot number	Test Result
CDMA1x/ 1x-EVDO	Rel 0 RTAP rate = 153.6kbps	0 ~ 20 GHz	1013	Plot 7.2 - 37, 38	Complies
		0 ~ 20 GHz	384	Plot 7.2 - 39, 40	Complies
		0 ~ 20 GHz	777	Plot 7.2 - 41, 42	Complies
		0 ~ 20 GHz	25	Plot 7.2 - 43, 44	Complies
		0 ~ 20 GHz	600	Plot 7.2 - 45, 46	Complies
		0 ~ 20 GHz	1175	Plot 7.2 - 47, 36	Complies

7.3 Plots

Plot 7.2 - 1 (GSM Ch128)

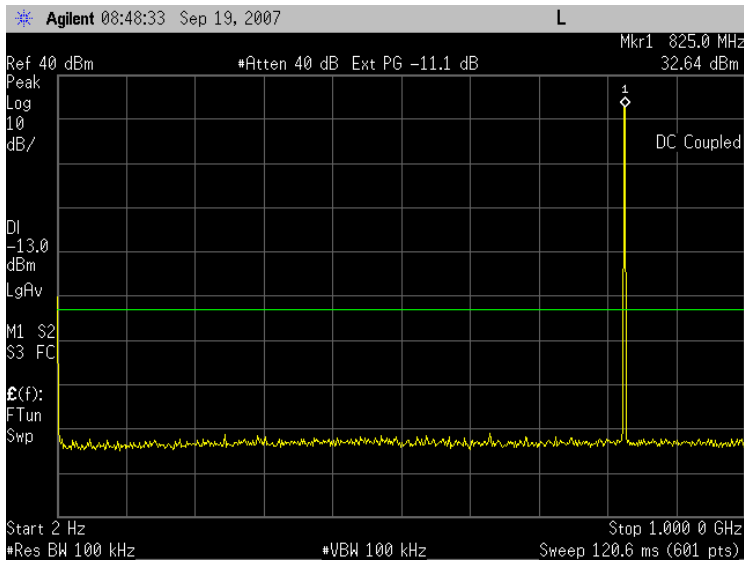

Plot 7.2 - 2 (GSM Ch128)

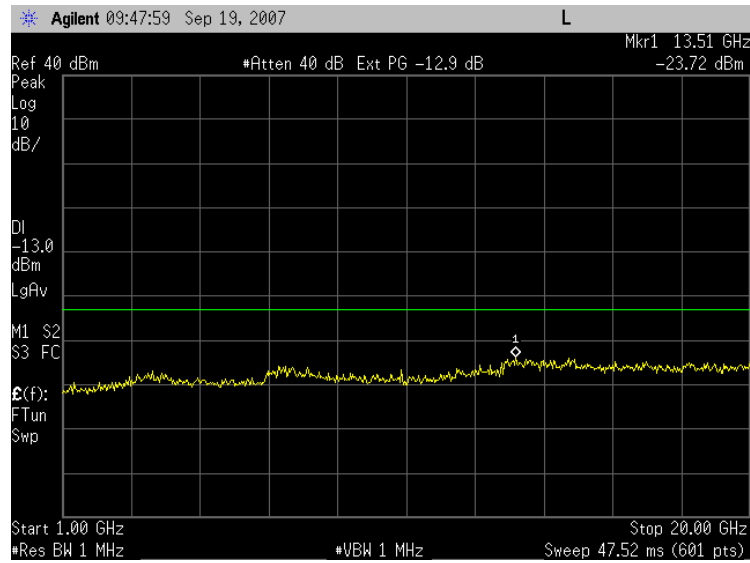

Plot 7.2 - 3 (GSM Ch190)

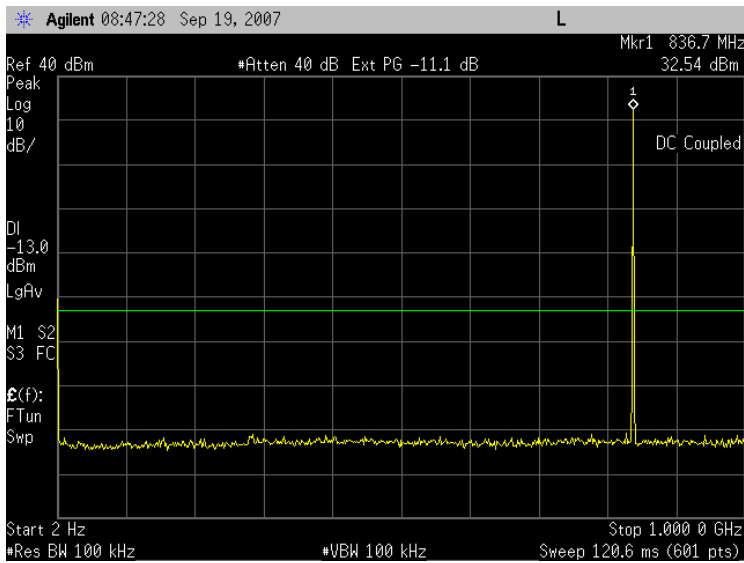

Plot 7.2 - 4 (GSM Ch190)

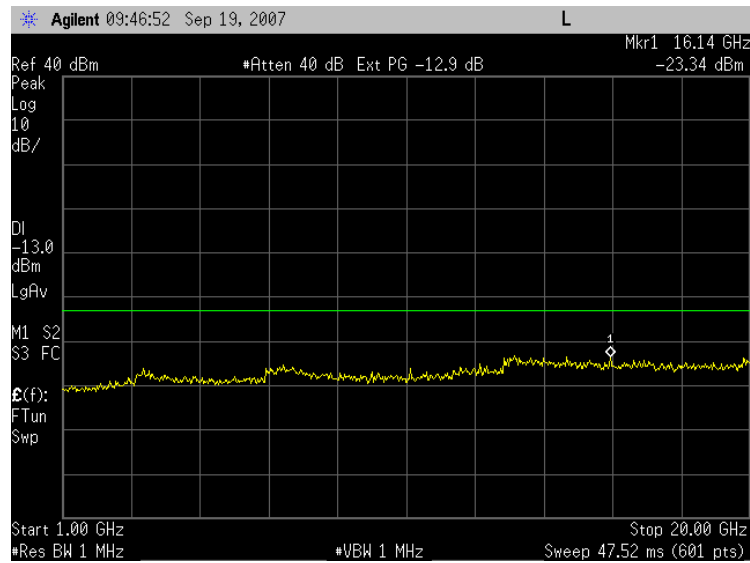

Plot 7.2 - 5 (GSM Ch251)

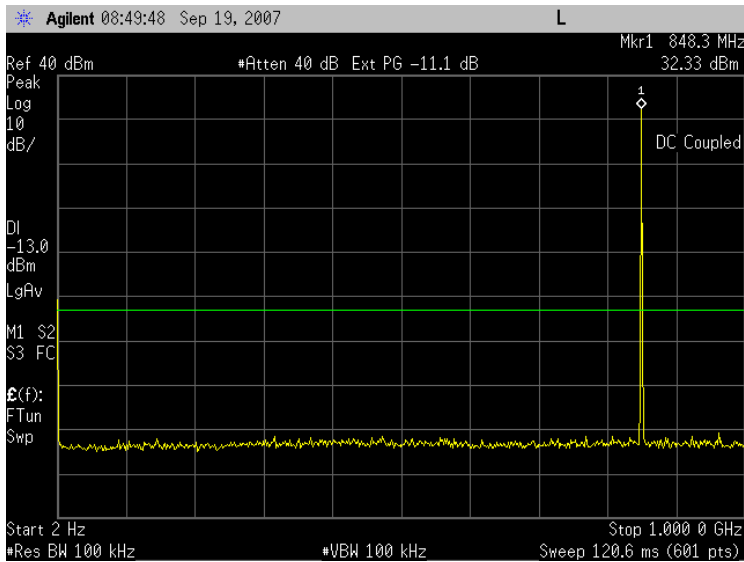

Plot 7.2 - 6 (GSM Ch251)

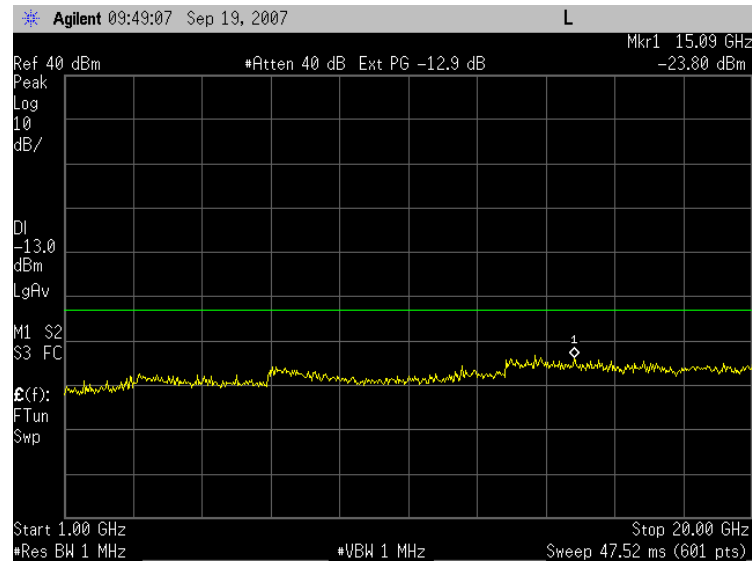

Plot 7.2 - 7 (GSM Ch512)

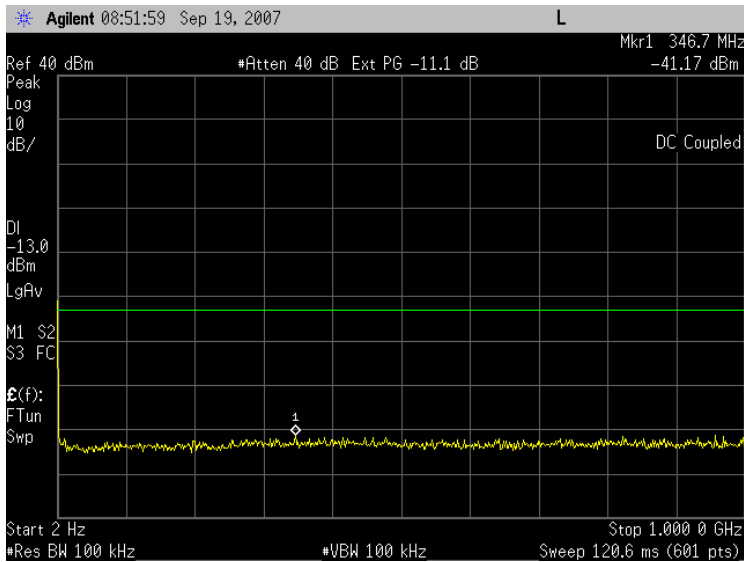

Plot 7.2 - 8 (GSM Ch512)

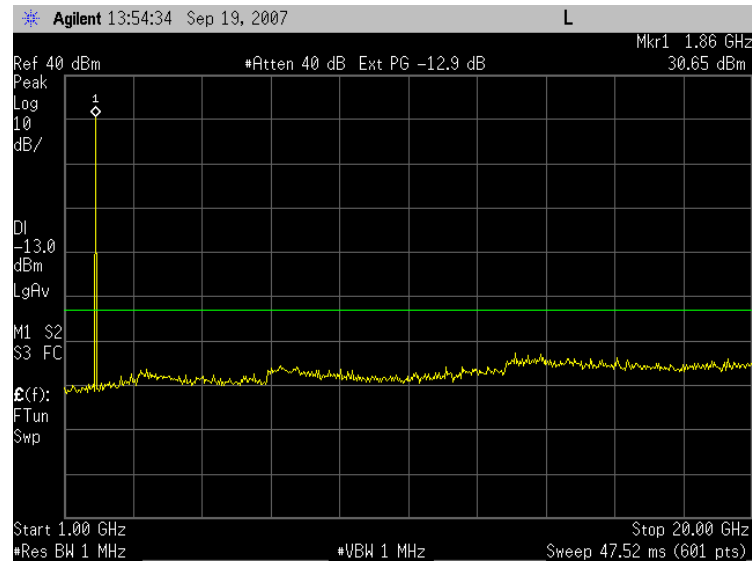

Plot 7.2 - 9 (GSM Ch661)

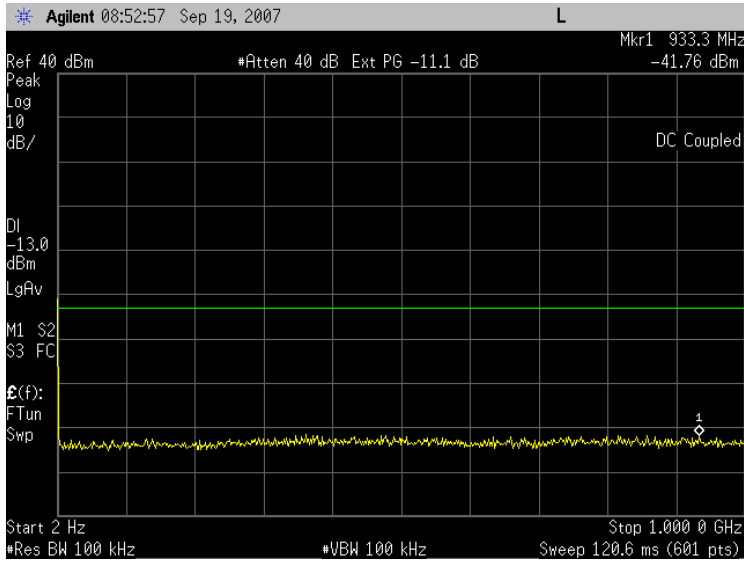

Plot 7.2 - 10 (GSM Ch661)

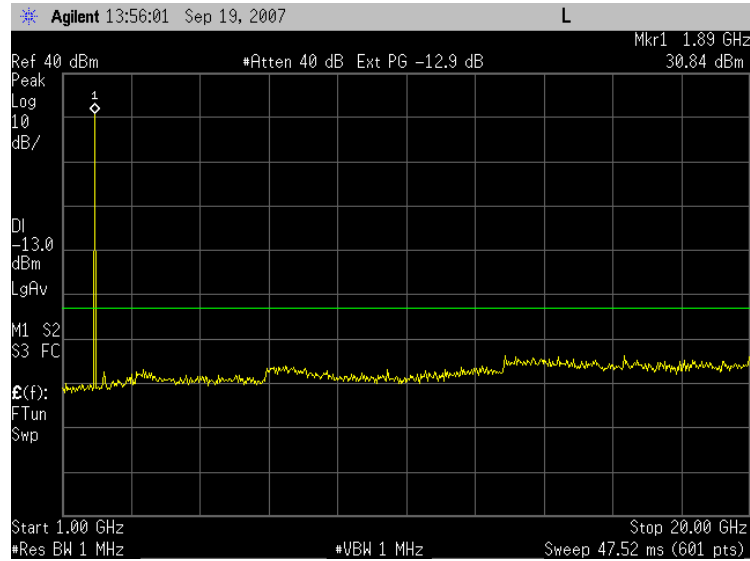

Plot 7.2 - 11 (GSM Ch810)

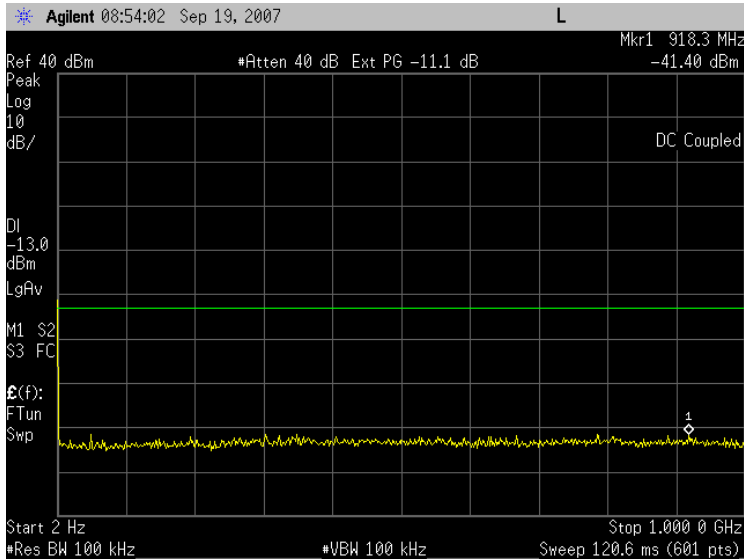

Plot 7.2 - 12 (GSM Ch810)

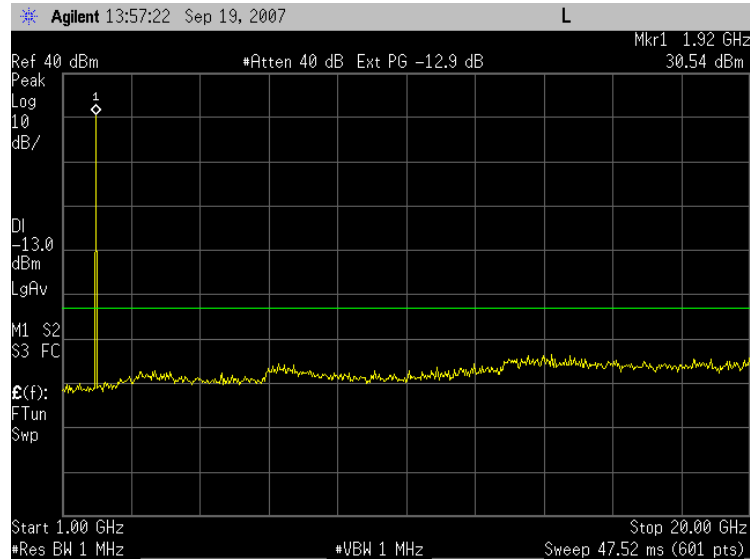

Plot 7.2 - 13 (EGPRS Ch128)

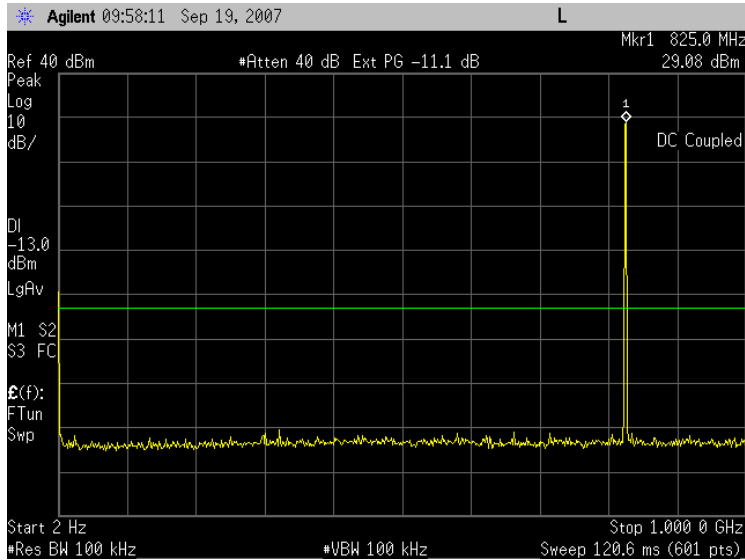

Plot 7.2 - 14 (EGPRS Ch128)

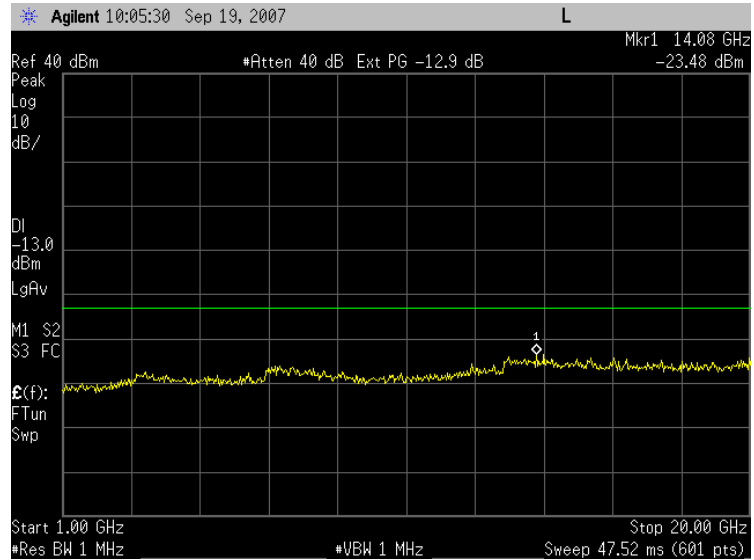

Plot 7.2 - 15 (EGPRS Ch190)

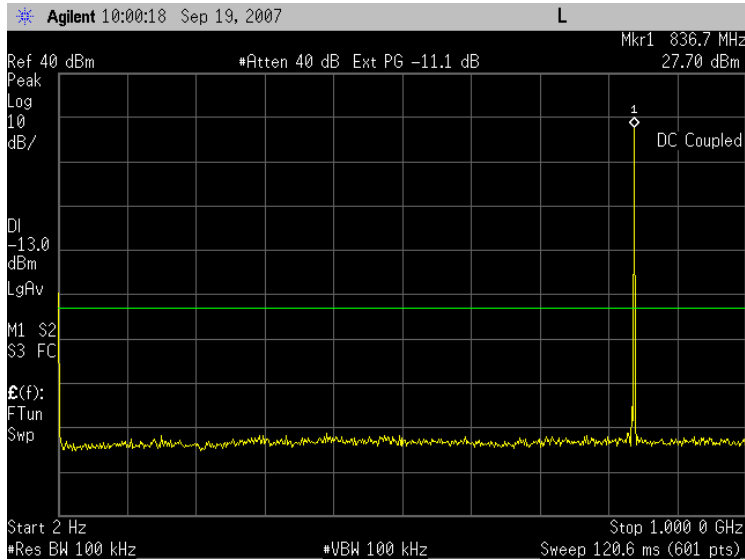

Plot 7.2 - 16 (EGPRS Ch190)

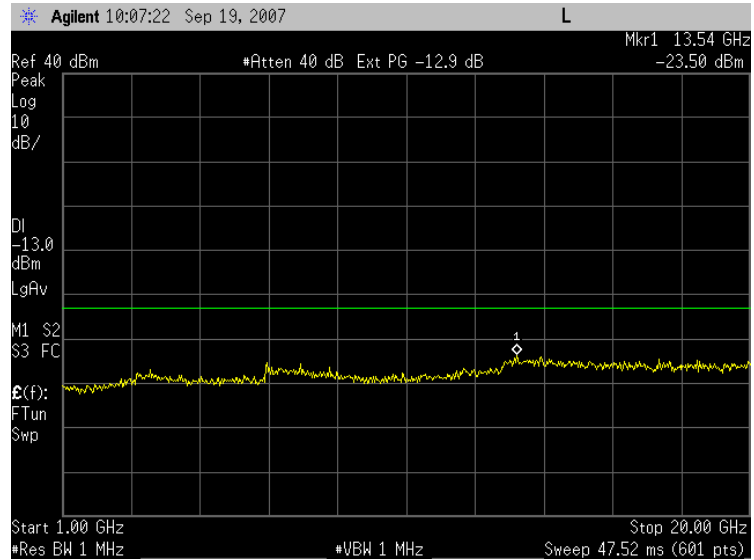

Plot 7.2 - 17 (EGPRS Ch251)

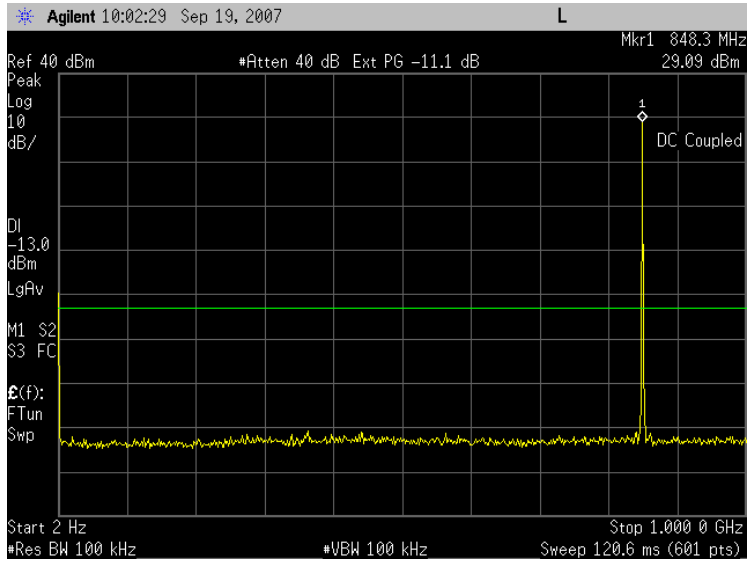

Plot 7.2 - 18 (EGPRS Ch251)

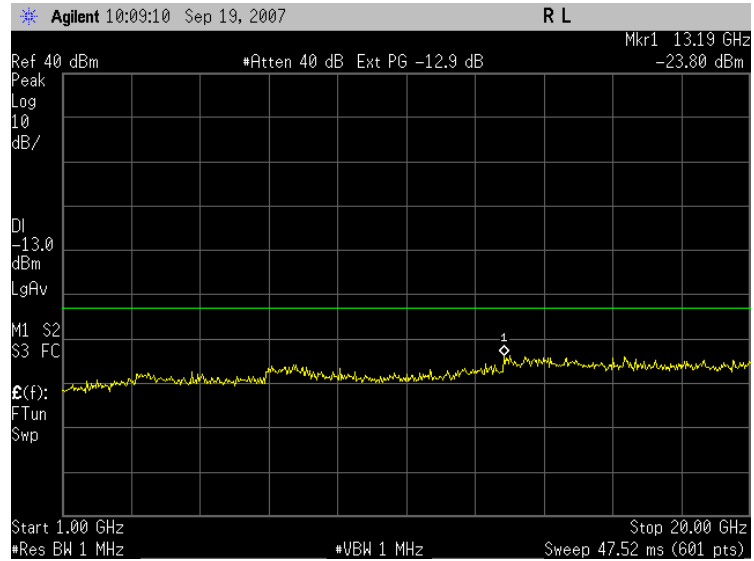

Plot 7.2 - 19 (EGPRS Ch512)

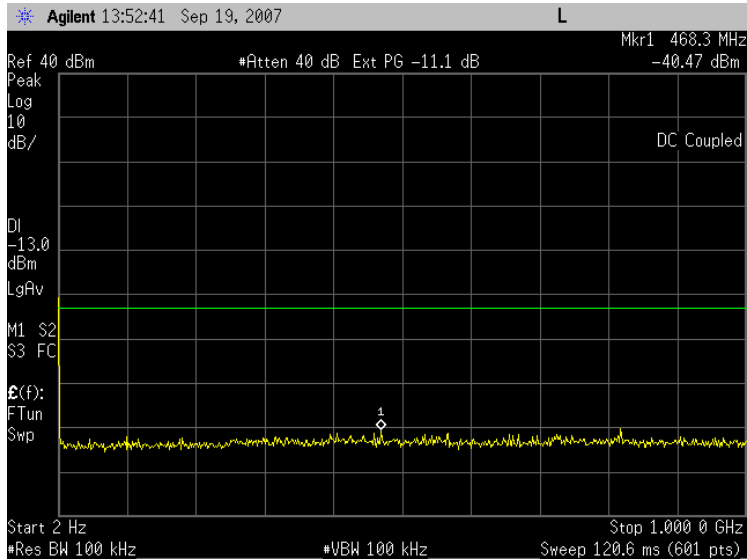

Plot 7.2 - 20 (EGPRS Ch512)

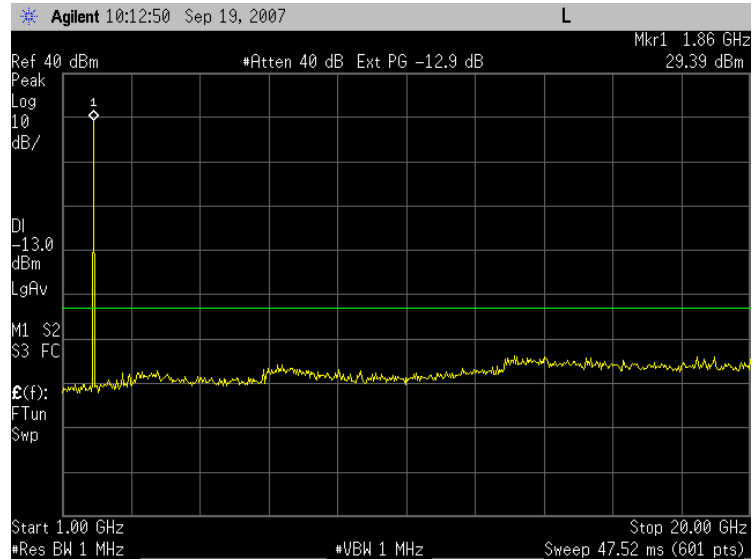

Plot 7.2 - 21 (EGPRS Ch661)

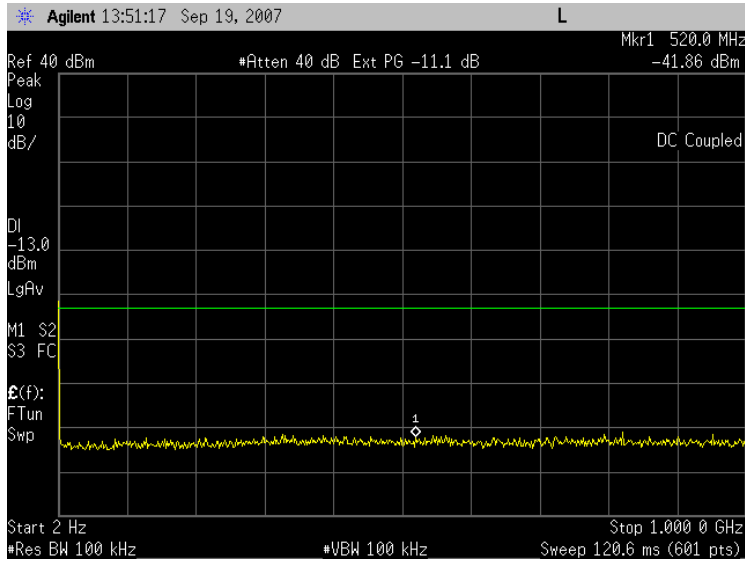

Plot 7.2 - 22 (EGPRS Ch661)

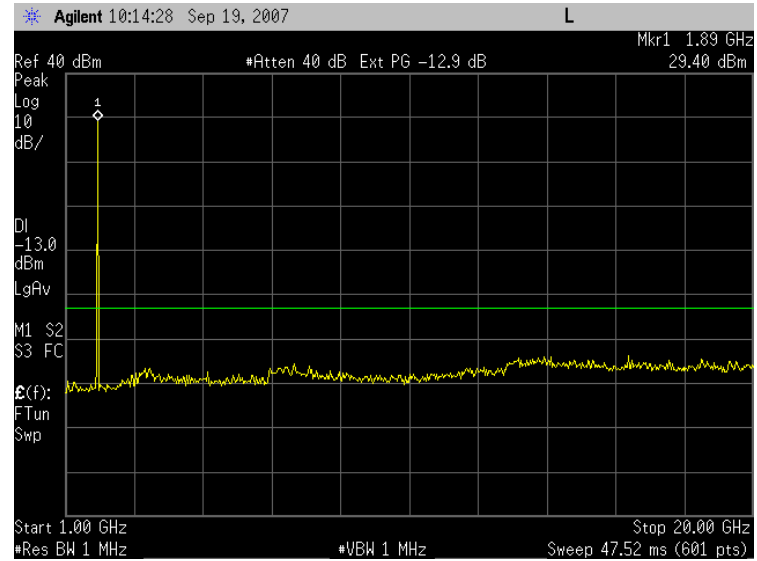

Plot 7.2 - 23 (EGPRS Ch810)

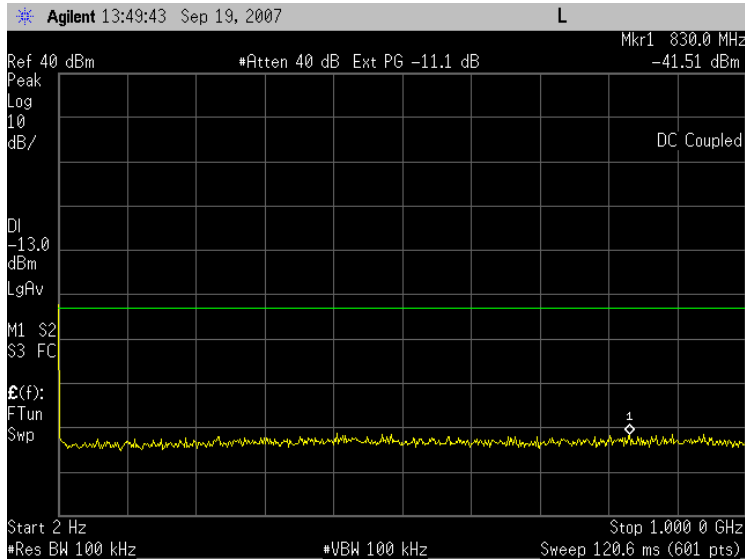

Plot 7.2 - 24 (EGPRS Ch810)

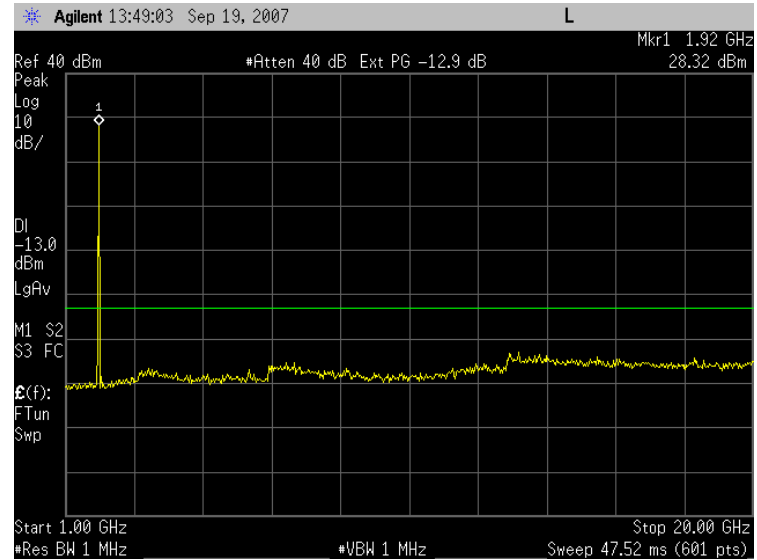

Plot 7.2 - 25 (WCDMA, Rel99, Ch4132)

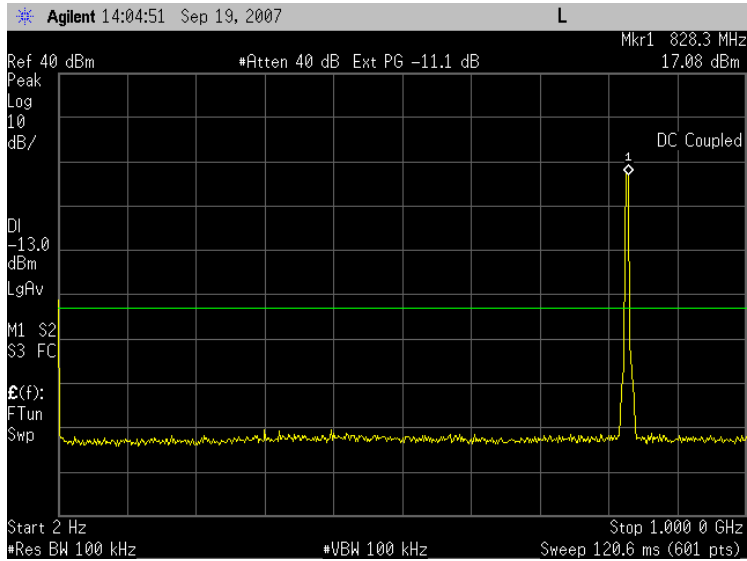

Plot 7.2 - 26 (WCDMA, Rel99, Ch4132)

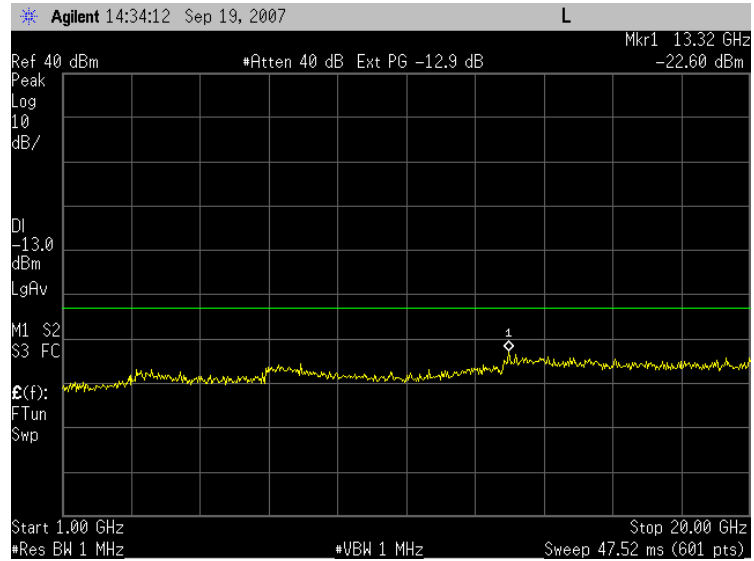

Plot 7.2 - 27 (WCDMA, Rel99, Ch4182)

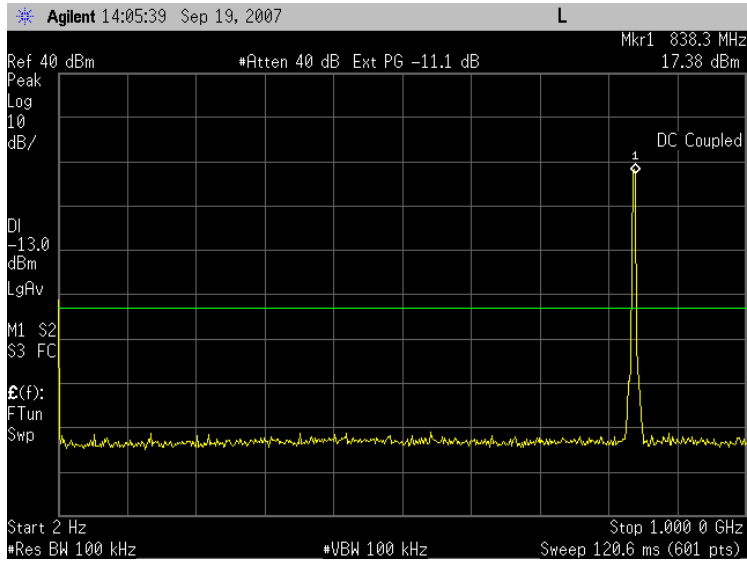

Plot 7.2 - 28 (WCDMA, Rel99, Ch4182)

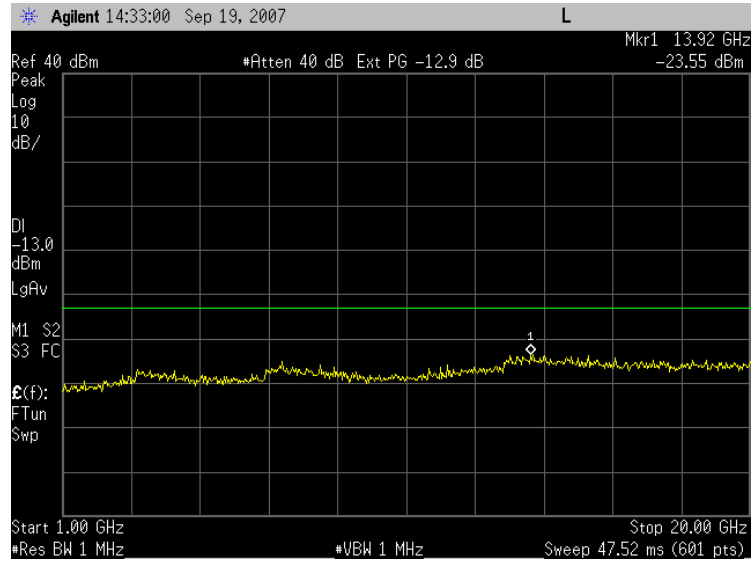

Plot 7.2 - 29(WCDMA, Rel99, Ch4233)

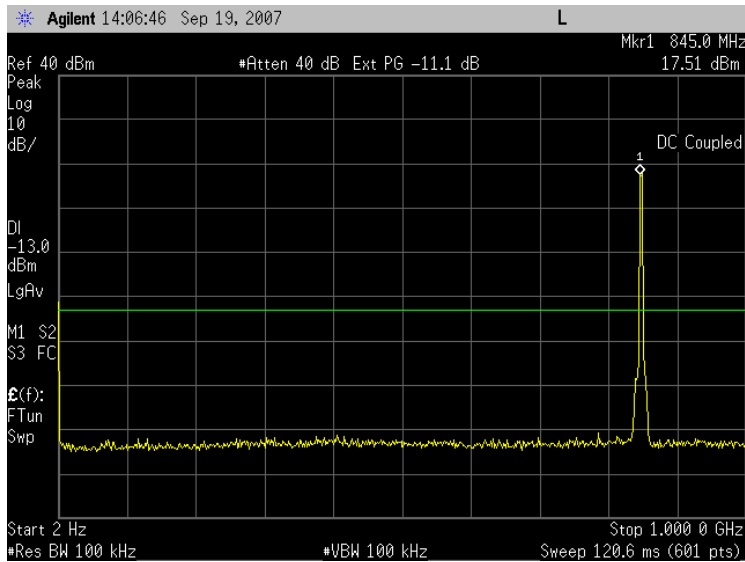

Plot 7.2 - 30 (WCDMA, Rel99, Ch4233)

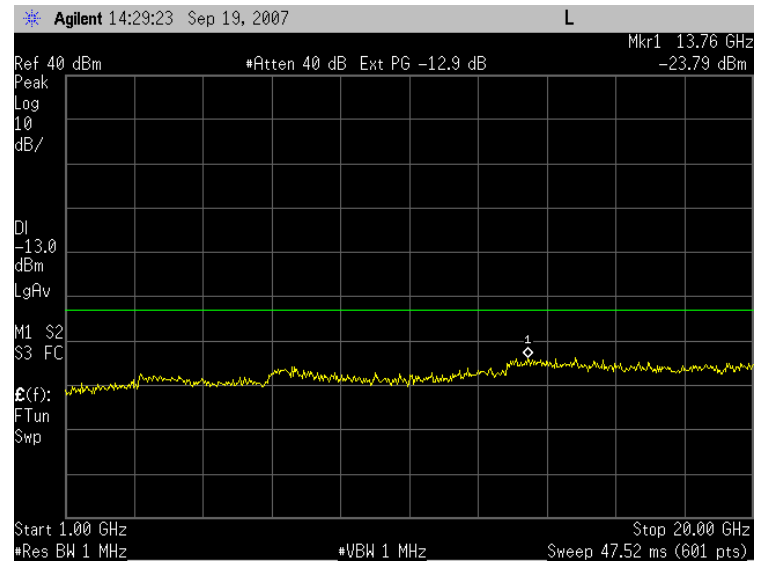

Plot 7.2 - 31 (WCDMA, Rel99, Ch9262)

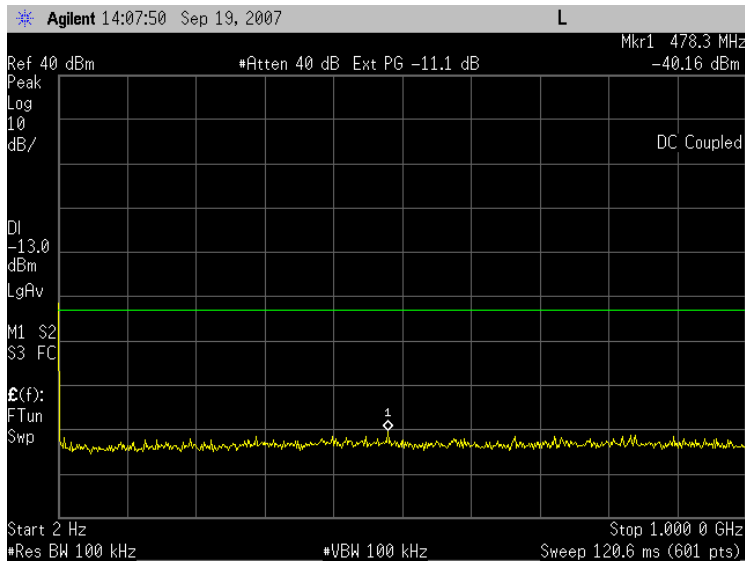

Plot 7.2 - 32 (WCDMA, Rel99, Ch9262)

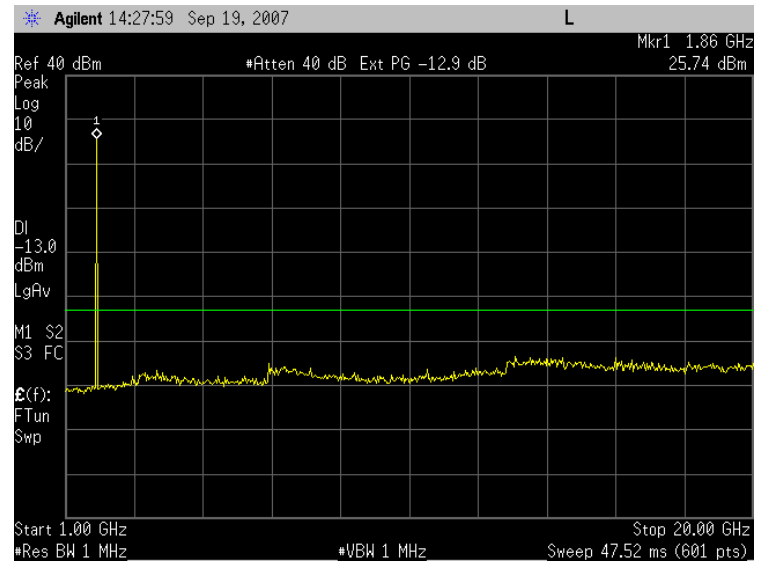

Plot 7.2 - 33 (WCDMA, Rel99, Ch9400)

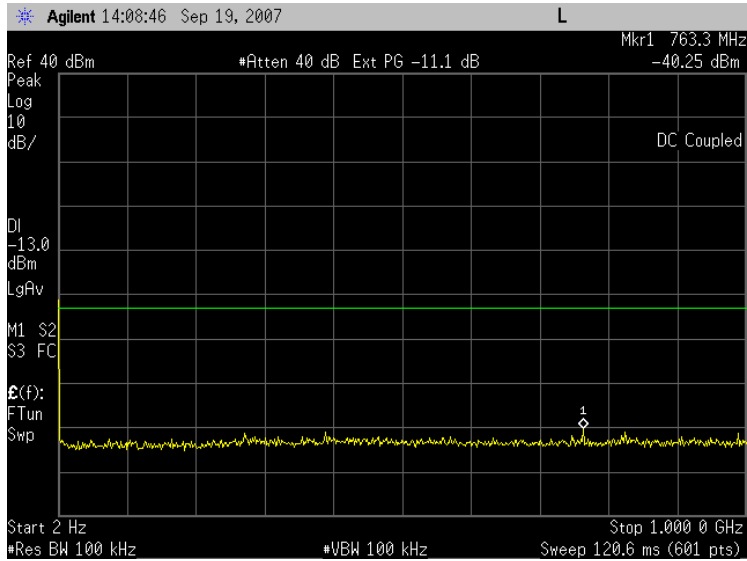

Plot 7.2 - 34 (WCDMA, Rel99, Ch9400)

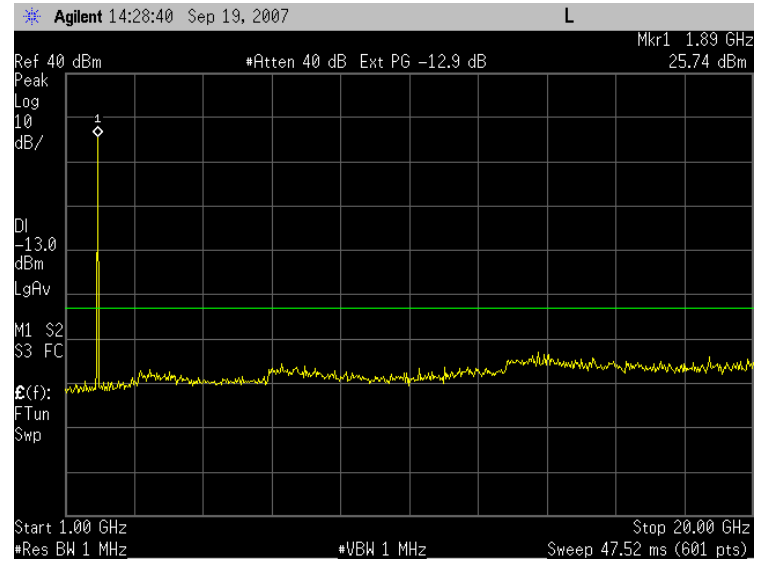

Plot 7.2 - 35 (WCDMA, Rel99, Ch9538)

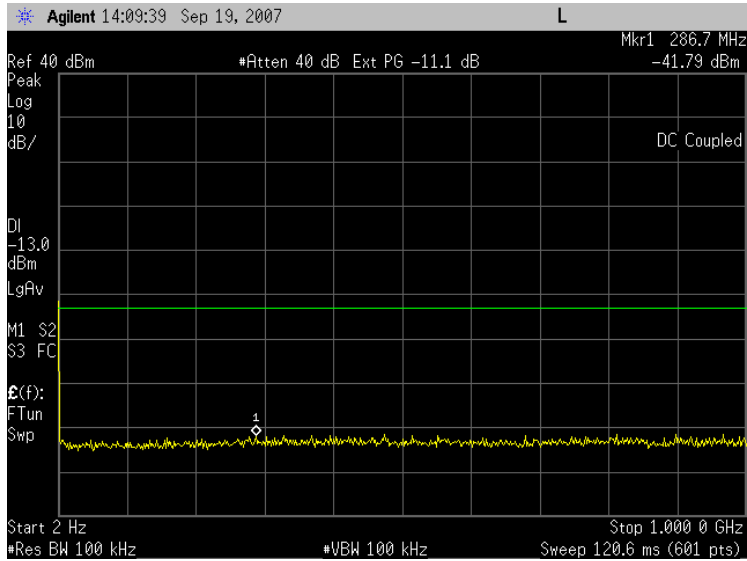

Plot 7.2 - 36 (WCDMA, Rel99, Ch9538)

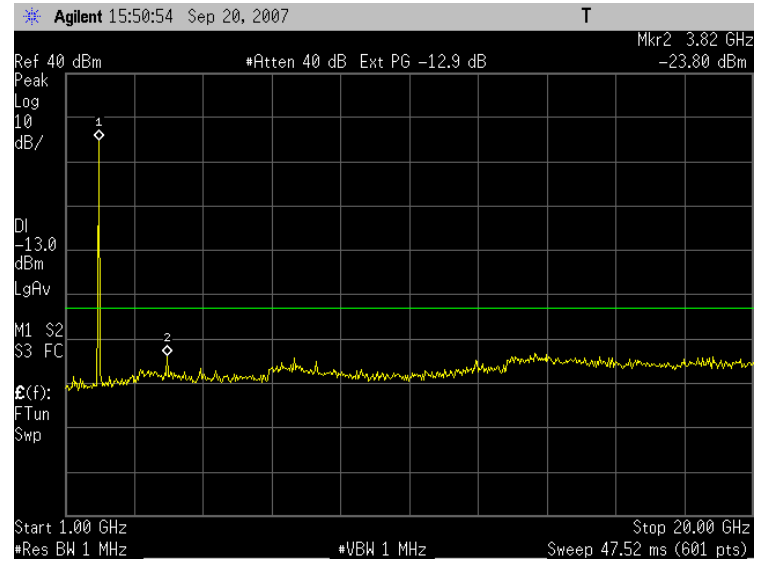

Plot 7.2 - 37 (EVDO, Rel0, 153.6kbps, Ch1013)

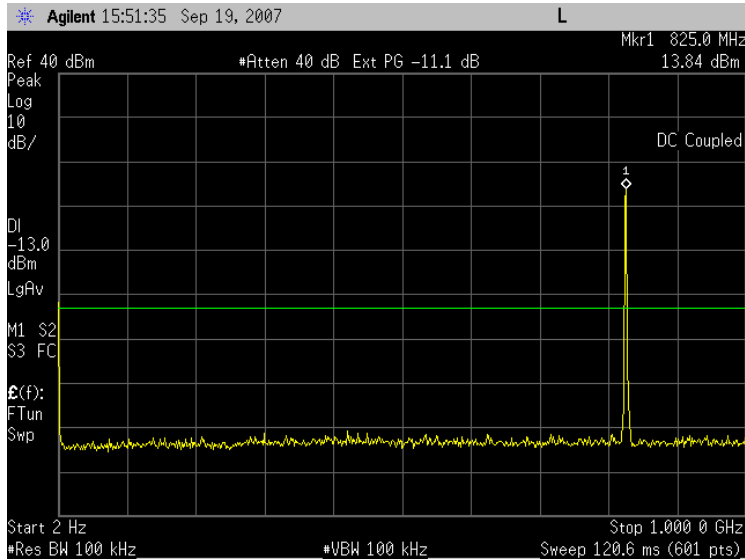

Plot 7.2 - 39 (EVDO, Rel0, 153.6kbps, Ch384)

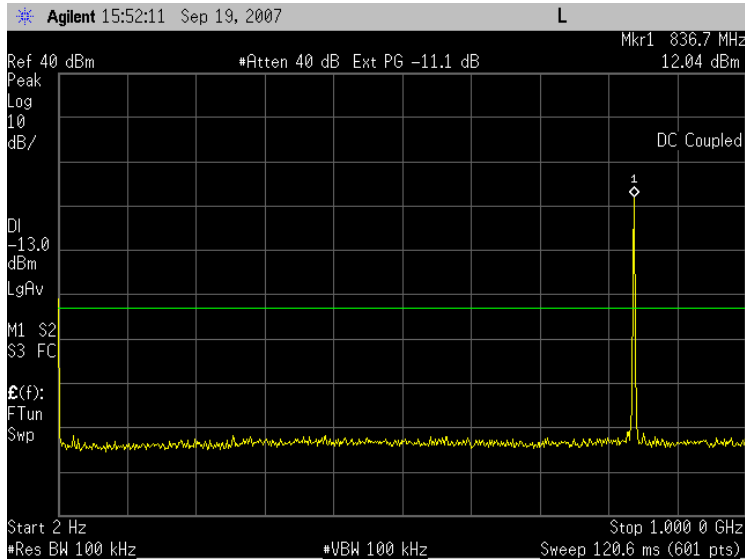

Plot 7.2 - 38 (EVDO, Rel0, 153.6kbps, Ch1013)

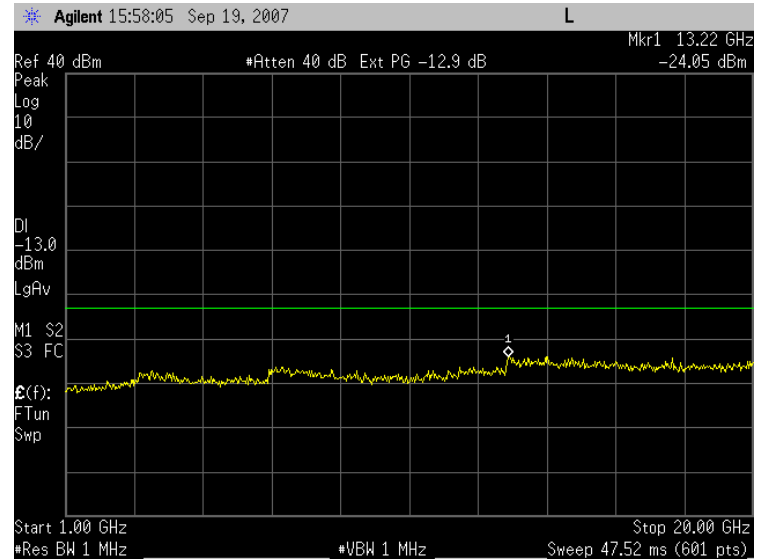

Plot 7.2 - 40 (EVDO, Rel0, 153.6kbps, Ch384)

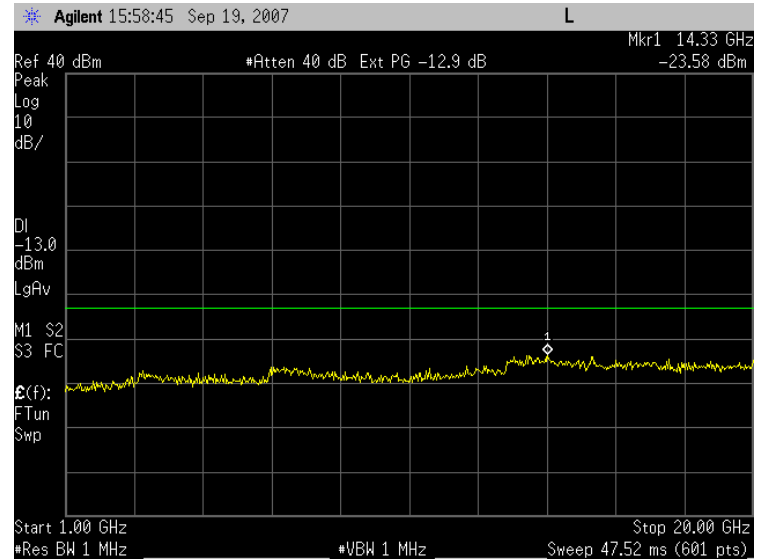

Plot 7.2 - 41 (EVDO, Rel0, 153.6kbps, Ch777)

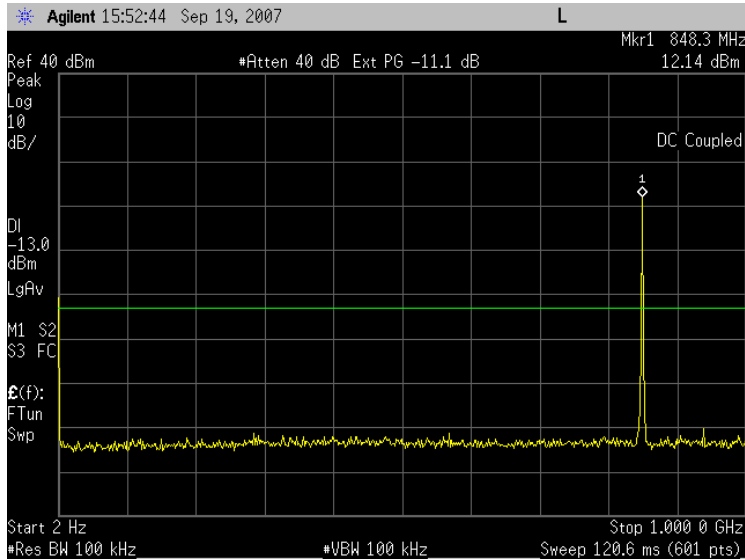

Plot 7.2 - 42 (EVDO, Rel0, 153.6kbps, Ch777)

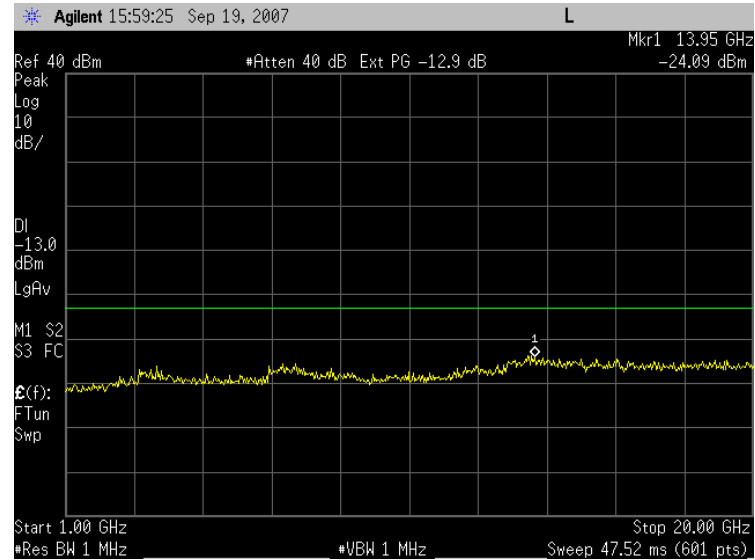

Plot 7.2 - 43 (EVDO, Rel0, 153.6kbps, Ch25)

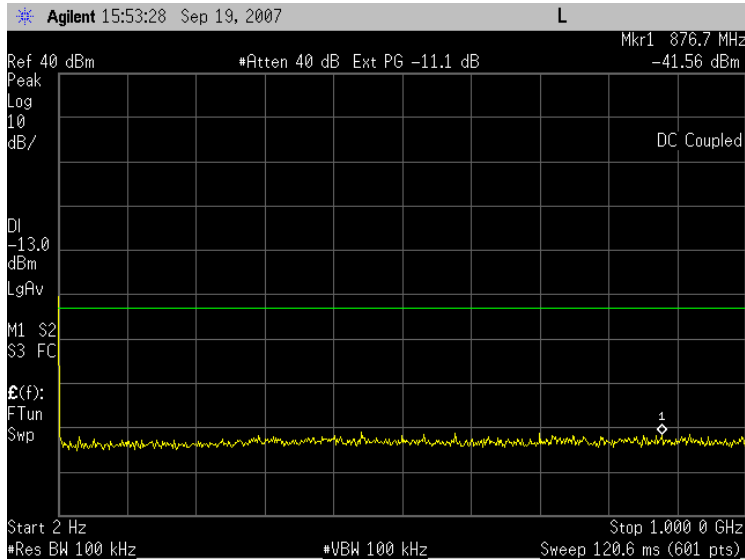

Plot 7.2 - 44 (EVDO, Rel0, 153.6kbps, Ch25)

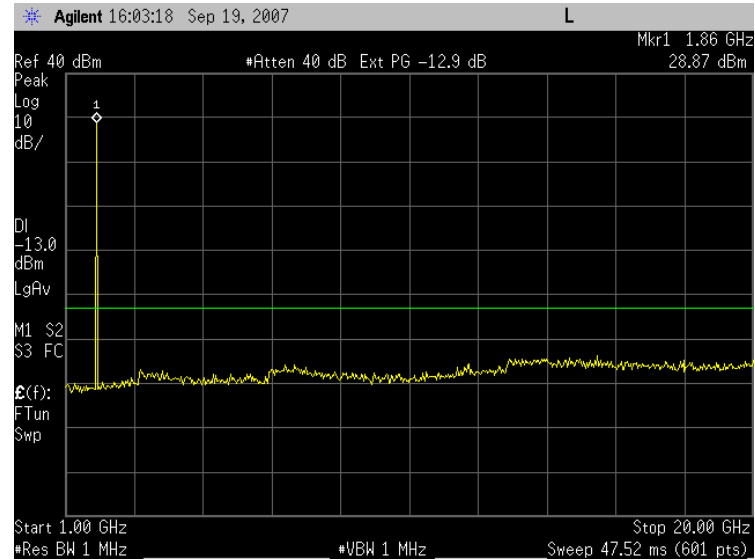

Plot 7.2 - 45 (EVDO, Rel0, 153.6kbps, Ch600)

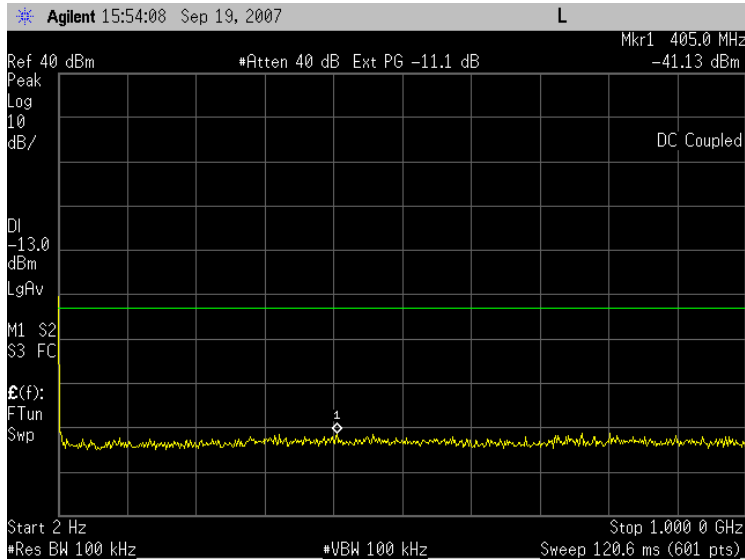

Plot 7.2 - 46 (EVDO, Rel0, 153.6kbps, Ch600)

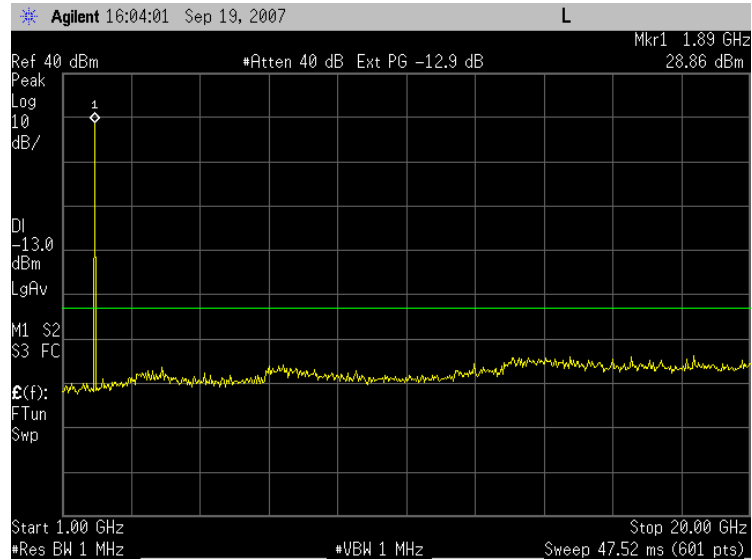

Plot 7.2 - 47 (EVDO, Rel0, 153.6kbps, Ch1175)

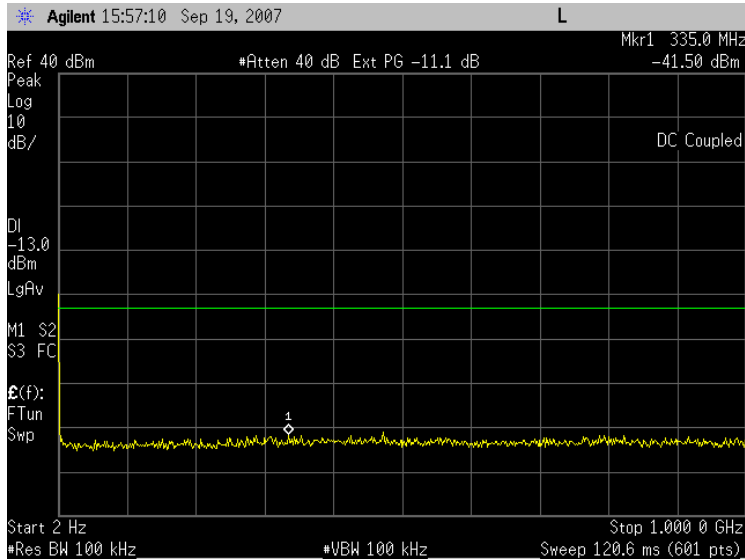

Plot 7.2 - 48 (EVDO, Rel0, 153.6kbps, Ch1175)

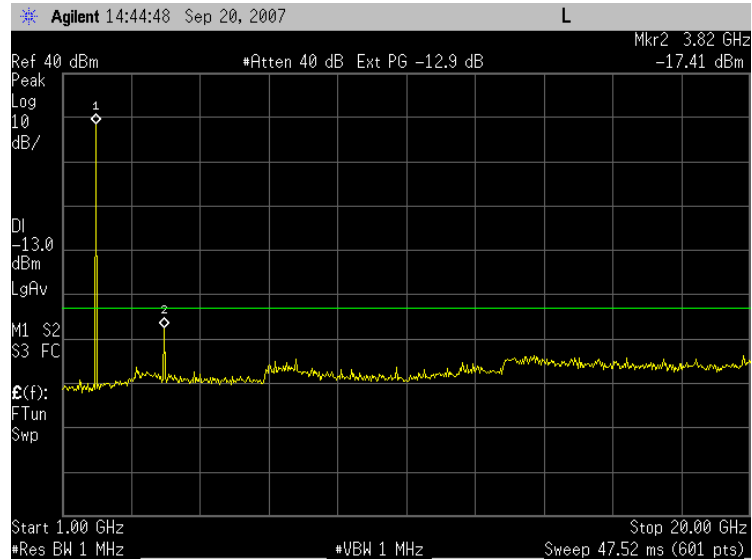

8. Frequency Stability

FCC:	§2.1055, 22.355, 24.235		
Limit:	±2.5ppm		
DUT SN	N10DG52R3		
Modes Tested	CDMA 1x / 1x-EVDO	WCDMA/HSPA	GSM/GPRS/EDGE
	▪ Rel 0, RTAP rate = 153.6kbps	▪ Rel 99	▪ GSM ▪ EDGE

8.1 Test Procedure

As the test setup indicates, placed the UNDP-1 inside the temperature chamber. Measured the transmitting frequency error at 20 degrees C with DC voltage varying from 3.0 volts to 3.6 volts, and then set the temperature to -30 degrees C and allow it to stabilize. After 1 hour soak time, take the measurement on transmitting frequency error at -30 degrees C in the same manner. As an incremental of 10 degrees C, repeat the same process until +60 degrees C is completed.

Used 8960 call box for CDMA 1x/1x-EVDO measurement, and 8820B for UMTS testing.

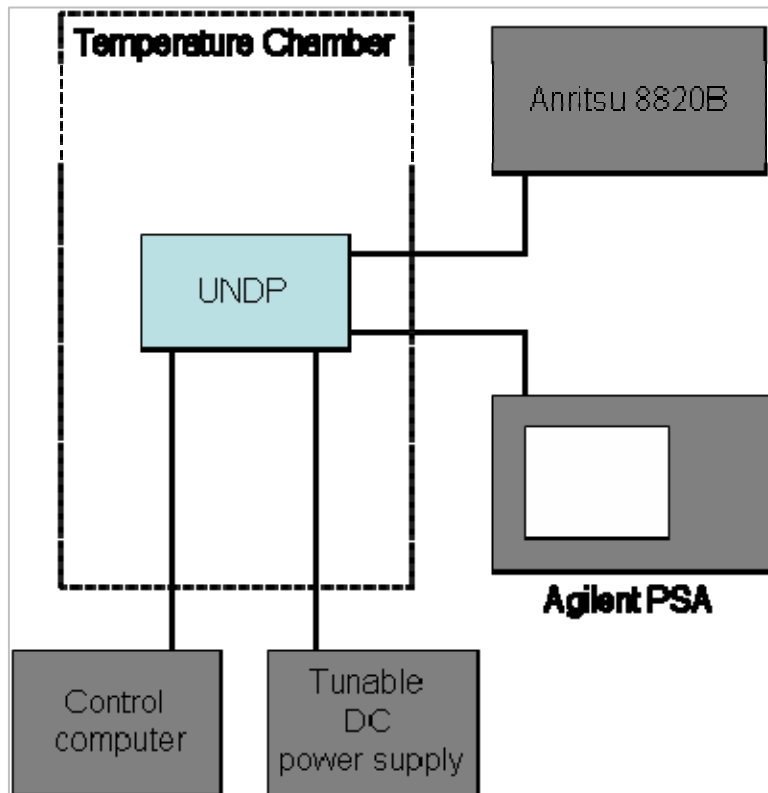

8.2 Test Results

The test was conducted at mid channel in each band.

Operation Mode:	GMSK	Channel:	190
Tx Frequency:	836.6MHz	Voltage:	3.3v (3.0v ~ 3.6v)
Limit:	±2.5ppm (±2091Hz)		

Temperature (°C)	Deviation of Carrier (Hz)			Specification (Hz)	
	3.0V	3.3V	3.6V	Lower limit	Upper limit
-30	-4.1	-3.2	-3.2	-2091	2091
-20	268	4.3	-13.2	-2091	2091
-10	-198	-26.9	-39.2	-2091	2091
0	-193	-17.2	-11.1	-2091	2091
10	-289	-9.1	-20.4	-2091	2091
20	-277	-21.3	-15.6	-2091	2091
30	-252	-16.9	-20.8	-2091	2091
40	-242	-16.8	-17.7	-2091	2091
50	-392	-49.8	-40.3	-2091	2091
60	202	-10.5	6.0	-2091	2091

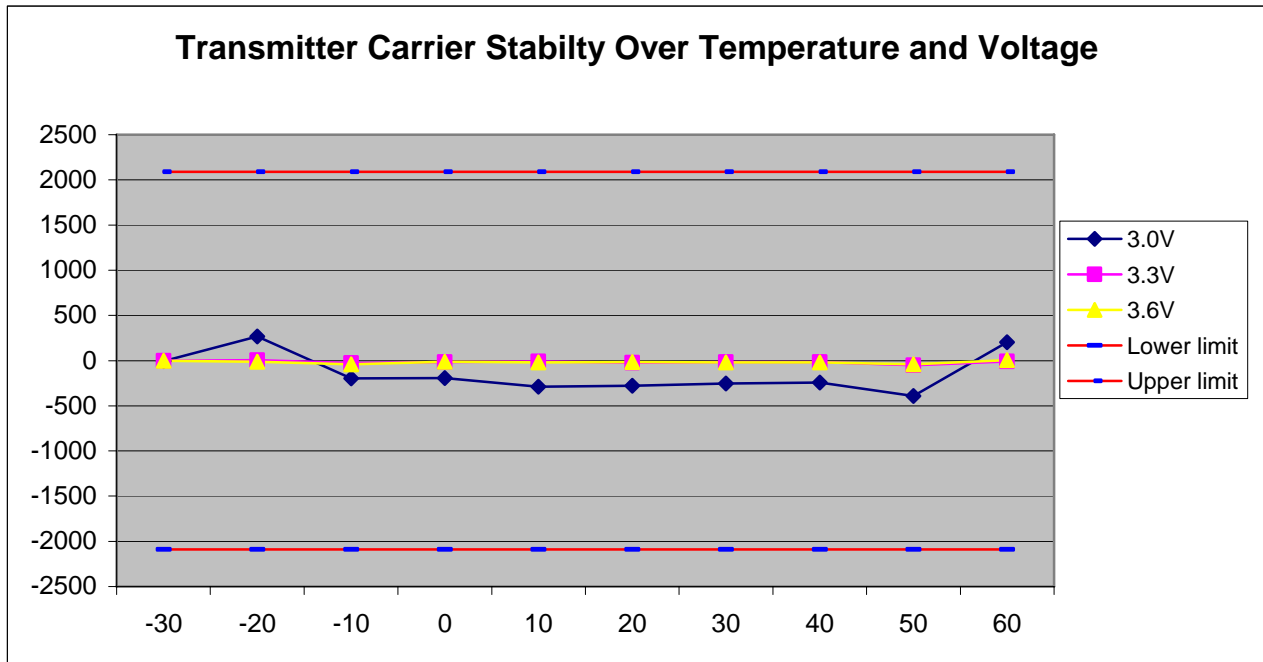

Operation Mode:	GMSK	Channel:	661
Tx Frequency:	1880MHz	Voltage:	3.3v (3.0v ~ 3.6v)
Limit:	±2.5ppm (±4700Hz)		

Temperature (°C)	Deviation of Carrier (Hz)			Specification (Hz)	
	3.0V	3.3V	3.6V	Lower limit	Upper limit
-30	-10.7	6.9	-2.2	-4700	4700
-20	-481	-17.2	11.7	-4700	4700
-10	-364	-18.6	-21.1	-4700	4700
0	-267	6.6	12.6	-4700	4700
10	-506	2.8	4.4	-4700	4700
20	-395	-41.9	-55.4	-4700	4700
30	-317	-14.3	4.6	-4700	4700
40	-289	-23.5	-40.1	-4700	4700
50	-1097	-53.7	-57.5	-4700	4700
60	-830	-8.5	13.2	-4700	4700

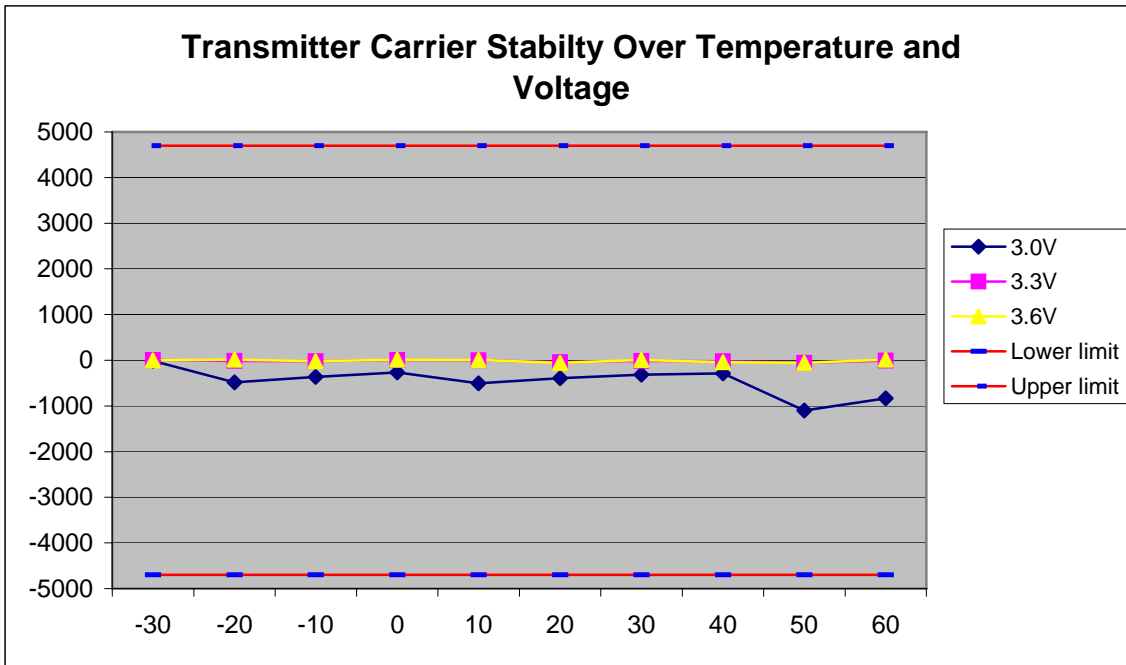

Operation Mode:	8PSK	Channel:	190
Tx Frequency:	836.6MHz	Voltage:	3.3v (3.0v ~ 3.6v)
Limit:	±2.5ppm (±2091Hz)		

Temperature (°C)	Deviation of Carrier (Hz)			Specification (Hz)	
	3.0V	3.3V	3.6V	Lower limit	Upper limit
-30	-15.0	11.8	7.7	-2091	2091
-20	-2.7	18.0	17.8	-2091	2091
-10	-41.0	-31.1	-33.7	-2091	2091
0	12.9	16.5	19.2	-2091	2091
10	-48.9	-39.4	-30.6	-2091	2091
20	-22.7	-20.4	18.5	-2091	2091
30	18.1	12.8	-5.6	-2091	2091
40	12.5	24.6	-14.1	-2091	2091
50	86.4	-50.5	-46.1	-2091	2091
60	-41.1	-14.3	-15.5	-2091	2091

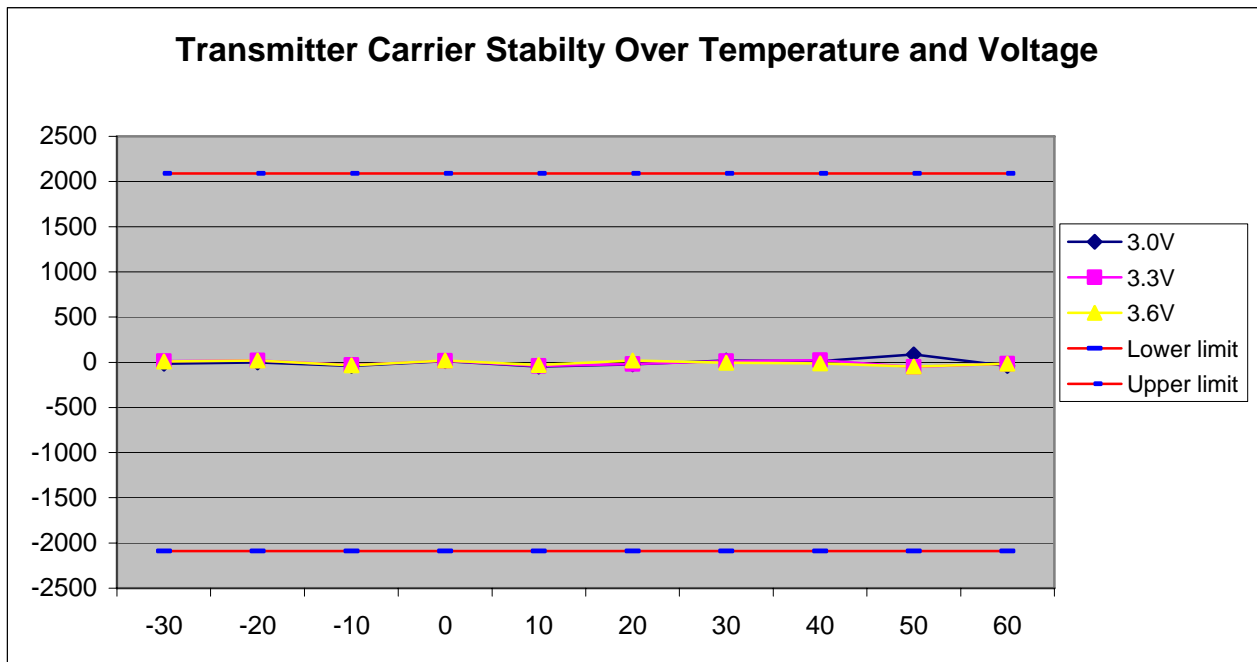

Operation Mode:	8PSK	Channel:	661
Tx Frequency:	1880MHz	Voltage:	3.3v (3.0v ~ 3.6v)
Limit:	±2.5ppm (±4700Hz)		

Temperature (°C)	Deviation of Carrier (Hz)			Specification (Hz)	
	3.0V	3.3V	3.6V	Lower limit	Upper limit
-30	-81.4	-40.1	-57.0	-4700	4700
-20	-13.7	7.7	18.8	-4700	4700
-10	-52.6	-2.4	-16.6	-4700	4700
0	-12.0	7.9	9.2	-4700	4700
10	-45.7	-19.0	8.7	-4700	4700
20	-22.6	-12.0	4.5	-4700	4700
30	-22.1	-4.3	16.8	-4700	4700
40	-12.5	34.0	19.6	-4700	4700
50	-65.8	-82.8	-66.6	-4700	4700
60	18.7	-57.3	-11.1	-4700	4700

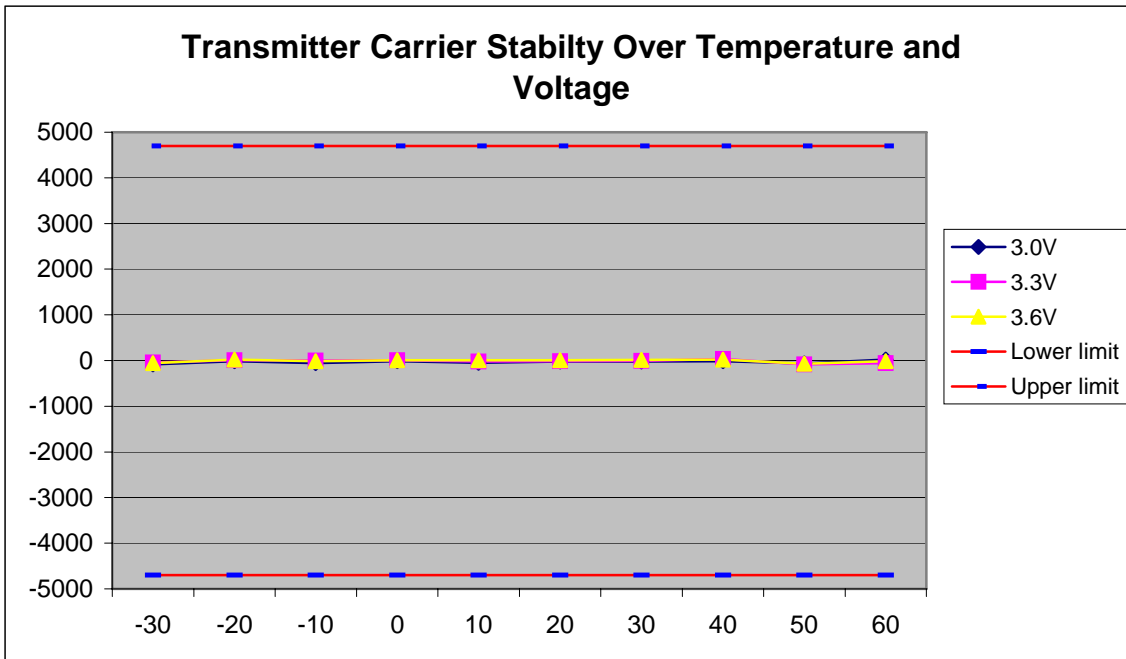

Operation Mode:	WCDMA Rel 99	Channel:	4182
Tx Frequency:	836.4MHz	Voltage:	3.3v (3.0v ~ 3.6v)
Limit:	±2.5ppm (±2091Hz)		

Temperature (°C)	Deviation of Carrier (Hz)			Specification (Hz)	
	3.0V	3.3V	3.6V	Lower limit	Upper limit
-30	-3.3	8.6	15.2	-2091	2091
-20	-12.5	-7.2	15.7	-2091	2091
-10	0.7	9.8	-2.4	-2091	2091
0	7.1	4.3	9.9	-2091	2091
10	2.7	-1.4	3.4	-2091	2091
20	-10.0	-2.0	-7.5	-2091	2091
30	9.0	0.0	11.5	-2091	2091
40	-42.6	2.3	12.4	-2091	2091
50	8.1	11.4	11.0	-2091	2091
60	-11.1	1.4	11.6	-2091	2091

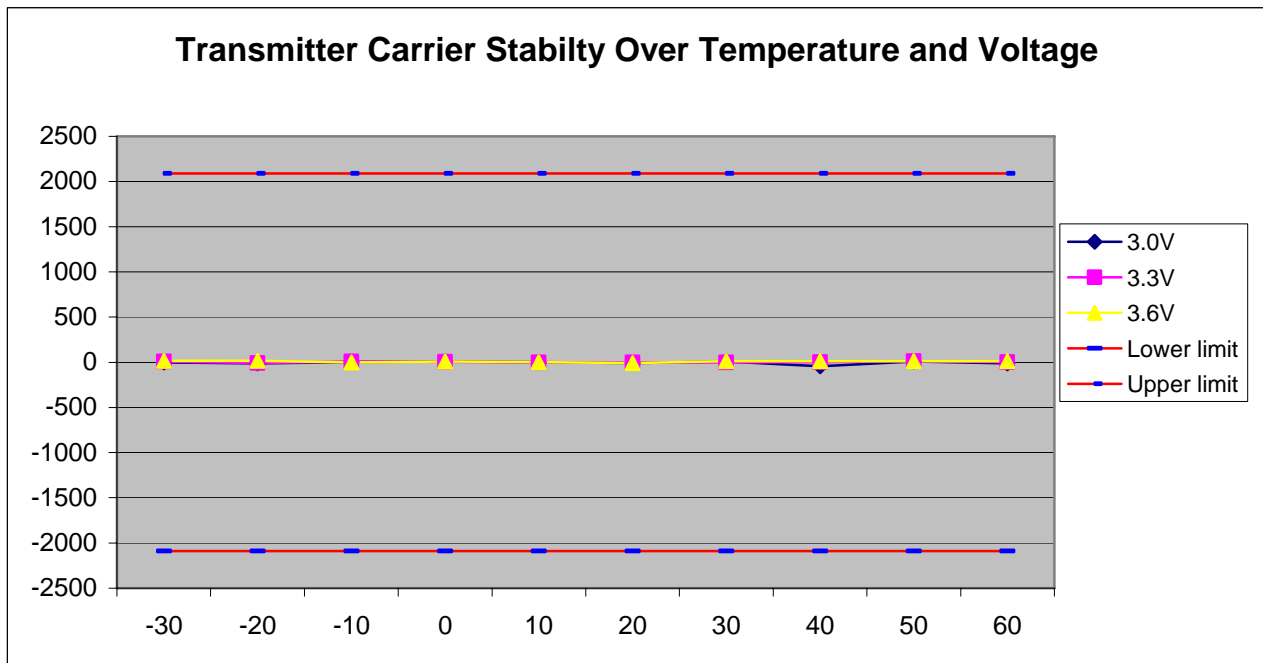

Operation Mode:	WCDMA Rel 99	Channel:	9400
Tx Frequency:	1880MHz	Voltage:	3.3v (3.0v ~ 3.6v)
Limit:	±2.5ppm (±4700Hz)		

Temperature (°C)	Deviation of Carrier (Hz)			Specification (Hz)	
	3.0V	3.3V	3.6V	Lower limit	Upper limit
-30	-3.0	-11.9	17.4	-4700	4700
-20	10.8	-10.8	-5.0	-4700	4700
-10	-9.2	-1.8	2.3	-4700	4700
0	-1.0	-18.3	-8.6	-4700	4700
10	16.9	14.8	16.4	-4700	4700
20	17.3	32.8	-11.7	-4700	4700
30	-9.9	-12.3	0.1	-4700	4700
40	-3.1	-18.0	-24.9	-4700	4700
50	-79.5	8.1	-7.4	-4700	4700
60	-3.1	31.9	-5.3	-4700	4700

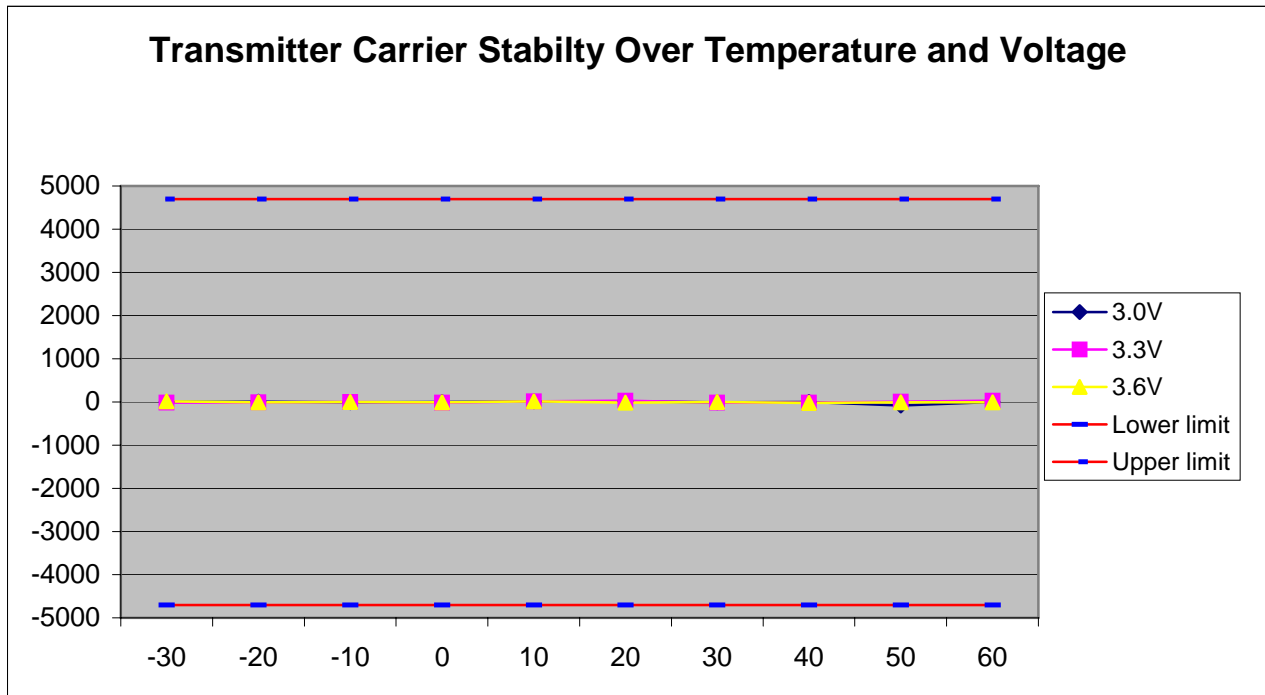

Operation Mode:	EVDO, Rel 0, RTAP rate = 153.6kbps	Channel:	384
Tx Frequency:	836.52MHz	Voltage:	3.3v (3.0v ~ 3.6v)
Limit:	±2.5ppm (±2091Hz)		

Temperature (°C)	Deviation of Carrier (Hz)			Specification (Hz)	
	3.0V	3.3V	3.6V	Lower limit	Upper limit
-30	-10.3	20.9	24.2	-2091	2091
-20	4.7	2.8	7.6	-2091	2091
-10	13.7	11.6	5.2	-2091	2091
0	17.6	4.4	6.9	-2091	2091
10	28.4	-1.4	2.2	-2091	2091
20	-1.4	7.1	10.8	-2091	2091
30	5.8	3.6	11.4	-2091	2091
40	14.6	-3.1	6.8	-2091	2091
50	8.8	-5.6	9.4	-2091	2091
60	7.9	-0.4	10.6	-2091	2091

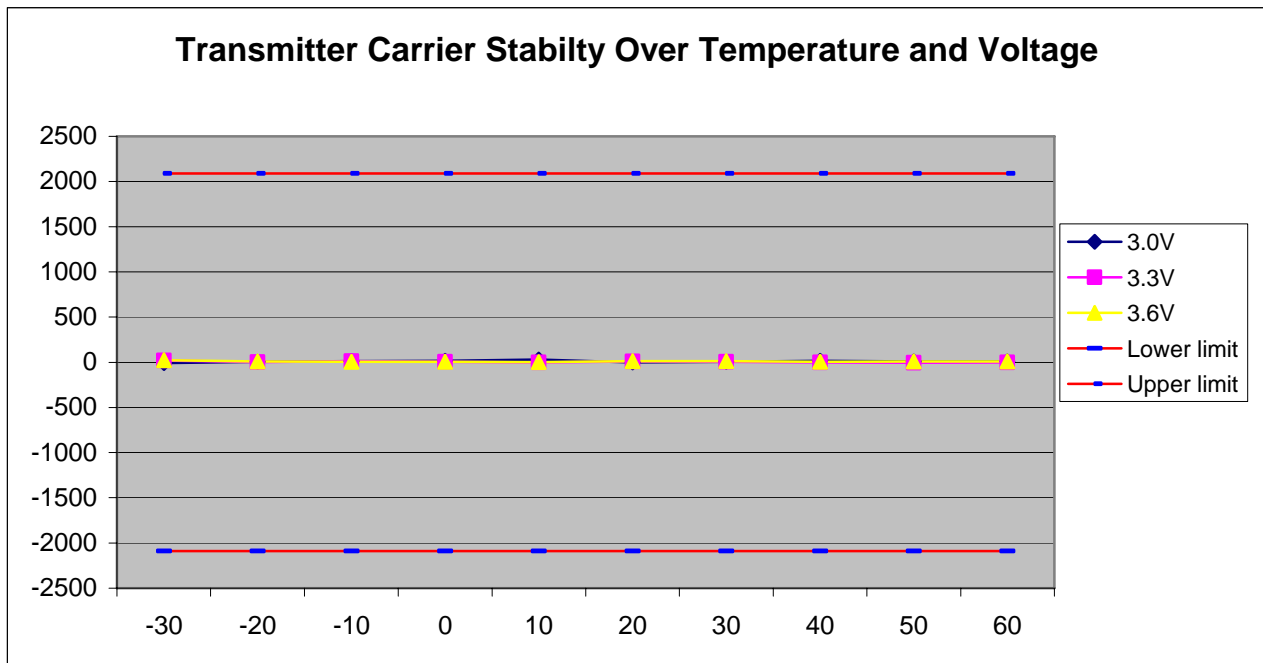

Operation Mode:	EVDO, Rel 0, RTAP rate = 153.6kbps	Channel:	600
Tx Frequency:	1880MHz	Voltage:	3.3v (3.0v ~ 3.6v)
Limit:	±2.5ppm (±4700Hz)		

Temperature (°C)	Deviation of Carrier (Hz)			Specification (Hz)	
	3.0V	3.3V	3.6V	Lower limit	Upper limit
-30	-25.9	-1.8	14.6	-4700	4700
-20	-72.6	7.8	12.5	-4700	4700
-10	13.6	-1.8	2.4	-4700	4700
0	67.0	12.5	-1.3	-4700	4700
10	22.4	11.6	5.8	-4700	4700
20	-73.0	-5.3	3.2	-4700	4700
30	-12.8	0.6	3.3	-4700	4700
40	118.0	-1.9	-1.6	-4700	4700
50	-10.1	2.2	0.9	-4700	4700
60	6.2	4.2	8.1	-4700	4700

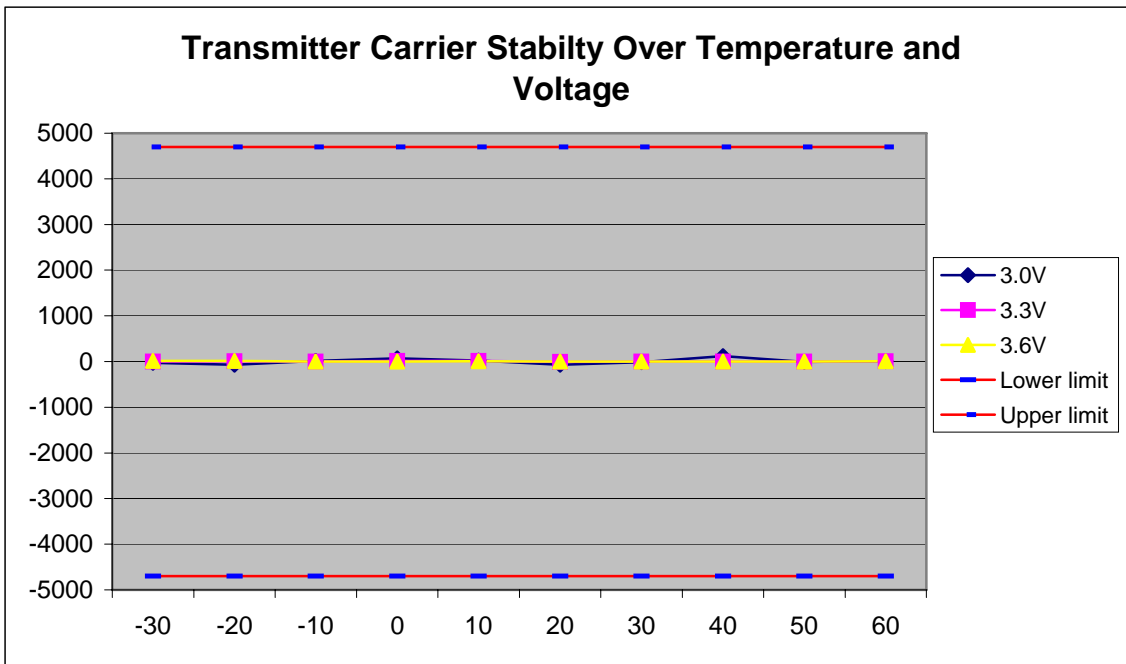

9. Test Equipment and Firmware

The following test equipments were used.

Model	Manufacturer	Description	S/N	Cal Data	Cal Due Date
MT8820B	Anritsu	Radio communication Analyzer	K159401	09/12/2007	09/12/2008
8960 Series 10 E5515C	Agilent	Wireless Communication Set	K119302	06/27/2007	06/27/2008
E4440A PSA Series	Agilent	Spectrum Analyzer	K118613	03/28/2007	03/28/2008
T43 Thinkpad	IBM/Lenovo	Notebook Computer	P63154	N/R	N/R
Model 105	TestEquity	Temperature Chamber	K141144	08/12/2007	08/12/2008
50-VD628-1 Rev A/A	Qualcomm	Module Fixture	U2-069	N/R	N/R

The firmwares built in the 8960 and 8820B are as follows, and have been validated to support the testing for all technologies implemented in UNDP-1.

Call Box	Technology	Firmware Rev
8960	EVDO	A.07.21
	1x	B.12.21
8820B	UMTS	10.11 #001