

Acer ICONIA TAB User Guide

Model: A100

First issue: 05/2011

Acer ICONIA TAB

Model number: \_\_\_\_\_

Serial number: \_\_\_\_\_

Date of purchase: \_\_\_\_\_

Place of purchase: \_\_\_\_\_

# Table of Contents

---

## End User License Agreement

### Getting to know your tablet

Features and functions .....	7
Product registration .....	7

### Setting Up

Unpacking your tablet .....	8
Getting to know your tablet .....	9
Charging your tablet .....	12

### Using Your Tablet

Turning on for the first time .....	13
Locking your tablet .....	14
Using the touchscreen .....	14
The Home screen .....	15
The onscreen keyboard .....	21
Editing text .....	23

### Connecting devices to your tablet

Connecting to AC power .....	25
Inserting a micro SD card (optional) .....	25
Connecting to a PC as a USB storage device .....	25
Connecting a Bluetooth device .....	26
Connecting to a television with HDMI .....	26
Connecting to the dock (optional) .....	27

### Going Online

Managing Wi-Fi Connections .....	28
Browsing the Internet .....	28
Setting up Gmail (Google mail) .....	29
Composing an email .....	29
Setting up the Email application .....	30
Online applications .....	30

### Acer content folders

### Playing music and video

Multimedia playback .....	36
---------------------------	----

Media server .....	39
Dolby Mobile .....	39
<b>Managing Contacts</b>	
<b>Using the Camera</b>	
Camera icons and indicators .....	43
Taking a photo .....	44
Shooting a video .....	45
<b>Reading an eBook</b>	
LumiRead .....	47
<b>Advanced Settings</b>	
Sound .....	51
Screen .....	51
Putting your tablet in Airplane mode .....	52
Activating or deactivating connections .....	52
Adjusting Bluetooth settings .....	52
Connecting to a PC .....	53
Synchronization .....	53
Setting the date and time .....	54
Setting alarms .....	54
Changing language and text options .....	54
Managing applications .....	54
Updating your tablet's operating system .....	55
Resetting your tablet .....	55
<b>Appendix</b>	
FAQ and troubleshooting .....	57
Other sources of help .....	58
Specifications .....	59
Safety .....	61

# End User License Agreement

---

IMPORTANT - READ CAREFULLY: THIS END USER LICENSE AGREEMENT ("AGREEMENT") IS A LEGAL AGREEMENT BETWEEN YOU (EITHER AN INDIVIDUAL OR A SINGLE ENTITY), AND ACER INC. INCLUDING ITS SUBSIDIARIES ("ACER") FOR THE SOFTWARE (WHETHER PROVIDED BY ACER OR BY ACER'S LICENSORS OR SUPPLIERS) THAT ACCOMPANIES THIS AGREEMENT, INCLUDING ANY ASSOCIATED MEDIA, PRINTED MATERIALS AND RELATED USER ELECTRONIC DOCUMENTATION WHICH MAY BE BRANDED "ACER" ("SOFTWARE"). AGREEMENTS RELATING TO ANY OTHER PRODUCT OR TOPIC ARE NEITHER INTENDED NOR SHOULD THEY BE IMPLIED. BY INSTALLING THE ACCOMPANYING SOFTWARE OR ANY PORTION THEREOF, YOU AGREE TO BE BOUND BY THE TERMS AND CONDITIONS OF THIS AGREEMENT. IF YOU DO NOT AGREE TO ALL OF THE TERMS AND CONDITIONS OF THIS AGREEMENT, DO NOT CONTINUE THE INSTALLATION PROCESS AND IMMEDIATELY DELETE ALL INSTALLED FILES, IF ANY, OF THE ACCOMPANYING SOFTWARE FROM YOUR DEVICE.

IF YOU DO NOT HAVE A VALIDLY-LICENSED COPY OF THE APPLICABLE SOFTWARE, YOU ARE NOT AUTHORIZED TO INSTALL, COPY OR OTHERWISE USE THE SOFTWARE, AND HAVE NO RIGHTS UNDER THIS AGREEMENT.

The Software is protected by U.S. and international copyright laws and conventions as well as other intellectual property laws and treaties. The Software is licensed, not sold.

## GRANT OF LICENSE

Acer grants to you the following non-exclusive and non-transferable rights with respect to the Software. Under this Agreement, you may:

1. Install and use the Software only on a single designated device. A separate license is required for each device on which the Software will be used;
2. Make one copy of the Software solely for backup or archival purposes;
3. Make one hardcopy of any electronic documents included in the Software, provided that you receive the documents electronically.

## RESTRICTIONS

You may NOT:

1. Use or copy the Software except as provided in this Agreement;
2. Rent or lease the Software to any third party;
3. Modify, adapt, or translate the Software in whole or in part;
4. Reverse engineer, decompile, or disassemble the Software or create derivative works based upon the Software;
5. Merge the Software with any other program or modify the Software, except for your personal use; and
6. Sublicense or otherwise make the Software available to third parties, except that you may, after prior written notification to Acer, transfer the Software as a whole to a third party so long as you do not retain any copies of the Software and such third party accepts the terms of this Agreement.
7. Transfer your rights under this Agreement to any third parties.
8. Export the Software in contravention of applicable export laws and regulations, or (i) sell, export, re-export, transfer, divert, disclose technical data, or dispose of, any Software to any prohibited person, entity, or destination including, without limitation, Cuba, Iran, North Korea, Sudan and Syria; or (ii) use any Software for any use prohibited by the laws or regulations of the United States.

## SUPPORT SERVICES

Acer is not obligated to provide technical or other support for the Software.

## ACER LIVE UPDATE

Certain of the software contains elements that enable the use of the Acer Live Update service, which allows for updates for such software to be automatically downloaded and installed on your device. By installing the software, you hereby agree and consent that Acer (or its licensors) may automatically check the version of such software that you are using on your device and may provide upgrades to such software that may be automatically downloaded on to your device.

## OWNERSHIP AND COPYRIGHT

Title, ownership rights and intellectual property rights in and to the Software and all copies thereof shall remain with Acer or Acer's licensors or suppliers (as applicable). You do not have or shall not gain any proprietary interest in the Software (including any modifications or copies made by or for you) or any related intellectual property rights. Title and related rights in the content accessed through the Software is the property of the applicable content owner and may be protected by applicable law. This license gives you no rights to such contents. You hereby agree

1. Not to remove any copyright or other proprietary notices from the Software;
2. To reproduce all such notices on any authorized copies you make; and
3. To use best efforts to prevent any unauthorized copying of the Software.

## TRADEMARKS

This Agreement does not grant to you any rights in connection with any trademarks or service marks of Acer or of Acer's licensors or suppliers.

## DISCLAIMER OF WARRANTIES

TO THE MAXIMUM EXTENT PERMITTED BY APPLICABLE LAW, ACER, ITS SUPPLIERS, AND ITS LICENSORS, PROVIDE THE SOFTWARE "AS IS" AND WITH ALL FAULTS, AND HEREBY DISCLAIM ALL OTHER WARRANTIES AND CONDITIONS, EITHER EXPRESS, IMPLIED OR STATUTORY, INCLUDING, BUT NOT LIMITED TO, ANY IMPLIED WARRANTIES, DUTIES OR CONDITIONS OF MERCHANTABILITY, OF FITNESS FOR A PARTICULAR PURPOSE, OF ACCURACY OR COMPLETENESS OF RESPONSES, OF RESULTS, OF WORKMANLIKE EFFORT, OF LACK OF VIRUSES, AND OF LACK OF NEGLIGENCE, ALL WITH REGARD TO THE SOFTWARE AND THE PROVISION OF OR FAILURE TO PROVIDE SUPPORT SERVICES. ALSO, THERE IS NO

WARRANTY OR CONDITION OF TITLE, QUIET ENJOYMENT, QUIET POSSESSION, CORRESPONDENCE TO DESCRIPTION OR NON-INFRINGEMENT WITH REGARD TO THE SOFTWARE.

#### EXCLUSION OF INCIDENTAL, CONSEQUENTIAL AND CERTAIN OTHER DAMAGES

TO THE MAXIMUM EXTENT PERMITTED BY APPLICABLE LAW, IN NO EVENT SHALL ACER, ACER'S SUPPLIERS, OR ACER'S LICENSORS, BE LIABLE FOR ANY SPECIAL, INCIDENTAL, INDIRECT, PUNITIVE, OR CONSEQUENTIAL DAMAGES WHATSOEVER (INCLUDING, BUT NOT LIMITED TO, DAMAGES FOR LOSS OF PROFITS OR CONFIDENTIAL OR OTHER INFORMATION, FOR BUSINESS INTERRUPTION, FOR PERSONAL INJURY, FOR LOSS OF PRIVACY, FOR FAILURE TO MEET ANY DUTY INCLUDING OF GOOD FAITH OR OF REASONABLE CARE, FOR NEGLIGENCE, AND FOR ANY OTHER PECUNIARY OR OTHER LOSS WHATSOEVER) ARISING OUT OF OR IN ANY WAY RELATED TO THE USE OF OR INABILITY TO USE THE SOFTWARE, THE PROVISION OF OR FAILURE TO PROVIDE SUPPORT SERVICES, OR OTHERWISE UNDER OR IN CONNECTION WITH ANY PROVISION OF THIS AGREEMENT, EVEN IN THE EVENT OF THE FAULT, TORT (INCLUDING NEGLIGENCE), STRICT LIABILITY, BREACH OF CONTRACT OR BREACH OF WARRANTY OF ACER OR ITS SUPPLIERS OR LICENSORS, AND EVEN IF ACER AND ITS SUPPLIERS AND LICENSORS HAVE BEEN ADVISED OF THE POSSIBILITY OF SUCH DAMAGES.

#### LIMITATION OF LIABILITY AND REMEDIES

NOTWITHSTANDING ANY DAMAGES THAT YOU MIGHT INCUR FOR ANY REASON WHATSOEVER (INCLUDING, WITHOUT LIMITATION, ALL DAMAGES REFERENCED ABOVE AND ALL DIRECT OR GENERAL DAMAGES), THE ENTIRE LIABILITY OF ACER, ITS SUPPLIERS, AND ITS LICENSORS, UNDER ANY PROVISION OF THIS AGREEMENT, AND YOUR EXCLUSIVE REMEDY FOR ALL OF THE FOREGOING, SHALL BE LIMITED TO THE AGGREGATE AMOUNT PAID BY YOU FOR THE SOFTWARE. THE FOREGOING LIMITATIONS, EXCLUSIONS AND DISCLAIMERS (INCLUDING DISCLAIMER OF WARRANTIES AND EXCLUSION OF INCIDENTAL, CONSEQUENTIAL AND CERTAIN OTHER DAMAGES ABOVE) SHALL APPLY TO THE MAXIMUM EXTENT PERMITTED BY APPLICABLE LAW, EVEN IF ANY REMEDY FAILS ITS ESSENTIAL PURPOSE; PROVIDED, HOWEVER, THAT BECAUSE SOME JURISDICTIONS DO NOT ALLOW THE EXCLUSION OR LIMITATION OR LIABILITY FOR CONSEQUENTIAL OR INCIDENTAL DAMAGES, THE ABOVE LIMITATION MAY NOT APPLY TO YOU.

#### TERMINATION

Without prejudice to any other rights, Acer may immediately terminate this Agreement without notice if you fail to comply with any terms and conditions of this Agreement.

In such event, you must:

1. Cease all use of the Software;
2. Destroy or return to Acer the original and all copies of the Software; and
3. Delete the Software from all devices on which it was resident.

All disclaimers of warranties and limitation of liability set forth in this Agreement shall survive termination of this Agreement.

#### GENERAL

This Agreement represents the complete agreement between you and Acer relating to this license for the Software and supersedes all prior agreements, communications, proposals and representations between the parties and prevails over any conflicting or additional terms of any quote, order, acknowledgement or similar communication. This Agreement may only be modified by a written document signed by both parties. If any provision of this Agreement is held by a court of competent jurisdiction to be contrary to law that provision will be enforced to the maximum extent permissible and the remaining provisions of this Agreement will remain in full force and effect.

#### ADDITIONAL PROVISIONS APPLICABLE TO THIRD PARTY SOFTWARE AND SERVICES

Software provided hereunder by Acer's licensors or suppliers ("Third Party Software") is made available to you for your personal, non-commercial use only. You may not use the Third Party Software in any manner that could damage, disable, overburden, or impair the services provided by Acer's licensors or suppliers hereunder ("Third Party Services"). Furthermore, you may not use the Third Party Software in any manner that could interfere with any other party's use and enjoyment of the Third Party Services, or the services and products of Acer's licensors' or suppliers' third party licensors. Your use of the Third Party Software and Third Party Services is also subject to additional terms and conditions and policies which can be accessed through our global website.

## Privacy policy

During registration you will be asked to submit some information to Acer. Please refer to Acer's privacy policy at <http://www.acer.com> or your local Acer website.

Music recognition technology and related data are provided by Gracenote®. Gracenote®, Gracenote logo and logotype, and the "Powered by Gracenote" logo are either a registered trademark or a trademark of Gracenote, Inc. in the United States and/or other countries.

 XT9 and XT9 logo are registered trademarks of Nuance Communications, Inc. or its subsidiaries in the United States of America and/or other countries.

# Getting to know your tablet

---

## Features and functions

Your new tablet offers leading, easy-to-access multimedia and entertainment features. You can:

- Connect to the Internet.
- Access your email while on the move.
- Keep in touch with your friends via your Contacts and social networking applications.
- Listen to rich, full-impact audio via Dolby Mobile.

## Product registration

When using your product for the first time, it is recommended that you immediately register it. This will give you access to useful benefits, such as:

- Faster service from our trained representatives.
- Membership in the Acer community: receive promotions and participate in customer surveys.
- The latest news from Acer.

Hurry and register, as other advantages await you!

## How to register

To register your Acer product, please visit **mobile.acer.com**. Click **Product Registration** and follow the simple instructions.

You can also register directly from your tablet by tapping the **Acer Registration** icon.

After we receive your product registration, you will be sent a confirmation email with important data that you should keep in a safe place.

# Setting Up

---

## Unpacking your tablet

Your new tablet comes packed in a protective box. Carefully unpack the box and remove the contents. If any of the following items is missing or damaged, contact your dealer immediately:

- Acer ICONIA TAB
- Quick Guide
- AC adapter
- Warranty card

# Getting to know your tablet

## Front view

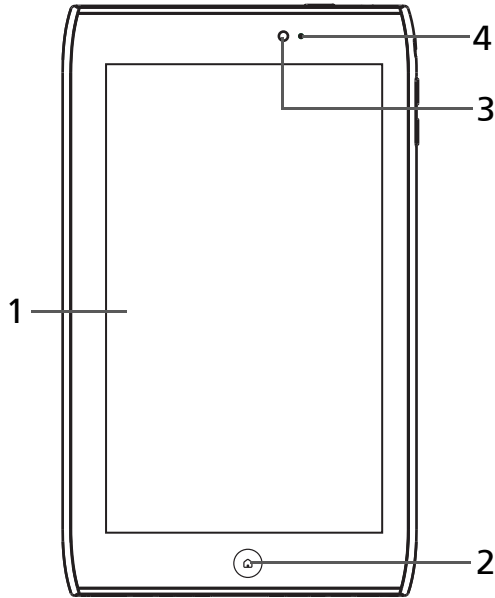

No.	Item	Description
1	Touchscreen	7-inch, 1024 x 600 pixel capacitive touchscreen.
2	Home button	Unknown
3	Front-facing camera	A 2-megapixel camera for video chatting and self-portrait images.
4	Light sensor	Detects ambient light and automatically adjusts the screen brightness.



## Back view

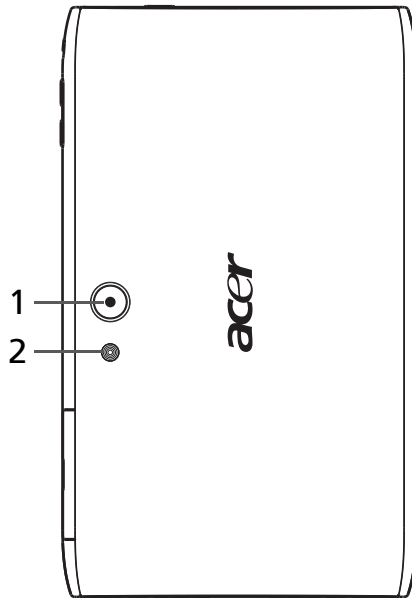

No.	Item	Description
1	5 MP camera	A 5-megapixel camera for taking high-resolution images.
2	LED flash	Lights to illuminate images.

## Top view



No.	Item	Description
1	Power button	Long press to turn the tablet on, press briefly to turn the screen on/off or enter sleep mode; press and hold to turn the tablet off.
2	3.5 mm headphone jack	Connect to stereo headphones.
3	Micro HDMI (Type D) connector	Connects to an HDMI cable with a Type D connector.

## Bottom view

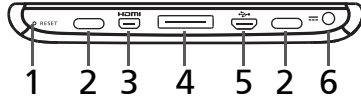

No.	Item	Description
1	Reset button	Insert a small thin object (such as a paperclip) to reset power to the tablet.
2	Speakers	Emits stereo audio
3	Micro HDMI (Type D) connector	Connects to an HDMI cable with a Type D connector.
4	Docking port	Connect your tablet to the dock accessory.
5	Micro USB connector (Slave)	Connects to a computer with a USB cable.
6	DC-in jack	Connects to the DC power supply.

## Side view



No.	Item	Description
1	Screen rotation lock switch	Use this switch to lock the screen rotation or allow the screen to match the tablet's orientation.
2	Volume control key	Increase and decrease the tablet volume.

No.	Item	Description
3	Card slot cover	Insert a micro SD card into the slot under this cover. See "Inserting a micro SD card (optional)" on page 25.

---

## Charging your tablet

For first-time use, you need to charge your tablet for four hours. After that you can recharge the battery as needed.

Connect the DC-in jack to your tablet and plug the AC adapter into any AC outlet.

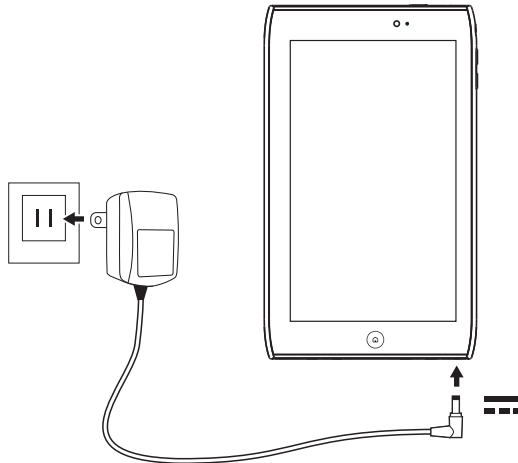

.....  
**Note:** It is normal for the tablet surface to become warm during charging or long periods of use.  
.....

# Using Your Tablet

---

## Turning on for the first time

To turn on your tablet, press and hold the power button for two seconds. You will then be asked some questions before you can use your tablet.

To start, tap to select your language, then tap **Start**. Follow the rest of the instructions as they are displayed.

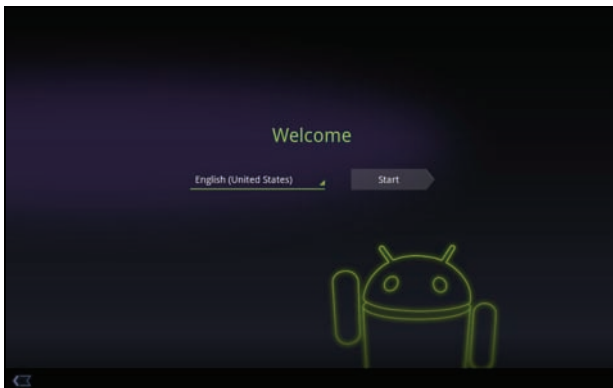

## Sign in to or create a Google account

If you have Internet access, your tablet allows you to synchronize information with a Google account.

During the start-up process, you may create or sign in to an account, which will be used to synchronize your contact list, email, calendar and other information. If you do not yet have Internet access, or do not want to use this feature, then tap **Skip**.



.....  
**Important:** You must sign into a Google Account to use Gmail, Google Talk, Google Calendar, and other Google Apps; to download applications from Android Market; to back up your settings to Google servers; and to take advantage of other Google services on your tablet.

If you want to restore existing settings from another device with Android 2.0 (or later) installed, you must sign into your Google account during setup. If you wait until after setup is complete, your settings will not be restored.  
.....



.....  
If you have multiple Google accounts, such as separate accounts for personal and business contacts, you can access and synchronize them from the Accounts settings section. See "Multiple Google accounts" on page 54.  
.....

# Locking your tablet

If you will not use your tablet for a while, briefly press the power button to lock access. This saves power and ensures your tablet does not unintentionally use any services. Your tablet will lock automatically if it is not used after a while. To change the delay, tap **Apps > Settings > Screen > Timeout**.

# Waking your tablet

If the screen is off and the tablet does not react to any taps on the screen, then it has been locked and is in sleep mode.

To wake your tablet, press the power button. Your tablet will display the Lock screen. Drag the lock symbol to the edge of the circle to unlock the tablet.



For additional security, you may set a code or number that must be entered to access the tablet, such as an unlock pattern (a set of dots that must be tapped in the correct order). Open the Home screen and tap **Apps > Settings > Location & security > Configure lock screen**.



.....  
**Note:** If you forget an unlock pattern or PIN, please refer to **“Unlock pattern” on page 58**.  
.....

# Using the touchscreen

Your tablet uses a touchscreen for selecting items and entering information. Use your finger to tap the screen.

**Tap:** Touch the screen once to open items and select options.

**Drag:** Hold your finger on the screen and drag across the screen to select text and images.

**Tap and hold:** Tap and hold an item to see a list of actions available for that item. On the pop-up menu that appears, tap the action you want to perform.

**Scroll:** To scroll up or down the screen, simply drag your finger up or down the screen in the direction that you want to scroll.

## The Home screen

When you start your tablet, or wake it from power saving, it will display the Home screen. This screen gives you quick access to information and simple controls with widgets or shortcuts. These display information such as the time and favorite bookmarks, or provide additional controls and direct access to applications. Some have been pre-installed on your tablet, while others may be downloaded from the Android Market.

The Home screen already features some useful controls and information.



### Search

To search for applications, files or for information on the Internet, tap the **Google / Search** icon in the top-left corner.



Simply enter the text you want to find. Tap the arrow or Enter key to search the Internet, or tap one of the suggestions, applications or files shown in the list.



.....  
**Note:** In order to search or browse the Internet, you must be connected to a wireless network. See "Going Online" on page 28.  
.....

### Voice search

If voice search is available, tap the microphone and speak your search request. See "Voice Search" on page 29.



### Navigation

To navigate through menus and options, three (or more) icons are shown in the bottom-left corner.



## Back

Tap this icon to go to the previous page, or to go up one level in a menu. This icon may be replaced with the *hide* icon in certain cases (such as if the keyboard or list of recent applications is shown).

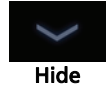

## Home

Tap this icon to go directly to the Home screen.

## Recent

Tap this icon to see recently opened applications. Tap an application to open it, or tap anywhere on the screen to return to the Home screen.

## Settings

This icon is displayed in some applications. Tap this icon to open a list of options.



## The extended Home screen

The Home screen extends to either side of the initial Home screen, giving you more room to add widgets or organize shortcuts. To view the extended Home screen, swipe your finger to the left or right.

A total of five pages are available, two to the left and two to the right. To change or add widgets on any of the screens see **“Personalizing the Home screen”** on page 20.



# The application menu

The application menu displays applications installed on your tablet.

Two categories are available **All** and **My apps**. **All** displays all applications that are installed on your tablet; **My apps** displays applications that you have installed from the Android Market.



**Note:** All images are for reference only. The applications installed on your tablet can be different to the applications shown in illustrations.

Applications are displayed in alphabetical order. If more applications are available, an outline of the second page will be shown on the side of the screen. Swipe the outline towards the center of the screen to switch pages.

Tap and hold an icon to add a shortcut to one of your Home screens. While a shortcut is selected, thumbnails of the Home screens are shown below the list of applications, simply drag the shortcut to a screen.

## Status and notification area

Status and notification icons are shown in the bottom-right corner of the screen.

This area contains a variety of icons to inform you of your tablet's status. The icons on the right side of the clock indicate connectivity and battery status. The left side of the clock displays the event notification icons.



Time  
Wireless reception  
Battery charge status



Tap the status icons to view more status information and a summary of events.

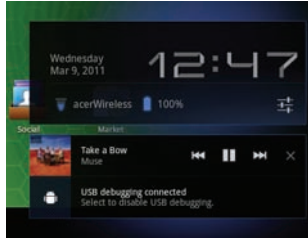

Tap the status area again to view more controls. While viewing a notification, tap the summary to see more information, if available. Some event summaries include controls, such as media controls if music is playing.

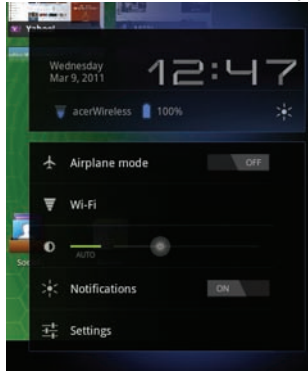

## Status and notification icons





















### Connection and batterystatus icons



**Note:** Network connection icons are blue if you have an active Google account.

Icon	Description	Icon	Description
	Connected to a wireless network (waves indicate connection strength)		Battery is very low
	An open wireless network is available		Battery is low
	Bluetooth is on		Battery is partially drained
	Connected to a Bluetooth device		Battery is full
	Airplane mode (wireless connectivity disconnected)		Battery is charging

## Notification icons

Icon	Description	Icon	Description
	Alarm is set		Speaker is silenced
	New Gmail message		Tablet microphone is off
	New Google Talk message		GPS is on
	Upcoming event		Receiving location data from GPS
	Song is playing		More status notifications
	SD card or USB storage is full		Syncing data
	Tablet is connected to PC via USB		Sync is on
	Application update available		Problem with sign-in or sync
	System update available		Uploading data
	Virtual private network (VPN) status		Downloading data
			Download finished

# Personalizing the Home screen

You may personalize your Home screen by adding or removing application shortcuts or widgets, and by changing the wallpaper.

## Adding or removing shortcuts or widgets

To add shortcuts or widgets open the **Add to Home** screen: tap the plus sign next to **Apps** in the top-right corner of the Home screen. Alternatively, tap and hold anywhere on the Home screen.

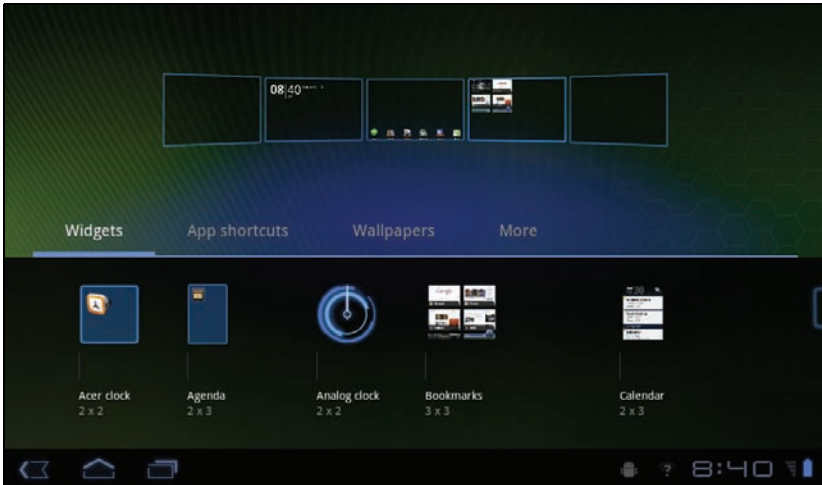

Tap **Widgets** to see small applications that you can add to a Home screen. Widgets are small applications display constantly-updated information or quick shortcuts to applications or special functions.

Tap **Applications** to open a list of shortcuts to applications and settings you can drag to a Home screen.

Tap **Wallpapers** to change the current wallpaper. You can choose from a set of pre-formatted wallpapers, images stored in the Gallery, or Live wallpapers featuring animated or interactive backgrounds.

Tap **More** to add icons, shortcuts, 'groups' of contacts or links to specific settings.

To move any item on the Home screen, tap and hold the item until it is selected. You may drag the item to any free area on the screen. To move the item to a different home screen, drag it to the side of the screen, the Home screen will switch to the screen in that direction. Release the item when it is positioned correctly.

To remove an item from the Home screen, tap and hold the item until the trash icon appears in the top-right corner of the screen. Simply drag the item to the trash icon.

## Adding shortcuts from the Application menu

You can add shortcuts to the Home screen directly from the application menu. Open the Application menu then tap and hold an icon until an image of the Home screens appears. Drag the icon to a Home screen to create a shortcut.

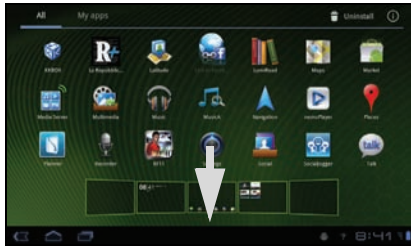

## The onscreen keyboard

When you tap a text box to enter text, an onscreen keyboard will appear. Simply tap on keys to enter text.

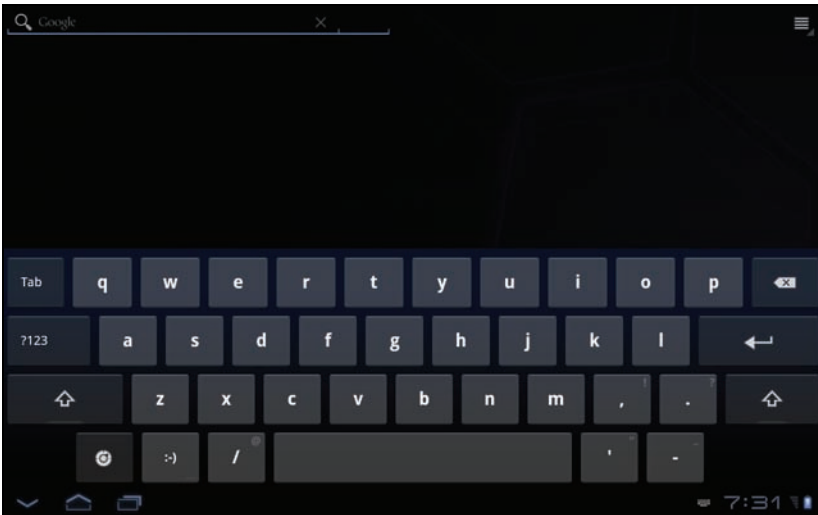

Tap the **123** button to see numbers and special characters, and then tap the **More** key to see more options. Tap and hold a key to select alternative characters (if available), such as letters with accents.

The layout of the keyboard varies slightly, depending on the application and information that is required.

## Changing Android keyboard settings

To use a different keyboard language or change settings, tap the **Input options** key, then select either **Input languages** or **Android keyboard**



**settings.** These settings include Auto-correction and keyboard sounds and vibration.

## Predictive text or auto correction

The Android keyboard can provide predictive text input. As you tap the letters of a word, a selection of words are displayed that continue the sequence of letters tapped, or are a close match allowing for errors. The word list changes after every key press. If the word you need is displayed, you can tap on it to insert it into your text.

To turn predictive text on or off with the Android keyboard, tap the **Input options** key, and then **Android keyboard settings**. Tap **Auto correction** or **Show correction suggestions** and select one of the options.

## Changing the keyboard

To use a different keyboard type, tap the **Keyboard status** icon; this will open a menu listing the text input methods available on your tablet. Tap your preferred input method.



Typically three options are available: two types of **Android Keyboard** (keyboard and voice) and **XT9 Text Input**.

## XT9 Text Input

The XT9 keyboard provides an alternative to the standard Android keyboard.

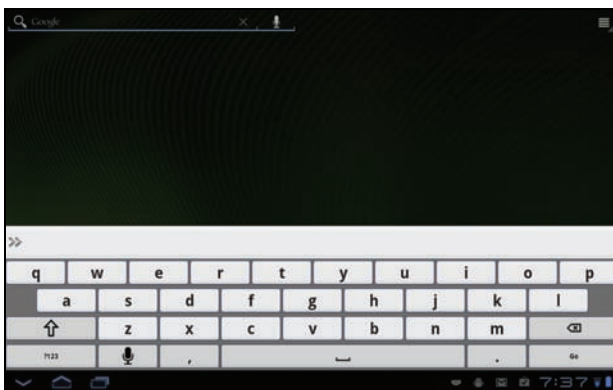

Tap the **?123** button to see numbers and special characters, and then tap the **ALT** key to see more options. Tap and hold a key to select alternative characters (if available), such as letters with accents.

Additional keys vary depending on the type of text you enter. E.g. a key to add a smiley is available when typing a text message. Like other keys, tap and hold to see if additional options are available.

## Text assistance

The standard XT9 keyboard has various features that assist you to enter correct text. To use these features, tap the **Keyboard status** icon; this will open a menu

listing the text input methods available on your tablet. Tap the settings icon next to the **XT9 Text Input** entry.

Function	Description
Languages and settings	Set the languages that will be available. If you have selected more than one keyboard language, tap the globe in the text prediction bar to cycle through the languages.
Preferences	Change your text input preferences.

## Editing text

You can select and edit text in certain applications, such as text you have entered in a text fields. Selected text can be cut or copied and later pasted within the same application, or to a different or across apps.



**Note:** Certain applications may not support text selection, or only support it in certain areas. Others applications offer specialized commands to select text that are only available in that application.

## Inserting text

1. Tap the text you want to select. If you can select this text, a cursor is inserted below the text.

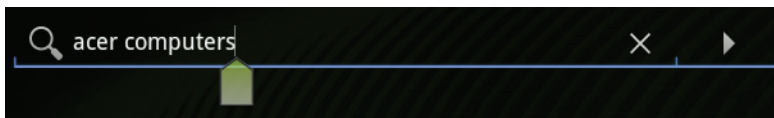

**Note:** The cursor indicates where text you type or paste will be inserted.

2. If the cursor is not in the desired position, simply drag it to the correct position  
If you previously copied (see below) text, a *Paste* button appears briefly above the cursor. Tap the button to paste the text.

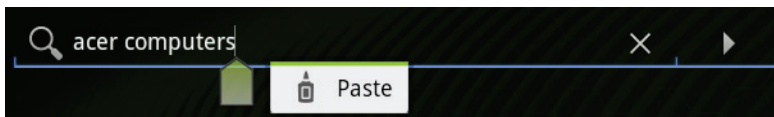

3. Modify the text: Type, paste or delete text.
4. Tap Enter on the keyboard, or tap the **Close Keyboard** button.

## Selecting text

To select text that you want to cut, copy, delete or replace:

1. Tap and hold the text or word you want to select.

The selected text is highlighted, with a tab at each end of the selection.

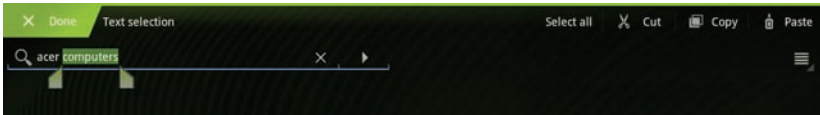

2. Drag either tab to expand or reduce the amount of selected text, or tap **Select all**.
3. To cut or copy the text, tap the **Cut** or **Copy** button.

# Connecting devices to your tablet

---

## Connecting to AC power

See "Charging your tablet" on page 12.

## Inserting a micro SD card (optional)

You may install a micro SD card to expand your device's storage space.

**Note:** Your tablet only supports microSD cards that use the FAT or FAT32 file system.

1. Open the card slot cover.
2. Insert the micro SD card as shown.
3. Replace the card slot cover.

Check card capacity in the **External SD card** section of **Apps > Settings > Storage**.

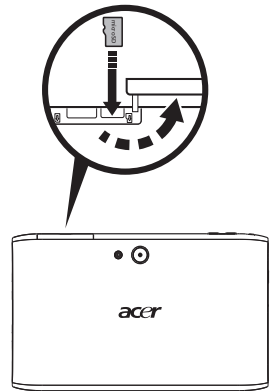

.....  
**Note:** Ensure that the micro SD card is inserted all the way into the card slot.  
.....

## Transferring files from a microSD card to your PC

Remove the card from the tablet and use a card reader or USB adapter to access the card as an external storage device.



.....  
**Note:** Check your tablet is not using the microSD card before removing it from the tablet.

Take care when removing the card, the slot is spring-loaded.  
.....

## Connecting to a PC as a USB storage device

Download and install the latest USB driver on your computer before connecting your tablet to the computer. Visit [www.acer.com/worldwide/support/download.htm](http://www.acer.com/worldwide/support/download.htm) for the latest driver.



This allows you to transfer your personal data to, or from, your PC, using your PC's file explorer.

Plug the micro USB connector to your tablet, and plug the other end of the USB cable into a USB port on your PC.

After a short delay, your tablet's internal memory will be visible as an external drive in your PC's file explorer.

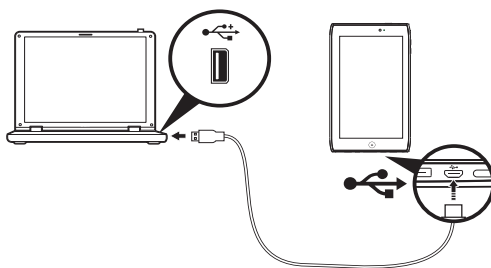

## Connecting a Bluetooth device

Only A2DP stereo headsets (without microphone) are supported. Please check for updates to the tablet's software which may add support for additional Bluetooth devices.

For Bluetooth settings, tap **Apps > Settings > Wireless & networks > Bluetooth settings**.

Tap **Find nearby devices** to scan for available devices.



.....  
**Note:** Please check for updates to the tablet's software that may add support for additional Bluetooth devices. Visit [www.acer.com/support](http://www.acer.com/support).  
.....

## Connecting to a television with HDMI

Connect a micro HDMI (Type D) cable to your tablet then plug the other end of the HDMI cable into a TV or monitor with an HDMI port.

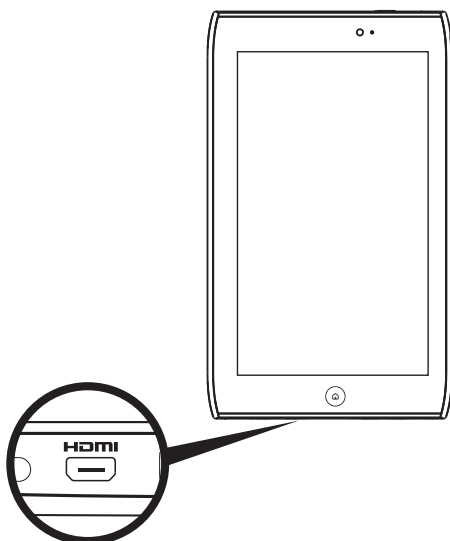

## Connecting to the dock (optional)

The optional dock holds your tablet and allows you to easily charge the battery with a single connection.

The dock provides extra connectors that replace your tablet's built-in connectors while it is docked. Please check the dock's specifications for the exact features provided.

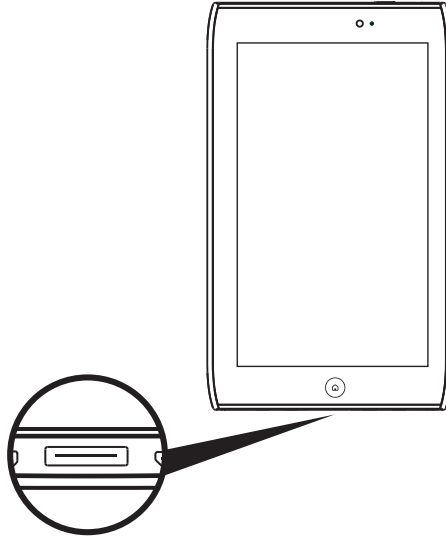

# Going Online

---

## Managing Wi-Fi Connections

If you did not connect to a Wi-Fi network when you first started your tablet, or want to connect to a new network, tap **Apps > Settings > Wireless & networks** to manage your connection settings. Alternatively, tap the Wi-Fi status icon in the bottom-right corner of the screen.

If Wi-Fi is not on, tap **Turn on Wi-Fi**, and wait for your tablet to detect nearby networks. Tap the name of your network and enter a security password, if needed.

## Browsing the Internet

In order to browse the Internet with your tablet, you must be connected to a the Internet.

### Using the browser

To start browsing, tap a bookmark from the bookmark widget on the Home screen, or open the Application menu and select **Browser**. To enter a website address, tap the address box at the top of the page. Enter the address using the keyboard and tap **Enter** or the Go arrow.

To view your browsing history, bookmarks or frequently visited sites, open the browser then tap the bookmark icon in the top-right corner.

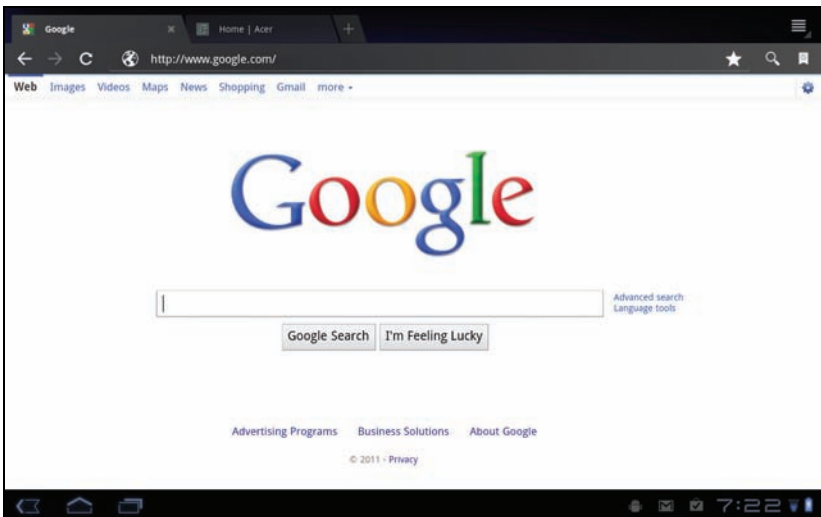

You may open multiple tabs. When a page is open, press the small tab with a plus sign. Simply tap one of the tabs across the top of the screen to switch pages.



Pinch to zoom in or out of pages. Tap and hold an item on a page to open a contextual menu.

## Voice Search

With voice actions, you can send emails, find directions to locations, search the Internet and even send a note to yourself using your voice. Tap the microphone on the Home screen or open **Voice Search** from the applications tab. When the **Speak now** prompt is displayed, state your command or query.

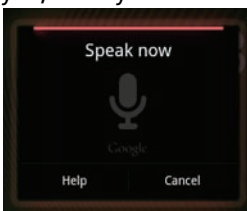

**Note:** Voice search is available only in some regions.

## Setting up Gmail (Google mail)

1. Make sure your tablet is connected to the Internet.
2. From the Applications menu tap **Gmail**.

If you did not enter an Gmail account address and password when you first started your tablet, follow the on screen instructions.



**Note:** You need to activate a Google account before you can use Gmail.

## Composing an email

1. Make sure your tablet is connected to the Internet.
2. Open the application menu and tap **Gmail**.
3. Press the **Menu** button and then tap **Compose**.
4. Enter the recipient's email address, the subject and message.
5. When you are finished composing your message, tap **Send**.

# Setting up the Email application

The Email application enables you to access email from most popular email providers. Most accounts can be set up in two steps. Open the application menu and then tap **Email** to start setting up your email access.

If necessary, enter your email address and tap **Manual setup** to enter the parameters manually. Tap **Next** to finish the setup process.

The combined inbox feature of your tablet allows you to view emails from multiple accounts in a single inbox.

## Online applications

Your tablet provides a variety of preinstalled applications. Many of these require some form of Internet access.

These applications may include:

- **Acer Sync:** Sync your data between your tablet, your computer and the Google servers.
- **SocialJogger:** View updates to your social networks in one location.
- **Maps:** Get easy-to-follow directions using Google Maps.
- **Talk\*:** Chat with your friends, with text, sound and video.
- **Navigation\*:** Turn-by-turn navigation with live traffic, multiple visible layers and text-to-speech take you where you want to go.
- **Latitude:** View where your friends are on Google Maps.
- **Places:** View places of interest and local businesses on Google Maps.
- **YouTube\*:** View the Most viewed and Most discussed video clips on YouTube.
- **LumiRead:** Download books from featured bookstores, and setup convenient links to your favorite ebook sites.
- **MusicA:** Let your tablet listen to music and access the MusicA database to find the track name and artist.



.....  
\* **Note:** Applications installed may vary according to your region.  
.....



# Acer SocialJogger

Acer SocialJogger combines your social network updates in one location, allowing you to quickly follow what your friends are doing across several platforms.

From the application menu, tap Acer SocialJogger to launch the program.

Select **Sign in** to enter your account information. When you are finished press **Start**.



Slide the disc, located on the right, up and down to cycle through the status updates.

Tap on a status to view more details and make a comment.

Tap the left and right arrows, located on the top, to cycle between the categories: My Page, Photos, Link and any added pages.

Tap the **Menu** button to access account settings, refresh the page, auto play, and add or remove custom pages.

# Adobe Flash Player

Adobe Flash Player is not installed on your tablet. If you want to use Flash content on in your browser, you can visit the Android Market (see below) to easily download and install Adobe Flash Player.

# Android Market



.....  
**Note:** The Android Market may not be available in all countries and regions.  
.....



.....  
**Note:** You need to activate a Google account before you can use the Android Market.  
.....

Tap **Market** from the home screen or application menu to open the *Android Market*. Here you can obtain a variety of add-on programs and applications to enhance the functionality of your tablet.

You may also browse for books that you may read with LumiRead or another reader application.

The first time you access the Android Market, you must read and accept the Terms of Service.

You can browse the market by category or tap the search icon to search for a specific application.

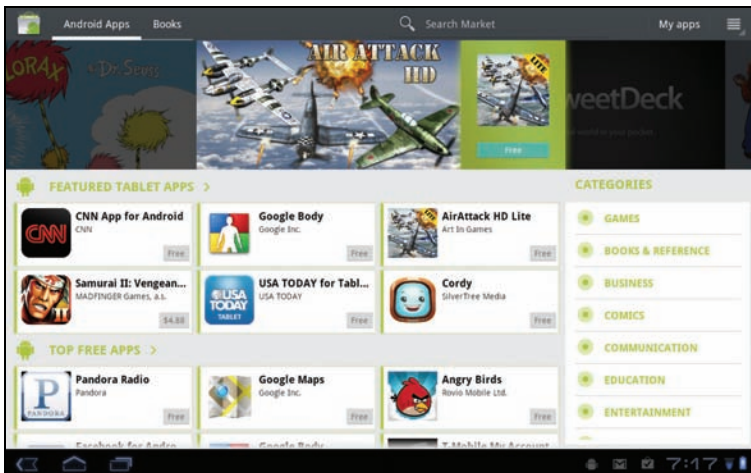

Once you have selected an application, tap the **DOWNLOAD** button to download and install the application. You will be told which services (contact information, wireless access, GPS, etc.) the application requires access in order to function correctly. If none of these services seem unusual, tap **OK** to proceed with the installation.

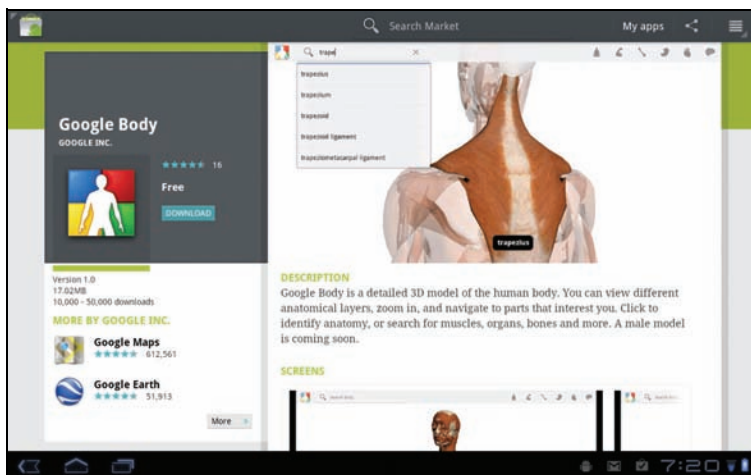

You may keep track of the download progress from the status area.



**Important:** Some applications may require payment before you can download them. You will need to have a Google Checkout account in order to pay for these applications.

## Using downloaded applications

Once you've downloaded and installed an application, you may find it in the **My apps** or **All** sections of the Application menu.

Certain applications also provide widgets, or only provide a widget (with no application icon). Widgets can be found in the Widget section when personalizing your Home screen. See "Personalizing the Home screen" on page 20.

## Uninstalling downloaded applications

Once you've downloaded and installed an application, you may uninstall the application by pressing and holding the application icon and dragging it to the trash can located on the top-right corner of the screen.

Alternatively, you can go to **Settings** from the application menu and select **Applications > Manage applications**. Tap the application you wish to uninstall, tap **Uninstall** and confirm the uninstall.

## Google Talk



**Note:** Google Talk may not be available in all countries and regions.



**Note:** You need to activate a Google account before you can use Google Talk.

Tap **Talk** from application menu to open Google Talk. Here you can see a list of your contacts connected to Google Talk services. Tap on a contact to open a chat session. After you have connected, you can open a video chat session.

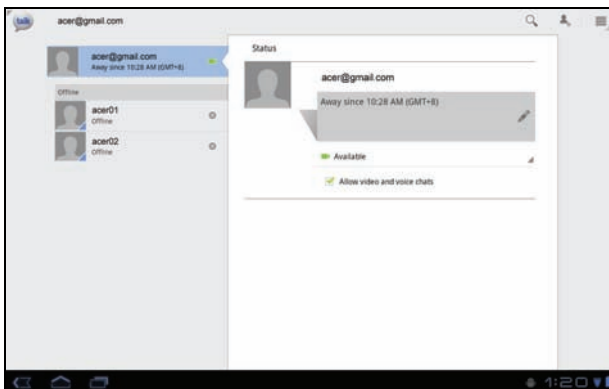

Use the front-facing camera so the person you call can see you while you can see them on the screen; hold your tablet in portrait mode to improve the camera position.



# Acer content folders

---

Your tablet includes content folders that allow you to easily organize and access your favorite applications.

Choose one of the four categories on the Home screen or application menu: **eReading**, **Games**, **Multimedia** or **Social**.

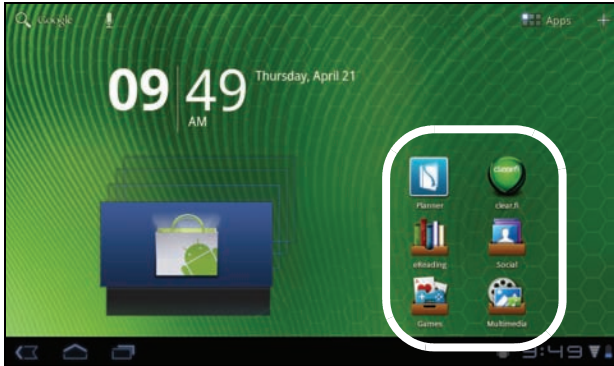

Tap the shortcut to open a screen containing applications from that category.

## Using the content folders

Each category already contains shortcuts to essential applications. Simply tap a shortcut to open the application. The shelves along the bottom of the screen may contain links to portals that allow you to download related applications from trustworthy publishers.

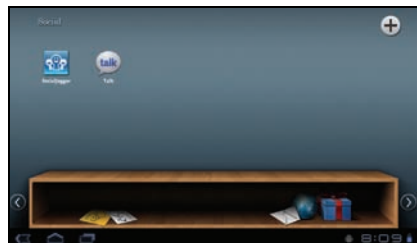
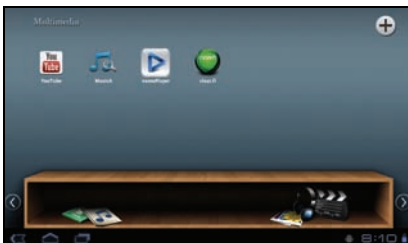
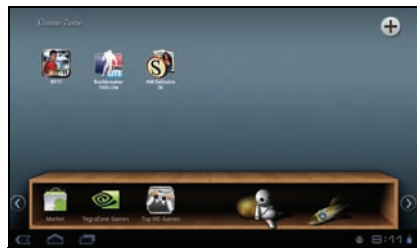
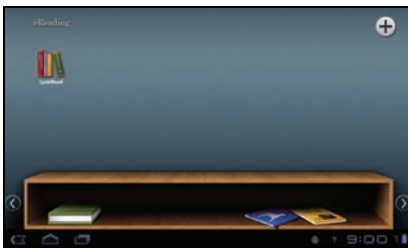

## Selecting a content folder

The folder shortcuts on the home screen or Application menu give you direct access to any of the four categories. If you have opened a category, you can easily change category by swiping the screen to the left or right.

## Adding

You can add applications to any content folder. Tap the **Plus** sign in the top right corner and select one or more applications from the list. Tap **OK** to add shortcuts for the selected applications.

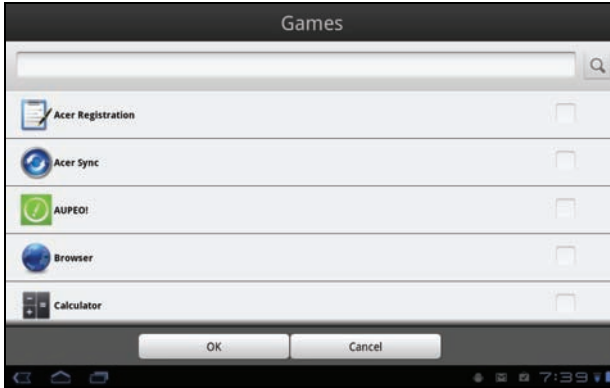

You may view up to twenty shortcuts on a single screen. If you add more than twenty shortcuts, swipe the screen up to see additional shortcuts.

## Moving or removing

Tap and hold an item to select it. Drag it to a new position to change the order, or to the trash can in the top right corner to remove the shortcut from the screen.



.....  
Note: Certain pre-loaded applications may not be removed.  
.....

# Playing music and video

---

## Multimedia playback

Your tablet comes supplied with a variety of programs that you can use to enjoy multimedia content.

### Acer clear.fi

With Acer clear.fi, you can browse and stream remote multimedia content from connected devices on your tablet.



.....  
**Note:** You must be connected to a wireless network.  
.....



.....  
**Note:** When using an external USB storage device to access media files, the device may not be recognized for a few minutes.  
.....

Tap **clear.fi**.



*Acer clear.fi* will automatically detect devices that are connected to a wireless network and display them at the bottom of the screen, with your tablet as the default device on the leftmost corner. Tap any of the connected devices and then tap **Photo**, **Video**, or **Music** to browse media files on that connected device.

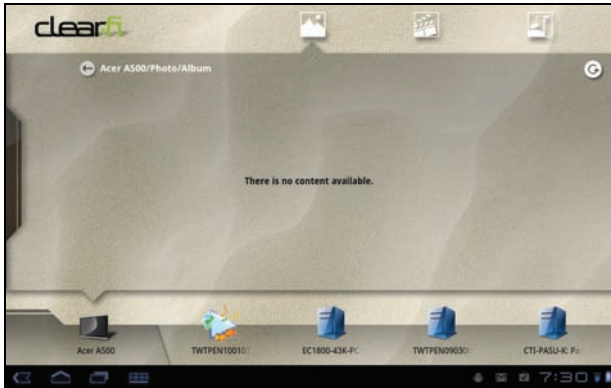

Drag the bar on left side for more viewing options.

## clear.fi photos

Tap the photo album to view the thumbnails. Tap and hold an album or photo thumbnail to view the menu panel.

You can view photos found on any of the connected devices and save them.

Tap and hold a photo thumbnail, then tap and hold any of the connected device showing an arrow. Select **Play** or **Save**.

To upload a photo to Facebook, or Flickr via Acer Photo Uploader, or to paired devices using Bluetooth, tap and hold a photo thumbnail, then tap **Share**.

## clear.fi videos

Tap a folder under Collection to view the thumbnails. Tap and hold a folder or video thumbnail to view the menu panel.

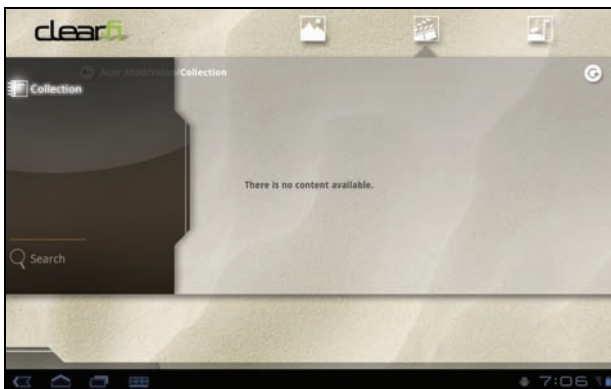

You can play videos found on any of the connected devices and save them. Tap and hold a video thumbnail, then tap and hold any of the connected device showing an arrow. Select **Play** or **Save**.