



AYHearing Aid Compatibility (HAC) RF Emissions Test Report

APPLICANT : Acer Incorporated
EQUIPMENT : Smart HandHeld _ Android
BRAND NAME : Acer
MODEL NAME : S100
FCC ID : HLZSHS100
STANDARD : FCC 47 CFR §20.19
ANSI C63.19-2007
M CATEGORY : M3

The product was received on Sep. 22, 2009 and completely tested on Oct. 05, 2009. We, SPORTON INTERNATIONAL INC., would like to declare that the tested sample has been evaluated in accordance with the procedures and shown the compliance with the applicable technical standards.

The test results in this report apply exclusively to the tested model / sample. Without written approval of SPORTON INTERNATIONAL INC., the test report shall not be reproduced except in full.

Reviewed by:

Roy Wu / Manager



SPORTON INTERNATIONAL INC.

No. 52, Hwa Ya 1st Rd., Hwa Ya Technology Park, Kwei-Shan Hsiang, Tao Yuan Hsien, Taiwan, R.O.C.



Table of Contents

Revision History..... 3
1. Statement of Compliance..... 4
2. Administration Data..... 5
2.1 Testing Laboratory..... 5
2.2 Applicant..... 5
2.3 Manufacturer..... 5
2.4 Application Details..... 5
3. General Information..... 6
3.1 Description of Device Under Test (DUT)..... 6
3.2 Product Photos..... 7
3.3 Applied Standards..... 8
3.4 Test Conditions..... 9
3.4.1 Ambient Condition..... 9
3.4.2 Test Configuration..... 9
4. Hearing Aid Compliance (HAC).....10
4.1 Introduction.....10
5. HAC RF Emission Measurement Setup.....11
5.1 E-Field and H-Field Probe System.....12
5.1.1 E-Field Probe Specification.....12
5.1.2 H-Field Probe Description.....12
5.1.3 Probe Tip Description.....13
5.2 DATA Acquisition Electronics (DAE).....14
5.3 Robot.....15
5.4 Measurement Server.....15
5.5 Phone Positioner.....16
5.6 Test Arch Phantom.....16
5.7 Data Storage and Evaluation.....17
5.7.1 Data Storage.....17
5.7.2 Data Evaluation.....17
5.8 Test Equipment List.....19
6. Uncertainty Assessment.....20
7. HAC RF Emission Measurement Evaluation.....22
7.1 Purpose of System Performance Check.....22
7.2 System Setup.....22
7.3 Validation Results.....23
8. RF Field Probe Modulation Factor.....24
9. Description for DUT Testing Position.....28
10. RF Emissions Test Procedure.....30
11. HAC RF Emission Test Results.....31
11.1 Conducted Power (Unit: dBm).....31
11.2 E-Field Emission.....31
11.3 H-Field Emission.....32
12. References.....33
Appendix A. Plots of System Performance Check
Appendix B. Plots of RF Emission Measurement
Appendix C. DASy Calibration Certificate
Appendix D. Product Photos
Appendix E. Test Setup Photos



1. Statement of Compliance

The maximum results of RF Emission of Hearing Aid Compliance (HAC) were found during testing for the **Acer Incorporated Smart HandHeld _ Android Acer S100**, which are as follows (with expanded uncertainty $\pm 30.4\%$ for E-field and $\pm 21.6\%$ for H-field):

Band	HAC RF Emission Test Result		M Rating
GSM850	E-Field (V/m)	176.2	M3
	H-Field (A/m)	0.218	M4
GSM1900	E-Field (V/m)	82.8	M3
	H-Field (A/m)	0.132	M4
WCDMA Band V	E-Field (V/m)	49.7	M4
	H-Field (A/m)	0.084	M4
WCDMA Band II	E-Field (V/m)	37	M4
	H-Field (A/m)	0.063	M4

They are in compliance with HAC limits specified in guidelines FCC 47 CFR §20.19 and ANSI Standard ANSI C63.19 for HAC Rated category M3.

Results Summary : M Category = M3 (ANSI C63.19-2007)



2. Administration Data

2.1 Testing Laboratory

Test Site	SPORTON INTERNATIONAL INC.
Test Site Location	No. 52, Hwa Ya 1 st Rd., Hwa Ya Technology Park, Kwei-Shan Hsiang, Tao Yuan Hsien, Taiwan, R.O.C. TEL: +886-3-327-3456 FAX: +886-3-328-4978
Test Site No.	Sporton Site No. : SAR01-HY ; SAR02-HY

2.2 Applicant

Company Name	Acer Incorporated
Address	8F., No. 88, Sec. 1, Hsin Tai Wu Rd., Hsichih, Taipei Hsien 221, Taiwan

2.3 Manufacturer

Company Name	Compal Communication (Nanjing)
Address	Nanjing Jingning Export Processing Zone (South Area) No. 68-2 Suyuan Street

2.4 Application Details

Date of Receipt of Application	Sep. 22, 2009
Date of Start during the Test	Sep. 25, 2009
Date of End during the Test	Oct. 05, 2009



3. General Information

3.1 Description of Device Under Test (DUT)

Product Feature & Specification	
DUT Type	Smart HandHeld _ Android
Brand Name	Acer
Model Name	S100
FCC ID	HLZSHS100
Tx Frequency	GSM850 : 824 MHz ~ 849 MHz GSM1900 : 1850 MHz ~ 1910 MHz WCDMA Band V : 824 MHz ~ 849 MHz WCDMA Band II : 1850 MHz ~ 1910 MHz
Rx Frequency	GSM850 : 869 MHz ~ 894 MHz GSM1900 : 1930 MHz ~ 1990 MHz WCDMA Band V : 869 MHz ~ 894 MHz WCDMA Band II : 1930 MHz ~ 1990 MHz
Maximum Output Power to Antenna	GSM850 : 32.09 dBm GSM1900 : 29.26 dBm WCDMA Band V : 22.79 dBm WCDMA Band II : 22.85 dBm
Antenna Type	Fixed Internal Antenna
HW Version	1.0
SW Version	Modem : A1-00.18.07 OS : Donut.eng.poseng.20090907.201329
Type of Modulation	GSM : GMSK WCDMA : QPSK
DUT Stage	Identical Prototype

List of Accessory:

Specification of Accessory		
AC Adapter 1	Brand Name	PHIHONG
	Model Name	PSAC05R-050
	Part Number	AP.0050P.015
	Power Rating	I/P:100-240Vac, 50-60Hz, 300mA, 12-18VA; O/P: 5Vdc, 1A
	DC Power Cord Type	1.5 meter shielded cable without ferrite core
AC Adapter 2	Brand Name	PHIHONG
	Model Name	PSAC05R-050
	Part Number	AP.0050P.008
	Power Rating	I/P:100-240Vac, 50-60Hz, 300mA, 12-18VA; O/P: 5Vdc, 1A
	DC Power Cord Type	1.5 meter non-shielded cable without ferrite core
Battery	Brand Name	Acer
	Model Name	A7BTA020F
	Power Rating	3.7Vdc, 1350mAh, 4.995Wh
	Type	Li-ion
Earphone 1	Brand Name	Merry
	Model Name	EMC292-003-01
	Signal Line Type	1.6 meter non-shielded cable without ferrite core
Earphone 2	Brand Name	KINGSTATE
	Model Name	KJAH4028AENCB
	Signal Line Type	1.6 meter non-shielded cable without ferrite core
USB Cable 1	Brand Name	Golden Bridge
	Model Name	AS51-09030018
	Signal Line Type	1.0 meter non-shielded cable without ferrite core
USB Cable 2	Brand Name	PHIHONG
	Model Name	DCM1000(AI-H)
	Signal Line Type	1.0 meter non-shielded cable without ferrite core
LCD Panel	Brand Name	AUO
	Model Name	H353VL01 V2

Remark: The above DUT's information was declared by manufacturer. Please refer to the specifications or user's manual for more detailed description.

3.2 Product Photos

Refer to Appendix D.



3.3 Applied Standards

The ANSI Standard ANSI C63.19-2007 represents performance requirements for acceptable interoperability of hearing aids with wireless communications devices. When these parameters are met, a hearing aid operates acceptably in close proximity to a wireless communications device.

The following AWF factors shall be used for the standard transmission protocols:

Standard	Technology	AWF (dB)
TIA/EIA/IS-2000	CDMA	0
TIA/EIA-136	TDMA (50 Hz)	0
J-STD-007	GSM (217)	-5
T1/T1P1/3GPP	UMTS (WCDMA)	0
iDENTM	TDMA (22 and 11 Hz)	0

Table 3.1 Articulation Weighting Factor (AWF)

Category	Telephone RF Parameters			
	Near Field	AWF	E-Field Emissions	H-Field Emissions
< 960 MHz				
Category M1		0	631.0 – 1122.0 V/m	1.91 – 3.39 A/m
		-5	473.2 – 841.4 V/m	1.43 – 2.54 A/m
Category M2		0	354.8 – 631.0 V/m	1.07 – 1.91 A/m
		-5	266.1 – 473.2 V/m	0.80 – 1.43 A/m
Category M3		0	199.5 – 354.8 V/m	0.6 – 1.07 A/m
		-5	149.6 – 266.1 V/m	0.45 – 0.80 A/m
Category M4		0	< 199.5 V/m	< 0.60 A/m
		-5	< 149.6 V/m	< 0.45 A/m
> 960 MHz				
Category M1		0	199.5 – 354.8 V/m	0.60 – 1.07 A/m
		-5	149.6 – 266.1 V/m	0.45 – 0.80 A/m
Category M2		0	112.2 – 199.5 V/m	0.34 – 0.60 A/m
		-5	84.1 – 149.6 V/m	0.25 – 0.45 A/m
Category M3		0	63.1 – 112.2 V/m	0.19 – 0.34 A/m
		-5	47.3 – 84.1 V/m	0.14 – 0.25 A/m
Category M4		0	< 63.1 V/m	< 0.19 A/m
		-5	< 47.3 V/m	< 0.14 A/m

Table 3.2 Telephone near-field categories in linear units



3.4 Test Conditions

3.4.1 Ambient Condition

Ambient Temperature	20 to 24 °C
Humidity	< 60 %

3.4.2 Test Configuration

The device was controlled by using a base station emulator R&S CMU200. Communication between the device and the emulator was established by air link. Measurements were performed on the low, middle and high channels of both bands. The DUT was set from the emulator to radiate maximum output power during all tests.



4. Hearing Aid Compliance (HAC)

4.1 Introduction

The federal communication commission (FCC) adopted ANSI C63.19 as HAC test standard.

5. HAC RF Emission Measurement Setup

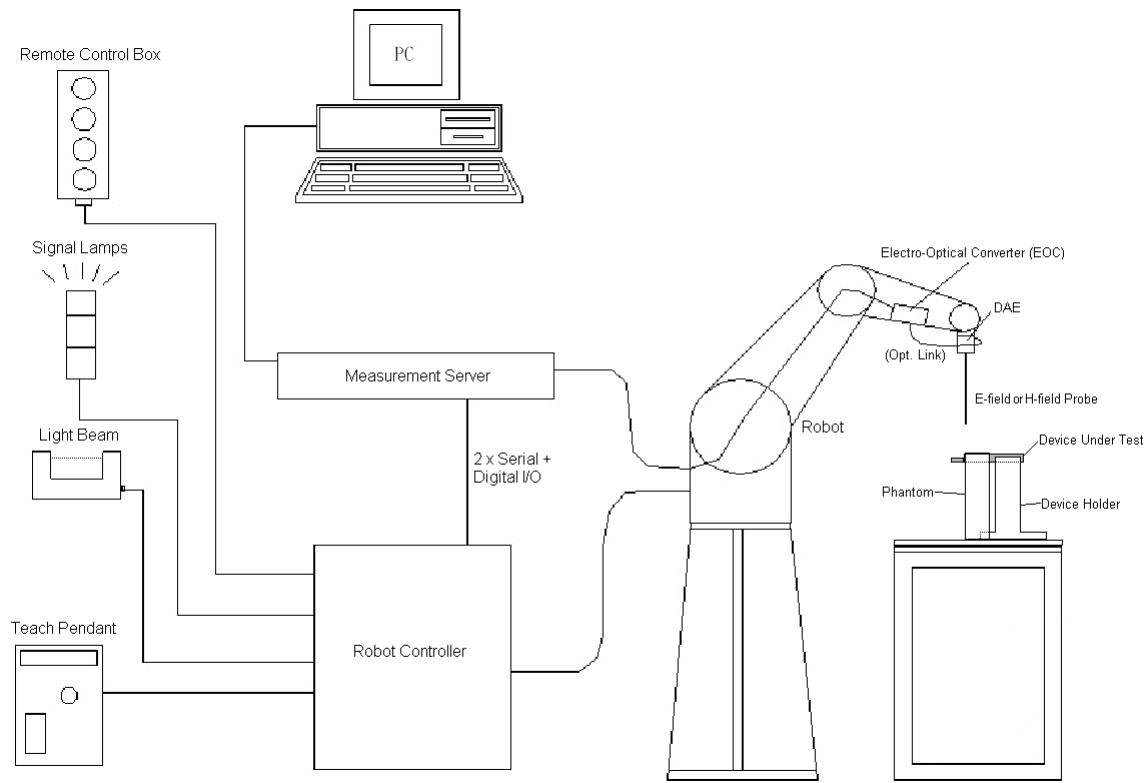

Fig 5.1 SPEAG DASY4 or DASY5 System Configurations

The DASY4 or DASY5 system for performance compliance tests is illustrated above graphically. This system consists of the following items:

- A standard high precision 6-axis robot with controller, a teach pendant and software
- A data acquisition electronic (DAE) attached to the robot arm extension
- A dosimetric probe equipped with an optical surface detector system
- The electro-optical converter (ECO) performs the conversion between optical and electrical signals
- A measurement server performs the time critical tasks such as signal filtering, control of the robot operation and fast movement interrupts.
- A probe alignment unit which improves the accuracy of the probe positioning
- A computer operating Windows XP
- DASY4 or DASY5 software
- Remote control with teach pendant and additional circuitry for robot safety such as warning lamps, etc.
- The SAM twin phantom
- A device holder
- Tissue simulating liquid
- Dipole for evaluating the proper functioning of the system

Some of the components are described in details in the following sub-sections.

5.1 E-Field and H-Field Probe System

The HAC measurement is conducted with the dosimetric probe ER3DV6 and H3DV6 (manufactured by SPEAG). The probe is specially designed and calibrated. This probe has a built in optical surface detection system to prevent from collision with DUT.

5.1.1 E-Field Probe Specification

<ER3DV6>

Construction	One dipole parallel, two dipoles normal to probe axis Built-in shielding against static charges
Calibration	In air from 100 MHz to 3.0 GHz (absolute accuracy $\pm 6.0\%$, $k=2$)
Frequency	100 MHz to 6 GHz; Linearity: ± 2.0 dB (100 MHz to 3 GHz)
Directivity	± 0.2 dB in air (rotation around probe axis) ± 0.4 dB in air (rotation normal to probe axis)
Dynamic Range	2 V/m to 1000 V/m (M3 or better device readings fall well below diode compression point)
Linearity	± 0.2 dB
Dimensions	Overall length: 330 mm (Tip: 16 mm) Tip diameter: 8 mm (Body: 12 mm) Distance from probe tip to dipole centers: 2.5 mm



Fig 5.2 Photo of E-field Probe

5.1.2 H-Field Probe Description

<H3DV6>

Construction	Three concentric loop sensors with 3.8 mm loop diameters Resistively loaded detector diodes for linear response Built-in shielding against static charges
Frequency	200 MHz to 3 GHz (absolute accuracy $\pm 6.0\%$, $k=2$); Output linearized
Directivity	± 0.25 dB (spherical isotropy error)
Dynamic Range	10 m A/m to 2 A/m at 1 GHz (M3 or better device readings fall well below diode compression point)
Dimensions	Overall length: 330 mm (Tip: 40 mm) Tip diameter: 6 mm (Body: 12 mm) Distance from probe tip to dipole centers: 3 mm
E-Field Interference	< 10% at 3 GHz (for plane wave)



Fig 5.3 Photo of H-field Probe

5.1.3 Probe Tip Description

HAC field measurements take place in the close near field with high gradients. Increasing the measuring distance from the source will generally decrease the measured field values (in case of the validation dipole approx. 10%/per mm).

Magnetic field sensors are measuring the integral of the H-field across their sensor area surrounded by the loop. They are calibrated in a precise, homogeneous field. When measuring a gradient field, the result will be very close to the field in the center of the loop which is equivalent to the value of a homogeneous field equivalent to the center value. But it will be different from the field at the field at the border of the loop.

Consequently, two sensors with different loop diameters – both calibrated ideally – would give different results when measuring from the edge of the probe sensor elements. The behavior for electrically small E-field sensors is equivalent. See below for distance plots from a WD which show the conservative nature of field readings at the probe element center vs. measurements at the sensor end:

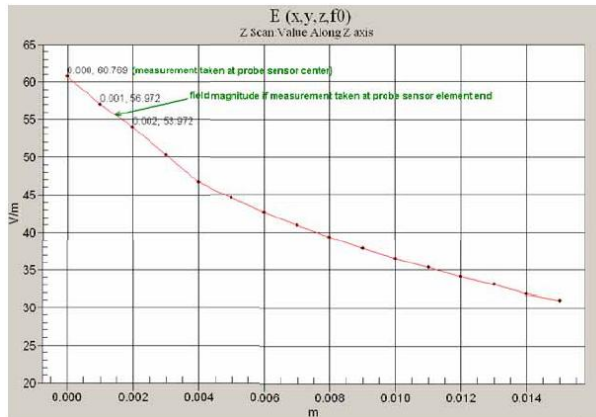

Fig 5.4 Z-Axis Scan at maximum point above a typical wireless device for E-field

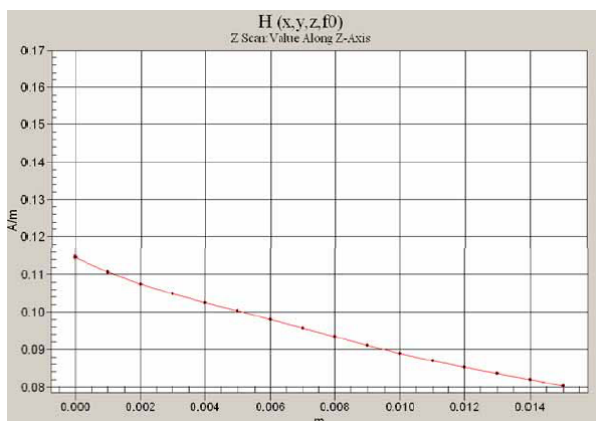

Fig 5.5 Z-Axis Scan at maximum point above a typical wireless device for H-field

The magnetic field loops of the H3D probes are concentric, with the center 3mm from the tip for H3DV6. Their radius is 1.9 mm.

The electric field probes have a more irregular internal geometry because it is physically not possible to have the 3 orthogonal sensors situated with the same center. The effect of the different sensor centers is accounted for in the HAC uncertainty budget ("sensor displacement"). Their geometric center is at 2.5 mm from the tip, and the element ends are 1.1 mm closer to the tip.

Where:

Peak Field = Peak field (in dB V/m or dB A/m)

Raw = Raw field measurement from the measurement system (in V/m or A/m).

PMF = Probe Modulation Factor (in Linear units). See Chapter 8 of test report.

5.2 DATA Acquisition Electronics (DAE)

The data acquisition electronics (DAE) consists of a highly sensitive electrometer-grade preamplifier with auto-zeroing, a channel and gain-switching multiplexer, a fast 16 bit AD-converter and a command decoder and control logic unit. Transmission to the measurement server is accomplished through an optical downlink for data and status information as well as an optical uplink for commands and the clock.

The input impedance of the DAE is 200 MOhm; the inputs are symmetrical and floating. Common mode rejection is above 80 dB.



Fig 5.6 Photo of DAE

5.3 Robot

The SPEAG DASY system uses the high precision robots (DASY4: RX90BL; DASY5: TX90XL) type from Stäubli SA (France). For the 6-axis controller system, the robot controller version (DASY4: CS7MB; DASY5: CS8c) from Stäubli is used. The Stäubli robot series have many features that are important for our application:

- High precision (repeatability ± 0.035 mm)
- High reliability (industrial design)
- Jerk-free straight movements
- Low ELF interference (the closed metallic construction shields against motor control fields)
- 6-axis controller

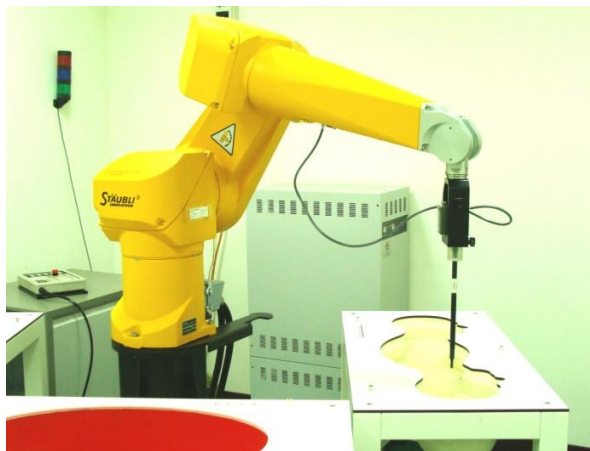

Fig 5.7 Photo of DASY4



Fig 5.8 Photo of DASY5

5.4 Measurement Server

The measurement server is based on a PC/104 CPU board with CPU (DASY4: 166 MHz, Intel Pentium; DASY5: 400 MHz, Intel Celeron), chipdisk (DASY4: 32 MB; DASY5: 128 MB), RAM (DASY4: 64 MB, DASY5: 128 MB). The necessary circuits for communication with the DAE electronic box, as well as the 16 bit AD converter system for optical detection and digital I/O interface are contained on the DASY I/O board, which is directly connected to the PC/104 bus of the CPU board.

The measurement server performs all the real-time data evaluation for field measurements and surface detection, controls robot movements and handles safety operations.



Fig 5.9 Photo of Server for DASY4



Fig 5.10 Photo of Server for DASY5

5.5 Phone Positioner

The phone positioner shown in Fig. 5.11 is used to adjust DUT to the suitable position.



Fig 5.11 Phone Positioner

5.6 Test Arch Phantom

<p>Construction :</p>	<p>Enables easy and well defined positioning of the phone and validation dipoles as well as simple teaching of the robot.</p>	
<p>Dimensions :</p>	<p>370 x 370 x 370 mm</p>	

Fig 5.12 Photo of Arch Phantom



5.7 Data Storage and Evaluation

5.7.1 Data Storage

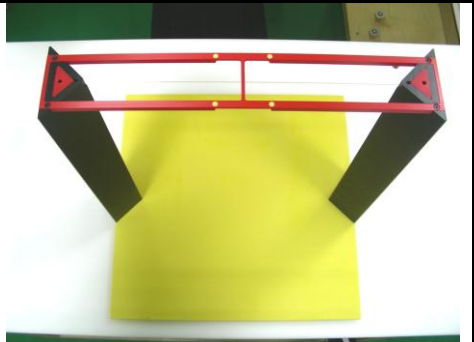
The DASYS software stores the assessed data from the data acquisition electronics as raw data (in microvolt readings from the probe sensors), together with all the necessary software parameters for the data evaluation (probe calibration data, and device frequency and modulation data) in measurement files. The post-processing software evaluates the desired unit and format for output each time the data is visualized or exported. This allows verification of the complete software setup even after the measurement and allows correction of erroneous parameter settings.

5.7.2 Data Evaluation

The DASYS post-processing software (SEMCAD) automatically executes the following procedures to calculate the field units from the microvolt readings at the probe connector. The parameters used in the evaluation are stored in the configuration modules of the software :

Probe parameters :	- Sensitivity	Norm _i , a _{i0} , a _{i1} , a _{i2}
	- Conversion factor	ConvF _i
	- Diode compression point	dcp _i
Device parameters :	- Frequency	f
	- Crest factor	cf
Media parameters :	- Conductivity	σ
	- Density	ρ

These parameters must be set correctly in the software. They can be found in the component documents or they can be imported into the software from the configuration files issued for the DASYS components. In the direct measuring mode of the multi-meter option, the parameters of the actual system setup are used. In the scan visualization and export modes, the parameters stored in the corresponding document files are used.

The first step of the evaluation is a linearization of the filtered input signal to account for the compression characteristics of the detector diode. The compensation depends on the input signal, the diode type and the DC-transmission factor from the diode to the evaluation electronics. If the exciting field is pulsed, the crest factor of the signal must be known to correctly compensate for peak power. The formula for each channel can be given as :

V_i = U_i + U_i^2 * (cf / dcp_i)

- with V_i = compensated signal of channel i, (i = x, y, z)
- U_i = input signal of channel i, (i = x, y, z)
- cf = crest factor of exciting field (DASY parameter)
- dcp_i = diode compression point (DASY parameter)



From the compensated input signals, the primary field data for each channel can be evaluated :

$$\text{E-field Probes : } \mathbf{E}_i = \sqrt{\frac{V_i}{\text{Norm}_i \cdot \text{ConvF}}}$$

$$\text{H-field Probes : } \mathbf{H}_i = \sqrt{V_i} \cdot \frac{a_{i0} + a_{i1}f + a_{i2}f^2}{f}$$

- with V_i = compensated signal of channel i , ($i = x, y, z$)
- Norm_i = sensor sensitivity of channel i , ($i = x, y, z$), $\mu\text{V}/(\text{V}/\text{m})^2$ for E-field Probes
- ConvF = sensitivity enhancement in solution
- a_{ij} = sensor sensitivity factors for H-field probes
- f = carrier frequency [GHz]
- E_i = electric field strength of channel i in V/m
- H_i = magnetic field strength of channel i in A/m

The RSS value of the field components gives the total field strength (Hermitian magnitude) :

$$\mathbf{E}_{\text{tot}} = \sqrt{\mathbf{E}_x^2 + \mathbf{E}_y^2 + \mathbf{E}_z^2}$$

The primary field data are used to calculate the derived field units.

The measurement/integration time per point, as specified by the system manufacturer is > 500 ms. The signal response time is evaluated as the time required by the system to reach 90% of the expected final value after an on/off switch of the power source with an integration time of 500 ms and a probe response time of < 5 ms. In the current implementation, DASYS waits longer than 100 ms after having reached the grid point before starting a measurement, i.e., the response time uncertainty is negligible.

If the device under test does not emit a CW signal, the integration time applied to measure the electric field at a specific point may introduce additional uncertainties due to the discretization. The tolerances for the different systems had the worst-case of 2.6%.



5.8 Test Equipment List

Manufacturer	Name of Equipment	Type/Model	Serial Number	Calibration	
				Last Cal.	Due Date
SPEAG	Isotropic E-Field Probe	ER3DV6	2358	Jan. 14, 2009	Jan. 13, 2010
SPEAG	Isotropic H-Field Probe	H3DV6	6184	Jan. 19, 2009	Jan. 18, 2010
SPEAG	Audio Magnetic 1D Field Probe	AM1DV2	1038	Jan. 12, 2009	Jan. 11, 2010
SPEAG	Audio Magnetic Calibration Coil	AMCC	1049	NCR	NCR
SPEAG	Audio Measuring Instrument	AMMI	1041	NCR	NCR
SPEAG	835MHz Calibration Dipole	CD835V3	1017	Jul. 14, 2009	Jul. 13, 2011
SPEAG	1880MHz Calibration Dipole	CD1880V3	1036	Jul. 15, 2009	Jul. 14, 2011
SPEAG	2450MHz Calibration Dipole	CD2450V3	1037	Jul. 16, 2009	Jul. 15, 2011
SPEAG	Data Acquisition Electronics	DAE3	577	Aug. 24, 2009	Aug. 23, 2010
SPEAG	Data Acquisition Electronics	DAE4	778	Sep. 18, 2009	Sep. 17, 2010
SPEAG	Data Acquisition Electronics	DAE4	679	Jun. 23, 2009	Jun. 22, 2010
SPEAG	Test Arch Phantom	N/A	N/A	NCR	NCR
SPEAG	Phone Positoiner	N/A	N/A	NCR	NCR
Agilent	Wireless Communication Test Set	E5515C	MY48360820	Dec. 15, 2008	Dec. 14, 2010
Agilent	Wireless Communication Test Set	E5515C	GB46311322	Feb. 16, 2009	Feb. 15, 2011
R&S	Universal Radio Communication Tester	CMU200	105934	Nov. 11, 2008	Nov. 10, 2009
Agilent	Dual Directional Coupler	778D	50422	NCR	NCR
AR	Power Amplifier	5S1G4M2	0328767	NCR	NCR
R&S	Power Meter	NRVD	101394	Oct. 20, 2008	Oct. 19, 2009
R&S	Power Sensor	NRV-Z1	100130	Oct. 20, 2008	Oct. 19, 2009
R&S	Spectrum Analyzer	FSP7	101131	Mar. 17, 2009	Mar. 16, 2010

Table 5.1 Test Equipment List

6. Uncertainty Assessment

The component of uncertainty may generally be categorized according to the methods used to evaluate them. The evaluation of uncertainty by the statistical analysis of a series of observations is termed a Type A evaluation of uncertainty. The evaluation of uncertainty by means other than the statistical analysis of a series of observation is termed a Type B evaluation of uncertainty. Each component of uncertainty, however evaluated, is represented by an estimated standard deviation, termed standard uncertainty, which is determined by the positive square root of the estimated variance.

A Type A evaluation of standard uncertainty may be based on any valid statistical method for treating data. This includes calculating the standard deviation of the mean of a series of independent observations; using the method of least squares to fit a curve to the data in order to estimate the parameter of the curve and their standard deviations; or carrying out an analysis of variance in order to identify and quantify random effects in certain kinds of measurement.

A type B evaluation of standard uncertainty is typically based on scientific judgment using all of the relevant information available. These may include previous measurement data, experience and knowledge of the behavior and properties of relevant materials and instruments, manufacture’s specification, data provided in calibration reports and uncertainties assigned to reference data taken from handbooks. Broadly speaking, the uncertainty is either obtained from an outdoor source or obtained from an assumed distribution, such as the normal distribution, rectangular or triangular distributions indicated in Table 6.1.

Uncertainty Distributions	Normal	Rectangular	Triangular	U-Shape
Multi-plying Factor ^(a)	1/k ^(b)	1/√3	1/√6	1/√2

(a) standard uncertainty is determined as the product of the multiplying factor and the estimated range of variations in the measured quantity

(b) κ is the coverage factor

Table 6.1 Multiplying Factions for Various Distributions

The combined standard uncertainty of the measurement result represents the estimated standard deviation of the result. It is obtained by combining the individual standard uncertainties of both Type A and Type B evaluation using the usual “root-sum-squares” (RSS) methods of combining standard deviations by taking the positive square root of the estimated variances.

Expanded uncertainty is a measure of uncertainty that defines an interval about the measurement result within which the measured value is confidently believed to lie. It is obtained by multiplying the combined standard uncertainty by a coverage factor. Typically, the coverage factor ranges from 2 to 3. Using a coverage factor allows the true value of a measured quantity to be specified with a defined probability within the specified uncertainty range. For purpose of this document, a coverage factor two is used, which corresponds to confidence interval of about 95 %. The DASY uncertainty Budget is showed in Table 6.2.



Error Description	Uncertainty Value (±%)	Probability Distribution	Divisor	Ci (E)	Ci (H)	Standard Uncertainty (E)	Standard Uncertainty (H)
Measurement System							
Probe Calibration	5.1	Normal	1	1	1	± 5.1 %	± 5.1 %
Axial Isotropy	4.7	Rectangular	√3	1	1	± 2.7 %	± 2.7 %
Sensor Displacement	16.5	Rectangular	√3	1	0.145	± 9.5 %	± 1.4 %
Test Arch	7.2	Rectangular	√3	1	0	± 4.1 %	± 0.0 %
Linearity	4.7	Rectangular	√3	1	1	± 2.7 %	± 2.7 %
Scaling to Peak Envelope Power	0.0	Rectangular	√3	1	1	± 0.0 %	± 0.0 %
System Detection Limit	1.0	Rectangular	√3	1	1	± 0.6 %	± 0.6 %
Readout Electronics	0.3	Normal	1	1	1	± 0.3 %	± 0.3 %
Response Time	0.8	Rectangular	√3	1	1	± 0.5 %	± 0.5 %
Integration Time	2.6	Rectangular	√3	1	1	± 1.5 %	± 1.5 %
RF Ambient Conditions	3.0	Rectangular	√3	1	1	± 1.7 %	± 1.7 %
RF Reflections	12.0	Rectangular	√3	1	1	± 6.9 %	± 6.9 %
Probe Positioner	1.2	Rectangular	√3	1	0.67	± 0.7 %	± 0.5 %
Probe Positioning	4.7	Rectangular	√3	1	0.67	± 2.7 %	± 1.8 %
Extrap. and Interpolation	1.0	Rectangular	√3	1	1	± 0.6 %	± 0.6 %
Test Sample Related							
Device Positioning Vertical	4.7	Rectangular	√3	1	0.67	± 2.7 %	± 1.8 %
Device Positioning Lateral	1.0	Rectangular	√3	1	1	± 0.6 %	± 0.6 %
Device Holder and Phantom	2.4	Rectangular	√3	1	1	± 1.4 %	± 1.4 %
Power Drift	5.0	Rectangular	√3	1	1	± 2.9 %	± 2.9 %
Phantom and Setup Related							
Phantom Thickness	2.4	Rectangular	√3	1	0.67	± 1.4 %	± 0.9 %
Combined Standard Uncertainty						± 15.2 %	± 10.8 %
Coverage Factor for 95 %						K = 2	
Expanded Uncertainty						± 30.4 %	± 21.6 %

Table 6.2 Uncertainty Budget of DASYS

7. HAC RF Emission Measurement Evaluation

Each DASY system is equipped with one or more system validation kits. These units, together with the predefined measurement procedures within the DASY software, enable the user to conduct the system performance check and system validation. System validation kit includes a dipole, tripod holder to fix it underneath the test Arch and a corresponding distance holder.

7.1 Purpose of System Performance Check

The system performance check verifies that the system operates within its specifications. System and operator errors can be detected and corrected. It is recommended that the system performance check be performed prior to any usage of the system in order to guarantee reproducible results. The system performance check uses normal HAC measurements in a simplified setup with a well characterized source. This setup was selected to give a high sensitivity to all parameters that might fail or vary over time. The system check does not intend to replace the calibration of the components, but indicates situations where the system uncertainty is exceeded due to drift or failure.

7.2 System Setup

In the simplified setup for system evaluation, the DUT is replaced by a calibrated dipole and the power source is replaced by a continuous wave which comes from a signal generator. The calibrated dipole must be placed beneath the arch phantom. The equipment setup is shown below:

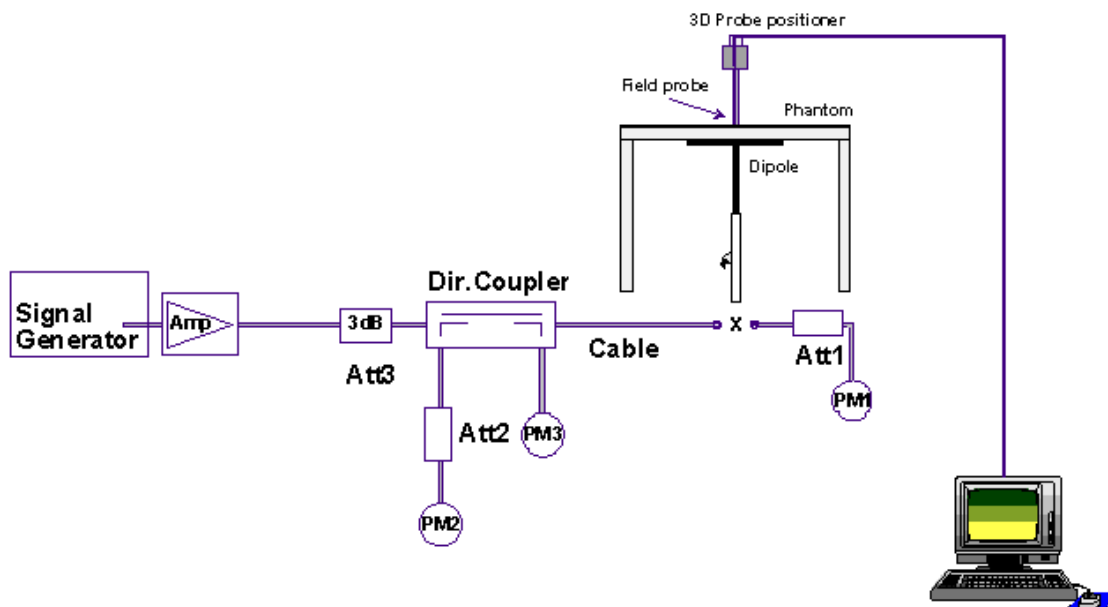

Fig. 7.1 System Setup of System Evaluation

1. Signal Generator
2. Amplifier
3. Directional Coupler
4. Power Meter
5. Calibrated Dipole

The output power on dipole port must be calibrated to 20dBm (100mW) before dipole is connected.

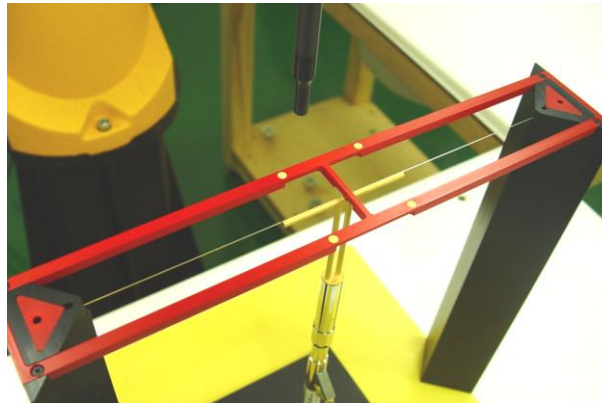

Fig 7.2 Dipole Setup

7.3 Validation Results

Comparing to the original E-field or H-field value provided by SPEAG, the validation data should be within its specification of 25 %. Table 7.1 shows the target value and measured value. The table below indicates the system performance check can meet the variation criterion and the plots can be referred to appendix A of this report.

Frequency (MHz)	Input Power (dBm)	Target Value (V/m)	E-Field 1 (V/m)	E-Field 2 (V/m)	Average Value (V/m)	Deviation (%)	Date
835	20	167.1	169.5	202.2	185.85	11.22	Oct. 02, 2009
1880	20	137.2	143.7	145.1	144.4	5.25	Sep. 25, 2009
1880	20	137.2	141.5	143.5	142.5	3.86	Oct. 02, 2009
Frequency (MHz)	Input Power (dBm)	Target Value (A/m)	H-Field (A/m)		Deviation (%)	Date	
835	20	0.457	0.452		-1.09	Oct. 05, 2009	
1880	20	0.474	0.482		1.69	Oct. 05, 2009	

Table 7.1 Test Results of System Validation

Note: Deviation = ((E or H-field Result) - (Target field)) / (Target field) * 100%

8. RF Field Probe Modulation Factor

A calibration shall be made of the modulation response of the probe and its instrumentation chain. This calibration shall be performed with the field probe, attached to the instrumentation that is to be used with it during the measurement. The response of the probe system to a CW field at the frequency(s) of interest is compared to its response to a modulated signal with equal peak amplitude. The field level of the test signals shall be more than 10 dB above the ambient level and the noise floor of the instrumentation being used. The ratio of the CW reading to that taken with a modulated field shall be applied to the readings taken of modulated fields of the specified type.

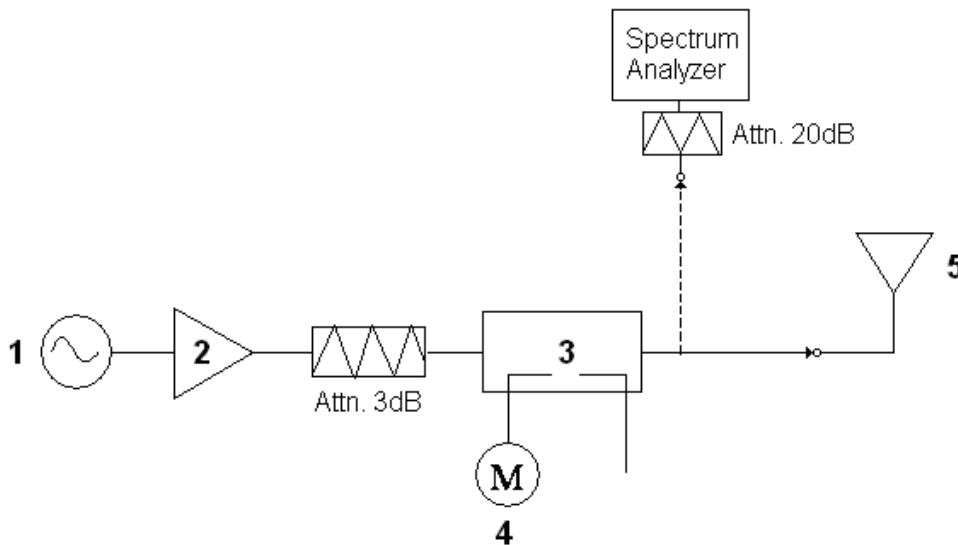

Fig. 8.1 System Calibration

This was done using the following procedure:

1. Fixing the probe in a set location relative to a field generating device.
2. Illuminate the probe with a CW signal at the intended measurement frequency.
3. Record the reading of the probe measurement system of the CW signal.
4. Determine the level of the CW signal being used to drive the field generating device.
5. Substitute a signal using the same modulation as that used by the intended WD for the CW signal.
6. Set the peak amplitude during transmission of the modulated signal to equal the amplitude of the CW signal.
7. Record the reading of the probe measurement system of the modulated signal.
8. The ratio of the CW to modulated signal reading is the modulation factor.
9. Repeat 2~8 steps at intended measurement frequency for both E and H field probe.



PMF Measurement Summary:

Frequency (MHz)	Functions	E-field	H-field	PMF	
		V/m	A/m	E-field	H-field
835	CW	661.0	1.796	-	-
835	AM 80%	416.0	1.450	1.59	1.24
835	GSM	251.0	1.197	2.63	1.50
1880	CW	464.0	1.523	-	-
1880	AM 80%	294.1	1.280	1.58	1.19
1880	GSM	171.9	1.190	2.70	1.28

Frequency (MHz)	Functions	E-field	H-field	PMF	
		V/m	A/m	E-field	H-field
835	CW	296.7	0.613	-	-
835	AM 80%	194.7	0.432	1.524	1.419
835	WCDMA	296.9	0.736	0.999	0.833
1880	CW	215.4	0.707	-	-
1880	AM 80%	150.5	0.603	1.431	1.172
1880	WCDMA	220.4	1.348	0.977	0.524



Zero span Spectrum Plots for RF Field Probe Modulation Factor

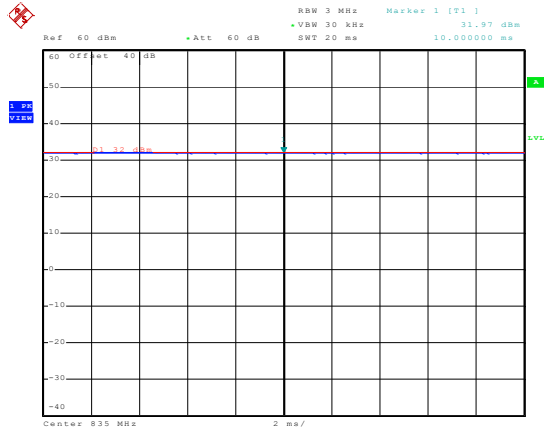

835MHz - CW

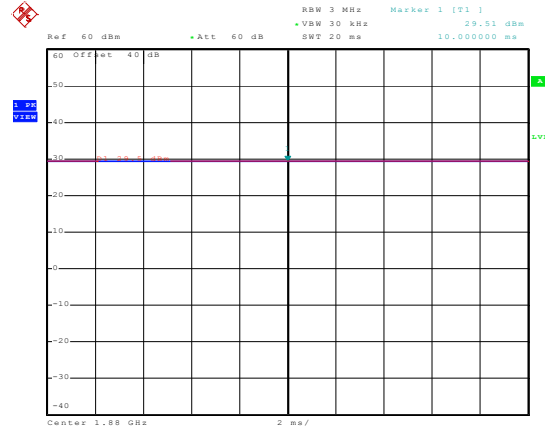

1880MHz - CW

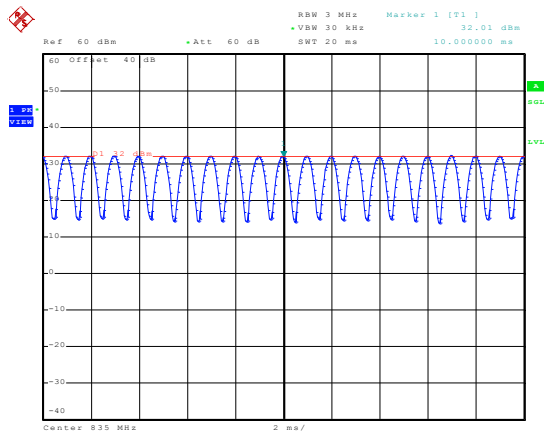

835MHz - 80% AM

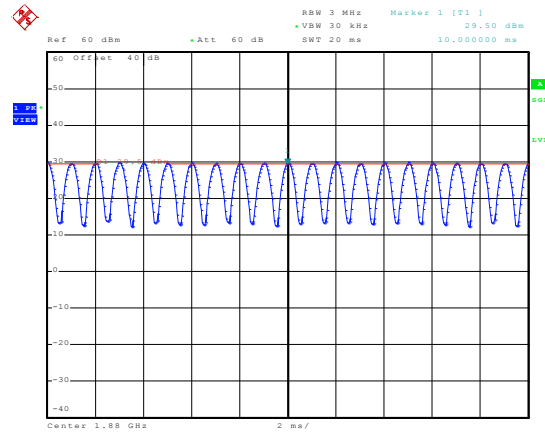

1880MHz - 80% AM

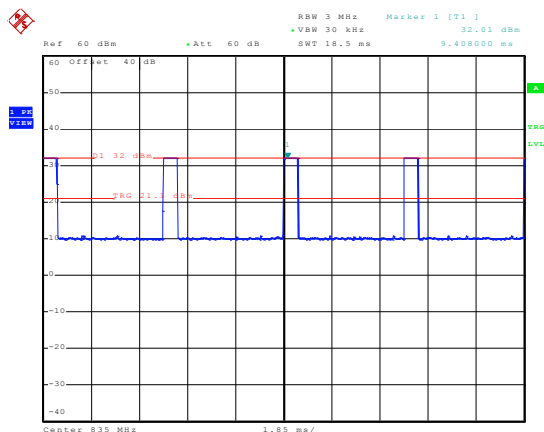

835MHz - GSM

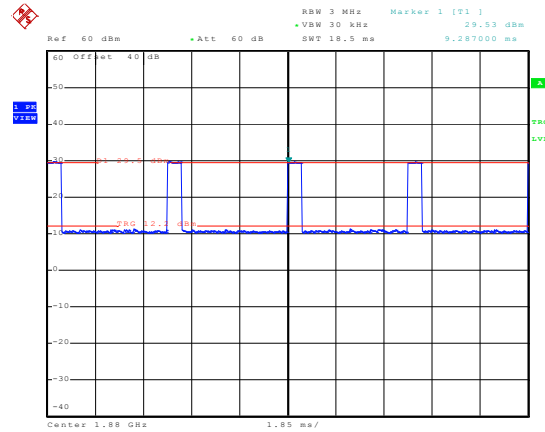

1880MHz - GSM

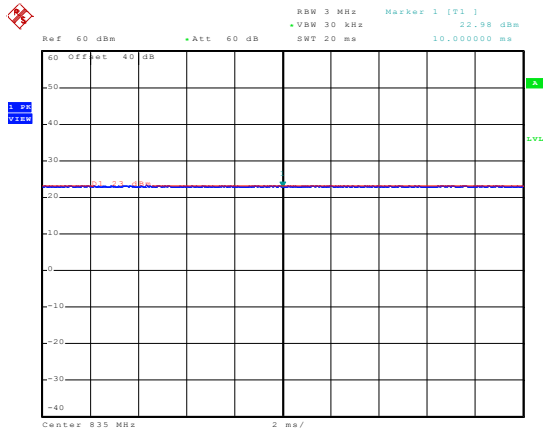

835MHz - CW

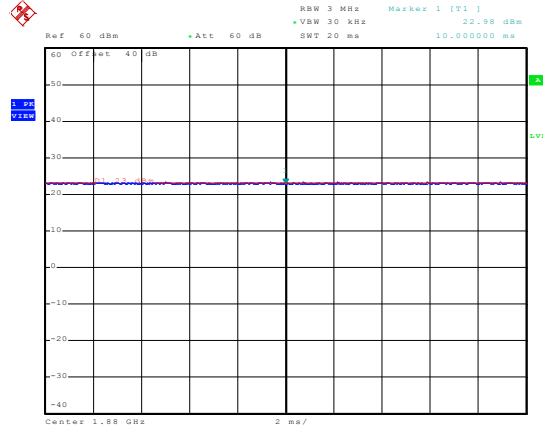

1880MHz - CW

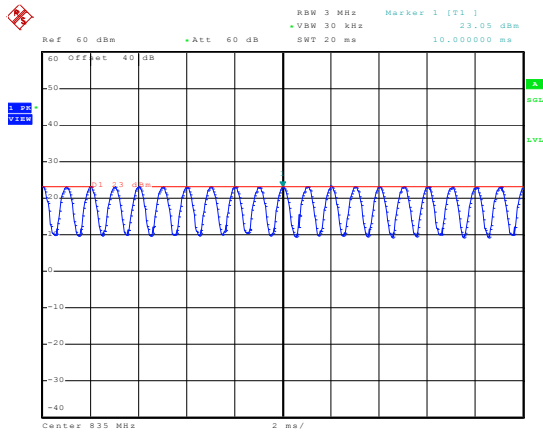

835MHz - 80% AM

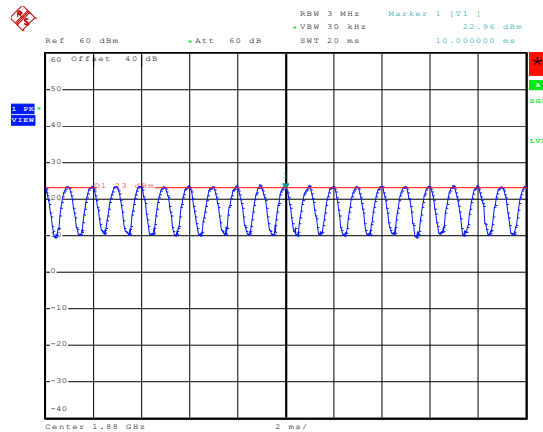

1880MHz - 80% AM

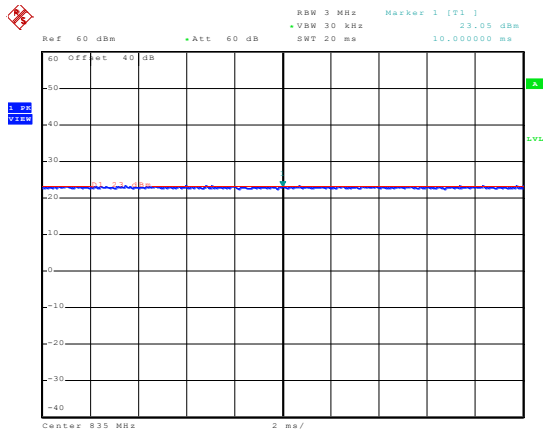

835MHz - WCDMA

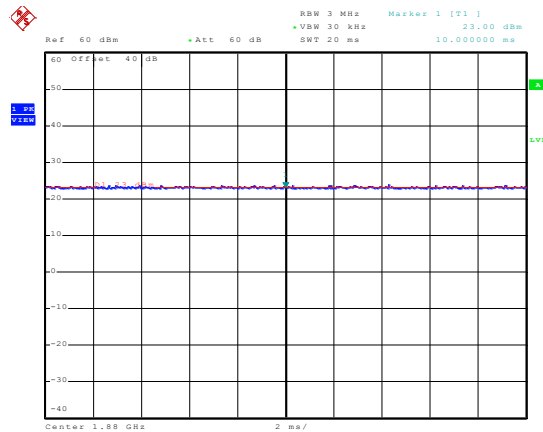

1880MHz - WCDMA

9. Description for DUT Testing Position

The DUT was put on device holder and adjusted to the accurate and reliable position. Please refer to Appendix E for the Setup photographs.

Fig. 9.1 illustrate the references and reference plane that shall be used in a typical DUT emissions measurement. The principle of this section is applied to DUT with similar geometry.

- The grid is 5 cm by 5 cm area that is divided into 9 evenly sized blocks or sub-grids.
- The grid is centered on the audio frequency output transducer of the DUT.
- The grid is in a reference plane, which is defined as the planar area that contains the highest point in the area of the phone that normally rests against the user's ear. It is parallel to the centerline of the receiver area of the phone and is defined by the points of the receiver-end of the DUT handset, which, in normal handset use, rest against the ear.
- The measurement plane is parallel to, and 15 mm in front of, the reference plane.



Fig 9.1 A typical DUT reference and plane for HAC measurements

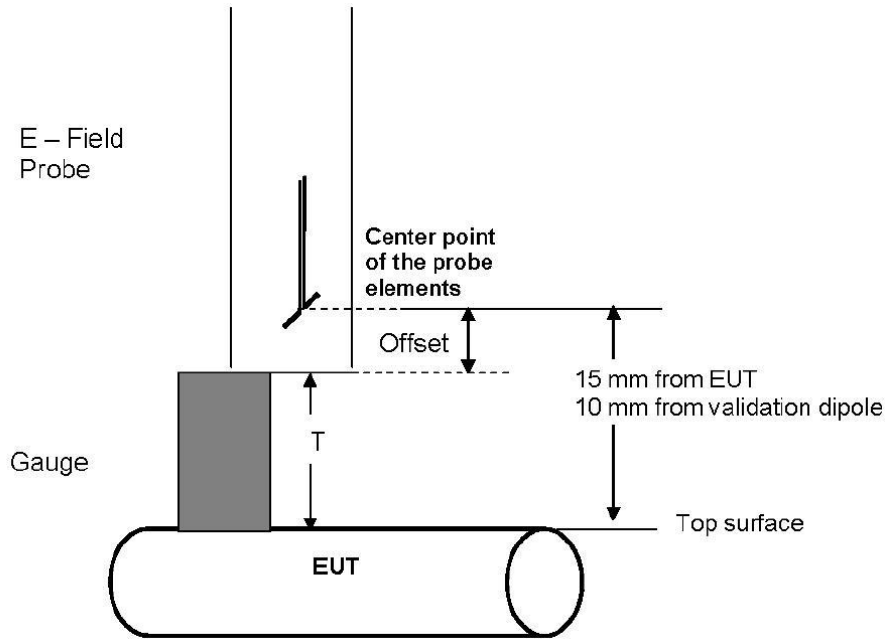

Fig. 9.2 Gauge block with E-field probe

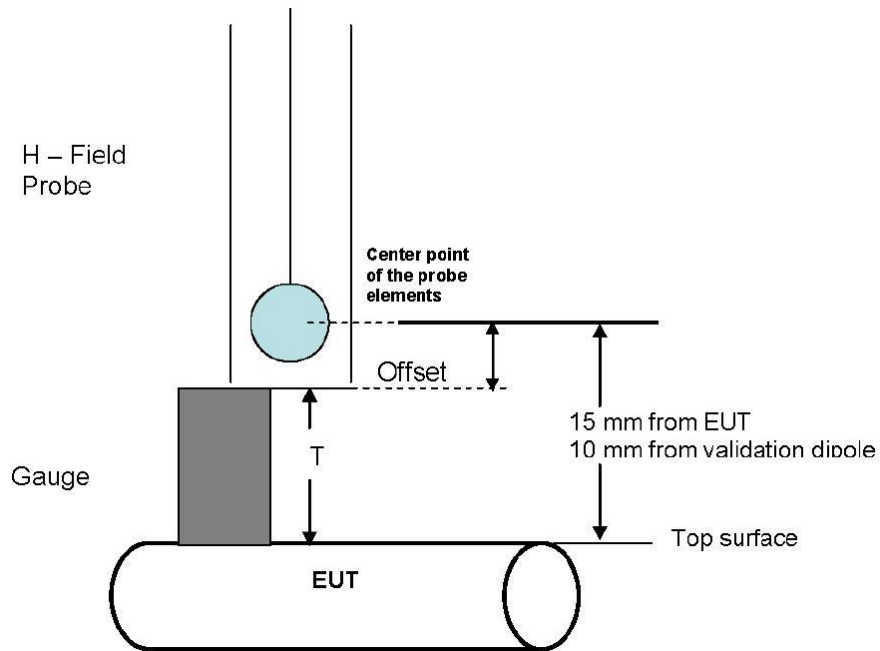

Fig. 9.3 Gauge block with H-field probe



10. RF Emissions Test Procedure

The following illustrate a typical RF emissions test scan over a wireless communications device:

1. Proper operation of the field probe, probe measurement system, other instrumentation, and the positioning system was confirmed.
2. DUT is positioned in its intended test position, acoustic output point of the device perpendicular to the field probe.
3. The DUT operation for maximum rated RF output power was configured and confirmed with the base station simulator, at the test channel and other normal operating parameters as intended for the test. The battery was ensured to be fully charged before each test.
4. The center sub-grid was centered over the center of the acoustic output (also audio band magnetic output, if applicable). The DUT audio output was positioned tangent (as physically possible) to the measurement plane.
5. A surface calibration was performed before each setup change to ensure repeatable spacing and proper maintenance of the measurement plane using the test Arch.
6. The measurement system measured the field strength at the reference location.
7. Measurements at 5 mm increments in the 5 x 5 cm region were performed and recorded. A 360° rotation about the azimuth axis at the maximum interpolated position was measured. For the worst-case condition, the peak reading from this rotation was used in re-evaluating the HAC category.
8. The system performed a drift evaluation by measuring the field at the reference location.
9. Steps 1 ~ 8 were done for both the E and H-Field measurements.



11. HAC RF Emission Test Results

11.1 Conducted Power (Unit: dBm)

Band	GSM850			GSM1900		
Channel	128	189	251	512	661	810
Frequency (MHz)	824.2	836.4	848.8	1850.2	1880.0	1909.8
GSM	31.84	32.01	32.09	29.26	29.26	29.26

Band	WCDMA Band V			WCDMA Band II		
Channel	4132	4182	4233	9262	9400	9538
Frequency (MHz)	826.4	836.4	846.6	1852.4	1880.0	1907.6
RMC 12.2K	22.74	22.79	22.79	22.78	22.85	22.66

11.2 E-Field Emission

Plot No.	Band	Mode	Channel	PMF	Peak E-Field (V/m)	M-Rating
#10	GSM850	GSM	128	2.63	143.9	M4
#11	GSM850	GSM	189	2.63	165.9	M3
#12	GSM850	GSM	251	2.63	176.2	M3
#01	GSM1900	GSM	512	2.70	66.9	M3
#02	GSM1900	GSM	661	2.70	71.7	M3
#03	GSM1900	GSM	810	2.70	82.8	M3
#7	WCDMA Band V	RMC12.2K	4132	0.999	43.2	M4
#8	WCDMA Band V	RMC12.2K	4182	0.999	49.7	M4
#9	WCDMA Band V	RMC12.2K	4233	0.999	49	M4
#04	WCDMA Band II	RMC12.2K	9262	0.977	32.3	M4
#05	WCDMA Band II	RMC12.2K	9400	0.977	34.6	M4
#06	WCDMA Band II	RMC12.2K	9538	0.977	37	M4



11.3 H-Field Emission

Plot No.	Band	Mode	Channel	PMF	Peak H-Field (A/m)	M-Rating
#22	GSM850	GSM	128	1.50	0.165	M4
#23	GSM850	GSM	189	1.50	0.197	M4
#24	GSM850	GSM	251	1.50	0.218	M4
#13	GSM1900	GSM	512	1.28	0.099	M4
#14	GSM1900	GSM	661	1.28	0.112	M4
#15	GSM1900	GSM	810	1.28	0.132	M4
#19	WCDMA Band V	RMC12.2K	4132	0.833	0.067	M4
#20	WCDMA Band V	RMC12.2K	4182	0.833	0.084	M4
#21	WCDMA Band V	RMC12.2K	4233	0.833	0.08	M4
#16	WCDMA Band II	RMC12.2K	9262	0.524	0.053	M4
#17	WCDMA Band II	RMC12.2K	9400	0.524	0.055	M4
#18	WCDMA Band II	RMC12.2K	9538	0.524	0.063	M4

Remark:

1. The volume was adjusted to maximum level and the backlight turned off during RF Emission testing.
2. Test Engineer : Robert Liu and Eric Huang



12. References

- [1] ANSI C63.19-2007, "American National Standard for Methods of Measurement of Compatibility between Wireless Communications Devices and Hearing Aids", 8 June 2007
- [2] SPEAG DASY System Handbook



Appendix A. Plots of System Performance Check

The plots are shown as follows.



Appendix B. Plots of RF Emission Measurement

The plots are shown as follows.



Appendix C. DASY Calibration Certificate

The DASY calibration certificates are shown as follows.