

# SAR Test Report

Product Name : Smart Handheld

Model No. : M900DF

Applicant : Acer Incorporated

Address : 8F, 88, Sec. 1, Hsin Tai Wu Rd., Hsichih, Taipei Hsien  
221, Taiwan

Date of Receipt : 2009/12/09

Issued Date : 2010/01/15

Report No. : 09C210R-HPUSP10V01

Report Version : V1.0

The test results relate only to the samples tested.

The test report shall not be reproduced except in full without the written approval of Quietek Corporation.

# Test Report Certification

Issued Date: 2010/01/15  
Report No.:09C210R-HPUSP10V01



Product Name : Smart Handheld  
 Applicant : Acer Incorporated  
 Address : 8F, 88, Sec. 1, Hsin Tai Wu Rd., Hsichih, Taipei  
 Hsien 221, Taiwan  
 Manufacturer : Compal Communications, INC.  
 Trade Name : acer  
 FCC ID : HLZSHM900DF  
 Model No. : M900DF  
 Applicable Standard : FCC Oet65 Supplement C June 2001  
 IEEE Std. 1528-2003  
 47CFR § 2.1093  
 Test Result : Max. SAR Measurement (1g)  
 GSM 850MHz: **1.01** W/kg  
 PCS 1900MHz: **1.09** W/kg  
 WCDMA Band V: **0.297** W/kg  
 WCDMA Band II: **0.857** W/kg

The test results relate only to the samples tested.

The test report shall not be reproduced except in full without the written approval of Quie Tek Corporation.

Documented By :   
 (Adm. Specialist / Nicole Huang)

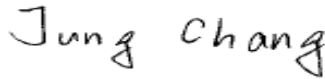
Tested By :   
 (Engineer / Jung Chang)

Approved By :   
 (Manager / Vincent Lin)

## TABLE OF CONTENTS

Description	Page
<b>1. General Information.....</b>	<b>5</b>
1.1 EUT Description .....	5
1.2 Test Environment .....	6
<b>2. SAR Measurement System .....</b>	<b>7</b>
2.1 DASY5 System Description .....	7
2.1.1 Applications .....	8
2.1.2 Area Scans.....	8
2.1.3 Zoom Scan (Cube Scan Averaging).....	8
2.1.4 Uncertainty of Inter-/Extrapolation and Averaging.....	8
2.2 DASY5 E-Field Probe .....	9
2.2.1 Isotropic E-Field Probe Specification .....	9
2.3 Boundary Detection Unit and Probe Mounting Device .....	10
2.4 DATA Acquisition Electronics (DAE) and Measurement Server .....	10
2.5 Robot.....	11
2.6 Light Beam Unit.....	11
2.7 Device Holder .....	12
2.8 SAM Twin Phantom .....	12
<b>3. Tissue Simulating Liquid .....</b>	<b>13</b>
3.1 The composition of the tissue simulating liquid .....	13
3.2 Tissue Calibration Result .....	13
3.3 Tissue Dielectric Parameters for Head and Body Phantoms .....	16
<b>4. SAR Measurement Procedure .....</b>	<b>17</b>
4.1 SAR System Validation.....	17
4.1.1 Validation Dipoles.....	17
4.1.2 Validation Result .....	17
4.2 Arrangement Assessment Setup .....	18
<b>5. SAR Exposure Limits .....</b>	<b>19</b>
<b>6. Test Equipment List.....</b>	<b>20</b>
<b>7. Measurement Uncertainty .....</b>	<b>21</b>
<b>8. Conducted Power Measurement .....</b>	<b>22</b>
<b>9. Test Results.....</b>	<b>29</b>
9.1 SAR Test Results Summary .....	29
Appendix.....	35
Appendix A. SAR System Validation Data.....	35

Appendix B. SAR measurement Data.....35  
Appendix C. Test Setup Photographs & EUT Photographs.....35  
Appendix D. Probe Calibration Data .....35  
Appendix E. Dipole Calibration Data .....35

**1. General Information**

**1.1 EUT Description**

Product Name	Smart Handheld
Model No.	M900DF
IMEI No.	353273-xx-xxxxxx-x
FCC ID	HLZSHM900DF
TX Frequency	824MHz~849MHz(GSM 850/WCDMA Band V) 1850MHz ~1910MHz(PCS 1900/WCDMA Band II)
RX Frequency	824MHz~849MHz(GSM 850/WCDMA Band V) 1850MHz ~1910MHz(PCS 1900/WCDMA Band II)
Antenna Type	FPCB
Device Category	Portable
RF Exposure Environment	Uncontrolled
Max. Output Power (Conducted)	GSM 850: 32.18dBm PCS 1900: 29.38dBm WCDMA V: 23.64dBm WCDMA II: 24.12dBm

## 1.2 Test Environment

Ambient conditions in the laboratory: GSM 850 & WCDMA Band V

Items	Required	Actual
Temperature (°C)	18-25	20.9
Humidity (%RH)	30-70	51

Ambient conditions in the laboratory: PCS 1900 & WCDMA Band II

Items	Required	Actual
Temperature (°C)	18-25	20.8
Humidity (%RH)	30-70	54

Ambient conditions in the laboratory: PCS 1900 (1/15)

Items	Required	Actual
Temperature (°C)	18-25	21.8
Humidity (%RH)	30-70	54

### Site Description:

Accredited by TAF  
 Accredited Number: 0914  
 Effective through: December 12, 2011



Site Name: Quietek Corporation

Site Address: No. 5-22, Ruei-Shu Valley, Ruei-Ping Tsuen,  
 Lin-Kou Shiang, Taipei,  
 Taiwan, R.O.C.  
 TEL: 886-2-8601-3788 / FAX: 886-2-8601-3789  
 E-Mail: [service@quietek.com](mailto:service@quietek.com)

## 2. SAR Measurement System

### 2.1 DASY5 System Description

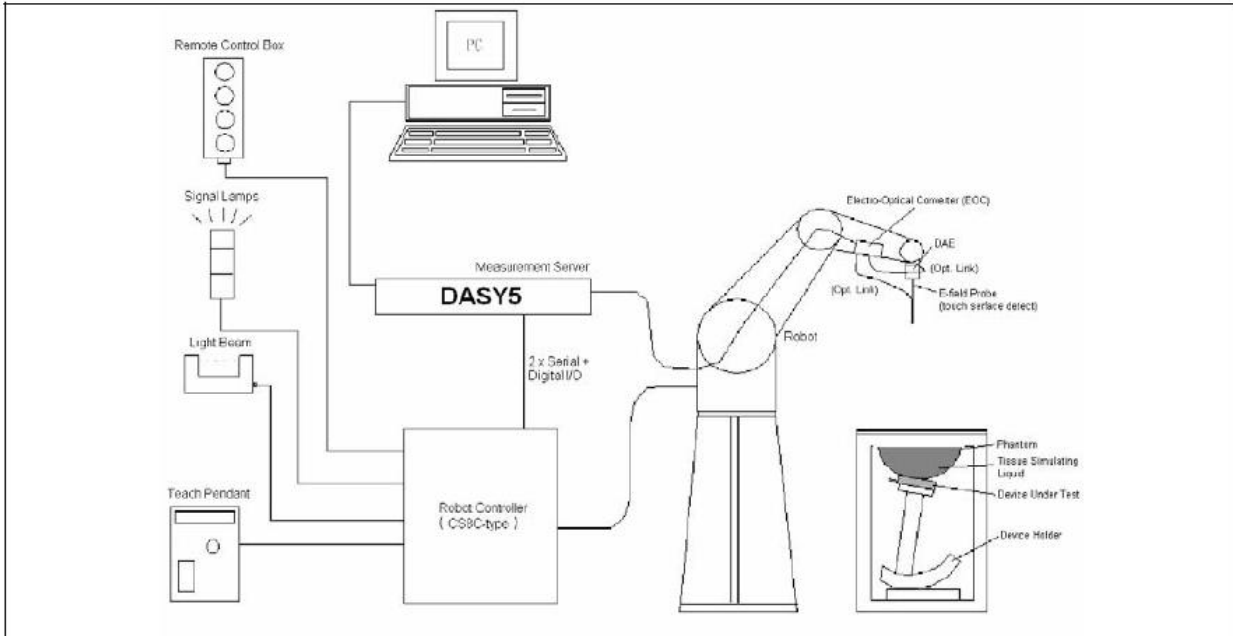

The DASY5 system for performing compliance tests consists of the following items:

- A standard high precision 6-axis robot with controller, teach pendant and software. An arm extension for accommodating the data acquisition electronics (DAE).
- A data acquisition electronics (DAE) which performs the signal amplification, signal multiplexing, AD-conversion, offset measurements, mechanical surface detection, collision detection, etc. The unit is battery powered with standard or rechargeable batteries. The signal is optically transmitted to the EOC.
- The Electro-optical converter (EOC) performs the conversion from optical to electrical signals for the digital communication to the DAE. To use optical surface detection, a special version of the EOC is required. The EOC signal is transmitted to the measurement server.
- The Light Beam used is for probe alignment. This improves the (absolute) accuracy of the probe positioning.
- A computer running WinXP and the DASY5 software.
- Remote control and teach pendant as well as additional circuitry for robot safety such as warning lamps, etc.
- The phantom, the device holder and other accessories according to the targeted measurement.

### **2.1.1 Applications**

Predefined procedures and evaluations for automated compliance testing with all worldwide standards, e.g., IEEE 1528, OET 65, IEC 62209-1, IEC 62209-2, EN 50360, EN 50383 and others.

### **2.1.2 Area Scans**

Area scans are defined prior to the measurement process being executed with a user defined variable spacing between each measurement point (integral) allowing low uncertainty measurements to be conducted. Scans defined for FCC applications utilize a 10mm<sup>2</sup> step integral, with 1mm interpolation used to locate the peak SAR area used for zoom scan assessments.

When an Area Scan has measured all reachable points, it computes the field maxima found in the scanned area, within a range of the global maximum. The range (in dB) is specified in the standards for compliance testing. For example, a 2 dB range is required in IEEE 1528-2003, EN 50361 and IEC 62209 standards, whereby 3 dB is a requirement when compliance is assessed in accordance with the ARIB standard (Japan).

### **2.1.3 Zoom Scan (Cube Scan Averaging)**

Zoom Scans are used to assess the peak spatial SAR values within a cubic averaging volume containing 1 g and 10 g of simulated tissue. A density of 1000 kg/m<sup>3</sup> is used to represent the head and body tissue density and not the phantom liquid density, in order to be consistent with the definition of the liquid dielectric properties, i.e. the side length of the 1 g cube is 10mm, with the side length of the 10 g cube 21,5mm.

The zoom scan integer steps can be user defined so as to reduce uncertainty, but normal practice for typical test applications (including FCC) utilize a physical step of 5x5x7 (8mmx8mmx5mm) providing a volume of 32mm in the X & Y axis, and 30mm in the Z axis.

### **2.1.4 Uncertainty of Inter-/Extrapolation and Averaging**

In order to evaluate the uncertainty of the interpolation, extrapolation and averaged SAR calculation algorithms of the Postprocessor, DASY5 allows the generation of measurement grids which are artificially predefined by analytically based test functions. Therefore, the grids of area scans and zoom scans can be filled with uncertainty test data, according to the SAR benchmark functions of IEEE 1528. The three analytical functions shown in equations as below are used to describe the possible range of the expected SAR distributions for the tested handsets. The field gradients are covered by the spatially flat



distribution f1, the spatially steep distribution f3 and f2 accounts for H-field cancellation on the phantom/tissue surface.

$$f_1(x, y, z) = Ae^{-\frac{z}{2a}} \cos^2 \left( \frac{\pi \sqrt{x'^2 + y'^2}}{5a} \right)$$

$$f_2(x, y, z) = Ae^{-\frac{z}{a}} \frac{a^2}{a^2 + x'^2} \left( 3 - e^{-\frac{2z}{a}} \right) \cos^2 \left( \frac{\pi y'}{2 \cdot 3a} \right)$$

$$f_3(x, y, z) = A \frac{a^2}{\frac{a^2}{4} + x'^2 + y'^2} \left( e^{-\frac{2z}{a}} + \frac{a^2}{2(a + 2z)^2} \right)$$

### 2.2 DASY5 E-Field Probe

The SAR measurement is conducted with the dosimetric probe manufactured by SPEAG. The probe is specially designed and calibrated for use in liquid with high permittivity. The dosimetric probe has special calibration in liquid at different frequency. SPEAG conducts the probe calibration in compliance with international and national standards (e.g. IEEE 1528, EN 62209-1, IEC 62209, etc.) under ISO 17025. The calibration data are in Appendix D.

#### 2.2.1 Isotropic E-Field Probe Specification

<b>Model</b>	Ex3DV4	
<b>Construction</b>	Symmetrical design with triangular core Built-in shielding against static charges PEEK enclosure material (resistant to organic solvents, e.g., DGBE)	
<b>Frequency</b>	10 MHz to 6 GHz Linearity: ± 0.2 dB (30 MHz to 6 GHz)	
<b>Directivity</b>	± 0.3 dB in HSL (rotation around probe axis) ± 0.5 dB in tissue material (rotation normal to probe axis)	
<b>Dynamic Range</b>	10 µW/g to 100 mW/g Linearity: ± 0.2 dB (noise: typically < 1 µW/g)	
<b>Dimensions</b>	Overall length: 330 mm (Tip: 20 mm) Tip diameter: 2.5 mm (Body: 12 mm) Typical distance from probe tip to dipole centers: 1 mm	
<b>Application</b>	High precision dosimetric measurements in any exposure scenario (e.g., very strong gradient fields). Only probe which enables compliance testing for frequencies up to 6 GHz with precision of better 30%.	

### 2.3 Boundary Detection Unit and Probe Mounting Device

The DASY probes use a precise connector and an additional holder for the probe, consisting of a plastic tube and a flexible silicon ring to center the probe. The connector at the DAE is flexibly mounted and held in the default position with magnets and springs. Two switching systems in the connector mount detect frontal and lateral probe collisions and trigger the necessary software response.



### 2.4 DATA Acquisition Electronics (DAE) and Measurement Server

The data acquisition electronics (DAE) consists of a highly sensitive electrometer-grade preamplifier with auto-zeroing, a channel and gain-switching multiplexer, a fast 16 bit AD-converter and a command decoder and control logic unit.

Transmission to the measurement server is accomplished through an optical downlink for data and status information as well as an optical uplink for commands and the clock.

The input impedance of the DAE4 is 200M Ohm; the inputs are symmetrical and floating. Common mode rejection is above 80dB.



The DASY5 measurement server is based on a PC/104 CPU board with a 400MHz intel ULV Celeron, 128MB chipdisk and 128MB RAM. The necessary circuits for communication with the DAE electronics box, as well as the 16 bit AD converter system for optical detection and digital I/O interface are contained on the DASY5 I/O board, which is directly connected to the PC/104 bus of the CPU board.



## 2.5 Robot

The DASY5 system uses the high precision robots TX90 XL type out of the newer series from Stäubli SA (France). For the 6-axis controller DASY5 system, the CS8C robot controller version from Stäubli is used.

The XL robot series have many features that are important for our application:

- High precision (repeatability 0.02 mm)
- High reliability (industrial design)
- Jerk-free straight movements
- Low ELF interference (the closed metallic construction shields against motor control fields)
- 6-axis controller



## 2.6 Light Beam Unit

The light beam switch allows automatic "tooling" of the probe. During the process, the actual position of the probe tip with respect to the robot arm is measured, as well as the probe length and the horizontal probe offset. The software then corrects all movements, such that the robot coordinates are valid for the probe tip.

The repeatability of this process is better than 0.1 mm. If a position has been taught with an aligned probe, the same position will be reached with another aligned probe within 0.1 mm, even if the other probe has different dimensions. During probe rotations, the probe tip will keep its actual position.



### 2.7 Device Holder

The DASY5 device holder is designed to cope with different positions given in the standard. It has two scales for the device rotation (with respect to the body axis) and the device inclination (with respect to the line between the ear reference points). The rotation center for both scales is the ear reference point (EPR).

Thus the device needs no repositioning when changing the angles.

The DASY5 device holder has been made out of low-loss POM material having the following dielectric parameters: relative permittivity  $\epsilon_r = 3$  and loss tangent  $\delta = 0.02$ . The amount of dielectric material has been reduced in the closest vicinity of the device, since measurements have suggested that the influence of the clamp on the test results could thus be lowered.



### 2.8 SAM Twin Phantom

The SAM twin phantom is a fiberglass shell phantom with 2mm shell thickness (except the ear region where shell thickness increases to 6mm). It has three measurement areas:

- Left head
- Right head
- Flat phantom



The bottom plate contains three pair of bolts for locking the device holder. The device holder positions are adjusted to the standard measurement positions in the three sections. A white cover is provided to tap the phantom during off-periods to prevent water evaporation and changes in the liquid parameters. On the phantom top, three reference markers are provided to identify the phantom position with respect to the robot.

### 3. Tissue Simulating Liquid

#### 3.1 The composition of the tissue simulating liquid

INGREDIENT (% Weight)	835MHz Head	835MHz Body	1900MHz Head	1900MHz Body
<b>Water</b>	40.45	52.4	54.90	40.5
<b>Salt</b>	1.45	1.40	0.18	0.50
<b>Sugar</b>	57.6	45.0	0.00	58.0
<b>HEC</b>	0.40	1.00	0.00	0.50
<b>Preventol</b>	0.10	0.20	0.00	0.50
<b>DGBE</b>	0.00	0.00	44.92	0.00

#### 3.2 Tissue Calibration Result

The dielectric parameters of the liquids were verified prior to the SAR evaluation using APREL Dielectric Probe Kit and Anritsu MS4623B Vector Network Analyzer.

Head Tissue Simulant Measurement				
Frequency [MHz]	Description	Dielectric Parameters		Tissue Temp. [°C]
		$\epsilon_r$	$\sigma$ [s/m]	
835 MHz	Reference result ± 5% window	42.54 40.413 to 44.667	0.91 0.8645 to 0.9555	N/A
	21-Dec-09	41.97	0.92	20.1

Body Tissue Simulant Measurement				
Frequency [MHz]	Description	Dielectric Parameters		Tissue Temp. [°C]
		$\epsilon_r$	$\sigma$ [s/m]	
835 MHz	Reference result ± 5% window	55.2 52.44 to 57.96	0.97 0.9215 to 1.0185	N/A
	21-Dec-09	54.26	0.96	20.1
824 MHz	Low channel	54.55	0.95	20.1
836 MHz	Mid channel	54.17	0.97	20.1
848 MHz	High channel	53.91	0.99	20.1

<b>Head Tissue Simulant Measurement</b>				
Frequency [MHz]	Description	Dielectric Parameters		Tissue Temp. [°C]
		$\epsilon_r$	$\sigma$ [s/m]	
1900 MHz	Reference result ± 5% window	39.9 37.905 to 41.895	1.42 1.349 to 1.491	N/A
	22-Dec-09	39.06	1.40	20.1

<b>Body Tissue Simulant Measurement</b>				
Frequency [MHz]	Description	Dielectric Parameters		Tissue Temp. [°C]
		$\epsilon_r$	$\sigma$ [s/m]	
1900 MHz	Reference result ± 5% window	53.3 50.635 to 55.965	1.52 1.444 to 1.596	N/A
	22-Dec-09	52.54	1.50	20.1
1850 MHz	Low channel	53.46	1.46	20.1
1880 MHz	Mid channel	53.17	1.48	20.1
1910 MHz	High channel	52.21	1.51	20.1

<b>Head Tissue Simulant Measurement</b>				
Frequency [MHz]	Description	Dielectric Parameters		Tissue Temp. [°C]
		$\epsilon_r$	$\sigma$ [s/m]	
1900 MHz	Reference result ± 5% window	39.9 37.905 to 41.895	1.42 1.349 to 1.491	N/A
	15-Jan-10	40.1	1.41	20.1

<b>Body Tissue Simulant Measurement</b>				
Frequency [MHz]	Description	Dielectric Parameters		Tissue Temp. [°C]
		$\epsilon_r$	$\sigma$ [s/m]	
1910 MHz	Reference result ± 5% window	53.3 50.635 to 55.965	1.52 1.444 to 1.596	N/A
	15-Jan-10	52.21	1.52	20.1

**3.3 Tissue Dielectric Parameters for Head and Body Phantoms**

The head tissue dielectric parameters recommended by the IEEE SCC-34/SC-2 in P1528 have been incorporated in the following table. These head parameters are derived from planar layer models simulating the highest expected SAR for the dielectric properties and tissue thickness variations in a human head. Other head and body tissue parameters that have not been specified in P1528 are derived from the tissue dielectric parameters computed from the 4-Cole-Cole equations described in Reference [12] and extrapolated according to the head parameters specified in P1528.

Target Frequency (MHz)	Head		Body	
	$\epsilon_r$	$\sigma$ (S/m)	$\epsilon_r$	$\sigma$ (S/m)
150	52.3	0.76	61.9	0.80
300	45.3	0.87	58.2	0.92
450	43.5	0.87	56.7	0.94
835	41.5	0.90	55.2	0.97
900	41.5	0.97	55.0	1.05
915	41.5	0.98	55.0	1.06
1450	40.5	1.20	54.0	1.30
1610	40.3	1.29	53.8	1.40
1800 – 2000	40.0	1.40	53.3	1.52
2450	39.2	1.80	52.7	1.95
3000	38.5	2.40	52.0	2.73
5800	35.3	5.27	48.2	6.00

( $\epsilon_r$  = relative permittivity,  $\sigma$  = conductivity and  $\rho = 1000 \text{ kg/m}^3$ )



## 4. SAR Measurement Procedure

### 4.1 SAR System Validation

#### 4.1.1 Validation Dipoles

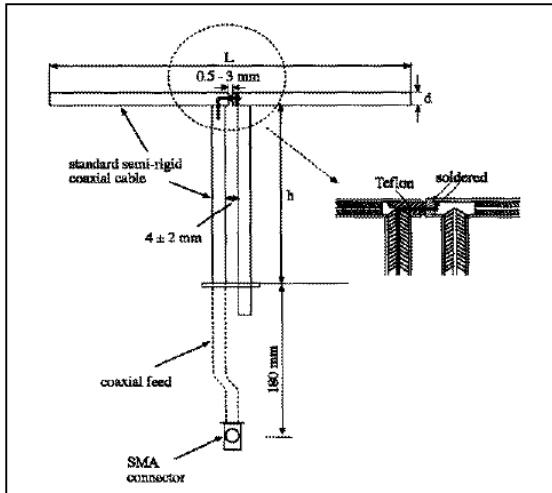

The dipoles used is based on the IEEE-1528 standard, and is complied with mechanical and electrical specifications in line with the requirements of both IEEE and FCC Supplement C. the table below provides details for the mechanical and electrical specifications for the dipoles.

Frequency	L (mm)	h (mm)	d (mm)
835MHz	165.0	900	3.6
1900MHz	68.0	39.5	3.6

#### 4.1.2 Validation Result

System Performance Check at 835MHz &1900MHz				
Validation Kit: ASL-D-835-S-2				
Frequency [MHz]	Description	SAR [w/kg] 1g	SAR [w/kg] 10g	Tissue Temp. [°C]
835 MHz	Reference result ± 10% window	9.33 8.397 to 10.263	6.42 5.778 to 7.062	N/A
	21-Dec-09	9.64	6.36	20.1
Validation Kit: ASL-D-1900-S-2				
Frequency [MHz]	Description	SAR [w/kg] 1g	SAR [w/kg] 10g	Tissue Temp. [°C]
1900 MHz	Reference result ± 10% window	36 32.4 to 39.6	20.78 18.702 to 22.858	N/A
	22-Dec-09	37.4	19.88	20.1
	14-Jan-10	35.76	21.2	20.1
Note: All SAR values are normalized to 1W forward power.				

## 4.2 Arrangement Assessment Setup

The ALSAS-10U calculates SAR using the following equation,

$$SAR = \frac{\sigma |E|^2}{\rho}$$

$\sigma$ : represents the simulated tissue conductivity

$\rho$ : represents the tissue density

The EUT is set to transmit at the required power in line with product specification, at each frequency relating to the LOW, MID, and HIGH channel settings.

Pre-scans are made on the device to establish the location for the transmitting antenna, using a large area scan in either air or tissue simulation fluid.

The EUT is placed against the Universal Phantom where the maximum area scan dimensions are larger than the physical size of the resonating antenna. When the scan size is not large enough to cover the peak SAR distribution, it is modified by either extending the area scan size in both the X and Y directions, or the device is shifted within the predefined area.

The area scan is then run to establish the peak SAR location (interpolated resolution set at 1mm<sup>2</sup>) which is then used to orient the center of the zoom scan. The zoom scan is then executed and the 1g and 10g averages are derived from the zoom scan volume (interpolated resolution set at 1mm<sup>3</sup>).

**5. SAR Exposure Limits**

SAR assessments have been made in line with the requirements of IEEE-1528, FCC Supplement C, and comply with ANSI/IEEE C95.1-1992 “Uncontrolled Environments” limits. These limits apply to a location which is deemed as “Uncontrolled Environment” which can be described as a situation where the general public may be exposed to an RF source with no prior knowledge or control over their exposure.

**Limits for General Population/Uncontrolled Exposure (W/kg)**

<b>Type Exposure</b>	<b>Uncontrolled Environment Limit</b>
Spatial Peak SAR (1g cube tissue for brain or body)	<b>1.60 W/kg</b>
Spatial Average SAR (whole body)	<b>0.08 W/kg</b>
Spatial Peak SAR (10g for hands, feet, ankles and wrist)	<b>4.00 W/kg</b>

## 6. Test Equipment List

Instrument	Manufacturer	Model No.	Serial No.	Last Calibration	Next Calibration
Stäubli Robot TX60L	Stäubli	TX60L	F09/5BL1A1/A06	May. 2009	only once
Controller	Speag	CS8c	N/A	May. 2009	only once
Aprel Reference Dipole 835Mhz	Aprel	ALS-D-835-S-2	QTK-315	May. 2008	May. 2010
Aprel Reference Dipole 1900Mhz	Aprel	ALS-D-1900-S-2	QTK-318	May. 2008	May. 2010
SAM Twin Phantom	Speag	QD000 P40 CA	Tp 1515	N/A	N/A
Device Holder	Speag	N/A	N/A	N/A	N/A
Data Acquisition Electronic	Speag	DAE4	1204	Apr. 2009	Apr. 2010
E-Field Probe	Speag	EX3DV4	3602	May. 2009	May. 2010
SAR Software	Speag	DASY5	V5.0 Build 125	N/A	N/A
Aprel Dipole Spaccer	Aprel	ALS-DS-U	QTK-295	N/A	N/A
Power Amplifier	Mini-Circuit	ZHL-42	D051404-20	N/A	N/A
Directional Coupler	Agilent	778D-012	50550	N/A	N/A
Universal Radio Communication Tester	R&S	CMU 200	104846	May. 2009	May. 2010
Vector Network	Anritsu	MS4623B	992801	Aug. 2009	Aug. 2010
Signal Generator	Anritsu	MG3692A	042319	Jun. 2009	Jun. 2010
Power Meter	Anritsu	ML2487A	6K00001447	Apr. 2009	Apr. 2010
Wide Bandwidth Sensor	Anritsu	MA2491	030677	Apr. 2009	Apr. 2010

7. Measurement Uncertainty

Uncertainty								
Error Description	Uncertainty value	Prob. Dist.	Div.	( $c_i$ ) 1g	( $c_i$ ) 10g	Std. Unc. (1g)	Std. Unc. (10g)	( $v_i$ ) $v_{eff}$
<b>Measurement System</b>								
Probe Calibration	±5.9 %	N	1	1	1	±5.9 %	±5.9 %	∞
Axial Isotropy	±4.7 %	R	$\sqrt{3}$	0.7	0.7	±1.9 %	±1.9 %	∞
Hemispherical Isotropy	±9.6 %	R	$\sqrt{3}$	0.7	0.7	±3.9 %	±3.9 %	∞
Boundary Effects	±1.0 %	R	$\sqrt{3}$	1	1	±0.6 %	±0.6 %	∞
Linearity	±4.7 %	R	$\sqrt{3}$	1	1	±2.7 %	±2.7 %	∞
System Detection Limits	±1.0 %	R	$\sqrt{3}$	1	1	±0.6 %	±0.6 %	∞
Readout Electronics	±0.3 %	N	1	1	1	±0.3 %	±0.3 %	∞
Response Time	±0.8 %	R	$\sqrt{3}$	1	1	±0.5 %	±0.5 %	∞
Integration Time	±2.6 %	R	$\sqrt{3}$	1	1	±1.5 %	±1.5 %	∞
RF Ambient Noise	±3.0 %	R	$\sqrt{3}$	1	1	±1.7 %	±1.7 %	∞
RF Ambient Reflections	±3.0 %	R	$\sqrt{3}$	1	1	±1.7 %	±1.7 %	∞
Probe Positioner	±0.4 %	R	$\sqrt{3}$	1	1	±0.2 %	±0.2 %	∞
Probe Positioning	±2.9 %	R	$\sqrt{3}$	1	1	±1.7 %	±1.7 %	∞
Max. SAR Eval.	±1.0 %	R	$\sqrt{3}$	1	1	±0.6 %	±0.6 %	∞
<b>Test Sample Related</b>								
Device Positioning	±2.9 %	N	1	1	1	±2.9 %	±2.9 %	145
Device Holder	±3.6 %	N	1	1	1	±3.6 %	±3.6 %	5
Power Drift	±5.0 %	R	$\sqrt{3}$	1	1	±2.9 %	±2.9 %	∞
<b>Phantom and Setup</b>								
Phantom Uncertainty	±4.0 %	R	$\sqrt{3}$	1	1	±2.3 %	±2.3 %	∞
Liquid Conductivity (target)	±5.0 %	R	$\sqrt{3}$	0.64	0.43	±1.8 %	±1.2 %	∞
Liquid Conductivity (meas.)	±2.5 %	N	1	0.64	0.43	±1.6 %	±1.1 %	∞
Liquid Permittivity (target)	±5.0 %	R	$\sqrt{3}$	0.6	0.49	±1.7 %	±1.4 %	∞
Liquid Permittivity (meas.)	±2.5 %	N	1	0.6	0.49	±1.5 %	±1.2 %	∞
Combined Std. Uncertainty						±10.9 %	±10.7 %	387
Expanded STD Uncertainty						±21.9 %	±21.4 %	

**8. Conducted Power Measurement**

**Maximum Power-GSM 850**

Frequency (MHz)	Output Power (dBm)	Path Loss (dB)	Result (dBm)	Result (W)
824.2	31.76	0.2	31.96	1.57
836.4	31.92	0.2	32.12	1.63
848.8	31.94	0.2	32.14	1.64

**Maximum Power-GPRS 850( ↑ )**

Frequency (MHz)	Output Power (dBm)	Path Loss (dB)	Result (dBm)	Result (W)
824.2	31.77	0.2	31.97	1.57
836.4	31.94	0.2	32.14	1.64
848.8	31.98	0.2	32.18	1.65

**Maximum Power-GPRS 850( ↑ ↑ )**

Frequency (MHz)	Output Power (dBm)	Path Loss (dB)	Result (dBm)	Result (W)
824.2	31.73	0.2	31.93	1.56
836.4	31.89	0.2	32.09	1.62
848.8	31.92	0.2	32.12	1.63

**Maximum Power-GPRS 850( ↑ ↑ ↑ )**

Frequency (MHz)	Output Power (dBm)	Path Loss (dB)	Result (dBm)	Result (W)
824.2	31.66	0.2	31.86	1.53
836.4	31.82	0.2	32.02	1.59
848.8	31.87	0.2	32.07	1.61

**Maximum Power-GPRS 850(↑↑↑↑)**

Frequency (MHz)	Output Power (dBm)	Path Loss (dB)	Result (dBm)	Result (W)
824.2	31.60	0.2	31.80	1.51
836.4	31.75	0.2	31.95	1.57
848.8	31.82	0.2	32.02	1.59

**Maximum Power-EGPRS 850(↑)**

Frequency (MHz)	Output Power (dBm)	Path Loss (dB)	Result (dBm)	Result (W)
824.2	25.36	0.2	25.56	0.36
836.4	25.55	0.2	25.75	0.38
848.8	25.63	0.2	25.83	0.38

**Maximum Power-EGPRS 850(↑↑)**

Frequency (MHz)	Output Power (dBm)	Path Loss (dB)	Result (dBm)	Result (W)
824.2	25.27	0.2	25.47	0.35
836.4	25.51	0.2	25.71	0.37
848.8	25.61	0.2	25.81	0.38

**Maximum Power-EGPRS 850(↑↑↑)**

Frequency (MHz)	Output Power (dBm)	Path Loss (dB)	Result (dBm)	Result (W)
824.2	25.25	0.2	25.45	0.35
836.4	25.50	0.2	25.70	0.37
848.8	25.58	0.2	25.78	0.38

**Maximum Power-EGPRS 850(↑↑↑↑)**

Frequency (MHz)	Output Power (dBm)	Path Loss (dB)	Result (dBm)	Result (W)
824.2	25.24	0.2	25.44	0.35
836.4	25.47	0.2	25.67	0.37
848.8	25.49	0.2	25.69	0.37

**Maximum Power-PCS 1900**

Frequency (MHz)	Output Power (dBm)	Path Loss (dB)	Result (dBm)	Result (W)
1850.2	28.71	0.4	29.11	0.81
1880	28.97	0.4	29.37	0.86
1909.8	28.82	0.4	29.22	0.84

**Maximum Power-GPRS 1900(↑)**

Frequency (MHz)	Output Power (dBm)	Path Loss (dB)	Result (dBm)	Result (W)
1850.2	28.76	0.4	29.16	0.82
1880	28.98	0.4	29.38	0.87
1909.8	28.83	0.4	29.23	0.84

**Maximum Power-GPRS 1900(↑↑)**

Frequency (MHz)	Output Power (dBm)	Path Loss (dB)	Result (dBm)	Result (W)
1850.2	28.70	0.4	29.10	0.81
1880	28.94	0.4	29.34	0.86
1909.8	28.79	0.4	29.19	0.83



**Maximum Power-GPRS 1900( ↑ ↑ ↑ )**

Frequency (MHz)	Output Power (dBm)	Path Loss (dB)	Result (dBm)	Result (W)
1850.2	28.65	0.4	29.05	0.80
1880	28.90	0.4	29.30	0.85
1909.8	28.70	0.4	29.10	0.81

**Maximum Power-GPRS 1900( ↑ ↑ ↑ ↑ )**

Frequency (MHz)	Output Power (dBm)	Path Loss (dB)	Result (dBm)	Result (W)
1850.2	28.57	0.4	28.97	0.79
1880	28.79	0.4	29.19	0.83
1909.8	28.64	0.4	29.04	0.80

**Maximum Power-EGPRS 1900( ↑ )**

Frequency (MHz)	Output Power (dBm)	Path Loss (dB)	Result (dBm)	Result (W)
1850.2	24.72	0.4	25.12	0.33
1880	24.98	0.4	25.38	0.35
1909.8	24.84	0.4	25.24	0.33

**Maximum Power-EGPRS 1900( ↑ ↑ )**

Frequency (MHz)	Output Power (dBm)	Path Loss (dB)	Result (dBm)	Result (W)
1850.2	24.75	0.4	25.15	0.33
1880	24.93	0.4	25.33	0.34
1909.8	24.82	0.4	25.22	0.33

**Maximum Power-EGPRS 1900(↑↑↑↑)**

Frequency (MHz)	Output Power (dBm)	Path Loss (dB)	Result (dBm)	Result (W)
1850.2	24.74	0.4	25.14	0.33
1880	24.92	0.4	25.32	0.34
1909.8	24.83	0.4	25.23	0.33

**Maximum Power-EGPRS 1900(↑↑↑↑↑)**

Frequency (MHz)	Output Power (dBm)	Path Loss (dB)	Result (dBm)	Result (W)
1850.2	24.66	0.4	25.06	0.32
1880	24.91	0.4	25.31	0.34
1909.8	24.72	0.4	25.12	0.33

**Maximum Power-WCDMA V**

Frequency (MHz)	Output Power (dBm)	Path Loss (dB)	Result (dBm)	Result (W)
826.4	23.44	0.2	23.64	0.23
836.6	23.37	0.2	23.57	0.23
846.6	22.88	0.2	23.08	0.20

**Maximum Power-WCDMA II**

Frequency (MHz)	Output Power (dBm)	Path Loss (dB)	Result (dBm)	Result (W)
1852.4	23.72	0.4	24.12	0.26
1880	23.56	0.4	23.96	0.25
1907.6	22.96	0.4	23.36	0.22

WCDMA V HSDPA								
Frequency (MHz)	Set 1		Set 2		Set 3		Set 4	
	Power (dBm)	Power (Watts)	Power (dBm)	Power (Watts)	Power (dBm)	Power (Watts)	Power (dBm)	Power (Watts)
826.4	23.36	0.22	22.91	0.20	22.75	0.19	22.42	0.17
836.6	23.27	0.21	22.55	0.18	22.42	0.17	22.40	0.17
846.6	22.83	0.19	22.07	0.16	22.19	0.17	21.92	0.16
$\beta_c$	2		12		15		15	
$\beta_d$	15		15		8		4	
$\Delta_{ACK}, \Delta_{NACK} \Delta_{CQI}$	8		8		8		8	
Cable loss: 0.2dB for 850MHz ; 0.4dB for 1900MHz								

WCDMA II HSDPA								
Frequency (MHz)	Set 1		Set 2		Set 3		Set 4	
	Power (dBm)	Power (Watts)	Power (dBm)	Power (Watts)	Power (dBm)	Power (Watts)	Power (dBm)	Power (Watts)
1852.4	23.77	0.24	22.81	0.19	23.18	0.21	23.14	0.21
1880	23.34	0.22	23.52	0.22	22.35	0.17	22.28	0.17
1907.6	23.23	0.21	22.45	0.18	22.34	0.17	22.26	0.17
$\beta_c$	2		12		15		15	
$\beta_d$	15		15		8		4	
$\Delta_{ACK}, \Delta_{NACK} \Delta_{CQI}$	8		8		8		8	
Cable loss: 0.2dB for 850MHz ; 0.4dB for 1900MHz								

WCDMA Band V HSUPA										
Frequency (MHz)	Set 1		Set 2		Set 3		Set 4		Set 5	
	Power (dBm)	Power (Watts)	Power (dBm)	Power (Watts)	Power (dBm)	Power (Watts)	Power (dBm)	Power (Watts)	Power (dBm)	Power (Watts)
826.4	22.89	0.19	21.31	0.14	21.99	0.16	22.18	0.17	23.09	0.20
836.6	22.32	0.17	21.38	0.14	21.74	0.15	21.99	0.16	22.95	0.20
846.6	21.77	0.15	20.99	0.13	21.73	0.15	21.58	0.14	22.76	0.19
$\beta_c$	11		6		15		2		15	
$\beta_d$	15		15		9		15		15	
$\Delta_{ACK}, \Delta_{NACK} \Delta_{CQI}$	8		8		8		8		8	
AGV	20		12		15		17		21	
Cable loss: 0.2dB for 850MHz ; 0.4dB for 1900MHz										

WCDMA Band II HSUPA										
Frequency (MHz)	Set 1		Set 2		Set 3		Set 4		Set 5	
	Power (dBm)	Power (Watts)	Power (dBm)	Power (Watts)	Power (dBm)	Power (Watts)	Power (dBm)	Power (Watts)	Power (dBm)	Power (Watts)
1852.4	22.99	0.20	21.30	0.13	22.52	0.18	22.43	0.17	22.16	0.16
1880	22.97	0.20	21.13	0.13	22.29	0.17	21.90	0.15	21.52	0.14
1907.6	22.01	0.16	21.38	0.14	21.64	0.15	21.49	0.14	22.24	0.17
$\beta_c$	11		6		15		2		15	
$\beta_d$	15		15		9		15		15	
$\Delta_{ACK}, \Delta_{NACK} \Delta_{CQI}$	8		8		8		8		8	
AGV	20		12		15		17		21	
Cable loss: 0.2dB for 850MHz ; 0.4dB for 1900MHz										

## 9. Test Results

### 9.1 SAR Test Results Summary

SAR MEASUREMENT						
Ambient Temperature (°C) : 20.9 ±2				Relative Humidity (%): 51		
Liquid Temperature (°C) : 20.1 ±2				Depth of Liquid (cm):>15		
Product: Smart Handheld						
Test Mode: GSM 850						
Test Position Head/Body	Antenna Position	Frequency		Conducted Power (dBm)	SAR 1g (W/kg)	Limit (W/kg)
		Channel	MHz			
Left-Cheek	Fixed	128	824.2	31.96	0.106	1.6
Left-Cheek	Fixed	189	836.4	32.12	0.125	1.6
Left-Cheek	Fixed	251	848.8	32.14	0.141	1.6
Left-Tilted	Fixed	128	824.2	31.96	0.143	1.6
Left-Tilted	Fixed	189	836.4	32.12	0.129	1.6
Left-Tilted	Fixed	251	848.8	32.14	0.118	1.6
Right-Cheek	Fixed	128	824.2	31.96	0.125	1.6
Right-Cheek	Fixed	189	836.4	32.12	0.124	1.6
Right-Cheek	Fixed	251	848.8	32.14	0.106	1.6
Right-Tilted	Fixed	128	824.2	31.96	0.113	1.6
Right-Tilted	Fixed	189	836.4	32.12	0.119	1.6
Right-Tilted	Fixed	251	848.8	32.14	0.100	1.6
Body-worn	Fixed	128	824.2	31.96	0.282	1.6
Body-worn	Fixed	189	836.4	32.12	0.284	1.6
Body-worn	Fixed	251	848.8	32.14	0.256	1.6
Test Mode: GSM 850 GPRS 2 Slot						
Body-worn	Fixed	189	836.4	32.09	0.564	1.6
Test Mode: GSM 850 GPRS 3 Slot						

Body-worn	Fixed	189	836.4	32.02	0.807	1.6
Test Mode: GSM 850 GPRS 4 Slot						
Body-worn	Fixed	128	824.2	31.80	0.982	1.6
Body-worn	Fixed	189	836.4	31.95	1.010	1.6
Body-worn	Fixed	251	848.8	32.02	0.980	1.6
Test Mode: GSM 850 EGPRS 4 Slot						
Body-worn	Fixed	189	836.4	25.67	0.981	1.6

SAR MEASUREMENT						
Ambient Temperature (°C): 20.8 ± 2				Relative Humidity (%): 54		
Liquid Temperature (°C): 20.1 ± 2				Depth of Liquid (cm):>15		
Product: Smart Handheld						
Test Mode: PCS 1900						
Test Position Head/Body	Antenna Position	Frequency		Conducted Power (dBm)	SAR 1g (W/kg)	Limit (W/kg)
		Channel	MHz			
Left-Cheek	Fixed	512	1850.2	29.11	0.091	1.6
Left-Cheek	Fixed	661	1880	29.37	0.115	1.6
Left-Cheek	Fixed	810	1909.8	29.22	0.128	1.6
Left-Tilted	Fixed	512	1850.2	29.11	0.075	1.6
Left-Tilted	Fixed	661	1880	29.37	0.070	1.6
Left-Tilted	Fixed	810	1909.8	29.22	0.101	1.6
Right-Cheek	Fixed	512	1850.2	29.11	0.161	1.6
Right-Cheek	Fixed	661	1880	29.37	0.147	1.6
Right-Cheek	Fixed	810	1909.8	29.22	0.169	1.6
Right-Tilted	Fixed	512	1850.2	29.11	0.096	1.6
Right-Tilted	Fixed	661	1880	29.37	0.075	1.6
Right-Tilted	Fixed	810	1909.8	29.22	0.086	1.6
Body-worn	Fixed	512	1850.2	29.11	0.338	1.6
Body-worn	Fixed	661	1880	29.37	0.317	1.6
Body-worn	Fixed	810	1909.8	29.22	0.344	1.6
Test Mode: PCS 1900 GPRS 2 Slot						
Body-worn	Fixed	661	1880	29.34	0.515	1.6
Test Mode: PCS 1900 GPRS 3 Slot						
Body-worn	Fixed	661	1880	29.30	0.821	1.6
Test Mode: PCS 1900 GPRS 4 Slot						

Body-worn	Fixed	512	1850.2	28.97	1.01	1.6
Body-worn	Fixed	661	1880	29.19	1.05	1.6
Body-worn	Fixed	810	1909.8	29.04	1.09	1.6
Test Mode: PCS 1900 GPRS 4 Slot <Front>						
Body-worn	Fixed	810	1909.8	29.04	0.328	1.6
Test Mode: PCS 1900 EGPRS 4 Slot						
Body-worn	Fixed	810	1909.8	25.12	1.08	1.6



SAR MEASUREMENT						
Ambient Temperature (°C) : 20.9 ±2			Relative Humidity (%): 51			
Liquid Temperature (°C) : 20.1 ±2			Depth of Liquid (cm):>15			
Product: Smart Handheld						
Test Mode: WCDMA Band V						
Test Position Head/Body	Antenna Position	Frequency		Conducted Power (dBm)	SAR 1g (W/kg)	Limit (W/kg)
		Channel	MHz			
Left-Cheek	Fixed	4132	826.4	23.64	0.116	1.6
Left-Cheek	Fixed	4183	836.6	23.57	0.086	1.6
Left-Cheek	Fixed	4233	846.6	23.08	0.129	1.6
Left-Tilted	Fixed	4132	826.4	23.64	0.159	1.6
Left-Tilted	Fixed	4183	836.6	23.57	0.123	1.6
Left-Tilted	Fixed	4233	846.6	23.08	0.114	1.6
Right-Cheek	Fixed	4132	826.4	23.64	0.150	1.6
Right-Cheek	Fixed	4183	836.6	23.57	0.112	1.6
Right-Cheek	Fixed	4233	846.6	23.08	0.136	1.6
Right-Tilted	Fixed	4132	826.4	23.64	0.137	1.6
Right-Tilted	Fixed	4183	836.6	23.57	0.097	1.6
Right-Tilted	Fixed	4233	846.6	23.08	0.118	1.6
Body-worn	Fixed	4132	826.4	23.64	0.291	1.6
Body-worn	Fixed	4183	836.6	23.57	0.236	1.6
Body-worn	Fixed	4233	846.6	23.08	0.297	1.6
Test Mode: WCDMA Band V HSDPA						
Body-worn	Fixed	4233	846.6	22.83	0.239	1.6
Test Mode: WCDMA Band V HSUPA						
Body-worn	Fixed	4233	846.6	22.76	0.249	1.6

SAR MEASUREMENT						
Ambient Temperature (°C): 20.8 ± 2				Relative Humidity (%): 54		
Liquid Temperature (°C): 20.1 ± 2				Depth of Liquid (cm):>15		
Product: Smart Handheld						
Test Mode: WCDMA Band II						
Test Position Head/Body	Antenna Position	Frequency		Conducted Power (dBm)	SAR 1g (W/kg)	Limit (W/kg)
		Channel	MHz			
Left-Cheek	Fixed	9262	1852.4	24.12	0.277	1.6
Left-Cheek	Fixed	9400	1880	23.96	0.243	1.6
Left-Cheek	Fixed	9538	1907.6	23.36	0.235	1.6
Left-Tilted	Fixed	9262	1852.4	24.12	0.189	1.6
Left-Tilted	Fixed	9400	1880	23.96	0.229	1.6
Left-Tilted	Fixed	9538	1907.6	23.36	0.190	1.6
Right-Cheek	Fixed	9262	1852.4	24.12	0.286	1.6
Right-Cheek	Fixed	9400	1880	23.96	0.289	1.6
Right-Cheek	Fixed	9538	1907.6	23.36	0.276	1.6
Right-Tilted	Fixed	9262	1852.4	24.12	0.224	1.6
Right-Tilted	Fixed	9400	1880	23.96	0.222	1.6
Right-Tilted	Fixed	9538	1907.6	23.36	0.177	1.6
Body-worn	Fixed	9262	1852.4	24.12	0.857	1.6
Body-worn	Fixed	9400	1880	23.96	0.799	1.6
Body-worn	Fixed	9538	1907.6	23.36	0.726	1.6
Test Mode: Test Mode: WCDMA Band II HSDPA						
Body-worn	Fixed	9262	1852.4	23.77	0.640	1.6
Test Mode: Test Mode: WCDMA Band II HSUPA						
Body-worn	Fixed	9262	1852.4	22.99	0.635	1.6

**Appendix****Appendix A. SAR System Validation Data****Appendix B. SAR measurement Data****Appendix C. Test Setup Photographs & EUT Photographs****Appendix D. Probe Calibration Data****Appendix E. Dipole Calibration Data**

## Appendix A. SAR System Validation Data

Date/Time: 12/21/2009

Test Laboratory: Quietek

### SystemPerformanceCheck-835MHz\_Head

**DUT: Dipole 835 MHz; Type: ALS-D-835-S-2; Serial: QTK-315**

Communication System: CW; Frequency: 835 MHz; Duty Cycle: 1:1  
 Medium parameters used:  $f = 835 \text{ MHz}$ ;  $\sigma = 0.92 \text{ mho/m}$ ;  $\epsilon_r = 42$ ;  $\rho = 1000 \text{ kg/m}^3$   
 Phantom section: Flat Section  
 Ambient Temperature ( $^{\circ}\text{C}$ ) : 20.9, Liquid Temperature ( $^{\circ}\text{C}$ ) : 20.1  
 DASY4 Configuration:

- Probe: EX3DV4 - SN3602; ConvF(9.32, 9.32, 9.32); Calibrated: 5/20/2009
- Sensor-Surface: 2mm (Mechanical Surface Detection)
- Electronics: DAE4 Sn1207; Calibrated: 4/7/2009
- Phantom: SAM Left Table; Type: SAM
- Measurement SW: DASY5, V5.0 Build 125; SEMCAD X Version 13.4 Build 125

**835MHz\_Head/Area Scan (7x9x1):** Measurement grid:  $dx=15\text{mm}$ ,  $dy=15\text{mm}$   
 Maximum value of SAR (measured) = 2.65 mW/g

**835MHz\_Head/Zoom Scan (7x7x7) (5x5x7)/Cube 0:** Measurement grid:  $dx=8\text{mm}$ ,  $dy=8\text{mm}$ ,  $dz=5\text{mm}$   
 Reference Value = 56.2 V/m; Power Drift = -0.055 dB  
 Peak SAR (extrapolated) = 3.57 W/kg  
**SAR(1 g) = 2.41 mW/g; SAR(10 g) = 1.59 mW/g**  
 Maximum value of SAR (measured) = 2.98 mW/g

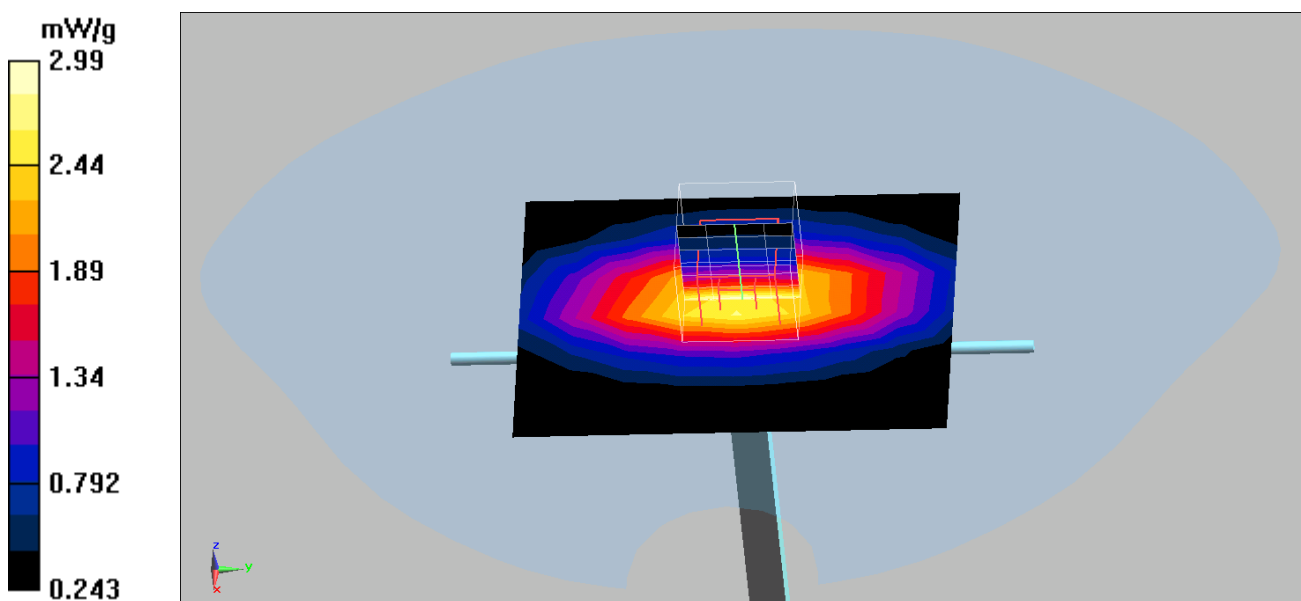

Date/Time: 12/22/2009

Test Laboratory: Quietek CORP

## System Performance Check\_1900MHz-Head

**DUT: Dipole 1900 MHz; Type: ALS-D-1900-S-2; Serial: QTK-318**

Communication System: CW; Frequency: 1900 MHz; Duty Cycle: 1:1  
 Medium parameters used:  $f = 1900 \text{ MHz}$ ;  $\sigma = 1.4 \text{ mho/m}$ ;  $\epsilon_r = 39.1$ ;  $\rho = 1000 \text{ kg/m}^3$   
 Phantom section: Flat Section  
 Ambient Temperature ( $^{\circ}\text{C}$ ) : 20.8, Liquid Temperature ( $^{\circ}\text{C}$ ) : 20.1  
 DASY4 Configuration:

- Probe: EX3DV4 - SN3602; ConvF(7.81, 7.81, 7.81); Calibrated: 5/20/2009
- Sensor-Surface: 2mm (Mechanical Surface Detection)
- Electronics: DAE4 Sn1207; Calibrated: 4/7/2009
- Phantom: SAM Right Table; Type: SAM
- Measurement SW: DASY5, V5.0 Build 125; SEMCAD X Version 13.4 Build 125

### **d=10mm, Pin=250mW, dist=4.0mm (EX-Probe)/Area Scan (7x7x1):**

Measurement grid:  $dx=15\text{mm}$ ,  $dy=15\text{mm}$   
 Maximum value of SAR (measured) = 9.57 mW/g

### **d=10mm, Pin=250mW, dist=4.0mm (EX-Probe)/Zoom Scan (7x7x7)**

**(7x7x7)/Cube 0:** Measurement grid:  $dx=5\text{mm}$ ,  $dy=5\text{mm}$ ,  $dz=5\text{mm}$   
 Reference Value = 96.4 V/m; Power Drift = 0.073 dB  
 Peak SAR (extrapolated) = 18.1 W/kg  
**SAR(1 g) = 9.35 mW/g; SAR(10 g) = 4.97 mW/g**  
 Maximum value of SAR (measured) = 13.8 mW/g

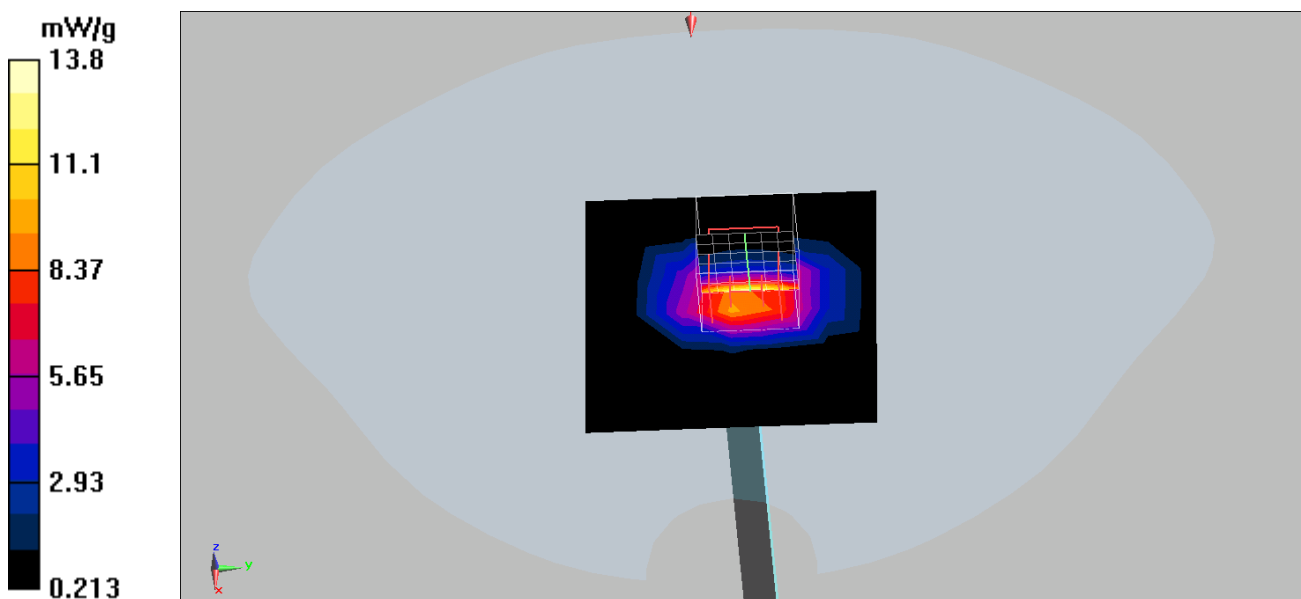

Date/Time: 1/15/2010

Test Laboratory: Quietek

**System Performance Check\_1900MHz-Head**

**DUT: Dipole 1900 MHz; Type: ALS-D-1900-S-2; Serial: QTK-318**

Communication System: CW; Frequency: 1900 MHz; Duty Cycle: 1:1

Medium parameters used:  $f = 1900 \text{ MHz}$ ;  $\sigma = 1.41 \text{ mho/m}$ ;  $\epsilon_r = 40.1$ ;  $\rho = 1000 \text{ kg/m}^3$

Phantom section: Flat Section

DASY4 Configuration:

- Probe: EX3DV4 - SN3602; ConvF(7.81, 7.81, 7.81); Calibrated: 5/20/2009
- Sensor-Surface: 2mm (Mechanical Surface Detection)
- Electronics: DAE4 Sn1207; Calibrated: 4/7/2009
- Phantom: SAM Right Table; Type: SAM
- Measurement SW: DASY5, V5.0 Build 125; SEMCAD X Version 13.4 Build 125

**1900MHz\_Head/Area Scan (7x7x1):** Measurement grid:  $dx=15\text{mm}$ ,  $dy=15\text{mm}$   
 Maximum value of SAR (measured) = 10.9 mW/g

**1900MHz\_Head/Zoom Scan (7x7x7) (7x7x7)/Cube 0:** Measurement grid:  $dx=5\text{mm}$ ,  $dy=5\text{mm}$ ,  $dz=5\text{mm}$

Reference Value = 97 V/m; Power Drift = 0.024 dB

Peak SAR (extrapolated) = 17.7 W/kg

**SAR(1 g) = 8.94 mW/g; SAR(10 g) = 5.3 mW/g**

Maximum value of SAR (measured) = 13.2 mW/g

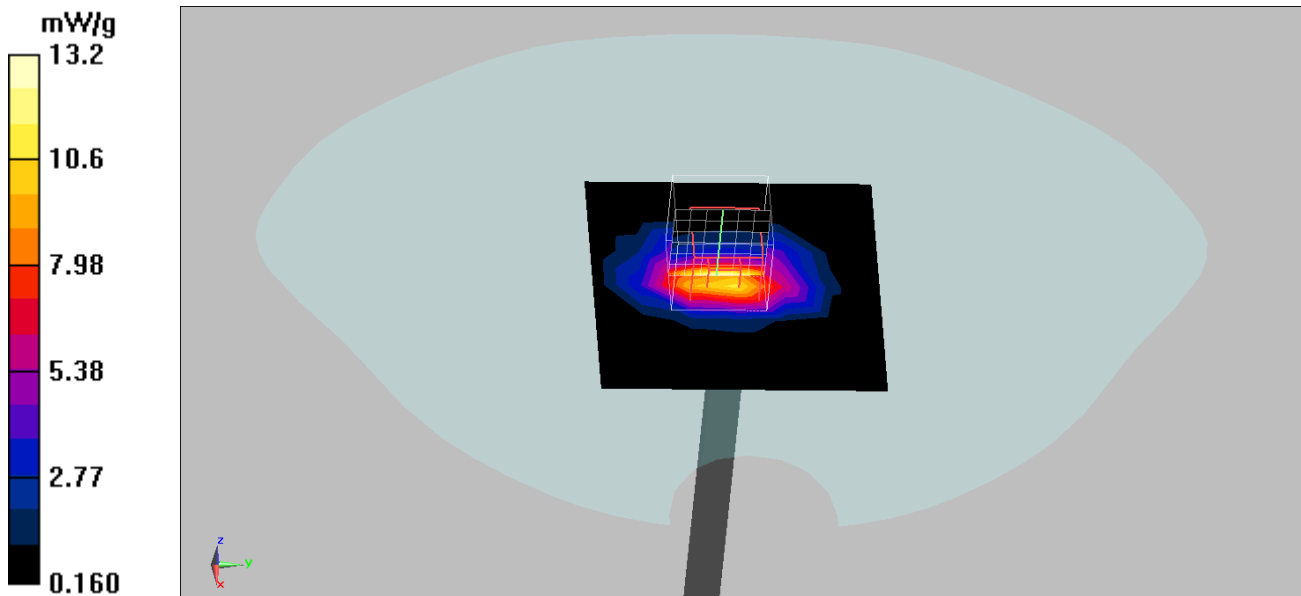

## Appendix B. SAR measurement Data

Date/Time: 12/21/2009

Test Laboratory: Quietek

### GSM850\_Left-Cheek\_Channel-128

**DUT: Smart Handheld; Type: M900DF**

Communication System: FCC GSM\_850MHz; Frequency: 824.2 MHz; Duty Cycle: 1:8.3

Medium parameters used:  $f = 824.2$  MHz;  $\sigma = 0.91$  mho/m;  $\epsilon_r = 42.4$ ;  $\rho = 1000$  kg/m<sup>3</sup>

Phantom section: Left Section

Ambient Temperature (°C) : 20.9, Liquid Temperature (°C) : 20.1

DASY4 Configuration:

- Probe: EX3DV4 - SN3602; ConvF(9.14, 9.14, 9.14); Calibrated: 5/20/2009
- Sensor-Surface: 4mm (Mechanical Surface Detection)
- Electronics: DAE4 Sn1207; Calibrated: 4/7/2009
- Phantom: SAM Left Table; Type: SAM;
- Measurement SW: DASY5, V5.0 Build 125; SEMCAD X Version 13.4 Build 125

**GSM850/Area Scan (7x11x1):** Measurement grid: dx=15mm, dy=15mm

Maximum value of SAR (measured) = 0.110 mW/g

**GSM850/Zoom Scan (7x7x7) (7x7x7)/Cube 0:** Measurement grid: dx=5mm, dy=5mm, dz=5mm

Reference Value = 0.840 V/m; Power Drift = 0.106 dB

Peak SAR (extrapolated) = 0.130 W/kg

**SAR(1 g) = 0.106 mW/g; SAR(10 g) = 0.081 mW/g**

Maximum value of SAR (measured) = 0.112 mW/g

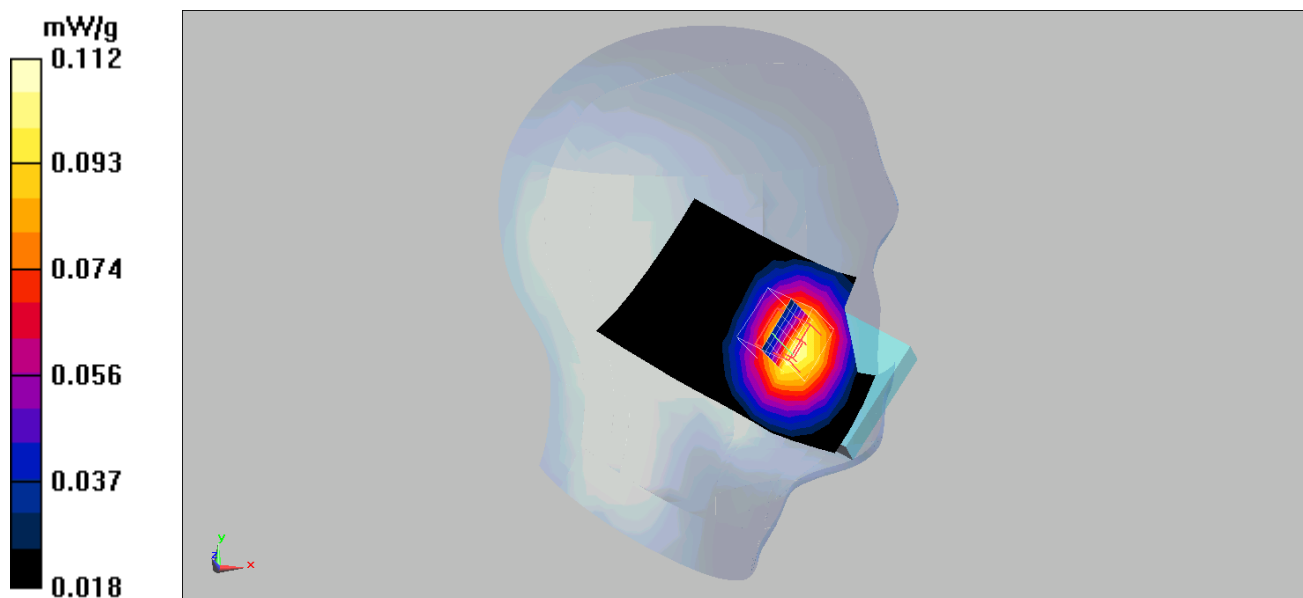

Date/Time: 12/21/2009

Test Laboratory: Quietek

**GSM850\_Left-Cheek\_Channel-189**

**DUT: Smart Handheld; Type: M900DF**

Communication System: FCC GSM\_850MHz; Frequency: 836.4 MHz; Duty Cycle: 1:8.3

Medium parameters used:  $f = 836.4 \text{ MHz}$ ;  $\sigma = 0.92 \text{ mho/m}$ ;  $\epsilon_r = 41.8$ ;  $\rho = 1000 \text{ kg/m}^3$

Phantom section: Left Section

Ambient Temperature ( $^{\circ}\text{C}$ ) : 20.9, Liquid Temperature ( $^{\circ}\text{C}$ ) : 20.1

DASY4 Configuration:

- Probe: EX3DV4 - SN3602; ConvF(9.14, 9.14, 9.14); Calibrated: 5/20/2009
- Sensor-Surface: 4mm (Mechanical Surface Detection)
- Electronics: DAE4 Sn1207; Calibrated: 4/7/2009
- Phantom: SAM Left Table; Type: SAM;
- Measurement SW: DASY5, V5.0 Build 125; SEMCAD X Version 13.4 Build 125

**GSM850/Area Scan (7x11x1):** Measurement grid: dx=15mm, dy=15mm

Maximum value of SAR (measured) = 0.130 mW/g

**GSM850/Zoom Scan (7x7x7) (7x7x7)/Cube 0:** Measurement grid: dx=5mm, dy=5mm, dz=5mm

Reference Value = 2.8 V/m; Power Drift = -0.126 dB

Peak SAR (extrapolated) = 0.155 W/kg

**SAR(1 g) = 0.125 mW/g; SAR(10 g) = 0.097 mW/g**

Maximum value of SAR (measured) = 0.133 mW/g

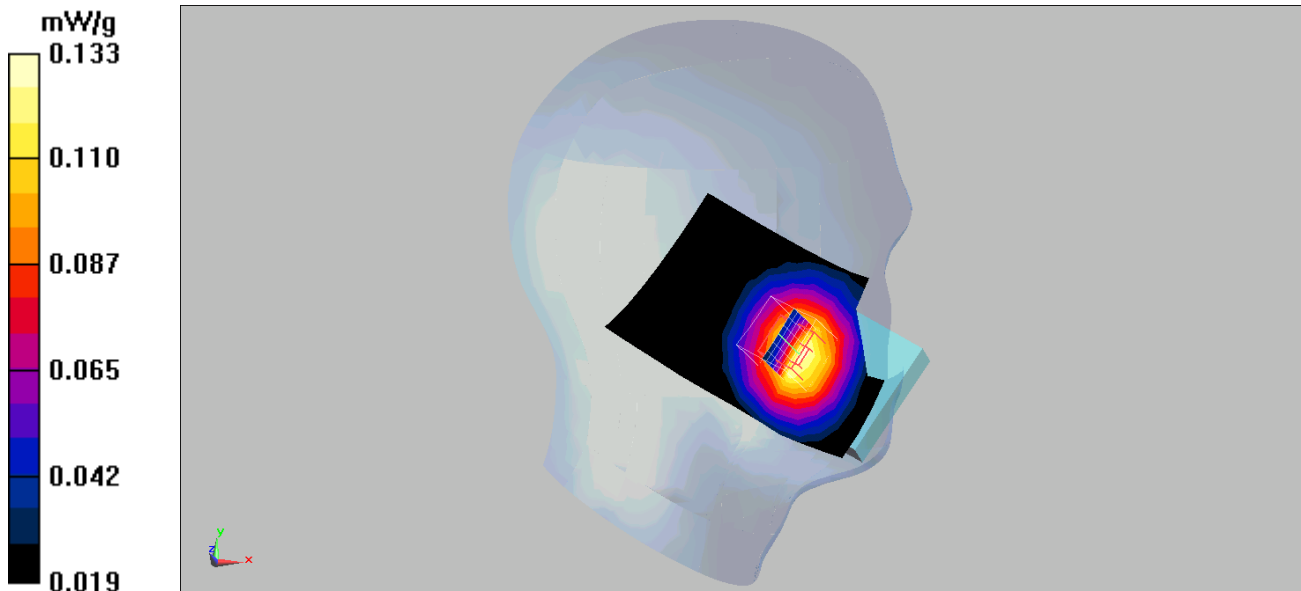



Date/Time: 12/21/2009

Test Laboratory: Quietek

**GSM850\_Left-Cheek\_Channel-251**

**DUT: Smart Handheld; Type: M900DF**

Communication System: FCC GSM\_850MHz; Frequency: 848.8 MHz; Duty Cycle: 1:8.3

Medium parameters used:  $f = 848.8 \text{ MHz}$ ;  $\sigma = 0.94 \text{ mho/m}$ ;  $\epsilon_r = 41.2$ ;  $\rho = 1000 \text{ kg/m}^3$

Phantom section: Left Section

Ambient Temperature ( $^{\circ}\text{C}$ ) : 20.9, Liquid Temperature ( $^{\circ}\text{C}$ ) : 20.1

DASY4 Configuration:

- Probe: EX3DV4 - SN3602; ConvF(9.14, 9.14, 9.14); Calibrated: 5/20/2009
- Sensor-Surface: 4mm (Mechanical Surface Detection)
- Electronics: DAE4 Sn1207; Calibrated: 4/7/2009
- Phantom: SAM Left Table; Type: SAM;
- Measurement SW: DASY5, V5.0 Build 125; SEMCAD X Version 13.4 Build 125

**GSM850/Area Scan (7x11x1):** Measurement grid:  $dx=15\text{mm}$ ,  $dy=15\text{mm}$

Maximum value of SAR (measured) = 0.147 mW/g

**GSM850/Zoom Scan (7x7x7) (7x7x7)/Cube 0:** Measurement grid:  $dx=5\text{mm}$ ,  $dy=5\text{mm}$ ,  $dz=5\text{mm}$

Reference Value = 2.69 V/m; Power Drift = 0.159 dB

Peak SAR (extrapolated) = 0.169 W/kg

**SAR(1 g) = 0.141 mW/g; SAR(10 g) = 0.109 mW/g**

Maximum value of SAR (measured) = 0.148 mW/g

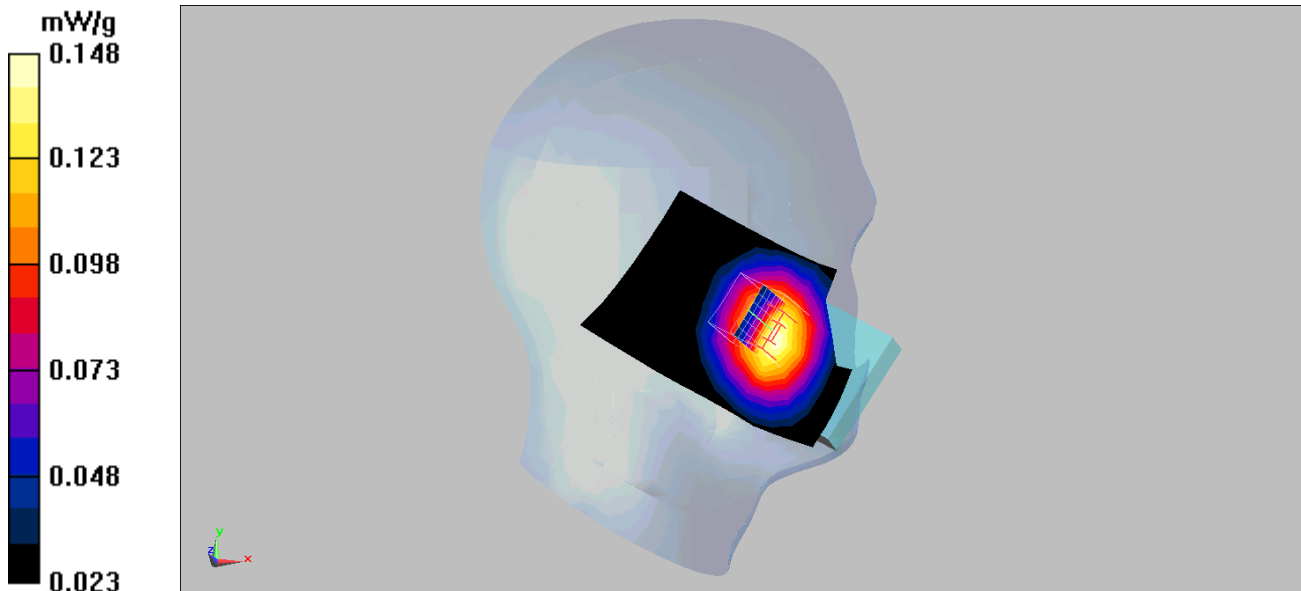

Date/Time: 12/21/2009

Test Laboratory: Quietek

### GSM850\_Left-Tilt\_Channel-128

**DUT: Smart Handheld; Type: M900DF**

Communication System: FCC GSM\_850MHz; Frequency: 824.2 MHz; Duty Cycle: 1:8.3

Medium parameters used:  $f = 824.2$  MHz;  $\sigma = 0.91$  mho/m;  $\epsilon_r = 42.4$ ;  $\rho = 1000$  kg/m<sup>3</sup>

Phantom section: Left Section

Ambient Temperature (°C) : 20.9, Liquid Temperature (°C) : 20.1

DASY4 Configuration:

- Probe: EX3DV4 - SN3602; ConvF(9.14, 9.14, 9.14); Calibrated: 5/20/2009
- Sensor-Surface: 4mm (Mechanical Surface Detection)
- Electronics: DAE4 Sn1207; Calibrated: 4/7/2009
- Phantom: SAM Left Table; Type: SAM;
- Measurement SW: DASY5, V5.0 Build 125; SEMCAD X Version 13.4 Build 125

**GSM850/Area Scan (7x11x1):** Measurement grid: dx=15mm, dy=15mm

Maximum value of SAR (measured) = 0.152 mW/g

**GSM850/Zoom Scan (7x7x7) (7x7x7)/Cube 0:** Measurement grid: dx=5mm, dy=5mm, dz=5mm

Reference Value = 8 V/m; Power Drift = -0.081 dB

Peak SAR (extrapolated) = 0.176 W/kg

**SAR(1 g) = 0.143 mW/g; SAR(10 g) = 0.110 mW/g**

Maximum value of SAR (measured) = 0.149 mW/g

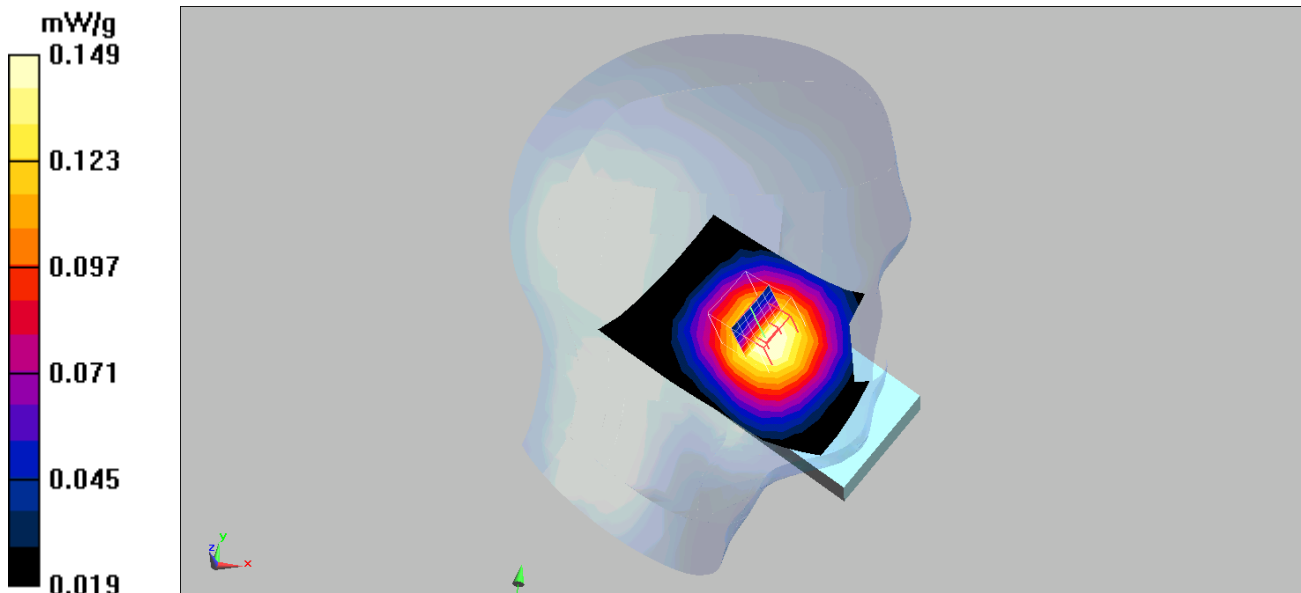

Date/Time: 12/21/2009

Test Laboratory: Quietek

**GSM850\_Left-Tilt\_Channel-189**

**DUT: Smart Handheld; Type: M900DF**

Communication System: FCC GSM\_850MHz; Frequency: 836.4 MHz; Duty Cycle: 1:8.3

Medium parameters used:  $f = 836.4$  MHz;  $\sigma = 0.92$  mho/m;  $\epsilon_r = 41.8$ ;  $\rho = 1000$  kg/m<sup>3</sup>

Phantom section: Left Section

Ambient Temperature (°C) : 20.9, Liquid Temperature (°C) : 20.1

DASY4 Configuration:

- Probe: EX3DV4 - SN3602; ConvF(9.14, 9.14, 9.14); Calibrated: 5/20/2009
- Sensor-Surface: 4mm (Mechanical Surface Detection)
- Electronics: DAE4 Sn1207; Calibrated: 4/7/2009
- Phantom: SAM Left Table; Type: SAM;
- Measurement SW: DASY5, V5.0 Build 125; SEMCAD X Version 13.4 Build 125

**GSM850/Area Scan (7x11x1):** Measurement grid: dx=15mm, dy=15mm

Maximum value of SAR (measured) = 0.134 mW/g

**GSM850/Zoom Scan (7x7x7) (7x7x7)/Cube 0:** Measurement grid: dx=5mm, dy=5mm, dz=5mm

Reference Value = 7.27 V/m; Power Drift = -0.128 dB

Peak SAR (extrapolated) = 0.159 W/kg

**SAR(1 g) = 0.129 mW/g; SAR(10 g) = 0.099 mW/g**

Maximum value of SAR (measured) = 0.135 mW/g

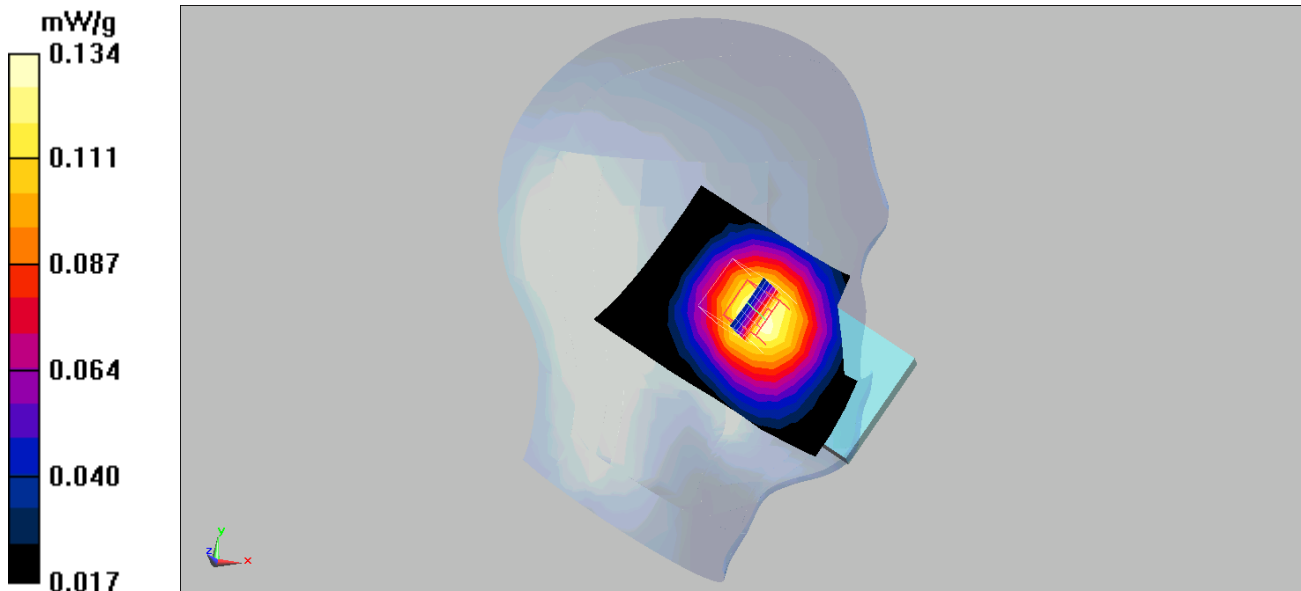

Date/Time: 12/21/2009

Test Laboratory: Quietek

### GSM850\_Left-Tilt\_Channel-251

**DUT: Smart Handheld; Type: M900DF**

Communication System: FCC GSM\_850MHz; Frequency: 848.8 MHz; Duty Cycle: 1:8.3

Medium parameters used:  $f = 848.8 \text{ MHz}$ ;  $\sigma = 0.94 \text{ mho/m}$ ;  $\epsilon_r = 41.2$ ;  $\rho = 1000 \text{ kg/m}^3$

Phantom section: Left Section

Ambient Temperature ( $^{\circ}\text{C}$ ) : 20.9, Liquid Temperature ( $^{\circ}\text{C}$ ) : 20.1

DASY4 Configuration:

- Probe: EX3DV4 - SN3602; ConvF(9.14, 9.14, 9.14); Calibrated: 5/20/2009
- Sensor-Surface: 4mm (Mechanical Surface Detection)
- Electronics: DAE4 Sn1207; Calibrated: 4/7/2009
- Phantom: SAM Left Table; Type: SAM;
- Measurement SW: DASY5, V5.0 Build 125; SEMCAD X Version 13.4 Build 125

**GSM850/Area Scan (7x11x1):** Measurement grid: dx=15mm, dy=15mm

Maximum value of SAR (measured) = 0.120 mW/g

**GSM850/Zoom Scan (7x7x7) (7x7x7)/Cube 0:** Measurement grid: dx=5mm, dy=5mm, dz=5mm

Reference Value = 6.84 V/m; Power Drift = -0.052 dB

Peak SAR (extrapolated) = 0.145 W/kg

**SAR(1 g) = 0.118 mW/g; SAR(10 g) = 0.091 mW/g**

Maximum value of SAR (measured) = 0.123 mW/g

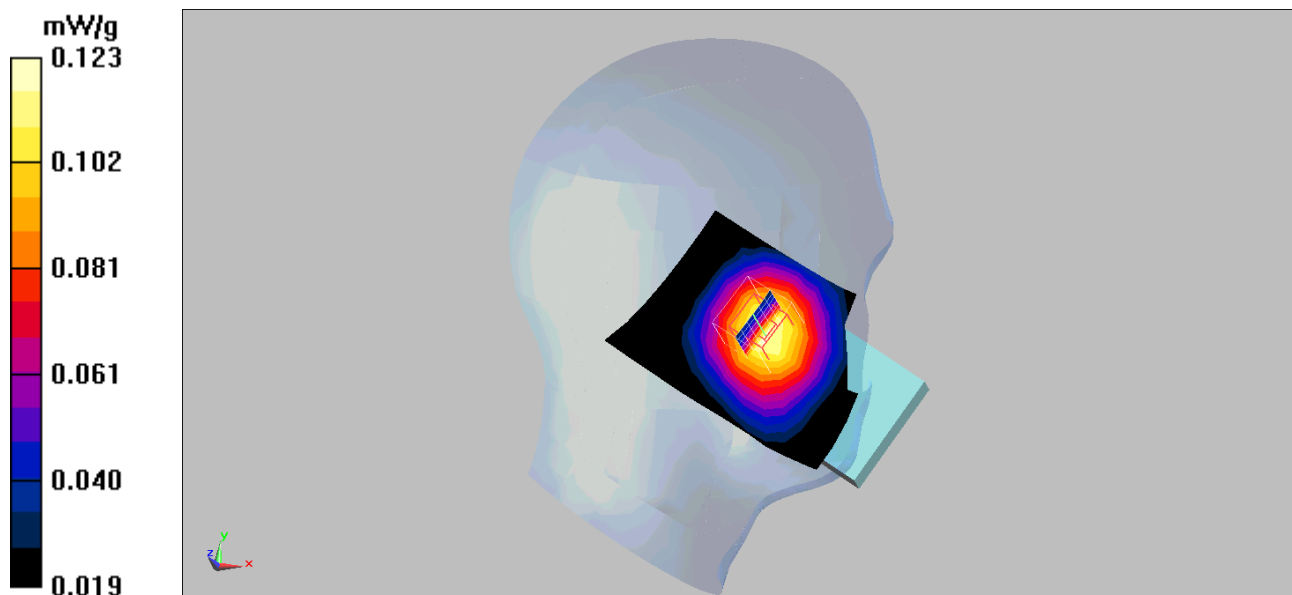

Date/Time: 12/21/2009

Test Laboratory: Quietek

**GSM850\_Right-Cheek\_Channel-128**

**DUT: Smart Handheld; Type: M900DF**

Communication System: FCC GSM\_850MHz; Frequency: 824.2 MHz; Duty Cycle: 1:8.3

Medium parameters used:  $f = 824.2$  MHz;  $\sigma = 0.91$  mho/m;  $\epsilon_r = 42.4$ ;  $\rho = 1000$  kg/m<sup>3</sup>

Phantom section: Right Section

Ambient Temperature (°C) : 20.9, Liquid Temperature (°C) : 20.1

DASY4 Configuration:

- Probe: EX3DV4 - SN3602; ConvF(9.14, 9.14, 9.14); Calibrated: 5/20/2009
- Sensor-Surface: 4mm (Mechanical Surface Detection)
- Electronics: DAE4 Sn1207; Calibrated: 4/7/2009
- Phantom: SAM Left Table; Type: SAM;
- Measurement SW: DASY5, V5.0 Build 125; SEMCAD X Version 13.4 Build 125

**GSM850/Area Scan (7x11x1):** Measurement grid: dx=15mm, dy=15mm

Maximum value of SAR (measured) = 0.130 mW/g

**GSM850/Zoom Scan (7x7x7) (7x7x7)/Cube 0:** Measurement grid: dx=5mm, dy=5mm, dz=5mm

Reference Value = 3.72 V/m; Power Drift = 0.143 dB

Peak SAR (extrapolated) = 0.152 W/kg

**SAR(1 g) = 0.125 mW/g; SAR(10 g) = 0.096 mW/g**

Maximum value of SAR (measured) = 0.132 mW/g

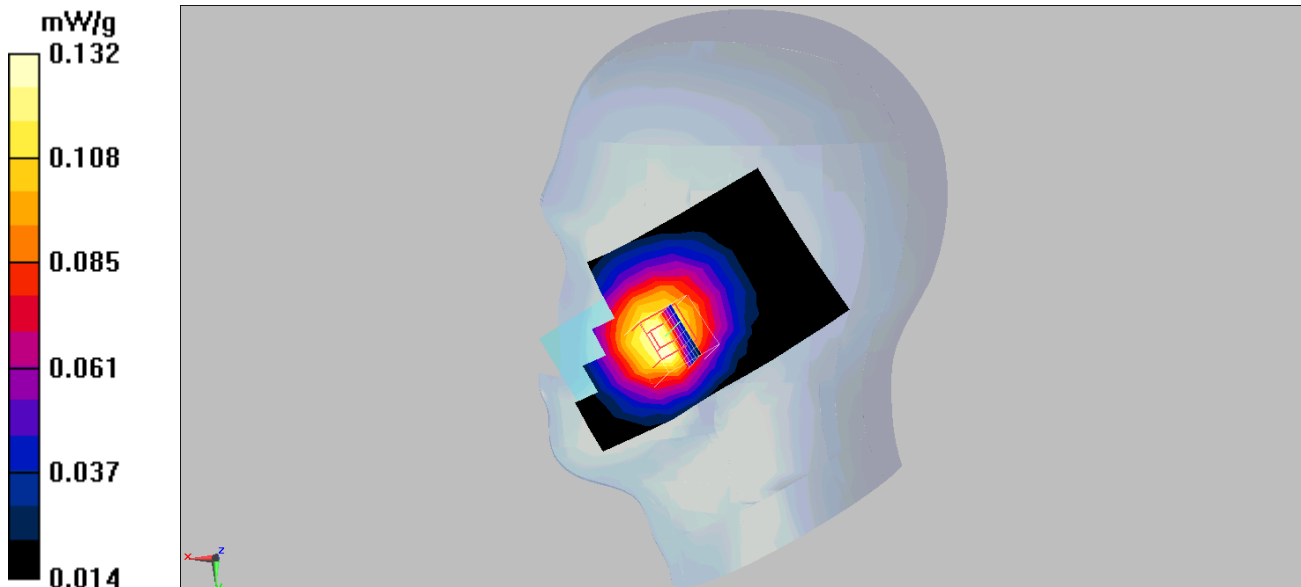

Date/Time: 12/21/2009

Test Laboratory: Quietek

**GSM850\_Right-Cheek\_Channel-189**

**DUT: Smart Handheld; Type: M900DF**

Communication System: FCC GSM\_850MHz; Frequency: 836.4 MHz; Duty Cycle: 1:8.3

Medium parameters used:  $f = 836.4$  MHz;  $\sigma = 0.92$  mho/m;  $\epsilon_r = 41.8$ ;  $\rho = 1000$  kg/m<sup>3</sup>

Phantom section: Right Section

Ambient Temperature (°C) : 20.9, Liquid Temperature (°C) : 20.1

DASY4 Configuration:

- Probe: EX3DV4 - SN3602; ConvF(9.14, 9.14, 9.14); Calibrated: 5/20/2009
- Sensor-Surface: 4mm (Mechanical Surface Detection)
- Electronics: DAE4 Sn1207; Calibrated: 4/7/2009
- Phantom: SAM Left Table; Type: SAM;
- Measurement SW: DASY5, V5.0 Build 125; SEMCAD X Version 13.4 Build 125

**GSM850/Area Scan (7x11x1):** Measurement grid: dx=15mm, dy=15mm

Maximum value of SAR (measured) = 0.129 mW/g

**GSM850/Zoom Scan (7x7x7) (7x7x7)/Cube 0:** Measurement grid: dx=5mm, dy=5mm, dz=5mm

Reference Value = 3.62 V/m; Power Drift = 0.102 dB

Peak SAR (extrapolated) = 0.151 W/kg

**SAR(1 g) = 0.124 mW/g; SAR(10 g) = 0.097 mW/g**

Maximum value of SAR (measured) = 0.130 mW/g

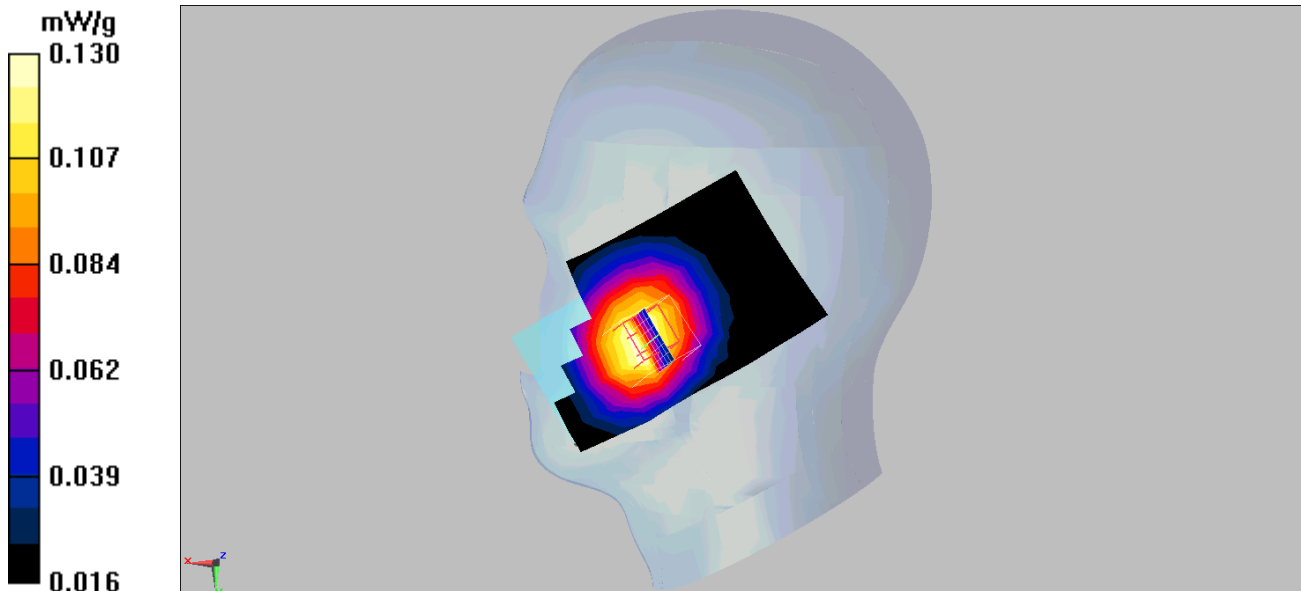

Date/Time: 12/21/2009

Test Laboratory: Quietek

**GSM850\_Right-Cheek\_Channel-251**

**DUT: Smart Handheld; Type: M900DF**

Communication System: FCC GSM\_850MHz; Frequency: 848.8 MHz; Duty Cycle: 1:8.3

Medium parameters used:  $f = 848.8 \text{ MHz}$ ;  $\sigma = 0.94 \text{ mho/m}$ ;  $\epsilon_r = 41.2$ ;  $\rho = 1000 \text{ kg/m}^3$

Phantom section: Right Section

Ambient Temperature ( $^{\circ}\text{C}$ ) : 20.9, Liquid Temperature ( $^{\circ}\text{C}$ ) : 20.1

DASY4 Configuration:

- Probe: EX3DV4 - SN3602; ConvF(9.14, 9.14, 9.14); Calibrated: 5/20/2009
- Sensor-Surface: 4mm (Mechanical Surface Detection)
- Electronics: DAE4 Sn1207; Calibrated: 4/7/2009
- Phantom: SAM Left Table; Type: SAM;
- Measurement SW: DASY5, V5.0 Build 125; SEMCAD X Version 13.4 Build 125

**GSM850/Area Scan (7x11x1):** Measurement grid: dx=15mm, dy=15mm

Maximum value of SAR (measured) = 0.106 mW/g

**GSM850/Zoom Scan (7x7x7) (7x7x7)/Cube 0:** Measurement grid: dx=5mm, dy=5mm, dz=5mm

Reference Value = 3.31 V/m; Power Drift = 0.131 dB

Peak SAR (extrapolated) = 0.126 W/kg

**SAR(1 g) = 0.106 mW/g; SAR(10 g) = 0.083 mW/g**

Maximum value of SAR (measured) = 0.111 mW/g

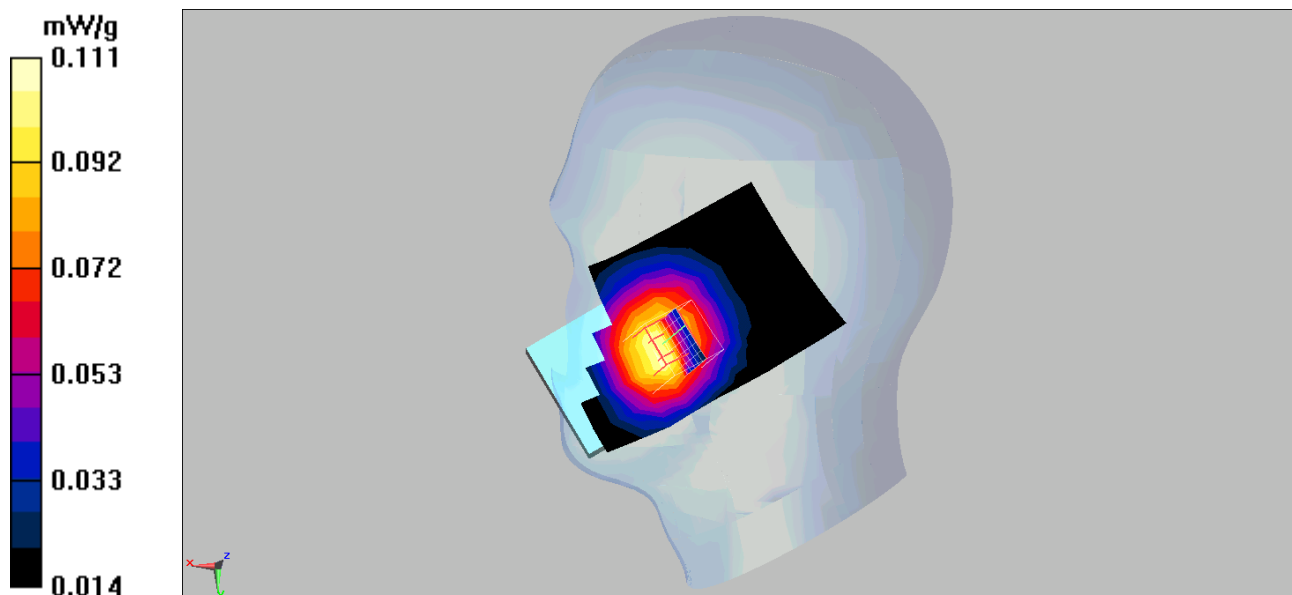

Date/Time: 12/21/2009

Test Laboratory: Quietek

**GSM850\_Right-Tilt\_Channel-128**

**DUT: Smart Handheld; Type: M900DF**

Communication System: FCC GSM\_850MHz; Frequency: 824.2 MHz; Duty Cycle: 1:8.3

Medium parameters used:  $f = 824.2 \text{ MHz}$ ;  $\sigma = 0.91 \text{ mho/m}$ ;  $\epsilon_r = 42.4$ ;  $\rho = 1000 \text{ kg/m}^3$

Phantom section: Right Section

Ambient Temperature ( $^{\circ}\text{C}$ ) : 20.9, Liquid Temperature ( $^{\circ}\text{C}$ ) : 20.1

DASY4 Configuration:

- Probe: EX3DV4 - SN3602; ConvF(9.14, 9.14, 9.14); Calibrated: 5/20/2009
- Sensor-Surface: 4mm (Mechanical Surface Detection)
- Electronics: DAE4 Sn1207; Calibrated: 4/7/2009
- Phantom: SAM Left Table; Type: SAM;
- Measurement SW: DASY5, V5.0 Build 125; SEMCAD X Version 13.4 Build 125

**GSM850/Area Scan (7x11x1):** Measurement grid: dx=15mm, dy=15mm

Maximum value of SAR (measured) = 0.115 mW/g

**GSM850/Zoom Scan (7x7x7) (7x7x7)/Cube 0:** Measurement grid: dx=5mm, dy=5mm, dz=5mm

Reference Value = 6.42 V/m; Power Drift = 0.138 dB

Peak SAR (extrapolated) = 0.138 W/kg

**SAR(1 g) = 0.113 mW/g; SAR(10 g) = 0.088 mW/g**

Maximum value of SAR (measured) = 0.117 mW/g

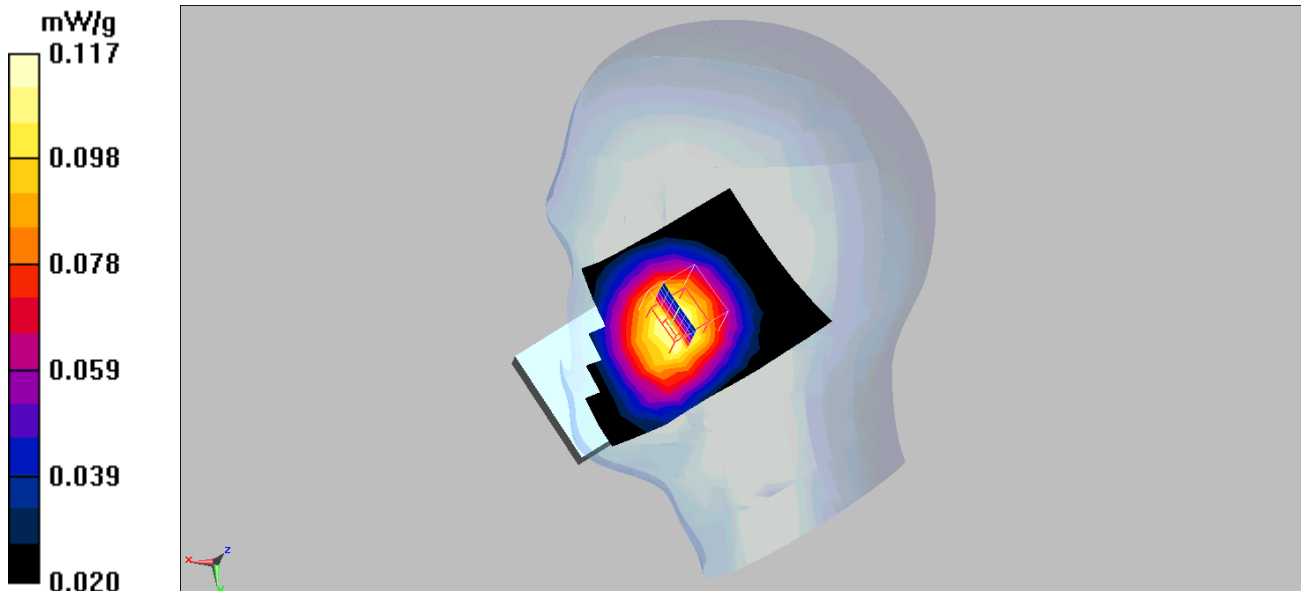



Date/Time: 12/21/2009

Test Laboratory: Quietek

**GSM850\_Right-Tilt\_Channel-189**

**DUT: Smart Handheld; Type: M900DF**

Communication System: FCC GSM\_850MHz; Frequency: 836.4 MHz; Duty Cycle: 1:8.3

Medium parameters used:  $f = 836.4 \text{ MHz}$ ;  $\sigma = 0.92 \text{ mho/m}$ ;  $\epsilon_r = 41.8$ ;  $\rho = 1000 \text{ kg/m}^3$

Phantom section: Right Section

Ambient Temperature ( $^{\circ}\text{C}$ ) : 20.9, Liquid Temperature ( $^{\circ}\text{C}$ ) : 20.1

DASY4 Configuration:

- Probe: EX3DV4 - SN3602; ConvF(9.14, 9.14, 9.14); Calibrated: 5/20/2009
- Sensor-Surface: 4mm (Mechanical Surface Detection)
- Electronics: DAE4 Sn1207; Calibrated: 4/7/2009
- Phantom: SAM Left Table; Type: SAM;
- Measurement SW: DASY5, V5.0 Build 125; SEMCAD X Version 13.4 Build 125

**GSM850/Area Scan (7x11x1):** Measurement grid: dx=15mm, dy=15mm

Maximum value of SAR (measured) = 0.125 mW/g

**GSM850/Zoom Scan (7x7x7) (7x7x7)/Cube 0:** Measurement grid: dx=5mm, dy=5mm, dz=5mm

Reference Value = 5.04 V/m; Power Drift = -0.036 dB

Peak SAR (extrapolated) = 0.145 W/kg

**SAR(1 g) = 0.119 mW/g; SAR(10 g) = 0.093 mW/g**

Maximum value of SAR (measured) = 0.124 mW/g

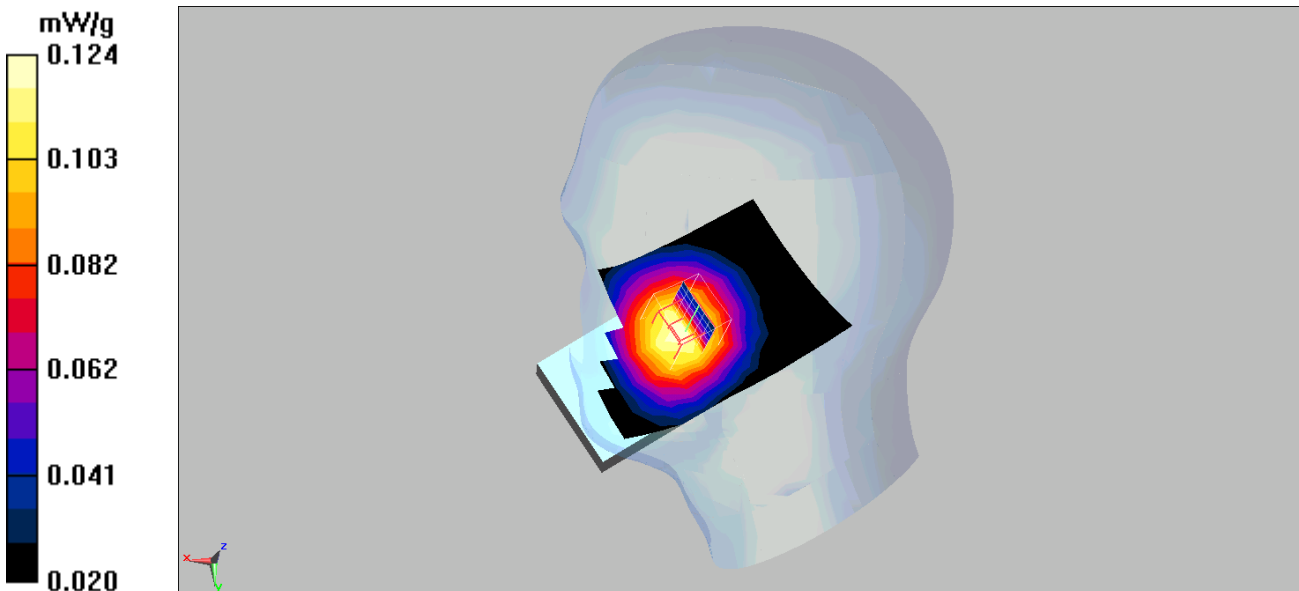

Date/Time: 12/21/2009

Test Laboratory: Quietek

**GSM850\_Right-Tilt\_Channel-251**

**DUT: Smart Handheld; Type: M900DF**

Communication System: FCC GSM\_850MHz; Frequency: 848.8 MHz; Duty Cycle: 1:8.3

Medium parameters used:  $f = 848.8 \text{ MHz}$ ;  $\sigma = 0.94 \text{ mho/m}$ ;  $\epsilon_r = 41.2$ ;  $\rho = 1000 \text{ kg/m}^3$

Phantom section: Right Section

Ambient Temperature ( $^{\circ}\text{C}$ ) : 20.9, Liquid Temperature ( $^{\circ}\text{C}$ ) : 20.1

DASY4 Configuration:

- Probe: EX3DV4 - SN3602; ConvF(9.14, 9.14, 9.14); Calibrated: 5/20/2009
- Sensor-Surface: 4mm (Mechanical Surface Detection)
- Electronics: DAE4 Sn1207; Calibrated: 4/7/2009
- Phantom: SAM Left Table; Type: SAM;
- Measurement SW: DASY5, V5.0 Build 125; SEMCAD X Version 13.4 Build 125

**GSM850/Area Scan (7x11x1):** Measurement grid: dx=15mm, dy=15mm

Maximum value of SAR (measured) = 0.105 mW/g

**GSM850/Zoom Scan (7x7x7) (7x7x7)/Cube 0:** Measurement grid: dx=5mm, dy=5mm, dz=5mm

Reference Value = 4.3 V/m; Power Drift = 0.163 dB

Peak SAR (extrapolated) = 0.122 W/kg

**SAR(1 g) = 0.100 mW/g; SAR(10 g) = 0.078 mW/g**

Maximum value of SAR (measured) = 0.106 mW/g

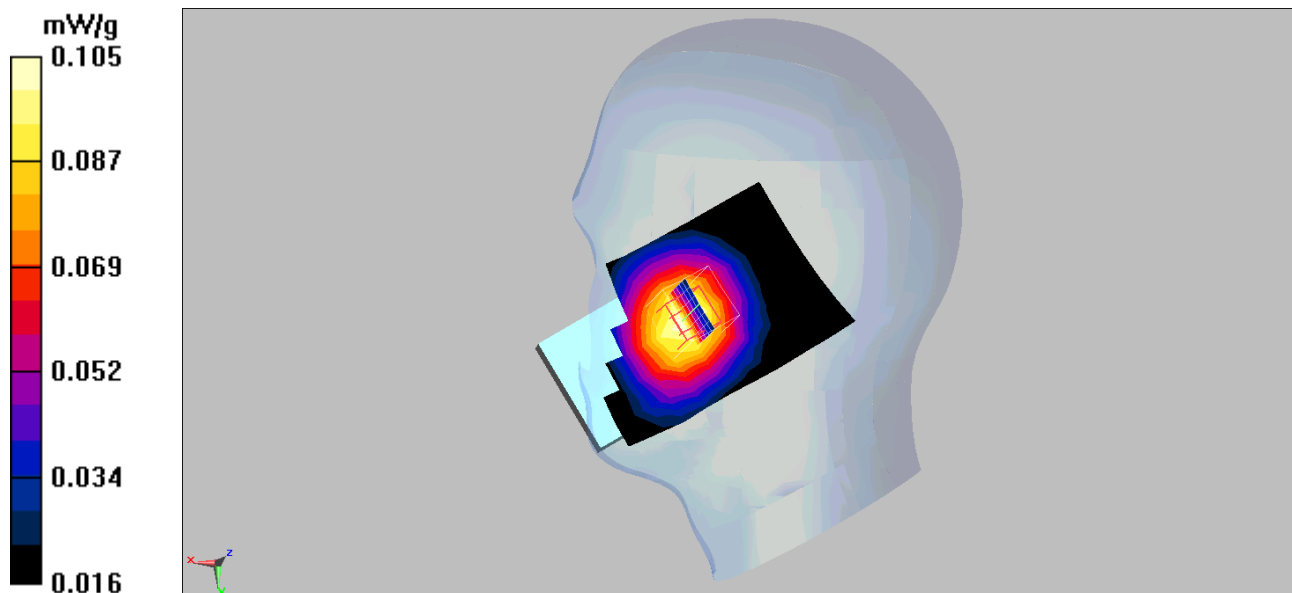

Date/Time: 12/21/2009

Test Laboratory: Quietek

### GSM850\_Body\_Channel-128

**DUT: Smart Handheld; Type: M900DF**

Communication System: FCC GSM\_850MHz; Frequency: 824.2 MHz; Duty Cycle: 1:8.3

Medium parameters used:  $f = 824.2$  MHz;  $\sigma = 0.95$  mho/m;  $\epsilon_r = 54.5$ ;  $\rho = 1000$  kg/m<sup>3</sup>

Phantom section: Flat Section

Ambient Temperature (°C) : 20.9, Liquid Temperature (°C) : 20.1

DASY4 Configuration:

- Probe: EX3DV4 - SN3602; ConvF(9.32, 9.32, 9.32); Calibrated: 5/20/2009
- Sensor-Surface: 4mm (Mechanical Surface Detection)
- Electronics: DAE4 Sn1207; Calibrated: 4/7/2009
- Phantom: SAM Left Table; Type: SAM;
- Measurement SW: DASY5, V5.0 Build 125; SEMCAD X Version 13.4 Build 125

**GSM850/Area Scan (7x11x1):** Measurement grid: dx=15mm, dy=15mm

Maximum value of SAR (measured) = 0.314 mW/g

**GSM850/Zoom Scan (7x7x7) (7x7x7)/Cube 0:** Measurement grid: dx=5mm, dy=5mm, dz=5mm

Reference Value = 8.12 V/m; Power Drift = -0.124 dB

Peak SAR (extrapolated) = 0.373 W/kg

**SAR(1 g) = 0.282 mW/g; SAR(10 g) = 0.212 mW/g**

Maximum value of SAR (measured) = 0.298 mW/g

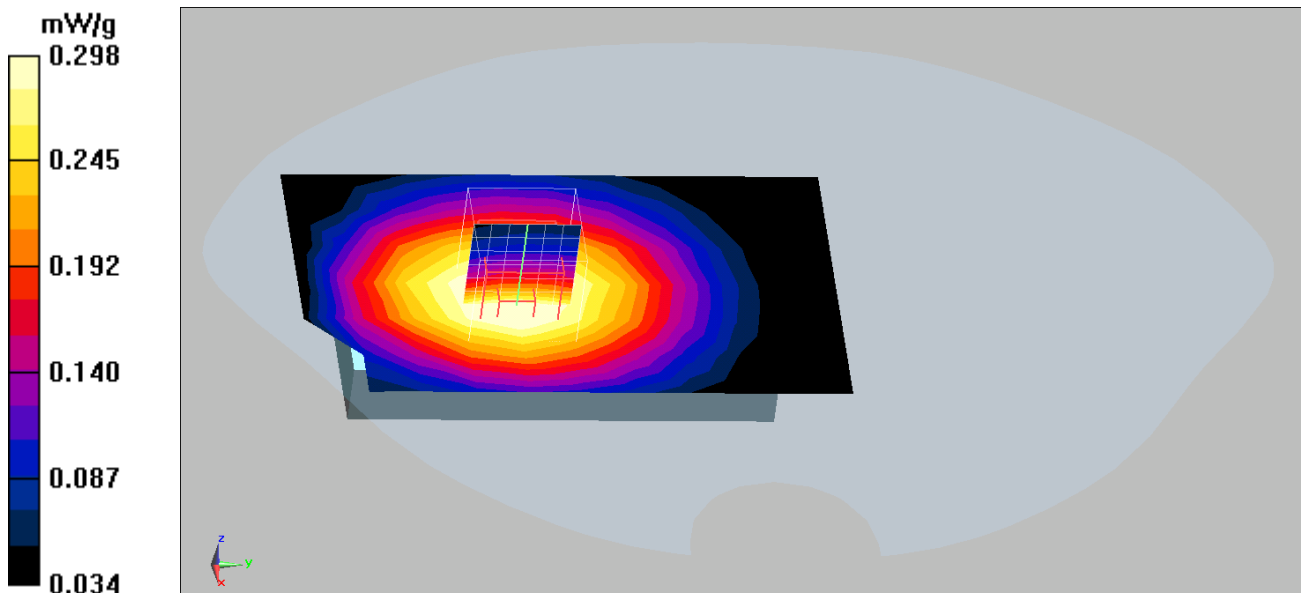

Date/Time: 12/21/2009

Test Laboratory: Quietek

### GSM850\_Body\_Channel-189

**DUT: Smart Handheld; Type: M900DF**

Communication System: FCC GSM\_850MHz; Frequency: 836.4 MHz; Duty Cycle: 1:8.3

Medium parameters used:  $f = 836.4 \text{ MHz}$ ;  $\sigma = 0.97 \text{ mho/m}$ ;  $\epsilon_r = 54.2$ ;  $\rho = 1000 \text{ kg/m}^3$

Phantom section: Flat Section

Ambient Temperature ( $^{\circ}\text{C}$ ) : 20.9, Liquid Temperature ( $^{\circ}\text{C}$ ) : 20.1

DASY4 Configuration:

- Probe: EX3DV4 - SN3602; ConvF(9.32, 9.32, 9.32); Calibrated: 5/20/2009
- Sensor-Surface: 4mm (Mechanical Surface Detection)
- Electronics: DAE4 Sn1207; Calibrated: 4/7/2009
- Phantom: SAM Left Table; Type: SAM;
- Measurement SW: DASY5, V5.0 Build 125; SEMCAD X Version 13.4 Build 125

**GSM850/Area Scan (7x11x1):** Measurement grid: dx=15mm, dy=15mm

Maximum value of SAR (measured) = 0.300 mW/g

**GSM850/Zoom Scan (7x7x7) (7x7x7)/Cube 0:** Measurement grid: dx=5mm, dy=5mm, dz=5mm

Reference Value = 7.81 V/m; Power Drift = -0.043 dB

Peak SAR (extrapolated) = 0.374 W/kg

**SAR(1 g) = 0.284 mW/g; SAR(10 g) = 0.212 mW/g**

Maximum value of SAR (measured) = 0.299 mW/g

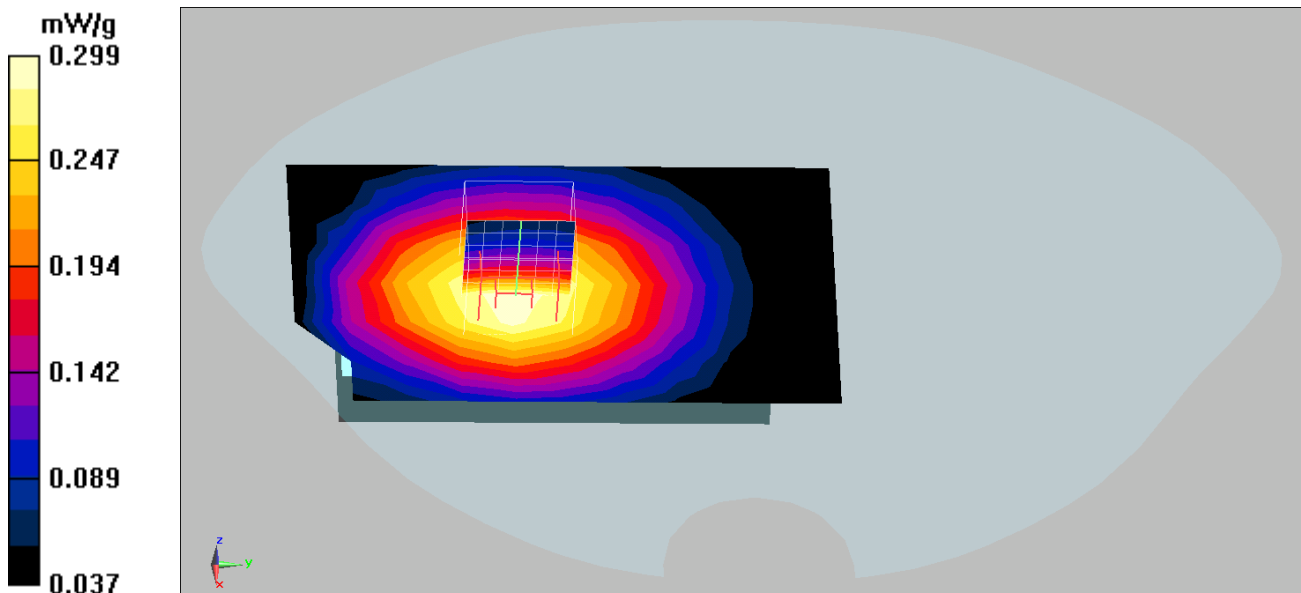

Date/Time: 12/21/2009

Test Laboratory: Quietek

### GSM850\_Body\_Channel-251

**DUT: Smart Handheld; Type: M900DF**

Communication System: FCC GSM\_850MHz; Frequency: 848.8 MHz; Duty Cycle: 1:8.3

Medium parameters used:  $f = 848.8 \text{ MHz}$ ;  $\sigma = 0.99 \text{ mho/m}$ ;  $\epsilon_r = 53.9$ ;  $\rho = 1000 \text{ kg/m}^3$

Phantom section: Flat Section

Ambient Temperature ( $^{\circ}\text{C}$ ) : 20.9, Liquid Temperature ( $^{\circ}\text{C}$ ) : 20.1

DASY4 Configuration:

- Probe: EX3DV4 - SN3602; ConvF(9.32, 9.32, 9.32); Calibrated: 5/20/2009
- Sensor-Surface: 4mm (Mechanical Surface Detection)
- Electronics: DAE4 Sn1207; Calibrated: 4/7/2009
- Phantom: SAM Left Table; Type: SAM;
- Measurement SW: DASY5, V5.0 Build 125; SEMCAD X Version 13.4 Build 125

**GSM850/Area Scan (7x11x1):** Measurement grid: dx=15mm, dy=15mm

Maximum value of SAR (measured) = 0.270 mW/g

**GSM850/Zoom Scan (7x7x7) (7x7x7)/Cube 0:** Measurement grid: dx=5mm, dy=5mm, dz=5mm

Reference Value = 7.54 V/m; Power Drift = -0.088 dB

Peak SAR (extrapolated) = 0.334 W/kg

**SAR(1 g) = 0.256 mW/g; SAR(10 g) = 0.191 mW/g**

Maximum value of SAR (measured) = 0.268 mW/g

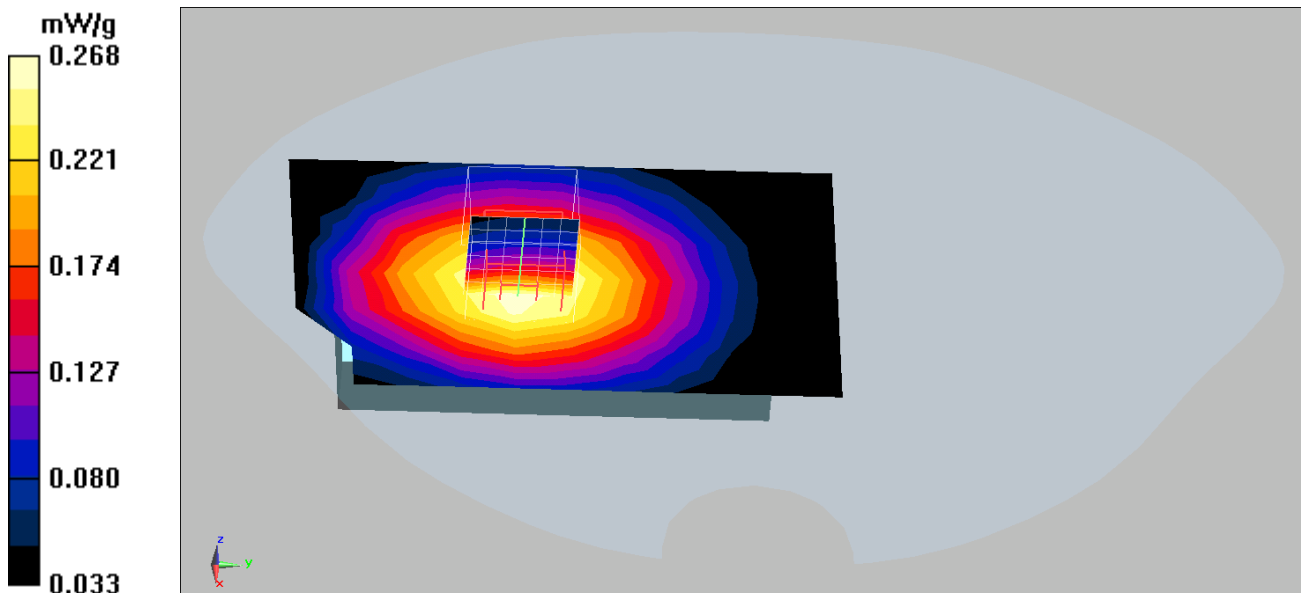

Date/Time: 12/21/2009

Test Laboratory: Quietek

### GSM850\_Body\_Channel-189 GPRE Slot-2

**DUT: Smart Handheld; Type: M900DF**

Communication System: FCC GSM\_850MHz\_GPRS -2 Slot; Frequency: 836.4 MHz; Duty Cycle: 1:4.1

Medium parameters used:  $f = 836.4$  MHz;  $\sigma = 0.97$  mho/m;  $\epsilon_r = 54.2$ ;  $\rho = 1000$  kg/m<sup>3</sup>

Phantom section: Flat Section

Ambient Temperature (°C) : 20.9, Liquid Temperature (°C) : 20.1

DASY4 Configuration:

- Probe: EX3DV4 - SN3602; ConvF(9.32, 9.32, 9.32); Calibrated: 5/20/2009
- Sensor-Surface: 4mm (Mechanical Surface Detection)
- Electronics: DAE4 Sn1207; Calibrated: 4/7/2009
- Phantom: SAM Left Table; Type: SAM;
- Measurement SW: DASY5, V5.0 Build 125; SEMCAD X Version 13.4 Build 125

**GSM850/Area Scan (7x11x1):** Measurement grid: dx=15mm, dy=15mm

Maximum value of SAR (measured) = 0.590 mW/g

**GSM850/Zoom Scan (7x7x7) (7x7x7)/Cube 0:** Measurement grid: dx=5mm, dy=5mm, dz=5mm

Reference Value = 10.7 V/m; Power Drift = -0.129 dB

Peak SAR (extrapolated) = 0.739 W/kg

**SAR(1 g) = 0.564 mW/g; SAR(10 g) = 0.418 mW/g**

Maximum value of SAR (measured) = 0.592 mW/g

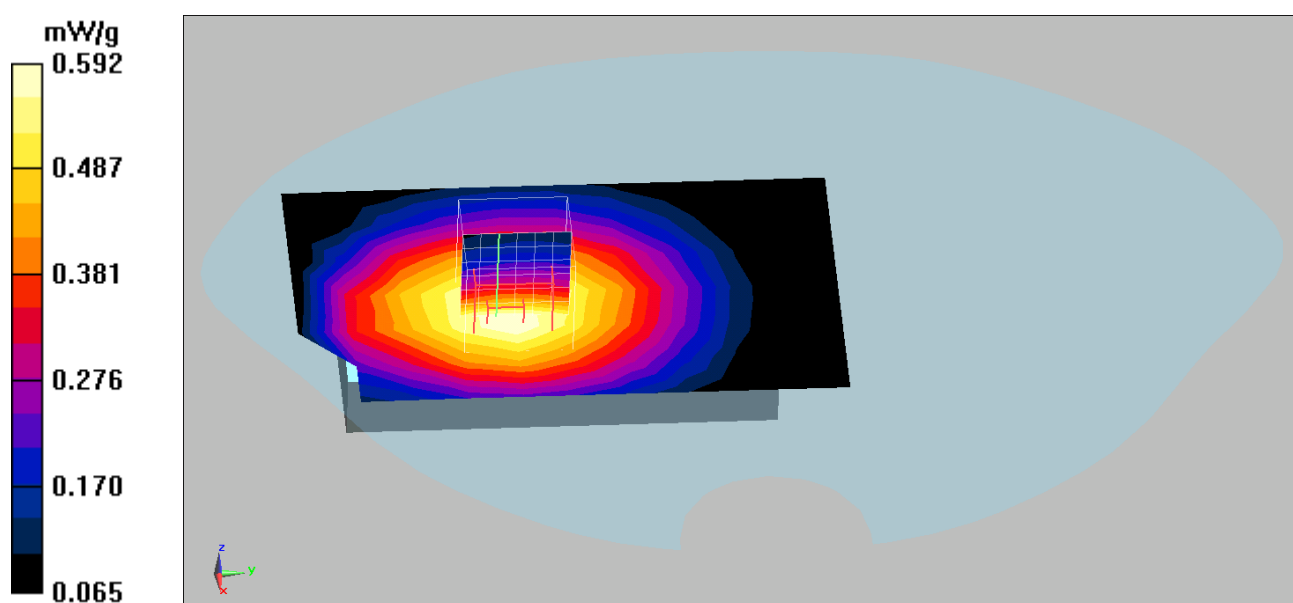

Date/Time: 12/21/2009

Test Laboratory: Quietek

### GSM850\_Body\_Channel-189 GPRE Slot-3

**DUT: Smart Handheld; Type: M900DF**

Communication System: FCC GSM\_850MHz\_GPRS -3 Slot; Frequency: 836.4 MHz; Duty Cycle: 1:2.7

Medium parameters used:  $f = 836.4$  MHz;  $\sigma = 0.97$  mho/m;  $\epsilon_r = 54.2$ ;  $\rho = 1000$  kg/m<sup>3</sup>

Phantom section: Flat Section

Ambient Temperature (°C) : 20.9, Liquid Temperature (°C) : 20.1

DASY4 Configuration:

- Probe: EX3DV4 - SN3602; ConvF(9.32, 9.32, 9.32); Calibrated: 5/20/2009
- Sensor-Surface: 4mm (Mechanical Surface Detection)
- Electronics: DAE4 Sn1207; Calibrated: 4/7/2009
- Phantom: SAM Left Table; Type: SAM;
- Measurement SW: DASY5, V5.0 Build 125; SEMCAD X Version 13.4 Build 125

**GSM850/Area Scan (7x11x1):** Measurement grid: dx=15mm, dy=15mm

Maximum value of SAR (measured) = 0.835 mW/g

**GSM850/Zoom Scan (7x7x7) (7x7x7)/Cube 0:** Measurement grid: dx=5mm, dy=5mm, dz=5mm

Reference Value = 12.1 V/m; Power Drift = -0.085 dB

Peak SAR (extrapolated) = 1.06 W/kg

**SAR(1 g) = 0.807 mW/g; SAR(10 g) = 0.598 mW/g**

Maximum value of SAR (measured) = 0.848 mW/g

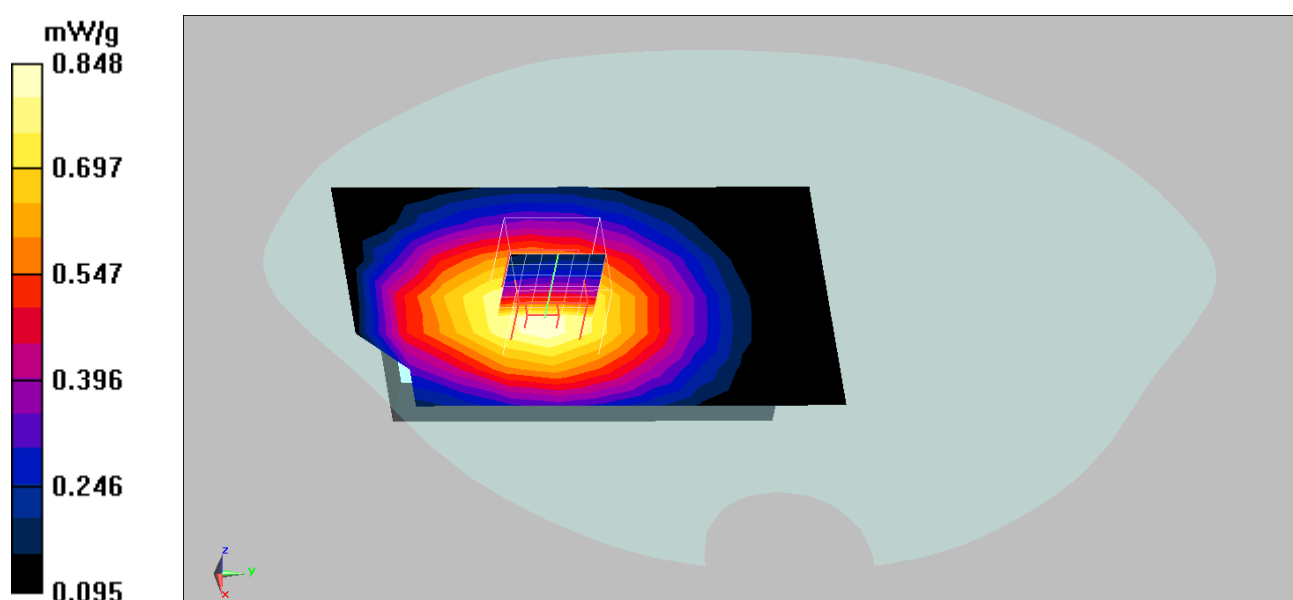

Date/Time: 12/21/2009

Test Laboratory: Quietek

**GSM850\_Body\_Channel-128 GPRE Slot-4**

**DUT: Smart Handheld; Type: M900DF**

Communication System: FCC GSM\_850MHz\_GPRS -4 Slot; Frequency: 824.2 MHz; Duty Cycle: 1:2

Medium parameters used:  $f = 824.2 \text{ MHz}$ ;  $\sigma = 0.95 \text{ mho/m}$ ;  $\epsilon_r = 54.5$ ;  $\rho = 1000 \text{ kg/m}^3$

Phantom section: Flat Section

Ambient Temperature ( $^{\circ}\text{C}$ ) : 20.9, Liquid Temperature ( $^{\circ}\text{C}$ ) : 20.1

DASY4 Configuration:

- Probe: EX3DV4 - SN3602; ConvF(9.32, 9.32, 9.32); Calibrated: 5/20/2009
- Sensor-Surface: 4mm (Mechanical Surface Detection)
- Electronics: DAE4 Sn1207; Calibrated: 4/7/2009
- Phantom: SAM Left Table; Type: SAM;
- Measurement SW: DASY5, V5.0 Build 125; SEMCAD X Version 13.4 Build 125

**GSM850/Area Scan (7x11x1):** Measurement grid: dx=15mm, dy=15mm

Maximum value of SAR (measured) = 1.03 mW/g

**GSM850/Zoom Scan (7x7x7) (7x7x7)/Cube 0:** Measurement grid: dx=5mm, dy=5mm, dz=5mm

Reference Value = 15.7 V/m; Power Drift = -0.101 dB

Peak SAR (extrapolated) = 1.3 W/kg

**SAR(1 g) = 0.982 mW/g; SAR(10 g) = 0.731 mW/g**

Maximum value of SAR (measured) = 1.04 mW/g

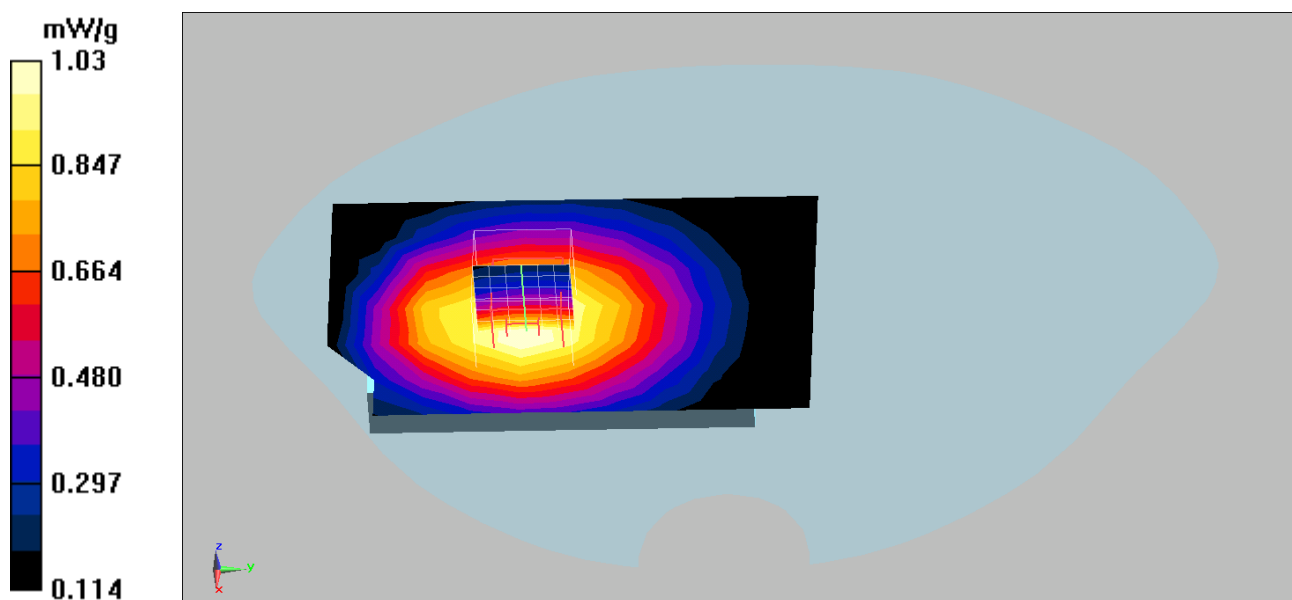



Date/Time: 12/21/2009

Test Laboratory: Quietek

**GSM850\_Body\_Channel-189 GPRE Slot-4**

**DUT: Smart Handheld; Type: M900DF**

Communication System: FCC GSM\_850MHz\_GPRS -4 Slot; Frequency: 836.4 MHz; Duty Cycle: 1:2

Medium parameters used:  $f = 836.4 \text{ MHz}$ ;  $\sigma = 0.97 \text{ mho/m}$ ;  $\epsilon_r = 54.2$ ;  $\rho = 1000 \text{ kg/m}^3$

Phantom section: Flat Section

Ambient Temperature ( $^{\circ}\text{C}$ ) : 20.9, Liquid Temperature ( $^{\circ}\text{C}$ ) : 20.1

DASY4 Configuration:

- Probe: EX3DV4 - SN3602; ConvF(9.32, 9.32, 9.32); Calibrated: 5/20/2009
- Sensor-Surface: 4mm (Mechanical Surface Detection)
- Electronics: DAE4 Sn1207; Calibrated: 4/7/2009
- Phantom: SAM Left Table; Type: SAM;
- Measurement SW: DASY5, V5.0 Build 125; SEMCAD X Version 13.4 Build 125

**GSM850/Area Scan (7x11x1):** Measurement grid: dx=15mm, dy=15mm

Maximum value of SAR (measured) = 1.05 mW/g

**GSM850/Zoom Scan (7x7x7) (7x7x7)/Cube 0:** Measurement grid: dx=5mm, dy=5mm, dz=5mm

Reference Value = 13.6 V/m; Power Drift = 0.012 dB

Peak SAR (extrapolated) = 1.32 W/kg

**SAR(1 g) = 1.01 mW/g; SAR(10 g) = 0.757 mW/g**

Maximum value of SAR (measured) = 1.06 mW/g

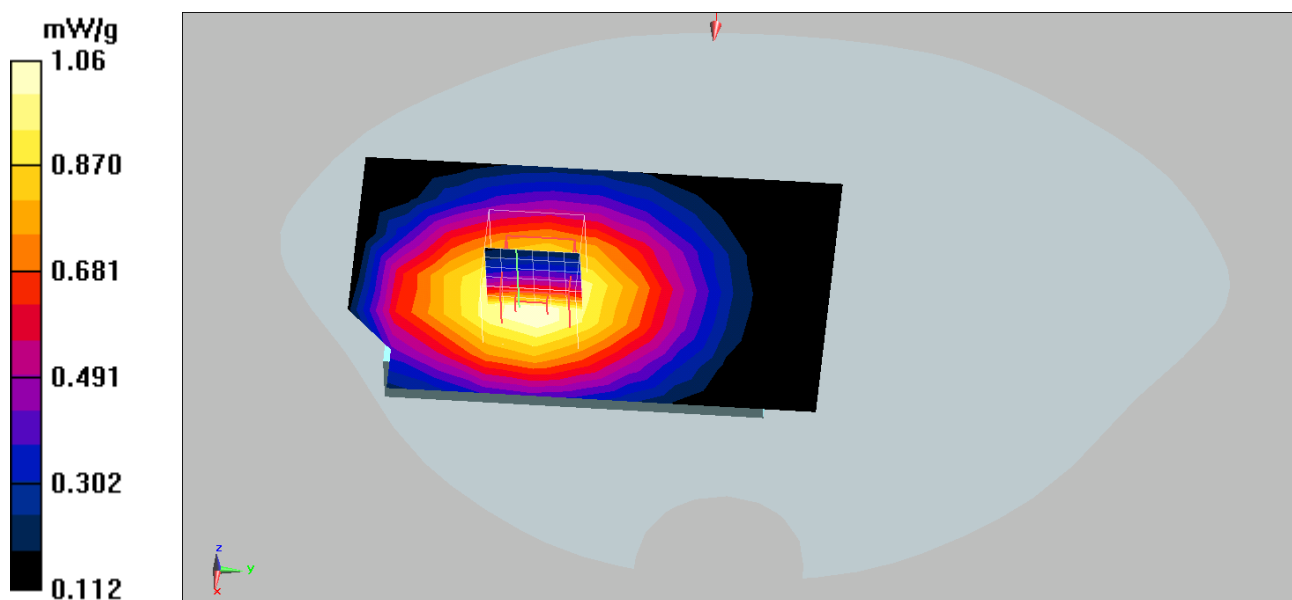

Date/Time: 12/21/2009

Test Laboratory: Quietek

### GSM850\_Body\_Channel-251 GPRE Slot-4

**DUT: Smart Handheld; Type: M900DF**

Communication System: FCC GSM\_850MHz\_GPRS -4 Slot; Frequency: 848.8 MHz; Duty Cycle: 1:2

Medium parameters used:  $f = 848.8 \text{ MHz}$ ;  $\sigma = 0.99 \text{ mho/m}$ ;  $\epsilon_r = 53.9$ ;  $\rho = 1000 \text{ kg/m}^3$

Phantom section: Flat Section

Ambient Temperature ( $^{\circ}\text{C}$ ) : 20.9, Liquid Temperature ( $^{\circ}\text{C}$ ) : 20.1

DASY4 Configuration:

- Probe: EX3DV4 - SN3602; ConvF(9.32, 9.32, 9.32); Calibrated: 5/20/2009
- Sensor-Surface: 4mm (Mechanical Surface Detection)
- Electronics: DAE4 Sn1207; Calibrated: 4/7/2009
- Phantom: SAM Left Table; Type: SAM;
- Measurement SW: DASY5, V5.0 Build 125; SEMCAD X Version 13.4 Build 125

**GSM850/Area Scan (7x11x1):** Measurement grid:  $dx=15\text{mm}$ ,  $dy=15\text{mm}$

Maximum value of SAR (measured) = 0.983 mW/g

**GSM850/Zoom Scan (7x7x7) (7x7x7)/Cube 0:** Measurement grid:  $dx=5\text{mm}$ ,  $dy=5\text{mm}$ ,  $dz=5\text{mm}$

Reference Value = 15.2 V/m; Power Drift = 0.117 dB

Peak SAR (extrapolated) = 1.29 W/kg

**SAR(1 g) = 0.980 mW/g; SAR(10 g) = 0.727 mW/g**

Maximum value of SAR (measured) = 1.04 mW/g

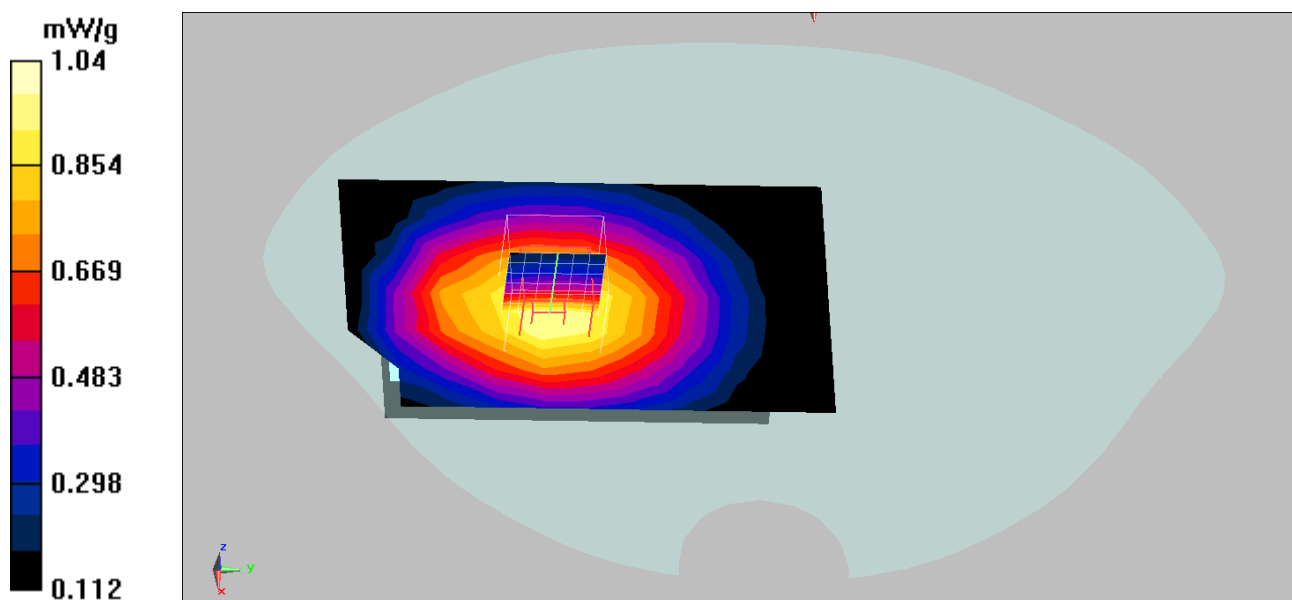

Date/Time: 12/21/2009

Test Laboratory: Quietek

**GSM850\_Body\_Channel-189 EGPRE Slot-4**

**DUT: Smart Handheld; Type: M900DF**

Communication System: FCC GSM\_850MHz\_EGPRS-4 Slot; Frequency: 836.4 MHz; Duty Cycle: 1:2

Medium parameters used:  $f = 836.4 \text{ MHz}$ ;  $\sigma = 0.97 \text{ mho/m}$ ;  $\epsilon_r = 54.2$ ;  $\rho = 1000 \text{ kg/m}^3$

Phantom section: Flat Section

Ambient Temperature ( $^{\circ}\text{C}$ ) : 20.9, Liquid Temperature ( $^{\circ}\text{C}$ ) : 20.1

DASY4 Configuration:

- Probe: EX3DV4 - SN3602; ConvF(9.32, 9.32, 9.32); Calibrated: 5/20/2009
- Sensor-Surface: 4mm (Mechanical Surface Detection)
- Electronics: DAE4 Sn1207; Calibrated: 4/7/2009
- Phantom: SAM Left Table; Type: SAM;
- Measurement SW: DASY5, V5.0 Build 125; SEMCAD X Version 13.4 Build 125

**GSM850/Area Scan (7x11x1):** Measurement grid: dx=15mm, dy=15mm

Maximum value of SAR (measured) = 1.05 mW/g

**GSM850/Zoom Scan (7x7x7) (7x7x7)/Cube 0:** Measurement grid: dx=5mm, dy=5mm, dz=5mm

Reference Value = 15.8 V/m; Power Drift = -0.137 dB

Peak SAR (extrapolated) = 1.38 W/kg

**SAR(1 g) = 0.981 mW/g; SAR(10 g) = 0.779 mW/g**

Maximum value of SAR (measured) = 1.11 mW/g

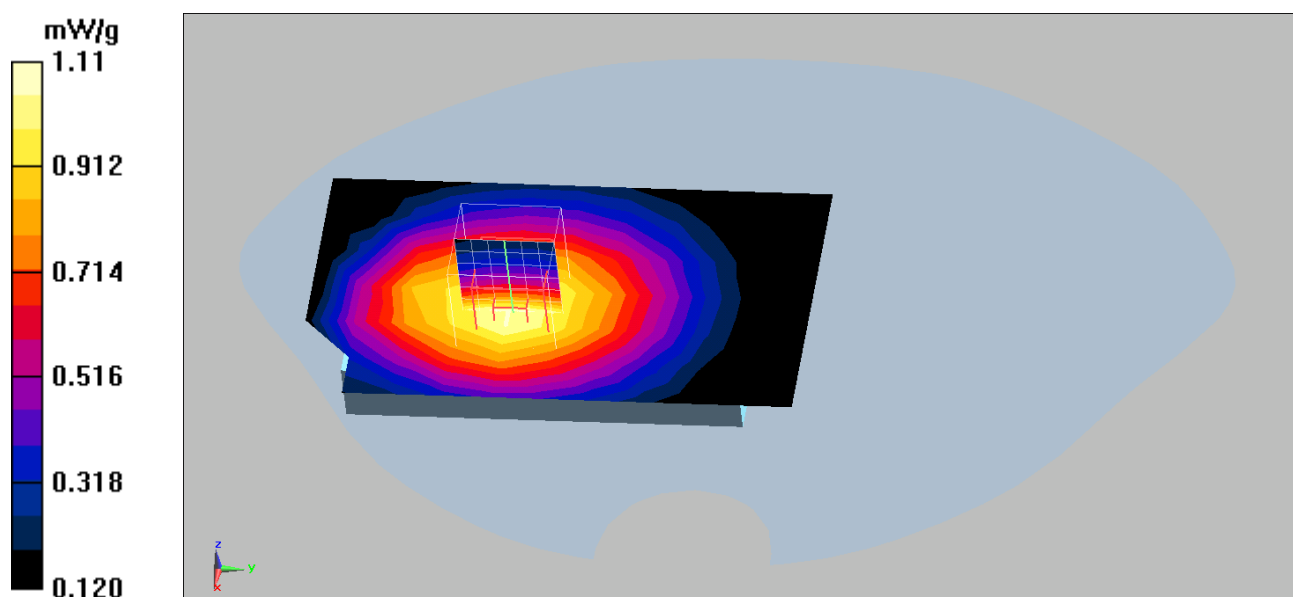

GSM 850 GPRS 4 Slot EUT Bottom Z-Axis plot  
Channel: 189

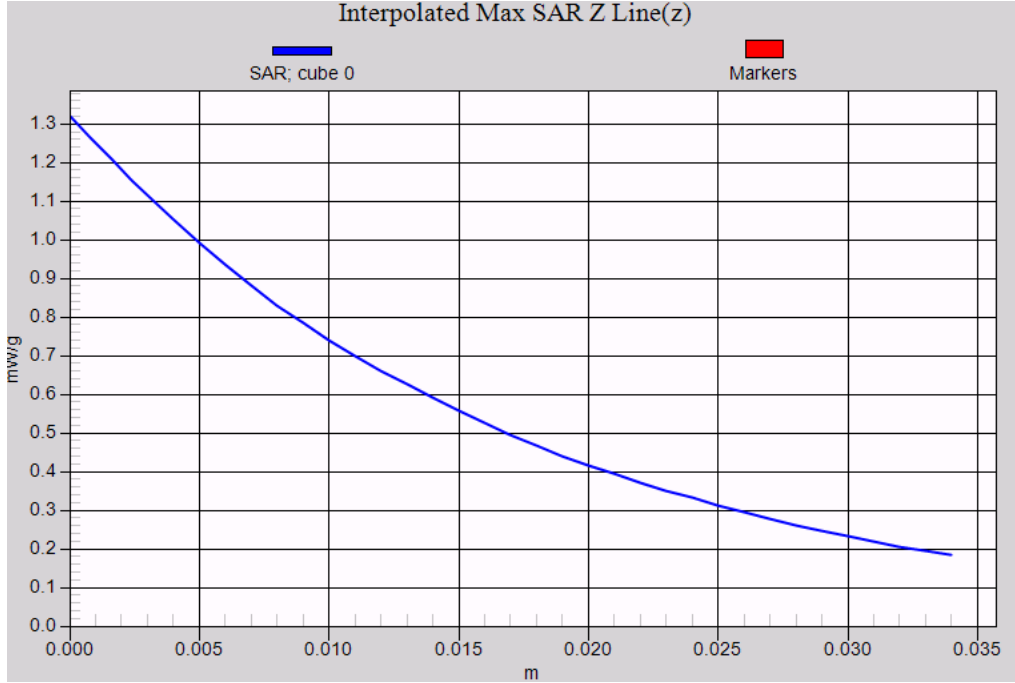

Date/Time: 12/22/2009

Test Laboratory: Quietek

**PCS1900\_Left-Cheek\_Channel-512**

**DUT: Smart Handheld; Type: M900DF**

Communication System: FCC PCS\_1900MHz; Frequency: 1850.2 MHz; Duty Cycle: 1:8.3

Medium parameters used:  $f = 1850.2$  MHz;  $\sigma = 1.36$  mho/m;  $\epsilon_r = 39.1$ ;  $\rho = 1000$  kg/m<sup>3</sup>

Phantom section: Left Section

Ambient Temperature (°C) : 20.8, Liquid Temperature (°C) : 20.1

DASY4 Configuration:

- Probe: EX3DV4 - SN3602; ConvF(7.81, 7.81, 7.81); Calibrated: 5/20/2009
- Sensor-Surface: 4mm (Mechanical Surface Detection)
- Electronics: DAE4 Sn1207; Calibrated: 4/7/2009
- Phantom: SAM Right Table; Type: SAM;
- Measurement SW: DASY5, V5.0 Build 125; SEMCAD X Version 13.4 Build 125

**PCS1900/Area Scan (7x11x1):** Measurement grid: dx=15mm, dy=15mm

Maximum value of SAR (measured) = 0.099 mW/g

**PCS1900/Zoom Scan (7x7x7) (7x7x7)/Cube 0:** Measurement grid: dx=5mm, dy=5mm, dz=5mm

Reference Value = 4.16 V/m; Power Drift = -0.104 dB

Peak SAR (extrapolated) = 0.138 W/kg

**SAR(1 g) = 0.091 mW/g; SAR(10 g) = 0.058 mW/g**

Maximum value of SAR (measured) = 0.101 mW/g

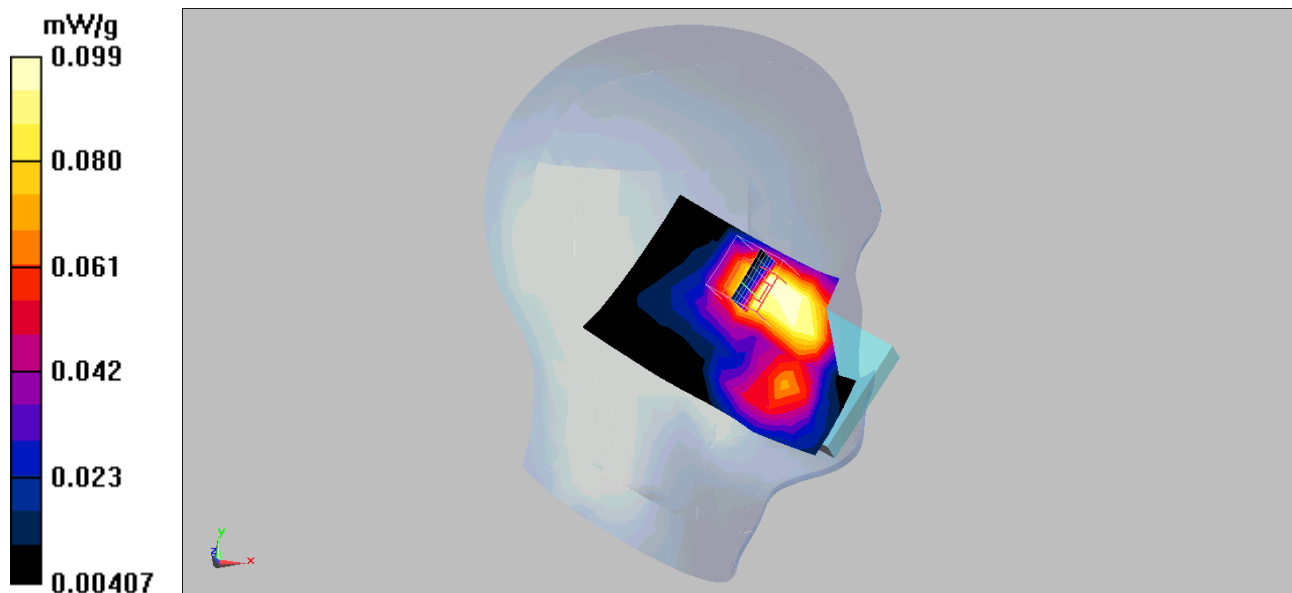

Date/Time: 12/22/2009

Test Laboratory: Quietek

**PCS1900\_Left-Cheek\_Channel-661**

**DUT: Smart Handheld; Type: M900DF**

Communication System: FCC PCS\_1900MHz; Frequency: 1880 MHz;Duty Cycle: 1:8.3

Medium parameters used:  $f = 1880 \text{ MHz}$ ;  $\sigma = 1.38 \text{ mho/m}$ ;  $\epsilon_r = 39.5$ ;  $\rho = 1000 \text{ kg/m}^3$

Phantom section: Left Section

Ambient Temperature ( $^{\circ}\text{C}$ ) : 20.8, Liquid Temperature ( $^{\circ}\text{C}$ ) : 20.1

DASY4 Configuration:

- Probe: EX3DV4 - SN3602; ConvF(7.81, 7.81, 7.81); Calibrated: 5/20/2009
- Sensor-Surface: 4mm (Mechanical Surface Detection)
- Electronics: DAE4 Sn1207; Calibrated: 4/7/2009
- Phantom: SAM Right Table; Type: SAM;
- Measurement SW: DASY5, V5.0 Build 125; SEMCAD X Version 13.4 Build 125

**PCS1900/Area Scan (7x11x1):** Measurement grid:  $dx=15\text{mm}$ ,  $dy=15\text{mm}$

Maximum value of SAR (measured) = 0.107 mW/g

**PCS1900/Zoom Scan (7x7x7) (7x7x7)/Cube 0:** Measurement grid:  $dx=5\text{mm}$ ,  $dy=5\text{mm}$ ,  $dz=5\text{mm}$

Reference Value = 4.4 V/m; Power Drift = 0.113 dB

Peak SAR (extrapolated) = 0.173 W/kg

**SAR(1 g) = 0.115 mW/g; SAR(10 g) = 0.072 mW/g**

Maximum value of SAR (measured) = 0.126 mW/g

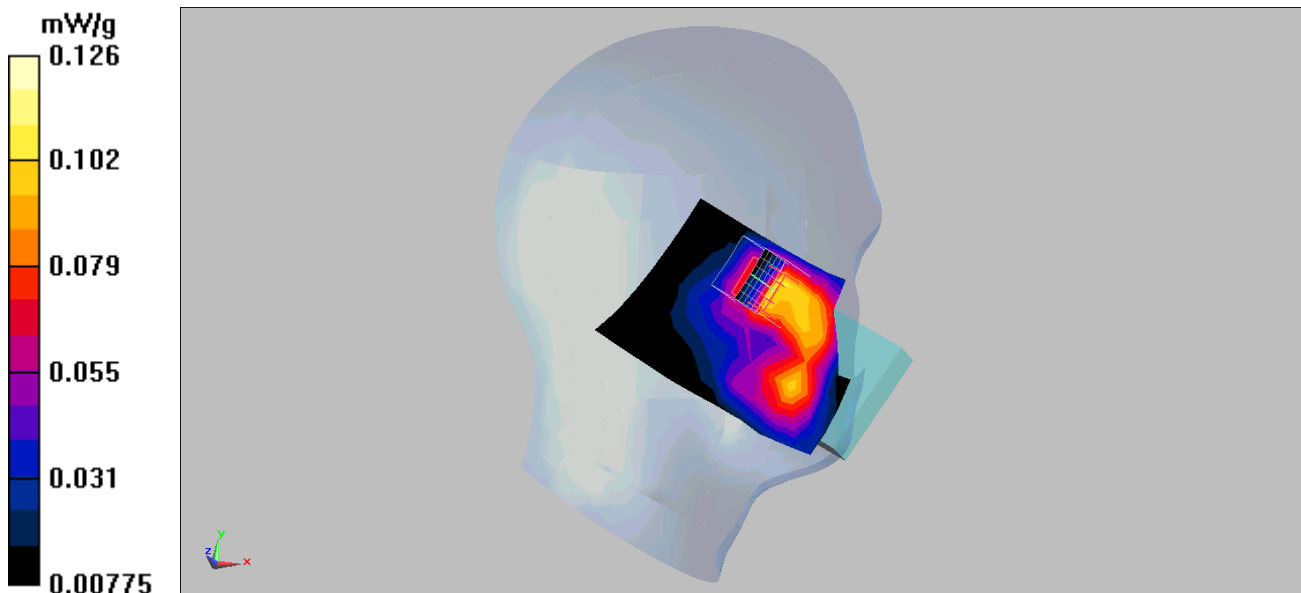

Date/Time: 12/22/2009

Test Laboratory: Quietek

**PCS1900\_Left-Cheek\_Channel-810**

**DUT: Smart Handheld; Type: M900DF**

Communication System: FCC PCS\_1900MHz; Frequency: 1909.8 MHz; Duty Cycle: 1:8.3

Medium parameters used:  $f = 1909.8$  MHz;  $\sigma = 1.41$  mho/m;  $\epsilon_r = 38.9$ ;  $\rho = 1000$  kg/m<sup>3</sup>

Phantom section: Left Section

Ambient Temperature (°C) : 20.8, Liquid Temperature (°C) : 20.1

DASY4 Configuration:

- Probe: EX3DV4 - SN3602; ConvF(7.81, 7.81, 7.81); Calibrated: 5/20/2009
- Sensor-Surface: 4mm (Mechanical Surface Detection)
- Electronics: DAE4 Sn1207; Calibrated: 4/7/2009
- Phantom: SAM Right Table; Type: SAM;
- Measurement SW: DASY5, V5.0 Build 125; SEMCAD X Version 13.4 Build 125

**PCS1900/Area Scan (7x11x1):** Measurement grid: dx=15mm, dy=15mm

Maximum value of SAR (measured) = 0.122 mW/g

**PCS1900/Zoom Scan (7x7x7) (7x7x7)/Cube 0:** Measurement grid: dx=5mm, dy=5mm, dz=5mm

Reference Value = 4.64 V/m; Power Drift = 0.137 dB

Peak SAR (extrapolated) = 0.193 W/kg

**SAR(1 g) = 0.128 mW/g; SAR(10 g) = 0.079 mW/g**

Maximum value of SAR (measured) = 0.140 mW/g

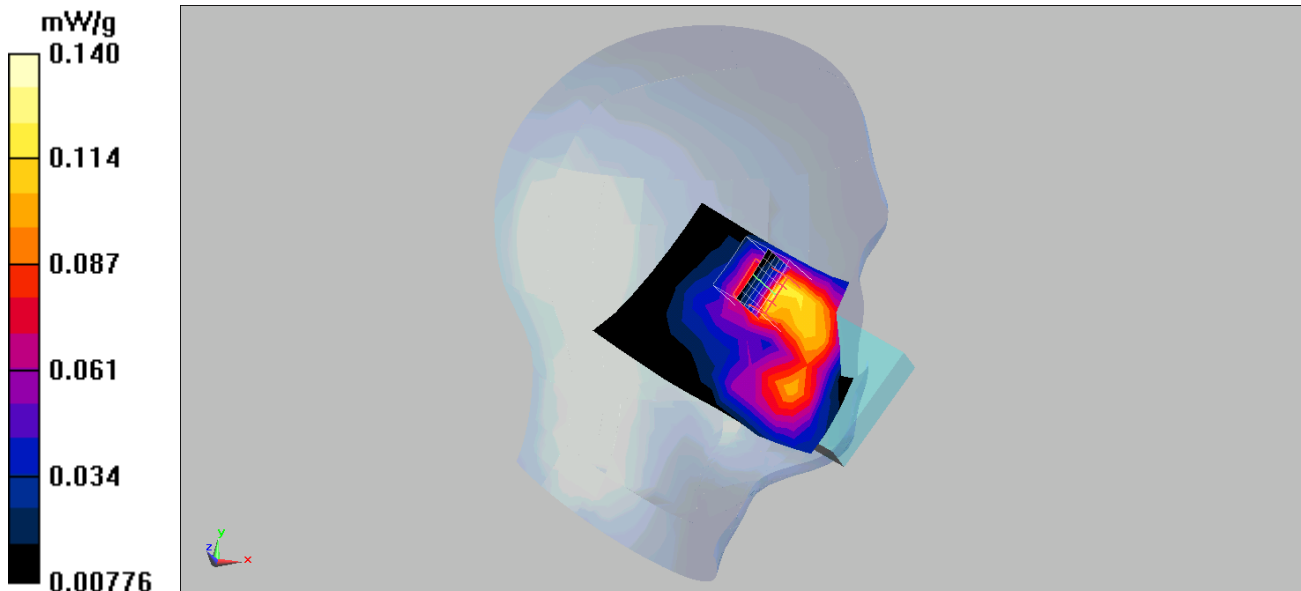

Date/Time: 12/22/2009

Test Laboratory: Quietek

**PCS1900\_Left-Tilt\_Channel-512**

**DUT: Smart Handheld; Type: M900DF**

Communication System: FCC PCS\_1900MHz; Frequency: 1850.2 MHz; Duty Cycle: 1:8.3

Medium parameters used:  $f = 1850.2$  MHz;  $\sigma = 1.36$  mho/m;  $\epsilon_r = 39.1$ ;  $\rho = 1000$  kg/m<sup>3</sup>

Phantom section: Left Section

Ambient Temperature (°C) : 20.8, Liquid Temperature (°C) : 20.1

DASY4 Configuration:

- Probe: EX3DV4 - SN3602; ConvF(7.81, 7.81, 7.81); Calibrated: 5/20/2009
- Sensor-Surface: 4mm (Mechanical Surface Detection)
- Electronics: DAE4 Sn1207; Calibrated: 4/7/2009
- Phantom: SAM Right Table; Type: SAM;
- Measurement SW: DASY5, V5.0 Build 125; SEMCAD X Version 13.4 Build 125

**PCS1900/Area Scan (7x11x1):** Measurement grid: dx=15mm, dy=15mm

Maximum value of SAR (measured) = 0.080 mW/g

**PCS1900/Zoom Scan (7x7x7) (7x7x7)/Cube 0:** Measurement grid: dx=5mm, dy=5mm, dz=5mm

Reference Value = 6.25 V/m; Power Drift = 0.094 dB

Peak SAR (extrapolated) = 0.112 W/kg

**SAR(1 g) = 0.075 mW/g; SAR(10 g) = 0.049 mW/g**

Maximum value of SAR (measured) = 0.081 mW/g

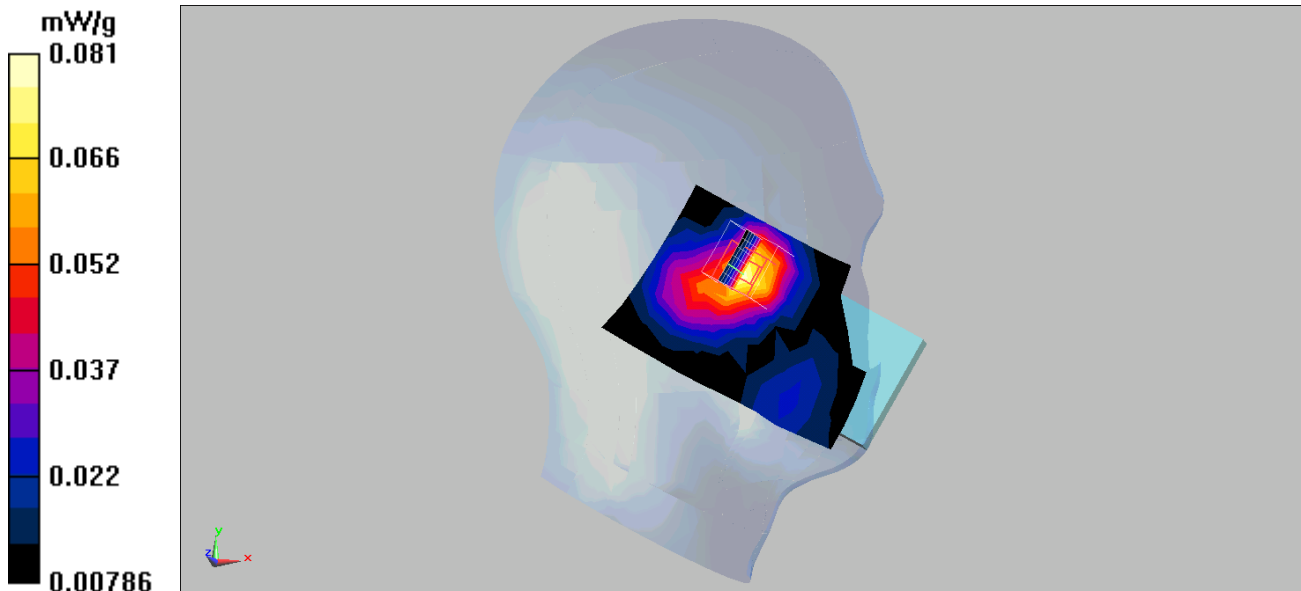



Date/Time: 12/22/2009

Test Laboratory: Quietek

**PCS1900\_Left-Tilt\_Channel-661**

**DUT: Smart Handheld; Type: M900DF**

Communication System: FCC PCS\_1900MHz; Frequency: 1880 MHz;Duty Cycle: 1:8.3

Medium parameters used:  $f = 1880 \text{ MHz}$ ;  $\sigma = 1.38 \text{ mho/m}$ ;  $\epsilon_r = 39.5$ ;  $\rho = 1000 \text{ kg/m}^3$

Phantom section: Left Section

Ambient Temperature ( $^{\circ}\text{C}$ ) : 20.8, Liquid Temperature ( $^{\circ}\text{C}$ ) : 20.1

DASY4 Configuration:

- Probe: EX3DV4 - SN3602; ConvF(7.81, 7.81, 7.81); Calibrated: 5/20/2009
- Sensor-Surface: 4mm (Mechanical Surface Detection)
- Electronics: DAE4 Sn1207; Calibrated: 4/7/2009
- Phantom: SAM Right Table; Type: SAM;
- Measurement SW: DASY5, V5.0 Build 125; SEMCAD X Version 13.4 Build 125

**PCS1900/Area Scan (7x11x1):** Measurement grid: dx=15mm, dy=15mm

Maximum value of SAR (measured) = 0.074 mW/g

**PCS1900/Zoom Scan (7x7x7) (7x7x7)/Cube 0:** Measurement grid: dx=5mm, dy=5mm, dz=5mm

Reference Value = 5.81 V/m; Power Drift = -0.042 dB

Peak SAR (extrapolated) = 0.102 W/kg

**SAR(1 g) = 0.070 mW/g; SAR(10 g) = 0.045 mW/g**

Maximum value of SAR (measured) = 0.075 mW/g

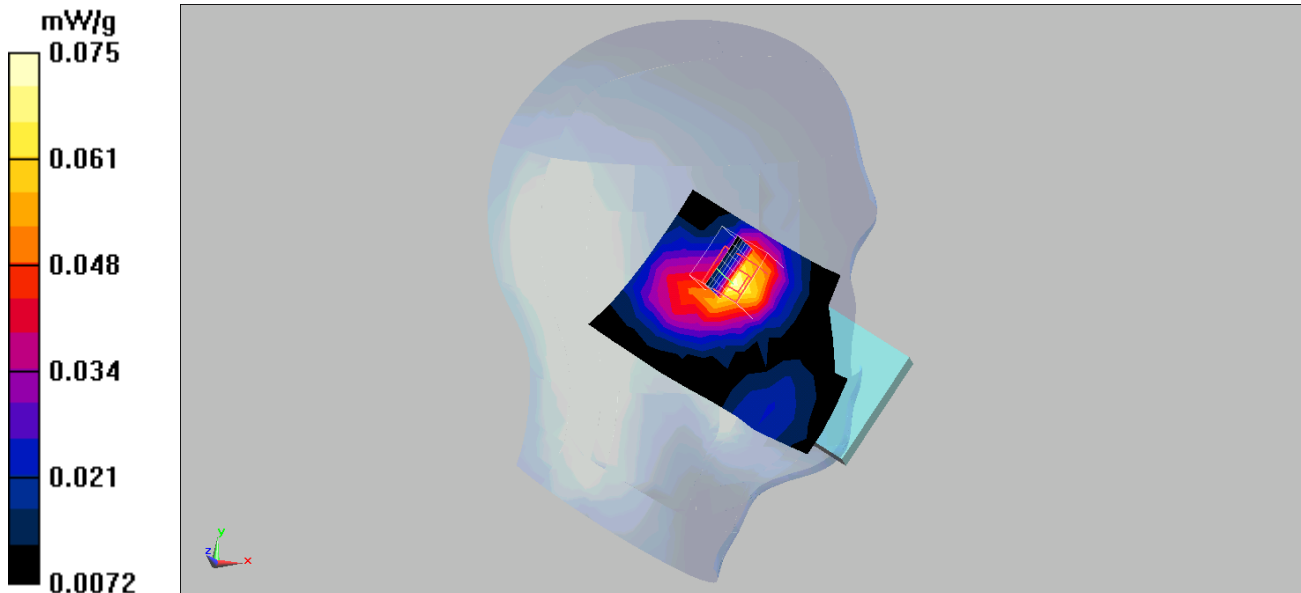

Date/Time: 12/22/2009

Test Laboratory: Quietek

**PCS1900\_Left-Tilt\_Channel-810**

**DUT: Smart Handheld; Type: M900DF**

Communication System: FCC PCS\_1900MHz; Frequency: 1909.8 MHz; Duty Cycle: 1:8.3

Medium parameters used:  $f = 1909.8$  MHz;  $\sigma = 1.41$  mho/m;  $\epsilon_r = 38.9$ ;  $\rho = 1000$  kg/m<sup>3</sup>

Phantom section: Left Section

Ambient Temperature (°C) : 20.8, Liquid Temperature (°C) : 20.1

DASY4 Configuration:

- Probe: EX3DV4 - SN3602; ConvF(7.81, 7.81, 7.81); Calibrated: 5/20/2009
- Sensor-Surface: 4mm (Mechanical Surface Detection)
- Electronics: DAE4 Sn1207; Calibrated: 4/7/2009
- Phantom: SAM Right Table; Type: SAM;
- Measurement SW: DASY5, V5.0 Build 125; SEMCAD X Version 13.4 Build 125

**PCS1900/Area Scan (7x11x1):** Measurement grid: dx=15mm, dy=15mm

Maximum value of SAR (measured) = 0.121 mW/g

**PCS1900/Zoom Scan (7x7x7) (7x7x7)/Cube 0:** Measurement grid: dx=5mm, dy=5mm, dz=5mm

Reference Value = 7.61 V/m; Power Drift = -0.104 dB

Peak SAR (extrapolated) = 0.153 W/kg

**SAR(1 g) = 0.101 mW/g; SAR(10 g) = 0.062 mW/g**

Maximum value of SAR (measured) = 0.110 mW/g

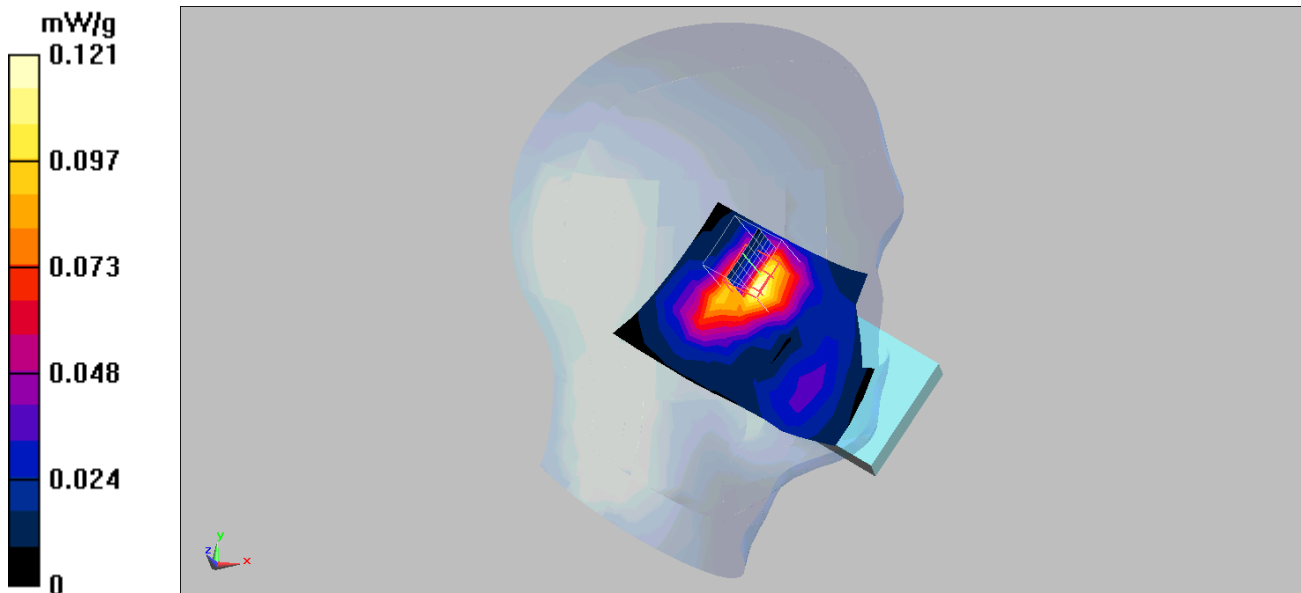

Date/Time: 12/22/2009

Test Laboratory: Quietek

**PCS1900\_Right-Cheek\_Channel-512**

**DUT: Smart Handheld; Type: M900DF**

Communication System: FCC PCS\_1900MHz; Frequency: 1850.2 MHz; Duty Cycle: 1:8.3

Medium parameters used:  $f = 1850.2$  MHz;  $\sigma = 1.36$  mho/m;  $\epsilon_r = 39.1$ ;  $\rho = 1000$  kg/m<sup>3</sup>

Phantom section: Right Section

Ambient Temperature (°C) : 20.8, Liquid Temperature (°C) : 20.1

DASY4 Configuration:

- Probe: EX3DV4 - SN3602; ConvF(7.81, 7.81, 7.81); Calibrated: 5/20/2009
- Sensor-Surface: 4mm (Mechanical Surface Detection)
- Electronics: DAE4 Sn1207; Calibrated: 4/7/2009
- Phantom: SAM Right Table; Type: SAM;
- Measurement SW: DASY5, V5.0 Build 125; SEMCAD X Version 13.4 Build 125

**PCS1900/Area Scan (7x11x1):** Measurement grid: dx=15mm, dy=15mm

Maximum value of SAR (measured) = 0.160 mW/g

**PCS1900/Zoom Scan (7x7x7) (7x7x7)/Cube 0:** Measurement grid: dx=5mm, dy=5mm, dz=5mm

Reference Value = 5.05 V/m; Power Drift = -0.011 dB

Peak SAR (extrapolated) = 0.246 W/kg

**SAR(1 g) = 0.161 mW/g; SAR(10 g) = 0.097 mW/g**

Maximum value of SAR (measured) = 0.176 mW/g

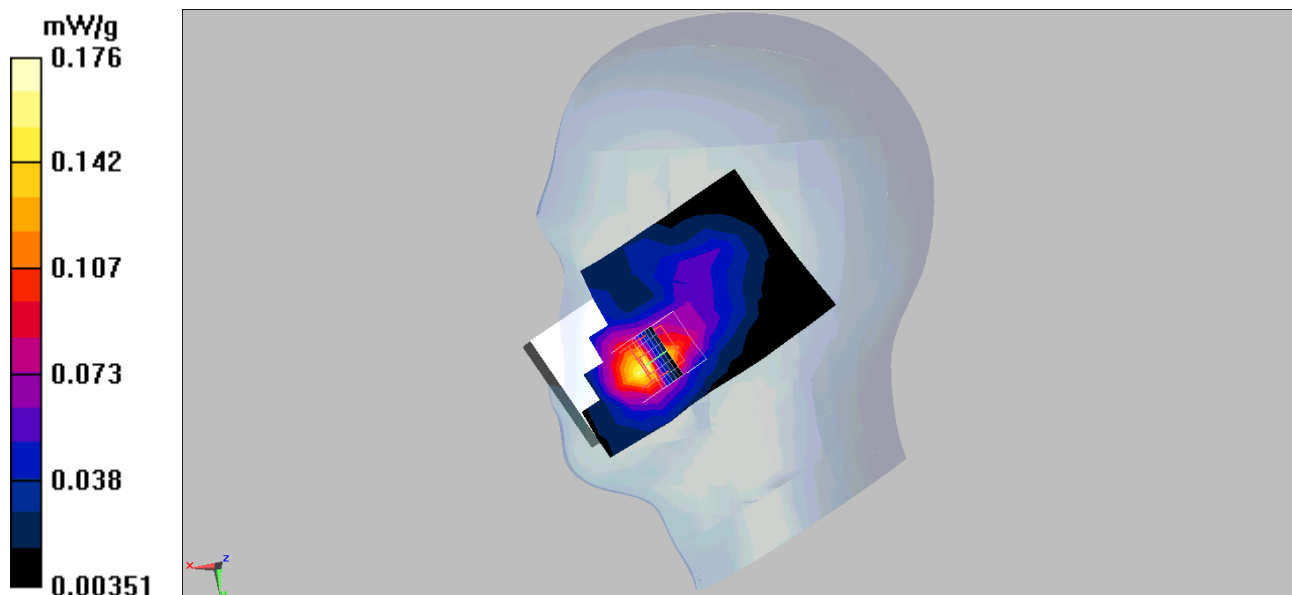

Date/Time: 12/22/2009

Test Laboratory: Quietek

**PCS1900\_Right-Cheek\_Channel-661**

**DUT: Smart Handheld; Type: M900DF**

Communication System: FCC PCS\_1900MHz; Frequency: 1880 MHz; Duty Cycle: 1:8.3

Medium parameters used:  $f = 1880 \text{ MHz}$ ;  $\sigma = 1.38 \text{ mho/m}$ ;  $\epsilon_r = 39.5$ ;  $\rho = 1000 \text{ kg/m}^3$

Phantom section: Right Section

Ambient Temperature ( $^{\circ}\text{C}$ ) : 20.8, Liquid Temperature ( $^{\circ}\text{C}$ ) : 20.1

DASY4 Configuration:

- Probe: EX3DV4 - SN3602; ConvF(7.81, 7.81, 7.81); Calibrated: 5/20/2009
- Sensor-Surface: 4mm (Mechanical Surface Detection)
- Electronics: DAE4 Sn1207; Calibrated: 4/7/2009
- Phantom: SAM Right Table; Type: SAM;
- Measurement SW: DASY5, V5.0 Build 125; SEMCAD X Version 13.4 Build 125

**PCS1900/Area Scan (7x11x1):** Measurement grid: dx=15mm, dy=15mm

Maximum value of SAR (measured) = 0.152 mW/g

**PCS1900/Zoom Scan (7x7x7) (7x7x7)/Cube 0:** Measurement grid: dx=5mm, dy=5mm, dz=5mm

Reference Value = 4.91 V/m; Power Drift = 0.102 dB

Peak SAR (extrapolated) = 0.229 W/kg

**SAR(1 g) = 0.147 mW/g; SAR(10 g) = 0.088 mW/g**

Maximum value of SAR (measured) = 0.160 mW/g

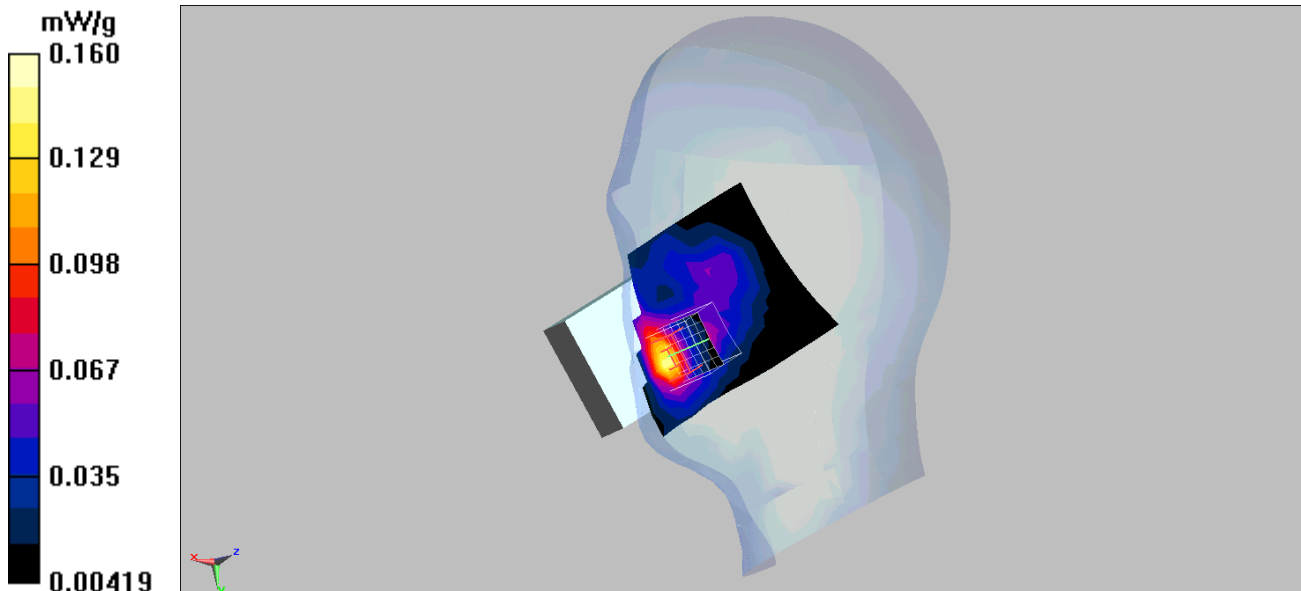

Date/Time: 12/22/2009

Test Laboratory: Quietek

**PCS1900\_Right-Cheek\_Channel-810**

**DUT: Smart Handheld; Type: M900DF**

Communication System: FCC PCS\_1900MHz; Frequency: 1909.8 MHz; Duty Cycle: 1:8.3

Medium parameters used:  $f = 1909.8$  MHz;  $\sigma = 1.41$  mho/m;  $\epsilon_r = 38.9$ ;  $\rho = 1000$  kg/m<sup>3</sup>

Phantom section: Right Section

Ambient Temperature (°C) : 20.8, Liquid Temperature (°C) : 20.1

DASY4 Configuration:

- Probe: EX3DV4 - SN3602; ConvF(7.81, 7.81, 7.81); Calibrated: 5/20/2009
- Sensor-Surface: 4mm (Mechanical Surface Detection)
- Electronics: DAE4 Sn1207; Calibrated: 4/7/2009
- Phantom: SAM Right Table; Type: SAM;
- Measurement SW: DASY5, V5.0 Build 125; SEMCAD X Version 13.4 Build 125

**PCS1900/Area Scan (7x11x1):** Measurement grid: dx=15mm, dy=15mm

Maximum value of SAR (measured) = 0.178 mW/g

**PCS1900/Zoom Scan (7x7x7) (7x7x7)/Cube 0:** Measurement grid: dx=5mm, dy=5mm, dz=5mm

Reference Value = 5.38 V/m; Power Drift = 0.144 dB

Peak SAR (extrapolated) = 0.260 W/kg

**SAR(1 g) = 0.169 mW/g; SAR(10 g) = 0.101 mW/g**

Maximum value of SAR (measured) = 0.185 mW/g

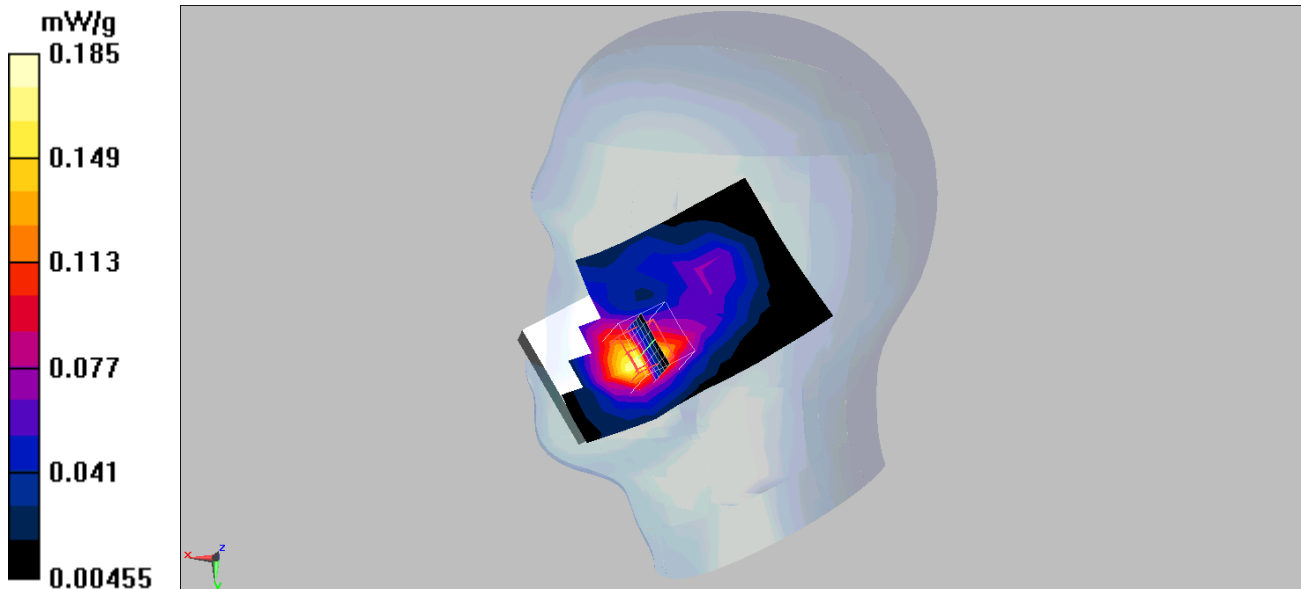

Date/Time: 12/22/2009

Test Laboratory: Quietek

**PCS1900\_Right-Tilt\_Channel-512**

**DUT: Smart Handheld; Type: M900DF**

Communication System: FCC PCS\_1900MHz; Frequency: 1850.2 MHz; Duty Cycle: 1:8.3

Medium parameters used:  $f = 1850.2$  MHz;  $\sigma = 1.36$  mho/m;  $\epsilon_r = 39.1$ ;  $\rho = 1000$  kg/m<sup>3</sup>

Phantom section: Right Section

Ambient Temperature (°C) : 20.8, Liquid Temperature (°C) : 20.1

DASY4 Configuration:

- Probe: EX3DV4 - SN3602; ConvF(7.81, 7.81, 7.81); Calibrated: 5/20/2009
- Sensor-Surface: 4mm (Mechanical Surface Detection)
- Electronics: DAE4 Sn1207; Calibrated: 4/7/2009
- Phantom: SAM Right Table; Type: SAM;
- Measurement SW: DASY5, V5.0 Build 125; SEMCAD X Version 13.4 Build 125

**PCS1900/Area Scan (7x11x1):** Measurement grid: dx=15mm, dy=15mm

Maximum value of SAR (measured) = 0.076 mW/g

**PCS1900/Zoom Scan (7x7x7) (7x7x7)/Cube 0:** Measurement grid: dx=5mm, dy=5mm, dz=5mm

Reference Value = 7.62 V/m; Power Drift = 0.095 dB

Peak SAR (extrapolated) = 0.146 W/kg

**SAR(1 g) = 0.096 mW/g; SAR(10 g) = 0.058 mW/g**

Maximum value of SAR (measured) = 0.106 mW/g

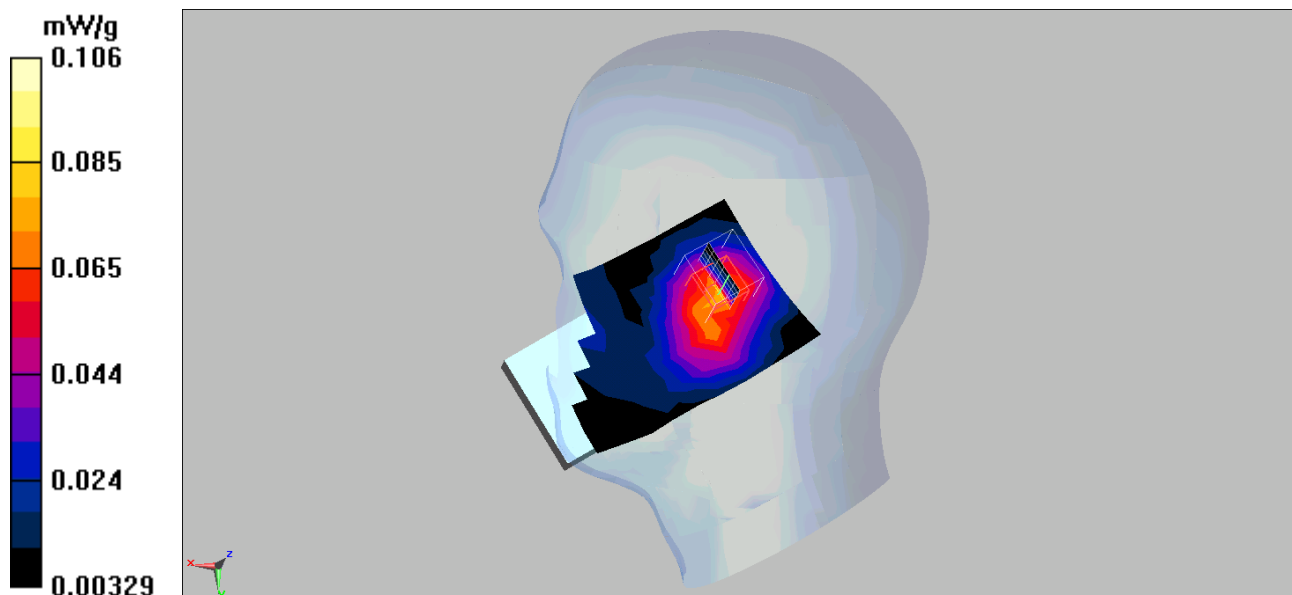

Date/Time: 12/22/2009

Test Laboratory: Quietek

**PCS1900\_Right-Tilt\_Channel-661**

**DUT: Smart Handheld; Type: M900DF**

Communication System: FCC PCS\_1900MHz; Frequency: 1880 MHz; Duty Cycle: 1:8.3

Medium parameters used:  $f = 1880 \text{ MHz}$ ;  $\sigma = 1.38 \text{ mho/m}$ ;  $\epsilon_r = 39.5$ ;  $\rho = 1000 \text{ kg/m}^3$

Phantom section: Right Section

Ambient Temperature ( $^{\circ}\text{C}$ ) : 20.8, Liquid Temperature ( $^{\circ}\text{C}$ ) : 20.1

DASY4 Configuration:

- Probe: EX3DV4 - SN3602; ConvF(7.81, 7.81, 7.81); Calibrated: 5/20/2009
- Sensor-Surface: 4mm (Mechanical Surface Detection)
- Electronics: DAE4 Sn1207; Calibrated: 4/7/2009
- Phantom: SAM Right Table; Type: SAM;
- Measurement SW: DASY5, V5.0 Build 125; SEMCAD X Version 13.4 Build 125

**PCS1900/Area Scan (7x11x1):** Measurement grid: dx=15mm, dy=15mm

Maximum value of SAR (measured) = 0.074 mW/g

**PCS1900/Zoom Scan (7x7x7) (7x7x7)/Cube 0:** Measurement grid: dx=5mm, dy=5mm, dz=5mm

Reference Value = 6.94 V/m; Power Drift = 0.074 dB

Peak SAR (extrapolated) = 0.115 W/kg

**SAR(1 g) = 0.075 mW/g; SAR(10 g) = 0.049 mW/g**

Maximum value of SAR (measured) = 0.086 mW/g

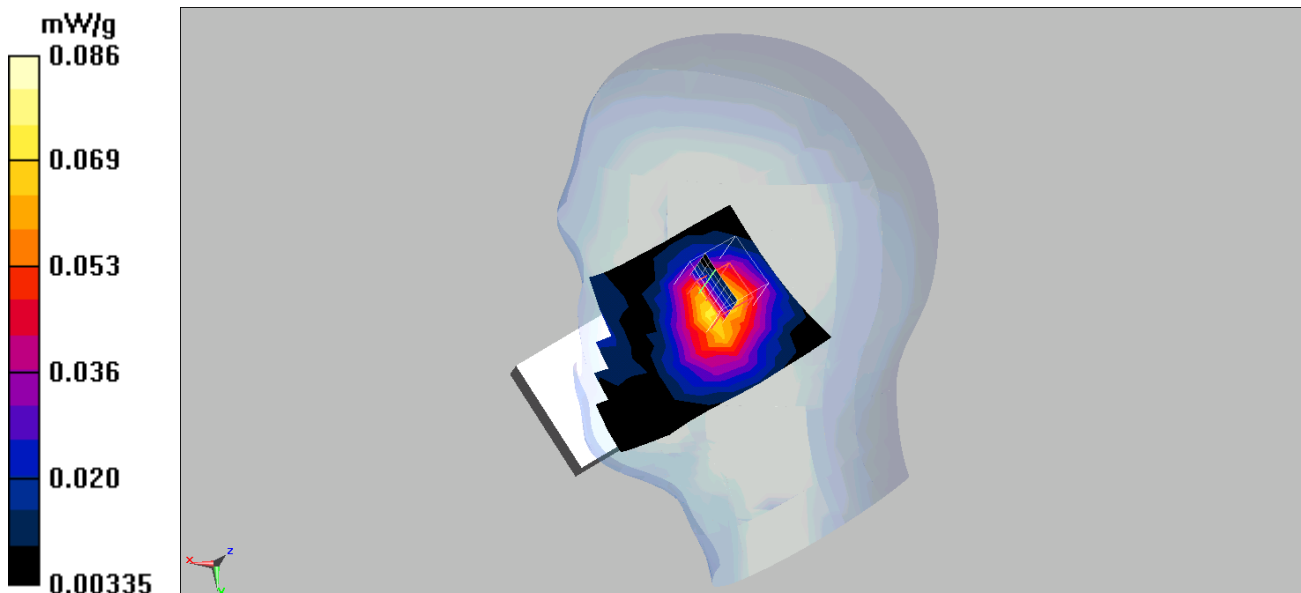

Date/Time: 12/22/2009

Test Laboratory: Quietek

### PCS1900\_Right-Tilt\_Channel-810

**DUT: Smart Handheld; Type: M900DF**

Communication System: FCC PCS\_1900MHz; Frequency: 1909.8 MHz; Duty Cycle: 1:8.3

Medium parameters used:  $f = 1909.8$  MHz;  $\sigma = 1.41$  mho/m;  $\epsilon_r = 38.9$ ;  $\rho = 1000$  kg/m<sup>3</sup>

Phantom section: Right Section

Ambient Temperature (°C) : 20.8, Liquid Temperature (°C) : 20.1

DASY4 Configuration:

- Probe: EX3DV4 - SN3602; ConvF(7.81, 7.81, 7.81); Calibrated: 5/20/2009
- Sensor-Surface: 4mm (Mechanical Surface Detection)
- Electronics: DAE4 Sn1207; Calibrated: 4/7/2009
- Phantom: SAM Right Table; Type: SAM;
- Measurement SW: DASY5, V5.0 Build 125; SEMCAD X Version 13.4 Build 125

**PCS1900/Area Scan (7x11x1):** Measurement grid: dx=15mm, dy=15mm

Maximum value of SAR (measured) = 0.088 mW/g

**PCS1900/Zoom Scan (7x7x7) (7x7x7)/Cube 0:** Measurement grid: dx=5mm, dy=5mm, dz=5mm

Reference Value = 7.06 V/m; Power Drift = 0.167 dB

Peak SAR (extrapolated) = 0.133 W/kg

**SAR(1 g) = 0.086 mW/g; SAR(10 g) = 0.053 mW/g**

Maximum value of SAR (measured) = 0.093 mW/g

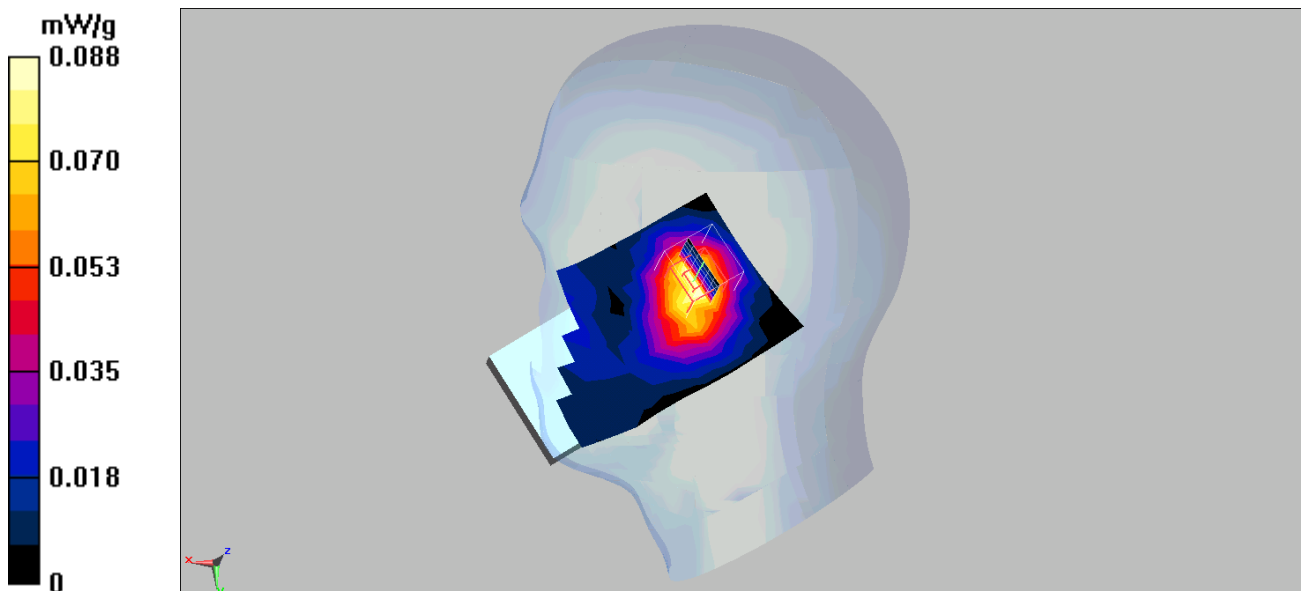



Date/Time: 12/22/2009

Test Laboratory: Quietek

### PCS1900\_Body\_Channel-512

**DUT: Smart Handheld; Type: M900DF**

Communication System: FCC PCS\_1900MHz; Frequency: 1850.2 MHz; Duty Cycle: 1:8.3

Medium parameters used:  $f = 1850.2$  MHz;  $\sigma = 1.46$  mho/m;  $\epsilon_r = 53.5$ ;  $\rho = 1000$  kg/m<sup>3</sup>

Phantom section: Flat Section

Ambient Temperature (°C) : 20.8, Liquid Temperature (°C) : 20.1

DASY4 Configuration:

- Probe: EX3DV4 - SN3602; ConvF(7.97, 7.97, 7.97); Calibrated: 5/20/2009
- Sensor-Surface: 4mm (Mechanical Surface Detection)
- Electronics: DAE4 Sn1207; Calibrated: 4/7/2009
- Phantom: SAM Right Table; Type: SAM;
- Measurement SW: DASY5, V5.0 Build 125; SEMCAD X Version 13.4 Build 125

**PCS1900/Area Scan (7x11x1):** Measurement grid: dx=15mm, dy=15mm

Maximum value of SAR (measured) = 0.346 mW/g

**PCS1900/Zoom Scan (7x7x7) (7x7x7)/Cube 0:** Measurement grid: dx=5mm, dy=5mm, dz=5mm

Reference Value = 7.9 V/m; Power Drift = 0.056 dB

Peak SAR (extrapolated) = 0.551 W/kg

**SAR(1 g) = 0.338 mW/g; SAR(10 g) = 0.210 mW/g**

Maximum value of SAR (measured) = 0.364 mW/g

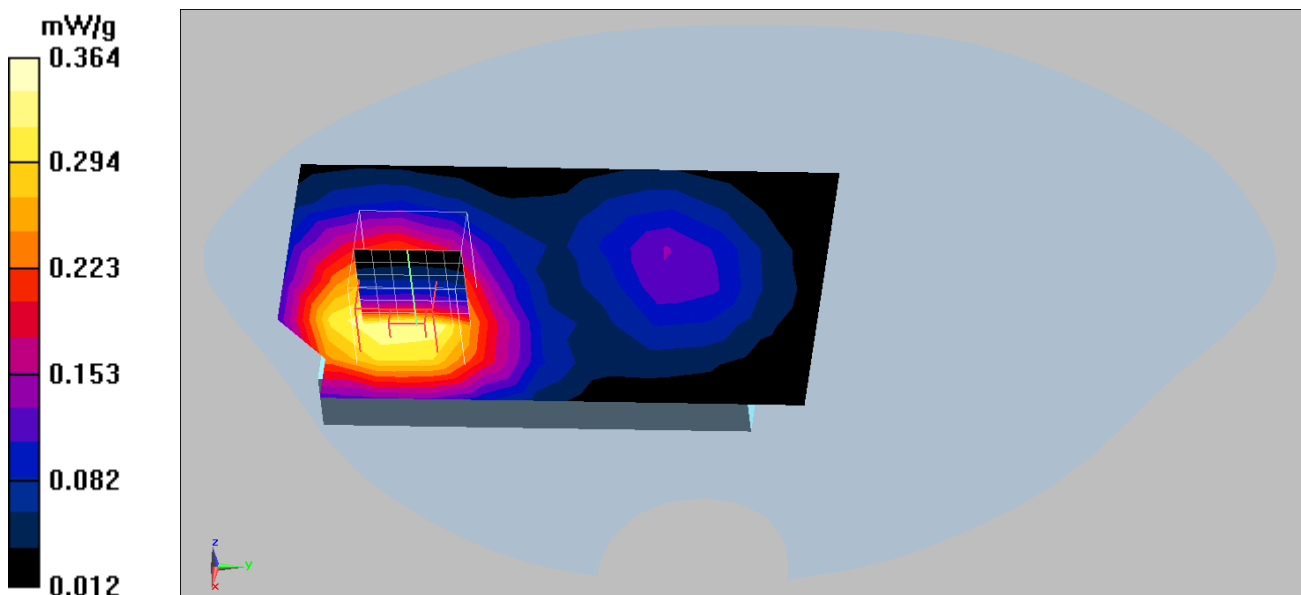

Date/Time: 12/22/2009

Test Laboratory: Quietek

**PCS1900\_Body\_Channel-661**

**DUT: Smart Handheld; Type: M900DF**

Communication System: FCC PCS\_1900MHz; Frequency: 1880 MHz;Duty Cycle: 1:8.3

Medium parameters used:  $f = 1880 \text{ MHz}$ ;  $\sigma = 1.48 \text{ mho/m}$ ;  $\epsilon_r = 53.2$ ;  $\rho = 1000 \text{ kg/m}^3$

Phantom section: Flat Section

Ambient Temperature ( $^{\circ}\text{C}$ ) : 20.8, Liquid Temperature ( $^{\circ}\text{C}$ ) : 20.1

DASY4 Configuration:

- Probe: EX3DV4 - SN3602; ConvF(7.97, 7.97, 7.97); Calibrated: 5/20/2009
- Sensor-Surface: 4mm (Mechanical Surface Detection)
- Electronics: DAE4 Sn1207; Calibrated: 4/7/2009
- Phantom: SAM Right Table; Type: SAM;
- Measurement SW: DASY5, V5.0 Build 125; SEMCAD X Version 13.4 Build 125

**PCS1900/Area Scan (7x11x1):** Measurement grid: dx=15mm, dy=15mm

Maximum value of SAR (measured) = 0.339 mW/g

**PCS1900/Zoom Scan (7x7x7) (7x7x7)/Cube 0:** Measurement grid: dx=5mm, dy=5mm, dz=5mm

Reference Value = 7.56 V/m; Power Drift = 0.039 dB

Peak SAR (extrapolated) = 0.535 W/kg

**SAR(1 g) = 0.317 mW/g; SAR(10 g) = 0.196 mW/g**

Maximum value of SAR (measured) = 0.342 mW/g

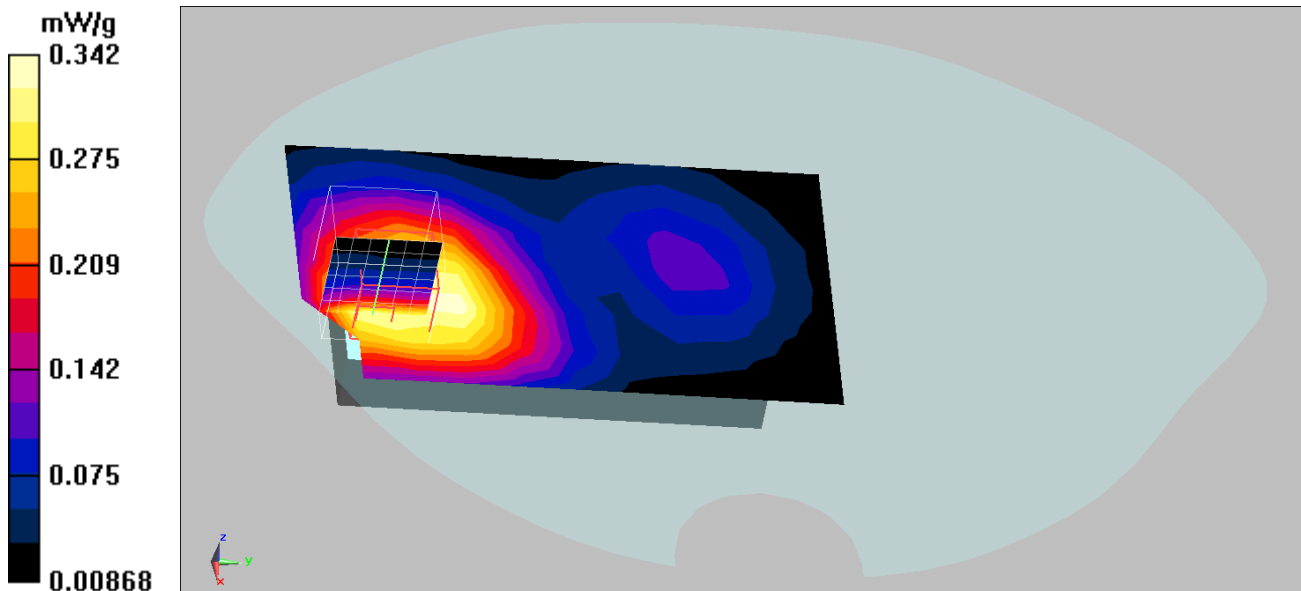

Date/Time: 12/22/2009

Test Laboratory: Quietek

**PCS1900\_Body\_Channel-810**

**DUT: Smart Handheld; Type: M900DF**

Communication System: FCC PCS\_1900MHz; Frequency: 1909.8 MHz; Duty Cycle: 1:8.3

Medium parameters used:  $f = 1909.8$  MHz;  $\sigma = 1.51$  mho/m;  $\epsilon_r = 52.2$ ;  $\rho = 1000$  kg/m<sup>3</sup>

Phantom section: Flat Section

Ambient Temperature (°C) : 20.8, Liquid Temperature (°C) : 20.1

DASY4 Configuration:

- Probe: EX3DV4 - SN3602; ConvF(7.97, 7.97, 7.97); Calibrated: 5/20/2009
- Sensor-Surface: 4mm (Mechanical Surface Detection)
- Electronics: DAE4 Sn1207; Calibrated: 4/7/2009
- Phantom: SAM Right Table; Type: SAM;
- Measurement SW: DASY5, V5.0 Build 125; SEMCAD X Version 13.4 Build 125

**PCS1900/Area Scan (7x11x1):** Measurement grid: dx=15mm, dy=15mm

Maximum value of SAR (measured) = 0.373 mW/g

**PCS1900/Zoom Scan (7x7x7) (7x7x7)/Cube 0:** Measurement grid: dx=5mm, dy=5mm, dz=5mm

Reference Value = 7.35 V/m; Power Drift = 0.056 dB

Peak SAR (extrapolated) = 0.588 W/kg

**SAR(1 g) = 0.344 mW/g; SAR(10 g) = 0.202 mW/g**

Maximum value of SAR (measured) = 0.371 mW/g

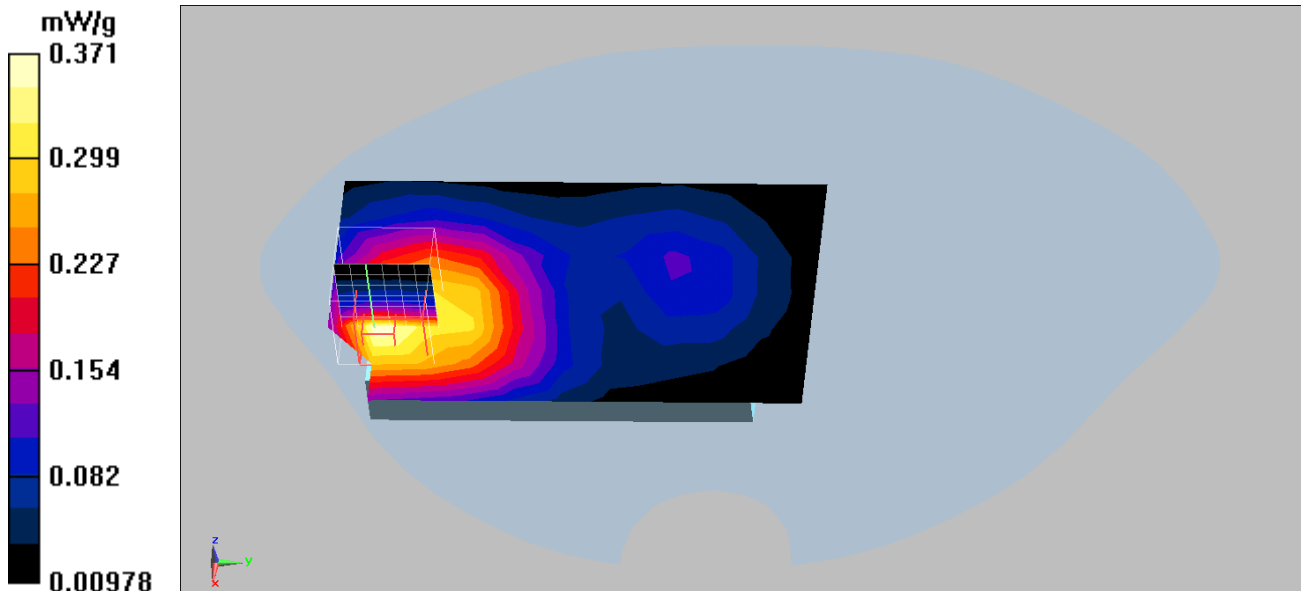

Date/Time: 12/22/2009

Test Laboratory: Quietek

**PCS1900\_Body\_Channel-661 GPRS\_2 slot**

**DUT: Smart Handheld; Type: M900DF**

Communication System: FCC PCS\_1900MHz\_GPRS -2 Slot; Frequency: 1880 MHz; Duty Cycle: 1:4.1

Medium parameters used:  $f = 1880 \text{ MHz}$ ;  $\sigma = 1.48 \text{ mho/m}$ ;  $\epsilon_r = 53.2$ ;  $\rho = 1000 \text{ kg/m}^3$

Phantom section: Flat Section

Ambient Temperature ( $^{\circ}\text{C}$ ) : 20.8, Liquid Temperature ( $^{\circ}\text{C}$ ) : 20.1

DASY4 Configuration:

- Probe: EX3DV4 - SN3602; ConvF(7.97, 7.97, 7.97); Calibrated: 5/20/2009
- Sensor-Surface: 4mm (Mechanical Surface Detection)
- Electronics: DAE4 Sn1207; Calibrated: 4/7/2009
- Phantom: SAM Right Table; Type: SAM;
- Measurement SW: DASY5, V5.0 Build 125; SEMCAD X Version 13.4 Build 125

**PCS1900/Area Scan (7x11x1):** Measurement grid: dx=15mm, dy=15mm

Maximum value of SAR (measured) = 0.525 mW/g

**PCS1900/Zoom Scan (7x7x7) (7x7x7)/Cube 0:** Measurement grid: dx=5mm, dy=5mm, dz=5mm

Reference Value = 9.56 V/m; Power Drift = -0.00518 dB

Peak SAR (extrapolated) = 0.836 W/kg

**SAR(1 g) = 0.515 mW/g; SAR(10 g) = 0.316 mW/g**

Maximum value of SAR (measured) = 0.559 mW/g

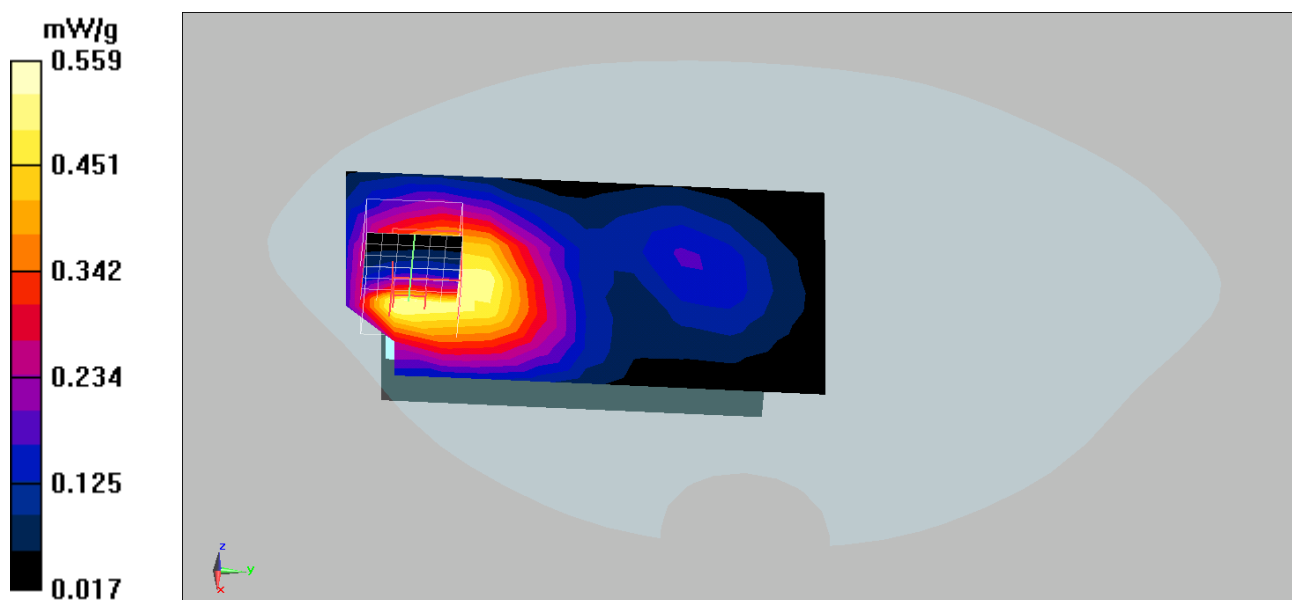

Date/Time: 12/22/2009

Test Laboratory: Quietek

**PCS1900\_Body\_Channel-661 GPRS\_3 slot**

**DUT: Smart Handheld; Type: M900DF**

Communication System: FCC PCS\_1900MHz\_GPRS -3 Slot; Frequency: 1880 MHz;Duty Cycle: 1:2.7

Medium parameters used:  $f = 1880$  MHz;  $\sigma = 1.48$  mho/m;  $\epsilon_r = 53.2$ ;  $\rho = 1000$  kg/m<sup>3</sup>

Phantom section: Flat Section

Ambient Temperature (°C) : 20.8, Liquid Temperature (°C) : 20.1

DASY4 Configuration:

- Probe: EX3DV4 - SN3602; ConvF(7.97, 7.97, 7.97); Calibrated: 5/20/2009
- Sensor-Surface: 4mm (Mechanical Surface Detection)
- Electronics: DAE4 Sn1207; Calibrated: 4/7/2009
- Phantom: SAM Right Table; Type: SAM;
- Measurement SW: DASY5, V5.0 Build 125; SEMCAD X Version 13.4 Build 125

**PCS1900/Area Scan (7x11x1):** Measurement grid: dx=15mm, dy=15mm

Maximum value of SAR (measured) = 0.828 mW/g

**PCS1900/Zoom Scan (7x7x7) (7x7x7)/Cube 0:** Measurement grid: dx=5mm, dy=5mm, dz=5mm

Reference Value = 13 V/m; Power Drift = -0.166 dB

Peak SAR (extrapolated) = 1.36 W/kg

**SAR(1 g) = 0.812 mW/g; SAR(10 g) = 0.481 mW/g**

Maximum value of SAR (measured) = 0.892 mW/g

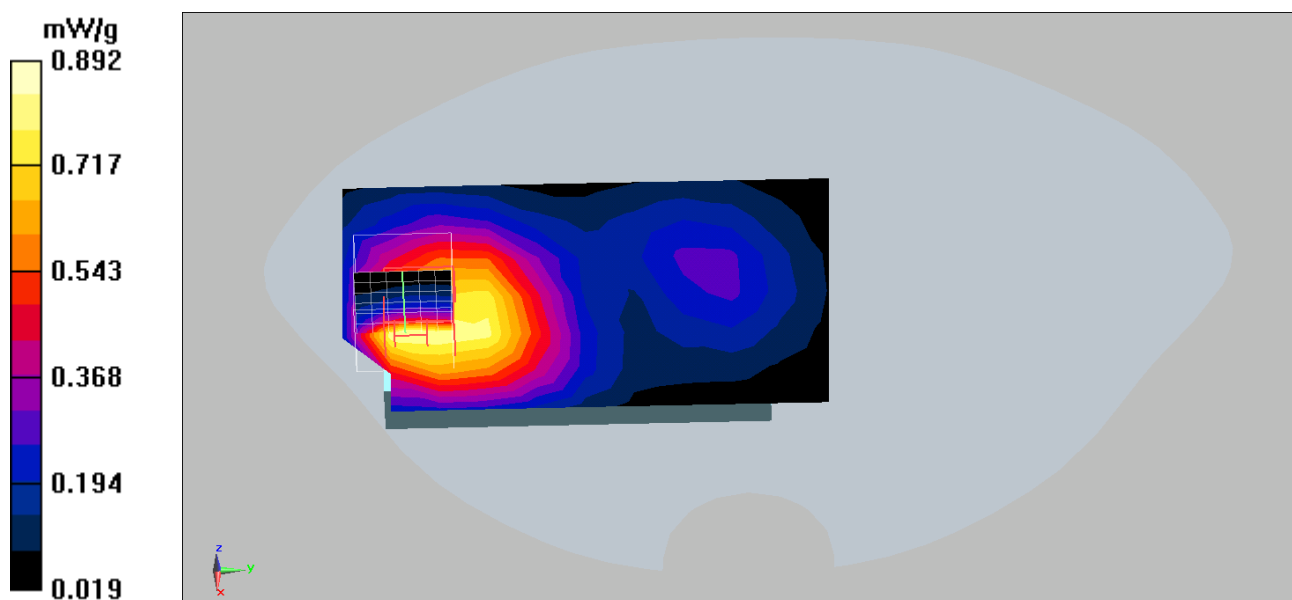

Date/Time: 12/22/2009

Test Laboratory: Quietek

**PCS1900\_Body\_Channel-512 GPRS\_4 slot**

**DUT: Smart Handheld; Type: M900DF**

Communication System: FCC PCS\_1900MHz\_GPRS -4 Slot; Frequency: 1850.2 MHz; Duty Cycle: 1:2

Medium parameters used:  $f = 1850.2$  MHz;  $\sigma = 1.46$  mho/m;  $\epsilon_r = 53.5$ ;  $\rho = 1000$  kg/m<sup>3</sup>

Phantom section: Flat Section

Ambient Temperature (°C) : 20.8, Liquid Temperature (°C) : 20.1

DASY4 Configuration:

- Probe: EX3DV4 - SN3602; ConvF(7.97, 7.97, 7.97); Calibrated: 5/20/2009
- Sensor-Surface: 4mm (Mechanical Surface Detection)
- Electronics: DAE4 Sn1207; Calibrated: 4/7/2009
- Phantom: SAM Right Table; Type: SAM;
- Measurement SW: DASY5, V5.0 Build 125; SEMCAD X Version 13.4 Build 125

**PCS1900/Area Scan (7x11x1):** Measurement grid: dx=15mm, dy=15mm

Maximum value of SAR (measured) = 1.08 mW/g

**PCS1900/Zoom Scan (7x7x7) (7x7x7)/Cube 0:** Measurement grid: dx=5mm, dy=5mm, dz=5mm

Reference Value = 14.7 V/m; Power Drift = 0.045 dB

Peak SAR (extrapolated) = 1.71 W/kg

**SAR(1 g) = 1.01 mW/g; SAR(10 g) = 0.619 mW/g**

Maximum value of SAR (measured) = 1.09 mW/g

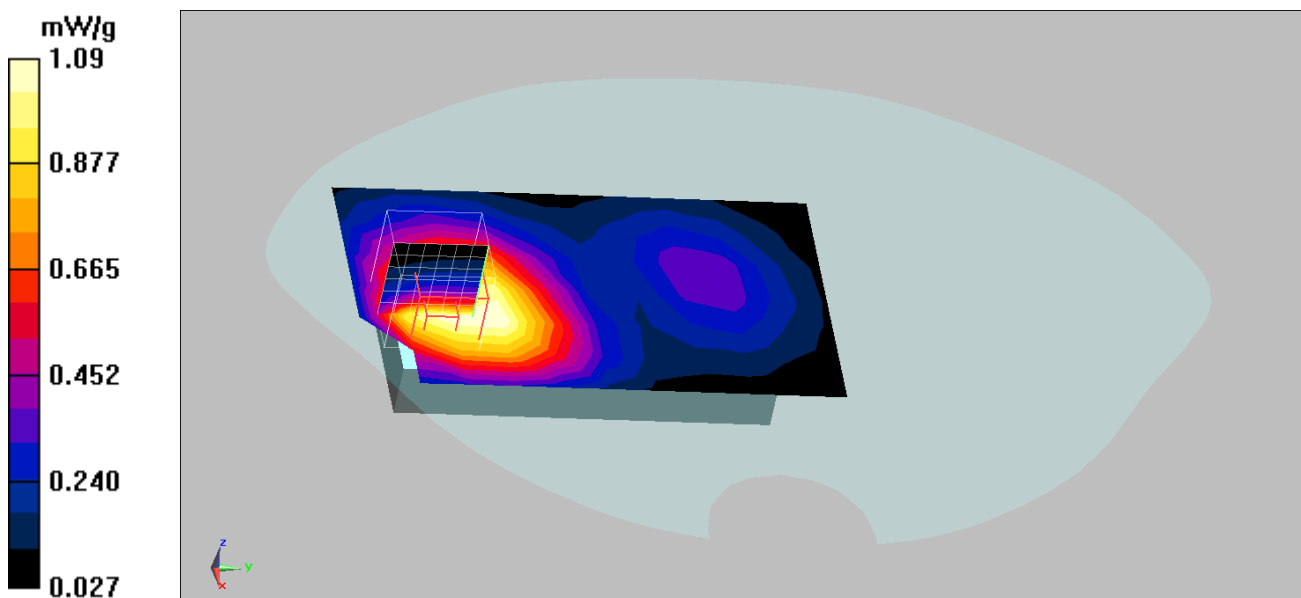

Date/Time: 12/22/2009

Test Laboratory: Quietek

**PCS1900\_Body\_Channel-661 GPRS\_4 slot**

**DUT: Smart Handheld; Type: M900DF**

Communication System: FCC PCS\_1900MHz\_GPRS -4 Slot; Frequency: 1880 MHz;Duty Cycle: 1:2

Medium parameters used:  $f = 1880 \text{ MHz}$ ;  $\sigma = 1.48 \text{ mho/m}$ ;  $\epsilon_r = 53.2$ ;  $\rho = 1000 \text{ kg/m}^3$

Phantom section: Flat Section

Ambient Temperature ( $^{\circ}\text{C}$ ) : 20.8, Liquid Temperature ( $^{\circ}\text{C}$ ) : 20.1

DASY4 Configuration:

- Probe: EX3DV4 - SN3602; ConvF(7.97, 7.97, 7.97); Calibrated: 5/20/2009
- Sensor-Surface: 4mm (Mechanical Surface Detection)
- Electronics: DAE4 Sn1207; Calibrated: 4/7/2009
- Phantom: SAM Right Table; Type: SAM;
- Measurement SW: DASY5, V5.0 Build 125; SEMCAD X Version 13.4 Build 125

**PCS1900/Area Scan (7x11x1):** Measurement grid: dx=15mm, dy=15mm

Maximum value of SAR (measured) = 1.04 mW/g

**PCS1900/Zoom Scan (7x7x7) (7x7x7)/Cube 0:** Measurement grid: dx=5mm, dy=5mm, dz=5mm

Reference Value = 14.4 V/m; Power Drift = -0.098 dB

Peak SAR (extrapolated) = 1.76 W/kg

**SAR(1 g) = 1.05 mW/g; SAR(10 g) = 0.616 mW/g**

Maximum value of SAR (measured) = 1.15 mW/g

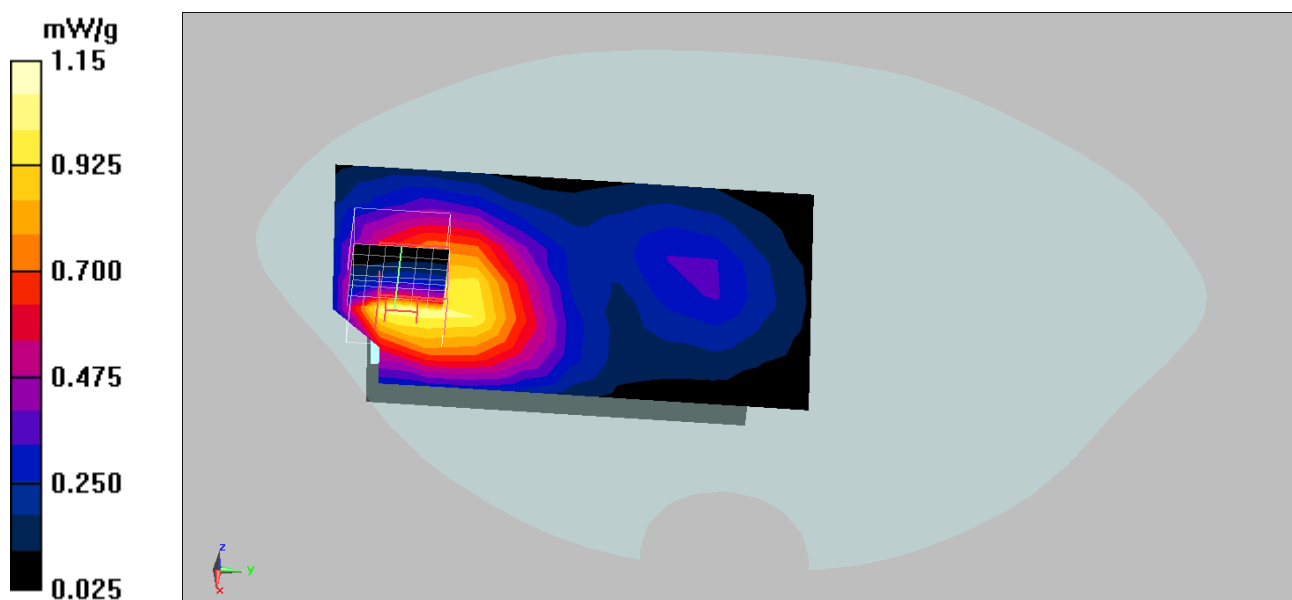

Date/Time: 12/22/2009

Test Laboratory: Quietek

**PCS1900\_Body\_Channel-810 GPRS\_4 slot**

**DUT: Smart Handheld; Type: M900DF**

Communication System: FCC PCS\_1900MHz\_GPRS -4 Slot; Frequency: 1909.8 MHz; Duty Cycle: 1:2

Medium parameters used:  $f = 1909.8$  MHz;  $\sigma = 1.51$  mho/m;  $\epsilon_r = 52.2$ ;  $\rho = 1000$  kg/m<sup>3</sup>

Phantom section: Flat Section

Ambient Temperature (°C) : 20.8, Liquid Temperature (°C) : 20.1

DASY4 Configuration:

- Probe: EX3DV4 - SN3602; ConvF(7.97, 7.97, 7.97); Calibrated: 5/20/2009
- Sensor-Surface: 4mm (Mechanical Surface Detection)
- Electronics: DAE4 Sn1207; Calibrated: 4/7/2009
- Phantom: SAM Right Table; Type: SAM;
- Measurement SW: DASY5, V5.0 Build 125; SEMCAD X Version 13.4 Build 125

**PCS1900/Area Scan (7x11x1):** Measurement grid: dx=15mm, dy=15mm

Maximum value of SAR (measured) = 1.12 mW/g

**PCS1900/Zoom Scan (7x7x7) (7x7x7)/Cube 0:** Measurement grid: dx=5mm, dy=5mm, dz=5mm

Reference Value = 14.2 V/m; Power Drift = -0.104 dB

Peak SAR (extrapolated) = 1.86 W/kg

**SAR(1 g) = 1.09 mW/g; SAR(10 g) = 0.640 mW/g**

Maximum value of SAR (measured) = 1.21 mW/g

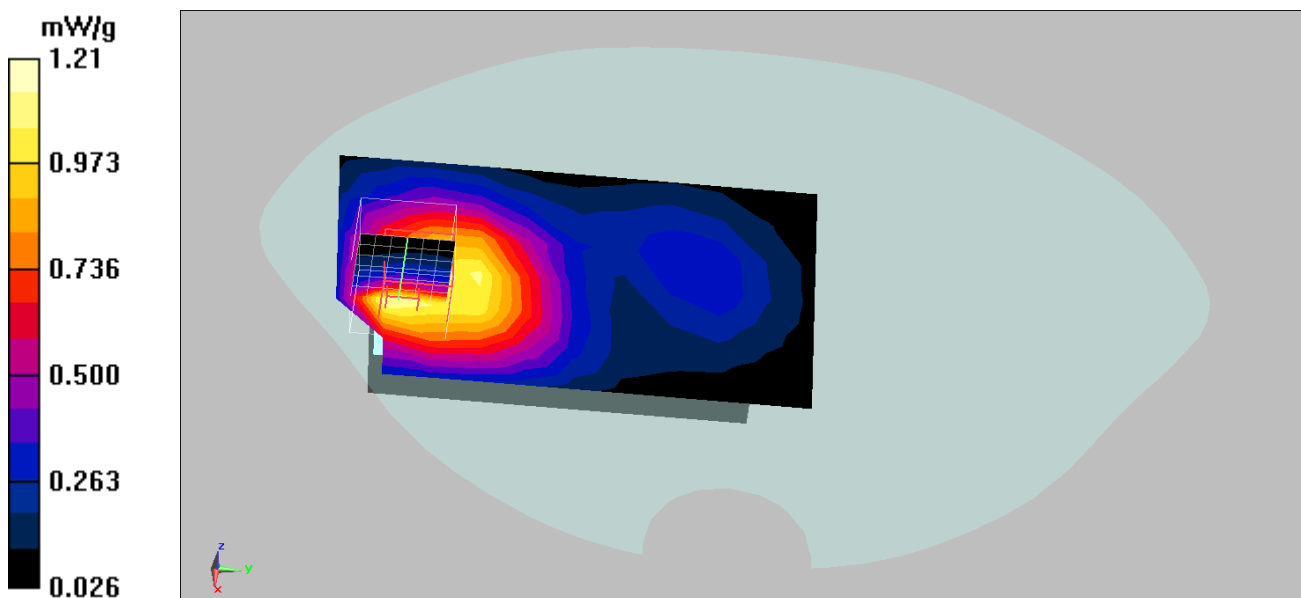



Date/Time: 1/15/2010

Test Laboratory: Quietek

**PCS1900\_Body\_Channel-810 GPRS\_4 slot Front**

**DUT: Mobile Phone; Type: M900DF**

Communication System: FCC PCS\_1900MHz; Frequency: 1909.8 MHz; Duty Cycle: 1:8.3

Medium parameters used:  $f = 1909.8 \text{ MHz}$ ;  $\sigma = 1.52 \text{ mho/m}$ ;  $\epsilon_r = 52.2$ ;  $\rho = 1000 \text{ kg/m}^3$

Phantom section: Flat Section

Ambient Temperature ( $^{\circ}\text{C}$ ) : 20.8, Liquid Temperature ( $^{\circ}\text{C}$ ) : 20.1

DASY4 Configuration:

- Probe: EX3DV4 - SN3602; ConvF(7.97, 7.97, 7.97); Calibrated: 5/20/2009
- Sensor-Surface: 4mm (Mechanical Surface Detection)
- Electronics: DAE4 Sn1207; Calibrated: 4/7/2009
- Phantom: SAM Right Table; Type: SAM;
- Measurement SW: DASY5, V5.0 Build 125; SEMCAD X Version 13.4 Build 125

**PCS1900/Area Scan (8x11x1):** Measurement grid: dx=15mm, dy=15mm

Maximum value of SAR (measured) = 0.361 mW/g

**PCS1900/Zoom Scan (7x7x7) (7x7x7)/Cube 0:** Measurement grid: dx=5mm, dy=5mm, dz=5mm

Reference Value = 10.7 V/m; Power Drift = -0.046 dB

Peak SAR (extrapolated) = 0.554 W/kg

**SAR(1 g) = 0.328 mW/g; SAR(10 g) = 0.194 mW/g**

Maximum value of SAR (measured) = 0.354 mW/g

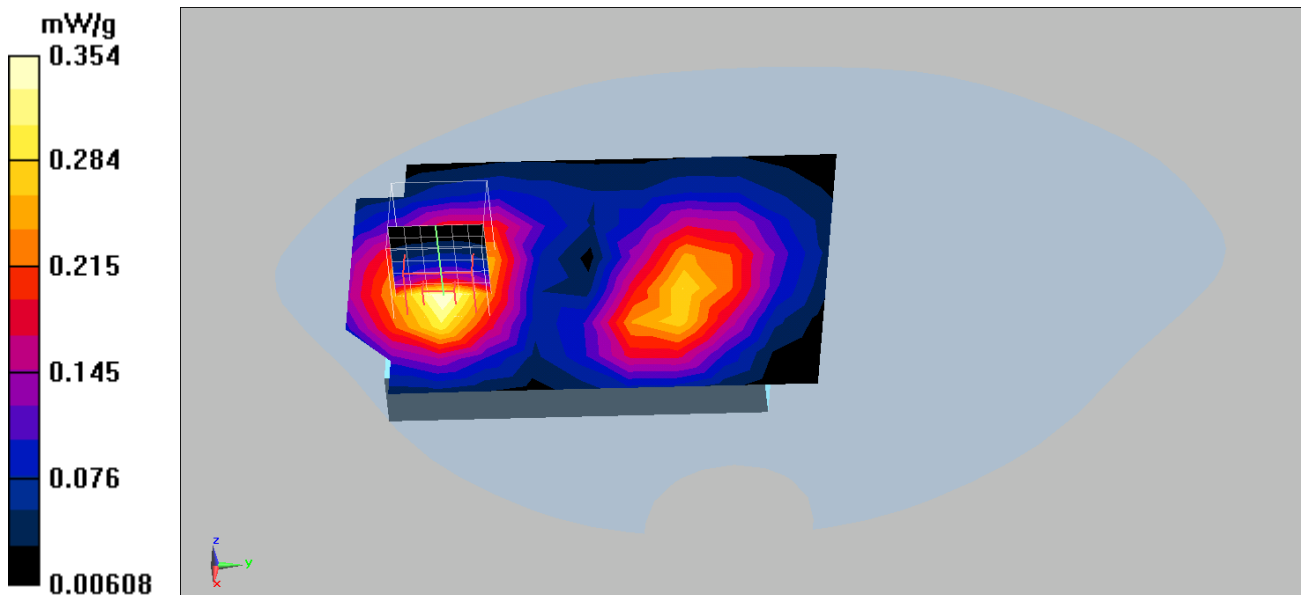

Date/Time: 12/22/2009

Test Laboratory: Quietek

**PCS1900\_Body\_Channel-810 EGPRS\_4 slot**

**DUT: Smart Handheld; Type: M900DF**

Communication System: FCC PCS\_1900MHz\_ EGPRS-4 Slot; Frequency: 1909.8 MHz; Duty Cycle: 1:2

Medium parameters used:  $f = 1909.8$  MHz;  $\sigma = 1.51$  mho/m;  $\epsilon_r = 52.2$ ;  $\rho = 1000$  kg/m<sup>3</sup>

Phantom section: Flat Section

Ambient Temperature (°C) : 20.8, Liquid Temperature (°C) : 20.1

DASY4 Configuration:

- Probe: EX3DV4 - SN3602; ConvF(7.97, 7.97, 7.97); Calibrated: 5/20/2009
- Sensor-Surface: 4mm (Mechanical Surface Detection)
- Electronics: DAE4 Sn1207; Calibrated: 4/7/2009
- Phantom: SAM Right Table; Type: SAM;
- Measurement SW: DASY5, V5.0 Build 125; SEMCAD X Version 13.4 Build 125

**PCS1900/Area Scan (7x11x1):** Measurement grid: dx=15mm, dy=15mm

Maximum value of SAR (measured) = 1.1 mW/g

**PCS1900/Zoom Scan (7x7x7) (7x7x7)/Cube 0:** Measurement grid: dx=5mm, dy=5mm, dz=5mm

Reference Value = 13.5 V/m; Power Drift = 0.057 dB

Peak SAR (extrapolated) = 1.83 W/kg

Peak SAR (extrapolated) = 1.83 W/kg

**SAR(1 g) = 1.08 mW/g; SAR(10 g) = 0.633 mW/g**

Maximum value of SAR (measured) = 1.19 mW/g

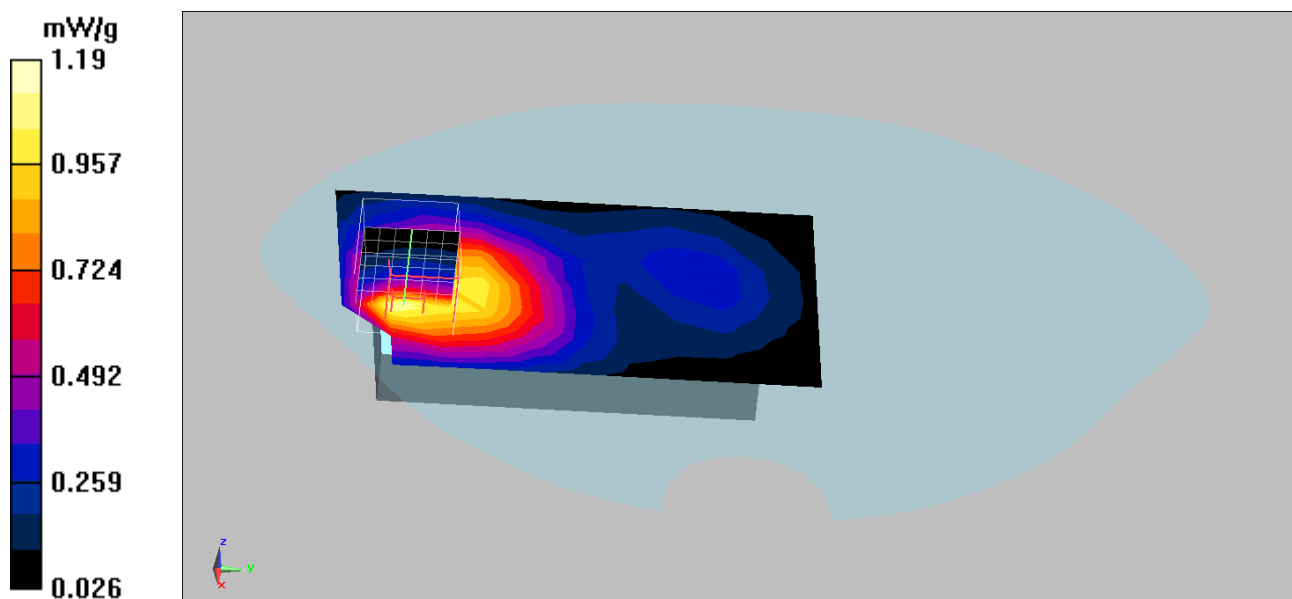

PCS 1900 GPRS 4 Slot EUT Bottom Z-Axis plot  
Channel: 810

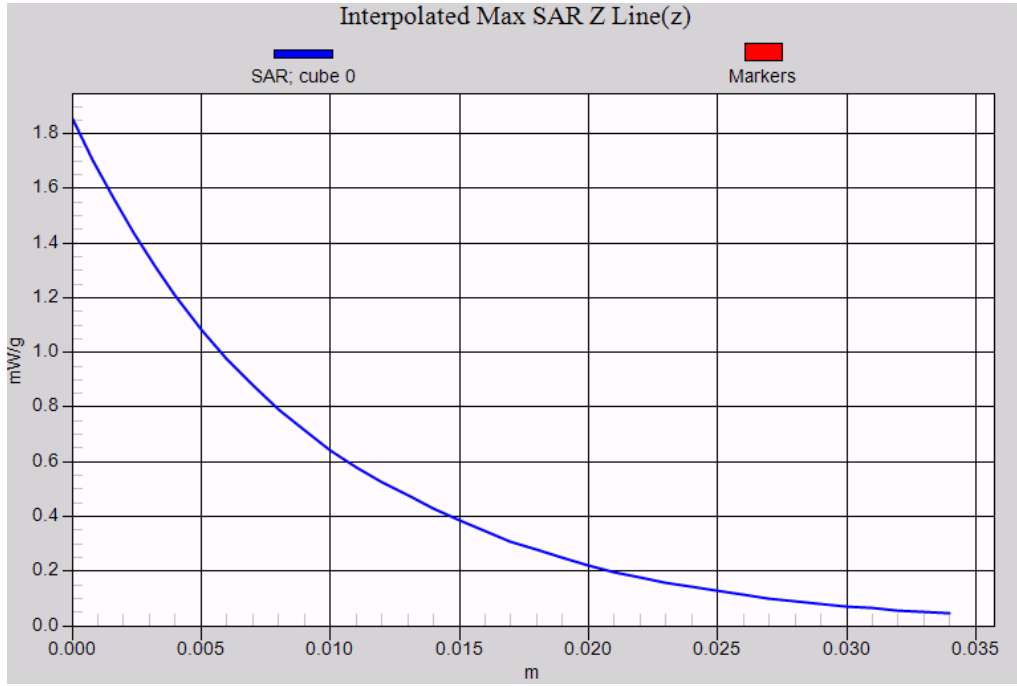

Date/Time: 12/21/2009

Test Laboratory: Quietek

**Band V\_Left-Cheek\_Channel-4132**

**DUT: Smart Handheld; Type: M900DF**

Communication System: FCC WCDMA\_Band-V; Frequency: 826.4 MHz; Duty Cycle: 1:1

Medium parameters used:  $f = 826.4 \text{ MHz}$ ;  $\sigma = 0.91 \text{ mho/m}$ ;  $\epsilon_r = 42.3$ ;  $\rho = 1000 \text{ kg/m}^3$

Phantom section: Left Section

Ambient Temperature ( $^{\circ}\text{C}$ ) : 20.9, Liquid Temperature ( $^{\circ}\text{C}$ ) : 20.1

DASY4 Configuration:

- Probe: EX3DV4 - SN3602; ConvF(9.14, 9.14, 9.14); Calibrated: 5/20/2009
- Sensor-Surface: 4mm (Mechanical Surface Detection)
- Electronics: DAE4 Sn1207; Calibrated: 4/7/2009
- Phantom: SAM Left Table; Type: SAM;
- Measurement SW: DASY5, V5.0 Build 125; SEMCAD X Version 13.4 Build 125

**Band V/Area Scan (7x11x1):** Measurement grid: dx=15mm, dy=15mm

Maximum value of SAR (measured) = 0.119 mW/g

**Band V/Zoom Scan (7x7x7) (7x7x7)/Cube 0:** Measurement grid: dx=5mm, dy=5mm, dz=5mm

Reference Value = 2.65 V/m; Power Drift = 0.00834 dB

Peak SAR (extrapolated) = 0.140 W/kg

**SAR(1 g) = 0.116 mW/g; SAR(10 g) = 0.090 mW/g**

Maximum value of SAR (measured) = 0.123 mW/g

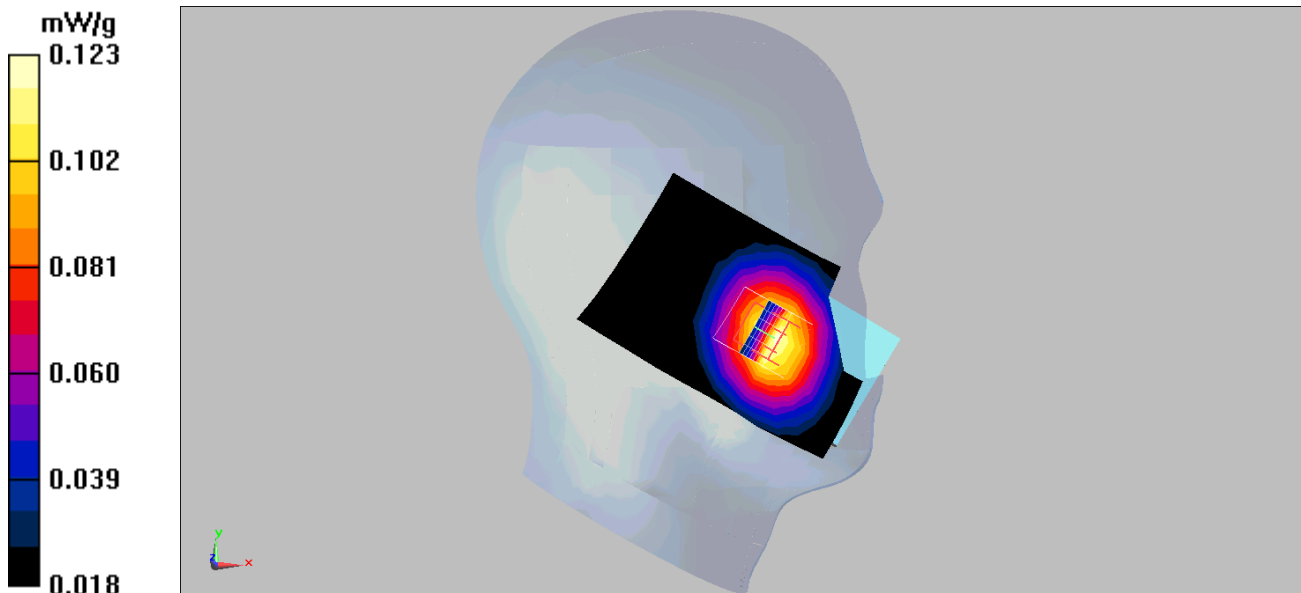

Date/Time: 12/21/2009

Test Laboratory: Quietek

**Band V\_Left-Cheek\_Channel-4183**

**DUT: Smart Handheld; Type: M900DF**

Communication System: FCC WCDMA\_Band-V; Frequency: 836.6 MHz; Duty Cycle: 1:1

Medium parameters used:  $f = 836.6 \text{ MHz}$ ;  $\sigma = 0.92 \text{ mho/m}$ ;  $\epsilon_r = 41.8$ ;  $\rho = 1000 \text{ kg/m}^3$

Phantom section: Left Section

Ambient Temperature ( $^{\circ}\text{C}$ ) : 20.9, Liquid Temperature ( $^{\circ}\text{C}$ ) : 20.1

DASY4 Configuration:

- Probe: EX3DV4 - SN3602; ConvF(9.14, 9.14, 9.14); Calibrated: 5/20/2009
- Sensor-Surface: 4mm (Mechanical Surface Detection)
- Electronics: DAE4 Sn1207; Calibrated: 4/7/2009
- Phantom: SAM Left Table; Type: SAM;
- Measurement SW: DASY5, V5.0 Build 125; SEMCAD X Version 13.4 Build 125

**Band V/Area Scan (7x11x1):** Measurement grid: dx=15mm, dy=15mm

Maximum value of SAR (measured) = 0.086 mW/g

**Band V/Zoom Scan (7x7x7) (7x7x7)/Cube 0:** Measurement grid: dx=5mm, dy=5mm, dz=5mm

Reference Value = 1.67 V/m; Power Drift = 0.159 dB

Peak SAR (extrapolated) = 0.104 W/kg

**SAR(1 g) = 0.086 mW/g; SAR(10 g) = 0.067 mW/g**

Maximum value of SAR (measured) = 0.091 mW/g

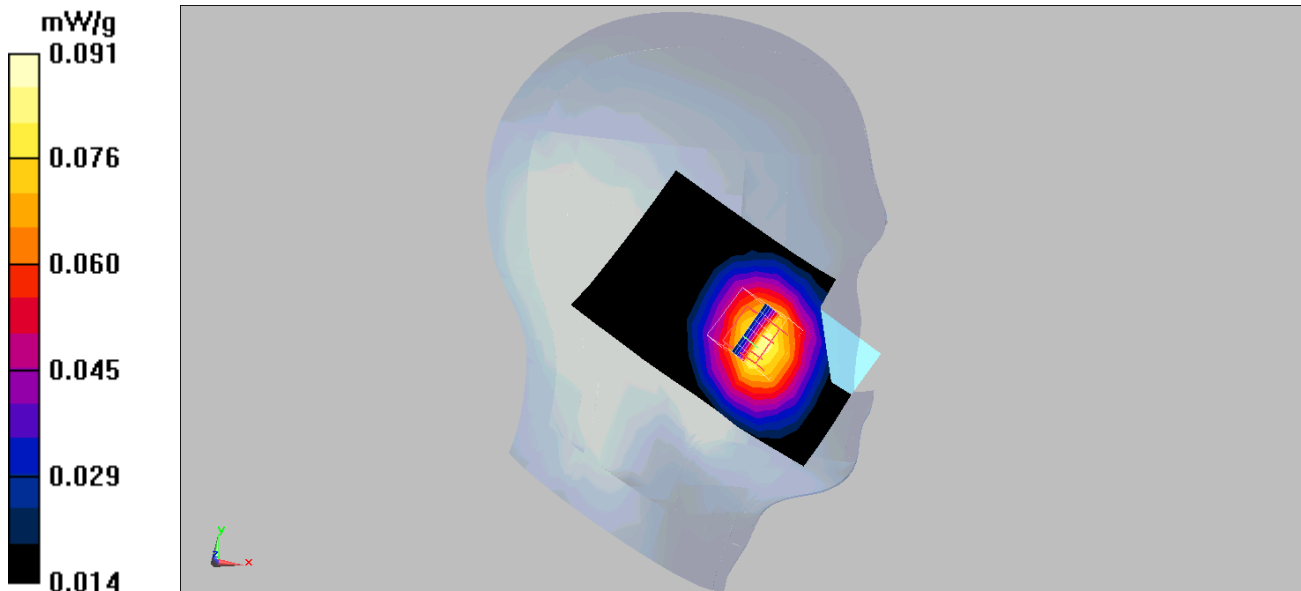

Date/Time: 12/21/2009

Test Laboratory: Quietek

**Band V\_Left-Cheek\_Channel-4233**

**DUT: Smart Handheld; Type: M900DF**

Communication System: FCC WCDMA\_Band-V; Frequency: 846.6 MHz; Duty Cycle: 1:1

Medium parameters used:  $f = 846.6 \text{ MHz}$ ;  $\sigma = 0.93 \text{ mho/m}$ ;  $\epsilon_r = 41.3$ ;  $\rho = 1000 \text{ kg/m}^3$

Phantom section: Left Section

Ambient Temperature ( $^{\circ}\text{C}$ ) : 20.9, Liquid Temperature ( $^{\circ}\text{C}$ ) : 20.1

DASY4 Configuration:

- Probe: EX3DV4 - SN3602; ConvF(9.14, 9.14, 9.14); Calibrated: 5/20/2009
- Sensor-Surface: 4mm (Mechanical Surface Detection)
- Electronics: DAE4 Sn1207; Calibrated: 4/7/2009
- Phantom: SAM Left Table; Type: SAM;
- Measurement SW: DASY5, V5.0 Build 125; SEMCAD X Version 13.4 Build 125

**Band V/Area Scan (7x11x1):** Measurement grid: dx=15mm, dy=15mm

Maximum value of SAR (measured) = 0.137 mW/g

**Band V/Zoom Scan (7x7x7) (7x7x7)/Cube 0:** Measurement grid: dx=5mm, dy=5mm, dz=5mm

Reference Value = 2.46 V/m; Power Drift = 0.088 dB

Peak SAR (extrapolated) = 0.155 W/kg

**SAR(1 g) = 0.129 mW/g; SAR(10 g) = 0.100 mW/g**

Maximum value of SAR (measured) = 0.135 mW/g

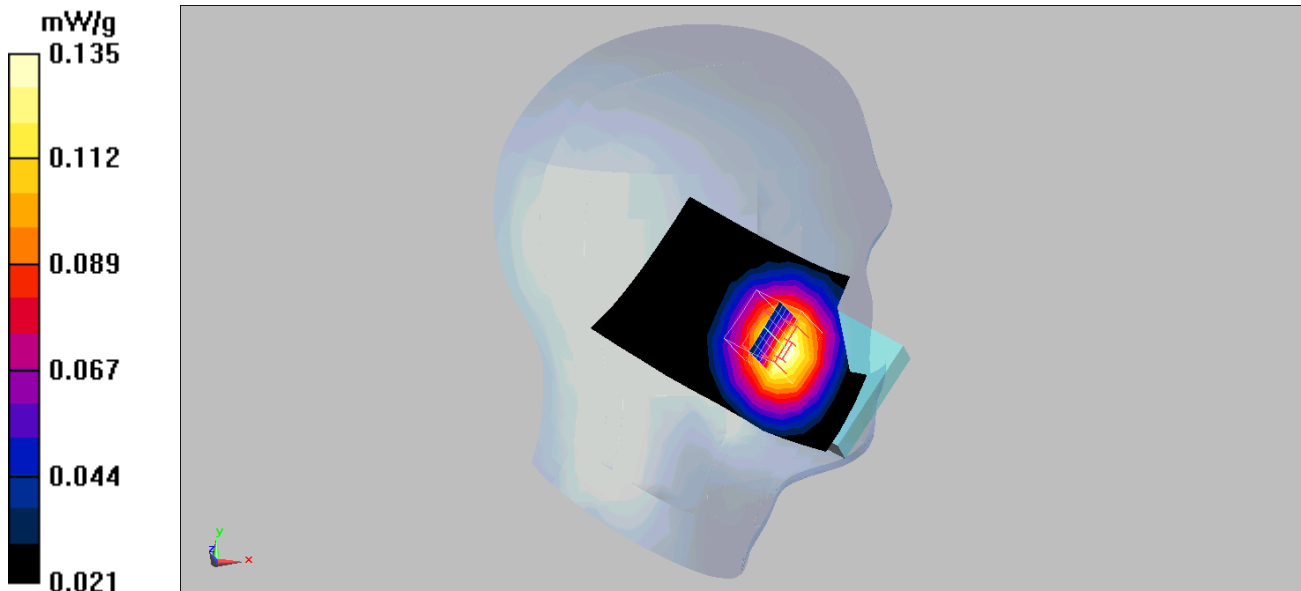

Date/Time: 12/21/2009

Test Laboratory: Quietek

### Band V\_Left-Tilt\_Channel-4132

**DUT: Smart Handheld; Type: M900DF**

Communication System: FCC WCDMA\_Band-V; Frequency: 826.4 MHz; Duty Cycle: 1:1

Medium parameters used:  $f = 826.4$  MHz;  $\sigma = 0.91$  mho/m;  $\epsilon_r = 42.3$ ;  $\rho = 1000$  kg/m<sup>3</sup>

Phantom section: Left Section

Ambient Temperature (°C) : 20.9, Liquid Temperature (°C) : 20.1

DASY4 Configuration:

- Probe: EX3DV4 - SN3602; ConvF(9.14, 9.14, 9.14); Calibrated: 5/20/2009
- Sensor-Surface: 4mm (Mechanical Surface Detection)
- Electronics: DAE4 Sn1207; Calibrated: 4/7/2009
- Phantom: SAM Left Table; Type: SAM;
- Measurement SW: DASY5, V5.0 Build 125; SEMCAD X Version 13.4 Build 125

**Band V/Area Scan (7x11x1):** Measurement grid: dx=15mm, dy=15mm

Maximum value of SAR (measured) = 0.165 mW/g

**Band V/Zoom Scan (7x7x7) (7x7x7)/Cube 0:** Measurement grid: dx=5mm, dy=5mm, dz=5mm

Reference Value = 3.84 V/m; Power Drift = 0.091 dB

Peak SAR (extrapolated) = 0.200 W/kg

**SAR(1 g) = 0.159 mW/g; SAR(10 g) = 0.120 mW/g**

Maximum value of SAR (measured) = 0.168 mW/g

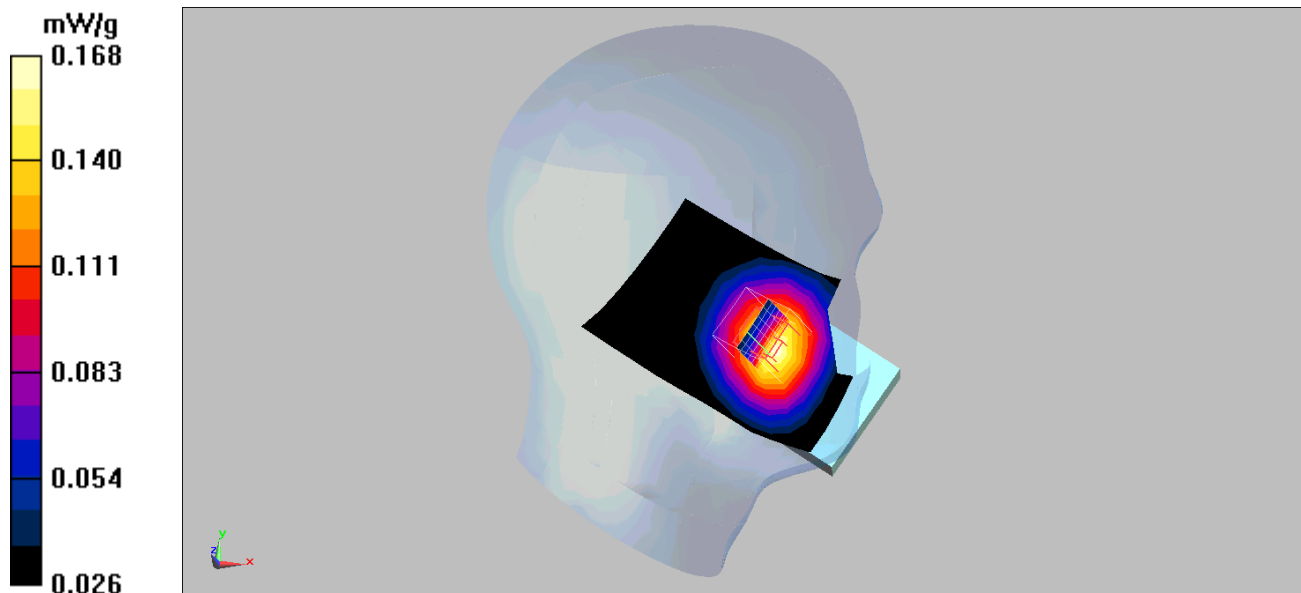

Date/Time: 12/21/2009

Test Laboratory: Quietek

**Band V\_Left-Tilt\_Channel-4183**

**DUT: Smart Handheld; Type: M900DF**

Communication System: FCC WCDMA\_Band-V; Frequency: 836.6 MHz; Duty Cycle: 1:1

Medium parameters used:  $f = 836.6 \text{ MHz}$ ;  $\sigma = 0.92 \text{ mho/m}$ ;  $\epsilon_r = 41.8$ ;  $\rho = 1000 \text{ kg/m}^3$

Phantom section: Left Section

Ambient Temperature ( $^{\circ}\text{C}$ ) : 20.9, Liquid Temperature ( $^{\circ}\text{C}$ ) : 20.1

DASY4 Configuration:

- Probe: EX3DV4 - SN3602; ConvF(9.14, 9.14, 9.14); Calibrated: 5/20/2009
- Sensor-Surface: 4mm (Mechanical Surface Detection)
- Electronics: DAE4 Sn1207; Calibrated: 4/7/2009
- Phantom: SAM Left Table; Type: SAM;
- Measurement SW: DASY5, V5.0 Build 125; SEMCAD X Version 13.4 Build 125

**Band V/Area Scan (7x11x1):** Measurement grid: dx=15mm, dy=15mm

Maximum value of SAR (measured) = 0.129 mW/g

**Band V/Zoom Scan (7x7x7) (7x7x7)/Cube 0:** Measurement grid: dx=5mm, dy=5mm, dz=5mm

Reference Value = 3.13 V/m; Power Drift = 0.126 dB

Peak SAR (extrapolated) = 0.151 W/kg

**SAR(1 g) = 0.123 mW/g; SAR(10 g) = 0.094 mW/g**

Maximum value of SAR (measured) = 0.130 mW/g

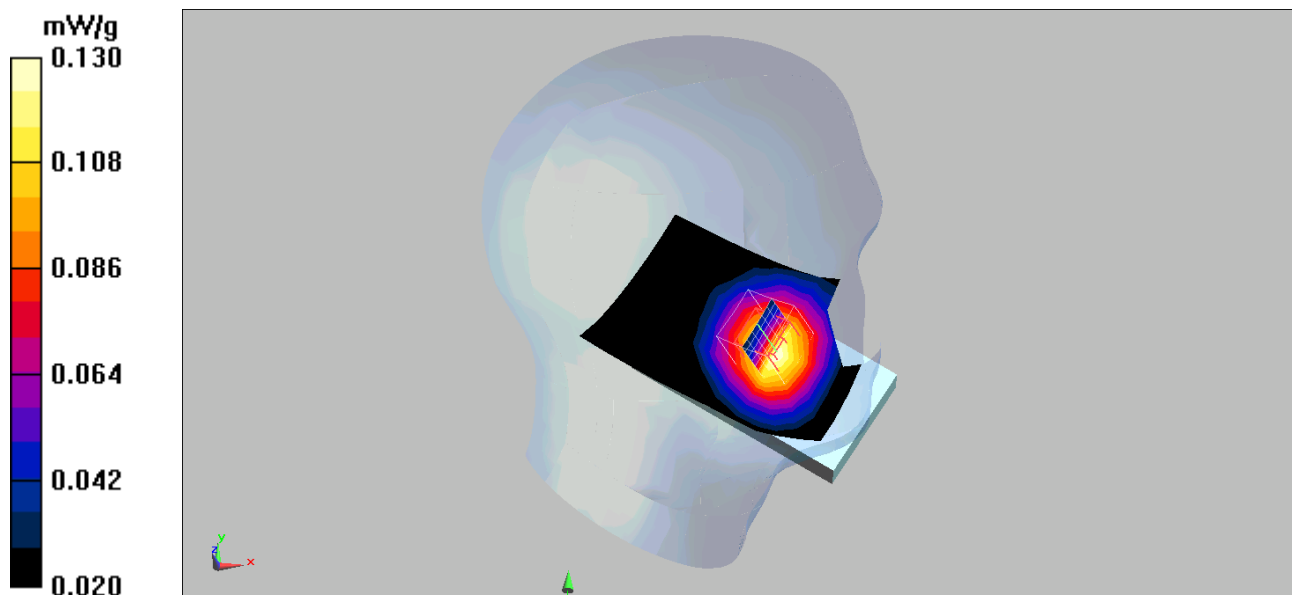



Date/Time: 12/21/2009

Test Laboratory: Quietek

**Band V\_Left-Tilt\_Channel-4233**

**DUT: Smart Handheld; Type: M900DF**

Communication System: FCC WCDMA\_Band-V; Frequency: 846.6 MHz; Duty Cycle: 1:1

Medium parameters used:  $f = 846.6 \text{ MHz}$ ;  $\sigma = 0.93 \text{ mho/m}$ ;  $\epsilon_r = 41.3$ ;  $\rho = 1000 \text{ kg/m}^3$

Phantom section: Left Section

Ambient Temperature ( $^{\circ}\text{C}$ ) : 20.9, Liquid Temperature ( $^{\circ}\text{C}$ ) : 20.1

DASY4 Configuration:

- Probe: EX3DV4 - SN3602; ConvF(9.14, 9.14, 9.14); Calibrated: 5/20/2009
- Sensor-Surface: 4mm (Mechanical Surface Detection)
- Electronics: DAE4 Sn1207; Calibrated: 4/7/2009
- Phantom: SAM Left Table; Type: SAM;
- Measurement SW: DASY5, V5.0 Build 125; SEMCAD X Version 13.4 Build 125

**Band V/Area Scan (7x11x1):** Measurement grid: dx=15mm, dy=15mm

Maximum value of SAR (measured) = 0.125 mW/g

**Band V/Zoom Scan (7x7x7) (7x7x7)/Cube 0:** Measurement grid: dx=5mm, dy=5mm, dz=5mm

Reference Value = 8.17 V/m; Power Drift = -0.083 dB

Peak SAR (extrapolated) = 0.146 W/kg

**SAR(1 g) = 0.114 mW/g; SAR(10 g) = 0.087 mW/g**

Maximum value of SAR (measured) = 0.119 mW/g

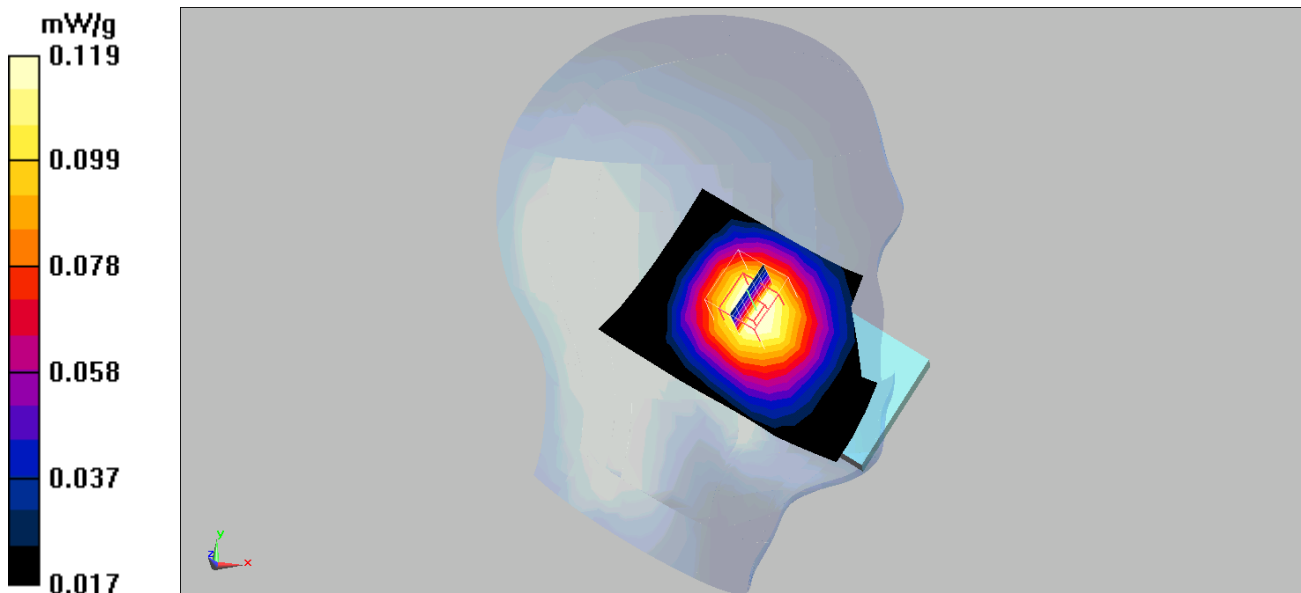

Date/Time: 12/21/2009

Test Laboratory: Quietek

**Band V\_Right-Cheek\_Channel-4132**

**DUT: Smart Handheld; Type: M900DF**

Communication System: FCC WCDMA\_Band-V; Frequency: 826.4 MHz; Duty Cycle: 1:1

Medium parameters used:  $f = 826.4 \text{ MHz}$ ;  $\sigma = 0.91 \text{ mho/m}$ ;  $\epsilon_r = 42.3$ ;  $\rho = 1000 \text{ kg/m}^3$

Phantom section: Right Section

Ambient Temperature ( $^{\circ}\text{C}$ ) : 20.9, Liquid Temperature ( $^{\circ}\text{C}$ ) : 20.1

DASY4 Configuration:

- Probe: EX3DV4 - SN3602; ConvF(9.14, 9.14, 9.14); Calibrated: 5/20/2009
- Sensor-Surface: 4mm (Mechanical Surface Detection)
- Electronics: DAE4 Sn1207; Calibrated: 4/7/2009
- Phantom: SAM Left Table; Type: SAM;
- Measurement SW: DASY5, V5.0 Build 125; SEMCAD X Version 13.4 Build 125

**Band V/Area Scan (7x11x1):** Measurement grid: dx=15mm, dy=15mm

Maximum value of SAR (measured) = 0.152 mW/g

**Band V/Zoom Scan (7x7x7) (7x7x7)/Cube 0:** Measurement grid: dx=5mm, dy=5mm, dz=5mm

Reference Value = 3.22 V/m; Power Drift = 0.102 dB

Peak SAR (extrapolated) = 0.184 W/kg

**SAR(1 g) = 0.150 mW/g; SAR(10 g) = 0.116 mW/g**

Maximum value of SAR (measured) = 0.157 mW/g

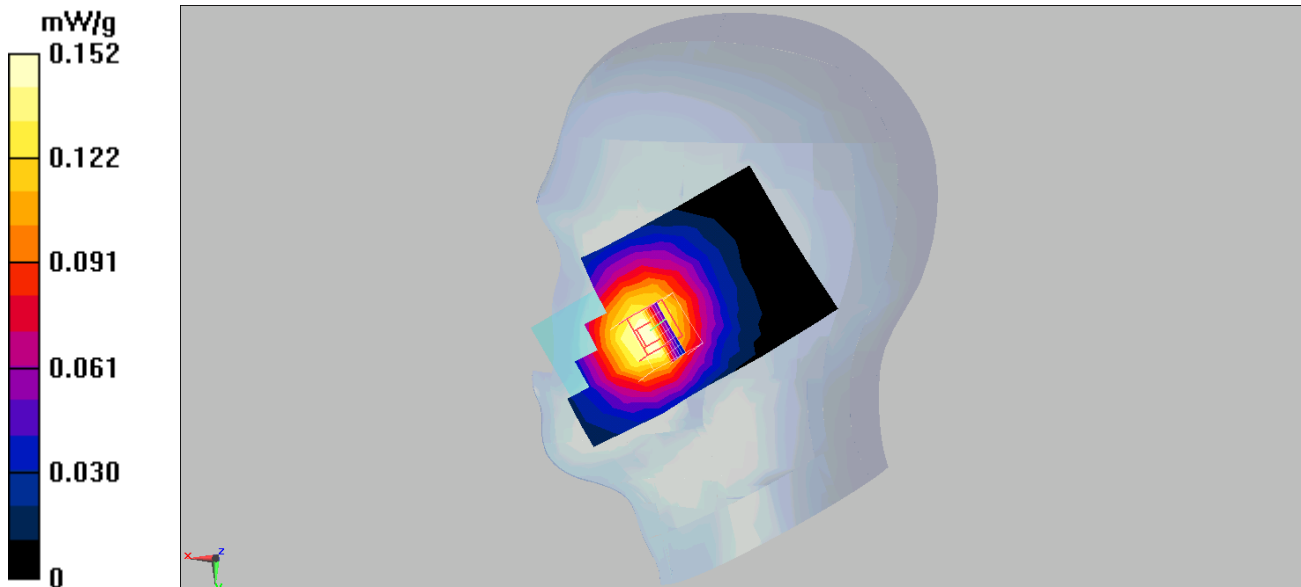

Date/Time: 12/21/2009

Test Laboratory: Quietek

**Band V\_Right-Cheek\_Channel-4183**

**DUT: Smart Handheld; Type: M900DF**

Communication System: FCC WCDMA\_Band-V; Frequency: 836.6 MHz; Duty Cycle: 1:1

Medium parameters used:  $f = 836.6 \text{ MHz}$ ;  $\sigma = 0.92 \text{ mho/m}$ ;  $\epsilon_r = 41.8$ ;  $\rho = 1000 \text{ kg/m}^3$

Phantom section: Right Section

Ambient Temperature ( $^{\circ}\text{C}$ ) : 20.9, Liquid Temperature ( $^{\circ}\text{C}$ ) : 20.1

DASY4 Configuration:

- Probe: EX3DV4 - SN3602; ConvF(9.14, 9.14, 9.14); Calibrated: 5/20/2009
- Sensor-Surface: 4mm (Mechanical Surface Detection)
- Electronics: DAE4 Sn1207; Calibrated: 4/7/2009
- Phantom: SAM Left Table; Type: SAM;
- Measurement SW: DASY5, V5.0 Build 125; SEMCAD X Version 13.4 Build 125

**Band V/Area Scan (7x11x1):** Measurement grid: dx=15mm, dy=15mm

Maximum value of SAR (measured) = 0.114 mW/g

**Band V/Zoom Scan (7x7x7) (7x7x7)/Cube 0:** Measurement grid: dx=5mm, dy=5mm, dz=5mm

Reference Value = 3.37 V/m; Power Drift = 0.089 dB

Peak SAR (extrapolated) = 0.135 W/kg

**SAR(1 g) = 0.112 mW/g; SAR(10 g) = 0.087 mW/g**

Maximum value of SAR (measured) = 0.117 mW/g

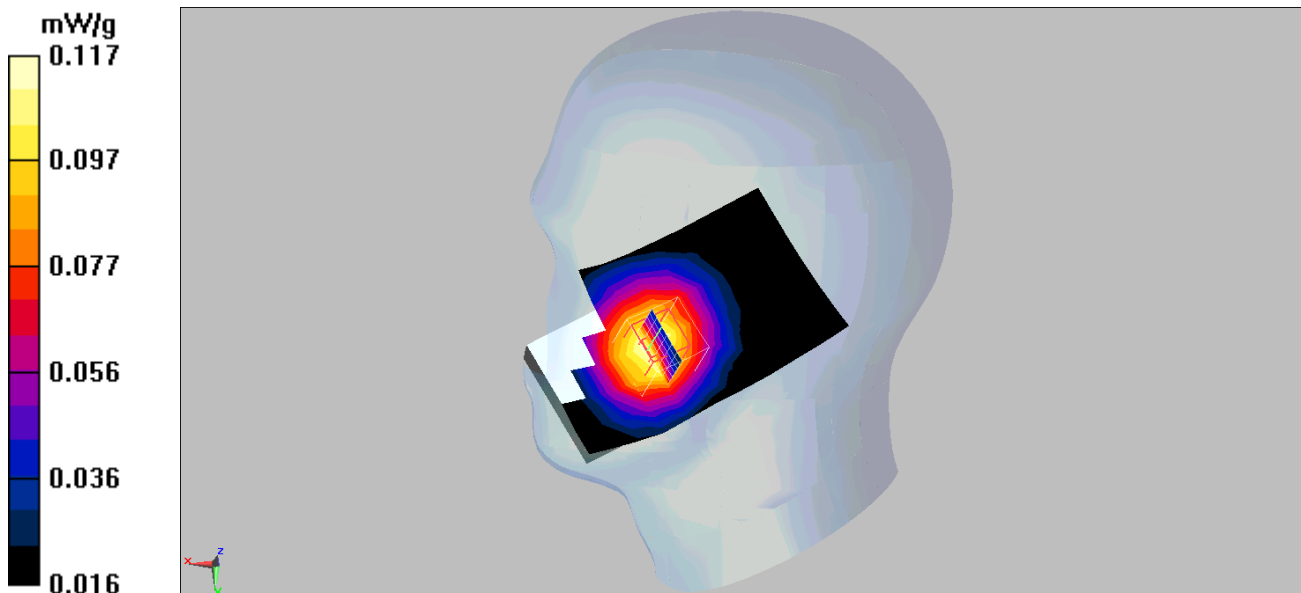

Date/Time: 12/21/2009

Test Laboratory: Quietek

**Band V\_Right-Cheek\_Channel-4233**

**DUT: Smart Handheld; Type: M900DF**

Communication System: FCC WCDMA\_Band-V; Frequency: 846.6 MHz; Duty Cycle: 1:1

Medium parameters used:  $f = 846.6 \text{ MHz}$ ;  $\sigma = 0.93 \text{ mho/m}$ ;  $\epsilon_r = 41.3$ ;  $\rho = 1000 \text{ kg/m}^3$

Phantom section: Right Section

Ambient Temperature ( $^{\circ}\text{C}$ ) : 20.9, Liquid Temperature ( $^{\circ}\text{C}$ ) : 20.1

DASY4 Configuration:

- Probe: EX3DV4 - SN3602; ConvF(9.14, 9.14, 9.14); Calibrated: 5/20/2009
- Sensor-Surface: 4mm (Mechanical Surface Detection)
- Electronics: DAE4 Sn1207; Calibrated: 4/7/2009
- Phantom: SAM Left Table; Type: SAM;
- Measurement SW: DASY5, V5.0 Build 125; SEMCAD X Version 13.4 Build 125

**Band V/Area Scan (7x11x1):** Measurement grid: dx=15mm, dy=15mm

Maximum value of SAR (measured) = 0.138 mW/g

**Band V/Zoom Scan (7x7x7) (7x7x7)/Cube 0:** Measurement grid: dx=5mm, dy=5mm, dz=5mm

Reference Value = 3.45 V/m; Power Drift = 0.135 dB

Peak SAR (extrapolated) = 0.167 W/kg

**SAR(1 g) = 0.136 mW/g; SAR(10 g) = 0.106 mW/g**

Maximum value of SAR (measured) = 0.143 mW/g

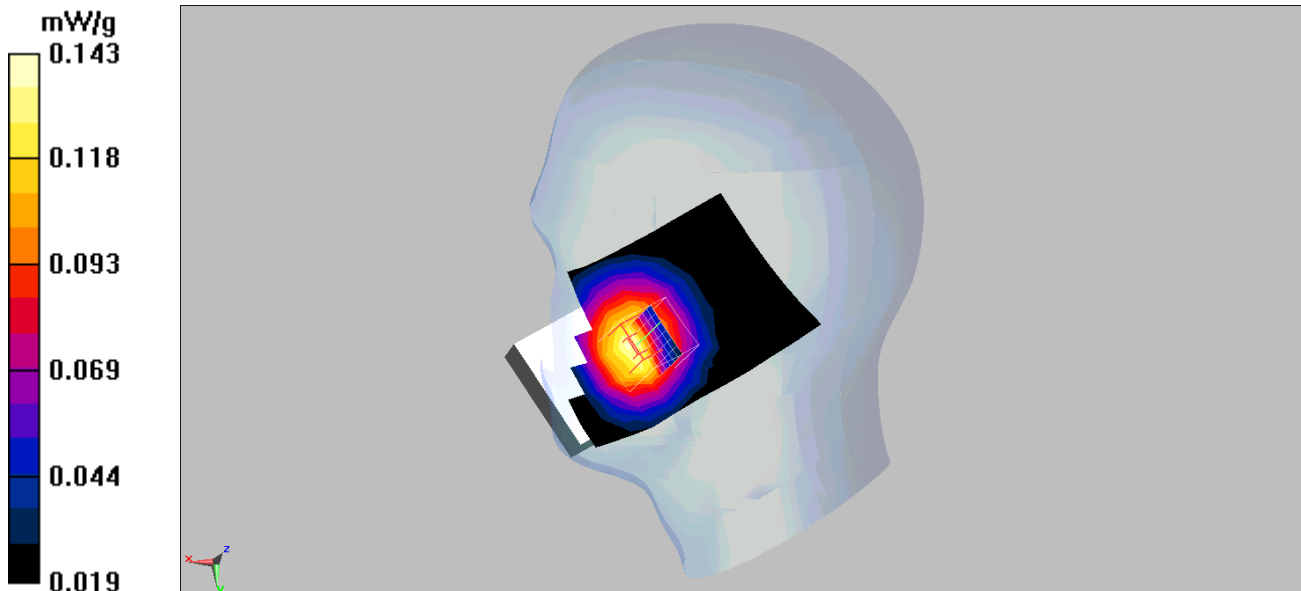

Date/Time: 12/21/2009

Test Laboratory: Quietek

**Band V\_Right-Tilt\_Channel-4132**

**DUT: Smart Handheld; Type: M900DF**

Communication System: FCC WCDMA\_Band-V; Frequency: 826.4 MHz; Duty Cycle: 1:1

Medium parameters used:  $f = 826.4 \text{ MHz}$ ;  $\sigma = 0.91 \text{ mho/m}$ ;  $\epsilon_r = 42.3$ ;  $\rho = 1000 \text{ kg/m}^3$

Phantom section: Right Section

Ambient Temperature ( $^{\circ}\text{C}$ ) : 20.9, Liquid Temperature ( $^{\circ}\text{C}$ ) : 20.1

DASY4 Configuration:

- Probe: EX3DV4 - SN3602; ConvF(9.14, 9.14, 9.14); Calibrated: 5/20/2009
- Sensor-Surface: 4mm (Mechanical Surface Detection)
- Electronics: DAE4 Sn1207; Calibrated: 4/7/2009
- Phantom: SAM Left Table; Type: SAM;
- Measurement SW: DASY5, V5.0 Build 125; SEMCAD X Version 13.4 Build 125

**Band V/Area Scan (7x11x1):** Measurement grid: dx=15mm, dy=15mm

Maximum value of SAR (measured) = 0.131 mW/g

**Band V/Zoom Scan (7x7x7) (7x7x7)/Cube 0:** Measurement grid: dx=5mm, dy=5mm, dz=5mm

Reference Value = 6.65 V/m; Power Drift = -0.116 dB

Peak SAR (extrapolated) = 0.382 W/kg

**SAR(1 g) = 0.137 mW/g; SAR(10 g) = 0.081 mW/g**

Maximum value of SAR (measured) = 0.135 mW/g

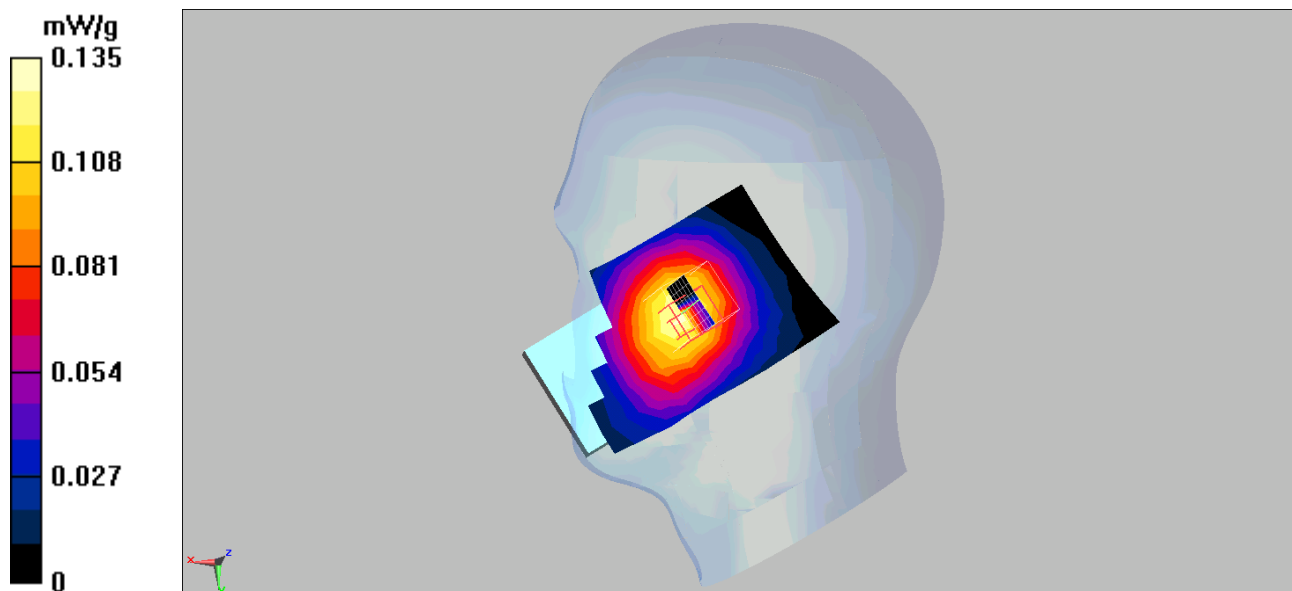

Date/Time: 12/22/2009

Test Laboratory: Quietek

**Band V\_Right-Tilt\_Channel-4183**

**DUT: Smart Handheld; Type: M900DF**

Communication System: FCC WCDMA\_Band-V; Frequency: 836.6 MHz; Duty Cycle: 1:1

Medium parameters used:  $f = 836.6 \text{ MHz}$ ;  $\sigma = 0.92 \text{ mho/m}$ ;  $\epsilon_r = 41.8$ ;  $\rho = 1000 \text{ kg/m}^3$

Phantom section: Right Section

Ambient Temperature ( $^{\circ}\text{C}$ ) : 20.9, Liquid Temperature ( $^{\circ}\text{C}$ ) : 20.1

DASY4 Configuration:

- Probe: EX3DV4 - SN3602; ConvF(9.14, 9.14, 9.14); Calibrated: 5/20/2009
- Sensor-Surface: 4mm (Mechanical Surface Detection)
- Electronics: DAE4 Sn1207; Calibrated: 4/7/2009
- Phantom: SAM Left Table; Type: SAM;
- Measurement SW: DASY5, V5.0 Build 125; SEMCAD X Version 13.4 Build 125

**Band V/Area Scan (7x11x1):** Measurement grid: dx=15mm, dy=15mm

Maximum value of SAR (measured) = 0.102 mW/g

**Band V/Zoom Scan (7x7x7) (7x7x7)/Cube 0:** Measurement grid: dx=5mm, dy=5mm, dz=5mm

Reference Value = 5.31 V/m; Power Drift = 0.00943 dB

Peak SAR (extrapolated) = 0.117 W/kg

**SAR(1 g) = 0.097 mW/g; SAR(10 g) = 0.075 mW/g**

Maximum value of SAR (measured) = 0.101 mW/g

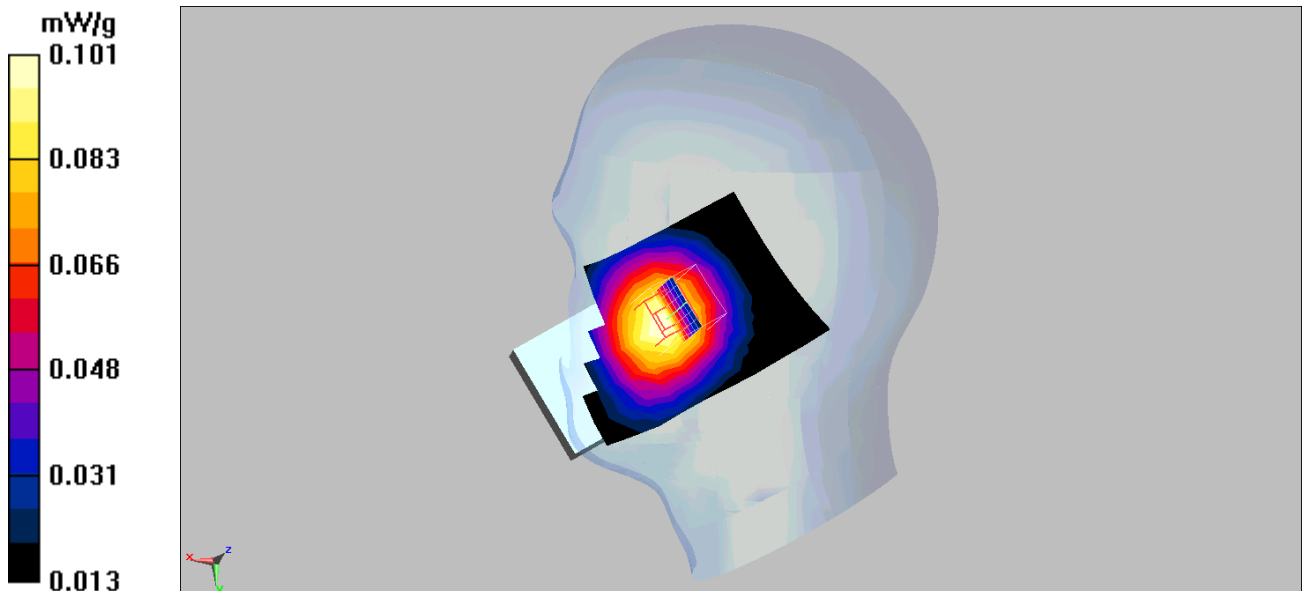

Date/Time: 12/21/2009

Test Laboratory: Quietek

**Band V\_Right-Tilt\_Channel-4233**

**DUT: Smart Handheld; Type: M900DF**

Communication System: FCC WCDMA\_Band-V; Frequency: 846.6 MHz; Duty Cycle: 1:1

Medium parameters used:  $f = 846.6 \text{ MHz}$ ;  $\sigma = 0.93 \text{ mho/m}$ ;  $\epsilon_r = 41.3$ ;  $\rho = 1000 \text{ kg/m}^3$

Phantom section: Right Section

Ambient Temperature ( $^{\circ}\text{C}$ ) : 20.9, Liquid Temperature ( $^{\circ}\text{C}$ ) : 20.1

DASY4 Configuration:

- Probe: EX3DV4 - SN3602; ConvF(9.14, 9.14, 9.14); Calibrated: 5/20/2009
- Sensor-Surface: 4mm (Mechanical Surface Detection)
- Electronics: DAE4 Sn1207; Calibrated: 4/7/2009
- Phantom: SAM Left Table; Type: SAM;
- Measurement SW: DASY5, V5.0 Build 125; SEMCAD X Version 13.4 Build 125

**Band V/Area Scan (7x11x1):** Measurement grid: dx=15mm, dy=15mm

Maximum value of SAR (measured) = 0.124 mW/g

**Band V/Zoom Scan (7x7x7) (7x7x7)/Cube 0:** Measurement grid: dx=5mm, dy=5mm, dz=5mm

Reference Value = 5.64 V/m; Power Drift = 0.147 dB

Peak SAR (extrapolated) = 0.145 W/kg

**SAR(1 g) = 0.118 mW/g; SAR(10 g) = 0.091 mW/g**

Maximum value of SAR (measured) = 0.101 mW/g

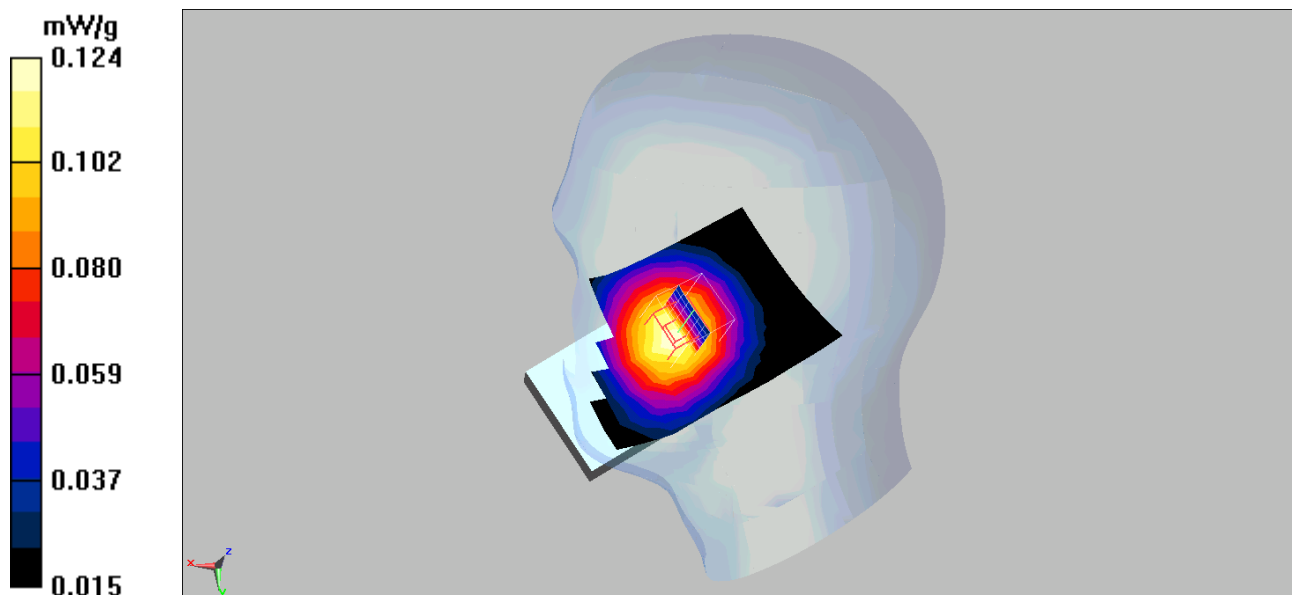

Date/Time: 12/21/2009

Test Laboratory: Quietek

**Band V\_Body\_Channel-4132**

**DUT: Smart Handheld; Type: M900DF**

Communication System: FCC WCDMA\_Band-V; Frequency: 826.4 MHz; Duty Cycle: 1:1

Medium parameters used:  $f = 826.4 \text{ MHz}$ ;  $\sigma = 0.95 \text{ mho/m}$ ;  $\epsilon_r = 54.6$ ;  $\rho = 1000 \text{ kg/m}^3$

Phantom section: Flat Section

Ambient Temperature ( $^{\circ}\text{C}$ ) : 20.9, Liquid Temperature ( $^{\circ}\text{C}$ ) : 20.1

DASY4 Configuration:

- Probe: EX3DV4 - SN3602; ConvF(9.32, 9.32, 9.32); Calibrated: 5/20/2009
- Sensor-Surface: 4mm (Mechanical Surface Detection)
- Electronics: DAE4 Sn1207; Calibrated: 4/7/2009
- Phantom: SAM Left Table; Type: SAM;
- Measurement SW: DASY5, V5.0 Build 125; SEMCAD X Version 13.4 Build 125

**Band V/Area Scan (7x11x1):** Measurement grid: dx=15mm, dy=15mm

Maximum value of SAR (measured) = 0.291 mW/g

**Band V/Zoom Scan (7x7x7) (7x7x7)/Cube 0:** Measurement grid: dx=5mm, dy=5mm, dz=5mm

Reference Value = 7.32 V/m; Power Drift = 0.188 dB

Peak SAR (extrapolated) = 0.382 W/kg

**SAR(1 g) = 0.291 mW/g; SAR(10 g) = 0.217 mW/g**

Maximum value of SAR (measured) = 0.305 mW/g

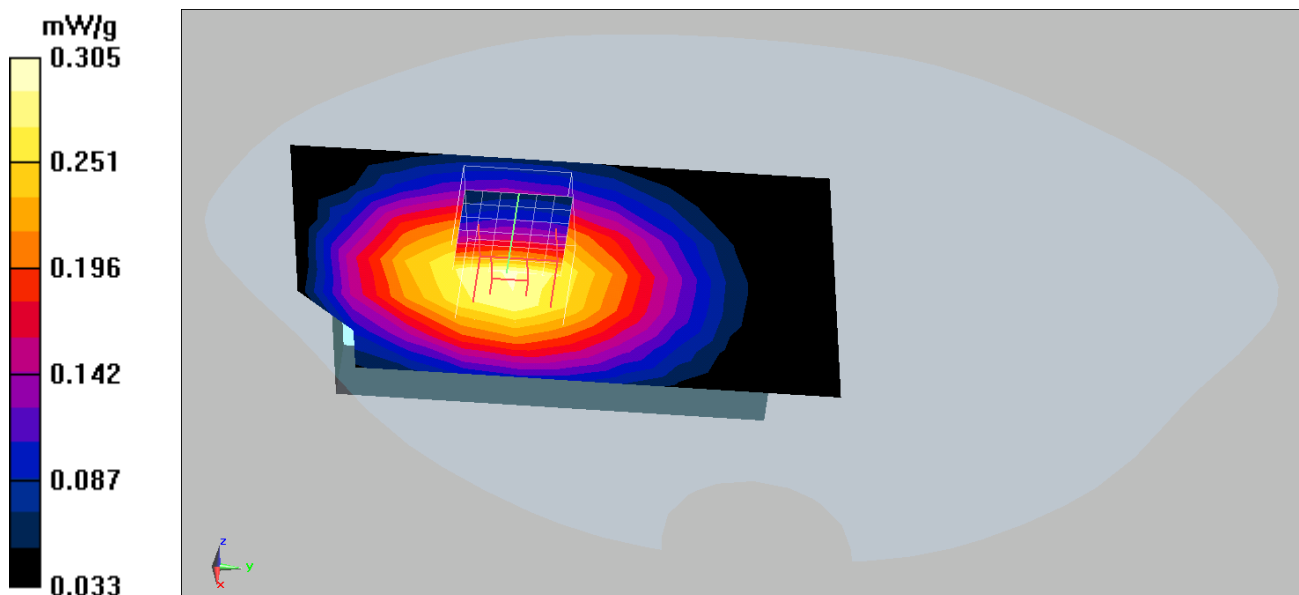



Date/Time: 12/21/2009

Test Laboratory: Quietek

**Band V\_Body\_Channel-4183**

**DUT: Smart Handheld; Type: M900DF**

Communication System: FCC WCDMA\_Band-V; Frequency: 836.6 MHz; Duty Cycle: 1:1

Medium parameters used:  $f = 836.6 \text{ MHz}$ ;  $\sigma = 0.97 \text{ mho/m}$ ;  $\epsilon_r = 54.2$ ;  $\rho = 1000 \text{ kg/m}^3$

Phantom section: Flat Section

Ambient Temperature ( $^{\circ}\text{C}$ ) : 20.9, Liquid Temperature ( $^{\circ}\text{C}$ ) : 20.1

DASY4 Configuration:

- Probe: EX3DV4 - SN3602; ConvF(9.32, 9.32, 9.32); Calibrated: 5/20/2009
- Sensor-Surface: 4mm (Mechanical Surface Detection)
- Electronics: DAE4 Sn1207; Calibrated: 4/7/2009
- Phantom: SAM Left Table; Type: SAM;
- Measurement SW: DASY5, V5.0 Build 125; SEMCAD X Version 13.4 Build 125

**Band V/Area Scan (7x11x1):** Measurement grid: dx=15mm, dy=15mm

Maximum value of SAR (measured) = 0.246 mW/g

**Band V/Zoom Scan (7x7x7) (7x7x7)/Cube 0:** Measurement grid: dx=5mm, dy=5mm, dz=5mm

Reference Value = 7.46 V/m; Power Drift = -0.122 dB

Peak SAR (extrapolated) = 0.309 W/kg

**SAR(1 g) = 0.236 mW/g; SAR(10 g) = 0.176 mW/g**

Maximum value of SAR (measured) = 0.247 mW/g

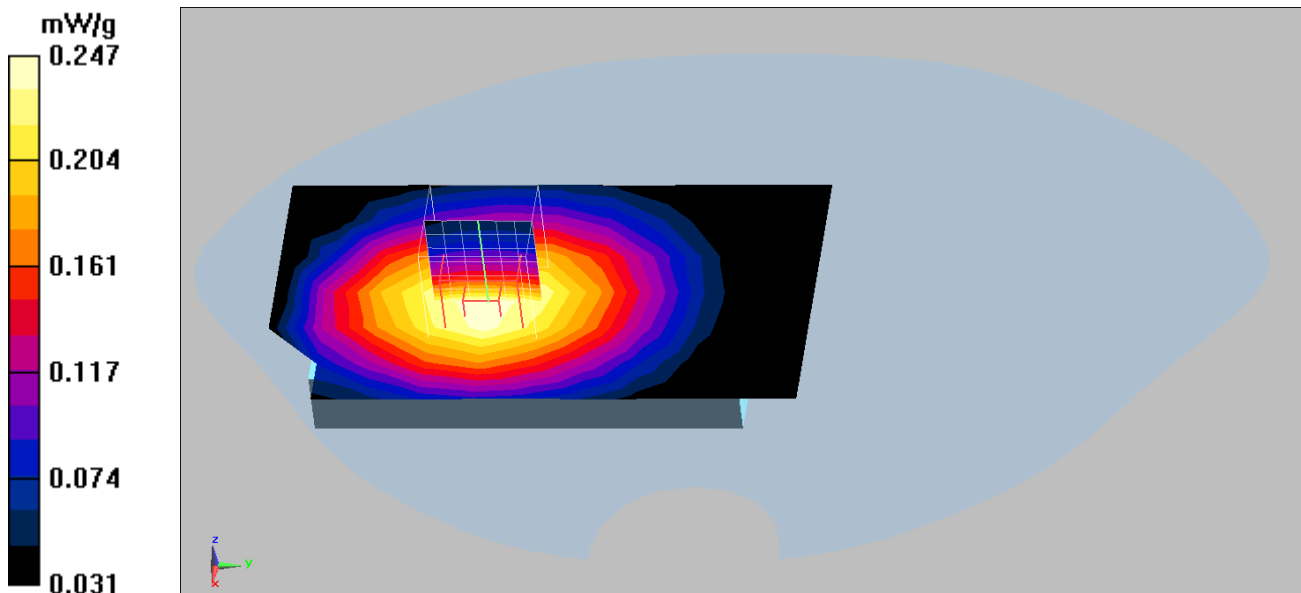

Date/Time: 12/21/2009

Test Laboratory: Quietek

**Band V\_Body\_Channel-4233**

**DUT: Smart Handheld; Type: M900DF**

Communication System: FCC WCDMA\_Band-V; Frequency: 846.6 MHz; Duty Cycle: 1:1

Medium parameters used:  $f = 846.6 \text{ MHz}$ ;  $\sigma = 0.99 \text{ mho/m}$ ;  $\epsilon_r = 53.9$ ;  $\rho = 1000 \text{ kg/m}^3$

Phantom section: Flat Section

Ambient Temperature ( $^{\circ}\text{C}$ ) : 20.9, Liquid Temperature ( $^{\circ}\text{C}$ ) : 20.1

DASY4 Configuration:

- Probe: EX3DV4 - SN3602; ConvF(9.32, 9.32, 9.32); Calibrated: 5/20/2009
- Sensor-Surface: 4mm (Mechanical Surface Detection)
- Electronics: DAE4 Sn1207; Calibrated: 4/7/2009
- Phantom: SAM Left Table; Type: SAM;
- Measurement SW: DASY5, V5.0 Build 125; SEMCAD X Version 13.4 Build 125

**Band V/Area Scan (7x11x1):** Measurement grid: dx=15mm, dy=15mm

Maximum value of SAR (measured) = 0.315 mW/g

**Band V/Zoom Scan (7x7x7) (7x7x7)/Cube 0:** Measurement grid: dx=5mm, dy=5mm, dz=5mm

Reference Value = 7.77 V/m; Power Drift = -0.054 dB

Peak SAR (extrapolated) = 0.387 W/kg

**SAR(1 g) = 0.297 mW/g; SAR(10 g) = 0.220 mW/g**

Maximum value of SAR (measured) = 0.311 mW/g

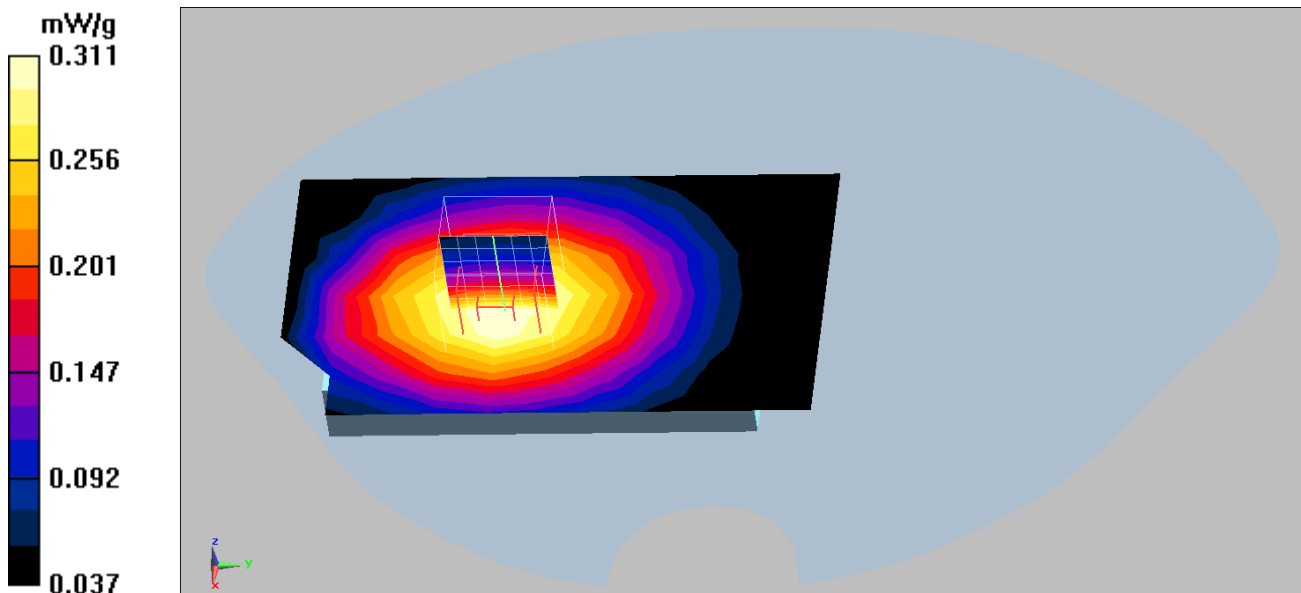

Date/Time: 12/21/2009

Test Laboratory: Quietek

**Band V\_Body\_Channel-4233 HSDPA**

**DUT: Smart Handheld; Type: M900DF**

Communication System: FCC WCDMA\_Band-V; Frequency: 846.6 MHz; Duty Cycle: 1:1

Medium parameters used:  $f = 846.6 \text{ MHz}$ ;  $\sigma = 0.99 \text{ mho/m}$ ;  $\epsilon_r = 53.9$ ;  $\rho = 1000 \text{ kg/m}^3$

Phantom section: Flat Section

Ambient Temperature ( $^{\circ}\text{C}$ ) : 20.9, Liquid Temperature ( $^{\circ}\text{C}$ ) : 20.1

DASY4 Configuration:

- Probe: EX3DV4 - SN3602; ConvF(9.32, 9.32, 9.32); Calibrated: 5/20/2009
- Sensor-Surface: 4mm (Mechanical Surface Detection)
- Electronics: DAE4 Sn1207; Calibrated: 4/7/2009
- Phantom: SAM Left Table; Type: SAM;
- Measurement SW: DASY5, V5.0 Build 125; SEMCAD X Version 13.4 Build 125

**Band V/Area Scan (7x11x1):** Measurement grid: dx=15mm, dy=15mm

Maximum value of SAR (measured) = 0.294 mW/g

**Band V/Zoom Scan (7x7x7) (7x7x7)/Cube 0:** Measurement grid: dx=5mm, dy=5mm, dz=5mm

Reference Value = 7.1 V/m; Power Drift = -0.045 dB

Peak SAR (extrapolated) = 0.376 W/kg

**SAR(1 g) = 0.239 mW/g; SAR(10 g) = 0.204 mW/g**

Maximum value of SAR (measured) = 0.304 mW/g

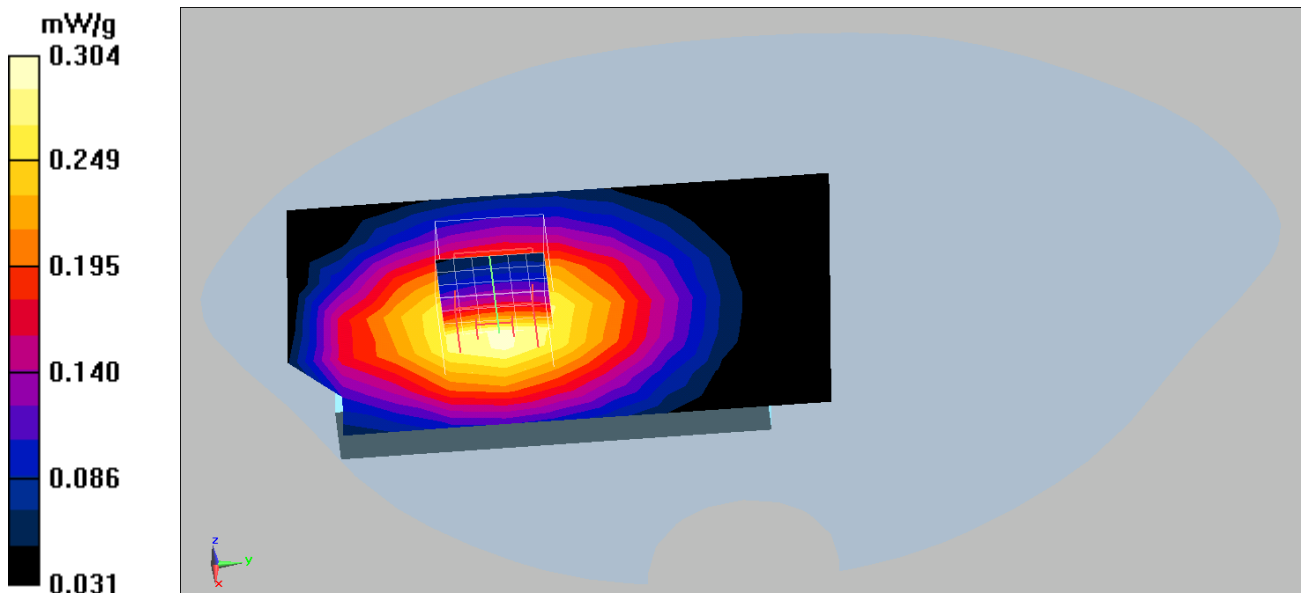

Date/Time: 12/21/2009

Test Laboratory: Quietek

**Band V\_Body\_Channel-4233 HSUPA**

**DUT: Smart Handheld; Type: M900DF**

Communication System: FCC WCDMA\_Band-V; Frequency: 846.6 MHz; Duty Cycle: 1:1

Medium parameters used:  $f = 846.6 \text{ MHz}$ ;  $\sigma = 0.99 \text{ mho/m}$ ;  $\epsilon_r = 53.9$ ;  $\rho = 1000 \text{ kg/m}^3$

Phantom section: Flat Section

Ambient Temperature ( $^{\circ}\text{C}$ ) : 20.9, Liquid Temperature ( $^{\circ}\text{C}$ ) : 20.1

DASY4 Configuration:

- Probe: EX3DV4 - SN3602; ConvF(9.32, 9.32, 9.32); Calibrated: 5/20/2009
- Sensor-Surface: 4mm (Mechanical Surface Detection)
- Electronics: DAE4 Sn1207; Calibrated: 4/7/2009
- Phantom: SAM Left Table; Type: SAM;
- Measurement SW: DASY5, V5.0 Build 125; SEMCAD X Version 13.4 Build 125

**Band V/Area Scan (7x11x1):** Measurement grid: dx=15mm, dy=15mm

Maximum value of SAR (measured) = 0.282 mW/g

**Band V/Zoom Scan (7x7x7) (7x7x7)/Cube 0:** Measurement grid: dx=5mm, dy=5mm, dz=5mm

Reference Value = 7.52 V/m; Power Drift = 0.145 dB

Peak SAR (extrapolated) = 0.353 W/kg

**SAR(1 g) = 0.249 mW/g; SAR(10 g) = 0.199 mW/g**

Maximum value of SAR (measured) = 0.284 mW/g

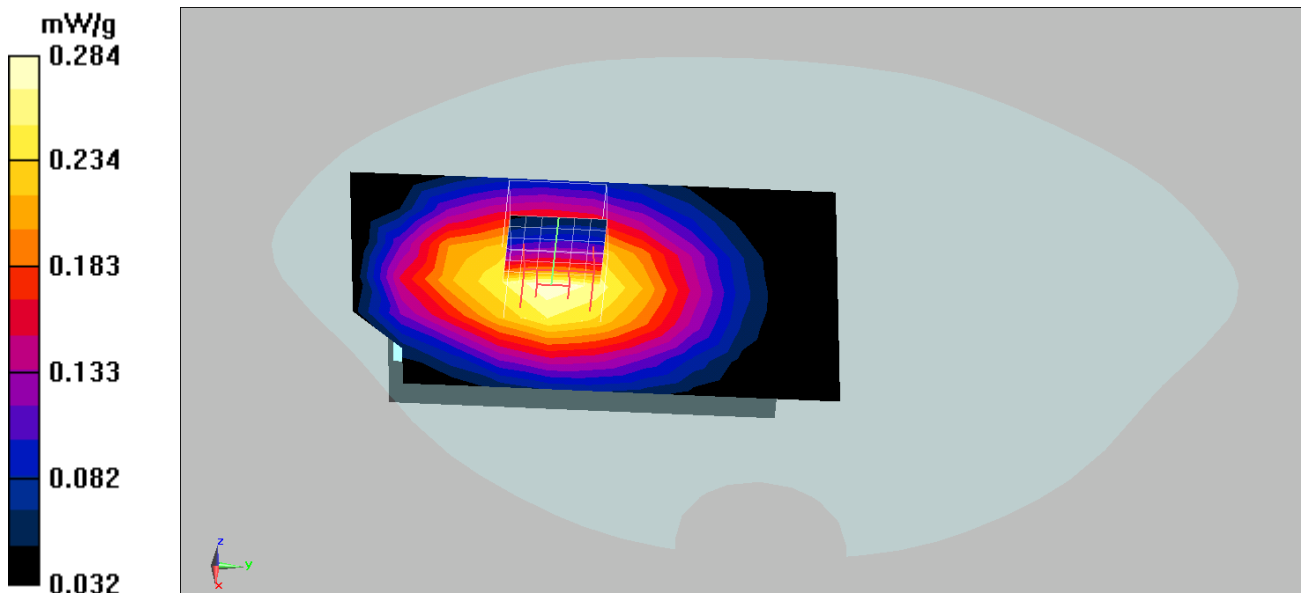

WCDMA Band V EUT Body-worn Z-Axis Plot  
Channel: 4233

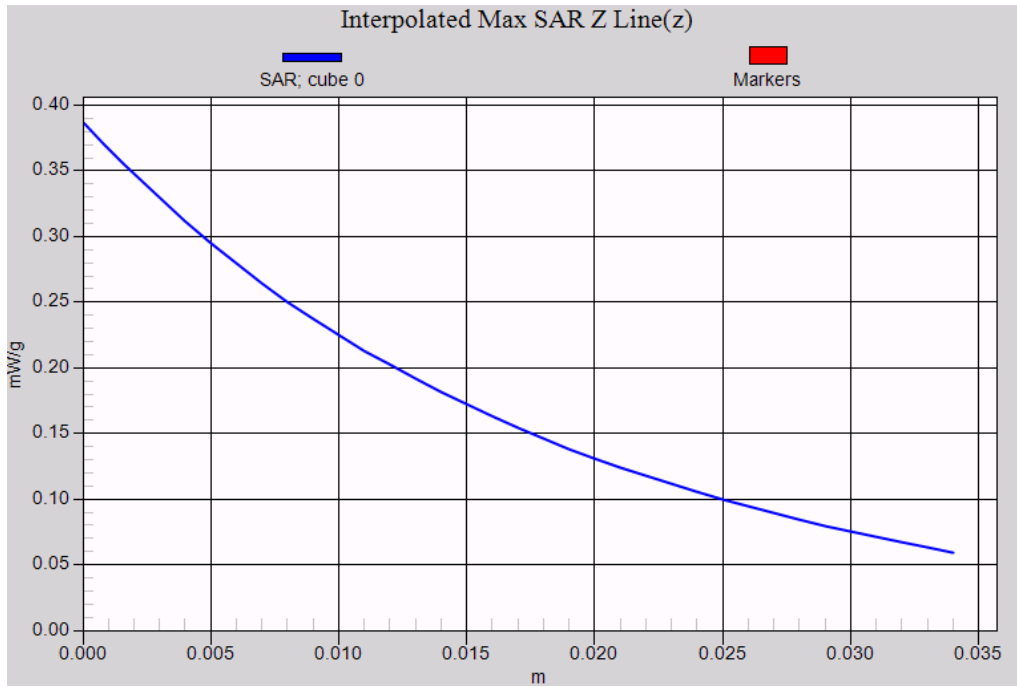

Date/Time: 12/22/2009

Test Laboratory: Quietek

**Band II\_Left-Cheek\_Channel-9262**

**DUT: Smart Handheld; Type: M900DF**

Communication System: FCC WCDMA\_Band-II; Frequency: 1852.4 MHz; Duty Cycle: 1:1

Medium parameters used:  $f = 1852.4 \text{ MHz}$ ;  $\sigma = 1.37 \text{ mho/m}$ ;  $\epsilon_r = 39.3$ ;  $\rho = 1000 \text{ kg/m}^3$

Phantom section: Left Section

Ambient Temperature ( $^{\circ}\text{C}$ ) : 20.8, Liquid Temperature ( $^{\circ}\text{C}$ ) : 20.1

DASY4 Configuration:

- Probe: EX3DV4 - SN3602; ConvF(7.81, 7.81, 7.81); Calibrated: 5/20/2009
- Sensor-Surface: 4mm (Mechanical Surface Detection)
- Electronics: DAE4 Sn1207; Calibrated: 4/7/2009
- Phantom: SAM Left Table; Type: SAM;
- Measurement SW: DASY5, V5.0 Build 125; SEMCAD X Version 13.4 Build 125

**Band II/Area Scan (7x11x1):** Measurement grid: dx=15mm, dy=15mm

Maximum value of SAR (measured) = 0.300 mW/g

**Band II/Zoom Scan (7x7x7) (7x7x7)/Cube 0:** Measurement grid: dx=5mm, dy=5mm, dz=5mm

Reference Value = 7.5 V/m; Power Drift = 0.101 dB

Peak SAR (extrapolated) = 0.384 W/kg

**SAR(1 g) = 0.277 mW/g; SAR(10 g) = 0.179 mW/g**

Maximum value of SAR (measured) = 0.298 mW/g

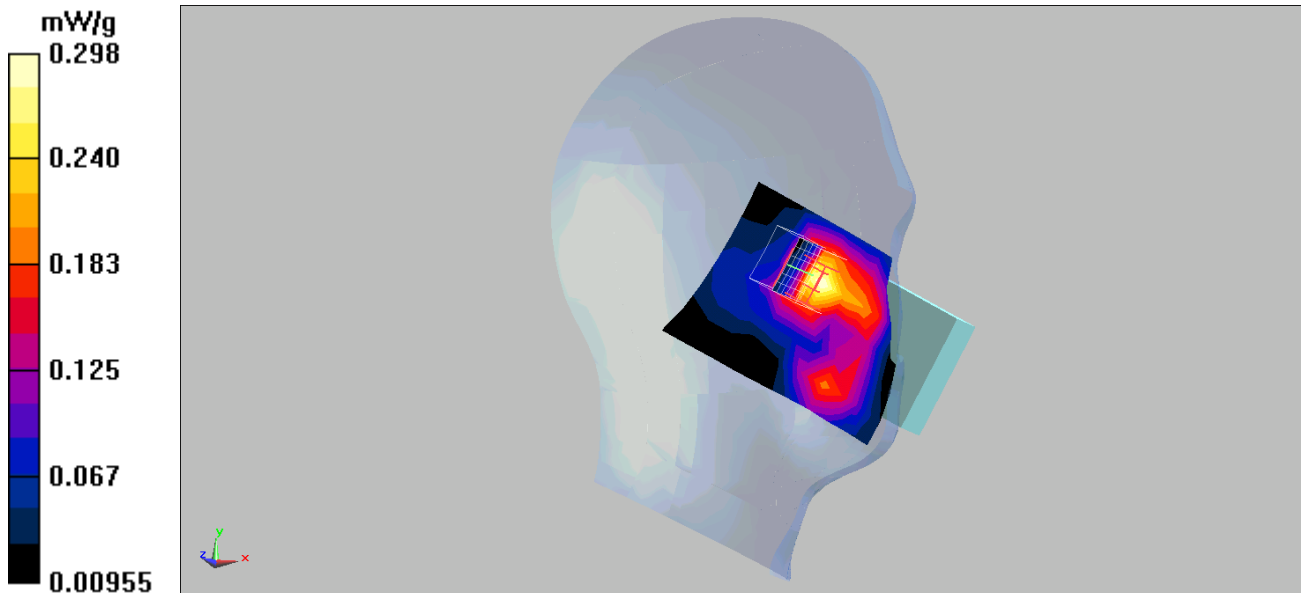

Date/Time: 12/22/2009

Test Laboratory: Quietek

**Band II\_Left-Cheek\_Channel-9400**

**DUT: Smart Handheld; Type: M900DF**

Communication System: FCC WCDMA\_Band-II; Frequency: 1880 MHz; Duty Cycle: 1:1

Medium parameters used:  $f = 1880 \text{ MHz}$ ;  $\sigma = 1.38 \text{ mho/m}$ ;  $\epsilon_r = 39.5$ ;  $\rho = 1000 \text{ kg/m}^3$

Phantom section: Left Section

Ambient Temperature ( $^{\circ}\text{C}$ ) : 20.8, Liquid Temperature ( $^{\circ}\text{C}$ ) : 20.1

DASY4 Configuration:

- Probe: EX3DV4 - SN3602; ConvF(7.81, 7.81, 7.81); Calibrated: 5/20/2009
- Sensor-Surface: 4mm (Mechanical Surface Detection)
- Electronics: DAE4 Sn1207; Calibrated: 4/7/2009
- Phantom: SAM Left Table; Type: SAM;
- Measurement SW: DASY5, V5.0 Build 125; SEMCAD X Version 13.4 Build 125

**Band II/Area Scan (7x11x1):** Measurement grid: dx=15mm, dy=15mm

Maximum value of SAR (measured) = 0.254 mW/g

**Band II/Zoom Scan (7x7x7) (7x7x7)/Cube 0:** Measurement grid: dx=5mm, dy=5mm, dz=5mm

Reference Value = 6.82 V/m; Power Drift = 0.025 dB

Peak SAR (extrapolated) = 0.346 W/kg

**SAR(1 g) = 0.243 mW/g; SAR(10 g) = 0.156 mW/g**

Maximum value of SAR (measured) = 0.261 mW/g

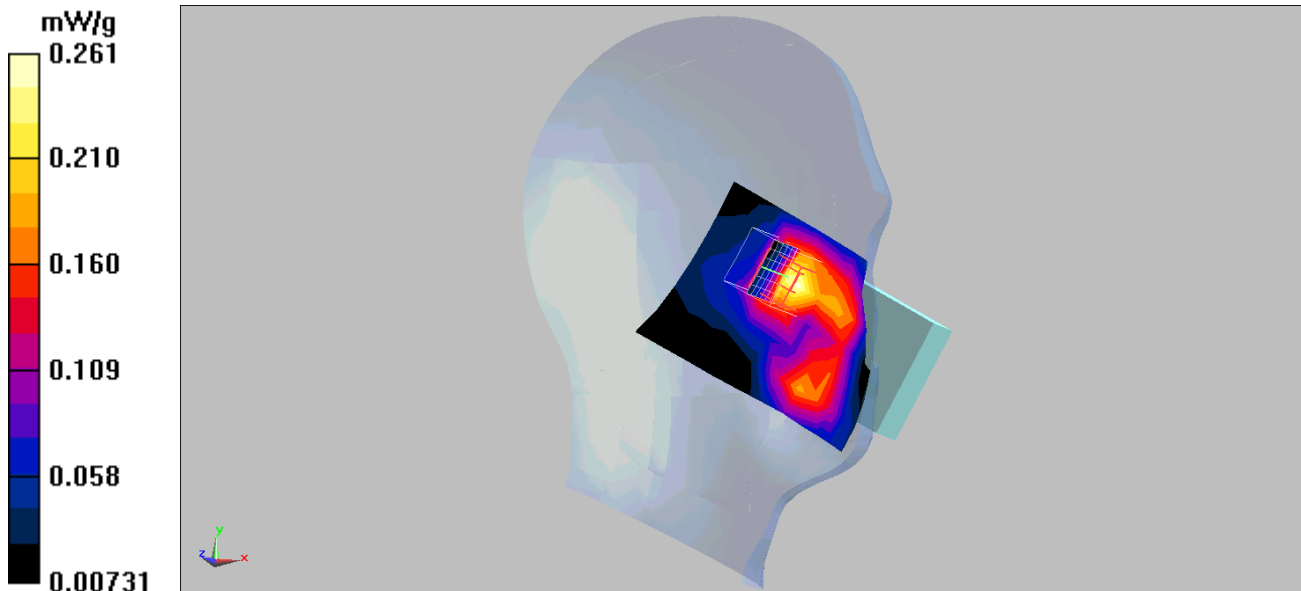

Date/Time: 12/22/2009

Test Laboratory: Quietek

**Band II\_Left-Cheek\_Channel-9538**

**DUT: Smart Handheld; Type: M900DF**

Communication System: FCC WCDMA\_Band-II; Frequency: 1907.6 MHz; Duty Cycle: 1:1

Medium parameters used:  $f = 1907.6 \text{ MHz}$ ;  $\sigma = 1.4 \text{ mho/m}$ ;  $\epsilon_r = 38.9$ ;  $\rho = 1000 \text{ kg/m}^3$

Phantom section: Left Section

Ambient Temperature ( $^{\circ}\text{C}$ ) : 20.8, Liquid Temperature ( $^{\circ}\text{C}$ ) : 20.1

DASY4 Configuration:

- Probe: EX3DV4 - SN3602; ConvF(7.81, 7.81, 7.81); Calibrated: 5/20/2009
- Sensor-Surface: 4mm (Mechanical Surface Detection)
- Electronics: DAE4 Sn1207; Calibrated: 4/7/2009
- Phantom: SAM Left Table; Type: SAM;
- Measurement SW: DASY5, V5.0 Build 125; SEMCAD X Version 13.4 Build 125

**Band II/Area Scan (7x11x1):** Measurement grid: dx=15mm, dy=15mm

Maximum value of SAR (measured) = 0.226 mW/g

**Band II/Zoom Scan (7x7x7) (7x7x7)/Cube 0:** Measurement grid: dx=5mm, dy=5mm, dz=5mm

Reference Value = 5.47 V/m; Power Drift = 0.078 dB

Peak SAR (extrapolated) = 0.362 W/kg

**SAR(1 g) = 0.235 mW/g; SAR(10 g) = 0.145 mW/g**

Maximum value of SAR (measured) = 0.257 mW/g

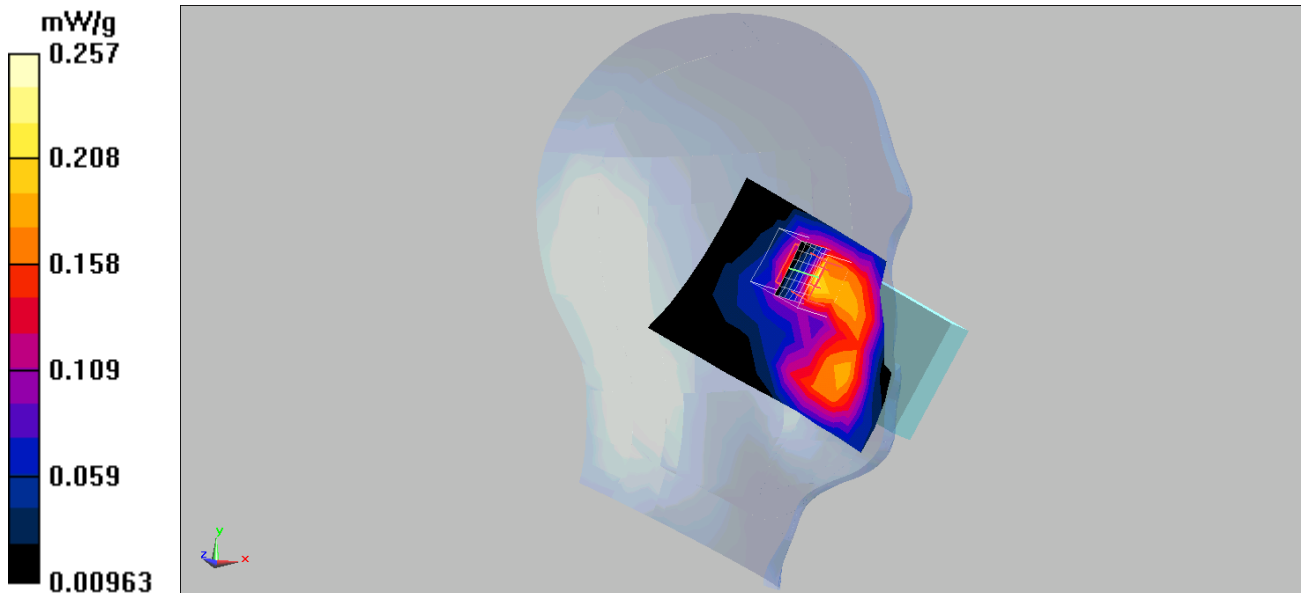



Date/Time: 12/22/2009

Test Laboratory: Quietek

**Band II\_Left-Tilt\_Channel-9262**

**DUT: Smart Handheld; Type: M900DF**

Communication System: FCC WCDMA\_Band-II; Frequency: 1852.4 MHz; Duty Cycle: 1:1

Medium parameters used:  $f = 1852.4 \text{ MHz}$ ;  $\sigma = 1.37 \text{ mho/m}$ ;  $\epsilon_r = 39.3$ ;  $\rho = 1000 \text{ kg/m}^3$

Phantom section: Left Section

Ambient Temperature ( $^{\circ}\text{C}$ ) : 20.8, Liquid Temperature ( $^{\circ}\text{C}$ ) : 20.1

DASY4 Configuration:

- Probe: EX3DV4 - SN3602; ConvF(7.81, 7.81, 7.81); Calibrated: 5/20/2009
- Sensor-Surface: 4mm (Mechanical Surface Detection)
- Electronics: DAE4 Sn1207; Calibrated: 4/7/2009
- Phantom: SAM Left Table; Type: SAM;
- Measurement SW: DASY5, V5.0 Build 125; SEMCAD X Version 13.4 Build 125

**Band II/Area Scan (7x11x1):** Measurement grid: dx=15mm, dy=15mm

Maximum value of SAR (measured) = 0.204 mW/g

**Band II/Zoom Scan (7x7x7) (7x7x7)/Cube 0:** Measurement grid: dx=5mm, dy=5mm, dz=5mm

Reference Value = 10.1 V/m; Power Drift = 0.170 dB

Peak SAR (extrapolated) = 0.279 W/kg

**SAR(1 g) = 0.189 mW/g; SAR(10 g) = 0.122 mW/g**

Maximum value of SAR (measured) = 0.206 mW/g

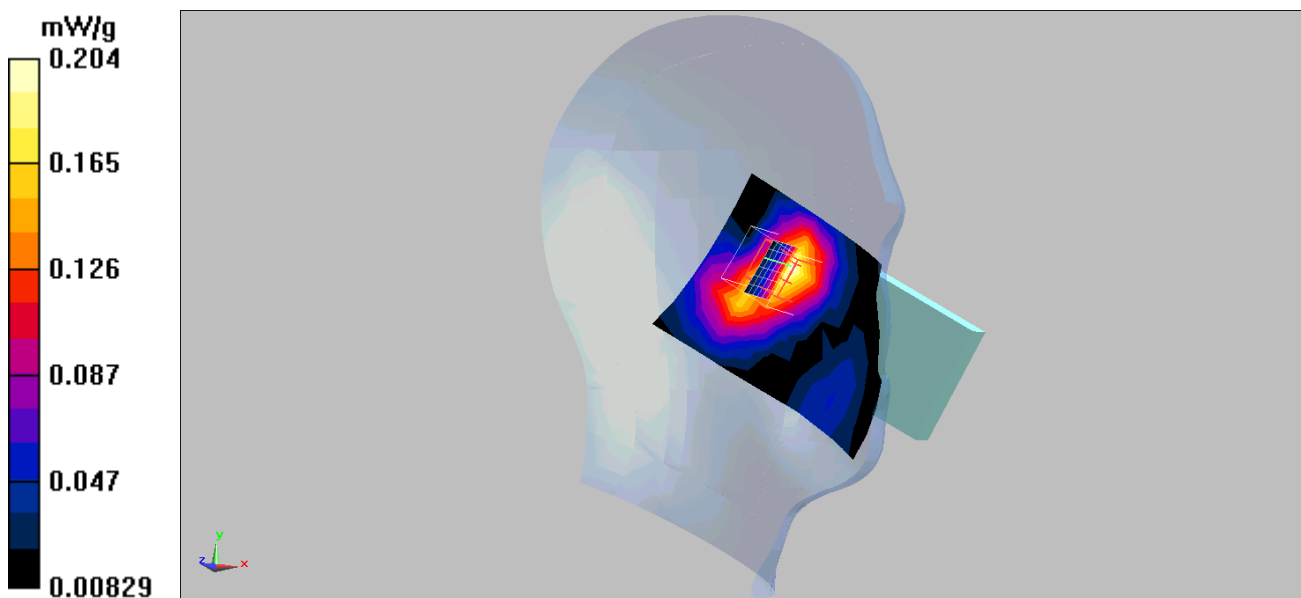

Date/Time: 12/22/2009

Test Laboratory: Quietek

### Band II\_Left-Tilt\_Channel-9400

**DUT: Smart Handheld; Type: M900DF**

Communication System: FCC WCDMA\_Band-II; Frequency: 1880 MHz; Duty Cycle: 1:1

Medium parameters used:  $f = 1880$  MHz;  $\sigma = 1.38$  mho/m;  $\epsilon_r = 39.5$ ;  $\rho = 1000$  kg/m<sup>3</sup>

Phantom section: Left Section

Ambient Temperature (°C) : 20.8, Liquid Temperature (°C) : 20.1

DASY4 Configuration:

- Probe: EX3DV4 - SN3602; ConvF(7.81, 7.81, 7.81); Calibrated: 5/20/2009
- Sensor-Surface: 4mm (Mechanical Surface Detection)
- Electronics: DAE4 Sn1207; Calibrated: 4/7/2009
- Phantom: SAM Left Table; Type: SAM;
- Measurement SW: DASY5, V5.0 Build 125; SEMCAD X Version 13.4 Build 125

**Band II/Area Scan (7x11x1):** Measurement grid: dx=15mm, dy=15mm

Maximum value of SAR (measured) = 0.245 mW/g

**Band II/Zoom Scan (7x7x7) (7x7x7)/Cube 0:** Measurement grid: dx=5mm, dy=5mm, dz=5mm

Reference Value = 11.1 V/m; Power Drift = 0.029 dB

Peak SAR (extrapolated) = 0.340 W/kg

**SAR(1 g) = 0.229 mW/g; SAR(10 g) = 0.143 mW/g**

Maximum value of SAR (measured) = 0.246 mW/g

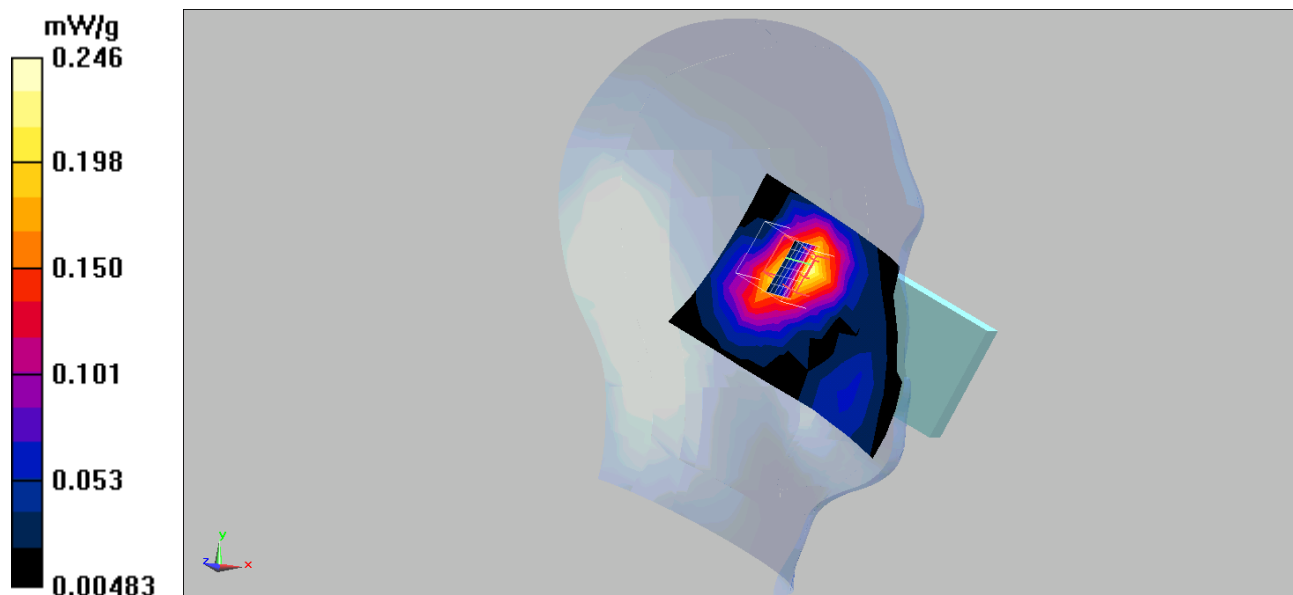

Date/Time: 12/22/2009

Test Laboratory: Quietek

**Band II\_Left-Tilt\_Channel-9538**

**DUT: Smart Handheld; Type: M900DF**

Communication System: FCC WCDMA\_Band-II; Frequency: 1907.6 MHz; Duty Cycle: 1:1

Medium parameters used:  $f = 1907.6 \text{ MHz}$ ;  $\sigma = 1.4 \text{ mho/m}$ ;  $\epsilon_r = 38.9$ ;  $\rho = 1000 \text{ kg/m}^3$

Phantom section: Left Section

Ambient Temperature ( $^{\circ}\text{C}$ ) : 20.8, Liquid Temperature ( $^{\circ}\text{C}$ ) : 20.1

DASY4 Configuration:

- Probe: EX3DV4 - SN3602; ConvF(7.81, 7.81, 7.81); Calibrated: 5/20/2009
- Sensor-Surface: 4mm (Mechanical Surface Detection)
- Electronics: DAE4 Sn1207; Calibrated: 4/7/2009
- Phantom: SAM Left Table; Type: SAM;
- Measurement SW: DASY5, V5.0 Build 125; SEMCAD X Version 13.4 Build 125

**Band II/Area Scan (7x11x1):** Measurement grid: dx=15mm, dy=15mm

Maximum value of SAR (measured) = 0.204 mW/g

**Band II/Zoom Scan (7x7x7) (7x7x7)/Cube 0:** Measurement grid: dx=5mm, dy=5mm, dz=5mm

Reference Value = 9.96 V/m; Power Drift = 0.127 dB

Peak SAR (extrapolated) = 0.295 W/kg

**SAR(1 g) = 0.190 mW/g; SAR(10 g) = 0.117 mW/g**

Maximum value of SAR (measured) = 0.205 mW/g

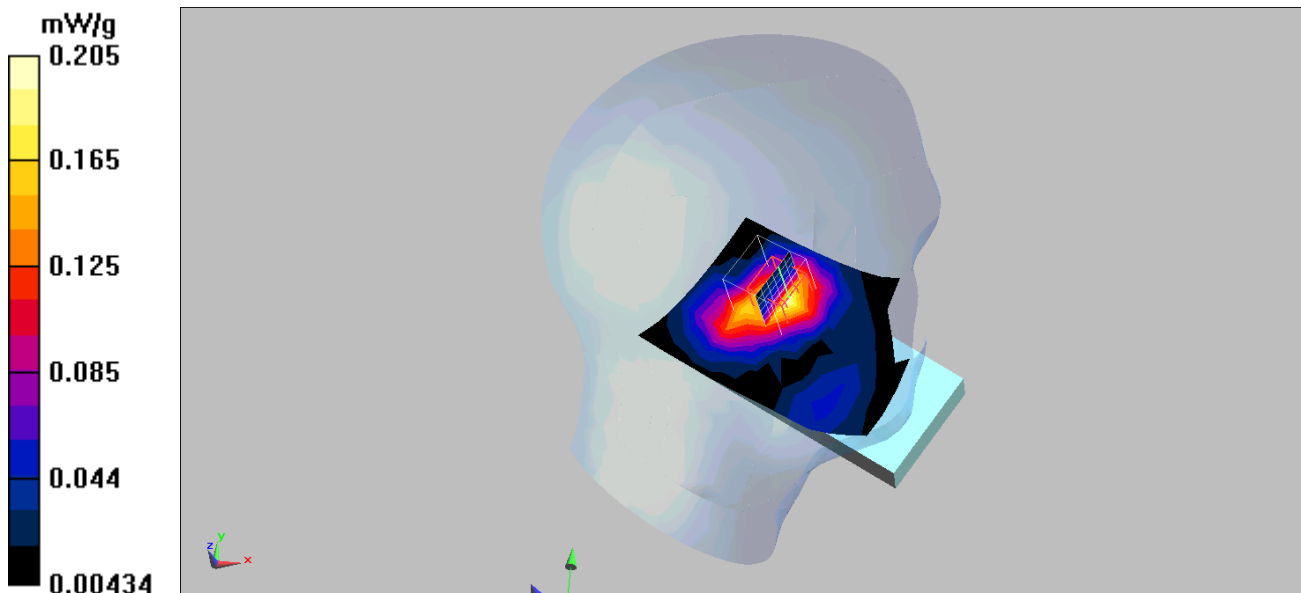

Date/Time: 12/22/2009

Test Laboratory: Quietek

**Band II\_Right-Cheek\_Channel-9262**

**DUT: Smart Handheld; Type: M900DF**

Communication System: FCC WCDMA\_Band-II; Frequency: 1852.4 MHz; Duty Cycle: 1:1

Medium parameters used:  $f = 1852.4 \text{ MHz}$ ;  $\sigma = 1.37 \text{ mho/m}$ ;  $\epsilon_r = 39.3$ ;  $\rho = 1000 \text{ kg/m}^3$

Phantom section: Right Section

Ambient Temperature ( $^{\circ}\text{C}$ ) : 20.8, Liquid Temperature ( $^{\circ}\text{C}$ ) : 20.1

DASY4 Configuration:

- Probe: EX3DV4 - SN3602; ConvF(7.81, 7.81, 7.81); Calibrated: 5/20/2009
- Sensor-Surface: 4mm (Mechanical Surface Detection)
- Electronics: DAE4 Sn1207; Calibrated: 4/7/2009
- Phantom: SAM Left Table; Type: SAM;
- Measurement SW: DASY5, V5.0 Build 125; SEMCAD X Version 13.4 Build 125

**Band II/Area Scan (7x11x1):** Measurement grid: dx=15mm, dy=15mm

Maximum value of SAR (measured) = 0.292 mW/g

**Band II/Zoom Scan (7x7x7) (7x7x7)/Cube 0:** Measurement grid: dx=5mm, dy=5mm, dz=5mm

Reference Value = 8.44 V/m; Power Drift = 0.077 dB

Peak SAR (extrapolated) = 0.421 W/kg

**SAR(1 g) = 0.286 mW/g; SAR(10 g) = 0.183 mW/g**

Maximum value of SAR (measured) = 0.309 mW/g

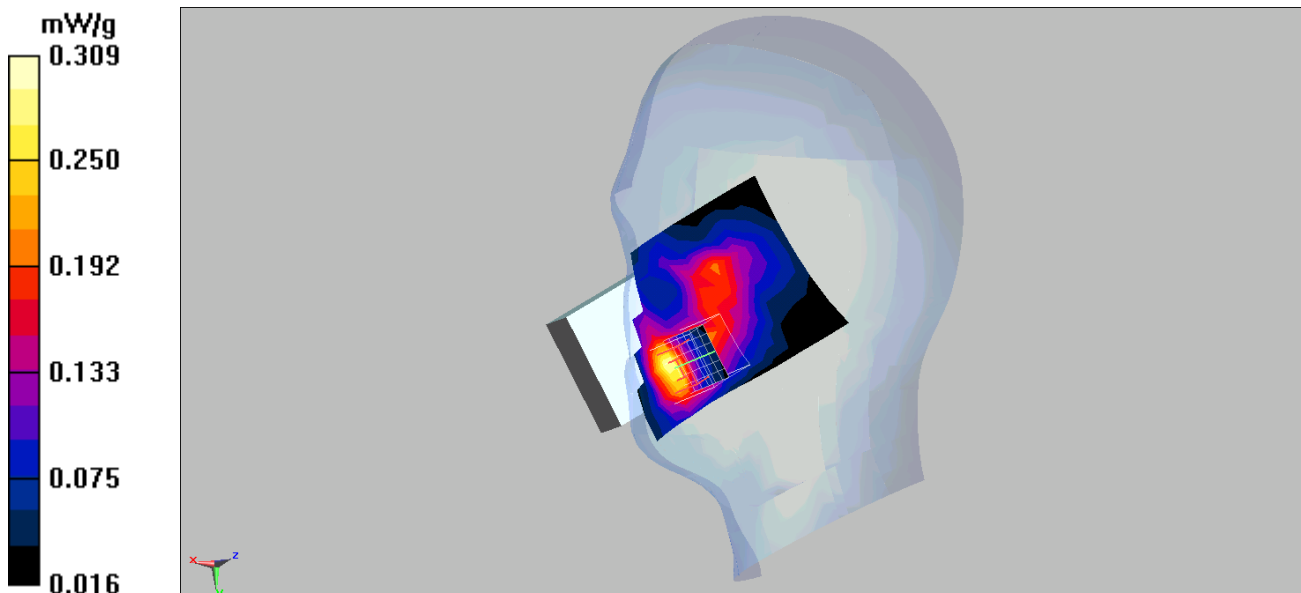

Date/Time: 12/22/2009

Test Laboratory: Quietek

**Band II\_Right-Cheek\_Channel-9400**

**DUT: Smart Handheld; Type: M900DF**

Communication System: FCC WCDMA\_Band-II; Frequency: 1880 MHz; Duty Cycle: 1:1

Medium parameters used:  $f = 1880 \text{ MHz}$ ;  $\sigma = 1.38 \text{ mho/m}$ ;  $\epsilon_r = 39.5$ ;  $\rho = 1000 \text{ kg/m}^3$

Phantom section: Right Section

Ambient Temperature ( $^{\circ}\text{C}$ ) : 20.8, Liquid Temperature ( $^{\circ}\text{C}$ ) : 20.1

DASY4 Configuration:

- Probe: EX3DV4 - SN3602; ConvF(7.81, 7.81, 7.81); Calibrated: 5/20/2009
- Sensor-Surface: 4mm (Mechanical Surface Detection)
- Electronics: DAE4 Sn1207; Calibrated: 4/7/2009
- Phantom: SAM Left Table; Type: SAM;
- Measurement SW: DASY5, V5.0 Build 125; SEMCAD X Version 13.4 Build 125

**Band II/Area Scan (7x11x1):** Measurement grid:  $dx=15\text{mm}$ ,  $dy=15\text{mm}$

Maximum value of SAR (measured) = 0.287 mW/g

**Band II/Zoom Scan (7x7x7) (7x7x7)/Cube 0:** Measurement grid:  $dx=5\text{mm}$ ,  $dy=5\text{mm}$ ,  $dz=5\text{mm}$

Reference Value = 8.25 V/m; Power Drift = 0.169 dB

Peak SAR (extrapolated) = 0.414 W/kg

**SAR(1 g) = 0.289 mW/g; SAR(10 g) = 0.185 mW/g**

Maximum value of SAR (measured) = 0.311 mW/g

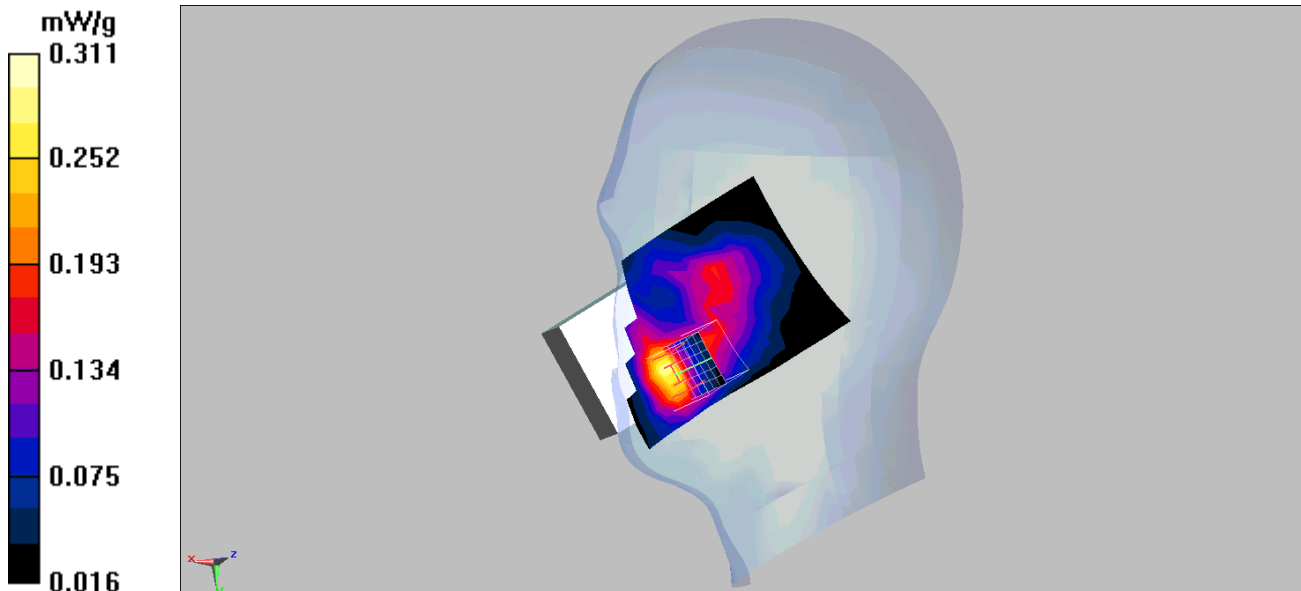

Date/Time: 12/22/2009

Test Laboratory: Quietek

**Band II\_Right-Cheek\_Channel-9538**

**DUT: Smart Handheld; Type: M900DF**

Communication System: FCC WCDMA\_Band-II; Frequency: 1907.6 MHz; Duty Cycle: 1:1

Medium parameters used:  $f = 1907.6 \text{ MHz}$ ;  $\sigma = 1.4 \text{ mho/m}$ ;  $\epsilon_r = 38.9$ ;  $\rho = 1000 \text{ kg/m}^3$

Phantom section: Right Section

Ambient Temperature ( $^{\circ}\text{C}$ ) : 20.8, Liquid Temperature ( $^{\circ}\text{C}$ ) : 20.1

DASY4 Configuration:

- Probe: EX3DV4 - SN3602; ConvF(7.81, 7.81, 7.81); Calibrated: 5/20/2009
- Sensor-Surface: 4mm (Mechanical Surface Detection)
- Electronics: DAE4 Sn1207; Calibrated: 4/7/2009
- Phantom: SAM Left Table; Type: SAM;
- Measurement SW: DASY5, V5.0 Build 125; SEMCAD X Version 13.4 Build 125

**Band II/Area Scan (7x11x1):** Measurement grid: dx=15mm, dy=15mm

Maximum value of SAR (measured) = 0.273 mW/g

**Band II/Zoom Scan (7x7x7) (7x7x7)/Cube 0:** Measurement grid: dx=5mm, dy=5mm, dz=5mm

Reference Value = 8.27 V/m; Power Drift = 0.049 dB

Peak SAR (extrapolated) = 0.407 W/kg

**SAR(1 g) = 0.276 mW/g; SAR(10 g) = 0.175 mW/g**

Maximum value of SAR (measured) = 0.302 mW/g

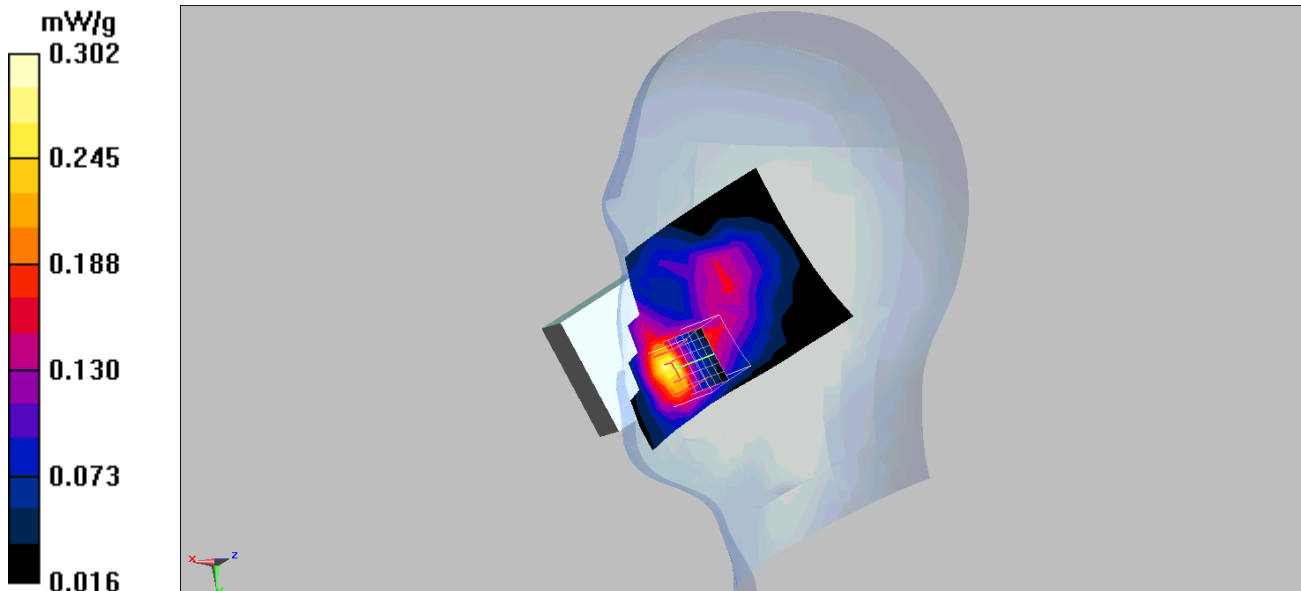

Date/Time: 12/22/2009

Test Laboratory: Quietek

**Band II\_Right-Tilt\_Channel-9262**

**DUT: Smart Handheld; Type: M900DF**

Communication System: FCC WCDMA\_Band-II; Frequency: 1852.4 MHz; Duty Cycle: 1:1

Medium parameters used:  $f = 1852.4 \text{ MHz}$ ;  $\sigma = 1.37 \text{ mho/m}$ ;  $\epsilon_r = 39.3$ ;  $\rho = 1000 \text{ kg/m}^3$

Phantom section: Right Section

Ambient Temperature ( $^{\circ}\text{C}$ ) : 20.8, Liquid Temperature ( $^{\circ}\text{C}$ ) : 20.1

DASY4 Configuration:

- Probe: EX3DV4 - SN3602; ConvF(7.81, 7.81, 7.81); Calibrated: 5/20/2009
- Sensor-Surface: 4mm (Mechanical Surface Detection)
- Electronics: DAE4 Sn1207; Calibrated: 4/7/2009
- Phantom: SAM Left Table; Type: SAM;
- Measurement SW: DASY5, V5.0 Build 125; SEMCAD X Version 13.4 Build 125

**Band II/Area Scan (7x11x1):** Measurement grid: dx=15mm, dy=15mm

Maximum value of SAR (measured) = 0.235 mW/g

**Band II/Zoom Scan (7x7x7) (7x7x7)/Cube 0:** Measurement grid: dx=5mm, dy=5mm, dz=5mm

Reference Value = 12.9 V/m; Power Drift = -0.123 dB

Peak SAR (extrapolated) = 0.321 W/kg

**SAR(1 g) = 0.224 mW/g; SAR(10 g) = 0.149 mW/g**

Maximum value of SAR (measured) = 0.240 mW/g

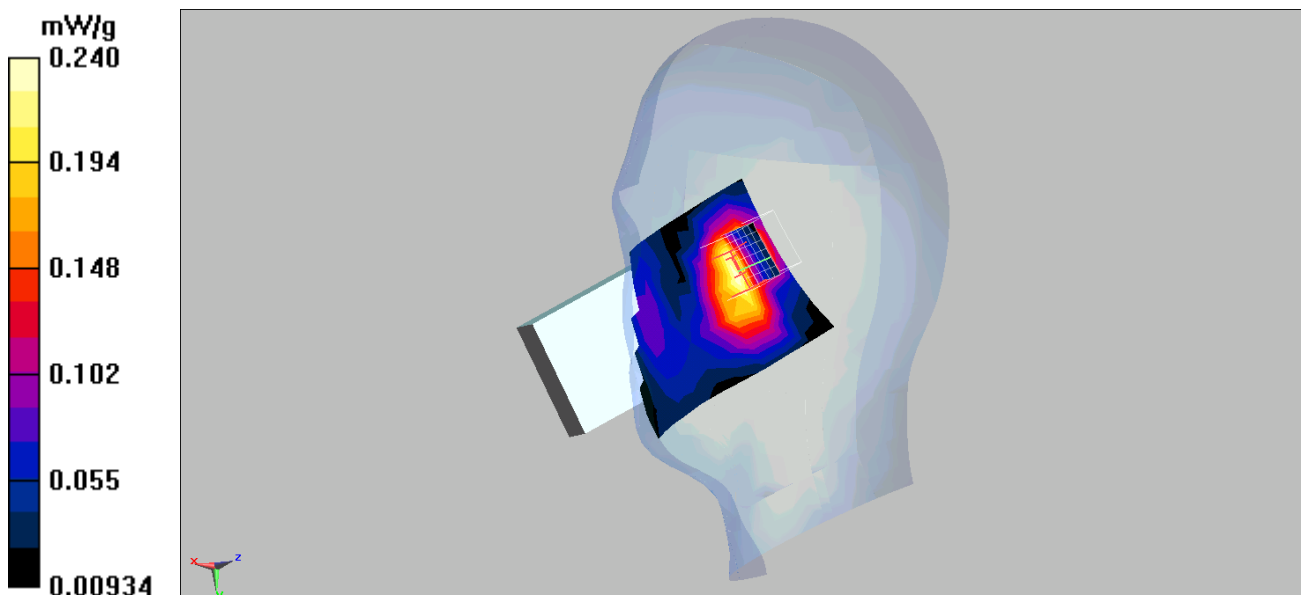

Date/Time: 12/22/2009

Test Laboratory: Quietek

**Band II\_Right-Tilt\_Channel-9400**

**DUT: Smart Handheld; Type: M900DF**

Communication System: FCC WCDMA\_Band-II; Frequency: 1880 MHz; Duty Cycle: 1:1

Medium parameters used:  $f = 1880$  MHz;  $\sigma = 1.38$  mho/m;  $\epsilon_r = 39.5$ ;  $\rho = 1000$  kg/m<sup>3</sup>

Phantom section: Right Section

Ambient Temperature (°C) : 20.8, Liquid Temperature (°C) : 20.1

DASY4 Configuration:

- Probe: EX3DV4 - SN3602; ConvF(7.81, 7.81, 7.81); Calibrated: 5/20/2009
- Sensor-Surface: 4mm (Mechanical Surface Detection)
- Electronics: DAE4 Sn1207; Calibrated: 4/7/2009
- Phantom: SAM Left Table; Type: SAM;
- Measurement SW: DASY5, V5.0 Build 125; SEMCAD X Version 13.4 Build 125

**Band II/Area Scan (7x11x1):** Measurement grid: dx=15mm, dy=15mm

Maximum value of SAR (measured) = 0.229 mW/g

**Band II/Zoom Scan (7x7x7) (7x7x7)/Cube 0:** Measurement grid: dx=5mm, dy=5mm, dz=5mm

Reference Value = 12.6 V/m; Power Drift = 0.079 dB

Peak SAR (extrapolated) = 0.327 W/kg

**SAR(1 g) = 0.222 mW/g; SAR(10 g) = 0.142 mW/g**

Maximum value of SAR (measured) = 0.244 mW/g

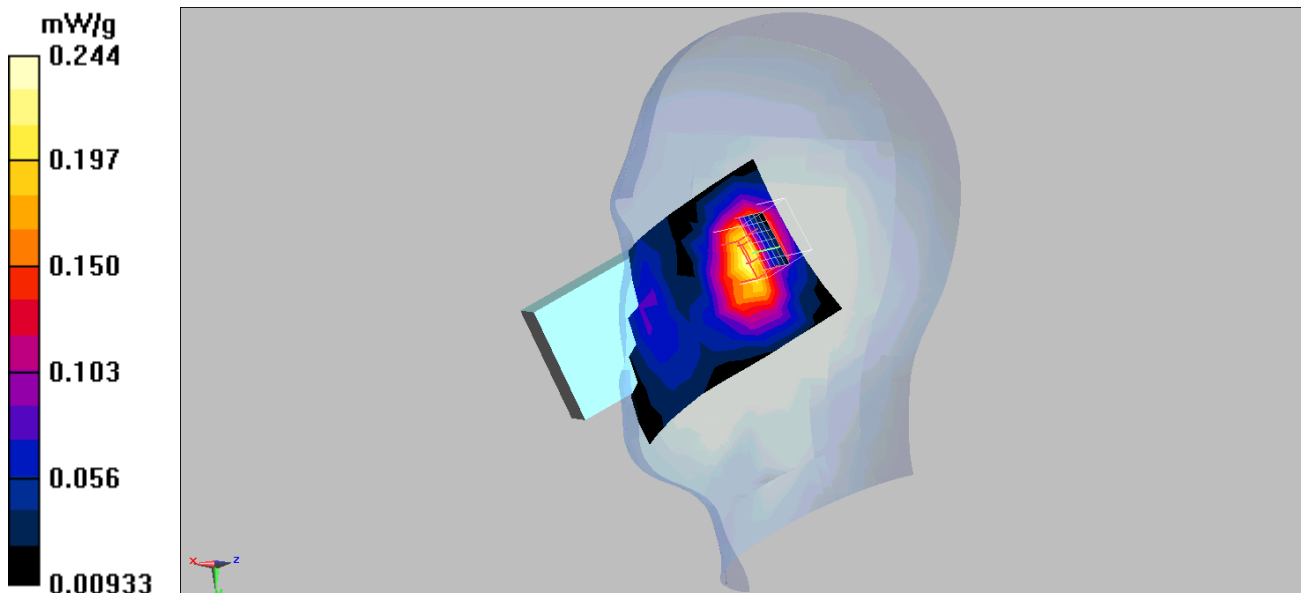



Date/Time: 12/22/2009

Test Laboratory: Quietek

**Band II\_Right-Tilt\_Channel-9538**

**DUT: Smart Handheld; Type: M900DF**

Communication System: FCC WCDMA\_Band-II; Frequency: 1907.6 MHz; Duty Cycle: 1:1

Medium parameters used:  $f = 1907.6 \text{ MHz}$ ;  $\sigma = 1.4 \text{ mho/m}$ ;  $\epsilon_r = 38.9$ ;  $\rho = 1000 \text{ kg/m}^3$

Phantom section: Right Section

Ambient Temperature ( $^{\circ}\text{C}$ ) : 20.8, Liquid Temperature ( $^{\circ}\text{C}$ ) : 20.1

DASY4 Configuration:

- Probe: EX3DV4 - SN3602; ConvF(7.81, 7.81, 7.81); Calibrated: 5/20/2009
- Sensor-Surface: 4mm (Mechanical Surface Detection)
- Electronics: DAE4 Sn1207; Calibrated: 4/7/2009
- Phantom: SAM Left Table; Type: SAM;
- Measurement SW: DASY5, V5.0 Build 125; SEMCAD X Version 13.4 Build 125

**Band II/Area Scan (7x11x1):** Measurement grid: dx=15mm, dy=15mm

Maximum value of SAR (measured) = 0.186 mW/g

**Band II/Zoom Scan (7x7x7) (7x7x7)/Cube 0:** Measurement grid: dx=5mm, dy=5mm, dz=5mm

Reference Value = 11.5 V/m; Power Drift = 0.069 dB

Peak SAR (extrapolated) = 0.260 W/kg

**SAR(1 g) = 0.177 mW/g; SAR(10 g) = 0.114 mW/g**

Maximum value of SAR (measured) = 0.192 mW/g

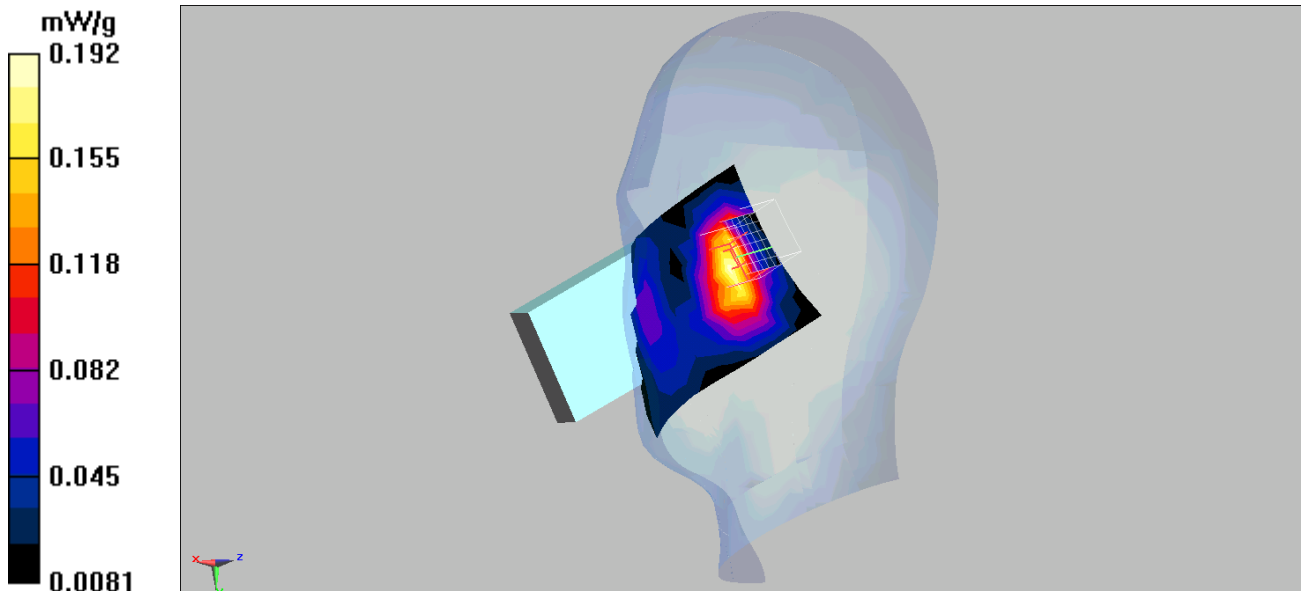

Date/Time: 12/22/2009

Test Laboratory: Quietek

**Band II\_Body\_Channel-9262**

**DUT: Smart Handheld; Type: M900DF**

Communication System: FCC WCDMA\_Band-II; Frequency: 1852.4 MHz; Duty Cycle: 1:1

Medium parameters used:  $f = 1852.4 \text{ MHz}$ ;  $\sigma = 1.46 \text{ mho/m}$ ;  $\epsilon_r = 53.5$ ;  $\rho = 1000 \text{ kg/m}^3$

Phantom section: Flat Section

Ambient Temperature ( $^{\circ}\text{C}$ ) : 20.8, Liquid Temperature ( $^{\circ}\text{C}$ ) : 20.1

DASY4 Configuration:

- Probe: EX3DV4 - SN3602; ConvF(7.97, 7.97, 7.97); Calibrated: 5/20/2009
- Sensor-Surface: 4mm (Mechanical Surface Detection)
- Electronics: DAE4 Sn1207; Calibrated: 4/7/2009
- Phantom: SAM Right Table; Type: SAM;
- Measurement SW: DASY5, V5.0 Build 125; SEMCAD X Version 13.4 Build 125

**Band II/Area Scan (7x11x1):** Measurement grid: dx=15mm, dy=15mm

Maximum value of SAR (measured) = 0.855 mW/g

**Band II/Zoom Scan (7x7x7) (7x7x7)/Cube 0:** Measurement grid: dx=5mm, dy=5mm, dz=5mm

Reference Value = 12.2 V/m; Power Drift = 0.105 dB

Peak SAR (extrapolated) = 1.39 W/kg

**SAR(1 g) = 0.857 mW/g; SAR(10 g) = 0.534 mW/g**

Maximum value of SAR (measured) = 0.929 mW/g

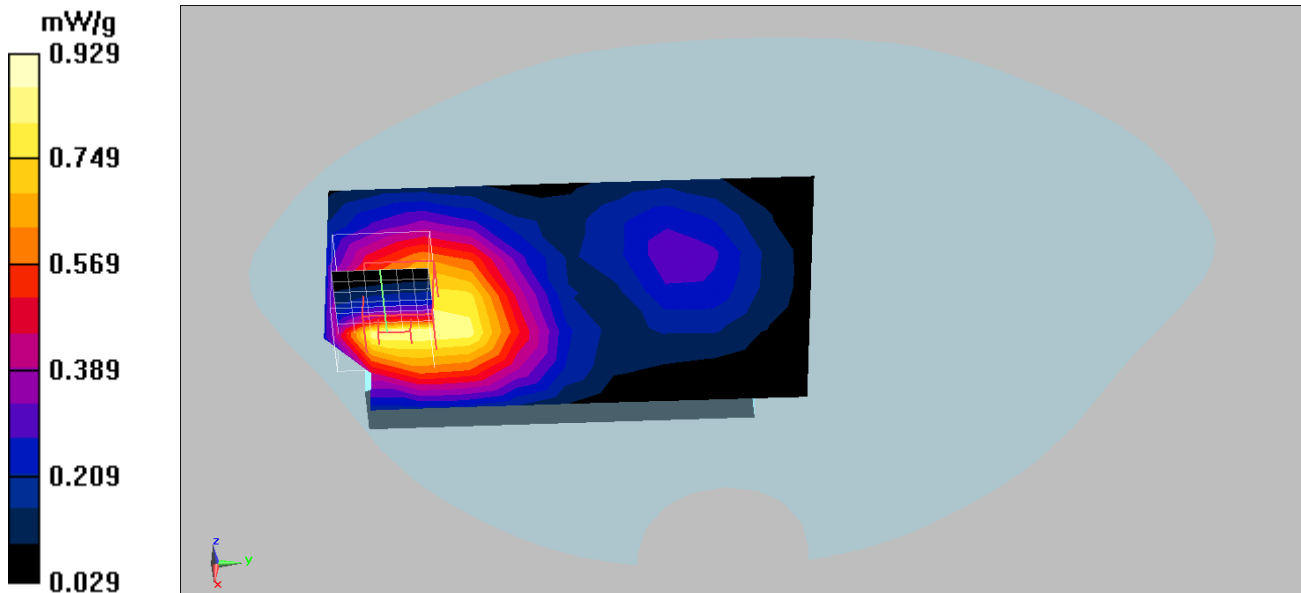

Date/Time: 12/22/2009

Test Laboratory: Quietek

### Band II\_Body\_Channel-9400

**DUT: Smart Handheld; Type: M900DF**

Communication System: FCC WCDMA\_Band-II; Frequency: 1880 MHz; Duty Cycle: 1:1

Medium parameters used:  $f = 1880$  MHz;  $\sigma = 1.47$  mho/m;  $\epsilon_r = 53.1$ ;  $\rho = 1000$  kg/m<sup>3</sup>

Phantom section: Flat Section

Ambient Temperature (°C) : 20.8, Liquid Temperature (°C) : 20.1

DASY4 Configuration:

- Probe: EX3DV4 - SN3602; ConvF(7.97, 7.97, 7.97); Calibrated: 5/20/2009
- Sensor-Surface: 4mm (Mechanical Surface Detection)
- Electronics: DAE4 Sn1207; Calibrated: 4/7/2009
- Phantom: SAM Right Table; Type: SAM;
- Measurement SW: DASY5, V5.0 Build 125; SEMCAD X Version 13.4 Build 125

**Band II/Area Scan (7x11x1):** Measurement grid: dx=15mm, dy=15mm

Maximum value of SAR (measured) = 0.823 mW/g

**Band II/Zoom Scan (7x7x7) (7x7x7)/Cube 0:** Measurement grid: dx=5mm, dy=5mm, dz=5mm

Reference Value = 11.4 V/m; Power Drift = 0.068 dB

Peak SAR (extrapolated) = 1.32 W/kg

**SAR(1 g) = 0.799 mW/g; SAR(10 g) = 0.478 mW/g**

Maximum value of SAR (measured) = 0.879 mW/g

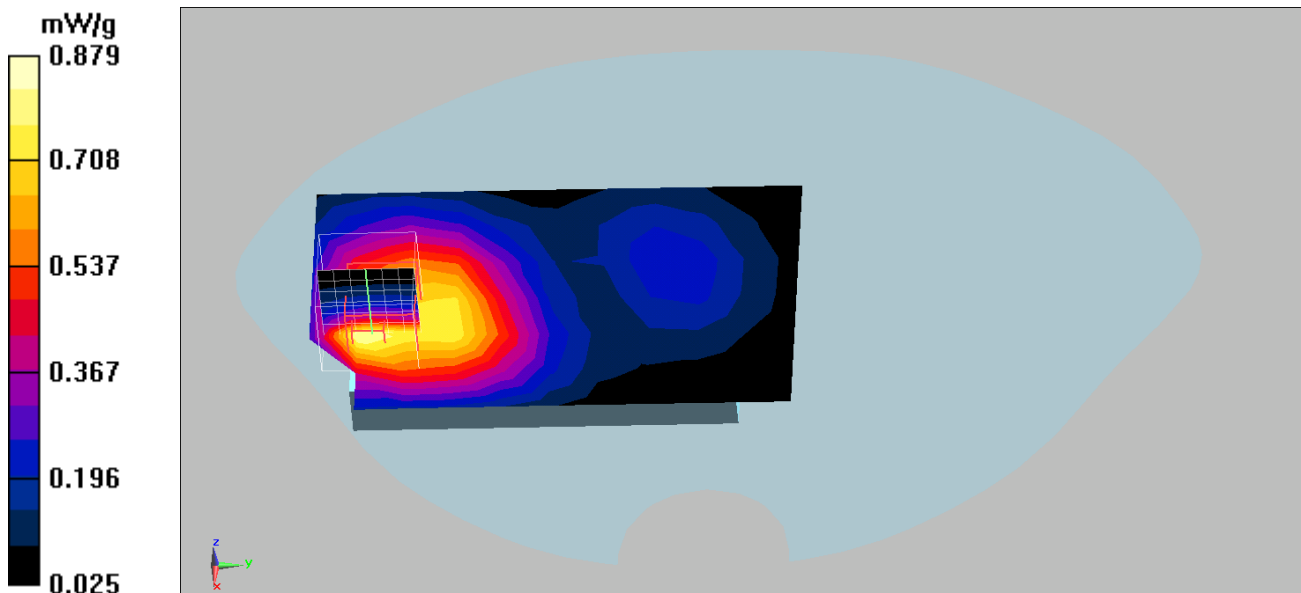

Date/Time: 12/22/2009

Test Laboratory: Quietek

**Band II\_Body\_Channel-9538**

**DUT: Smart Handheld; Type: M900DF**

Communication System: FCC WCDMA\_Band-II; Frequency: 1907.6 MHz; Duty Cycle: 1:1

Medium parameters used:  $f = 1907.6 \text{ MHz}$ ;  $\sigma = 1.51 \text{ mho/m}$ ;  $\epsilon_r = 52.3$ ;  $\rho = 1000 \text{ kg/m}^3$

Phantom section: Flat Section

Ambient Temperature ( $^{\circ}\text{C}$ ) : 20.8, Liquid Temperature ( $^{\circ}\text{C}$ ) : 20.1

DASY4 Configuration:

- Probe: EX3DV4 - SN3602; ConvF(7.97, 7.97, 7.97); Calibrated: 5/20/2009
- Sensor-Surface: 4mm (Mechanical Surface Detection)
- Electronics: DAE4 Sn1207; Calibrated: 4/7/2009
- Phantom: SAM Right Table; Type: SAM;
- Measurement SW: DASY5, V5.0 Build 125; SEMCAD X Version 13.4 Build 125

**Band II/Area Scan (7x11x1):** Measurement grid: dx=15mm, dy=15mm

Maximum value of SAR (measured) = 0.782 mW/g

**Band II/Zoom Scan (7x7x7) (7x7x7)/Cube 0:** Measurement grid: dx=5mm, dy=5mm, dz=5mm

Reference Value = 9.85 V/m; Power Drift = -0.118 dB

Peak SAR (extrapolated) = 2.24 W/kg

**SAR(1 g) = 0.726 mW/g; SAR(10 g) = 0.220 mW/g**

Maximum value of SAR (measured) = 0.770 mW/g

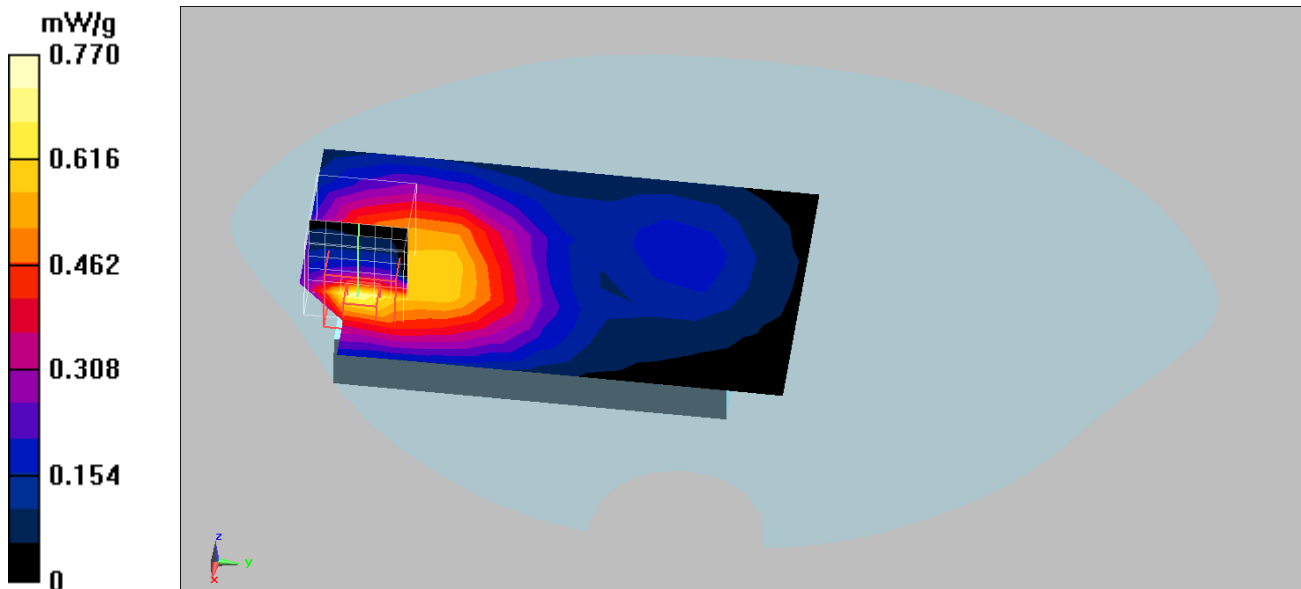

Date/Time: 12/22/2009

Test Laboratory: Quietek

**Band II\_Body\_Channel-9262 HSDPA**

**DUT: Smart Handheld; Type: M900DF**

Communication System: FCC WCDMA\_Band-II; Frequency: 1852.4 MHz; Duty Cycle: 1:1

Medium parameters used:  $f = 1852.4 \text{ MHz}$ ;  $\sigma = 1.46 \text{ mho/m}$ ;  $\epsilon_r = 53.5$ ;  $\rho = 1000 \text{ kg/m}^3$

Phantom section: Flat Section

Ambient Temperature ( $^{\circ}\text{C}$ ) : 20.8, Liquid Temperature ( $^{\circ}\text{C}$ ) : 20.1

DASY4 Configuration:

- Probe: EX3DV4 - SN3602; ConvF(7.97, 7.97, 7.97); Calibrated: 5/20/2009
- Sensor-Surface: 4mm (Mechanical Surface Detection)
- Electronics: DAE4 Sn1207; Calibrated: 4/7/2009
- Phantom: SAM Right Table; Type: SAM;
- Measurement SW: DASY5, V5.0 Build 125; SEMCAD X Version 13.4 Build 125

**Band II/Area Scan (7x11x1):** Measurement grid: dx=15mm, dy=15mm

Maximum value of SAR (measured) = 0.668 mW/g

**Band II/Zoom Scan (7x7x7) (7x7x7)/Cube 0:** Measurement grid: dx=5mm, dy=5mm, dz=5mm

Reference Value = 12.3 V/m; Power Drift = 0.126 dB

Peak SAR (extrapolated) = 1.04 W/kg

**SAR(1 g) = 0.640 mW/g; SAR(10 g) = 0.397 mW/g**

Maximum value of SAR (measured) = 0.689 mW/g

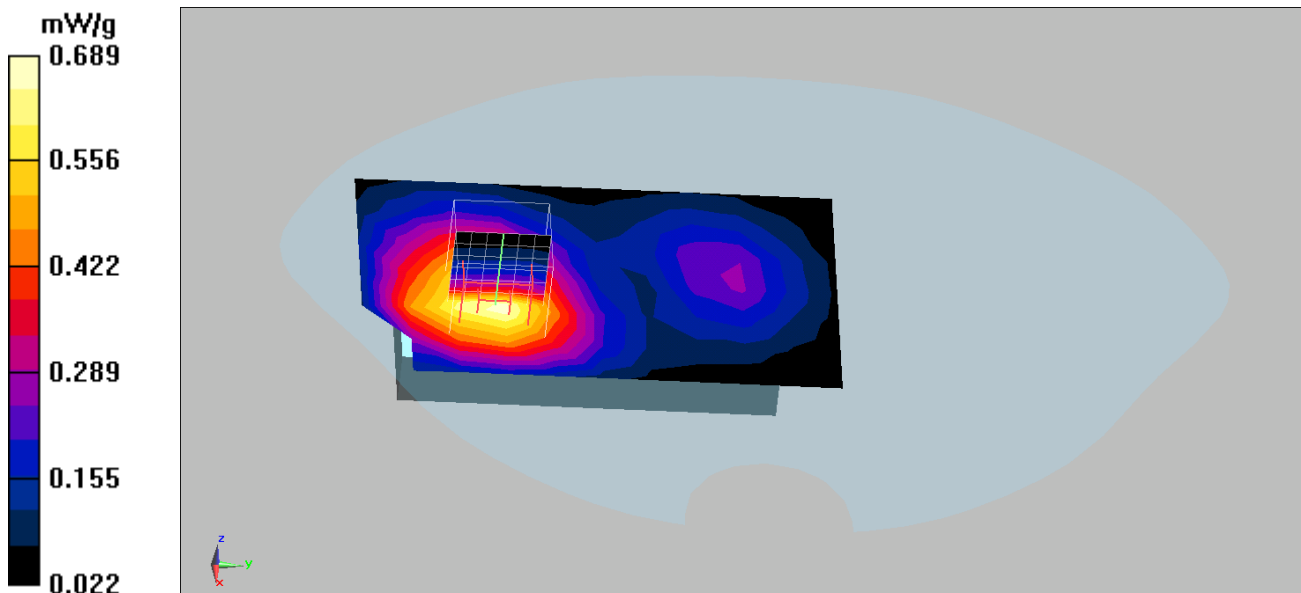

Date/Time: 12/22/2009

Test Laboratory: Quietek

**Band II\_Body\_Channel-9262 HSUPA**

**DUT: Smart Handheld; Type: M900DF**

Communication System: FCC WCDMA\_Band-II; Frequency: 1852.4 MHz;Duty Cycle: 1:1

Medium parameters used:  $f = 1852.4 \text{ MHz}$ ;  $\sigma = 1.46 \text{ mho/m}$ ;  $\epsilon_r = 53.5$ ;  $\rho = 1000 \text{ kg/m}^3$

Phantom section: Flat Section

Ambient Temperature ( $^{\circ}\text{C}$ ) : 20.8, Liquid Temperature ( $^{\circ}\text{C}$ ) : 20.1

DASY4 Configuration:

- Probe: EX3DV4 - SN3602; ConvF(7.97, 7.97, 7.97); Calibrated: 5/20/2009
- Sensor-Surface: 4mm (Mechanical Surface Detection)
- Electronics: DAE4 Sn1207; Calibrated: 4/7/2009
- Phantom: SAM Right Table; Type: SAM;
- Measurement SW: DASY5, V5.0 Build 125; SEMCAD X Version 13.4 Build 125

**Band II/Area Scan (7x11x1):** Measurement grid: dx=15mm, dy=15mm

Maximum value of SAR (measured) = 0.664 mW/g

**Band II/Zoom Scan (7x7x7) (7x7x7)/Cube 0:** Measurement grid: dx=5mm, dy=5mm, dz=5mm

Reference Value = 12.4 V/m; Power Drift = 0.115 dB

Peak SAR (extrapolated) = 1.03 W/kg

**SAR(1 g) = 0.635 mW/g; SAR(10 g) = 0.393 mW/g**

Maximum value of SAR (measured) = 0.680 mW/g

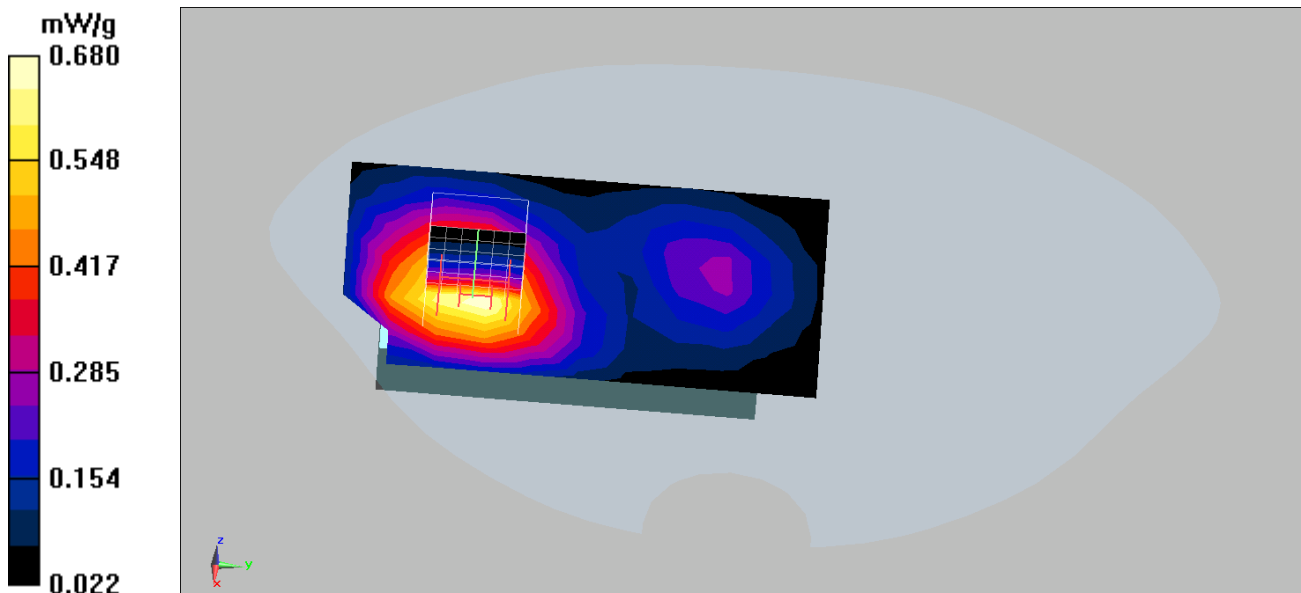

WCDMA Band II EUT Body-worn Z-Axis Plot  
Channel: 9262

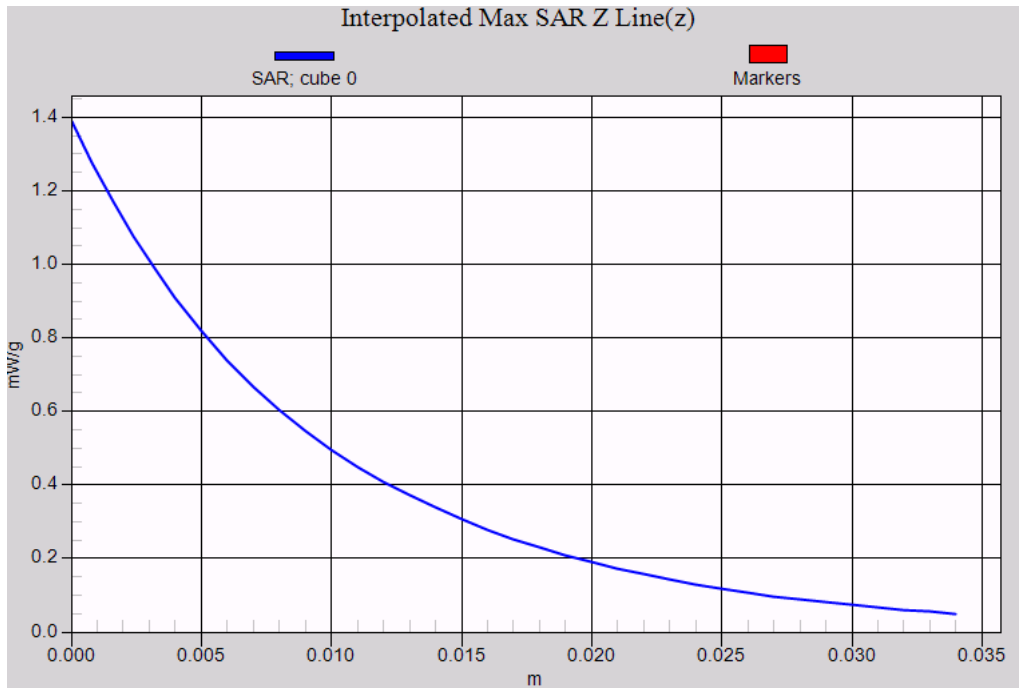



## **Appendix D. Probe Calibration Data**

**Miniature Isotropic RF Probe  
S/N: 3602**





Accredited by the Swiss Accreditation Service (SAS)  
The Swiss Accreditation Service is one of the signatories to the EA  
Multilateral Agreement for the recognition of calibration certificates

Accreditation No.: **SCS 108**

Client **Quietek (Auden)**

Certificate No: **EX3-3602\_May09**

## CALIBRATION CERTIFICATE

Object **EX3DV4 - SN:3602**

Calibration procedure(s) **QA CAL-01.v6, QA CAL-14.v3 and QA CAL-23.v3  
Calibration procedure for dosimetric E-field probes**

Calibration date: **May 20, 2009**

Condition of the calibrated item **In Tolerance**

This calibration certificate documents the traceability to national standards, which realize the physical units of measurements (SI).  
The measurements and the uncertainties with confidence probability are given on the following pages and are part of the certificate.

All calibrations have been conducted in the closed laboratory facility: environment temperature  $(22 \pm 3)^\circ\text{C}$  and humidity  $< 70\%$ .

Calibration Equipment used (M&TE critical for calibration)

Primary Standards	ID #	Cal Date (Certificate No.)	Scheduled Calibration
Power meter E4419B	GB41283874	1-Apr-09 (No. 217-01030)	Apr-10
Power sensor E4412A	MY41495277	1-Apr-09 (No. 217-01030)	Apr-10
Power sensor E4412A	MY41498087	1-Apr-09 (No. 217-01030)	Apr-10
Reference 3 dB Attenuator	SN: S5054 (3c)	31-Mar-09 (No. 217-01028)	Mar-10
Reference 20 dB Attenuator	SN: S5086 (20b)	31-Mar-09 (No. 217-01028)	Mar-10
Reference 30 dB Attenuator	SN: S5129 (30b)	31-Mar-09 (No. 217-01027)	Mar-10
Reference Probe ES3DV2	SN: 3013	2-Jan-09 (No. ES3-3013_Jan09)	Jan-10
DAE4	SN: 660	9-Sep-08 (No. DAE4-660_Sep08)	Sep-09

Secondary Standards	ID #	Check Date (in house)	Scheduled Check
RF generator HP 8648C	US3642U01700	4-Aug-99 (in house check Oct-07)	In house check: Oct-09
Network Analyzer HP 8753E	US37390585	18-Oct-01 (in house check Oct-08)	In house check: Oct-09

	Name	Function	Signature
Calibrated by:	Katja Pokovic	Technical Manager	
Approved by:	Niels Kuster	Quality Manager	

Issued: May 20, 2009

This calibration certificate shall not be reproduced except in full without written approval of the laboratory.



Accredited by the Swiss Accreditation Service (SAS)

The Swiss Accreditation Service is one of the signatories to the EA  
Multilateral Agreement for the recognition of calibration certificates

Accreditation No.: **SCS 108**

### Glossary:

TSL	tissue simulating liquid
NORM <sub>x,y,z</sub>	sensitivity in free space
ConvF	sensitivity in TSL / NORM <sub>x,y,z</sub>
DCP	diode compression point
Polarization $\varphi$	$\varphi$ rotation around probe axis
Polarization $\vartheta$	$\vartheta$ rotation around an axis that is in the plane normal to probe axis (at measurement center), i.e., $\vartheta = 0$ is normal to probe axis

### Calibration is Performed According to the Following Standards:

- IEEE Std 1528-2003, "IEEE Recommended Practice for Determining the Peak Spatial-Averaged Specific Absorption Rate (SAR) in the Human Head from Wireless Communications Devices: Measurement Techniques", December 2003
- IEC 62209-1, "Procedure to measure the Specific Absorption Rate (SAR) for hand-held devices used in close proximity to the ear (frequency range of 300 MHz to 3 GHz)", February 2005

### Methods Applied and Interpretation of Parameters:

- NORM<sub>x,y,z</sub>**: Assessed for E-field polarization  $\vartheta = 0$  ( $f \leq 900$  MHz in TEM-cell;  $f > 1800$  MHz: R22 waveguide). NORM<sub>x,y,z</sub> are only intermediate values, i.e., the uncertainties of NORM<sub>x,y,z</sub> does not effect the E<sup>2</sup>-field uncertainty inside TSL (see below *ConvF*).
- NORM(f)<sub>x,y,z</sub>** = NORM<sub>x,y,z</sub> \* frequency response (see Frequency Response Chart). This linearization is implemented in DASY4 software versions later than 4.2. The uncertainty of the frequency response is included in the stated uncertainty of *ConvF*.
- DCP<sub>x,y,z</sub>**: DCP are numerical linearization parameters assessed based on the data of power sweep (no uncertainty required). DCP does not depend on frequency nor media.
- ConvF and Boundary Effect Parameters**: Assessed in flat phantom using E-field (or Temperature Transfer Standard for  $f \leq 800$  MHz) and inside waveguide using analytical field distributions based on power measurements for  $f > 800$  MHz. The same setups are used for assessment of the parameters applied for boundary compensation (alpha, depth) of which typical uncertainty values are given. These parameters are used in DASY4 software to improve probe accuracy close to the boundary. The sensitivity in TSL corresponds to NORM<sub>x,y,z</sub> \* ConvF whereby the uncertainty corresponds to that given for ConvF. A frequency dependent ConvF is used in DASY version 4.4 and higher which allows extending the validity from  $\pm 50$  MHz to  $\pm 100$  MHz.
- Spherical isotropy (3D deviation from isotropy)**: in a field of low gradients realized using a flat phantom exposed by a patch antenna.
- Sensor Offset**: The sensor offset corresponds to the offset of virtual measurement center from the probe tip (on probe axis). No tolerance required.

# Probe EX3DV4

## SN:3602

Manufactured:	March 23, 2009
Calibrated:	May 20, 2009

Calibrated for DASY Systems

(Note: non-compatible with DASY2 system!)

## DASY - Parameters of Probe: EX3DV4 SN:3602

### Sensitivity in Free Space<sup>A</sup>

NormX	<b>0.41</b> ± 10.1%	$\mu\text{V}/(\text{V}/\text{m})^2$	DCP X	<b>87</b> mV
NormY	<b>0.40</b> ± 10.1%	$\mu\text{V}/(\text{V}/\text{m})^2$	DCP Y	<b>89</b> mV
NormZ	<b>0.52</b> ± 10.1%	$\mu\text{V}/(\text{V}/\text{m})^2$	DCP Z	<b>89</b> mV

### Diode Compression<sup>B</sup>

### Sensitivity in Tissue Simulating Liquid (Conversion Factors)

Please see Page 8.

### Boundary Effect

**TSL**                      **900 MHz**      **Typical SAR gradient: 5 % per mm**

Sensor Center to Phantom Surface Distance		<b>2.0 mm</b>	<b>3.0 mm</b>
SAR <sub>loc</sub> [%]	Without Correction Algorithm	10.2	6.1
SAR <sub>loc</sub> [%]	With Correction Algorithm	0.9	0.6

**TSL**                      **1810 MHz**      **Typical SAR gradient: 10 % per mm**

Sensor Center to Phantom Surface Distance		<b>2.0 mm</b>	<b>3.0 mm</b>
SAR <sub>loc</sub> [%]	Without Correction Algorithm	6.7	2.9
SAR <sub>loc</sub> [%]	With Correction Algorithm	0.5	0.3

### Sensor Offset

Probe Tip to Sensor Center                      **1.0 mm**

**The reported uncertainty of measurement is stated as the standard uncertainty of measurement multiplied by the coverage factor k=2, which for a normal distribution corresponds to a coverage probability of approximately 95%.**

<sup>A</sup> The uncertainties of NormX,Y,Z do not affect the E<sup>2</sup>-field uncertainty inside TSL. (see Page 8).

<sup>B</sup> Numerical linearization parameter: uncertainty not required.

# Frequency Response of E-Field

(TEM-Cell:ifi110 EXX, Waveguide: R22)

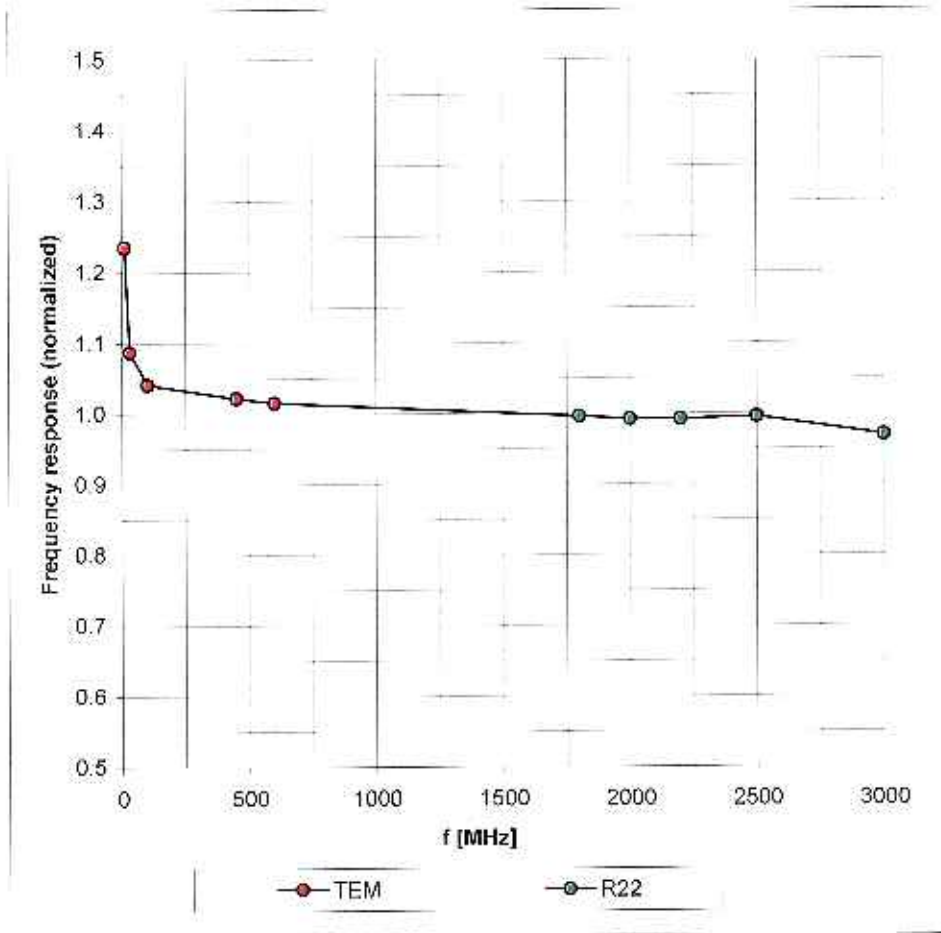

Uncertainty of Frequency Response of E-field:  $\pm 6.3\%$  (k=2)

### Receiving Pattern ( $\phi$ ), $\vartheta = 0^\circ$

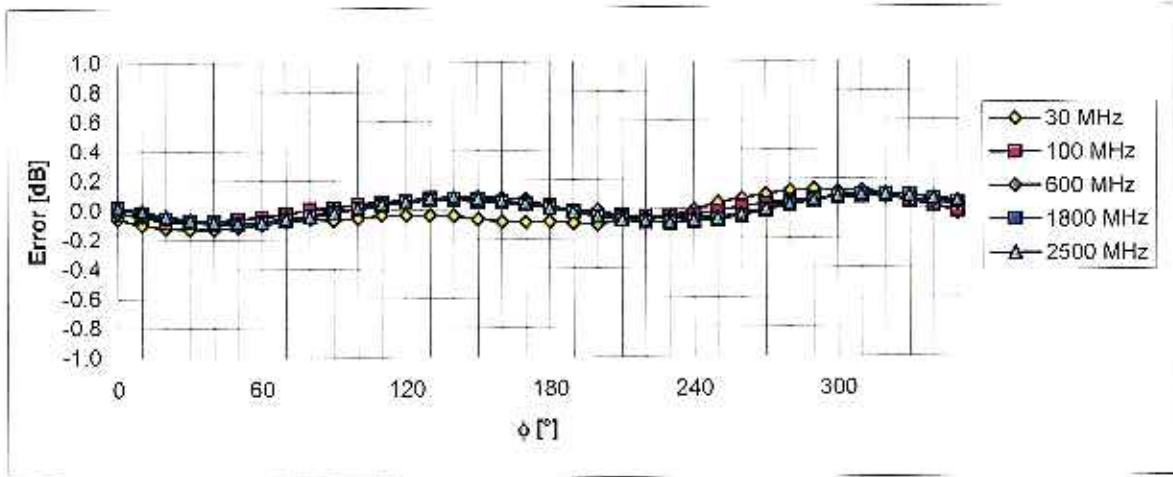
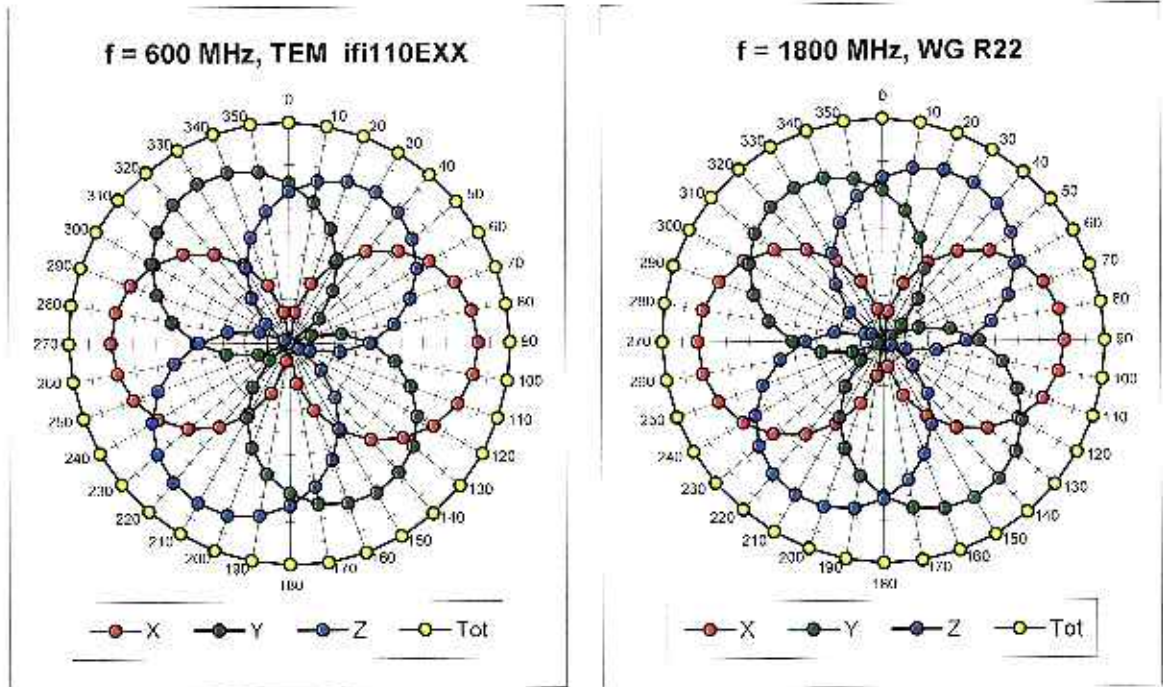

Uncertainty of Axial Isotropy Assessment:  $\pm 0.5\%$  ( $k=2$ )

### Dynamic Range $f(\text{SAR}_{\text{head}})$ (Waveguide R22, $f = 1800 \text{ MHz}$ )

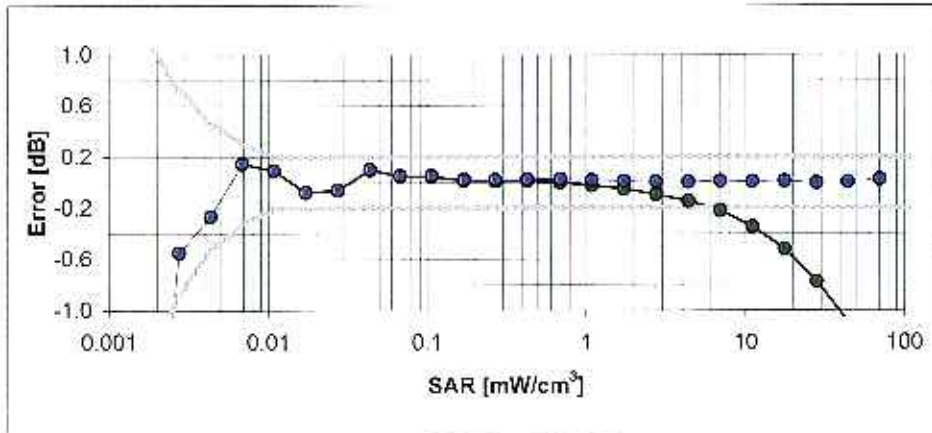
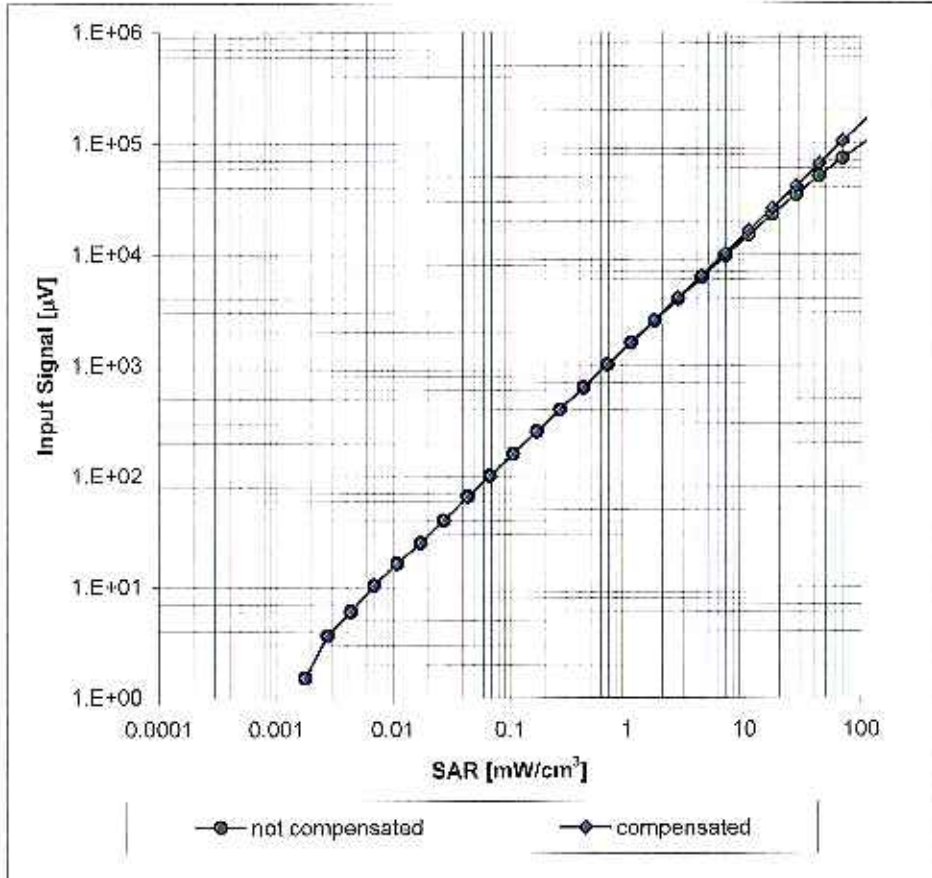

Uncertainty of Linearity Assessment:  $\pm 0.6\%$  ( $k=2$ )

## Conversion Factor Assessment

f [MHz]	Validity [MHz] <sup>c</sup>	TSL	Permittivity	Conductivity	Alpha	Depth	ConvF	Uncertainty
835	± 50 / ± 100	Head	41.5 ± 5%	0.90 ± 5%	0.56	0.71	9.14	± 11.0% (k=2)
900	± 50 / ± 100	Head	41.5 ± 5%	0.97 ± 5%	0.65	0.65	8.86	± 11.0% (k=2)
1810	± 50 / ± 100	Head	40.0 ± 5%	1.40 ± 5%	0.84	0.55	7.81	± 11.0% (k=2)
1950	± 50 / ± 100	Head	40.0 ± 5%	1.40 ± 5%	0.84	0.56	7.55	± 11.0% (k=2)
2450	± 50 / ± 100	Head	39.2 ± 5%	1.80 ± 5%	0.46	0.70	7.10	± 11.0% (k=2)
2600	± 50 / ± 100	Head	39.0 ± 5%	1.96 ± 5%	0.41	0.77	7.10	± 11.0% (k=2)
3500	± 50 / ± 100	Head	37.9 ± 5%	2.91 ± 5%	0.42	1.00	6.26	± 13.1% (k=2)
5200	± 50 / ± 100	Head	36.0 ± 5%	4.66 ± 5%	0.43	1.75	4.79	± 13.1% (k=2)
5300	± 50 / ± 100	Head	35.9 ± 5%	4.76 ± 5%	0.43	1.75	4.43	± 13.1% (k=2)
5500	± 50 / ± 100	Head	35.6 ± 5%	4.96 ± 5%	0.50	1.75	4.44	± 13.1% (k=2)
5600	± 50 / ± 100	Head	35.5 ± 5%	5.07 ± 5%	0.50	1.75	4.42	± 13.1% (k=2)
5800	± 50 / ± 100	Head	35.3 ± 5%	5.27 ± 5%	0.52	1.75	4.21	± 13.1% (k=2)
835	± 50 / ± 100	Body	55.2 ± 5%	0.97 ± 5%	0.72	0.65	9.32	± 11.0% (k=2)
900	± 50 / ± 100	Body	55.0 ± 5%	1.05 ± 5%	0.55	0.74	8.97	± 11.0% (k=2)
1810	± 50 / ± 100	Body	53.3 ± 5%	1.52 ± 5%	0.70	0.65	7.97	± 11.0% (k=2)
1950	± 50 / ± 100	Body	53.3 ± 5%	1.52 ± 5%	0.48	0.78	7.68	± 11.0% (k=2)
2450	± 50 / ± 100	Body	52.7 ± 5%	1.95 ± 5%	0.42	0.79	6.90	± 11.0% (k=2)
2600	± 50 / ± 100	Body	52.5 ± 5%	2.16 ± 5%	0.28	1.23	6.81	± 11.0% (k=2)
3500	± 50 / ± 100	Body	51.3 ± 5%	3.31 ± 5%	0.35	1.22	5.75	± 13.1% (k=2)
5200	± 50 / ± 100	Body	49.0 ± 5%	5.30 ± 5%	0.50	1.80	4.43	± 13.1% (k=2)
5300	± 50 / ± 100	Body	48.5 ± 5%	5.42 ± 5%	0.52	1.80	4.23	± 13.1% (k=2)
5500	± 50 / ± 100	Body	48.6 ± 5%	5.65 ± 5%	0.55	1.80	4.08	± 13.1% (k=2)
5600	± 50 / ± 100	Body	48.5 ± 5%	5.77 ± 5%	0.55	1.80	3.95	± 13.1% (k=2)
5800	± 50 / ± 100	Body	48.2 ± 5%	6.00 ± 5%	0.61	1.80	4.00	± 13.1% (k=2)

<sup>c</sup> The validity of ± 100 MHz only applies for DASY v4.4 and higher (see Page 2). The uncertainty is the RSS of the ConvF uncertainty at calibration frequency and the uncertainty for the indicated frequency band.



### Deviation from Isotropy in HSL

Error ( $\phi$ ,  $\theta$ ),  $f = 900$  MHz

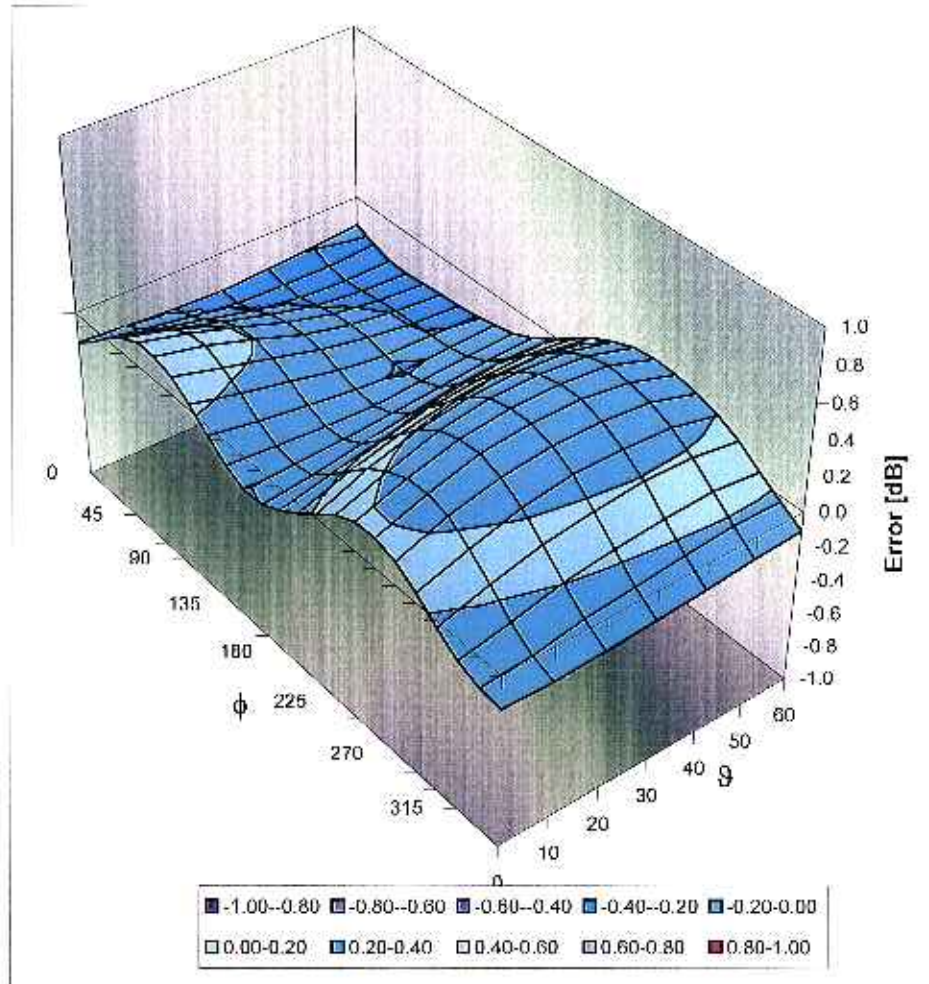

Uncertainty of Spherical Isotropy Assessment:  $\pm 2.6\%$  ( $k=2$ )



## **Appendix E. Dipole Calibration**

**Validation Dipole 835 MHz**

**M/N: ALS-D-835-S-2**

**S/N: QTK-316**

**Validation Dipole 1900 MHz**

**M/N: ALS-D-1900-S-2**

**S/N: QTK-318**

# NCL CALIBRATION LABORATORIES

Calibration File No: DC-887

## CERTIFICATE OF CALIBRATION

It is certified that the equipment identified below has been calibrated in the **NCL CALIBRATION LABORATORIES** by qualified personnel following recognized procedures and using transfer standards traceable to NRC/NIST.

Quietek Validation Dipole

Manufacturer: APREL Laboratories

Part number: ALS-D-835-S-2

Frequency: 835 MHz

Serial No: QTK-315

Customer: Quietek

Project Number: QTKB-Dipole-CAL-5336

Calibrated: 9<sup>th</sup> May 2008  
Released on: 9<sup>th</sup> May 2008

This Calibration Certificate is Incomplete Unless Accompanied with the Calibration Results Summary

Released By: \_\_\_\_\_

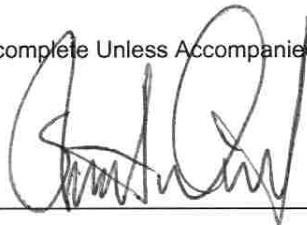

**NCL CALIBRATION LABORATORIES**

51 SPECTRUM WAY  
NEPEAN, ONTARIO  
CANADA K2R 1E6

Division of APREL Lab.  
TEL: (613) 820-4988  
FAX: (613) 820-4162

## Calibration Results Summary

The following results relate the Calibrated Dipole and should be used as a quick reference for the user.

### Mechanical Dimensions

**Length:** 165.0 mm  
**Height:** 90.0 mm

### Electrical Specification

**SWR:** 1.04 U  
**Return Loss:** -32.9 dB  
**Impedance:** 51.1  $\Omega$

### System Validation Results

Frequency	1 Gram	10 Gram	Peak
835 MHz	9.33W/Kg	6.42W/Kg	15.0W/Kg

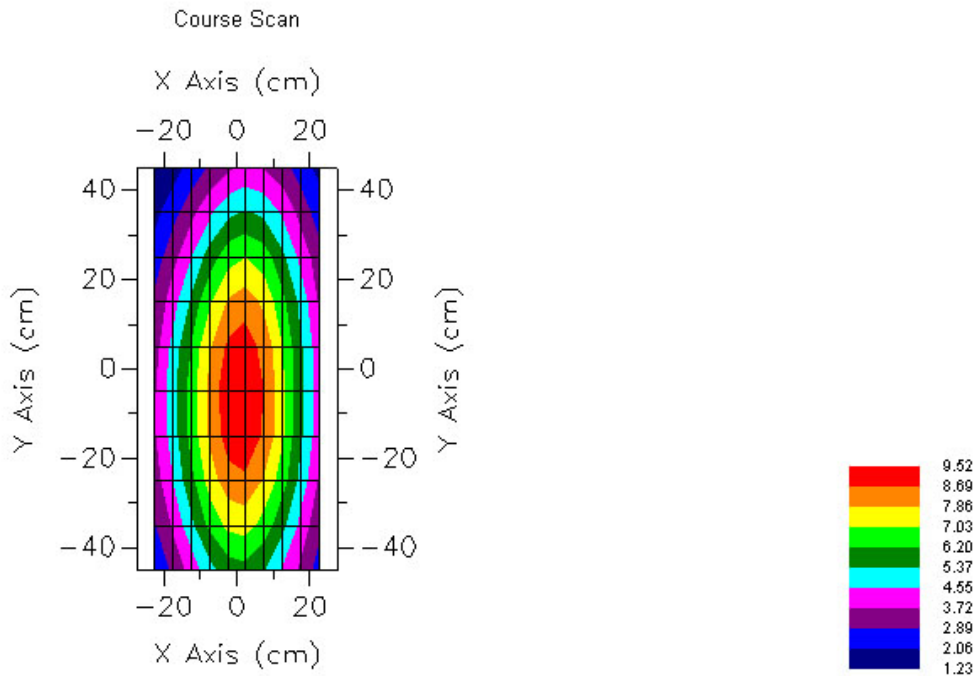

## Conditions

Dipole 315 is a recalibration.

**Ambient Temperature of the Laboratory:** 22 °C +/- 0.5°C

**Temperature of the Tissue:** 21 °C +/- 0.5°C

## References

SSI-TP-018-ALSAS Dipole Calibration Procedure

SSI-TP-016 Tissue Calibration Procedure

IEEE 1528 “Recommended Practice for Determining the Peak Spatial-Average Specific Absorption Rate (SAR) in the Human Body Due to Wireless Communications Devices: Experimental Techniques”

IEC 62209 “Human exposure to radio frequency fields from hand-held and body-mounted wireless communication devices – Human models, instrumentation, and procedures –Part 1 & Part 2: Procedure to determine the specific absorption rate (SAR) for mobile wireless communication devices used in close proximity to the human body (frequency range of 30 MHz to 6 GHz)”

We the undersigned attest that to the best of our knowledge the calibration of this device has been accurately conducted and that all information contained within this report has been reviewed for accuracy.



-----  
**Stuart Nicol**



-----  
**C. Teodorian**

## Dipole Calibration Results

### Mechanical Verification

<b>IEEE Length</b>	<b>IEEE Height</b>	<b>Measured Length</b>	<b>Measured Height</b>
161.0 mm	89.8 mm	165.0 mm	90.0 mm

### Tissue Validation

<b>Head Tissue 835 MHz</b>	<b>Measured</b>
<b>Dielectric constant, <math>\epsilon_r</math></b>	42.54
<b>Conductivity, <math>\sigma</math> [S/m]</b>	0.91

**Electrical Calibration**

Test Result	
S11 R/L	-32.9 dB
SWR 1.04	U
Impedance	51.1 $\Omega$

The Following Graphs are the results as displayed on the Vector Network Analyzer.

**S11 Parameter Return Loss**

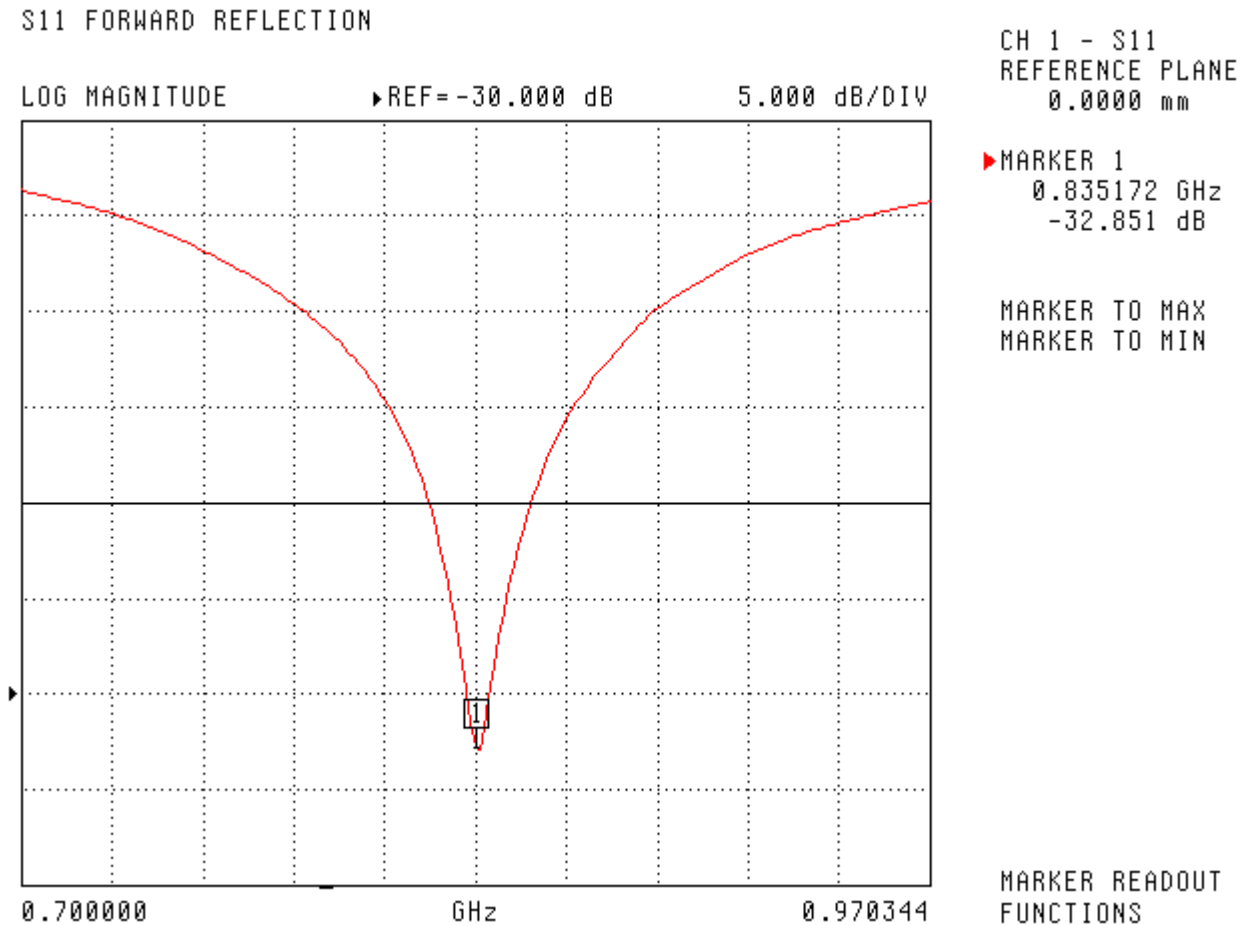

SWR

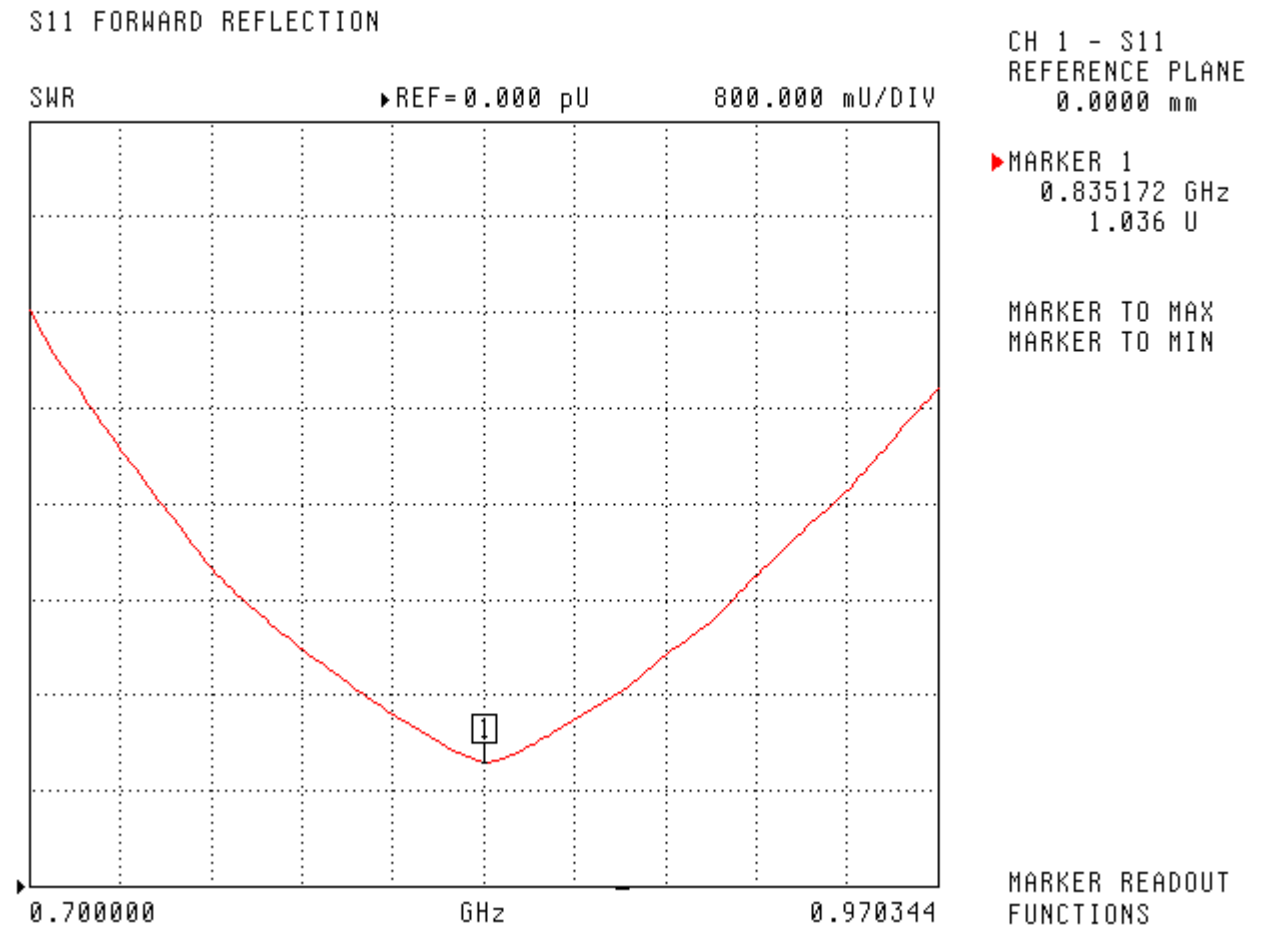



## Smith Chart Dipole Impedance

S11 FORWARD REFLECTION  
IMPEDANCE

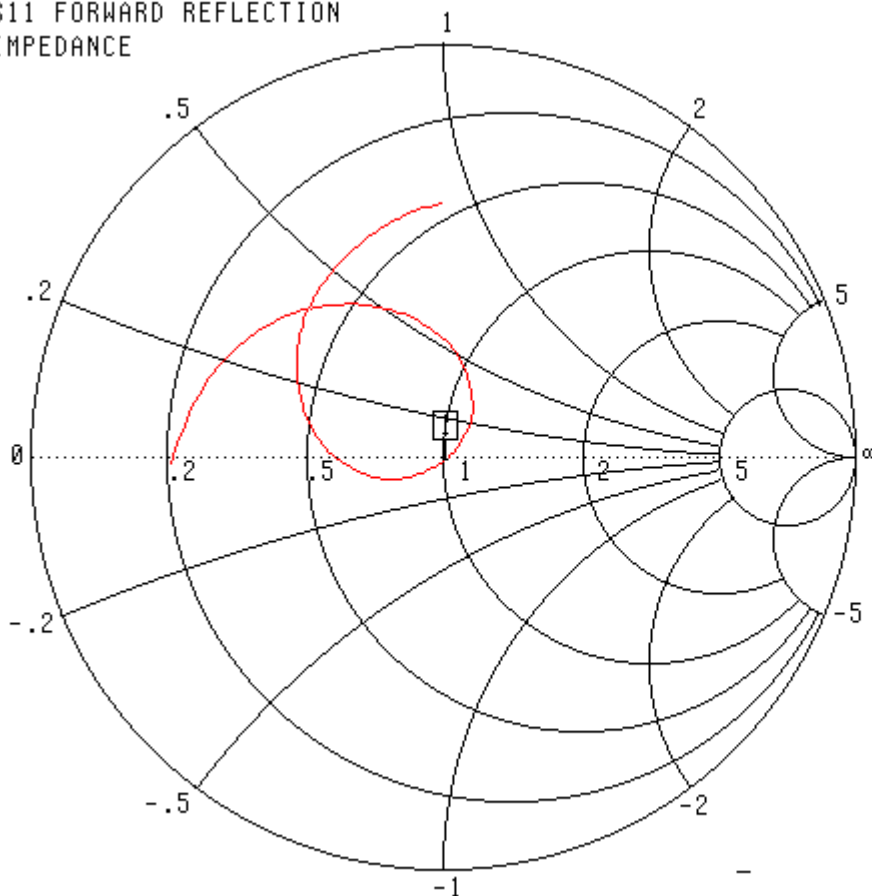

CH 1 - S11  
REFERENCE PLANE  
0.0000 mm

▶ MARKER 1  
0.835172 GHz  
51.124  $\Omega$   
-920.979  $j\Omega$

MARKER TO MAX  
MARKER TO MIN

MARKER READOUT  
FUNCTIONS

0.700000 - 0.970344 GHz

**System Validation Results Using the Electrically Calibrated Dipole**

<b>Head Tissue Frequency</b>	<b>1 Gram</b>	<b>10 Gram</b>	<b>Peak Above Feed Point</b>
835 MHz	9.33W/Kg	6.42W/Kg	15.0W/Kg

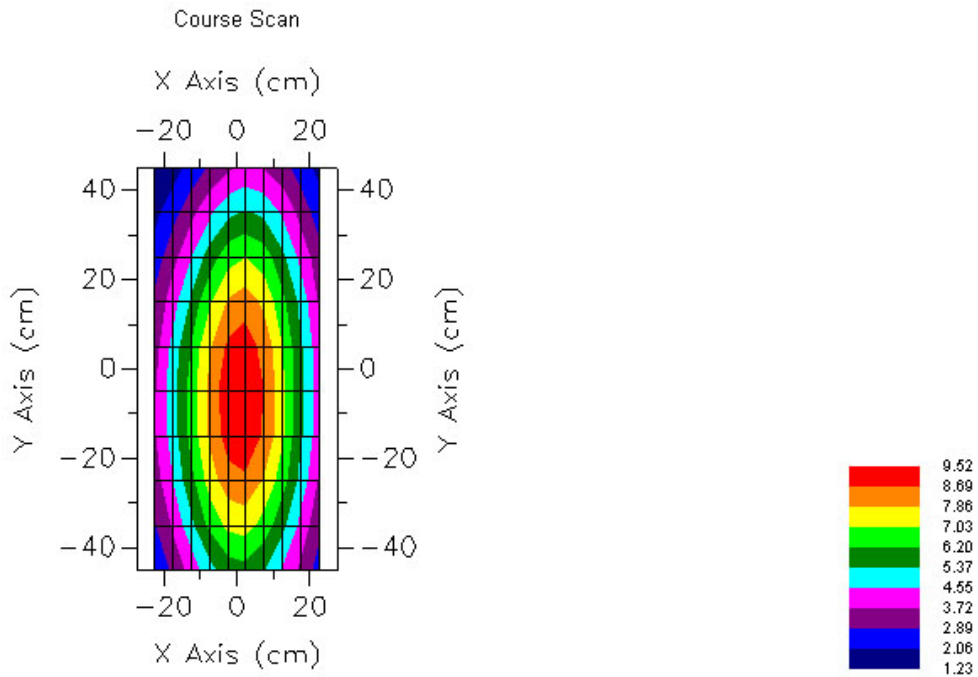

## **Test Equipment**

The test equipment used during Probe Calibration, manufacturer, model number and, current calibration status are listed and located on the main APREL server R:\NCL\Calibration Equipment\Instrument List May 2008.

# NCL CALIBRATION LABORATORIES

Calibration File No: DC-890

## C E R T I F I C A T E   O F   C A L I B R A T I O N

It is certified that the equipment identified below has been calibrated in the  
**NCL CALIBRATION LABORATORIES** by qualified personnel following recognized  
procedures and using transfer standards traceable to NRC/NIST.

Quietek Validation Dipole

Manufacturer: APREL Laboratories

Part number: ALS-D-1900-S-2

Frequency: 1.9 GHz

Serial No: QTK-318

Customer: Quietek

Project Number: QTKB-Dipole-CAL-5336

Calibrated: 9<sup>th</sup> May 2008  
Released on: 9<sup>th</sup> May 2008

This Calibration Certificate is Incomplete Unless Accompanied with the Calibration Results Summary

Released By: \_\_\_\_\_

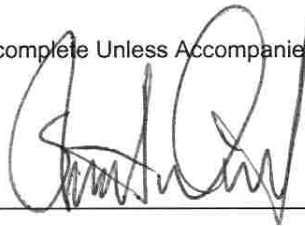

**NCL** CALIBRATION LABORATORIES

51 SPECTRUM WAY  
NEPEAN, ONTARIO  
CANADA K2R 1E6

Division of APREL Lab.  
TEL: (613) 820-4988  
FAX: (613) 820-4161

## Calibration Results Summary

The following results relate the Calibrated Dipole and should be used as a quick reference for the user.

### Mechanical Dimensions

**Length:** 70.0 mm  
**Height:** 39.5 mm

### Electrical Specification

**SWR:** 1.1 U  
**Return Loss:** -25.8 dB  
**Impedance:** 47.8  $\Omega$

### System Validation Results

Frequency	1 Gram	10 Gram	Peak
1.9 GHz	36.0W/Kg	20.78W/Kg	67.7W/Kg

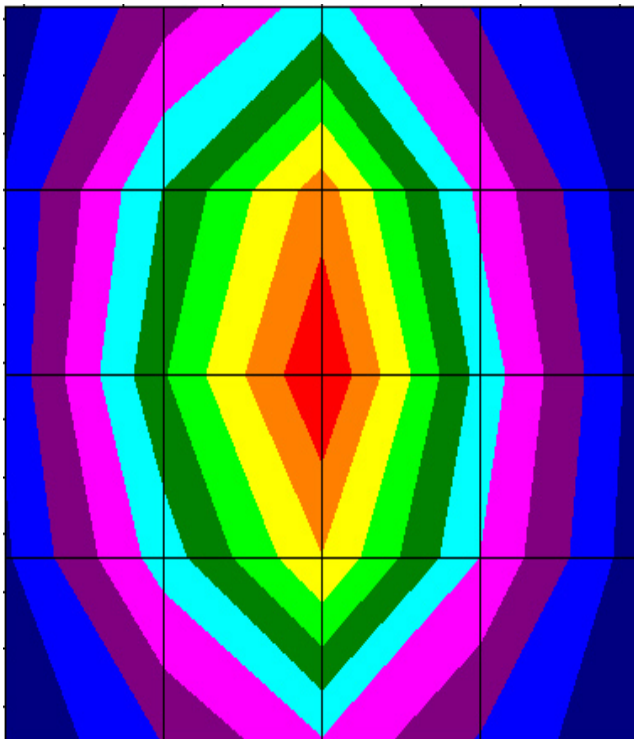

## Conditions

Dipole 318 is a recalibration.

**Ambient Temperature of the Laboratory:** 22 °C +/- 0.5°C  
**Temperature of the Tissue:** 21 °C +/- 0.5°C

## References

SSI-TP-018-ALSAS Dipole Calibration Procedure

SSI-TP-016 Tissue Calibration Procedure

IEEE 1528 "Recommended Practice for Determining the Peak Spatial-Average Specific Absorption Rate (SAR) in the Human Body Due to Wireless Communications Devices: Experimental Techniques"

IEC 62209 "Human exposure to radio frequency fields from hand-held and body-mounted wireless communication devices – Human models, instrumentation, and procedures –Part 1 & Part 2: Procedure to determine the specific absorption rate (SAR) for mobile wireless communication devices used in close proximity to the human body (frequency range of 30 MHz to 6 GHz)

We the undersigned attest that to the best of our knowledge the calibration of this device has been accurately conducted and that all information contained within this report has been reviewed for accuracy.



-----  
**Stuart Nicol**



-----  
**C. Teodorian**

20 °C +/- 0.5°C

**NCL Calibration Laboratories**

Division of APREL Laboratories.

---

## **Dipole Calibration Results**

### **Mechanical Verification**

<b>IEEE Length</b>	<b>IEEE Height</b>	<b>Measured Length</b>	<b>Measured Height</b>
68.0 mm	39.5 mm	70.0 mm	39.5 mm

### **Tissue Validation**

<b>Head Tissue 1900 MHz</b>	<b>Measured</b>
<b>Dielectric constant, <math>\epsilon_r</math></b>	39.9
<b>Conductivity, <math>\sigma</math> [S/m]</b>	1.42



**Electrical Calibration**

Test Result	
S11 R/L	-25.8 dB
SWR 1.1	U
Impedance	47.8 $\Omega$

The Following Graphs are the results as displayed on the Vector Network Analyzer.

**S11 Parameter Return Loss**

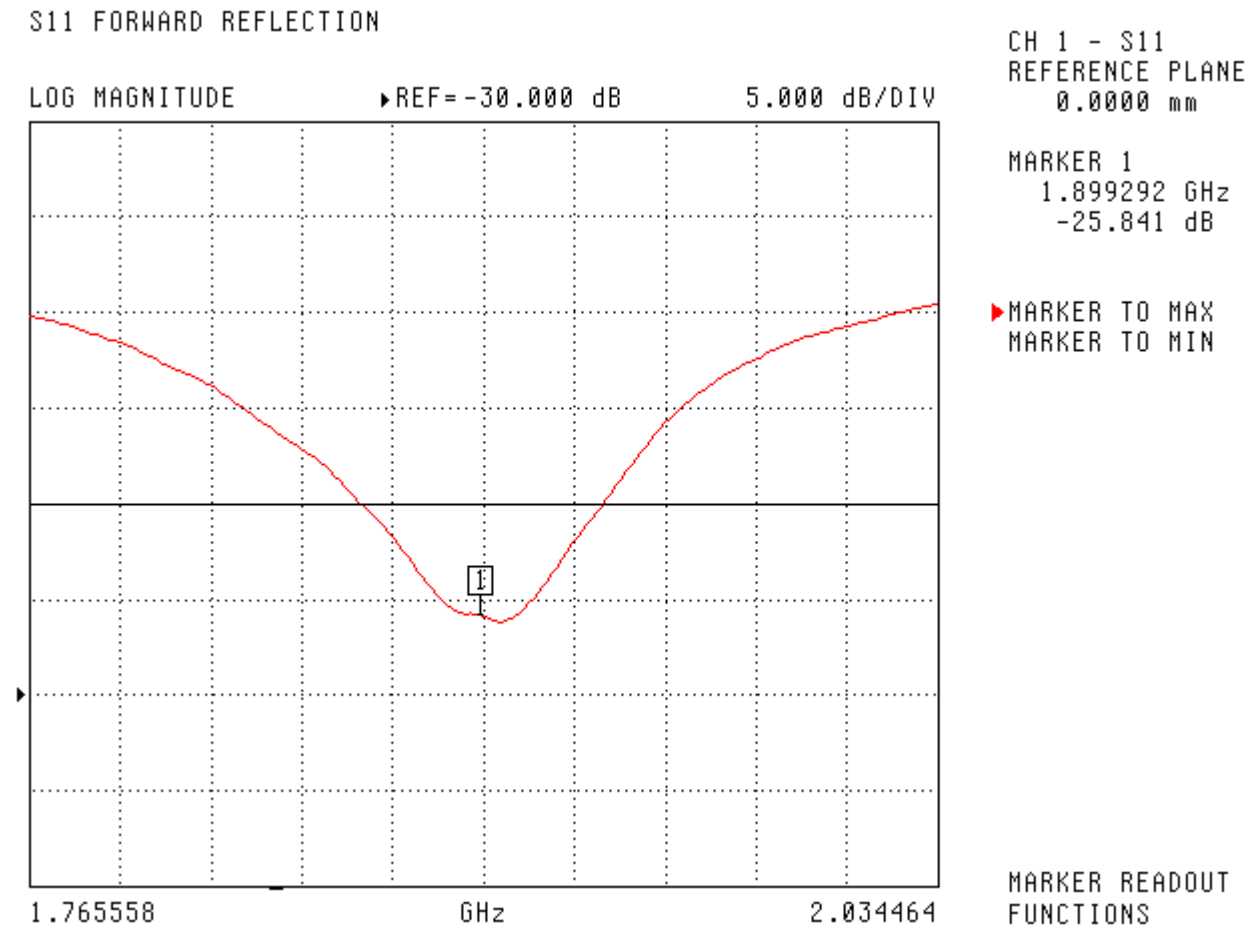

SWR

S11 FORWARD REFLECTION

SWR REF=1.000 U 200.000 mU/DIV

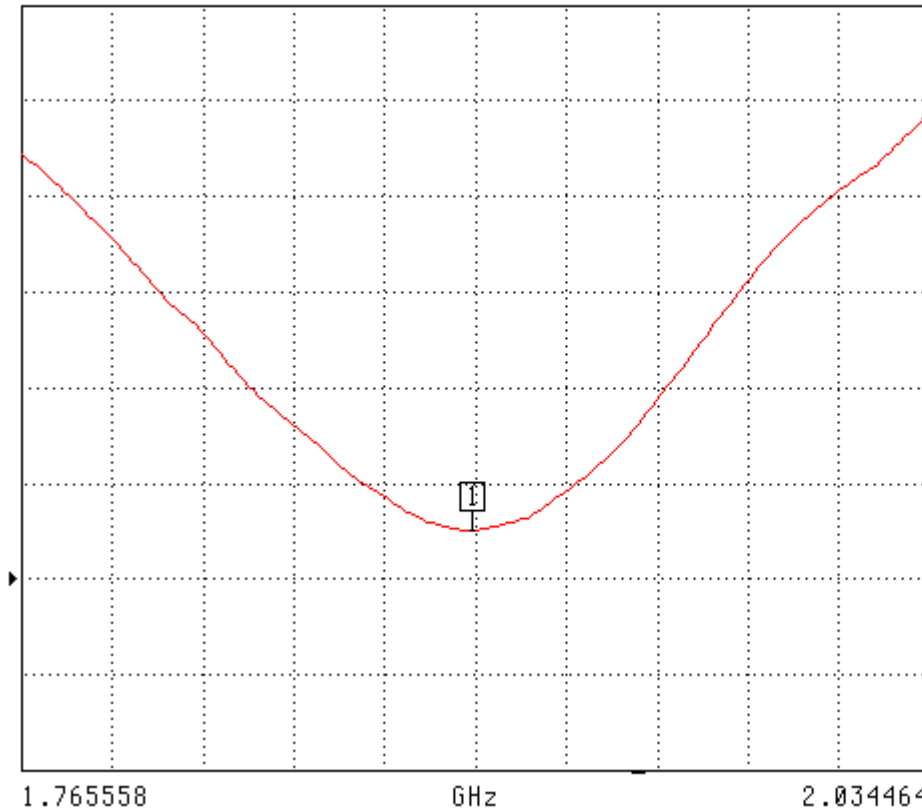

CH 1 - S11  
REFERENCE PLANE  
0.0000 mm

MARKER 1  
1.899292 GHz  
1.101 U

▶ MARKER TO MAX  
MARKER TO MIN

MARKER READOUT  
FUNCTIONS

## Smith Chart Dipole Impedance

S11 FORWARD REFLECTION  
IMPEDANCE

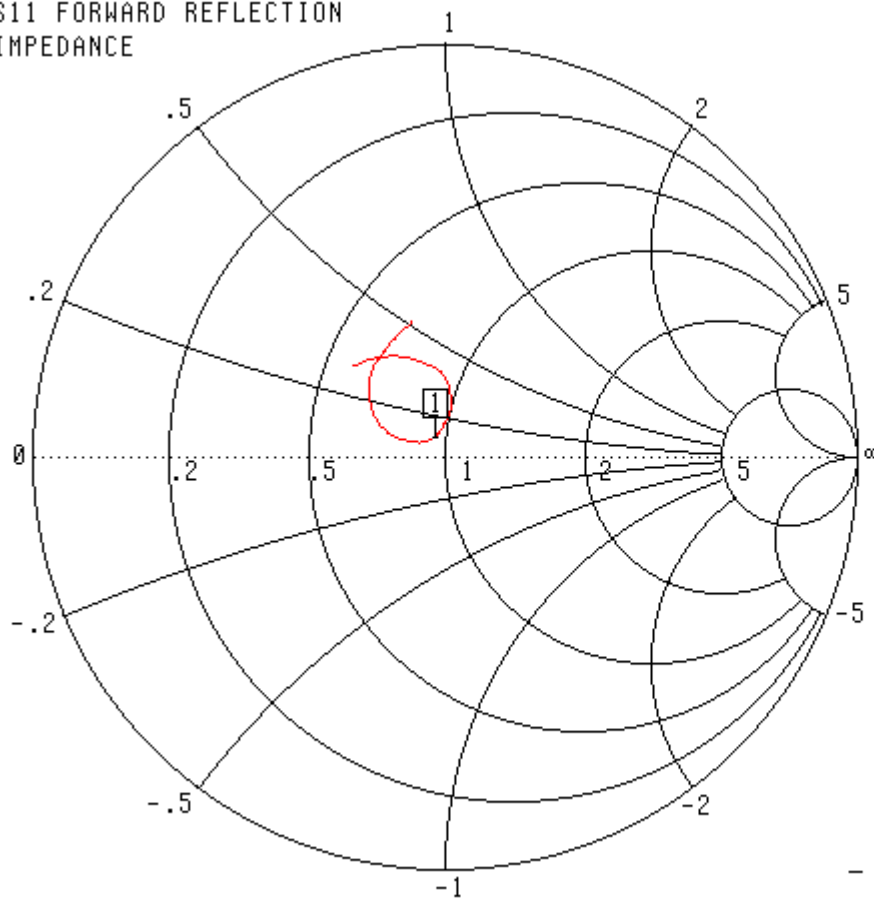

CH 1 - S11  
REFERENCE PLANE  
0.0000 mm

MARKER 1  
1.899292 GHz  
47.748  $\Omega$   
4.401  $j\Omega$

▶ MARKER TO MAX  
MARKER TO MIN

- MARKER READOUT  
FUNCTIONS

1.765558 - 2.034464 GHz

**System Validation Results Using the Electrically Calibrated Dipole**

<b>Frequency</b>	<b>1 Gram</b>	<b>10 Gram</b>	<b>Peak Above Feed Point</b>
1.9 GHz	36.0W/Kg	20.78W/Kg	67.7W/Kg

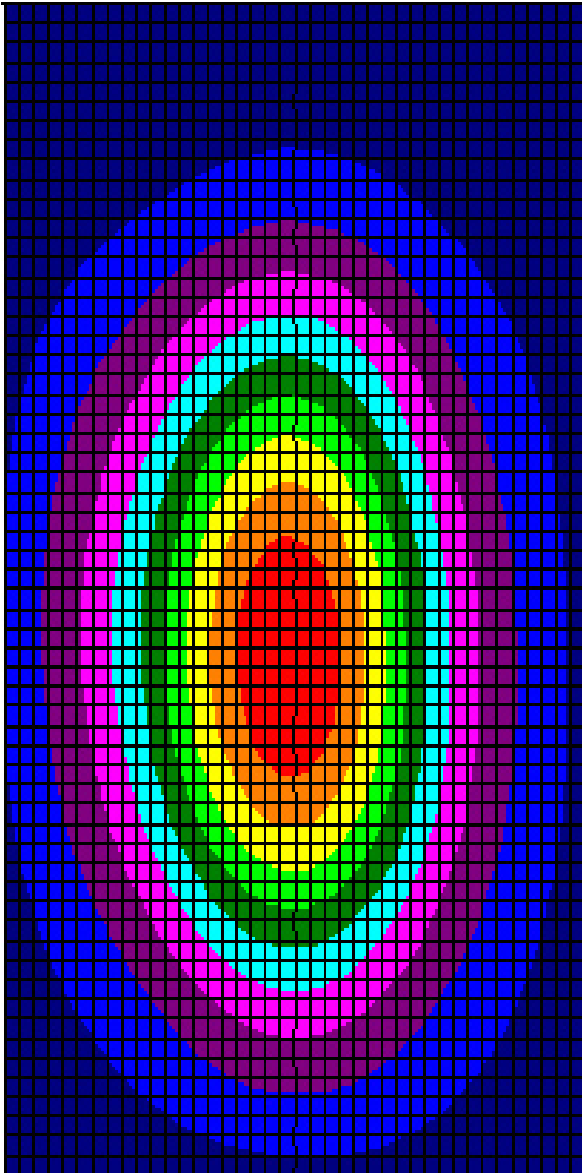

## **Test Equipment**

The test equipment used during Probe Calibration, manufacturer, model number and, current calibration status are listed and located on the main APREL server R:\NCL\Calibration Equipment\Instrument List May 2008.