

Acer OLED Monitor

User's Guide

Copyright © 2022. Acer Incorporated.
All Rights Reserved.

Acer OLED Monitor User's Guide
Original Issue: 04/2022

Changes may be made periodically to the information in this publication without obligation to notify any person of such revisions or changes. Such changes will be incorporated in new editions of this manual or supplementary documents and publications. This company makes no representations or warranties, either expressed or implied, with respect to the contents hereof and specifically disclaims the implied warranties of merchantability or fitness for a particular purpose.

Record the model number, serial number, purchase date and place of purchase information in the space provided below. The serial number and model number are recorded on the label affixed to your computer. All correspondence concerning your unit should include the serial number, model number and purchase information.

No part of this publication may be reproduced, stored in a retrieval system, or transmitted, in any form or by any means, electronically, mechanically, by photocopy, recording or otherwise, without the prior written permission of Acer Incorporated.

Acer OLED Monitor User's Guide

Model number: _____

Serial number: _____

Date of purchase: _____

Place of purchase: _____

Acer and the Acer logo are registered trademarks of AOPEN Incorporated.
Other companies' product names or trademarks are used herein for identification purposes only and belong to their respective companies.

Special notes on OLED monitors

The following are normal with the OLED monitor and do not indicate a problem.

- Due to the nature of the fluorescent light, the screen may flicker during initial use. Turn off the power switch and then turn it on again to make sure the flicker disappears.
- You may find slightly uneven brightness on the screen depending on the desktop pattern you use.
- The OLED screen has 99.99% or more effective pixels. It may include blemishes of 0.01% or less such as a missing pixel or a pixel lit all the time.
- Due to the nature of the OLED screen, an afterimage of the previous screen may remain after switching the image, when the same image is displayed for hours. In this case, the screen is recovered slowly by changing the image or turning off the power switch for a few hours.

Information for Your Safety and Comfort

Safety instructions

Read these instructions carefully. Keep this document for future reference. Follow all warnings and instructions marked on the product.

Cleaning your monitor

Please carefully follow these guidelines when cleaning the monitor:

- Always unplug the monitor before cleaning.
- Use a soft cloth to wipe the screen and cabinet front and sides.

Connecting/disconnecting the device

Observe the following guidelines when connecting and disconnecting power from the OLED monitor:

- Make sure the monitor is attached to its base before connecting the power cord to the AC power outlet.
- Make sure both the OLED monitor and the computer are turned off before connecting any cable or unplugging the power cord.
- If the system has multiple sources of power, disconnect power from the system by unplugging all power cords from the power supplies.

Accessibility

Be sure that the power outlet you plug the power cord into is easily accessible and located as close to the equipment operator as possible. When you need to disconnect power from the equipment, be sure to unplug the power cord from the electrical outlet.

Safe listening

To protect your hearing, follow these instructions.

- Gradually increase the volume until you can hear it clearly and comfortably and without distortion.
- After setting the volume level, do not increase it after your ears have adjusted.
- Limit the amount of time listening to music at high volume.
- Avoid turning up the volume to block out noisy surroundings.
- Turn the volume down if you can't hear people speaking near you.

Warnings

- Do not use this product near water.
- Do not place this product on an unstable cart, stand or table. If the product falls, it could be seriously damaged.
- Slots and openings are provided for ventilation to ensure reliable operation of the product and to protect it from overheating. These openings must not be blocked or covered. The openings should never be blocked by placing the product on a bed, sofa, rug or other similar surface. This product should never be placed near or over a radiator or heat register, or in a built-in installation unless proper ventilation is provided.
- Never push objects of any kind into this product through cabinet slots as they may touch dangerous voltage points or short-out parts that could result in a fire or electric shock. Never spill liquid of any kind onto or into the product.
- To avoid damage of internal components and to prevent battery leakage, do not place the product on a vibrating surface.
- Never use it under sporting, exercising, or any vibrating environment which will probably cause unexpected short current or damage internal devices.

Using electrical power

- This product should be operated from the type of power indicated on the marking label. If you are not sure of the type of power available, consult your dealer or local power company.
- Do not allow anything to rest on the power cord. Do not locate this product where people will walk on the cord.
- If an extension cord is used with this product, make sure that the total ampere rating of the equipment plugged into the extension cord does not exceed the extension cord ampere rating. Also, make sure that the total rating of all products plugged into the wall outlet does not exceed the fuse rating.
- Do not overload a power outlet, strip or receptacle by plugging in too many devices. The overall system load must not exceed 80% of the branch circuit rating. If power strips are used, the load should not exceed 80% of the power strip's input rating.
- This product's power cord is equipped with a three-wire grounded plug. The plug only fits in a grounded power outlet. Make sure the power outlet is properly grounded before inserting the power cord plug. Do not insert the plug into a non-grounded power outlet. Contact your electrician for details.



.....
Warning! The grounding pin is a safety feature. Using a power outlet that is not properly grounded may result in electric shock and/or injury.



.....
Note: The grounding pin also provides good protection from unexpected noise produced by other nearby electrical devices that may interfere with the performance of this product.

Product servicing

Do not attempt to service this product yourself, as opening or removing covers may expose you to dangerous voltage points or other risks. Refer all servicing to qualified service personnel.

Unplug this product from the wall outlet and refer servicing to qualified service personnel when:

- the power cord or plug is damaged, cut or frayed
- liquid was spilled into the product
- the product was exposed to rain or water
- the product has been dropped or the case has been damaged
- the product exhibits a distinct change in performance, indicating a need for service
- the product does not operate normally after following the operating instructions



.....
Note: Adjust only those controls that are covered by the operating instructions, since improper adjustment of other controls may result in damage and will often require extensive work by a qualified technician to restore the product to normal condition.

Potentially explosive environments

Switch off your device in any area with a potentially explosive atmosphere and obey all signs and instructions. Potentially explosive atmospheres include areas where you would normally be advised to turn off your vehicle engine. Sparks in such areas could cause an explosion or fire resulting in bodily injury or even death. Switch off the device near gas pumps at service stations. Observe restrictions on the use of radio equipment in fuel depots, storage and distribution areas; chemical plants; or where blasting operations are in progress. Areas with a potentially explosive atmosphere are often, but not always, marked. They include below deck on boats, chemical transfer or storage facilities, vehicles using liquefied petroleum gas (such as propane or butane), and areas where the air contains chemicals or particles such as grain, dust or metal powders.

Additional safety information

Your device and its enhancements may contain small parts. Keep them out of the reach of small children.

IT Equipment Recycling Information

Acer is strongly committed to environmental protection and views recycling, in the form of salvaging and disposal of used equipment, as one of the company's top priorities in minimizing the burden placed on the environment.

We at Acer are very conscious of the environmental effects of our business and strive to identify and provide the best working procedures to reduce the environmental impact of our products.

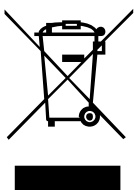

This symbol on the product or on its packaging indicates that this product must not be disposed of with your other household waste. Instead, it is your responsibility to dispose of your waste equipment by handing it over to a designated collection point for the recycling of waste electrical and electronic equipment. The separate collection and recycling of your waste equipment at the time of disposal will help to conserve natural resources and ensure that it is recycled in a manner that protects human health and the environment. For more

information about where you can drop off your waste equipment for recycling, please contact your local city office, your household waste disposal service or the shop where you purchased the product.

Acer monitor is purposed for video and visual display of information obtained from electronic devices.

OLED pixel statement

The OLED unit is produced with high-precision manufacturing techniques. Nevertheless, some pixels may occasionally misfire or appear as black or red dots. This has no effect on the recorded image and does not constitute a malfunction.

This product has been shipped enabled for power management:

- Activate display's Sleep mode within 15 minutes of user inactivity.
- Activate computer's Sleep mode within 30 minutes of user inactivity.
- Wake the computer from Sleep mode by pushing the power button.

Tips and information for comfortable use

Computer users may complain of eyestrain and headaches after prolonged use. Users are also at risk of physical injury after long hours of working in front of a computer. Long work periods, bad posture, poor work habits, stress, inadequate working conditions, personal health and other factors greatly increase the risk of physical injury.

Incorrect computer usage may lead to carpal tunnel syndrome, tendonitis, tenosynovitis or other musculoskeletal disorders. The following symptoms may appear in the hands, wrists, arms, shoulders, neck or back:

- numbness, or a burning or tingling sensation
- aching, soreness or tenderness
- pain, swelling or throbbing
- stiffness or tightness
- coldness or weakness

If you have these symptoms, or any other recurring or persistent discomfort and/or pain related to computer use, consult a physician immediately and inform your company's health and safety department.

The following section provides tips for more comfortable computer use.

Finding your comfort zone

Find your comfort zone by adjusting the viewing angle of the monitor, using a footrest, or raising your sitting height to achieve maximum comfort. Observe the following tips:

- refrain from staying too long in one fixed posture
- avoid slouching forward and/or leaning backward
- stand up and walk around regularly to remove the strain on your leg muscles

Taking care of your vision

Long viewing hours, wearing incorrect glasses or contact lenses, glare, excessive room lighting, poorly focused screens, very small typefaces and low-contrast displays could stress your eyes. The following sections provide suggestions on how to reduce eyestrain.

Eyes

- Rest your eyes frequently.
- Give your eyes regular breaks by looking away from the monitor and focusing on a distant point.
- Blink frequently to keep your eyes from drying out.

Display

- Keep your display clean.
- Keep your head at a higher level than the top edge of the display so your eyes point downward when looking at the middle of the display.
- Adjust the display brightness and/or contrast to a comfortable level for enhanced text readability and graphics clarity.

- Eliminate glare and reflections by:
 - placing your display in such a way that the side faces the window or any light source
 - minimizing room light by using drapes, shades or blinds
 - using a task light
 - changing the display's viewing angle
 - using a glare-reduction filter
 - using a display visor, such as a piece of cardboard extended from the display's top front edge
- Avoid adjusting your display to an awkward viewing angle.
- Avoid looking at bright light sources, such as open windows, for extended periods of time.

Developing good work habits

Develop the following work habits to make your computer use more relaxing and productive:

- Take short breaks regularly and often.
- Perform some stretching exercises.
- Breathe fresh air as often as possible.
- Exercise regularly and maintain a healthy body.
- In order to prevent damage to the monitor, do not lift the monitor by its base.



Declaration of Conformity

We,

Acer Incorporated

8F, 88, Sec. 1, Xintai 5th Rd., Xizhi, New Taipei City 221

And,

Acer Italy s.r.l.

Viale delle Industrie 1/A, 20020 Arese (MI), Italy

Tel: +39-02-939-921, Fax: +39-02 9399-2913

www.acer.it

Product:	OLED Monitor
Trade Name:	Acer
Model Number:	PM168QT
SKU Number:	PM168QT xxxxxx

(“x” = 0~9, a ~ z, A ~ Z, or blank)

We, Acer INC., hereby declare under our sole responsibility that the product described above is in conformity with the relevant Union harmonization legislations as below Directive and following harmonized standards and/or other relevant standards have been applied:

EMC Directive: 2014/30/EU

EN55032:2015+AC:2016 Class B

EN55035: 2017

EN61000-3-2:2014 Class D

EN61000-3-3:2013

LVD Directive: 2014/35/EU

EN 62368-1: 2014+ A11: 2017

RoHS Directive: 2011/65/EU

EN IEC 63000: 2018

ErP Directive: 2009/125/EC

Regulation (EC) No. 1275/ 2008; EN 50564:2011

Year to begin affixing CE marking: 2022.

RU Jan / Sr. Manager
Acer Incorporated (Taipei, Taiwan)

Apr. 13, 2022
Date



Federal Communications Commission Declaration of Conformity



This device complies with Part 15 of the FCC Rules. Operation is subject to the following two conditions: (1) this device may not cause harmful interference, and (2) this device must accept any interference received, including interference that may cause undesired operation.

The following local Manufacturer /Importer is responsible for this declaration:

Product:	OLED Monitor
Brand:	Acer
Model Number:	PM168QT
SKU Number:	PM168QT xxxx (“x” = 0~9, a ~ z, A ~ Z or Blank)
Name of Responsible Party:	Acer America Corporation
Address of Responsible Party:	333 West San Carlos St. Suite 1500 San Jose, CA 95110 U. S. A.
Contact Person:	Acer Representative
Phone No.:	254-298-4000
Fax No.:	254-298-4147

Special notes on OLED monitors	iii
Information for Your Safety and Comfort	iii
Safety instructions	iii
Cleaning your monitor	iii
Connecting/disconnecting the device	iii
Accessibility	iii
Safe listening	iv
Warnings	iv
Using electrical power	iv
Product servicing	v
Potentially explosive environments	v
Additional safety information	vi
IT Equipment Recycling Information	vi
OLED pixel statement	vi
Tips and information for comfortable use	vii
Finding your comfort zone	vii
Taking care of your vision	vii
Developing good work habits	viii
PACKAGE CONTENTS	1
Adjustable base (12.5°~ 45°)	1
Power saving	2
Display Data Channel (DDC)	2
Connector pin assignment	3
Type C (24Pin female connector)	3
Standard timing table	4
Connect the monitor to your computer	5
External controls	6
Using the Shortcut Menu	7
Operational procedures	7
OSD	8
Scene Setting	8
Troubleshooting	12
HDMI/Type-C model	12

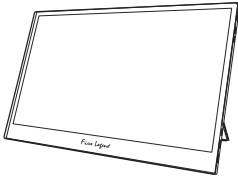
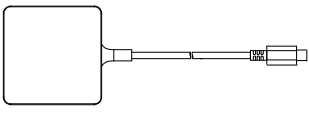
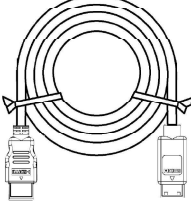
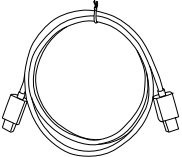
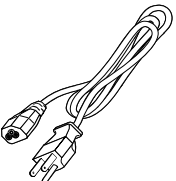
PACKAGE CONTENTS

monitor	Adapter	MINI HDMI Cable (Optional)	Type-C cable (Optional)
			
Power Cord (Optional)		Quick start guide	
		 <p data-bbox="571 788 737 1034"> acer Portable Monitor NITRO TM16 Series/ PM1650T USER GUIDE </p>	

Please make sure to use the original Acer accessory. In order to preserve the quality-aspects.

Adjustable base (12.5°~ 45°)

1. Take out the monitor from the packaging and place it on a stable and level workspace.
2. Open or close the base. The viewing angle of the monitor can be adjusted using the stand. (As shown below, Adjustable Angle 12.5°~ 45°)

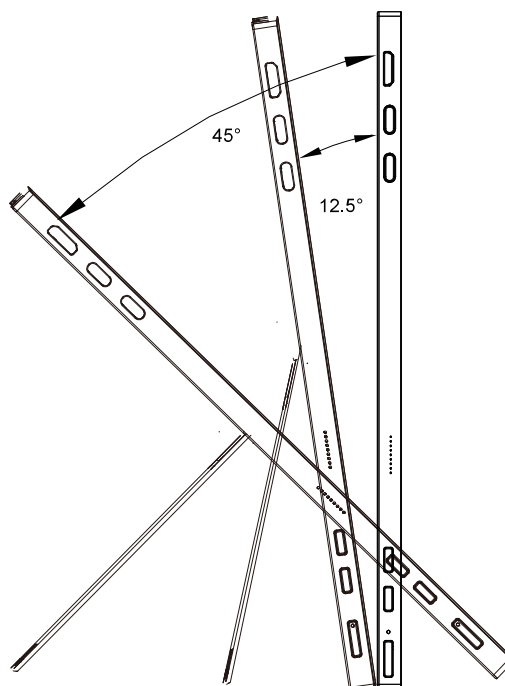

Power saving

The monitor will be switched to "power saving" mode by the control signal from the display controller, as indicated by the orange-colored power LED.

Model	LED light
On	White
Power saving	orange

The power saving mode will be kept until a control signal has been detected or the keyboard or mouse is activated. The recovery time from "power saving" mode back to "on" is around 3 seconds.

Display Data Channel (DDC)

To make installation easier, so long as your system supports the DDC protocol, the monitor is able to plug-and-play. The DDC is a communication protocol through which the monitor automatically informs the host system about its capabilities; for example, supported resolutions and corresponding timing. The monitor supports the DDC2B standard.

Connector pin assignment

English

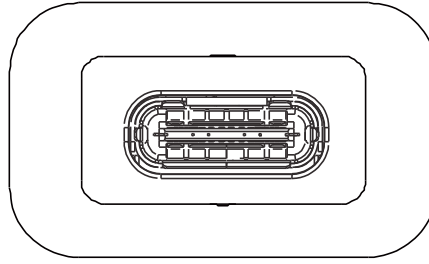

Type C (24Pin female connector)

A1	GND	B1	GND
A2	TX1+	B2	TX2+
A3	TX1-	B3	TX2-
A4	VBUS	B4	VBUS
A5	CC	B5	CONN
A6	D+	B6	
A7	D-	B7	
A8	SBU1	B8	DBU2
A9	VBUS	B9	VBUS
A10	RX-2	B10	RX-1
A11	RX2+	B11	RX+1
A12	GND	B12	GND

19-Pin Color Display Signal Cable*

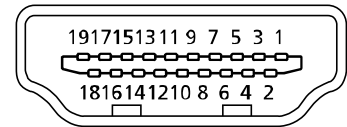

PIN	Meaning	PIN	Meaning
1.	TMDS Data2+	10.	TMDS Clock+
2.	TMDS Data2 Shield	11.	TMDS Clock Shield
3.	TMDS Data2-	12.	TMDS Clock-
4.	TMDS Data1+	13.	CEC
5.	TMDS Data1 Shield	14.	Reserved (N.C. on device)
6.	TMDS Data1-	15.	SCL
7.	TMDS Data0+	16.	SDA
8.	TMDS Data0 Shield	17.	DDC/CEC Ground
9.	TMDS Data0-	18.	+5V Power
		19.	Hot Plug Detect

Standard timing table

Mode		Resolution		
1	VGA	640×480	60	Hz
2	VGA	640×480	70	Hz
3	VGA	640×480	75	Hz
4	VESA	720×400	70	Hz
5	SVGA	800×600	60	Hz
6	SVGA	800×600	75	Hz
7	MAC	832×764	75	Hz
8	XGA	1024×768	60	Hz
9	XGA	1024×768	75	Hz
10	MAC	1152×870	75	Hz
11	MAC	1280×960	60	Hz
12	SXGA	1280×1024	60	Hz
13	SXGA	1280×1024	75	Hz
14	VESA	1280×720	60	Hz
15	WXGA+	1400×900	60	Hz
16	WXGA+	1600×900	60	Hz
17	WSXGA+	1680×1050	60	Hz
18	UXGA	1920×1080	60	Hz

Connect the monitor to your computer

Type C Connection

Connecting Your Monitor to a Computer

1. Plug the power cords of you monitor into a nearby electrical outlet.
2. Use the adapter to connect to the monitor's Type-C port 1 or 2.
3. Connect the Type-C cable to the another Type-C port.

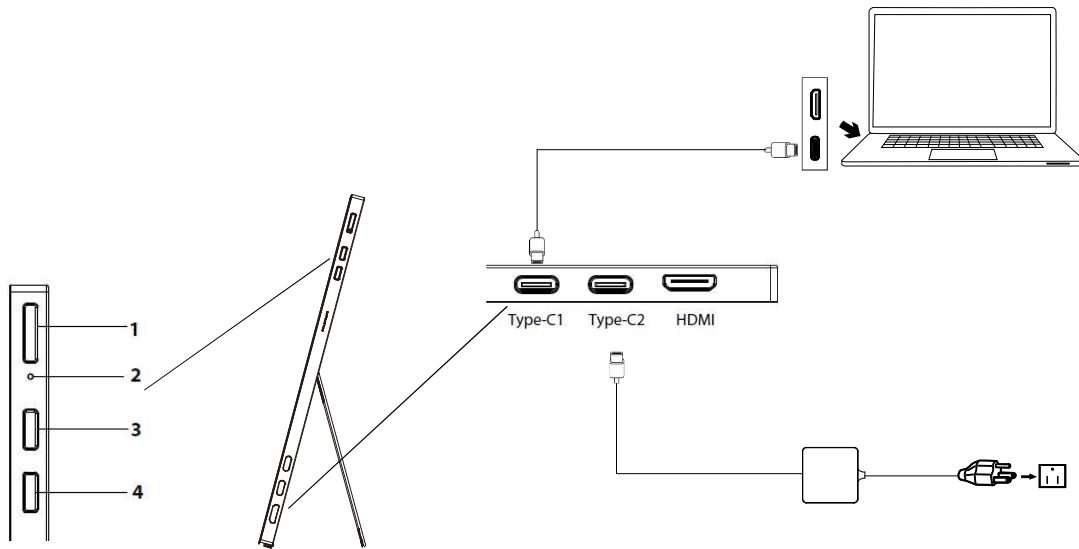

Please make sure your device (mobile/PC) has a Type-C port supporting video-out (DP ALT) when extending your display.

Mini HDMI Connection

1. Plug the power cords of you monitor into a nearby electrical outlet.
2. se the adapter to connect to the monitor's Type-C port 1 or 2.
3. Connect the MiniHDMI to HDMI cable to the computer or Notebook

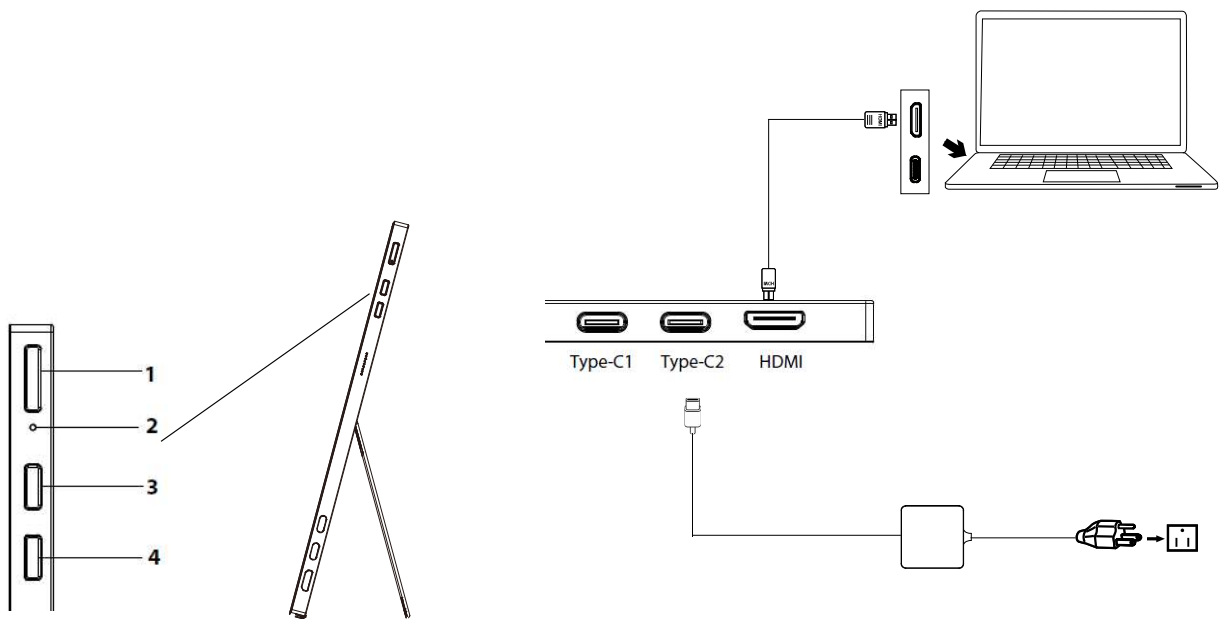

*Please make sure to use the original Acer accessory .In order to preserve the quality-aspects.

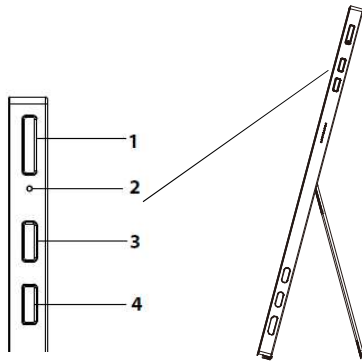

Please make sure your device (mobile/PC) has a Type-C port supporting video-out (DP ALT) when extending your display.

External controls

No.	Icon	Item	Description
1	⏻	Power /Menu	<ul style="list-style-type: none"> a. Long press for 5 sec to turn on/off Monitor. b. Press the MENU key to display the OSD menu and enter the next menu c. Press and hold for 1s to return to the previous layer of the OSD
2	●	LED Indicator	White indicates power on. Orange indicates standby mode.
3	^	UP/Brightness	<ul style="list-style-type: none"> a.Press the UP button to shown Brightness Hot key, press again to adjust value b.Press UP and Down to select the desired item when in OSD menu.
4	∨	DOWN/Volume	<ul style="list-style-type: none"> a.Press the Down button to shown Volume Hot key, press again to adjust value b.Press UP and Down to select the desired item when in OSD menu.

Using the Shortcut Menu

The following content is for general reference only. Actual product specifications may vary. The OSD can be used for adjusting the settings of your OLED Monitor. Press the Any key to open the Navigation OSD. You can use the OSD to adjust the picture quality, OSD setting and general settings. For advanced settings, please refer to following page:

Hot key1 -Brightness



1. Display Brightness management OSD, when users press “UP” button.
2. The default value is 50, an increase or decrease for each of 1 adjustment
3. The default brightness is 5 in the one-line communication state



Note: Adjusts the balance between light and dark . Adjust the brightness from 0 to 100.

Hot Key 2 – Volume

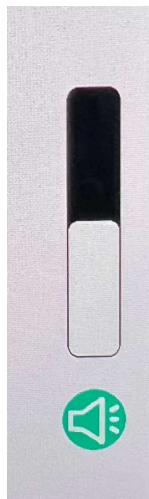

1. Display volume management OSD, when users press “DOWN” button.
2. The default value is 50, an increase or decrease for each of 1 adjustment
3. The default Volume is 30 in the one-line communication state

OSD

Adjusting the Picture

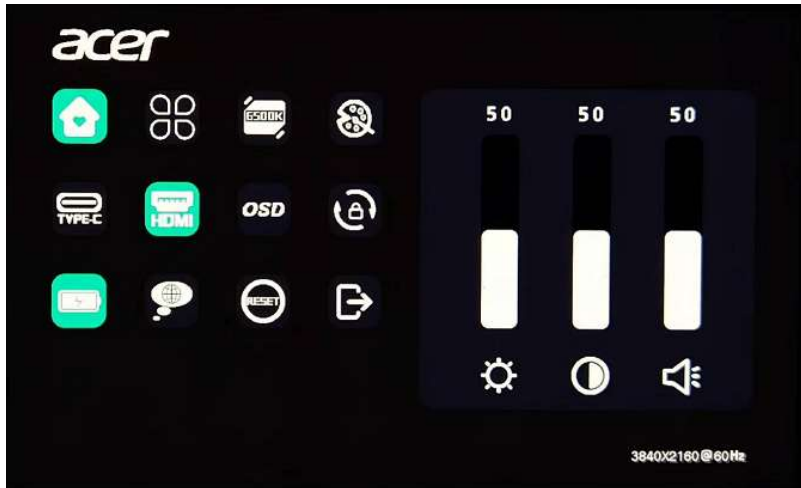

1. Press the MENU key to open the OSD.
2. Toggle the button to the up or down to select Home from the OSD. Then toggle to the right to navigate to the element you wish to adjust and press the button to enter it.
3. Toggle to the up or down to adjust the sliding scales.
4. The Home menu can be used to adjust the Brightness, Contrast, Volume
5. Brightness: Adjust the brightness from 0 to 100.



Note: Adjusts the balance between light and dark shades.

6. Contrast: Adjust the contrast from 0 to 100.



-Note: Sets the degree of difference between light and dark areas.

7. Volume: Adjust the volume

Adjusting the Mode

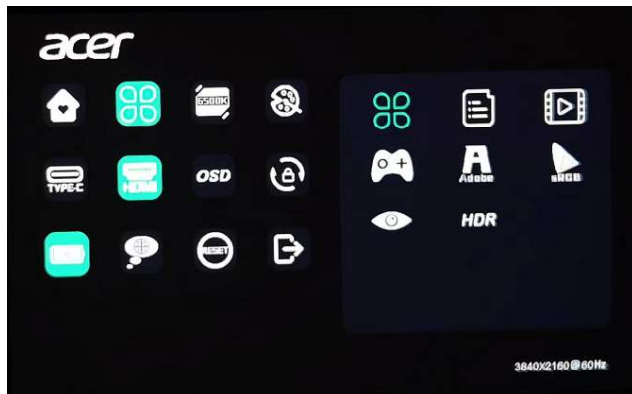

1. Press the MENU key to open the OSD.
2. Toggle the button to the up or down to select Mode from the OSD. Then toggle to the right to navigate to the element you wish to adjust and press the button to enter it.
3. Toggle to the up or down to adjust the sliding scales.
4. Modes: You can choose Custom, Text, Movie, Game, Adobe, sRGB, Eye protection, HDR
5. Custom: Brightness and contrast can be adjusted in this mode
6. Text: Reading books does not strain the eyes easily
7. Movie: The colors are more realistic and the visual effect is better
8. Game: High brightness and contrast, better game experience
9. Adobe: This mode is compatible with Adobe RGB
10. sRGB: Adobe 72% NTSC color
11. Eye protection: Reduce the blue light and brightness, effectively protect the eyes
12. HDR: Turn HDR off, Auto or VESA HDR Trueblack. The default is off. Select Auto enables this function to automatically detect and process HDR signal.

Adjusting the Color Temp.

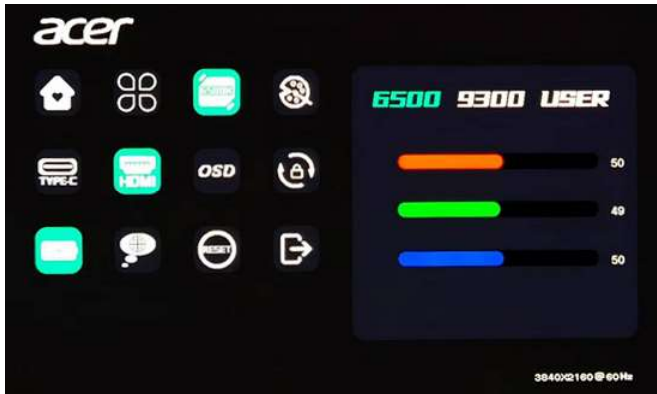

1. Press the MENU key to open the OSD.
2. Toggle the button to the up or down to select Color Temp from the OSD.
3. Toggle to the up or down to adjust the sliding scales.
4. Color temperature: Default is warm. You can choose 6500, 9300 or User.
5. R: R (black level) detail adjustment, from 0 to 100 (Default value is 50),
6. G: G (black level) detail adjustment, from 0 to 100 (Default value is 50),
7. B: B (black level) detail adjustment, from 0 to 100 (Default value is 50).

Adjusting the Color



1. Press the MENU key to open the OSD.
2. Toggle the button to the up or down to select Color from the OSD
3. Toggle to the up or down to adjust the sliding scales.
4. Hue: Adjust the color of the picture to make it more real Adjust the Hue level from 0 to 100 (Default value is 50),.
5. Saturation: Set the brightness of color Adjust the Saturation level from 0 to 100 (Default value is 50),
6. Sharpness: Adjust the value, make the picture clearer Adjust the Sharpness level from 0 to 10 (Default value is 5)

Adjusting the Input

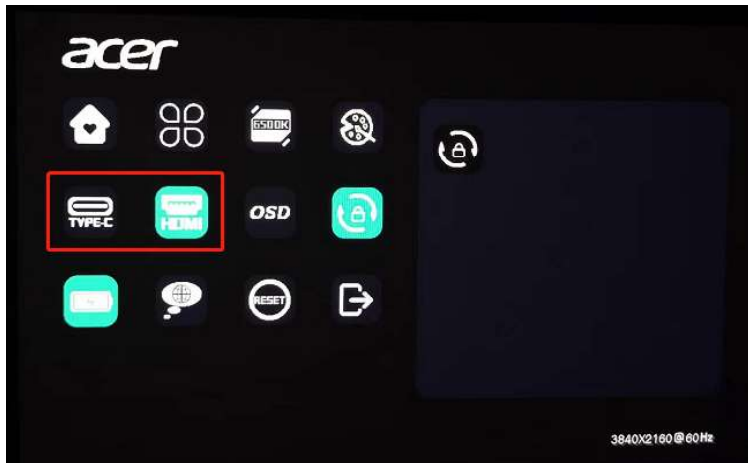

1. Press the MENU key to open the OSD.
2. Toggle the button to the up or down to select Input from the OSD.
3. Input: Select the source from Type-C, MiniHDMI

Adjusting the OSD



1. Press the MENU key to open the OSD.
2. Toggle the button to the up or down to select Mode from the OSD. Then toggle to the right to navigate to the element you wish to adjust and press the button to enter it.
3. Toggle to the up or down to adjust the sliding scales.
4. OSD timeout: Adjust the delay before turning off the OSD menu.
5. OSD menu transparency: Adjust the OSD menu transparency from 0 to 10. 10 is not 100% transparency, default: 0

Adjusting the Gravity sensor

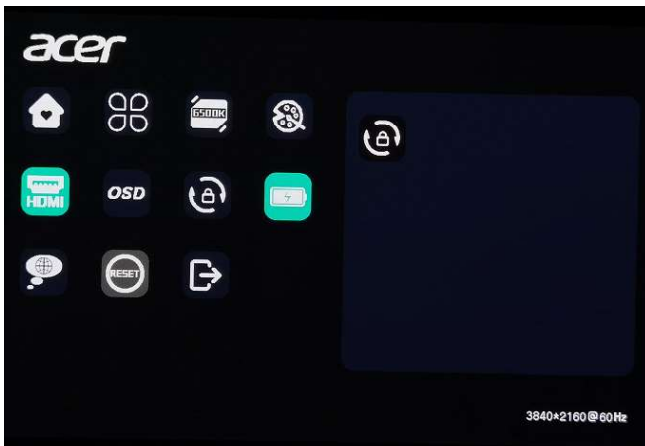

1. Press the MENU key to open the OSD.
2. Toggle the button to the up or down to select Gravity sensor from the OSD. Then toggle to the right to navigate to the element you wish to adjust and press the button to enter it.
3. Toggle to the up or down to adjust the sliding scales.
4. Default: Locked, can not rotate.
5. HDMI mode: Rotation unlocked, 360° horizontal and vertical rotation.
6. Type-C mode : Rotation unlocked, select android or Windows device 360° horizontal and vertical rotation.

Adjusting the Language

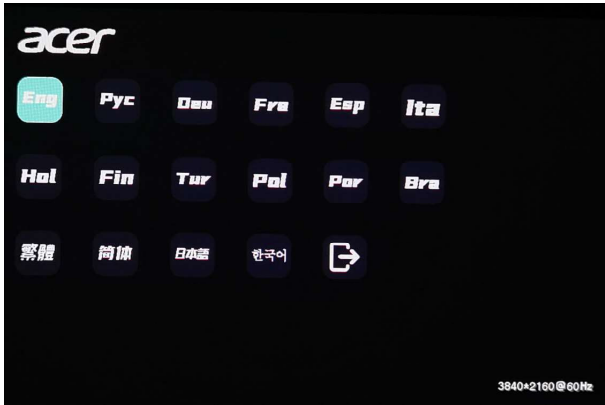

1. Press the MENU key to open the OSD.
2. Toggle the button to the up or down to select Gravity sensor from the OSD. Then toggle to the right to navigate to the element you wish to adjust and press the button to enter it.
3. Toggle to the up or down to adjust the sliding scales.
4. Language: Set the OSD menu language. Default: ENGLISH.
Language differs only within warning menu descriptions

Adjusting the Reset

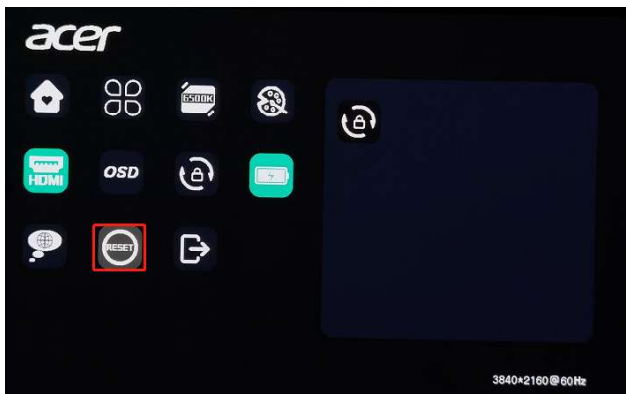

1. Press the MENU key to open the OSD.
2. Toggle the button to the up or down to select Gravity sensor from the OSD. Then toggle to the right to navigate to the element you wish to adjust and press the button to enter it.
3. Toggle to the up or down to adjust the sliding scales.
4. Reset: Reset all settings to the factory defaults.

Troubleshooting

Before sending your OLED monitor for servicing, please check the troubleshooting list below to see if you can self-diagnose the problem.

HDMI/Type-C model

Problem	LED status	Remedy
No Picture	White	Using the OSD, adjust brightness and contrast to maximum or reset to their default settings.
	Off	Check the power switch Long press 5S to start the machine. Check if the power cord is properly connected to the monitor.
	Orange	Check if the video signal cable is properly connected at the back of monitor. Check if the computer system is switched on and in power saving/standby mode.
Unstable picture		Check if the specification of graphics adapter and monitor is in compliance which may be causing the input signal frequency mismatch.
Abnormal picture	Image is missing, off-center, too large or too small on the screen.	Check the display setting on your system. In case of a missing image, please select another resolution or vertical refresh rate. Wait for a few seconds after adjusting the size of the image before changing or disconnecting the signal cable or switching off the monitor.

Note: Acer monitor is purposed for video and visual display of information obtained from electronic devices.

