

# Acer Liquid Metal (S120)

## User Guide

© 2010 All Rights Reserved

Acer Liquid Metal (S120) User Guide

First issue: 10/2010

Acer Liquid Metal (S120) Smartphone

Model number: \_\_\_\_\_

Serial number: \_\_\_\_\_

Date of purchase: \_\_\_\_\_

Place of purchase: \_\_\_\_\_

# End User License Agreement

---

IMPORTANT - READ CAREFULLY: THIS END USER LICENSE AGREEMENT ("AGREEMENT") IS A LEGAL AGREEMENT BETWEEN YOU (EITHER AN INDIVIDUAL OR A SINGLE ENTITY), AND ACER INC. INCLUDING ITS SUBSIDIARIES ("ACER") FOR THE SOFTWARE (WHETHER PROVIDED BY ACER OR BY ACER'S LICENSORS OR SUPPLIERS) THAT ACCOMPANIES THIS AGREEMENT, INCLUDING ANY ASSOCIATED MEDIA, PRINTED MATERIALS AND RELATED USER ELECTRONIC DOCUMENTATION WHICH MAY BE BRANDED "ACER" ("SOFTWARE"). AGREEMENTS RELATING TO ANY OTHER PRODUCT OR TOPIC ARE NEITHER INTENDED NOR SHOULD THEY BE IMPLIED. BY INSTALLING THE ACCOMPANYING SOFTWARE OR ANY PORTION THEREOF, YOU AGREE TO BE BOUND BY THE TERMS AND CONDITIONS OF THIS AGREEMENT. IF YOU DO NOT AGREE TO ALL OF THE TERMS AND CONDITIONS OF THIS AGREEMENT, DO NOT CONTINUE THE INSTALLATION PROCESS AND IMMEDIATELY DELETE ALL INSTALLED FILES, IF ANY, OF THE ACCOMPANYING SOFTWARE FROM YOUR PHONE.

IF YOU DO NOT HAVE A VALIDLY-LICENSED COPY OF THE APPLICABLE SOFTWARE, YOU ARE NOT AUTHORIZED TO INSTALL, COPY OR OTHERWISE USE THE SOFTWARE, AND HAVE NO RIGHTS UNDER THIS AGREEMENT.

The Software is protected by U.S. and international copyright laws and conventions as well as other intellectual property laws and treaties. The Software is licensed, not sold.

## GRANT OF LICENSE

Acer grants to you the following non-exclusive and non-transferable rights with respect to the Software. Under this Agreement, you may:

1. Install and use the Software only on a single designated phone. A separate license is required for each phone on which the Software will be used;
2. Make one copy of the Software solely for backup or archival purposes;
3. Make one hardcopy of any electronic documents included in the Software, provided that you receive the documents electronically.

## RESTRICTIONS

You may NOT:

1. Use or copy the Software except as provided in this Agreement;
2. Rent or lease the Software to any third party;
3. Modify, adapt, or translate the Software in whole or in part;
4. Reverse engineer, decompile, or disassemble the Software or create derivative works based upon the Software;
5. Merge the Software with any other program or modify the Software, except for your personal use; and
6. Sublicense or otherwise make the Software available to third parties, except that you may, after prior written notification to Acer, transfer the Software as a whole to a third party so long as you do not retain any copies of the Software and such third party accepts the terms of this Agreement.
7. Transfer your rights under this Agreement to any third parties.
8. Export the Software in contravention of applicable export laws and regulations, or (i) sell, export, re-export, transfer, divert, disclose technical data, or dispose of, any Software to any prohibited person, entity, or destination including, without limitation, Cuba, Iran, North Korea, Sudan and Syria; or (ii) use any Software for any use prohibited by the laws or regulations of the United States.

## SUPPORT SERVICES

Acer is not obligated to provide technical or other support for the Software.

## ACER LIVE UPDATE

Certain of the software contains elements that enable the use of the Acer Live Update service, which allows for updates for such software to be automatically downloaded and installed on your phone. By installing the software, you hereby agree and consent that Acer (or its licensors) may automatically check the version of such software that you are using on your phone and may provide upgrades to such software that may be automatically downloaded on to your phone.

## OWNERSHIP AND COPYRIGHT

Title, ownership rights and intellectual property rights in and to the Software and all copies thereof shall remain with Acer or Acer's licensors or suppliers (as applicable). You do not have or shall not gain any proprietary interest in the Software (including any modifications or copies made by or for you) or any related intellectual property rights. Title and related rights in the content accessed through the Software is the property of the applicable content owner and may be protected by applicable law. This license gives you no rights to such contents. You hereby agree

1. Not to remove any copyright or other proprietary notices from the Software;
2. To reproduce all such notices on any authorized copies you make; and
3. To use best efforts to prevent any unauthorized copying of the Software.

## TRADEMARKS

This Agreement does not grant to you any rights in connection with any trademarks or service marks of Acer or of Acer's licensors or suppliers.

## DISCLAIMER OF WARRANTIES

TO THE MAXIMUM EXTENT PERMITTED BY APPLICABLE LAW, ACER, ITS SUPPLIERS, AND ITS LICENSORS, PROVIDE THE SOFTWARE "AS IS" AND WITH ALL FAULTS, AND HEREBY DISCLAIM ALL OTHER WARRANTIES AND CONDITIONS, EITHER EXPRESS, IMPLIED OR STATUTORY, INCLUDING, BUT NOT LIMITED TO, ANY IMPLIED WARRANTIES, DUTIES OR CONDITIONS OF MERCHANTABILITY, OF FITNESS FOR A PARTICULAR PURPOSE, OF ACCURACY OR COMPLETENESS OF RESPONSES, OF RESULTS, OF WORKMANLIKE EFFORT, OF LACK OF VIRUSES, AND OF LACK OF NEGLIGENCE, ALL WITH REGARD TO THE SOFTWARE AND THE PROVISION OF OR FAILURE TO PROVIDE SUPPORT SERVICES. ALSO, THERE IS NO

WARRANTY OR CONDITION OF TITLE, QUIET ENJOYMENT, QUIET POSSESSION, CORRESPONDENCE TO DESCRIPTION OR NON-INFRINGEMENT WITH REGARD TO THE SOFTWARE.

#### EXCLUSION OF INCIDENTAL, CONSEQUENTIAL AND CERTAIN OTHER DAMAGES

TO THE MAXIMUM EXTENT PERMITTED BY APPLICABLE LAW, IN NO EVENT SHALL ACER, ACER'S SUPPLIERS, OR ACER'S LICENSORS, BE LIABLE FOR ANY SPECIAL, INCIDENTAL, INDIRECT, PUNITIVE, OR CONSEQUENTIAL DAMAGES WHATSOEVER (INCLUDING, BUT NOT LIMITED TO, DAMAGES FOR LOSS OF PROFITS OR CONFIDENTIAL OR OTHER INFORMATION, FOR BUSINESS INTERRUPTION, FOR PERSONAL INJURY, FOR LOSS OF PRIVACY, FOR FAILURE TO MEET ANY DUTY INCLUDING OF GOOD FAITH OR OF REASONABLE CARE, FOR NEGLIGENCE, AND FOR ANY OTHER PECUNIARY OR OTHER LOSS WHATSOEVER) ARISING OUT OF OR IN ANY WAY RELATED TO THE USE OF OR INABILITY TO USE THE SOFTWARE, THE PROVISION OF OR FAILURE TO PROVIDE SUPPORT SERVICES, OR OTHERWISE UNDER OR IN CONNECTION WITH ANY PROVISION OF THIS AGREEMENT, EVEN IN THE EVENT OF THE FAULT, TORT (INCLUDING NEGLIGENCE), STRICT LIABILITY, BREACH OF CONTRACT OR BREACH OF WARRANTY OF ACER OR ITS SUPPLIERS OR LICENSORS, AND EVEN IF ACER AND ITS SUPPLIERS AND LICENSORS HAVE BEEN ADVISED OF THE POSSIBILITY OF SUCH DAMAGES.

#### LIMITATION OF LIABILITY AND REMEDIES

NOTWITHSTANDING ANY DAMAGES THAT YOU MIGHT INCUR FOR ANY REASON WHATSOEVER (INCLUDING, WITHOUT LIMITATION, ALL DAMAGES REFERENCED ABOVE AND ALL DIRECT OR GENERAL DAMAGES), THE ENTIRE LIABILITY OF ACER, ITS SUPPLIERS, AND ITS LICENSORS, UNDER ANY PROVISION OF THIS AGREEMENT, AND YOUR EXCLUSIVE REMEDY FOR ALL OF THE FOREGOING, SHALL BE LIMITED TO THE AGGREGATE AMOUNT PAID BY YOU FOR THE SOFTWARE. THE FOREGOING LIMITATIONS, EXCLUSIONS AND DISCLAIMERS (INCLUDING DISCLAIMER OF WARRANTIES AND EXCLUSION OF INCIDENTAL, CONSEQUENTIAL AND CERTAIN OTHER DAMAGES ABOVE) SHALL APPLY TO THE MAXIMUM EXTENT PERMITTED BY APPLICABLE LAW, EVEN IF ANY REMEDY FAILS ITS ESSENTIAL PURPOSE; PROVIDED, HOWEVER, THAT BECAUSE SOME JURISDICTIONS DO NOT ALLOW THE EXCLUSION OR LIMITATION OR LIABILITY FOR CONSEQUENTIAL OR INCIDENTAL DAMAGES, THE ABOVE LIMITATION MAY NOT APPLY TO YOU.

#### TERMINATION

Without prejudice to any other rights, Acer may immediately terminate this Agreement without notice if you fail to comply with any terms and conditions of this Agreement.

In such event, you must:

1. Cease all use of the Software;
2. Destroy or return to Acer the original and all copies of the Software; and
3. Delete the Software from all phones on which it was resident.

All disclaimers of warranties and limitation of liability set forth in this Agreement shall survive termination of this Agreement.

#### GENERAL

This Agreement represents the complete agreement between you and Acer relating to this license for the Software and supersedes all prior agreements, communications, proposals and representations between the parties and prevails over any conflicting or additional terms of any quote, order, acknowledgement or similar communication. This Agreement may only be modified by a written document signed by both parties. If any provision of this Agreement is held by a court of competent jurisdiction to be contrary to law that provision will be enforced to the maximum extent permissible and the remaining provisions of this Agreement will remain in full force and effect.

#### ADDITIONAL PROVISIONS APPLICABLE TO THIRD PARTY SOFTWARE AND SERVICES

Software provided hereunder by Acer's licensors or suppliers ("Third Party Software") is made available to you for your personal, non-commercial use only. You may not use the Third Party Software in any manner that could damage, disable, overburden, or impair the services provided by Acer's licensors or suppliers hereunder ("Third Party Services"). Furthermore, you may not use the Third Party Software in any manner that could interfere with any other party's use and enjoyment of the Third Party Services, or the services and products of Acer's licensors' or suppliers' third party licensors. Your use of the Third Party Software and Third Party Services is also subject to additional terms and conditions and policies which can be accessed through our global website.

## Privacy policy

During registration you will be asked to submit some information to Acer. Please refer to Acer's privacy policy at <http://www.acer.com> or your local Acer website.

Music recognition technology and related data are provided by Gracenote®. Gracenote®, Gracenote logo and logotype, and the "Powered by Gracenote" logo are either a registered trademark or a trademark of Gracenote, Inc. in the United States and/or other countries.

 XT9 and XT9 logo are registered trademarks of Nuance Communications, Inc. or its subsidiaries in the United States of America and/or other countries.

# Table of Contents

---

## End User License Agreement

Features and functions .....	7
Product registration .....	7

## Setting Up

Unpacking your smartphone .....	8
Getting to know your smartphone .....	8
Installing a SIM or microSD Card .....	10
Installing or removing the battery .....	10

## Using Your Smartphone

Turning on for the first time .....	13
Locking your smartphone .....	13
Using the touchscreen .....	14
The onscreen keyboard .....	14
The widget screen .....	17
The home screen .....	18

## Managing Contacts

Managing your contacts .....	23
------------------------------	----

## Making Calls

Before making a call .....	26
Making a call .....	26
The voice call screen .....	27
Voice call options .....	28

## Messaging

Creating a new message .....	30
Replying to a message .....	31
MMS messages .....	31

## Going Online

Browsing the Internet .....	33
Setting up your Google email .....	34
Composing an email .....	34
Setting up Email .....	35
Online applications .....	35

Acer SocialJogger .....	37
<b>Using the Camera</b>	
Camera icons and indicators .....	39
Taking a photo .....	40
Shooting a video .....	41
<b>Advanced Settings</b>	
Putting your smartphone in Airplane mode .....	42
Activating or deactivating connections .....	42
Adjusting connection settings .....	43
Dolby Mobile .....	44
Selecting a network .....	44
Phone settings .....	45
Connecting to a PC .....	45
Multimedia playback .....	46
Resetting your smartphone .....	50
<b>Accessories and Tips</b>	
Using the headset .....	52
Using a Bluetooth headset .....	52
<b>Appendix</b>	
FAQ and troubleshooting .....	53
Other sources of help .....	54
Warnings and precautions .....	54
Emergency calls .....	57
Disposal and recycling information .....	57
Taking care of your smartphone .....	58
Specifications .....	59
Regulatory information .....	61

# Getting to know your smartphone

---

## Features and functions

Your new smartphone offers leading, easy-to-access multimedia and entertainment features. You can:

- Access your email while on the move.
- Connect to the Internet at high speed, via HSPA+ (DL 14.4 Mbps / UL 2 Mbps) or Wi-Fi.
- Keep in touch with your friends via your Contacts and social networking applications.
- Listen to rich, full-impact audio via Dolby Mobile.

## Product registration

When using your product for the first time, it is recommended that you immediately register it. This will give you access to some useful benefits, such as:

- Faster service from our trained representatives.
- Membership in the Acer community: receive promotions and participate in customer surveys.
- The latest news from Acer.

Hurry and register, as other advantages await you!

## How to register

To register your Acer product, please visit <http://mobile.acer.com>. Click **Product Registration** and follow the simple instructions.

You can also register directly from your smartphone by tapping the **Acer Registration** icon.

After we receive your product registration, you will be sent a confirmation email with important data that you should keep in a safe place.

# Chapter 1: Setting Up

## Unpacking your smartphone

Your new smartphone comes packed in a protective box. Carefully unpack the box and remove the contents. If any of the following items is missing or damaged, contact your dealer immediately:

- Acer Liquid Metal (S120) Smartphone
- Battery
- Quick Guide
- USB cable
- AC adapter
- Headset
- Warranty card

## Getting to know your smartphone

### Views

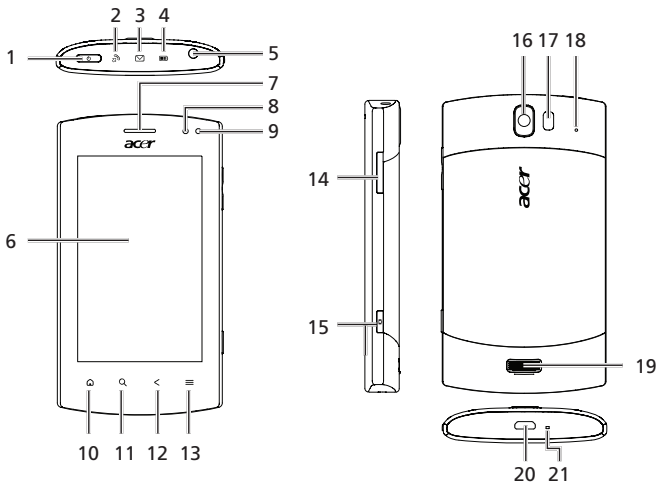

No.	Item	Description
1	Power button	Press to turn the screen on/off or enter sleep mode; press and hold to turn the smartphone off.
2	Call indicator	Indicates an incoming call or missed call.
3	Mail/message indicator	Indicates unread mail or other messages.
4	Charge indicator	Indicates battery charge status.
5	3.5 mm headphone jack	Connect to stereo headphones.
6	Touchscreen	3.5-inch, 800 x 480 pixel capacitive touchscreen to display data, phone content and enter information.



No.	Item	Description
7	Phone speaker	Emits audio from your smartphone; suitable for holding to your ear.
8	IR LED	Works in conjunction with the proximity sensor.
9	Proximity and light sensor	Dims the display and deactivates the touchscreen when the device is brought near the face during a call. Adjusts the display brightness depending on lighting conditions.
10	Home button	Returns to the Home screen; press and hold to view recently-used applications, tap an icon to open the associated program.
11	Search button	Opens the Google search function.
12	Back button	Goes back one menu step; closes the keyboard.
13	Menu button	Opens the option menu; press and hold to display the keyboard.
14	Volume up/down button	Increases or decreases the phone volume.
15	Camera button	Activates the camera or takes a picture. Press down halfway to auto-focus.
16	Camera	A 5-megapixel camera for taking high-resolution images.
17	Flash	Produces light for picture taking and video recording.
18	Second microphone	Internal microphone
19	Handsfree speaker	Emits audio from your smartphone; suitable for handsfree use.
20	Micro USB connector	Connects to a USB cable/charger.
21	Microphone	Internal microphone.

## LED indicators

### Call indicator:

LED state	Description
Off	No incoming or missed calls.
Fast flashing	Incoming call.
Slow flashing	Missed call(s).

### Mail/message indicator:

LED state	Description
Off	No unread mail or messages.
Slow flashing	Unread mail or messages.

## Charge indicator:

LED state	Description
Off	Normal status.
Constantly on	Battery is fully charged and the device is plugged in.
Slow flashing	Device plugged in: Battery is charging. Device unplugged: Battery is low and should be charged.
Fast flashing	Battery is critically low and needs to be charged urgently.



.....  
**Note:** If the phone's battery is completely discharged, it may take a minute or two for the indicator to start flashing after you plug the phone in.  
.....

## Installing a SIM or microSD Card

To take full advantage of your smartphone's telephony capabilities, you must install a SIM card. The SIM card holder is located in the battery compartment.

Additionally, you may wish to increase your smartphone's storage by inserting a microSD Card into the slot provided. This is next to the SIM card slot.

1. Turn off the phone by pressing and holding the power button.
2. Open the cover and remove the battery as described in "Installing the battery" on page 11.
3. Insert the SIM or microSD Card as shown.
4. Replace the battery and battery cover.

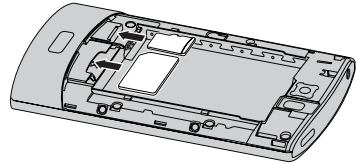

.....  
**Note:** Ensure that the microSD Card is inserted all the way into the card slot.  
.....



.....  
**Caution:** Turn off your smartphone and remove the battery before installing or removing the SIM or microSD card. You may damage the card or your smartphone if the battery is still installed.  
.....

## Installing or removing the battery

Your smartphone uses a replaceable battery to provide power. It is packed separately from your smartphone and needs to be inserted and charged before you can use the smartphone.

## Installing the battery

Slide the battery cover down and lift up.

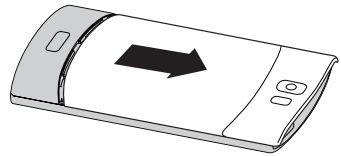

Place the battery into the battery compartment, lining up the battery connectors with those at the top of the compartment.

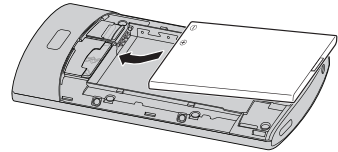

Align the tabs on the battery cover and carefully slide the battery cover until it clicks into place.

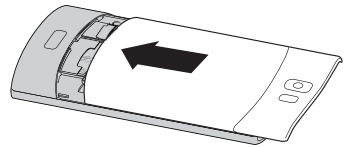

.....  
**CAUTION: RISK OF EXPLOSION IF BATTERY IS REPLACED BY AN INCORRECT TYPE.  
DISPOSE OF USED BATTERIES ACCORDING TO THE INSTRUCTIONS.**  
.....



.....  
**CAUTION: DO NOT INSERT THE BATTERY VERTICALLY INTO THE COMPARTMENT AS IT  
MAY DAMAGE THE CONTACTS.**  
.....

## Charging the battery

For initial use, you need to charge your smartphone for eight hours. After that you can charge it each day to recharge the battery to full capacity.

Connect the AC adapter cord to the micro USB connector on your smartphone.



.....  
**Note:** The fastest way to charge your smartphone is with the included AC adapter.  
.....

## Removing the battery

Open the battery compartment as shown in **"Installing the battery"** on page 11. Lift the battery out of the compartment using the tab on the top of the battery.

Replace the battery cover as described above.

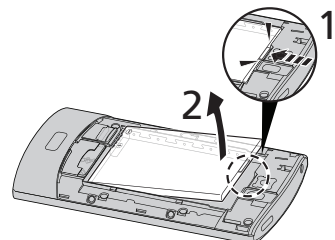

## SIM card lock

Your smartphone may come with a SIM card lock, i.e., you will only be able to use the SIM card provided by your network operator.

To cancel the SIM lock, contact your network provider.

# Chapter 2: Using Your Smartphone

---

## Turning on for the first time

To turn on your smartphone for the first time, press and hold the power button until the screen turns on. You will then be asked to configure some settings before you can use your smartphone.

To start, tap to select your language, then tap the green android on the next screen. Follow the rest of the instructions as they are displayed.

## Sign in to or create a Google account

If you have Internet access, your smartphone allows you to synchronize information with a google account.

During the start-up process, you may create or sign in to your account, which will be used to synchronize your contact list, email, calendar and other information. If you do not yet have Internet access, or do not want to use this feature, then tap skip.

## Creating multiple Google accounts

You can create and easily access multiple Google accounts. Tap **Settings > Accounts & sync settings > Add account**.

## Activating a new SIM card

If you are using your SIM card for the first time, it may require activation. Contact your network operator for details on how to do this.

## Entering your PIN

When you install a SIM card for the first time, you may need to enter a PIN using the onscreen number pad.



.....  
**Important:** Depending on your settings, you may be required to enter your PIN each time you switch on the phone function.  
.....

## Locking your smartphone

If you will not use your smartphone for a while, briefly press the power button to lock access. This saves power and ensures your smartphone does not unintentionally use any services. Your smartphone will lock automatically if it is not used after a while. To set the delay, tap **Menu > Settings > Display > Screen timeout**.

# Waking your smartphone

If the screen is off and the smartphone does not react to any taps on the screen, then it has been locked and is in sleep mode.

To wake your smartphone, press the power button. Your smartphone will display the widgets screen. Tap and drag starting from the bottom left corner to peel the screen and unlock the smartphone.

For additional security, you may set an unlock pattern, a set of dots that must be tapped in the correct order to access the phone. Open the application menu and tap **Settings > Location & security > Set up screen lock**.

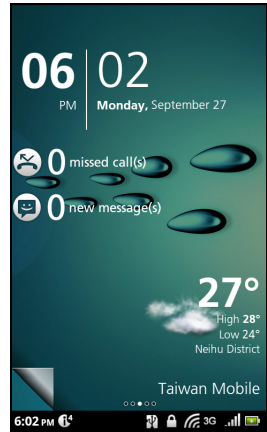

**Note:** If you forget your unlock pattern, please refer to “Unlock pattern” on page 53.

# Unlocking your smartphone

At the bottom left of the screen is the **Page peel**. Unlock your smartphone by dragging the peel up and right.

# Using the touchscreen

Your smartphone uses a touchscreen for selecting items and entering information. Use your finger to tap the screen.

**Tap:** Touch the screen once to open items and select options.

**Drag:** Hold your finger on the screen and drag across the screen to select text and images.

**Tap and hold:** Tap and hold an item to see a list of actions available for that item. On the pop-up menu that appears, tap the action you want to perform.

**Scroll:** To scroll up or down the screen, simply drag your finger up or down the screen in the direction that you want to scroll.

# The onscreen keyboard

When you tap a text box to enter text, an onscreen keyboard will appear. Simply tap on keys to enter text. If you require a larger keyboard, turn your smartphone 90 degrees to the left to use landscape mode.

The layout of the keyboard varies slightly, depending on the application and information that is required.

## Changing the text input method

To change the input method, tap and hold a text box, then select **Input method**. This will open a menu listing the text input methods available on your phone. Tap your preferred input method. Typically two options are available: **XT9 Text Input** and **Android Keyboard**.

## Predictive text

Both XT9 Text Input and Android keyboard provide predictive text input. As you tap the letters of a word, a selection of words are displayed above the keyboard that continue the sequence of letters tapped, or are a close match allowing for errors. The word list changes after every key press. If the word you need is displayed, you can tap on it to insert it into your text.

## XT9 Text Input

Tap the **?123** button to see numbers and special characters, and then tap the **Alt** key to see even more. Tap and hold a key to select alternative characters, such as letters with accents.

Additional keys vary depending on the type of text you enter. E.g. a key to add a smiley is available when typing a text message. Like other keys, tap and hold for additional options.



## Text assistance

The standard XT9 keyboard has various features that assist you to enter correct text. Tap **Menu > Settings > Language & keyboard > XT9 Text Input**. From here you can enable or disable the following:

Function	Description
Languages and settings	Set the languages that will be available. Select the keyboard layout you prefer. There are three layouts available: <ul style="list-style-type: none"><li>• Keyboard: A full QWERTY keyboard.</li><li>• Reduced keyboard: Two letters are available on each key. Tap and hold the key to select a letter, including special characters.</li><li>• Phone keypad: Three letters are available on each key. Tap and hold the key to select a letter, including special characters.</li></ul>
Preferences	Change your text input preferences.

# Android keyboard

This is a standard QWERTY keyboard that allows you to enter text.



Tap the **?123** button to see numbers and special characters, and then tap the **Alt** key to see even more. Tap and hold a key to select alternative characters, such as letters with accents.

Additional keys vary depending on the type of text you enter. E.g. a key to add a smiley is available when typing a message. Like other keys, tap and hold for additional options.

## Text assistance

The standard Android keyboard has various features that assist you to enter correct text. Tap **Menu > Settings > Language & keyboard > Android keyboard**. From here you can enable or disable the following:

Function	Description
Quick fixes	Corrects commonly typed mistakes.
Show suggestions	Shows suggested words while you are typing.
Auto-complete	Inserts the suggested word whenever you tap space or a punctuation mark.

## Multilingual input

Switch between multiple input languages by swiping across the space bar. The keyboard layout will change accordingly. To select your preferred languages, tap **Menu > Settings > Language & keyboard > Android keyboard > Input languages**.



## Penpower Input Method

*Only available in certain regions.*

The Penpower Input Method allows you to draw letters and characters on the screen, one at a time.

Draw the character in the rectangle that appears on the screen. After a short delay, a selection of characters will be proposed below the input area. Tap a character to enter it into the text.

Draw a letter in the **Abc** rectangle to limit the proposed characters to the alphabet, or in the **12#** rectangle to limit the proposed characters to numbers or text symbols.

Tap the circle and triangle symbol to expand the input area so that it takes the whole screen. Tap the **Abc** or **12#** keys to display a keyboard.

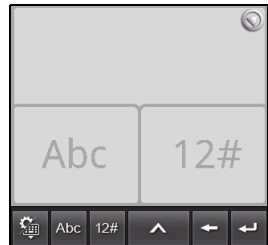



Tap and hold the settings symbol and select **Input Method Settings**, or from the Home screen tap **Menu > Settings > Language & keyboard > Penpower Input Method**, to access text entry settings.



## The widget screen

When you start your smartphone, or wake it from power saving, it will display the Widget screen. This screen protects your smartphone from accidental access and gives you quick access to information and simple controls with **widgets**. These display information such as the time or weather, or provide additional controls. Some have been pre-installed on your smartphone, while others may be downloaded from the Android Market.

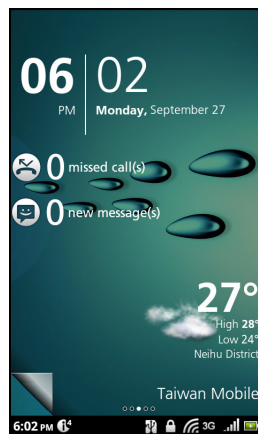

## The extended widget screen

The widget screen extends to either side of the initial widget screen, giving you more room to add widgets or features. To view the extended widget screen, slide your finger to the left or right. A total of five pages are available, two to the left and two to the right. To change or add widgets on any of the screens see **“Personalizing the screen”** on page 20.



# The home screen

When you unlock your smartphone it will display the home screen. This screen gives you quick, icon-based access to many of the frequently-used features of your smartphone.

The Home screen already features some useful icons, application history and media panel.



The top of the screen is empty when you first start using your smartphone. Later it shows the **application history**, allowing you to access applications you have recently used, and a **media panel**, allowing you access to your pictures, music and videos from your microSD card.

At the bottom of the screen is the **application dock** which shows favorite or recommended applications. Tap an icon to open the application. Tap the menu button or drag the application dock towards the top of the screen to see the application menu.

## Application history

The application history shows recently opened applications.

If the history thumbnails are not displayed, drag the tab on the left of the screen towards the right. Scroll through the thumbnails of applications until you find the application you want to open, then tap the thumbnail to open the application.

Tap the **Clear History** button to remove all the history thumbnails. Tap and hold a thumbnail, then drag it to the trash to remove a single entry.



## Multitasking

You can have multiple applications open at the same time. To open a new application, press the **Home** button to return to the Home screen, then start the new application.

To view your recent applications, access the application history and tap a thumbnail to open the application.



**Tip:** To prolong battery life, it is better to close an application when you've finished using it. Do this by either pressing the **Menu** button and selecting **Exit** (if available).

## The application menu

The application menu displays groups of applications in a series of pages. Up to sixteen applications may be displayed per page.

The number of pages is displayed at the bottom of the screen. Drag the menu to the left or right to switch pages. You may also tap and hold the page numbers at the bottom of the screen to go directly to any page.

Tap and hold an icon to move or delete it; you may change the order of icons or reorganize the pages to suit your needs. Drag an icon to the edge of the screen, or one of the page numbers, to change the page.

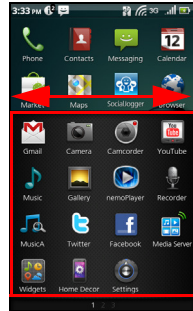

## Notification area

The Notification area is between the application history and application dock.









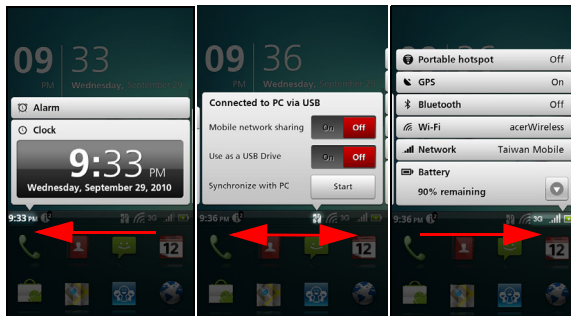





This area contains a variety of icons to inform you of your phone's status. The left side of the Notification area displays the time and event icons. The icons on the right side indicate connectivity and battery status.

Tap the **Notification** area to view more information about new events and connectivity.

While viewing notifications, tap a category to see more information or buttons to settings, if available. If more than one column of notifications are available, drag the notifications to the side to view them.



Icon	Description
	An alarm has been set.
	Application notification.

Icon	Description
	New/unread message.
	Incoming call or active call.
	Missed call.
	Wi-Fi signal strength.
	Bluetooth® enabled.
	Vibrate enabled.
	Cellular signal strength.
	Airplane mode: Wireless signals disconnected. Disable airplane mode before trying to make a call.
	3G connected: You may make a call.
	2G connected: You may make a call.
	SIM card not installed/error.
	Battery status.

## Personalizing the screen

You may personalize your screen by adding or removing icons, shortcuts or widgets, and by changing the wallpaper.

### Changing application dock icons

You can set icons for installed applications in the application dock. Open the application menu and find the application you want to add. Tap and hold the icon, then drag it to a position in the dock, it will be added in place of the existing application.

To remove an icon from the dock, open the application menu, then tap and hold an icon to select it. Either drag the icon to a different page in the application menu, or to the trash icon that appears at the bottom left corner of the screen.

## Shortcuts and Folders

You can add shortcuts and folders to a free space in the application dock or menu, for example, to display contacts or shortcuts to specific tasks or settings.

Pre-defined Shortcuts are available or you can add a Folder. Tap and hold a space on the dock or the application menu. Tap either Shortcuts or Folders; Shortcuts provides a list of specific contacts, addresses and settings, Folders provides a list of contacts or document types.

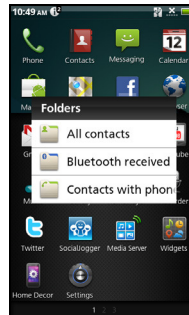
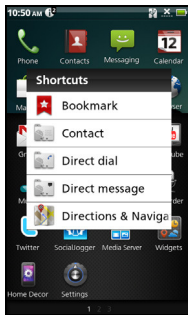
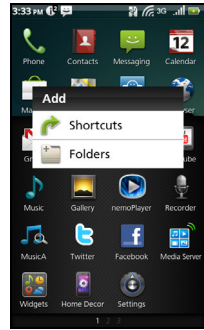

## Widget overlay

The widget overlay allows you to bring up the widget screen and access installed widgets while working on another process.

To access the widget overlay, press and hold the home button.

## Adding or removing widgets

To add widgets, press and hold the home button or tap **Widgets** in the application menu, to open the widget overlay. Tap the **+** button in the bottom left corner to open a list of available widgets. Scroll down the list to see all options.

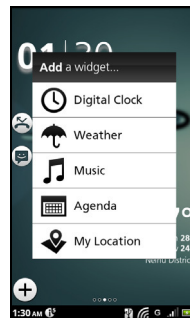
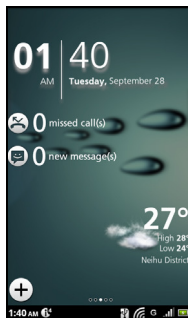

To reposition a widget, tap and hold the widget. You may then drag the widget to any point on the grid.

A red background indicates that the widget may not be placed in the chosen position, usually because widgets may not overlap. A green background indicates the position can be used.

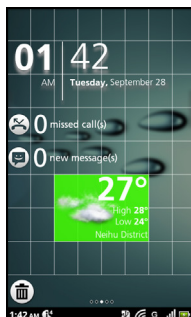
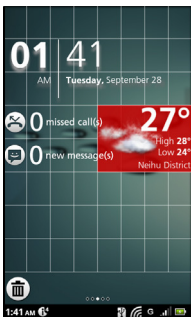

Drag the widget to the left or right edge of the screen to add it to either extended screen. Drag it to the trash icon to remove it from the screen.

## Acer Widget Settings

From the widget overlay screen, tap the menu button and select Acer Widget Settings to see settings for Acer-designed widgets.

## Changing the wallpaper

On the home screen, simply tap and hold the current wallpaper. A screen showing alternative wallpapers and sounds will be displayed.

Select a wallpaper from the first row, or open your own pictures from the second row. Tap the image you wish to use as your smartphone's wallpaper. If you choose an image that is not the correct size, you will be asked to crop the image to the correct size. Tap and drag the box until you have selected the part of the image you want.

To set the wallpaper from the camera, follow the instructions on **"Taking a photo" on page 40**. In the picture review screen, tap the  icon and set picture as **Wallpaper**.

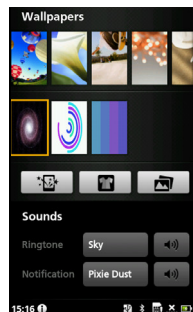

# Chapter 3: Managing Contacts

## Managing your contacts

Your smartphone features an address book that allows you to save contacts to the internal memory, SIM card or Google.

Tap **Contacts** from the application dock or the **Contacts** tab from the Phone application to view your contacts.

If you don't have any contacts stored on your phone, you can sync your Google account contacts, add a new contact or import any SIM contacts. Press the Menu button to open the menu options.

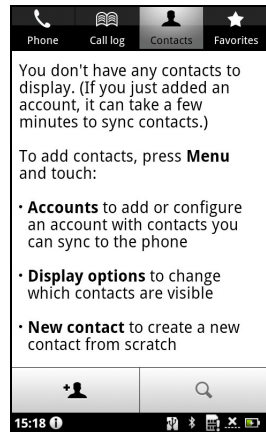

Icon	Description
	Add a new contact.
	Search for a contact.

## Adding a contact

Tap **Add contact** to add a new contact. You will be asked if you want to create a SIM, Phone, or Google contact.

To create a contact, you will be asked to enter the contact's:

- Given and Family name.
- Phone numbers.
- Email addresses.
- IM addresses.
- Postal addresses.

To assign an image to your contact, tap the silhouette and select an images from your smartphone's picture gallery (select **Gallery** if requested). You may also take a new photo: tap **Gallery**, then the camera icon in the corner of the screen.

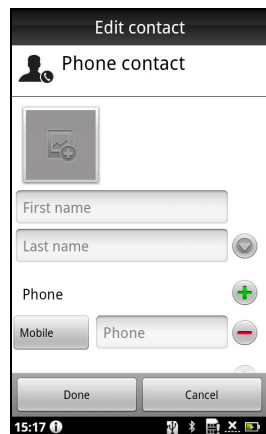



**Tip:** Set the phone number to match the type of network as this can determine some functions. I.e. certain applications only recognise 'Mobile' numbers as they require a mobile network.



**Tip:** You may also create a contact from an already dialed or received number, see **"Saving a number from the call log" on page 27.**

## Creating a group

In Contacts, tap **Menu** > **More** > **Manage Groups** > **Add Group** and enter in a group name.

## Assigning a contact to a group

To assign a contact to a group, tap **Menu** > **Edit Contacts** > **Groups** and select which groups to join.

## Opening a contact

To see the information stored for a contact, tap on the contact's name. Then to add the contact to your Favorites list, tap the star next to the contact's name.

## Favorites

You may quickly access your favorite contacts by adding them to the Favorites tab. First open the contact, then tap the star next to the contact's name. Tap the **Favorites** tab to see your favorite contacts.

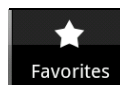

## Editing a contact

Open the contact you want to edit. Tap **Menu** then **Edit contact** to add or change information. Tap the green plus sign to add an entry, then enter the information in the new text box. You may enter multiple entries in each category, such as multiple phone numbers or addresses.

Additional options are available under the options drop down. Tap **Options** to set special entries for your smartphone.

- Assign the contact to one or more groups.
- Set a ringtone for calls received from the contact.
- Send any calls from the contact directly to your voicemail.

Tap **Done** to save the changes, or **Cancel** to discard them.

## Editing a contact on your computer

If you have synchronised your Google account and contacts, you can use your computer to access and edit your contact list. Open the Internet browser on your computer and go to <http://mail.google.com>. Sign in to your account and click **Contacts**. Select and edit contacts from the list; the next time you



smartphone synchronizes with your computer, these changes will also be made to your smartphone's contact list.





**Warning: Backup your contacts before making any changes. You may do this from the Contacts tab: Tap Menu and select Import/Export. You may then Export your contact list to the SD card in your smartphone.**

# Chapter 4: Making Calls

This chapter shows you how to make phone calls, and the various options available to you during your call.

## Before making a call

Check that the phone function is on before you make a call. You can confirm the phone status from the icon on the right-hand side of the Notification area.

Icon	Description
	Connected to a 3G network: You may make a call.
	Connected to a 2G network: You may make a call.
	Airplane mode: Wireless connectivity disconnected (Wi-Fi, Bluetooth, 2G and 3G). Please disable airplane mode before trying to make a call.

## Making a call



**Note:** The phone function needs to be enabled before the call can be connected.

1. From the Home screen tap **Phone** to open the onscreen number pad.
2. Enter the number you wish to dial.
3. Tap  to make the call.
4. To end the call, tap **End Call**.

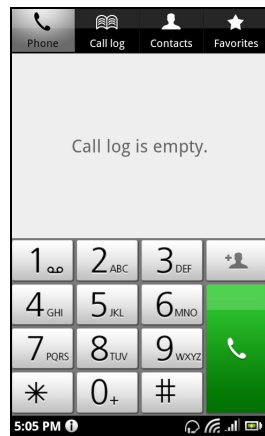

**Warning:** International call rates can vary greatly depending on the country you are calling and your network provider. We suggest you check all call rates with your network provider, to avoid excessive phone bills. If you are using your smartphone abroad, roaming charges will apply. Consult your network provider for roaming rates specific to the country you are visiting before you leave.

## Smart search

Smart search allows you to quickly find a contact from the phone keypad. As you enter a number, if it is already known, it will find appropriate contacts and display them in the list above the keypad. Also, instead of typing a phone

number, you may enter the contact name using the predictive text letters (2 for 'a', 'b' or 'c'; 3 or 'd', 'e' or 'f'; etc.). If the letter combinations match a contact name, it will be displayed.

If the contact you need is displayed, simply tap the contact name to make a call.

## Dialing a number from call log

Your call history can be viewed by tapping the **Call Log** tab. It displays recent received, dialed, and missed calls.

Tap a number to redial. To view details of the call, tap . You may also tap and hold the number to open a menu with other options: **Call <the number>**; **Edit number before call**; **Send text message**; **Add to contacts** or **Remove from call log**.

## Saving a number from the call log

You can save a number from the call log to your contacts for future use.

1. Tap the **Call log** tab in the phone application, or **Contacts** from the Home screen, to view your contacts.
2. Select the number from the **Call log** tab, and tap **Add to contacts**.

## Making a call to one of your contacts

1. Tap the **Contacts** tab in the phone application or **Contacts** from the Home screen to view your contacts.
2. Tap a contact. A dialog will open, asking if you want to call the contact, send the contact an SMS or see the contact's details.

## Speed Dial

You may add a contact to a Speed Dial number on the phone keypad. Open the **Phone** tab, then tap and hold any number from 2 through 9 (1 is reserved for the voicemail service).

Select **OK**, then select a contact from the list. If the contact has more than one phone number, select the number to use.

If a key has a speed dial contact defined, it will show a small contact image as a reminder. Tap and hold the key to call the speed dial number.

If you want to remove or change a speed dial number, tap **Menu** and select **Speed dial**. Tap an entry to remove or change the assigned telephone number.

## The voice call screen

Once you have dialed your number the voice call screen appears, which displays the number/contact you are talking to, the call duration and the dialpad tab.

## Answering or declining a call

When you have an incoming call, the number will be shown on the screen. To accept or decline the call, tap the appropriate button.

If you are answering a call from a locked state, slide the bar to answer the call. To reject a call from a locked state, press the power button.

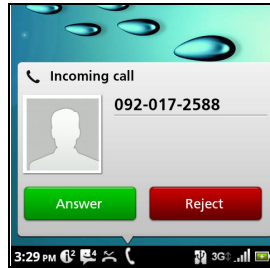
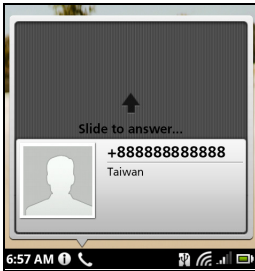



## Ending a call

To end a call, press **End Call** from the voice call screen.

## Voice call options

### Using the speakerphone

The speakerphone function allows you to make calls without having to hold your smartphone. This handsfree function is especially useful for multitasking.

To activate the speakerphone, tap . Tap  again to disable the speakerphone.

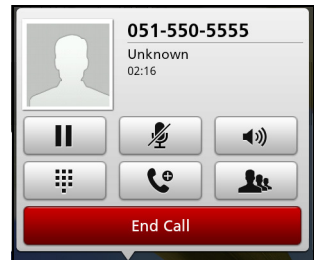

### Accessing the keypad

To access the keypad while in a call, tap . Tap **Back** to return to the voice call screen.

### Accessing your phonebook

To access your phonebook while in a call, tap .

### Muting a call

To mute a call, tap  on the voice call screen to switch off the microphone.



Tap  again to switch the microphone back on.

### Putting a call on hold

To put a call on hold, tap . To return to the call, tap  again.

# Conference calls

If you have one call on hold and another on the line, you can combine both calls to create a conference call.

After the first call is established, tap  to add a second call. When both calls are connected, tap  to start the conference call.

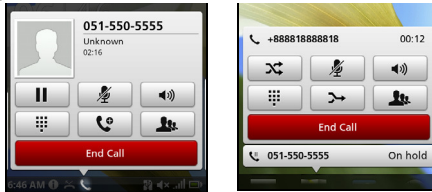

# Viewing missed calls

Missed calls will be displayed by the call indicator in the Notification area with the  icon.

You can also view missed calls from the Notification area.

1. Open the notification list by tapping the Notification area to display the details of the missed calls.
2. Select the call from the list and tap **Return call** to return the missed call.

You can save phone numbers to your contacts list from the Call Log. Please refer to **"Adding a contact"** on **page 23** for further details.

# Chapter 5: Messaging

This chapter shows you how to set up and use the SMS and MMS functions of your smartphone.

All SMS and MMS messages are accessed via Messaging. Messaging automatically arranges received and sent messages into threads.

To access Messaging tap **Messaging** on the Home screen.

## Creating a new message

You can use your phone to compose SMS or MMS messages.

Tap **New message** to compose a new message.





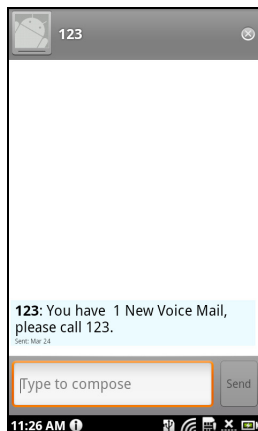

Enter the recipient's phone number or name in the **To** field. Suggested contacts will be displayed in a drop-down list below the text field. To select a suggested contact, tap the contact's name.

Once you have entered the recipient, enter your message in the text box labeled **Type to compose**.



**Note:** SMS messages may be up to 160 characters long. If your message is longer than 160 characters, it will be sent as multiple linked messages. Most phones will automatically join the linked messages to present the recipient with a single long message, however, some older phones do not have this ability.

Press the Menu button to see what options are available when creating a new message. The options change depending on the status of the message.





Icon	Description
	Select receiver from contacts.
	Converts the SMS to an MMS, allowing you to add a subject to the message.
	Views all the threads currently on your phone.
	Converts the SMS to an MMS, allowing you to attach a file to the message.
	Discards the message.
	Inserts a smiley/emoticon into your message text.

# Replying to a message

When a new text message arrives, a message icon appears in the Notification area and the message icon on the top of the phone lights up.

Tap **Messaging** on the Home screen to view the message list or expand the Notification area to see a summary of the message. Tap the summary to open the message list.

To reply to an SMS or MMS message, open the message from the message list. Enter your text in the text box labeled **Type to compose**. Press the Menu button to see available options.

Icon	Description
	Calls selected contact.
	Converts the SMS to an MMS, allowing you to add a subject to the message.
	Converts the SMS to an MMS, allowing you to attach a file to the message.
	Deletes the thread.
	Inserts a smiley/emoticon into your message text.

## MMS messages

MMS messages are similar to text messages but also allow you to attach multimedia files such as pictures, audio or video clips. Each MMS message can be up to 300 kB in size.



**Note:** You need to set up an MMS profile before you can send MMS messages. Normally, your smartphone will set up the profile for you based on information retrieved from your provider.



**Tip:** Ask your network provider for the necessary information if you need to manually set up the MMS profile.

# Receiving MMS messages

When a new MMS message arrives, a message icon appears on the notification bar and a notification message is displayed.

1. Open Messaging to view a summary of the message.
2. Tap **Download** to download the message content.



**Note:** Downloads can take a long time, depending on your connection quality. If you reply or open another application, the download will be stopped.



**Important:** You may be charged to download message content, especially if you are roaming. Please contact your provider if you have any questions.

3. Tap the message to view the content.
4. Tap the **Menu** button and tap **Reply** to reply to the message. The message window will appear. Simple text replies will be sent as SMS messages. If you wish to attach a file, tap the **Menu** button and tap **Attach**. You will be presented with a menu of options.
5. When you have finished composing the message, tap the **Menu** button and tap **Send**.

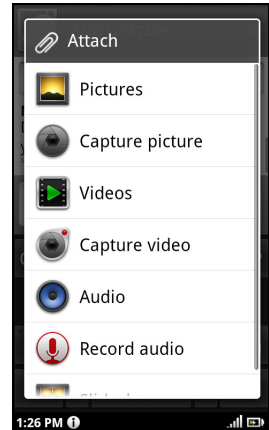



# Chapter 6: Going Online

---

## Browsing the Internet

In order to browse the Internet with your smartphone, you must be connected to a data or wireless network.

### Using the browser

Tap **Browser** on the Home screen to start browsing. To open a new website, tap the address box at the top of the page. Enter the address using the keyboard and tap **Go**.

To view your browsing history, bookmarks or frequently visited sites, open the browser then press and hold the back button.

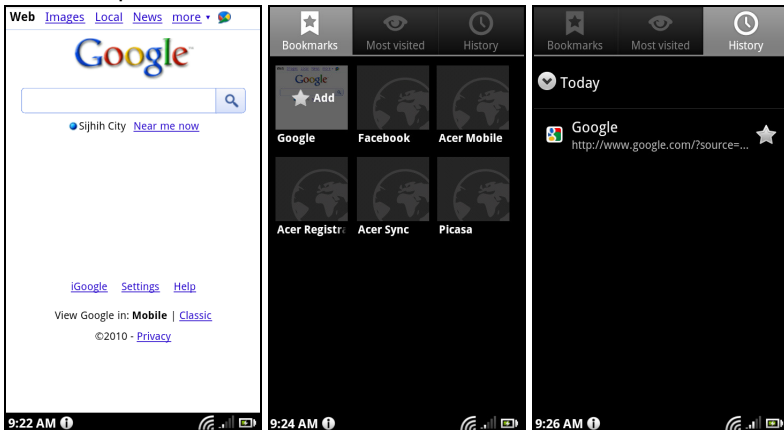

You may open multiple pages. When a page is open, press the Menu button and tap **New window** from the menu that opens. Tap **Windows** to view all the windows that are open.

You can zoom in or out of pages using the zoom bar that appears when you tap the screen. Tap and hold an item on a page to open a contextual menu.

# Voice Search

With voice actions, you can send text messages, place calls, send emails, find directions of establishments, automatically call establishments, search the Internet and even send a note to yourself using your voice. Open **Voice Search** from the applications tab, or press and hold the Search button. Press and hold the Search button again to display the “Speak now” prompt, and state your command.



**Note:** Voice search is available only in some regions.

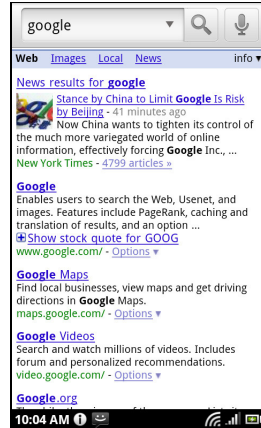
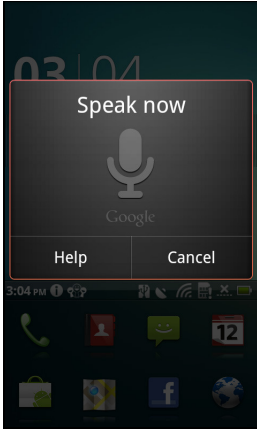

## Setting up your Google email

1. Make sure your smartphone is connected to a data or Wi-Fi connection.
2. From the Applications menu tap **Gmail**.

If you did not enter your Gmail account address and password when you first started your phone, follow the on screen instructions.

## Composing an email

1. Make sure your smartphone is connected to a data or Wi-Fi connection.
2. From the Home screen tap **Gmail**.
3. Press the **Menu** button and then tap **Compose**.
4. Enter the recipient's email address, the subject and message.
5. When you are finished composing your message, tap **Send**.

# Setting up Email

Your smartphone enables you to access your email. Most popular ISPs can be set up in two steps. Pull up the application menu and then tap **Email** to start setting up your email access.

If necessary, enter your email address and tap **Manual setup** to enter the parameters manually. Tap **Next** to finish the setup process.

The combined inbox feature of your smartphone allows you to view emails from multiple accounts in a single inbox.



## Online applications

Your smartphone has a variety of applications installed on it from the factory.



**Note:** Applications installed may vary according to your region.

These applications may include:

- **Acer Sync:** Sync your data between your computer and the Google servers.
- **SocialJogger:** View updates to your social networks in one location.
- **Facebook:** View your Facebook profile and keep up-to-date with your friends.
- **Maps:** Get easy-to-follow directions using Google Maps.
- **Navigation:** Turn-by-turn navigation with live traffic, multiple visible layers and text-to-speech take you where you want to go.
- **Latitude:** View where your friends are on Google Maps.
- **Places:** View places of interest and local businesses on Google Maps.
- **YouTube:** View the Most viewed and Most discussed video clips on YouTube.

# Android market



**Note:** The Android Market may not be available in all countries and regions.



**Note:** You need to have a Google account set up and active on your phone before you can use the Android Market.

Tap **Market** from the application menu to open the Android Market. Here you can obtain a variety of add-on programs and applications to enhance the functionality of your smartphone. The first time you access the Android Market, you will need to read and accept the Terms of Service.

You can browse the market by category or tap the search icon to search for a specific application.

Once you have selected an application, tap the **Install** button to download and install the application. You will be told which services on your phone that the application has access to. Tap **OK** to proceed with the installation.

You may keep track of the download progress from the Notification Area.

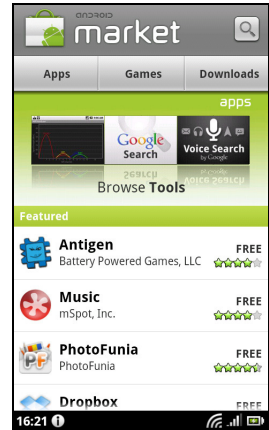

**Important:** Some applications may require payment before you can download them. You will need to have a Google Checkout account in order to pay for these applications.

## Uninstalling downloaded applications

Once you've downloaded and installed an application, you may uninstall the application by pressing and holding the application icon and dragging it to the trash can located on the bottom left-hand corner of the screen.

Alternatively, you can go to **Settings** from the application menu and select **Applications > Manage applications**. Tap the application you wish to uninstall, tap **Uninstall** and confirm the uninstall.

# Acer SocialJogger

Acer SocialJogger combines your social network updates in one location, allowing you to quickly follow what your friends are doing across several platforms.

From the application menu, tap Acer SocialJogger to launch the program.

Select **Sign in** to enter your account information. When you are finished press **Start**.

Slide the disc, located on the right, up and down to cycle through the notification updates.

Tap on a notification to view more details and make a comment.

Tap the left and right arrows, located on the top, to cycle between the categories: My Page, Photos, Link and any added pages.

Tap the **Menu** button to access account settings, refresh the page, and add or remove custom pages.

Location Plus: If you upload a picture with the SocialJogger uploader through the gallery or from the camera review screen, the uploaded picture will display its geotag.



**Note:** For geotag to display, pictures must be taken with **Store Location** activated in the camera settings.

# urFooz

urFooz is a portable avatar that lets you share information across your favorite social networks, blogs and more.

Easily organize your Web favorites, such as photos, videos, bookmarks and more, with a urFooz ID. urFooz gives you:

- One identity for all your online activities.
- An avatar that represents the "virtual" you.
- A single connection for all your Web favorites.

To start urFooz, open the application menu and tap **urFooz**.

Additional tools on the urFooz Internet site let you edit and manage your Fooz avatar(s), create new avatars and share them on Facebook, MySpace, blogs and more. Go to <http://www.urfooz.com>.

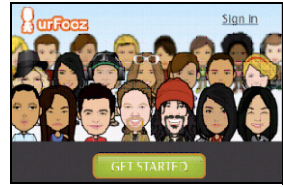

.....  
**Note:** urFooz, Fooz Avatars, Fooz Creator, Fooz Card, and Fooz World are trademarks or registered trademarks of Fuhu, Inc. in the U.S. and/or other countries.  
.....

# Chapter 7: Using the Camera

Your smartphone features a 5-megapixel digital camera and flash mounted on the rear. This section will take you through all the steps in taking photos and videos with your smartphone.







**Note:** You need to have a microSD Card inserted into the microSD slot before using the camera.

To activate the camera, press and hold the camera button, or open the application menu and tap **Camera**.

## Camera icons and indicators







In the camera window, the five icons on the left allow you to set the focus, adjust the flash settings, switch between camera and camcorder, and view the gallery of pictures or videos. Use the zoom slider at the bottom of the screen to adjust the zoom. :

Icon	Description
	Adjusts the focus between normal, facial recognition  , and macro  .
	Adjusts the flash between on  , auto  , red eye reduction  , and off.
	Takes you to the gallery.
	Activates the camera.
	Activates the video recorder.

The number in the top right corner shows how many more photos can be stored, or the maximum duration for a video.



To adjust the settings, tap **Menu**. The menu options are:

Icon	Description
 SM 2592x1944 Photo quality	Set the photo quality.
 Properties	Set brightness, contrast, saturation, and sharpness.
 AWB White balance	Set white balance.
 Off Timer	Set timer.
 More	Access camera settings menu.

## Camera settings menu

This menu has the following options:

- Capture mode
- Anti-Shake
- Effect
- ISO
- Auto Exposure
- Time stamp
- Store Location
- Review Duration
- JPEG Quality
- Anti Banding
- Reset to Default

Capture mode	Description
Normal	Standard point and shoot mode.
 Smile	Detects a smile and automatically takes a picture.
 Face auto-shot	Detects when a face is centered and automatically takes a picture.

## Taking a photo

1. Ensure you have adjusted the parameters described above.
2. Frame your subject and steady your smartphone.
3. Zoom in or out as needed.
4. **Auto focus:** Press the camera button down halfway to focus. The focus frame will turn green. Push the button down the rest of the way to take the photo.



# Shooting a video

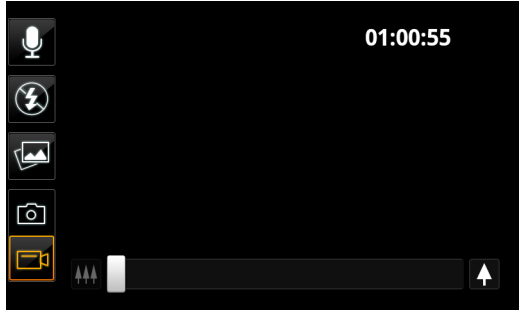

Turn on camcorder mode by tapping the camcorder icon.

1. Ensure you have adjusted the options described above.
2. Frame your subject and steady your smartphone and zoom in or out as needed.
3. Press the camera button down fully to begin recording.
4. Press the camera button down fully to stop recording.



.....  
**Note:** Zoom is only available in certain resolutions.  
.....

## Supported formats

Type	Formats
Image	JPEG
Video	MPEG-4, H.263

## Viewing photos and videos

After you have taken your photo or video, it is automatically saved.

Once you have taken a photo or video, you can view it in the Gallery by tapping the thumbnail icon in the left side of the screen. Alternatively, open the application menu and tap **Gallery**. From the Gallery you can share the file directly using various services.



.....  
**Note:** Share options vary depending on the file type.  
.....

# Chapter 8: Advanced Settings

---

## Putting your smartphone in Airplane mode

You can enter Airplane mode (also known as flight mode) to turn off telephone and Bluetooth functions and use your smartphone as a handheld device during a flight. Check with your airline to make sure this is permitted onboard.

Switch your smartphone off during takeoff and landing as it may interfere with aircraft electronic systems.

## Turning Airplane mode on or off



.....  
**Note:** When Airplane mode is active, the  icon will be displayed in the Notification area.  
.....

1. Press and hold the power button until you get the phone options menu.
2. Tap the switch next to **Airplane Mode** to switch it ON or OFF.

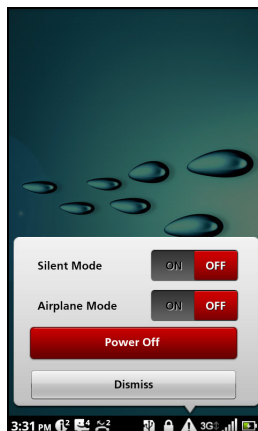

## Activating or deactivating connections

Open the Application menu and tap **Settings** > **Wireless & networks** to manage your connection settings.

Each connection will have a green check when turned on.

Alternatively, you can tap on the right side of the notification bar to manage connection settings.



.....  
**Important:** If your phone is in Airplane mode, the option to turn Bluetooth on will be disabled. Please refer to **"Putting your smartphone in Airplane mode"** on page 42 for instructions on turning Airplane mode on or off.  
.....

## Phone network settings

Tap **Settings** > **Wireless & networks** > **Mobile networks** to adjust your network settings. You can turn data connection on or off when roaming, restrict the connection to 2G networks only, specify a network operator and define access point names. Please refer to **"Selecting a network"** on page 44.

# Adjusting connection settings

This section will show you how to adjust detailed settings for your phone, data, Wi-Fi and Bluetooth connections.

Item	Description
Airplane mode	Disables all wireless connections so you can safely use this device onboard an aircraft.
Wi-Fi	Turns the Wi-Fi function on or off.
Wi-Fi settings	Sets up and manages your wireless access points.
Bluetooth	Turns the Bluetooth function on or off.
Bluetooth settings	Manages your Bluetooth connections, sets a device name and discoverability.
Tethering & portable hotspot	Shares your phone's mobile data connection via USB or as a portable Wi-Fi hotspot.
VPN settings	Sets up and manages Virtual Private Networks.
Mobile networks	Sets your options for connecting to mobile networks.
Internet sharing	Shares your mobile data connection with the connected computer.

## Sound

Adjust the volume of your phone using the volume buttons on the side of the phone. Alternatively, you can adjust your phone sound settings by tapping **Settings > Sound**.

Item	Description
Silent mode	Turns off all sounds except for alarms and media.
Vibrate	Sets vibration options.
Volume	Sets volume for Ringtone, Media, Alarm, and Notifications.
Phone ringtone	Sets your phone's ringtone.
Notification ringtone	Sets a ringtone for notifications.
Audible touch tones	Plays tones when using dial pad.
Audible selection	Plays a sound whenever a screen selection is made.
Screen lock sounds	Plays a sound when locking and unlocking the screen.
Haptic feedback	Vibrates when pressing soft keys and on certain UI interactions.
Gesture controls	Mutes alarm or skips forward / back while playing music.

## Display

You can adjust your phone display settings by tapping **Settings > Display**.

Item	Description
Brightness	Adjust screen brightness.
Auto-rotate screen	Enable rotation of the screen when device is tilted.
Animation	Enable window animations.

Item	Description
Screen timeout	Set a delay before the screen will be turned off.
Touch panel sensitivity	Adjust the touch panel sensitivity.
Keypad sensitivity	Adjust the keypad sensitivity.

## Dolby Mobile

To access Dolby Mobile settings go to the application menu and tap **Settings > Dolby Mobile**. Here you can switch Dolby Mobile on or off, set Treble, Natural Bass, Music EQ and Video EQ.

## Selecting a network

Your phone will automatically detect your carrier/network settings when you insert a new SIM card. However, you may prefer to manually select a network. This may be a good idea when roaming.



.....  
**Tip:** When you are traveling, manually selecting a network may help to reduce your roaming charges. Check with your home service provider for the network offering the most competitive rates at your destination.  
.....

1. Open the application menu and tap **Settings > Wireless & networks > Mobile networks > Network operators**.
2. Your phone will search for available networks.
3. Select your preferred network from the list generated. Your phone will attempt to register on the selected network.
4. Tap **Select automatically** to connect to the available network with the strongest signal. This may lead to your phone jumping between networks when you move around.



.....  
**Note:** Contact your service provider should you have any problems obtaining voice mail and the text message service center numbers.  
.....

## Adjusting Bluetooth settings

You can use Bluetooth to exchange information between your smartphone and other mobile devices.

## Bluetooth connections

For all Bluetooth settings, open the application menu and tap **Settings > Wireless & networks > Bluetooth settings**. Here you can switch Bluetooth on or off, set a device name and discoverability. Tap **Scan for devices** to scan for available devices.

To connect to a device, tap the device in the list of available devices. You may be asked to enter a PIN on both devices to establish the connection.

# Phone settings

Many phone settings are automatically configured by your smartphone when you insert a SIM card. The device will communicate with your provider and automatically obtain all necessary settings, such as network name, voice mail and text message center numbers.

You can also view and modify these settings manually through the Phone Settings screen.

Open the application menu and tap **Settings > Call settings**.

## Connecting to a PC

If you wish to transfer information between the microSD Card in your phone and your computer, you can connect your phone to a PC using the supplied USB cable. Plug the USB sync cable into the micro USB connector on your smartphone. Plug the USB client connector into an available USB port on your computer.

Tap the **USB** icon in the notification bar and next to "Use as a USB Drive", tap **On**.

You will now be able to see the microSD Card in your phone as a drive in your computer's file explorer.

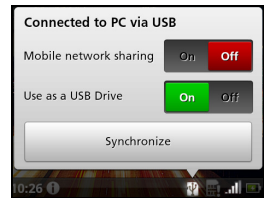

## Internet sharing

### Tethering via USB

If you wish to share your mobile Internet connection with a computer, you can connect your phone to a PC using the supplied USB cable.

1. Plug the USB sync cable into the micro USB connector on your smartphone.
2. Plug the USB client connector into an available USB port on your computer.
3. Tap the **USB** icon in the notification bar and next to "Mobile network sharing", tap **On**.
4. Alternatively, you can tap **Menu > Settings > Wireless & network settings > Tethering & portable hotspot** and then tap **USB tethering**.

### Wi-Fi hotspot

You can turn your smartphone into a portable Wi-Fi hotspot to share your mobile Internet connection with up to 8 clients.

1. Tap the notification bar and swipe to the left until you see Portable hotspot.
2. Tap **Portable hotspot** and tap **On**.
3. Tap the  icon to access the Tethering & portable hotspot page. Tap **Portable Wi-Fi hotspot settings**.
4. Tap **Configure Wi-Fi hotspot**.
5. Set the Network SSID and adjust security between Open and WPA2 PSK. Tap **Save** to finish.



**Note:** When your smartphone is serving as a Wi-Fi hotspot, you can't use your phone's applications to access the internet via its Wi-Fi connection.

## Synchronization

You can sync your calendar, email and contacts on your phone and never worry about losing them again. Sync in real time or adjust it as you please. Tap **Menu > Settings > Accounts & sync** to access the synchronization settings.

To have your smartphone auto-sync, make sure **Background data** and **Auto-sync** are checked.

To manage synchronization of individual accounts, tap an account to see their settings.

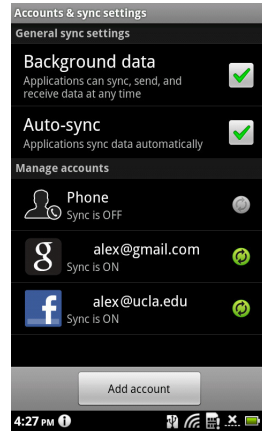

## Google Sync

In Google, you can set synchronization for contacts, email and calendar. Tap to checkmark an item you would like to have auto-sync. Tap again to uncheck any for manual synchronization.

To manually synchronize an item, tap the item.



**Note:** You need a Google account to sync your calendar and appointments.

## Acer Sync

Acer Sync allows you to easily synchronize your contacts, calendar, photos and videos between your smartphone, PC and corresponding Google services. Download and install Acer Sync and Acer PIM for the PC from <http://mobile.acer.com>.

## Multimedia playback

Your smartphone comes supplied with a variety of programs that you can use to enjoy multimedia content.

## nemoPlayer

Open **nemoPlayer** from the application menu to play media you have stored on your phone.

nemoPlayer enables you to listen to music, view video clips and pictures in the following formats.

Type	Formats
Audio playback	MP3, AMR, WMA
Ringtone	MP3, MIDI, iMelody, WAVE, WMA
Video recording	3GP, MPEG-4, H.263

Type	Formats
------	---------

Video playback	3GP, MPEG-4, H.263, H.264, WMV
----------------	--------------------------------

While listening to music, you can skip forward or backward by swinging the smartphone. You can enable or disable the feature in **Settings > Sound > Gesture controls > Music back / forward**.

- Skip forward: Swing smartphone left.
- Skip backward: Swing smartphone right.

## Spinlets

Spinlets gives you access to your favorite music, movie and television content. Get your favorite music, photos and videos from your mobile phone and share your favorite Spinlets on social networks, websites and more.



**Note:** Some contents may not be available in some countries.

## Launching Spinlets

To launch the Spinlets application, tap **Spinlets** in the application menu.

## Browsing Spinlets gallery

You can sort or search your media content by albums or genres.

### Browsing albums

Once Spinlets is opened, you will see a display of featured albums. Browse this display by sliding your finger horizontally (left or right), and select an album by tapping it.

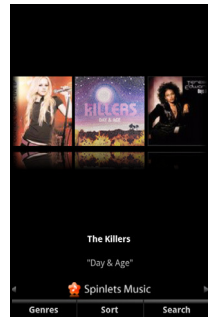

### Browsing genres

To browse the Gallery by genre, tap the **Genres** button on the bottom left corner of the screen. You will see a new screen with a list of different genres. Tap on the genre you wish to view.

### Sort

To sort through Spinlets by Name, Ratings, or Newest content, select the Sort button at the bottom of the screen.

### Search

To search the Gallery for a specific name, select the Search button at the bottom right corner of the screen. Type the name of an artist in the search box and find potential matches.

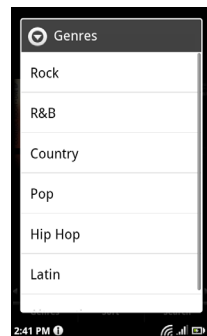

## Exploring Spinlets widgets

When you select an album, you will see a Spinlet.

To play the featured song, select the red **Play** button.

To play selected songs, select the Music tab and choose which songs you would like to play.

To view artist photos, select the Photos tab.

To visit the artist's social networks and websites, select the icons located along the bottom of the screen.

## Sharing your Spinlets

You can share your favorite Spinlets in two ways.

To post the Spinlet you are currently viewing to your social networks, blogs, or other websites, tap **Share It** at the top right corner of the Spinlet. Select Post It and tap the icon of the social network site or blog you want to post the widget to. Log in to your social network account or blog page and follow the steps.

Another way you can share Spinlets is through email. Tap **Share It** at the top right corner of the Spinlet, select Send it, and enter your name and your friend's email address.



**Note:** Fuhu, Spinlets, Spinlet, urFouz, Fouz Avatars, Fouz Creator, Fouz Card, and Fouz World are trademarks or registered trademarks of Fuhu, Inc. in the U.S. and/or other countries.

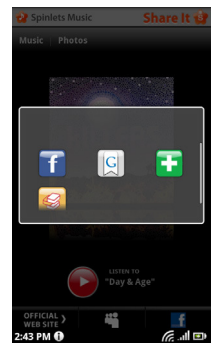
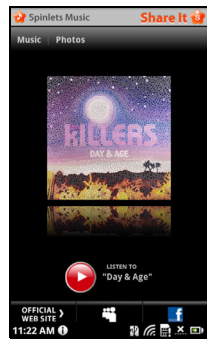

## Media server

Your phone can act as a digital media server using UPnP technology. This means that you can use it to send media content to other UPnP-enabled home entertainment devices that are connected to a home wireless network.

To set up the media server, open the application menu and tap **Media server**.

You will need to enable **Share contents** before you can start using the service.

You may select to share your **Video**, **Photo** or **Music** content from **Shared content settings**.

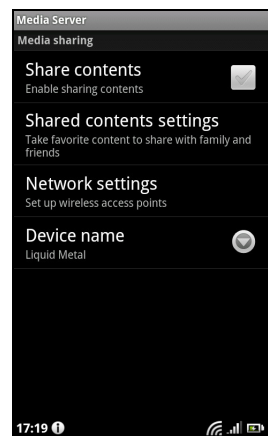



## Adjusting the volume

Adjust the volume of your smartphone using the volume buttons on the side of the device. Alternatively, you can set the **Ringtone**, **Media** and **Alarm volume** by opening the application menu and tapping **Settings > Sound > volume**.

## Setting the date and time

To set the date and time, open the application menu and tap **Settings > Date & time**.



**Tip:** If you travel frequently or live in an area that uses daylight saving time, activate **Automatic** from this menu. This will enable your smartphone to set the date and time based on information it receives from the network.

## Setting alarms

There are two predefined alarms on your phone by default. To add or edit alarm settings, tap **Alarm Clock** in the application menu and tap a preset alarm to:

- Turn the alarm on or off.
- Set the alarm time.
- Set a ringtone.
- Enable or disable vibrate.
- Set which days to repeat the alarm.
- Give it a label.

Shake the smartphone to mute an alarm. You can enable or disable this feature in **settings > Sound > Gesture controls**

## Changing language and text options

Set your location and language input preferences by opening the application menu and going to **Settings > Language & keyboard**.

## Managing applications

### App-2-SD

When installing an application, you may have a choice to install the program to the internal memory or installed memory card.

Move an installed application by going to **Settings > Applications > Manage applications** and tap **Move to SD card**.

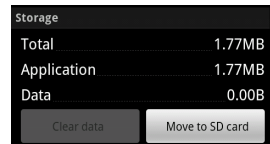

**Note:** Not all programs support App-2-SD. Please see application specifications for compatibility.



.....  
**Warning! Make sure you trust the source of any program you install. If you are not sure of the source, do not install a program. Installing programs from unknown sources increases your risk of virus attacks and theft of personal and private data.**  
.....

## Closing an application

To close an active application, go to **settings > Applications > Manage applications**. Tap the **running** tab, then tap the program you wish to close. Select **Force stop** to close the program.

## Uninstalling an application

You can remove programs installed on your smartphone to free up extra storage memory. Tap and hold a program icon from the application menu and drag it into the trash can on the bottom left hand corner.

Alternatively, you can go to **Settings** from the application menu and select **Applications > Manage applications**. Tap the application you wish to uninstall, tap **Uninstall** and confirm the uninstall.

Here you can allow programs from **Unknown sources** to be installed and **Manage applications**.



.....  
**Warning! You should only remove programs if you are familiar with the Android operating system.**  
.....

## Resetting your smartphone

You may have to perform a reset if your smartphone fails to respond when buttons are pressed or the screen is tapped.

Remove the battery cover and use the battery cover tab to press the recessed reset key. Replace the battery cover when finished.



.....  
**Note:** Before performing a reset, ensure that your smartphone is not locked. Press any key or tap the screen to see if the phone responds.  
.....

## Clean boot

A clean boot will restore your smartphone to the factory settings.



.....  
**Warning! You should only perform a clean boot when all other options have failed to restore your smartphone to an operational state.**  
.....



.....  
**Warning! This will erase all your personal information, any contacts stored on your phone and any programs you installed.**  
.....

If your phone is responding to screen input

Open **Settings** from the application menu, then tap **Privacy > Factory data reset**; click **Reset phone** and then **Erase everything** to format your phone.

### **If your phone is not responding to screen input**

Turn off your phone, then press and hold the power until you feel your smartphone vibrate and/or you see the Acer logo screen. Press and hold the Volume up and Volume down buttons. Use the Volume down button to select Clean boot: Yes. Press the camera button to confirm.

# Chapter 9: Accessories and Tips

---

This chapter shows you how to use accessories with your smartphone, as well as provide useful tips for when you are using your smartphone.

## Using the headset

Your smartphone comes packaged with a headset with built-in microphone for handsfree use when making calls, and listening to the radio.

To use the headset, plug it into the 3.5 mm headphone jack at the top of the phone.

When the headset is plugged in, all audio is routed to the headset, and the speakers are turned off.

- To answer an incoming call, press the center button on the microphone.
- Adjust the volume using the volume up/down buttons on the microphone.



.....  
**Note:** Please refrain from speaking while adjusting the volume.  
.....

- End the call by pressing the center button again.

## Using a Bluetooth headset

Your smartphone's Bluetooth functions make it fully compatible with all Bluetooth headsets. This allows you to use the unit handsfree when making calls, without the inconvenience of wires.

## Creating a new access point

When you need to add another GPRS/3G/EDGE connection on your phone, obtain the access point name and settings (including username and password if required) from your wireless service provider.

1. Open the application menu and tap **Settings > Wireless & networks > Mobile networks > Access Point Names**.
2. Tap the **Menu** button and tap **New APN**.
3. Enter the APN settings. Tap an item to adjust it.
4. When you have finished tap the **Menu** button and tap **Save**.



.....  
**Important:** Some providers and countries do not allow the use of a smartphone as a modem over HSDPA. Please check with your provider before attempting to do so.  
.....

# Appendix

---

## FAQ and troubleshooting

This section lists frequently asked questions that may arise during the use of your smartphone, and gives easy answers and solutions to these questions.

Aspect	Question	Answer
Audio	Why is there no sound coming from the device?	If the headset is plugged into the device, the speaker is automatically shut off. Disconnect the headset.  Check that the device volume setting is not muted.  Check that the volume control is not at its lowest setting.
Multimedia files	Why can't I view my picture files?	You may be trying to view an image that is not supported. Refer to <b>"Multimedia"</b> on <b>page 59</b> for more information.
	Why can't I view my video files?	You may be trying to view a video that is not supported. Refer to <b>"Multimedia"</b> on <b>page 59</b> for more information.
	Why can't I play my music files?	You may be trying to play a file that is not supported. Refer to <b>"Multimedia"</b> on <b>page 59</b> for more information.
System information and performance	How do I check the OS version of my device?	Tap <b>Menu &gt; Settings &gt; About phone</b> to check the OS version (Kernel/build number) and other hardware and software information.
Power	I couldn't turn on the device.	The battery power may be depleted. Recharge the device. Refer to <b>"SIM card lock"</b> on <b>page 12</b> for more information.
RAM / ROM	How do I check the RAM and ROM memory status?	To check the ROM status, go to <b>Settings &gt; SD card &amp; phone storage</b> .  To check RAM status, go to <b>Settings &gt; Applications &gt; Running services</b> .
Unlock pattern	I forgot my unlock pattern.	After a certain number of wrong entries, you will be presented with an option to reset your pattern. Tap <b>Forgot pattern?</b> and enter your google account username and password.   ..... <b>Note:</b> You must have an active Google account on the smartphone. .....  Alternatively, you can clean boot the smartphone and erase all data. See <b>"Clean boot"</b> on <b>page 50</b> .

Aspect	Question	Answer
Heat	The phone heats up when charging or making long duration calls.	<p>It is normal for the phone to heat up when charging. When charging is complete, it will return to its normal temperature.</p> <p>It is also normal for the phone to heat up during long periods of use, such as watching a video or a long phone conversation.</p> <p>All Acer phones are factory tested before release.</p>

## Other sources of help

For information on:	Refer to:
Up-to-date information regarding your smartphone	<a href="http://www.acer.com">http://www.acer.com</a> <a href="http://mobile.acer.com">http://mobile.acer.com</a>
Service enquiries	<a href="http://www.acer.com/support/">http://www.acer.com/support/</a>

## Warnings and precautions

- Do not use this product near water.
- Do not place this product on an unstable cart, stand or table. If the product falls, it could be seriously damaged.
- Slots and openings are provided for ventilation to ensure reliable operation of the product and to protect it from overheating. These openings must not be blocked or covered. The openings should never be blocked by placing the product on a bed, sofa, rug or other similar surface. This product should never be placed near or over a radiator or heat register, or in a built-in installation unless proper ventilation is provided.
- Never push objects of any kind into this product through cabinet slots as they may touch dangerous voltage points or short-out parts that could result in a fire or electric shock. Never spill liquid of any kind onto or into the product.
- To avoid damage of internal components and to prevent battery leakage, do not place the product on a vibrating surface.
- Never use this product when engaging in sporting activities, exercising, or in any vibrating environment which may cause a short circuit or damage, and even a risk of explosion from the battery pack.

### CAUTION when listening to music

To protect your hearing, follow these instructions.

- Increase the volume gradually until you can hear clearly and comfortably.
- Do not increase the volume level after your ears have adjusted.
- Do not listen to music at high volumes for extended periods.
- Do not increase the volume to block out noisy surroundings.
- Decrease the volume if you can't hear people speaking near you.

### Battery information

This product uses a Lithium-ion battery. Do not use it in a humid, wet and/or corrosive environment. Do not put, store or leave your product in or near a heat source, in a high

temperature location, in strong direct sunlight, in a microwave oven or in a pressurized container, and do not expose it to temperatures over 60 °C (140 °F). Failure to follow these guidelines may cause the battery to leak acid, become hot, explode or ignite and cause injury and/or damage. Do not pierce, open or disassemble the battery. If the battery leaks and you come into contact with the leaked fluids, rinse thoroughly with water and seek medical attention immediately. For safety reasons, and to prolong the lifetime of the battery, charging will not occur at low (below 0 °C/32 °F) or high (over 40 °C/104 °F) temperatures.

The full performance of a new battery is achieved only after two or three complete charge and discharge cycles. The battery can be charged and discharged hundreds of times, but it will eventually wear out. When the talk and standby times are noticeably shorter than normal, buy a new battery. Use only Acer approved batteries, and recharge your battery only with Acer approved chargers designated for this device.

Unplug the charger from the electrical plug and the device when not in use. Do not leave a fully charged battery connected to the ac charger, since overcharging may shorten its lifetime. If left unused, a fully charged battery will lose its charge over time. If the battery is completely discharged, it may take a few minutes before the charging indicator appears on the display or before any calls can be made.

Use the battery only for its intended purpose. Never use any charger or battery that is damaged.

Do not short-circuit the battery. Accidental short-circuiting can occur when a metallic object such as a coin, clip, or pen causes direct connection of the positive (+) and negative (-) terminals of the battery. (These look like metal strips on the battery.) This might happen, for example, when you carry a spare battery in your pocket or purse. Short-circuiting the terminals may damage the battery or the connecting object.

Leaving the battery in hot or cold places, such as in a closed car in summer or winter conditions, will reduce the capacity and lifetime of the battery. Always try to keep the battery between 15 °C and 25 °C (59 °F and 77 °F). A device with a hot or cold battery may not work temporarily, even when the battery is fully charged. Battery performance is particularly limited in temperatures well below freezing.

Do not dispose of batteries in a fire as they may explode. Batteries may also explode if damaged. Dispose of batteries according to local regulations. Please recycle when possible. Do not dispose as household waste.

## Replacing the battery pack

Your smartphone uses lithium batteries. Replace the battery with the same type as that which came bundled with your product. Use of another battery may present a risk of fire or explosion.



.....  
**Warning! Batteries may explode if not handled properly. Do not disassemble or dispose of them in fire. Keep them away from children. Follow local regulations when disposing of used batteries.**  
.....

## Additional safety information

Your device and its enhancements may contain small parts. Keep them out of the reach of small children.

## Operating environment



.....  
**Warning! For safety reasons, turn off all wireless or radio transmitting devices when using your smartphone device under the following conditions. These devices may include, but are not limited to: wireless LAN (WLAN), Bluetooth and/or 3G.**  
.....

Remember to follow any special regulations in force in any area, and always switch off your device when its use is prohibited or when it may cause interference or danger. Use the device only in its normal operating positions. To successfully transmit data files or messages, this device requires a good quality connection to the network. In some cases, transmission of data files or messages may be delayed until such a connection is available. Ensure that the above separation distance instructions are followed until the transmission is completed. Parts of the device are magnetic. Metallic materials may be attracted to the device, and persons with hearing aids should not hold the device to the ear with the hearing aid. Do not place credit cards or other magnetic storage media near the device, because information stored on them may be erased.

## Medical devices

Operation of any radio transmitting equipment, including wireless phones, may interfere with the functionality of inadequately protected medical devices. Consult a physician or the manufacturer of the medical device to determine if they are adequately shielded from external RF energy or if you have any questions. Switch off your device in health care facilities when any regulations posted in these areas instruct you to do so. Hospitals or health care facilities may be using equipment that could be sensitive to external RF transmissions.

**Pacemakers.** Pacemaker manufacturers recommend that a minimum separation of 15.3 cm (6") be maintained between wireless devices and a pacemaker to avoid potential interference with the pacemaker. These recommendations are consistent with the independent research by and recommendations of Wireless Technology Research. Persons with pacemakers should do the following:

- Always keep the device more than 15.3 cm (6") from the pacemaker.
- Not carry the device near your pacemaker when the device is switched on. If you suspect interference, switch off your device, and move it.

**Hearing aids.** Some digital wireless devices may interfere with some hearing aids. If interference occurs, consult your service provider.

## Vehicles

RF signals may affect improperly installed or inadequately shielded electronic systems in motor vehicles such as electronic fuel injection systems, electronic antiskid (antilock) braking systems, electronic speed control systems, and air bag systems. For more information, check with the manufacturer, or its representative, of your vehicle or any equipment that has been added. Only qualified personnel should service the device, or install the device in a vehicle. Faulty installation or service may be dangerous and may invalidate any warranty that may apply to the device. Check regularly that all wireless equipment in your vehicle is mounted and operating properly. Do not store or carry flammable liquids, gases, or explosive materials in the same compartment as the device, its parts, or enhancements. For vehicles equipped with an air bag, remember that air bags inflate with great force. Do not place objects, including installed or portable wireless equipment in the area over the air bag or in the air bag deployment area. If in-vehicle



wireless equipment is improperly installed, and the air bag inflates, serious injury could result. Using your device while flying in aircraft is prohibited. Switch off your device before boarding an aircraft. The use of wireless teledevices in an aircraft may be dangerous to the operation of the aircraft, disrupt the wireless telephone network, and may be illegal.

## Potentially explosive environments

Switch off your device when in any area with a potentially explosive atmosphere and obey all signs and instructions. Potentially explosive atmospheres include areas where you would normally be advised to turn off your vehicle engine. Sparks in such areas could cause an explosion or fire resulting in bodily injury or even death. Switch off the device at refueling points such as near gas pumps at service stations. Observe restrictions on the use of radio equipment in fuel depots, storage, and distribution areas; chemical plants; or where blasting operations are in progress. Areas with a potentially explosive atmospheres are often, but not always, clearly marked. They include below deck on boats, chemical transfer or storage facilities, vehicles using liquefied petroleum gas (such as propane or butane), and areas where the air contains chemicals or particles such as grain, dust or metal powders.

Follow any restrictions. Do not use the device where blasting is in progress.

## Emergency calls

Important: Wireless phones, including this device, operate using radio signals, wireless networks, landline networks, and user-programmed functions. Because of this, connections in all conditions cannot be guaranteed. You should never rely solely on any wireless device for essential communications like medical emergencies.

If certain features are in use, you may first need to turn those features off before you can make an emergency call. Consult this guide or your service provider for more information.

When making an emergency call, give all the necessary information as accurately as possible. Your wireless device may be the only means of communication at the scene of an accident. Do not end the call until given permission to do so.

## Disposal and recycling information



Do not throw this electronic device into the trash when discarding.

To minimize pollution and ensure utmost protection of the global environment, please recycle. For more information on the Waste from Electrical and Electronics Equipment (WEEE) regulations, visit <http://www.acer-group.com/public/Sustainability/sustainability01.htm>

### Mercury advisory



For projectors or electronic products containing an LCD/CRT monitor or display: Lamp(s) inside this product contain mercury and must be recycled or disposed of according to local, state or federal laws. For more information, contact the Electronic Industries Alliance at <http://www.eiae.org>. For lamp-specific disposal information, check <http://www.lamprecycle.org>.

# Taking care of your smartphone

1. **DO** take care not to scratch the screen of your smartphone. Keep the screen clean. When working with your smartphone, use your finger or fingernail. Never use an actual pen or pencil or other sharp object on the screen surface.
2. **DO NOT** expose your smartphone to rain or moisture. Do not let water enter the circuitry through the front panel buttons or expansion slots. In general, treat your smartphone as you would a mobile phone or other small electronic device.
3. **DO** be careful not to drop your smartphone or subject it to any strong impact. Do not place your smartphone in your back pocket.
4. **DO NOT** expose your smartphone to extreme temperatures. For example, do not leave your smartphone on the dashboard of a car on a hot day or when temperatures are below freezing point. Also, keep it away from heaters and other sources of heat.
5. **DO NOT** use or store your smartphone in any location that is dusty, damp or wet.
6. **DO** use a soft, damp cloth to clean your smartphone. If the surface of the screen becomes soiled, clean it with a soft cloth moistened with diluted window-cleaning solution.
7. **DO NOT** press down on the screen with force, otherwise you may crack the screen.

# Specifications

## Performance

- Qualcomm MSM 7230-1, 800 MHz
- System memory:
  - 512 MB of RAM
  - 512 MB of ROM
- Google Android operating system

## Display

- 3.61" WVGA TFT-LCD capacitive multi-touch screen
- 800 x 480 resolution
- 65K colors support

## Multimedia

- CD-quality stereo output
- Mono speaker
- Dual microphone
- Dolby Mobile
- Formats supported

Type	Formats
Audio playback	MP3, AMR, WMA
Ringtone	MP3, MIDI, iMelody, WAVE, WMA
Video recording	3GP, MPEG-4, H.263
Video playback	3GP, MPEG-4, H.263, H.264, WMV

## USB connector

- Micro USB connector
- USB Client
- DC power-in (5 V, 1 A)

## Connectivity

- Bluetooth 2.1+EDR & A2DP support
- IEEE Wi-Fi 802.11b/g/n WLAN
- GSM 850 / 900 / 1800 / 1900
- UMTS 900 / 1900 / 2100 (EU models)
- UMTS 850 / 1900 / 2100 (US models)
- HSDPA / HSUPA / HSPA+ / EDGE / GPRS
- GPS / AGPS

## Camera

- 5-megapixel
- Auto-focus

- Flash

## Expansion

- microSD memory card (up to 32 GB)

## Battery

- High density, rechargeable 1500 mAh Lithium-ion battery (replaceable)



.....  
**Note:** Length of battery operation will depend on power consumption which is based on system resource use. For example, constantly using the backlight or using power-demanding applications will shorten battery life between charges.  
.....

## Dimensions

- Stylish, light and robust design

Height	115 mm
Width	63 mm
Thickness	13.55 mm
Weight	<135 g (with battery)

# Regulatory information

## Compliant with Russian regulatory certification



### RoHS compliance

This product is in compliance with Directive 2002/95/EC of the European Parliament and of the Council of 27 January 2003, on the restriction of the use of certain hazardous substances in electrical and electronic equipment (RoHS) and its amendments.

### LCD pixel statement

The LCD unit is produced with high-precision manufacturing techniques. Nevertheless, some pixels may occasionally misfire or appear as black or red dots. This has no effect on the recorded image and does not constitute a malfunction.

### Radio device regulatory notice



.....  
**Note:** Regulatory information below is for models with wireless LAN and/or Bluetooth only.  
.....

### General

This product complies with the radio frequency and safety standards of any country or region in which it has been approved for wireless use. Depending on configuration, this product may or may not contain wireless radio devices (such as wireless LAN and/or Bluetooth modules). Information below is for products with such devices.

### Preventing hearing loss



.....  
**Caution: Permanent hearing loss may occur if earphones or headphones are used at high volume for prolonged periods of time.**  
.....

This device have been tested to comply with the Sound Pressure Level requirement laid down in the applicable EN 50332-1 and/or EN 50332-2 standards.



**Note:** For France, mobile headphones or earphones for this device have been tested to comply with the Sound Pressure requirement laid done in the applicable NF EN 50332-1:2000 and/or NF EN 50332-2:2003 standards as required by French Article L. 5232-1.

# Wireless operation channels for different domains

N. America	2.412-2.462 GHz	Ch01 through Ch11
Japan	2.412-2.484 GHz	Ch01 through Ch14
Europe ETSI	2.412-2.472 GHz	Ch01 through Ch13

## France: Restricted wireless frequency bands

Some areas of France have a restricted frequency band. The worst case maximum authorized power indoors is:

- 10 mW for the entire 2.4 GHz band (2400 MHz - 2483.5 MHz)
- 100 mW for frequencies between 2446.5 MHz and 2483.5 MHz



.....  
**Note:** Channels 10 through 13 inclusive operate in the band 2446.6 MHz to 2483.5 MHz.  
.....

There are few possibilities for outdoor use: On private property or on the private property of public persons, use is subject to a preliminary authorization procedure by the Ministry of Defense, with maximum authorized power of 100 mW in the 2446.5 - 2483.5 MHz band. Use outdoors on public property is not permitted.

In the departments listed below, for the entire 2.4 GHz band:

- Maximum authorized power indoors is 100 mW
- Maximum authorized power outdoors is 10 mW

Departments in which the use of the 2400 - 2483.5 MHz band is permitted with an EIRP of less than 100 mW indoors and less than 10 mW outdoors:

01 Ain Orientales	25 Doubs	59 Nord	75 Paris
02 Aisne	26 Drome	60 Oise	82 Tarn et Garonne
03 Allier	32 Gers	61 Orne	84 Vaucluse
05 Hautes Alpes	36 Indre	63 Puy Du Dome	88 Vosges
08 Ardennes	37 Indre et Loire	64 Pyrenees Atlantique	89 Yonne
09 Ariege	41 Loir et Cher	66 Pyrenees	90 Territoire de Belfort
11 Aude	45 Loret	67 Bas Rhin	94 Val de Marne
12 Aveyron	50 Manche	68 Haut Rhin	
16 Charente	55 Meuse	70 Haute Saone	
24 Dordogne	58 Nievre	71 Saone et Loire	

This requirement is likely to change over time, allowing you to use your wireless LAN card in more areas within France.

Please check with ART for the latest information (<http://www.art-telecom.fr>).



.....  
**Note:** Your WLAN Card transmits less than 100 mW, but more than 10 mW.  
.....

# List of National Codes

This equipment may be operated in the following countries:

Country	ISO 3166 2 letter code	Country	ISO 3166 2 letter code
Austria	AT	Malta	MT
Belgium	BE	Netherlands	NT
Cyprus	CY	Poland	PL
Czech Republic	CZ	Portugal	PT
Denmark	DK	Slovakia	SK
Estonia	EE	Slovenia	SL
Finland	FI	Spain	ES
France	FR	Sweden	SE
Germany	DE	United Kingdom	GB
Greece	GR	Iceland	IS
Hungary	HU	Liechtenstein	LI
Ireland	IE	Norway	NO
Italy	IT	Switzerland	CH
Latvia	LV	Bulgaria	BG
Lithuania	LT	Romania	RO
Luxembourg	LU	Turkey	TR

## FCC regulations

This mobile phone complies with part 15 of the FCC Rules. Operation is subject to the following two conditions: (1) This device may not cause harmful interference, and (2) this device must accept any interference received, including interference that may cause undesired operation.

This mobile phone has been tested and found to comply with the limits for a Class B digital device, pursuant to Part 15 of the FCC Rules. These limits are designed to provide reasonable protection against harmful interference in a residential installation. This equipment generates, uses and can radiated radio frequency energy and, if not installed and used in accordance with the instructions, may cause harmful interference to radio communications. However, there is no guarantee that interference will not occur in a particular installation. If this equipment does cause harmful interference to radio or television reception, which can be determined by turning the equipment off and on, the user is encouraged to try to correct the interference by one or more of the following measures:

- Reorient or relocate the receiving antenna.
  - Increase the separation between the equipment and receiver.
  - Connect the equipment into an outlet on a circuit different from that to which the receiver is connected.
  - Consult the dealer or an experienced radio/TV technician for help.
- Changes or modifications not expressly approved by the party responsible for compliance could void the user's authority to operate the equipment.

## RF exposure warning

The equipment complies with FCC RF exposure limits set forth for an uncontrolled environment.

The antenna(s) used for this transmitter must not be co-located or operating in conjunction with any other antenna or transmitter.

## RF exposure information (SAR)

This mobile phone meets the government's requirements for exposure to radio waves.

This phone is designed and manufactured not to exceed the emission limits for exposure to radio frequency (RF) energy set by the Federal Communications Commission of the U.S. Government.

The exposure standard for wireless mobile phones employs a unit of measurement known as the Specific Absorption Rate, or SAR. The SAR limit set by the FCC is 1.6 W/kg.

Tests for SAR are conducted using standard operating positions accepted by the FCC with the phone transmitting at its highest certified power level in all tested frequency bands. Although the SAR is determined at the highest certified power level, the actual SAR level of the phone while operating can be well below the maximum value. This is because the phone is designed to operate at multiple power levels so as to use only the power required to reach the network. In general, the closer you are to a wireless base station antenna, the lower the power output.

The highest SAR value for US model phones as reported to the FCC when tested for use at the ear is 0.768 W/kg and when worn on the body, as described in this user guide, is 1.33 W/kg.

The highest SAR value for EU model phones as reported to the FCC when tested for use at the ear is 0.95 W/kg and when worn on the body, as described in this user guide, is 0.665 W/kg.



.....  
**Important:** Body-worn measurements differ among phone models, depending upon available enhancements and FCC requirements.  
.....

While there may be differences between the SAR levels of various phones and at various positions, they all meet the government requirements.

The FCC has granted an Equipment Authorization for this model phone with all reported SAR levels evaluated as in compliance with the FCC RF exposure guidelines. SAR information on this model phone is on file with the FCC and can be found under the Display Grant section of <http://www.fcc.gov/oet/ea/fccid> after searching on **FCC ID: HLZJMS120EU** (for EU models) or **HLZJMS120** (for US models).

For body worn operation, this phone has been tested and meets the FCC RF exposure guidelines for use with accessories that contain no metal and that position the handset a minimum of 1.5 cm from the body. Use of other accessories may not ensure compliance with FCC RF exposure guidelines. If you do not use a body-worn accessory and are not holding the phone at the ear, position the handset a minimum of 1.5 cm from your body when the phone is switched on.

## Certificate Information (SAR)

This device meets the EU requirements (1999/519/EC) on the limitation of exposure of the general public to electromagnetic fields by way of health protection.

The limits are part of extensive recommendations for the protection of the general public. These recommendations have been developed and checked by independent scientific organizations through regular and thorough evaluations of scientific studies. To guarantee the safety of all persons, regardless of age and health, the limits include a significant safety buffer.

Before radio devices can be put in circulation, their agreement with European laws or limits must be confirmed; only then may the CE symbol be applied.



The unit of measurement for the European Council's recommended limit for mobile telephones is the "Specific Absorption Rate" (SAR). This SAR limit is 2.0 W/kg, averaged over 10 g of body tissue. It meets the requirements of the International Commission on Non-ionizing Radiation Protection (ICNIRP) and was included in the European Standard EN 50360 for mobile radio devices. The SAR regulation for mobile telephones is in line with European Standard EN 62209-1. The maximum SAR value is calculated at the highest output level in all frequency bands of the mobile telephone. During use, the actual SAR level is usually much lower than the maximum value, because the mobile telephone works in different output levels. It only transmits with as much output as is required to reach the network. In general the following applies: The closer you are to a base station, the lower the transmission output of your mobile telephone. The tested SAR of this device is as follows:

US model		CE		EU model		
FCC		CE		NCC		FCC
Head (W/kg)	Body (W/kg)	Head (W/kg)	Body (W/kg)	Head (W/kg)	Head (W/kg)	Body (W/kg)
0.768	1.33	0.678	1.72	0.678	0.95	0.665
FCC ID_US model				HLZJMS120		
FCC ID_EU model				HLZJMS120EU		

## For Canadian users

Operation is subject to the following two conditions: (1) this device may not cause interference, and (2) this device must accept any interference, including interference that may cause undesired operation of the device.

This Class B digital apparatus complies with Canadian ICES-003.

This Category II radiocommunication device complies with Industry Canada Standard RSS-310.

## Important note

### IC radiation exposure statement

This EUT is compliance with SAR for general population/uncontrolled exposure limits in IC RSS-102 and had been tested in accordance with the measurement methods and procedures specified in IEEE 1528. This equipment should be installed and operated with minimum distance 1.5cm between the radiator and your body.

This device and its antenna(s) must not be co-located or operating in conjunction with any other antenna or transmitter.



**Note:** The county code selection feature is disabled for products marketed in the US/Canada.

# NCC warning

## 警語

經型式認證合格之低功率射頻電機，非經許可，公司、商號或使用者均不得擅自變更頻率、加大功率或變更原設計之特性及功能。

低功率射頻電機之使用不得影響飛航安全及干擾合法通信；經發現有干擾現象時，應立即停用，並改善至無干擾時方得繼續使用。

前項合法通信，指依電信法規定作業之無線電通信。

低功率射頻電機須忍受合法通信或工業、科學及醫療用電波輻射性電機設備之干擾，減少電磁波影響，請妥善使用。



SAR 標準值 2.0 W/kg，送測產品實測值為 0.678 W/kg。

## Lithium-ion battery warning



**ATTENZIONE!** Rischio di esplosione della batteria se sostituita in modo errato. Sostituire la batteria con un una di tipo uguale o equivalente consigliata dalla fabbrica. Non disperdere le batterie nell'ambiente.



**VORSICHT!** Explosionsgefahr bei unsachgemäßen Austausch der Batterie. Ersatz nur durch denselben oder einem vom Hersteller empfohlenem ähnlichen Typ. Entsorgung gebrauchter Batterien nach Angaben des Herstellers.



**ADVARSEL!** Lithiumbatteri - Eksplosionsfare ved fejlagtig håndtering. Udskiftning må kun ske med batteri af samme fabrikat og type. Levér det brugte batteri tilbage til leverandøren.



**VARNING!** Explosionsfara vid felaktigt batteribyte. Använd samma batterityp eller en ekvivalent typ som rekommenderas av apparattillverkaren. Kassera använt batteri enligt fabrikantens instruktion.



**VAROITUS!** Paristo voi räjähtää, jos se on virheellisesti asennettu. Vaihda paristo ainoastaan laitevalmistajan suosittelemaan tyyppiin. Hävitä käytetty paristo valmistagan ohjeiden mukaisesti.



**ATTENTION !** Il y a danger d'explosion s'il y a remplacement incorrect de la batterie. Remplacer uniquement avec une batterie du môme type ou d' un type équivalent recommandé par le constructeur. Mettre au rebut les batteries usagées conformément aux instructions du fabricant.



**ADVARSEL!** Eksplosjonsfare ved feilaktig skifte av batteri. Benytt samme batteritype eller en tilsvarende type anbefalt av apparatfabrikanten. Brukte batterier kasseres i henhold til fabrikantens instruksjoner.

# CE 0682 ⓘ

Acer Incorporated

Date: September 16, 2010

## Declaration of Conformity

We, Acer Incorporated,  
of 8F., No. 88, Sec. 1, Hsin Tai Wu Rd. Hsichih Taipei Hsien 221, Taiwan  
Declare under sole responsibility that the product:

Model: S120

Description: Smart HandHeld

To which this declaration relates, is in conformity with the following standards and/ or other normative documents:

- EN 301 511 V9.0.2
- EN 300 328 V1.7.1
- EN 301 908-1/-2 V3.2.1
- EN 300 440-1 V1.5.1/ EN300 440-2 V1.3.1
- EN 301 489-1 V1.8.1/ -3 V1.4.1/ -7 V1.3.1/ -17 V2.1.1/ -24 V1.4.1
- EN 55022:2006/A1:2007 Class B; EN 55024:1998/A1:2001/A2:2003
- EN 55013:2001/A1:2003/A2:2006; EN 55020:2007
- EN 60950-1: 2006+A11:2009
- EN 50332-1:2000/ -2: 2003
- EN 50360:2001/ EN 62209-1:2006/ EN62311:2008/ OET65C

We hereby declare that the above named product is in conformance to all the essential requirements of the R&TTE Directive (99/5/EC) issued by the Commission of the European Community.

The conformity assessment procedure referred to in Article 10 and detailed in Annex [IV] of directive 1999/5/EC has been followed related to Articles

- R&TTE Article 3.1 (a) Health and Safety
- R&TTE Article 3.1 (b) EMC
- R&TTE Article 3.2 Spectrum Usage

with the involvement of the following Notified Body:

**CETECOM, Untertuerkheimer Str. 6 – 10 66117 Saarbruecken**

Identification mark: **0682** (Notified Body) **CE**

The technical documentation relevant to the above equipment will be held at:

Acer Incorporated

8F., No. 88, Sec. 1, Hsin Tai Wu Rd. Hsichih Taipei Hsien 221, Taiwan

Authorized Person:

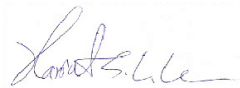

Name: Harriot S.L. Lee