

Aspire One Series

Quick Guide

© 2011 All Rights Reserved.

Aspire One Series Quick Guide
Original Issue: 06/2011

Model number: _____

Serial number: _____

Date of purchase: _____

Place of purchase: _____

First things first

We would like to thank you for making an Acer notebook your choice for meeting your mobile computing needs.

Your guides

To help you use your Acer notebook, we have designed a set of guides:

First off, the **setup poster** helps you get started with setting up your computer.

The **Aspire One Generic User Guide** contains useful information applying to all models in the Aspire product series. It covers basic topics such as using the keyboard and audio, etc. Please understand that due to its nature, the **Generic User Guide** will occasionally refer to functions or features which are only contained in certain models of the series, but not necessarily in the model you purchased. Such instances are marked in the text with language such as "only for certain models".

The **Quick Guide** introduces you to the basic features and functions of your new computer. For more on how your computer can help you to be more productive, please refer to the **Aspire One Generic User Guide**. This guide contains detailed information on such subjects as system utilities, data recovery, expansion options and troubleshooting. In addition it contains warranty information and the general regulations and safety notices for your notebook. It is available in Portable Document Format (PDF) and comes preloaded on your notebook. Follow these steps to access it:

- 1 Click on  **Start > All Programs > AcerSystem**.
- 2 Click on **AcerSystem User Guide**.



Note: Viewing the file requires Adobe Reader. If Adobe Reader is not installed on your computer, clicking on **AcerSystem User Guide** will run the Adobe Reader setup program first. Follow the instructions on the screen to complete the installation. For instructions on how to use Adobe Reader, access the **Help and Support** menu.

Your Acer notebook tour

After setting up your computer as illustrated in the **setup poster**, let us show you around your new Acer notebook.

Top view

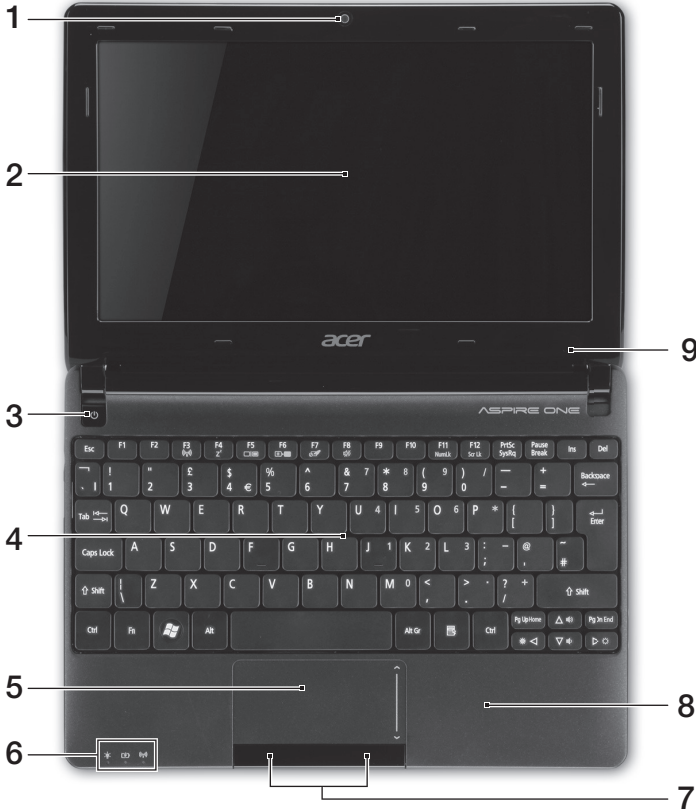

#	Icon	Item	Description
1		Integrated webcam	Web camera for video communication (configuration may vary by model).





#	Icon	Item	Description
2		Display screen	Also called Liquid-Crystal Display (LCD), displays computer output (configuration may vary by model).
3		Power button	Turns the computer on and off.
4		Keyboard	For entering data into your computer.
5		Touchpad	Touch-sensitive pointing device which functions like a computer mouse.
6		Status indicators ¹	Light-Emitting Diodes (LED) that light up to show the status of the computer's functions and components.
7		Click buttons (left and right)	The left and right buttons function like the left and right mouse buttons.
8		Palmrest	Comfortable support area for your hands when you use the computer.
9		Microphone	Internal microphone for sound recording.





1. The front panel indicators are visible even when the computer cover is closed.

Hotkeys

The computer employs hotkeys or key combinations to access most of the computer's controls like screen brightness and volume output.

To activate hotkeys, press and hold the <Fn> key before pressing the other key in the hotkey combination.

Hotkey	Icon	Function	Description
<Fn> + <F3>		Communication	Enables/disables the computer's communication devices. (Communication devices may vary by configuration.)
<Fn> + <F4>		Sleep	Puts the computer in Sleep mode.
<Fn> + <F5>		Display toggle	Switches display output between the display screen, external monitor (if connected) and both.
<Fn> + <F6>		Screen blank	Turns the display screen backlight off to save power. Press any key to return.
<Fn> + <F7>		Touchpad toggle	Turns the internal touchpad on and off.

Hotkey	Icon	Function	Description
<Fn> + <F8>		Speaker toggle	Turns the speakers on and off.
<Fn> + <F11>		Num Lock	When Num Lock is on, the embedded keypad is in numeric mode. The keys function as a calculator (complete with the arithmetic operators +, -, *, and /). Use this mode when you need to do a lot of numeric data entry. A better solution would be to connect an external keypad. <Fn> + <F11> only for certain models.
<Fn> + <F12>		Scroll Lock	When Scroll Lock is on, the screen moves one line up or down when you press the up or down arrow keys respectively. Scroll Lock does not work with some applications.
<Fn> + <D>		Brightness up	Increases the screen brightness.
<Fn> + <L>		Brightness down	Decreases the screen brightness.
<Fn> + <A>		Volume up	Increases the sound volume (only for certain models).
<Fn> + <V>		Volume down	Decreases the sound volume (only for certain models).

Using the communication key*

Here you can enable and disable the various wireless connectivity devices on your computer.

Press <Fn> + <F3> to bring up the Launch Manager window panel.

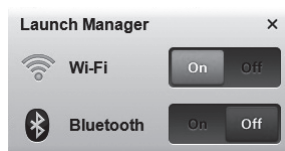

A red toggle indicates the device is off. Click On to enable Wi-Fi/Bluetooth connection. Click Off to disable connection.



* Communication devices may vary by model.

Closed front view



#	Icon	Item	Description						
		Power indicator	Indicates the computer's power status.						
1		Battery indicator	Indicates the computer's battery status. 1. Charging: The light shows amber when the battery is charging. 2. Fully charged: The light shows blue when in AC mode.						
		Communication indicator	Indicates the status of 3G / Wi-Fi communication <table border="1"> <thead> <tr> <th>Blue light on</th> <th>Orange light on</th> <th>Not lit</th> </tr> </thead> <tbody> <tr> <td>3G on / Wi-Fi on 3G on / Wi-Fi off</td> <td>3G off / Wi-Fi on</td> <td>3G off / Wi-Fi off</td> </tr> </tbody> </table>	Blue light on	Orange light on	Not lit	3G on / Wi-Fi on 3G on / Wi-Fi off	3G off / Wi-Fi on	3G off / Wi-Fi off
Blue light on	Orange light on	Not lit							
3G on / Wi-Fi on 3G on / Wi-Fi off	3G off / Wi-Fi on	3G off / Wi-Fi off							

Rear view









#	Item	Description
1	Battery bay	Houses the computer's battery pack.

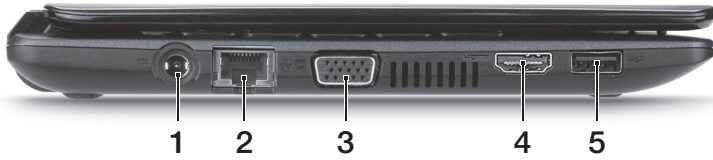

Note: Your computer may be equipped with a different battery to the one in the picture.



Left view



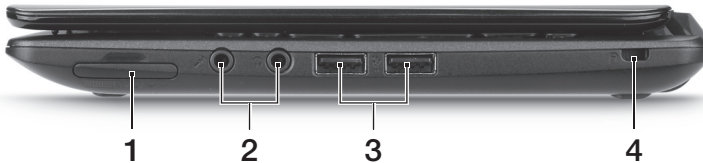

#	Icon	Item	Description
1		DC-in jack	Connects to an AC adapter.
2		Ethernet (RJ-45) port	Connects to an Ethernet 10/100 based network.
3		External display (VGA) port	Connects to a display device (e.g., external monitor, LCD projector).
4		HDMI port	Supports high-definition digital video connections.
5		USB port	Connects to USB devices (e.g., USB mouse, USB camera).

Right view





#	Icon	Item	Description
1		Multi-in-1 card reader	Accepts Secure Digital (SD), MultiMediaCard (MMC), Memory Stick (MS), Memory Stick PRO (MS PRO), xD-Picture Card (xD). Note: Push to remove/install the card. Only one card can operate at any given time.
2		Headphone/speaker/line-out jack	Connects to audio line-out devices (e.g., speakers, headphones).
		Microphone-in jack	Accepts inputs from external microphones.

#	Icon	Item	Description
3		USB ports	Connect to USB devices (e.g., USB mouse, USB camera).
4		Kensington lock slot	Connects to a Kensington-compatible computer security lock.

Base view



#	Icon	Item	Description
1		Ventilation slots and cooling fan	Enable the computer to stay cool, even after prolonged use. Note: Do not cover or obstruct the opening of the fan.
2		Battery release latch	Releases the battery for removal.
3		3G SIM card slot	Accepts a 3G SIM card for 3G connectivity (only for certain models).
4		Battery bay	Houses the computer's battery pack.

#	Icon	Item	Description
5		Battery lock	Locks the battery in position.
6		Speaker	Emits audio from your computer.

Environment

- Temperature:
 - Operating: 5 °C to 35 °C
 - Non-operating: -20 °C to 65 °C
 - Humidity (non-condensing):
 - Operating: 20% to 80%
 - Non-operating: 20% to 80%
-