

ELECTROMAGNETIC EMISSIONS COMPLIANCE REPORT

INTENTIONAL RADIATOR CERTIFICATION TO FCC PART 22 SUBPART H, PART 24 SUBPART E CLASS II PC REPORT

For

Product Description: 3G MODULE

Trade Name: Acer

Model Name of Host: NAV70

**Model No. for WWAN
Module** FCC: EM770W

FCC ID: HLZEM770W

Report No.: EH/2010/50025

Issue Date: Jun. 03, 2010

FCC Rule Part: 2, 22H & 24E

Prepared for: Acer Incorporated
8F,88, Sec. 1, Hsin Tai Wu Rd. Hsichih Taipei Hsien 221

Prepared by: SGS Taiwan Ltd.
Electronics & Communication Laboratory
No. 134, Wu Kung Rd., Wuku Industrial Zone, Taipei
County, Taiwan.

Note: This report shall not be reproduced except in full, without the written approval of SGS Taiwan Ltd. This document may be altered or revised by SGS Taiwan Ltd. personnel only, and shall be noted in the revision section of the document.

Unless otherwise stated the results shown in this test report refer only to the sample(s) tested and such sample(s) are retained for 90 days only.

除非另有說明，此報告結果僅對測試之樣品負責，同時此樣品僅保留90天。本報告未經本公司書面許可，不可部份複製。

This document is issued by the Company subject to its General Conditions of Service printed overleaf, available on request or accessible at www.sgs.com/terms_and_conditions.htm and for electronic format documents, subject to Terms and Conditions for Electronic Documents at www.sgs.com/terms_e-document.htm. Attention is drawn to the limitation of liability, indemnification and jurisdiction issues defined therein. Any holder of this document is advised that information contained hereon reflects the Company's findings at the time of its intervention only and within the limits of Client's instructions, if any. The Company's sole responsibility is to its Client and this document does not exonerate parties to a transaction from exercising all their rights and obligations under the transaction documents. This document cannot be reproduced except in full, without prior written approval of the Company. Any unauthorized alteration, forgery or falsification of the content or appearance of this document is unlawful and offenders may be prosecuted to the fullest extent of the law.

SGS Taiwan Ltd.

No.134, Wu Kung Road, Wuku Industrial Zone, Taipei County, Taiwan / 台北縣五股工業區五工路 134 號

台灣檢驗科技股份有限公司

t (886-2) 2299-3279

f (886-2) 2298-0488

www.tw.sgs.com

Member of SGS Group

CERTIFICATION OF COMPLIANCE

Applicant: Acer Incorporated
 8F,88, Sec. 1, Hsin Tai Wu Rd. Hsichih Taipei Hsien 221

Product Description: 3G MODULE

Trade Name: Acer

FCC ID: HLZEM770W

Model No of the host NAV70

Model No. for WWAN FCC: EM770W

Modular:

File Number: EH/2010/50025

Date of test: May. 25, 2010 ~ May. 31, 2010

Date of EUT Received: May. 25, 2010

We hereby certify that:

The above equipment was tested by SGS Taiwan Ltd. Electronics & Communication Laboratory The test data, data evaluation, test procedures, and equipment configurations shown in this report were made in accordance with the procedures given in TIA/EIA-603-C-2004 and the energy emitted by the sample EUT tested as described in this report is in compliance with conducted and radiated emission limits of FCC Rule PART 22 subpart H, PART 24 subpart E.

The test results of this report relate only to the tested sample identified in this report.

Test By: Bondi Liu **Date:** Jun. 03, 2010

Bondi Liu / Engineer

Prepared By: Alex Hsieh **Date:** Jun. 03, 2010

Alex Hsieh /Sr. Engineer

Approved By: Vincent Su **Date:** Jun. 03, 2010

Vincent Su / Manager

Unless otherwise stated the results shown in this test report refer only to the sample(s) tested and such sample(s) are retained for 90 days only.

除非另有說明，此報告結果僅對測試之樣品負責，同時此樣品僅保留90天。本報告未經本公司書面許可，不可部份複製。

This document is issued by the Company subject to its General Conditions of Service printed overleaf, available on request or accessible at www.sgs.com/terms_and_conditions.htm and for electronic format documents, subject to Terms and Conditions for Electronic Documents at www.sgs.com/terms_e-document.htm. Attention is drawn to the limitation of liability, indemnification and jurisdiction issues defined therein. Any holder of this document is advised that information contained hereon reflects the Company's findings at the time of its intervention only and within the limits of Client's instructions, if any. The Company's sole responsibility is to its Client and this document does not exonerate parties to a transaction from exercising all their rights and obligations under the transaction documents. This document cannot be reproduced except in full, without prior written approval of the Company. Any unauthorized alteration, forgery or falsification of the content or appearance of this document is unlawful and offenders may be prosecuted to the fullest extent of the law.



Version

Version No.	Date	Description
00	Jun. 03, 2010	Initial creation of document

Unless otherwise stated the results shown in this test report refer only to the sample(s) tested and such sample(s) are retained for 90 days only.

除非另有說明，此報告結果僅對測試之樣品負責，同時此樣品僅保留90天。本報告未經本公司書面許可，不可部份複製。

This document is issued by the Company subject to its General Conditions of Service printed overleaf, available on request or accessible at www.sgs.com/terms_and_conditions.htm and for electronic format documents, subject to Terms and Conditions for Electronic Documents at www.sgs.com/terms_e-document.htm. Attention is drawn to the limitation of liability, indemnification and jurisdiction issues defined therein. Any holder of this document is advised that information contained hereon reflects the Company's findings at the time of its intervention only and within the limits of Client's instructions, if any. The Company's sole responsibility is to its Client and this document does not exonerate parties to a transaction from exercising all their rights and obligations under the transaction documents. This document cannot be reproduced except in full, without prior written approval of the Company. Any unauthorized alteration, forgery or falsification of the content or appearance of this document is unlawful and offenders may be prosecuted to the fullest extent of the law.

SGS Taiwan Ltd.

No.134, Wu Kung Road, Wuku Industrial Zone, Taipei County, Taiwan / 台北縣五股工業區五工路 134 號

台灣檢驗科技股份有限公司

t (886-2) 2299-3279

f (886-2) 2298-0488

www.tw.sgs.com

Member of SGS Group

Table of Contents

1. GENERAL INFORMATION	5
1.1 Host Description	5
1.2 Related Submittal(s) / Grant (s)	8
1.3 Test Methodology	8
1.4 Test Facility	8
1.5 Special Accessories	8
1.6 Equipment Modifications.....	8
2. SYSTEM TEST CONFIGURATION	9
2.1 EUT Configuration	9
2.2 EUT Exercise	9
2.3 Test Procedure.....	9
2.4 Configuration of Tested System.....	10
3. SUMMARY OF TEST RESULTS	11
4. DESCRIPTION OF TEST MODES	11
5. RF POWER OUTPUT/ MAXMUM POWER REDUCTION MEASUREMENT	12
5.1 Standard Applicable:	12
5.2 Test Set-up:	12
5.3 Measurement Procedure:	12
5.4 Measurement Equipment Used:	12
5.5 Measurement Result:	13
6. ERP/EIRP MEASUREMENT	14
6.1 Standard Applicable	14
6.2 Test SET-UP (Block Diagram of Configuration).....	14
6.3 Measurement Procedure.....	16
6.4 Measurement Equipment Used:	17
6.5 Measurement Result.....	17
Measurement Result:	18
7. FIELD STRENGTH OF SPURIOUS RADIATION MEASUREMENT	19
7.1 Standard Applicable	19
7.2 EUT Setup (Block Diagram of Configuration).....	19
7.3 Measurement Procedure.....	20
7.4 Measurement Equipment Used:	20
7.5 Measurement Result.....	20

Unless otherwise stated the results shown in this test report refer only to the sample(s) tested and such sample(s) are retained for 90 days only.

除非另有說明，此報告結果僅對測試之樣品負責，同時此樣品僅保留90天。本報告未經本公司書面許可，不可部份複製。

This document is issued by the Company subject to its General Conditions of Service printed overleaf, available on request or accessible at www.sgs.com/terms_and_conditions.htm and for electronic format documents, subject to Terms and Conditions for Electronic Documents at www.sgs.com/terms_e-document.htm. Attention is drawn to the limitation of liability, indemnification and jurisdiction issues defined therein. Any holder of this document is advised that information contained hereon reflects the Company's findings at the time of its intervention only and within the limits of Client's instructions, if any. The Company's sole responsibility is to its Client and this document does not exonerate parties to a transaction from exercising all their rights and obligations under the transaction documents. This document cannot be reproduced except in full, without prior written approval of the Company. Any unauthorized alteration, forgery or falsification of the content or appearance of this document is unlawful and offenders may be prosecuted to the fullest extent of the law.

1. GENERAL INFORMATION

1.1 Host Description

General:

Product Name	3G MODULE	
Brand Name	Acer	
Model Name	NAV70	
Marketing Name:	N/A	
Model Difference	N/A	
FCC ID:	HLZEM770W	
Model No. for WWAN Module:	FCC: EM770W	
Power Supply	11.1Vdc Li-Ion Battery or 19Vdc by AC/DC power adapter	
	Battery:	Model:AL10A31 ,Supplier: Acer Computer Co., Ltd.
	Adaptor:	Model No.: IU40-11190-010S Supplier: LEADER ELECTRONICS, INC.

Unless otherwise stated the results shown in this test report refer only to the sample(s) tested and such sample(s) are retained for 90 days only.

除非另有說明，此報告結果僅對測試之樣品負責，同時此樣品僅保留90天。本報告未經本公司書面許可，不可部份複製。

This document is issued by the Company subject to its General Conditions of Service printed overleaf, available on request or accessible at www.sgs.com/terms_and_conditions.htm and for electronic format documents, subject to Terms and Conditions for Electronic Documents at www.sgs.com/terms_e-document.htm. Attention is drawn to the limitation of liability, indemnification and jurisdiction issues defined therein. Any holder of this document is advised that information contained hereon reflects the Company's findings at the time of its intervention only and within the limits of Client's instructions, if any. The Company's sole responsibility is to its Client and this document does not exonerate parties to a transaction from exercising all their rights and obligations under the transaction documents. This document cannot be reproduced except in full, without prior written approval of the Company. Any unauthorized alteration, forgery or falsification of the content or appearance of this document is unlawful and offenders may be prosecuted to the fullest extent of the law.

GSM and WCDMA:

Cellular Phone Standards Frequency Range and Power:	Operating Frequency		Rated Power
	GSM/GPRS 850, Class 10	824.2 MHz– 848.8MHz	33 dBm
	EDGE 850, Class 10	824.2 MHz– 848.8MHz	27 dBm
	GSM/GPRS 900, Class 10	880.2MHz – 914.8MHz	33 dBm
	EDGE 900, Class 10	880.2MHz – 914.8MHz	27 dBm
	GSM/GPRS 1800, Class 10	1710.2MHz – 1784.8MHz	30 dBm
	EDGE 1800, Class 10	1710.2MHz – 1784.8MHz	26dBm
	GSM/GPRS 1900, Class 10	1850.2MHz – 1909.8MHz	30 dBm
	EDGE 1900, Class 10	1850.2MHz – 1909.8MHz	26 dBm
	WCDMA/HSUPA/HSDPA Band I	1922.4MHz – 1977.6MHz	24 dBm
	WCDMA/HSUPA/HSDPA Band II	1852.40MHz – 1907.6MHz	24 dBm
	WCDMA/HSUPA/HSDPA Band V	826.40MHz – 846.6MHz	24 dBm
	WCDMA/HSUPA/HSDPA Band VIII	882.4MHz – 912.6MHz	24 dBm
Hardware Version:	MD32TCPU		
Software Version:	11.126.07.02.00		
IMEI:	358823030001856		
WWAN module FCC ID:	HLZEM770W		

Unless otherwise stated the results shown in this test report refer only to the sample(s) tested and such sample(s) are retained for 90 days only.

除非另有說明，此報告結果僅對測試之樣品負責，同時此樣品僅保留90天。本報告未經本公司書面許可，不可部份複製。

This document is issued by the Company subject to its General Conditions of Service printed overleaf, available on request or accessible at www.sgs.com/terms_and_conditions.htm and for electronic format documents, subject to Terms and Conditions for Electronic Documents at www.sgs.com/terms_e-document.htm. Attention is drawn to the limitation of liability, indemnification and jurisdiction issues defined therein. Any holder of this document is advised that information contained hereon reflects the Company's findings at the time of its intervention only and within the limits of Client's instructions, if any. The Company's sole responsibility is to its Client and this document does not exonerate parties to a transaction from exercising all their rights and obligations under the transaction documents. This document cannot be reproduced except in full, without prior written approval of the Company. Any unauthorized alteration, forgery or falsification of the content or appearance of this document is unlawful and offenders may be prosecuted to the fullest extent of the law.

SGS Taiwan Ltd. | No.134, Wu Kung Road, Wuku Industrial Zone, Taipei County, Taiwan / 台北縣五股工業區五工路 134 號

Class II Permissive change:	Adding Acer's 3G MODULE on NAV70 notebook computer
Type of Emission:	22H(GMSK): 824.2 - 848.8 MHz: 300KGXW 24E(GMSK): 1850.2 - 1909.8 MHz: 300KGXW 22H(8PSK): 824.2 - 848.8 MHz: 300KG7W 24E(8PSK): 1850.2 - 1909.8 MHz: 300KG7W 22H(WCDMA): 826.4 - 846.6 MHz: 4M20F9W 24E(WCDMA): 1852.4 - 1907.5 MHz: 4M20F9W
Transmit power (Conducted Power) Listed in Original Grant:	22H(GMSK): 824.2 - 848.8 MHz: 1.82W 24E(GMSK): 1850.2 - 1909.8 MHz: 0.97W 22H(8PSK): 824.2 - 848.8 MHz: 0.52W 24E(8PSK): 1850.2 - 1909.8 MHz: 0.42W 22H(WCDMA): 826.4 - 846.6 MHz: 0.17W 24E(WCDMA): 1852.4 - 1907.5 MHz: 0.18W

This test report applies for GPRS/EDGE 850, GPRS/EDGE 1900, WCDMA/HSUPA/HSDPA Band II/V bands.

Unless otherwise stated the results shown in this test report refer only to the sample(s) tested and such sample(s) are retained for 90 days only.

除非另有說明，此報告結果僅對測試之樣品負責，同時此樣品僅保留90天。本報告未經本公司書面許可，不可部份複製。

This document is issued by the Company subject to its General Conditions of Service printed overleaf, available on request or accessible at www.sgs.com/terms_and_conditions.htm and for electronic format documents, subject to Terms and Conditions for Electronic Documents at www.sgs.com/terms_e-document.htm. Attention is drawn to the limitation of liability, indemnification and jurisdiction issues defined therein. Any holder of this document is advised that information contained hereon reflects the Company's findings at the time of its intervention only and within the limits of Client's instructions, if any. The Company's sole responsibility is to its Client and this document does not exonerate parties to a transaction from exercising all their rights and obligations under the transaction documents. This document cannot be reproduced except in full, without prior written approval of the Company. Any unauthorized alteration, forgery or falsification of the content or appearance of this document is unlawful and offenders may be prosecuted to the fullest extent of the law.

1.2 Related Submittal(s) / Grant (s)

This submittal(s) (test report) is intended for **FCC ID: HLZEM770W** filing to comply with Section Part 22 subpart H, Part 24 subpart E of the FCC CFR 47 Rules.

1.3 Test Methodology

Both conducted and radiated testing were performed according to the procedures document on TIA/EIA-603-C-2004 and FCC CFR 47 2.1046, 2.1053

1.4 Test Facility

The measurement facilities used to collect the 3m Radiated Emission and AC power line conducted data are located on the address of SGS Taiwan Ltd. Electronics & Communication Laboratory No. 134, Wu Kung Rd., Wuku Industrial Zone, Taipei Country, Taiwan which are constructed and calibrated to meet the FCC requirements in documents ANSI C63.4: 2003. FCC Registration Number are: 990257 and 236194, Canada Registration Number: 4620A-1

The 10 m Open Area Test Sites located on the address of SGS Taiwan Ltd. Electronics & Communication Laboratory No. 29, Pau-Tou-Tsuo Valley Chia-Pau Tsuen, Linkou Hsiang, Taipei county, which is constructed and calibrated to meet the CISPR 22/EN 55022 requirements. SGS Site No. 1(3 &10 meters) and FCC Registration Number: 94644.

1.5 Special Accessories

Not available for this EUT intended for grant.

1.6 Equipment Modifications

Not available for this EUT intended for grant.

Unless otherwise stated the results shown in this test report refer only to the sample(s) tested and such sample(s) are retained for 90 days only.

除非另有說明，此報告結果僅對測試之樣品負責，同時此樣品僅保留90天。本報告未經本公司書面許可，不可部份複製。

This document is issued by the Company subject to its General Conditions of Service printed overleaf, available on request or accessible at www.sgs.com/terms_and_conditions.htm and for electronic format documents, subject to Terms and Conditions for Electronic Documents at www.sgs.com/terms_e-document.htm. Attention is drawn to the limitation of liability, indemnification and jurisdiction issues defined therein. Any holder of this document is advised that information contained hereon reflects the Company's findings at the time of its intervention only and within the limits of Client's instructions, if any. The Company's sole responsibility is to its Client and this document does not exonerate parties to a transaction from exercising all their rights and obligations under the transaction documents. This document cannot be reproduced except in full, without prior written approval of the Company. Any unauthorized alteration, forgery or falsification of the content or appearance of this document is unlawful and offenders may be prosecuted to the fullest extent of the law.

2. SYSTEM TEST CONFIGURATION

2.1 EUT Configuration

The EUT configuration for testing is installed on RF field strength measurement to meet the Commissions requirement and operating in a manner which intends to maximize its emission characteristics in a continuous normal application.

2.2 EUT Exercise

The EUT (Transmitter) was operated in the engineering mode to fix the Tx frequency which was for the purpose of the measurements.

2.3 Test Procedure

2.3.1 Conducted Measurement at Antenna Port:

According to measurement procured TIA/EIA 603C, the EUT is placed on a turn table which is 0.8 m above ground plane. A low loss of RF cable was used to connect the antenna port of EUT to measurement equipment.

2.3.2 Radiated Emissions (ERP/EIRP):

According to measurement procured TIA/EIA 603C TIA/EIA IS-98 for Mobile stations. The EUT is placed on a turn table which is 0.8 m above ground plane. The turn table shall rotate 360 degrees to determine the position of maximum emission level. EUT is set 3m away from the receiving antenna which varied from 1m to 4m to find out the highest emission. And also, each emission was to be maximized by changing the polarization of receiving antenna both horizontal and vertical. In order to find out the max. emission, the relative positions of this hand-held transmitter (EUT) was rotated through three orthogonal axes according to the requirements.

A standard antenna was used to replace the EUT and connect to the SG. Adjust the SG output level to reach the max emission level which were measured above.

Unless otherwise stated the results shown in this test report refer only to the sample(s) tested and such sample(s) are retained for 90 days only.

除非另有說明，此報告結果僅對測試之樣品負責，同時此樣品僅保留90天。本報告未經本公司書面許可，不可部份複製。

This document is issued by the Company subject to its General Conditions of Service printed overleaf, available on request or accessible at www.sgs.com/terms_and_conditions.htm and for electronic format documents, subject to Terms and Conditions for Electronic Documents at www.sgs.com/terms_e-document.htm. Attention is drawn to the limitation of liability, indemnification and jurisdiction issues defined therein. Any holder of this document is advised that information contained hereon reflects the Company's findings at the time of its intervention only and within the limits of Client's instructions, if any. The Company's sole responsibility is to its Client and this document does not exonerate parties to a transaction from exercising all their rights and obligations under the transaction documents. This document cannot be reproduced except in full, without prior written approval of the Company. Any unauthorized alteration, forgery or falsification of the content or appearance of this document is unlawful and offenders may be prosecuted to the fullest extent of the law.

SGS Taiwan Ltd.

No.134, Wu Kung Road, Wuku Industrial Zone, Taipei County, Taiwan / 台北縣五股工業區五工路 134 號

台灣檢驗科技股份有限公司

t (886-2) 2299-3279

f (886-2) 2298-0488

www.tw.sgs.com

Member of SGS Group

2.4 Configuration of Tested System

Fig. 1-1 Configuration for Radiated Emission

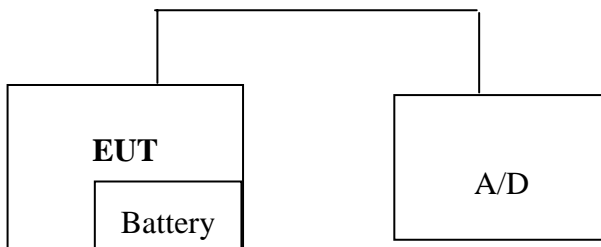

Fig. 1-2 Configuration (Remote Side, on the corner)

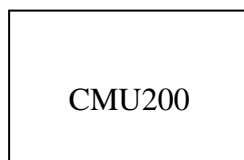

Table 2-1 Equipment Used in Tested System

Item	Equipment	Mfr/Brand	Model/ Type No.	Series No.	Data Cable	Power Cord
1.	Universal Radio Communication Tester	R&S	CMU200	102189	Shielded	Un-shielded

Unless otherwise stated the results shown in this test report refer only to the sample(s) tested and such sample(s) are retained for 90 days only.

除非另有說明，此報告結果僅對測試之樣品負責，同時此樣品僅保留90天。本報告未經本公司書面許可，不可部份複製。

This document is issued by the Company subject to its General Conditions of Service printed overleaf, available on request or accessible at www.sgs.com/terms_and_conditions.htm and for electronic format documents, subject to Terms and Conditions for Electronic Documents at www.sgs.com/terms_e-document.htm. Attention is drawn to the limitation of liability, indemnification and jurisdiction issues defined therein. Any holder of this document is advised that information contained hereon reflects the Company's findings at the time of its intervention only and within the limits of Client's instructions, if any. The Company's sole responsibility is to its Client and this document does not exonerate parties to a transaction from exercising all their rights and obligations under the transaction documents. This document cannot be reproduced except in full, without prior written approval of the Company. Any unauthorized alteration, forgery or falsification of the content or appearance of this document is unlawful and offenders may be prosecuted to the fullest extent of the law.

SGS Taiwan Ltd.

No.134, Wu Kung Road, Wuku Industrial Zone, Taipei County, Taiwan / 台北縣五股工業區五工路 134 號

台灣檢驗科技股份有限公司

t (886-2) 2299-3279

f (886-2) 2298-0488

www.tw.sgs.com

Member of SGS Group

3. SUMMARY OF TEST RESULTS

FCC Rules	Description Of Test	Result
24.232(C) 22.913(a)(2)	RF Power output / Maximum power reduction measurement	Compliant
§2.1046(a) §22.913(a)(2) §24.232(c)	ERP/ EIRP measurement	Compliant
§2.1053 §22.917(a) §24.238(a)	Field Strength of Spurious Radiation	Compliant

4. DESCRIPTION OF TEST MODES

The EUT has been tested under operating condition.

Set EUT power control max power for all test mode through base station.

The Channel Low, Mid and High for each type of bands with rated data rate were chosen for above testing.

The field strength of ERP/EIRP power and spurious radiation emission were measured as EUT stand up position for both GPRS 850 and 1900 bands were reported which has worst data.

Unless otherwise stated the results shown in this test report refer only to the sample(s) tested and such sample(s) are retained for 90 days only.

除非另有說明，此報告結果僅對測試之樣品負責，同時此樣品僅保留90天。本報告未經本公司書面許可，不可部份複製。

This document is issued by the Company subject to its General Conditions of Service printed overleaf, available on request or accessible at www.sgs.com/terms_and_conditions.htm and for electronic format documents, subject to Terms and Conditions for Electronic Documents at www.sgs.com/terms_e-document.htm. Attention is drawn to the limitation of liability, indemnification and jurisdiction issues defined therein. Any holder of this document is advised that information contained hereon reflects the Company's findings at the time of its intervention only and within the limits of Client's instructions, if any. The Company's sole responsibility is to its Client and this document does not exonerate parties to a transaction from exercising all their rights and obligations under the transaction documents. This document cannot be reproduced except in full, without prior written approval of the Company. Any unauthorized alteration, forgery or falsification of the content or appearance of this document is unlawful and offenders may be prosecuted to the fullest extent of the law.

5. RF POWER OUTPUT/ MAXIMUM POWER REDUCTION MEASUREMENT

5.1 Standard Applicable:

FCC 24.232(C) Peak Power Measurement, 22.913(a)(2)

5.2 Test Set-up:

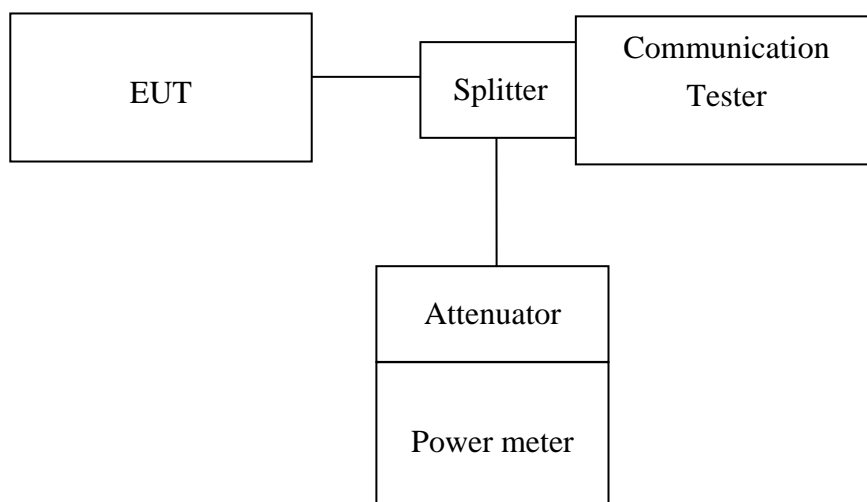

Note: Measurement setup for testing on Antenna connector

5.3 Measurement Procedure:

The transmitter output was connected to a calibrated attenuator, the other end of which was connected to a power meter. Transmitter output was read off the power meter in dBm. The power output at the transmitter antenna port was determined by adding the value of the attenuator to the power meter reading. It was used for EUT and Base station setting.

5.4 Measurement Equipment Used:

Refer to section 2.4 in this report

Unless otherwise stated the results shown in this test report refer only to the sample(s) tested and such sample(s) are retained for 90 days only.

除非另有說明，此報告結果僅對測試之樣品負責，同時此樣品僅保留90天。本報告未經本公司書面許可，不可部份複製。

This document is issued by the Company subject to its General Conditions of Service printed overleaf, available on request or accessible at www.sgs.com/terms_and_conditions.htm and for electronic format documents, subject to Terms and Conditions for Electronic Documents at www.sgs.com/terms_e-document.htm. Attention is drawn to the limitation of liability, indemnification and jurisdiction issues defined therein. Any holder of this document is advised that information contained hereon reflects the Company's findings at the time of its intervention only and within the limits of Client's instructions, if any. The Company's sole responsibility is to its Client and this document does not exonerate parties to a transaction from exercising all their rights and obligations under the transaction documents. This document cannot be reproduced except in full, without prior written approval of the Company. Any unauthorized alteration, forgery or falsification of the content or appearance of this document is unlawful and offenders may be prosecuted to the fullest extent of the law.

5.5 Measurement Result:

GPRS850	1Dn1UP		1Dn2UP	
	PK(dBm)	AV(dBm)	PK(dBm)	AV(dBm)
CH 128	32.10	32.00	32.10	32.00
CH 190	32.40	32.30	32.40	32.30
CH 251	32.70	32.60	32.70	32.60

EDGE850	1Dn1UP		1Dn2UP	
	PK(dBm)	AV(dBm)	PK(dBm)	AV(dBm)
CH 128	30.40	26.60	30.20	26.30
CH 190	30.70	27.00	30.50	26.70
CH 251	31.00	27.20	30.90	27.00

GPRS1900	1Dn1UP		1Dn2UP	
	PK(dBm)	AV(dBm)	PK(dBm)	AV(dBm)
CH 512	29.50	29.40	29.40	29.30
CH 661	29.50	29.40	29.50	29.30
CH 810	29.80	29.60	29.70	29.60

EDGE1900	1Dn1UP		1Dn2UP	
	PK(dBm)	AV(dBm)	PK(dBm)	AV(dBm)
CH 512	29.00	25.80	28.80	25.60
CH 661	29.10	25.90	28.90	25.70
CH 810	29.20	26.00	29.00	25.80

UMTS B2	WCDMA	
	PK(dBm)	AV(dBm)
CH 9262	25.34	21.64
CH 9400	26.15	22.43
CH 9538	25.31	21.61

UMTS B5	WCDMA	
	PK(dBm)	AV(dBm)
CH 4132	26.53	23.31
CH 4183	26.73	23.41
CH 4233	26.37	23.11

Unless otherwise stated the results shown in this test report refer only to the sample(s) tested and such sample(s) are retained for 90 days only.

除非另有說明，此報告結果僅對測試之樣品負責，同時此樣品僅保留90天。本報告未經本公司書面許可，不可部份複製。

This document is issued by the Company subject to its General Conditions of Service printed overleaf, available on request or accessible at www.sgs.com/terms_and_conditions.htm and for electronic format documents, subject to Terms and Conditions for Electronic Documents at www.sgs.com/terms_e-document.htm. Attention is drawn to the limitation of liability, indemnification and jurisdiction issues defined therein. Any holder of this document is advised that information contained hereon reflects the Company's findings at the time of its intervention only and within the limits of Client's instructions, if any. The Company's sole responsibility is to its Client and this document does not exonerate parties to a transaction from exercising all their rights and obligations under the transaction documents. This document cannot be reproduced except in full, without prior written approval of the Company. Any unauthorized alteration, forgery or falsification of the content or appearance of this document is unlawful and offenders may be prosecuted to the fullest extent of the law.

6. ERP/EIRP MEASUREMENT

6.1 Standard Applicable

According to FCC §2.1046

FCC 22.913(a)(2) Mobile station are limited to 7W ERP.

FCC 24.232(c) Mobile station are limited to 2W EIRP.

6.2 Test SET-UP (Block Diagram of Configuration)

(A) Radiated Emission Test Set-Up, Frequency Below 1000MHz

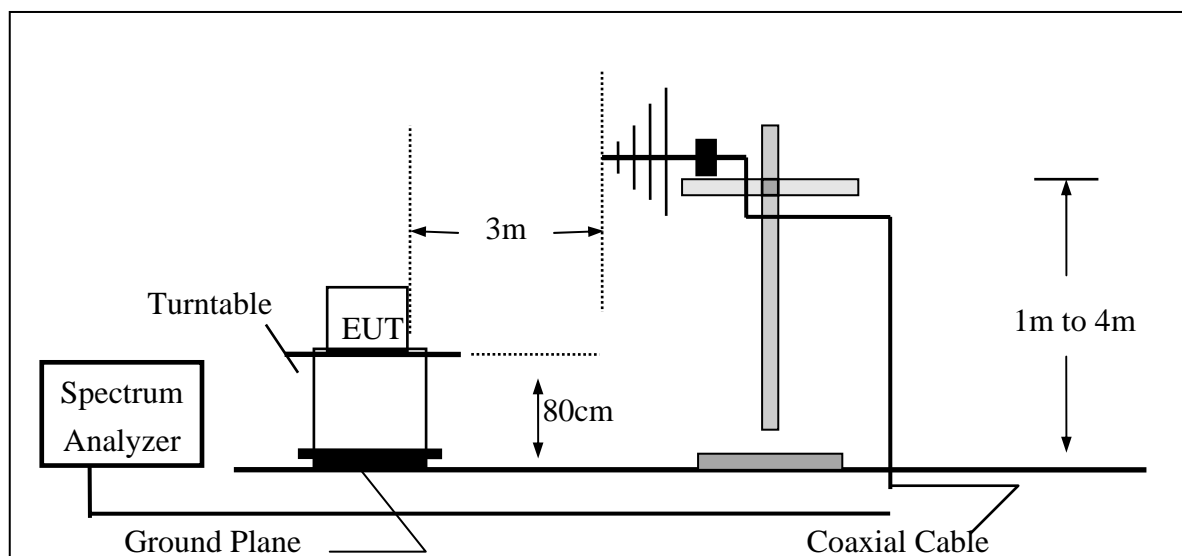

Unless otherwise stated the results shown in this test report refer only to the sample(s) tested and such sample(s) are retained for 90 days only.

除非另有說明，此報告結果僅對測試之樣品負責，同時此樣品僅保留90天。本報告未經本公司書面許可，不可部份複製。

This document is issued by the Company subject to its General Conditions of Service printed overleaf, available on request or accessible at www.sgs.com/terms_and_conditions.htm and for electronic format documents, subject to Terms and Conditions for Electronic Documents at www.sgs.com/terms_e-document.htm. Attention is drawn to the limitation of liability, indemnification and jurisdiction issues defined therein. Any holder of this document is advised that information contained hereon reflects the Company's findings at the time of its intervention only and within the limits of Client's instructions, if any. The Company's sole responsibility is to its Client and this document does not exonerate parties to a transaction from exercising all their rights and obligations under the transaction documents. This document cannot be reproduced except in full, without prior written approval of the Company. Any unauthorized alteration, forgery or falsification of the content or appearance of this document is unlawful and offenders may be prosecuted to the fullest extent of the law.

(B) Radiated Emission Test Set-UP Frequency Over 1 GHz

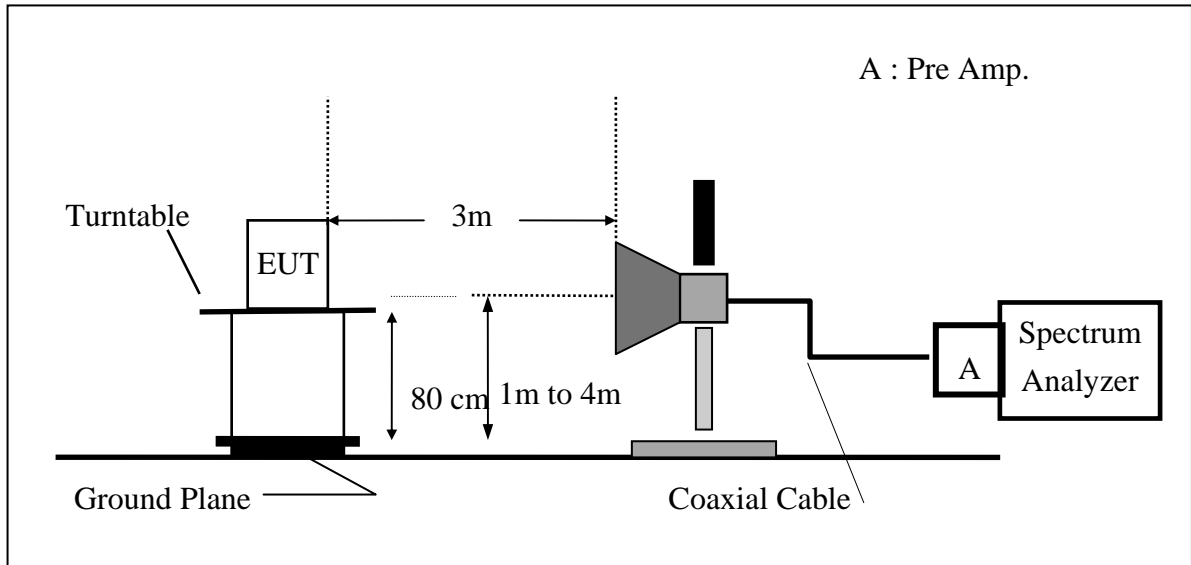

(C) Substituted Method Test Set-UP

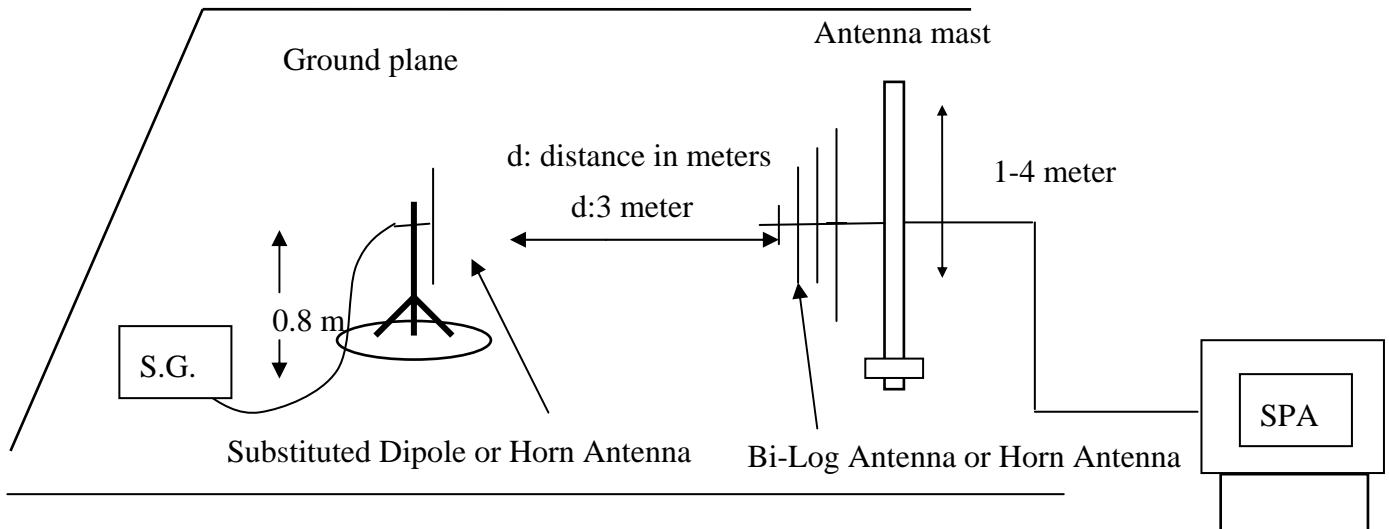

Unless otherwise stated the results shown in this test report refer only to the sample(s) tested and such sample(s) are retained for 90 days only.

除非另有說明，此報告結果僅對測試之樣品負責，同時此樣品僅保留90天。本報告未經本公司書面許可，不可部份複製。

This document is issued by the Company subject to its General Conditions of Service printed overleaf, available on request or accessible at www.sgs.com/terms_and_conditions.htm and for electronic format documents, subject to Terms and Conditions for Electronic Documents at www.sgs.com/terms_e-document.htm. Attention is drawn to the limitation of liability, indemnification and jurisdiction issues defined therein. Any holder of this document is advised that information contained hereon reflects the Company's findings at the time of its intervention only and within the limits of Client's instructions, if any. The Company's sole responsibility is to its Client and this document does not exonerate parties to a transaction from exercising all their rights and obligations under the transaction documents. This document cannot be reproduced except in full, without prior written approval of the Company. Any unauthorized alteration, forgery or falsification of the content or appearance of this document is unlawful and offenders may be prosecuted to the fullest extent of the law.

6.3 Measurement Procedure

The EUT was placed on a non-conductive turntable using a non-conductive support. The radiated emission at the fundamental frequency was measured at 3 m with a test antenna and EMI spectrum analyzer.

During the measurement, the EUT was communication with the station. The highest emission was recorded with the rotation of the turntable and the lowering of the test antenna from 4m to 1m. The reading was recorded and the field strength (E in dBuV/m) was calculated.

ERP in frequency band 824.2 –848.80.8MHz were measured using a substitution method. The EUT was replaced by dipole antenna connected, the S.G. output was recorded and ERP was calculated as follows:

EIRP in frequency band 1850.2 –1909.8MHz were measured using a substitution method. The EUT was replaced by a horn antenna connected, the S.G. output was recorded and EIRP was calculated as follows:

$$\text{ERP} = \text{S.G. output (dBm)} + \text{Antenna Gain (dBd)} - \text{Cable Loss (dB)}$$

$$\text{EIRP} = \text{S.G. output (dBm)} + \text{Antenna Gain (dBi)} - \text{Cable Loss (dB)}$$

Unless otherwise stated the results shown in this test report refer only to the sample(s) tested and such sample(s) are retained for 90 days only.

除非另有說明，此報告結果僅對測試之樣品負責，同時此樣品僅保留90天。本報告未經本公司書面許可，不可部份複製。

This document is issued by the Company subject to its General Conditions of Service printed overleaf, available on request or accessible at www.sgs.com/terms_and_conditions.htm and for electronic format documents, subject to Terms and Conditions for Electronic Documents at www.sgs.com/terms_e-document.htm. Attention is drawn to the limitation of liability, indemnification and jurisdiction issues defined therein. Any holder of this document is advised that information contained hereon reflects the Company's findings at the time of its intervention only and within the limits of Client's instructions, if any. The Company's sole responsibility is to its Client and this document does not exonerate parties to a transaction from exercising all their rights and obligations under the transaction documents. This document cannot be reproduced except in full, without prior written approval of the Company. Any unauthorized alteration, forgery or falsification of the content or appearance of this document is unlawful and offenders may be prosecuted to the fullest extent of the law.

6.4 Measurement Equipment Used:

ERP, EIRP MEASUREMENT EQUIPMENT List 966 Chamber					
EQUIPMENT TYPE	MFR	MODEL NUMBER	SERIAL NUMBER	LAST CAL.	CAL DUE.
Spectrum Analyzer	R&S	FSP 40	100034	02/12/2010	02/11/2011
Bilog Antenna	SCHWAZBECK	VULB9160	9160-3136	11/15/2009	11/14/2010
Dipole Antenna	SCHWAZBECK	VHAP	908/909	07/10/2008	07/09/2010
Dipole Antenna	SCHWAZBECK	UHAP	891/892	07/10/2008	07/09/2010
Hor.n antenna	SCHWAZBECK	BBHA 9120D	309	01/22/2010	01/21/2012
Horn antenna	SCHWAZBECK	BBHA 9120D	9120D-673	05/09/2010	05/08/2012
Signal Generator	R&S	SMR40	100210	01/22/2010	01/21/2011
Signal Generator	Agilent	E4438C	MY45093613	06/11/2009	06/10/2010
Pre-Amplifier	Agilent	8447D	1937A02834	11/30/2009	11/29/2010
Pre-Amplifier	Agilent	8449B	3008A01973	01/05/2010	01/04/2011
Attenuator	Mini-Circuit	BW-S20W5	001	07/05/2009	07/04/2010
Attenuator	Mini-Circuit	BW-S10W5	001	07/05/2009	07/04/2010
Attenuator	Mini-Circuit	BW-S6W5	001	07/05/2009	07/04/2010
Radio Communication Analyzer	R&S	CMU200	102189	05/13/2010	05/12/2012
Turn Table	HD	DT420	N/A	N.C.R	N.C.R
Antenna Tower	HD	MA240-N	240/657	N.C.R	N.C.R
Controller	HD	HD100	N/A	N.C.R	N.C.R
Low Loss Cable	HUBER+SUHNER	SUCOFLEX 104PEA-10M	10m	01/05/2010	01/04/2011
Low Loss Cable	HUBER+SUHNER	SUCOFLEX 104PEA-3M	3m	01/05/2010	01/04/2011
Filter 800-1000	Micro-Tronics	BRM13462	1	01/05/2010	01/04/2011
Filter 1800-2000	Micro-Tronics	BRM13463	1	01/05/2010	01/04/2011
3m Site	SGS	966 chamber	N/A	11/08/2009	11/09/2010

6.5 Measurement Result

Refer to following pages for detail.

Unless otherwise stated the results shown in this test report refer only to the sample(s) tested and such sample(s) are retained for 90 days only.

除非另有說明，此報告結果僅對測試之樣品負責，同時此樣品僅保留90天。本報告未經本公司書面許可，不可部份複製。

This document is issued by the Company subject to its General Conditions of Service printed overleaf, available on request or accessible at www.sgs.com/terms_and_conditions.htm and for electronic format documents, subject to Terms and Conditions for Electronic Documents at www.sgs.com/terms_e-document.htm. Attention is drawn to the limitation of liability, indemnification and jurisdiction issues defined therein. Any holder of this document is advised that information contained hereon reflects the Company's findings at the time of its intervention only and within the limits of Client's instructions, if any. The Company's sole responsibility is to its Client and this document does not exonerate parties to a transaction from exercising all their rights and obligations under the transaction documents. This document cannot be reproduced except in full, without prior written approval of the Company. Any unauthorized alteration, forgery or falsification of the content or appearance of this document is unlawful and offenders may be prosecuted to the fullest extent of the law.

SGS Taiwan Ltd.

No.134, Wu Kung Road, Wuku Industrial Zone, Taipei County, Taiwan / 台北縣五股工業區五工路 134 號

台灣檢驗科技股份有限公司

t (886-2) 2299-3279

f (886-2) 2298-0488

www.tw.sgs.com

Member of SGS Group

Measurement Result:

EUT Mode	Frequency (MHz)	CH	EUT Pol.	Antenna Pol.	SPA Reading (dBuV)	S.G. Output (dBm)	Antenna Gain (dBd)	Cable Loss (dB)	ERP (dBm)	Limit (dBm)
GPRS 850	824.20	128	H	V	125.74	39.35	-7.87	3.62	27.85	38.45
				H	127.69	41.42	-7.87	3.62	29.92	38.45
	836.60	190	H	V	124.70	38.45	-7.88	3.65	26.92	38.45
				H	125.23	39.00	-7.88	3.65	27.47	38.45
	848.80	251	H	V	123.45	37.33	-7.88	3.68	25.77	38.45
				H	124.75	38.56	-7.88	3.68	27.00	38.45

Remark :

- (1) The RBW,VBW of SPA for frequency
RBW=300 KHz, VBW=1MHz

EUT Mode	Frequency (MHz)	CH	EUT Pol.	Antenna Pol.	SPA Reading (dBuV)	S.G. Output (dBm)	Antenna Gain (dBi)	Cable Loss (dB)	EIRP (dBm)	Limit (dBm)
GPRS 1900	1850.20	512	H	V	125.10	20.71	9.90	5.56	25.05	33.00
				H	126.20	22.02	9.90	5.84	26.08	33.00
	1880.00	661	H	V	123.05	18.69	9.99	5.61	23.07	33.00
				H	124.84	20.70	9.99	5.61	25.07	33.00
	1909.80	810	H	V	124.09	19.76	10.08	5.66	24.18	33.00
				H	125.45	21.34	10.08	5.66	25.76	33.00

Remark :

- (1) The RBW,VBW of SPA for frequency
RBW=300 KHz, VBW=1MHz

Unless otherwise stated the results shown in this test report refer only to the sample(s) tested and such sample(s) are retained for 90 days only.

除非另有說明，此報告結果僅對測試之樣品負責，同時此樣品僅保留90天。本報告未經本公司書面許可，不可部份複製。

This document is issued by the Company subject to its General Conditions of Service printed overleaf, available on request or accessible at www.sgs.com/terms_and_conditions.htm and for electronic format documents, subject to Terms and Conditions for Electronic Documents at www.sgs.com/terms_e-document.htm. Attention is drawn to the limitation of liability, indemnification and jurisdiction issues defined therein. Any holder of this document is advised that information contained hereon reflects the Company's findings at the time of its intervention only and within the limits of Client's instructions, if any. The Company's sole responsibility is to its Client and this document does not exonerate parties to a transaction from exercising all their rights and obligations under the transaction documents. This document cannot be reproduced except in full, without prior written approval of the Company. Any unauthorized alteration, forgery or falsification of the content or appearance of this document is unlawful and offenders may be prosecuted to the fullest extent of the law.

SGS Taiwan Ltd. No.134, Wu Kung Road, Wuku Industrial Zone, Taipei County, Taiwan / 台北縣五股工業區五工路 134 號

台灣檢驗科技股份有限公司 t (886-2) 2299-3279

f (886-2) 2298-0488

www.tw.sgs.com

Member of SGS Group

7. FIELD STRENGTH OF SPURIOUS RADIATION MEASUREMENT

7.1 Standard Applicable

According to FCC §2.1053,

FCC §22.917(a), §24.238(a) the magnitude of each spurious and harmonic emission that can be detected when the equipment is operated under the conditions specified in the instruction manual and/ or alignment procedure, shall not be less than $43 + 10 \log$ (mean output power in watts) dBc below the mean power output outside a license's frequency block (-13dBm)

7.2 EUT Setup (Block Diagram of Configuration)

Refer to section 5.2 for details

Unless otherwise stated the results shown in this test report refer only to the sample(s) tested and such sample(s) are retained for 90 days only.

除非另有說明，此報告結果僅對測試之樣品負責，同時此樣品僅保留90天。本報告未經本公司書面許可，不可部份複製。

This document is issued by the Company subject to its General Conditions of Service printed overleaf, available on request or accessible at www.sgs.com/terms_and_conditions.htm and for electronic format documents, subject to Terms and Conditions for Electronic Documents at www.sgs.com/terms_e-document.htm. Attention is drawn to the limitation of liability, indemnification and jurisdiction issues defined therein. Any holder of this document is advised that information contained hereon reflects the Company's findings at the time of its intervention only and within the limits of Client's instructions, if any. The Company's sole responsibility is to its Client and this document does not exonerate parties to a transaction from exercising all their rights and obligations under the transaction documents. This document cannot be reproduced except in full, without prior written approval of the Company. Any unauthorized alteration, forgery or falsification of the content or appearance of this document is unlawful and offenders may be prosecuted to the fullest extent of the law.

SGS Taiwan Ltd.

No.134, Wu Kung Road, Wuku Industrial Zone, Taipei County, Taiwan / 台北縣五股工業區五工路 134 號

台灣檢驗科技股份有限公司

t (886-2) 2299-3279

f (886-2) 2298-0488

www.tw.sgs.com

Member of SGS Group

7.3 Measurement Procedure

The EUT was placed on a non-conductive; the measurement antenna was placed at a distance of 3 meters from the EUT. During the tests, the antenna height and the EUT azimuth were varied in order to identify the maximum level of emissions from the EUT. This maximization process was repeated with the EUT positioned in each of its three orthogonal orientations.

The frequency range up to tenth harmonic was investigated for each of three fundamental frequencies (low, middle and high channels). Once spurious emission was identified, the power of the emission was determined using the substitution method.

ERP in frequency band 824.2 –848.80MHz were measured using a substitution method. The EUT was replaced by dipole antenna connected, the S.G. output was recorded and ERP was calculated as follows:

EIRP in frequency band 1850.2 –1909.8MHz were measured using a substitution method. The EUT was replaced by a horn antenna connected, the S.G. output was recorded and EIRP was calculated as follows:

The spurious emissions attenuation was calculated as the difference between radiated power at the fundamental frequency and the spurious emissions frequency.

$$\text{ERP} = \text{S.G. output (dBm)} + \text{Antenna Gain(dBd)} - \text{Cable Loss (dB)}$$

$$\text{EIRP} = \text{S.G. output (dBm)} + \text{Antenna Gain(dBi)} - \text{Cable Loss (dB)}$$

7.4 Measurement Equipment Used:

Refer to section 5.4 for details

7.5 Measurement Result

Refer to attach tabular data sheets.

Unless otherwise stated the results shown in this test report refer only to the sample(s) tested and such sample(s) are retained for 90 days only.

除非另有說明，此報告結果僅對測試之樣品負責，同時此樣品僅保留90天。本報告未經本公司書面許可，不可部份複製。

This document is issued by the Company subject to its General Conditions of Service printed overleaf, available on request or accessible at www.sgs.com/terms_and_conditions.htm and for electronic format documents, subject to Terms and Conditions for Electronic Documents at www.sgs.com/terms_e-document.htm. Attention is drawn to the limitation of liability, indemnification and jurisdiction issues defined therein. Any holder of this document is advised that information contained hereon reflects the Company's findings at the time of its intervention only and within the limits of Client's instructions, if any. The Company's sole responsibility is to its Client and this document does not exonerate parties to a transaction from exercising all their rights and obligations under the transaction documents. This document cannot be reproduced except in full, without prior written approval of the Company. Any unauthorized alteration, forgery or falsification of the content or appearance of this document is unlawful and offenders may be prosecuted to the fullest extent of the law.

SGS Taiwan Ltd.

No.134, Wu Kung Road, Wuku Industrial Zone, Taipei County, Taiwan / 台北縣五股工業區五工路 134 號

台灣檢驗科技股份有限公司

t (886-2) 2299-3279

f (886-2) 2298-0488

www.tw.sgs.com

Member of SGS Group

Radiated Spurious Emission Measurement Result: GPRS 850 Mode

Operation Mode	: TX CH Low Mode	Test Date:	May, 30, 2010
Fundamental Frequency	: 824.20 MHz	Test By:	Jason
Temperature	: 25°C	Pol:	Ver
Humidity	: 65%		

Freq. (MHz)	SPA. Reading (dBuV)	Ant.Pol. H/V	S.G Out-put (dBm)	Antenna Gain (dBd/dBi)	Cable Loss (dB)	ERP/EIRP (dBm)	Limit (dBm)	Safe Margin (dBm)
36.79	47.77	V	-54.96	-4.16	0.91	-60.03	-13.00	-47.03
67.83	43.96	V	-67.73	-0.95	1.14	-69.82	-13.00	-56.82
101.78	45.72	V	-56.04	-7.76	1.37	-65.16	-13.00	-52.16
261.83	37.91	V	-61.59	-7.90	2.03	-71.52	-13.00	-58.52
327.79	38.26	V	-59.65	-7.76	2.28	-69.69	-13.00	-56.69
363.68	41.80	V	-55.25	-7.65	2.40	-65.29	-13.00	-52.29
824.00	79.72	V	-6.67	-7.87	3.62	-18.17	-13.00	-5.17
1648.40	46.48	V	-58.10	9.29	5.23	-54.04	-13.00	-41.04
2472.60	57.48	V	-43.53	10.08	6.53	-39.98	-13.00	-26.98
3296.80	---	V		12.17	7.71		-13.00	
4121.00	---	V		12.61	8.86		-13.00	
4945.20	---	V		12.65	9.74		-13.00	
5769.40	---	V		13.55	10.54		-13.00	
6593.60	---	V		12.05	11.30		-13.00	
7417.80	---	V		11.49	12.10		-13.00	
8242.00	---	V		11.48	12.71		-13.00	

Measurement uncertainty	30MHz - 80MHz: 5.04dB
	80MHz - 1000MHz: 3.76dB
	1GHz - 40GHz: 4.45dB

Remark :

- 1 The emission behaviors belong to narrowband spurious emission.
- 2 Remark"---" means that the emission level is too low to be measured
- 3 The result basic equation calculation is as follows:
- 4 $ERP/EIRP (dBm) = SG \text{ Setting}(dBm) + Antenna \text{ Gain} (dBd/dBi) - Cable \text{ loss} (dB)$

Unless otherwise stated the results shown in this test report refer only to the sample(s) tested and such sample(s) are retained for 90 days only.

除非另有說明，此報告結果僅對測試之樣品負責，同時此樣品僅保留90天。本報告未經本公司書面許可，不可部份複製。

This document is issued by the Company subject to its General Conditions of Service printed overleaf, available on request or accessible at www.sgs.com/terms_and_conditions.htm and for electronic format documents, subject to Terms and Conditions for Electronic Documents at www.sgs.com/terms_e-document.htm. Attention is drawn to the limitation of liability, indemnification and jurisdiction issues defined therein. Any holder of this document is advised that information contained hereon reflects the Company's findings at the time of its intervention only and within the limits of Client's instructions, if any. The Company's sole responsibility is to its Client and this document does not exonerate parties to a transaction from exercising all their rights and obligations under the transaction documents. This document cannot be reproduced except in full, without prior written approval of the Company. Any unauthorized alteration, forgery or falsification of the content or appearance of this document is unlawful and offenders may be prosecuted to the fullest extent of the law.

Radiated Spurious Emission Measurement Result: GPRS 850 Mode

Operation Mode	: TX CH Low Mode	Test Date:	May, 30, 2010
Fundamental Frequency	: 824.20 MHz	Test By:	Jason
Temperature	: 25°C	Pol:	Hor
Humidity	: 65%		

Freq. (MHz)	SPA. Reading (dBuV)	Ant.Pol. H/V	S.G Out-put (dBm)	Antenna Gain (dBd/dBi)	Cable Loss (dB)	ERP/EIRP (dBm)	Limit (dBm)	Safe Margin (dBm)
38.73	41.73	H	-61.46	-3.25	0.90	-65.61	-13.00	-52.61
90.14	45.17	H	-58.56	-7.75	1.27	-67.58	-13.00	-54.58
261.83	37.52	H	-61.33	-7.90	2.03	-71.26	-13.00	-58.26
363.68	38.32	H	-58.67	-7.65	2.40	-68.72	-13.00	-55.72
460.68	35.85	H	-57.95	-7.70	2.69	-68.34	-13.00	-55.34
591.63	33.89	H	-56.98	-7.78	3.02	-67.78	-13.00	-54.78
824.00	81.39	H	-4.88	-7.87	3.62	-16.38	-13.00	-3.38
1648.40	46.55	H	-57.85	9.29	5.23	-53.79	-13.00	-40.79
2472.60	59.23	H	-41.68	10.08	6.53	-38.13	-13.00	-25.13
3296.80	---	H		12.17	7.71		-13.00	
4121.00	---	H		12.61	8.86		-13.00	
4945.20	---	H		12.65	9.74		-13.00	
5769.40	---	H		13.55	10.54		-13.00	
6593.60	---	H		12.05	11.30		-13.00	
7417.80	---	H		11.49	12.10		-13.00	
8242.00	---	H		11.48	12.71		-13.00	

Measurement uncertainty	30MHz - 80MHz: 5.04dB
	80MHz - 1000MHz: 3.76dB
	1GHz - 40GHz: 4.45dB

Remark :

- 1 The emission behaviors belong to narrowband spurious emission.
- 2 Remark"---" means that the emission level is too low to be measured
- 3 The result basic equation calculation is as follows:
- 4 $ERP/EIRP (dBm) = SG \text{ Setting}(dBm) + Antenna \text{ Gain} (dBd/dBi) - Cable \text{ loss} (dB)$

Unless otherwise stated the results shown in this test report refer only to the sample(s) tested and such sample(s) are retained for 90 days only.

除非另有說明，此報告結果僅對測試之樣品負責，同時此樣品僅保留90天。本報告未經本公司書面許可，不可部份複製。

This document is issued by the Company subject to its General Conditions of Service printed overleaf, available on request or accessible at www.sgs.com/terms_and_conditions.htm and for electronic format documents, subject to Terms and Conditions for Electronic Documents at www.sgs.com/terms_e-document.htm. Attention is drawn to the limitation of liability, indemnification and jurisdiction issues defined therein. Any holder of this document is advised that information contained hereon reflects the Company's findings at the time of its intervention only and within the limits of Client's instructions, if any. The Company's sole responsibility is to its Client and this document does not exonerate parties to a transaction from exercising all their rights and obligations under the transaction documents. This document cannot be reproduced except in full, without prior written approval of the Company. Any unauthorized alteration, forgery or falsification of the content or appearance of this document is unlawful and offenders may be prosecuted to the fullest extent of the law.

Radiated Spurious Emission Measurement Result: GPRS 850 Mode

Operation Mode	: TX CH Mid Mode	Test Date:	May, 30, 2010
Fundamental Frequency	: 836.60 MHz	Test By:	Jason
Temperature	: 25°C	Pol:	Ver
Humidity	: 65%		

Freq. (MHz)	SPA. Reading (dBuV)	Ant.Pol. H/V	S.G Output (dBm)	Antenna Gain (dBd/dBi)	Cable Loss (dB)	ERP/EIRP (dBm)	Limit (dBm)	Safe Margin (dBm)
36.79	48.17	V	-54.56	-4.16	0.91	-59.63	-13.00	-46.63
90.14	47.46	V	-55.72	-7.75	1.27	-64.74	-13.00	-51.74
208.48	39.41	V	-62.05	-7.85	1.76	-71.66	-13.00	-58.66
327.79	38.85	V	-59.06	-7.76	2.28	-69.10	-13.00	-56.10
363.68	40.59	V	-56.46	-7.65	2.40	-66.50	-13.00	-53.50
512.09	35.70	V	-58.04	-7.73	2.84	-68.61	-13.00	-55.61
1673.20	45.84	V	-58.72	9.36	5.27	-54.62	-13.00	-41.62
2509.80	54.15	V	-46.63	10.09	6.58	-43.13	-13.00	-30.13
3346.40	---	V		12.28	7.79		-13.00	
4183.00	---	V		12.62	8.93		-13.00	
5019.60	---	V		12.67	9.81		-13.00	
5856.20	---	V		13.68	10.62		-13.00	
6692.80	---	V		11.95	11.39		-13.00	
7529.40	---	V		11.45	12.20		-13.00	
8366.00	---	V		11.59	12.81		-13.00	

Measurement uncertainty	30MHz - 80MHz: 5.04dB
	80MHz - 1000MHz: 3.76dB
	1GHz - 40GHz: 4.45dB

Remark :

- 1 The emission behaviors belong to narrowband spurious emission.
- 2 Remark"---" means that the emission level is too low to be measured
- 3 The result basic equation calculation is as follows:
- 4 $ERP/EIRP (dBm) = SG \text{ Setting}(dBm) + Antenna \text{ Gain} (dBd/dBi) - Cable \text{ loss} (dB)$

Unless otherwise stated the results shown in this test report refer only to the sample(s) tested and such sample(s) are retained for 90 days only.

除非另有說明，此報告結果僅對測試之樣品負責，同時此樣品僅保留90天。本報告未經本公司書面許可，不可部份複製。

This document is issued by the Company subject to its General Conditions of Service printed overleaf, available on request or accessible at www.sgs.com/terms_and_conditions.htm and for electronic format documents, subject to Terms and Conditions for Electronic Documents at www.sgs.com/terms_e-document.htm. Attention is drawn to the limitation of liability, indemnification and jurisdiction issues defined therein. Any holder of this document is advised that information contained hereon reflects the Company's findings at the time of its intervention only and within the limits of Client's instructions, if any. The Company's sole responsibility is to its Client and this document does not exonerate parties to a transaction from exercising all their rights and obligations under the transaction documents. This document cannot be reproduced except in full, without prior written approval of the Company. Any unauthorized alteration, forgery or falsification of the content or appearance of this document is unlawful and offenders may be prosecuted to the fullest extent of the law.

Radiated Spurious Emission Measurement Result: GPRS 850 Mode

Operation Mode	: TX CH Mid Mode	Test Date:	May, 30, 2010
Fundamental Frequency	: 836.60 MHz	Test By:	Jason
Temperature	: 25°C	Pol:	Hor
Humidity	: 65%		

Freq. (MHz)	SPA. Reading (dBuV)	Ant.Pol. H/V	S.G Out-put (dBm)	Antenna Gain (dBd/dBi)	Cable Loss (dB)	ERP/EIRP (dBm)	Limit (dBm)	Safe Margin (dBm)
38.73	42.74	H	-60.45	-3.25	0.90	-64.60	-13.00	-51.60
90.14	44.55	H	-59.18	-7.75	1.27	-68.20	-13.00	-55.20
153.19	36.96	H	-61.06	-7.80	1.60	-70.46	-13.00	-57.46
206.54	39.91	H	-61.42	-7.85	1.75	-71.02	-13.00	-58.02
363.68	37.74	H	-59.25	-7.65	2.40	-69.30	-13.00	-56.30
460.68	34.87	H	-58.93	-7.70	2.69	-69.32	-13.00	-56.32
1673.20	48.47	H	-55.91	9.36	5.27	-51.81	-13.00	-38.81
2509.80	58.40	H	-42.30	10.09	6.58	-38.80	-13.00	-25.80
3346.40	---	H		12.28	7.79		-13.00	
4183.00	---	H		12.62	8.93		-13.00	
5019.60	---	H		12.67	9.81		-13.00	
5856.20	---	H		13.68	10.62		-13.00	
6692.80	---	H		11.95	11.39		-13.00	
7529.40	---	H		11.45	12.20		-13.00	
8366.00	---	H		11.59	12.81		-13.00	

Measurement uncertainty	30MHz - 80MHz: 5.04dB
	80MHz - 1000MHz: 3.76dB
	1GHz - 40GHz: 4.45dB

Remark :

- 1 The emission behaviors belong to narrowband spurious emission.
- 2 Remark"---" means that the emission level is too low to be measured
- 3 The result basic equation calculation is as follows:
- 4 $ERP/EIRP (dBm) = SG \text{ Setting}(dBm) + Antenna \text{ Gain} (dBd/dBi) - Cable \text{ loss} (dB)$

Unless otherwise stated the results shown in this test report refer only to the sample(s) tested and such sample(s) are retained for 90 days only.

除非另有說明，此報告結果僅對測試之樣品負責，同時此樣品僅保留90天。本報告未經本公司書面許可，不可部份複製。

This document is issued by the Company subject to its General Conditions of Service printed overleaf, available on request or accessible at www.sgs.com/terms_and_conditions.htm and for electronic format documents, subject to Terms and Conditions for Electronic Documents at www.sgs.com/terms_e-document.htm. Attention is drawn to the limitation of liability, indemnification and jurisdiction issues defined therein. Any holder of this document is advised that information contained hereon reflects the Company's findings at the time of its intervention only and within the limits of Client's instructions, if any. The Company's sole responsibility is to its Client and this document does not exonerate parties to a transaction from exercising all their rights and obligations under the transaction documents. This document cannot be reproduced except in full, without prior written approval of the Company. Any unauthorized alteration, forgery or falsification of the content or appearance of this document is unlawful and offenders may be prosecuted to the fullest extent of the law.

Radiated Spurious Emission Measurement Result: GPRS 850 Mode

Operation Mode	: TX CH High Mode	Test Date:	May, 30, 2010
Fundamental Frequency	: 848.80 MHz	Test By:	Jason
Temperature	: 25°C	Pol:	Ver
Humidity	: 65%		

Freq. (MHz)	SPA. Reading (dBuV)	Ant.Pol. H/V	S.G Output (dBm)	Antenna Gain (dBd/dBi)	Cable Loss (dB)	ERP/EIRP (dBm)	Limit (dBm)	Safe Margin (dBm)
36.79	48.17	V	-54.56	-4.16	0.91	-59.63	-13.00	-46.63
90.14	47.09	V	-56.09	-7.75	1.27	-65.11	-13.00	-52.11
155.13	37.67	V	-60.08	-7.80	1.60	-69.49	-13.00	-56.49
255.04	38.52	V	-61.20	-7.89	2.01	-71.11	-13.00	-58.11
363.68	40.65	V	-56.40	-7.65	2.40	-66.44	-13.00	-53.44
518.88	34.85	V	-58.67	-7.74	2.86	-69.26	-13.00	-56.26
850.00	76.20	V	-9.91	-7.88	3.68	-21.47	-13.00	-8.47
1697.60	48.90	V	-55.64	9.44	5.31	-51.51	-13.00	-38.51
2546.40	48.05	V	-52.59	10.20	6.63	-49.03	-13.00	-36.03
3395.20	---	V		12.38	7.87		-13.00	
4244.00	---	V		12.63	9.00		-13.00	
5092.80	---	V		12.74	9.88		-13.00	
5941.60	---	V		13.81	10.70		-13.00	
6790.40	---	V		11.86	11.48		-13.00	
7639.20	---	V		11.40	12.27		-13.00	
8488.00	---	V		11.70	12.91		-13.00	

Measurement uncertainty	30MHz - 80MHz: 5.04dB
	80MHz - 1000MHz: 3.76dB
	1GHz - 40GHz: 4.45dB

Remark :

- 1 The emission behaviors belong to narrowband spurious emission.
- 2 Remark"---" means that the emission level is too low to be measured
- 3 The result basic equation calculation is as follows:
- 4 $ERP/EIRP (dBm) = SG \text{ Setting}(dBm) + Antenna \text{ Gain} (dBd/dBi) - Cable \text{ loss} (dB)$

Unless otherwise stated the results shown in this test report refer only to the sample(s) tested and such sample(s) are retained for 90 days only.

除非另有說明，此報告結果僅對測試之樣品負責，同時此樣品僅保留90天。本報告未經本公司書面許可，不可部份複製。

This document is issued by the Company subject to its General Conditions of Service printed overleaf, available on request or accessible at www.sgs.com/terms_and_conditions.htm and for electronic format documents, subject to Terms and Conditions for Electronic Documents at www.sgs.com/terms_e-document.htm. Attention is drawn to the limitation of liability, indemnification and jurisdiction issues defined therein. Any holder of this document is advised that information contained hereon reflects the Company's findings at the time of its intervention only and within the limits of Client's instructions, if any. The Company's sole responsibility is to its Client and this document does not exonerate parties to a transaction from exercising all their rights and obligations under the transaction documents. This document cannot be reproduced except in full, without prior written approval of the Company. Any unauthorized alteration, forgery or falsification of the content or appearance of this document is unlawful and offenders may be prosecuted to the fullest extent of the law.

SGS Taiwan Ltd. No.134, Wu Kung Road, Wuku Industrial Zone, Taipei County, Taiwan / 台北縣五股工業區五工路 134 號

Radiated Spurious Emission Measurement Result: GPRS 850 Mode

Operation Mode	: TX CH High Mode	Test Date:	May, 30, 2010
Fundamental Frequency	: 848.80 MHz	Test By:	Jason
Temperature	: 25°C	Pol:	Hor
Humidity	: 65%		

Freq. (MHz)	SPA. Reading (dBuV)	Ant.Pol. H/V	S.G Output (dBm)	Antenna Gain (dBd/dBi)	Cable Loss (dB)	ERP/EIRP (dBm)	Limit (dBm)	Safe Margin (dBm)
36.79	43.34	H	-60.46	-4.16	0.91	-65.52	-13.00	-52.52
90.14	44.64	H	-59.09	-7.75	1.27	-68.11	-13.00	-55.11
153.19	36.04	H	-61.98	-7.80	1.60	-71.38	-13.00	-58.38
206.54	38.28	H	-63.05	-7.85	1.75	-72.65	-13.00	-59.65
363.68	38.04	H	-58.95	-7.65	2.40	-69.00	-13.00	-56.00
431.58	35.31	H	-59.52	-7.69	2.60	-69.81	-13.00	-56.81
850.00	79.36	H	-6.83	-7.88	3.68	-18.39	-13.00	-5.39
1697.60	50.42	H	-53.93	9.44	5.31	-49.80	-13.00	-36.80
2546.40	55.84	H	-44.76	10.20	6.63	-41.20	-13.00	-28.20
3395.20	---	H		12.38	7.87		-13.00	
4244.00	---	H		12.63	9.00		-13.00	
5092.80	---	H		12.74	9.88		-13.00	
5941.60	---	H		13.81	10.70		-13.00	
6790.40	---	H		11.86	11.48		-13.00	
7639.20	---	H		11.40	12.27		-13.00	
8488.00	---	H		11.70	12.91		-13.00	

Measurement uncertainty	30MHz - 80MHz: 5.04dB
	80MHz - 1000MHz: 3.76dB
	1GHz - 40GHz: 4.45dB

Remark :

- 1 The emission behaviors belong to narrowband spurious emission.
- 2 Remark"---" means that the emission level is too low to be measured
- 3 The result basic equation calculation is as follows:
- 4 $ERP/EIRP (dBm) = SG \text{ Setting}(dBm) + Antenna \text{ Gain} (dBd/dBi) - Cable \text{ loss} (dB)$

Unless otherwise stated the results shown in this test report refer only to the sample(s) tested and such sample(s) are retained for 90 days only.

除非另有說明，此報告結果僅對測試之樣品負責，同時此樣品僅保留90天。本報告未經本公司書面許可，不可部份複製。

This document is issued by the Company subject to its General Conditions of Service printed overleaf, available on request or accessible at www.sgs.com/terms_and_conditions.htm and for electronic format documents, subject to Terms and Conditions for Electronic Documents at www.sgs.com/terms_e-document.htm. Attention is drawn to the limitation of liability, indemnification and jurisdiction issues defined therein. Any holder of this document is advised that information contained hereon reflects the Company's findings at the time of its intervention only and within the limits of Client's instructions, if any. The Company's sole responsibility is to its Client and this document does not exonerate parties to a transaction from exercising all their rights and obligations under the transaction documents. This document cannot be reproduced except in full, without prior written approval of the Company. Any unauthorized alteration, forgery or falsification of the content or appearance of this document is unlawful and offenders may be prosecuted to the fullest extent of the law.

Radiated Spurious Emission Measurement Result: GPRS 1900 Mode

Operation Mode	: TX CH Low Mode	Test Date:	May, 30, 2010
Fundamental Frequency	: 1850.20MHz	Test By:	Jason
Temperature	: 25°C	Pol:	Ver
Humidity	: 65%		

Freq. (MHz)	SPA. Reading (dBuV)	Ant.Pol. H/V	S.G Out-put (dBm)	Antenna Gain (dBd/dBi)	Cable Loss (dB)	ERP/EIRP (dBm)	Limit (dBm)	Safe Margin (dBm)
36.79	47.43	V	-55.30	-4.16	0.91	-60.37	-13.00	-47.37
67.83	43.89	V	-67.80	-0.95	1.14	-69.89	-13.00	-56.89
90.14	46.08	V	-57.10	-7.75	1.27	-66.12	-13.00	-53.12
203.63	40.98	V	-60.66	-7.84	1.73	-70.24	-13.00	-57.24
261.83	39.99	V	-59.51	-7.90	2.03	-69.44	-13.00	-56.44
361.74	41.32	V	-55.81	-7.64	2.40	-65.85	-13.00	-52.85
1850.00	79.38	V	-25.01	9.90	5.56	-20.67	-13.00	-7.67
3700.40	39.49	V	-58.44	12.61	8.31	-54.14	-13.00	-41.14
5550.60	---	V		13.23	10.33		-13.00	
7400.80	---	V		11.50	12.08		-13.00	
9251.00	---	V		11.92	13.50		-13.00	
11101.20	---	V		11.66	15.11		-13.00	
12951.40	---	V		13.63	16.60		-13.00	
14801.60	---	V		12.76	17.95		-13.00	
16651.80	---	V		15.92	19.14		-13.00	
18502.00	---	V		18.75	10.40		-13.00	

Measurement uncertainty	30MHz - 80MHz: 5.04dB
	80MHz - 1000MHz: 3.76dB
	1GHz - 40GHz: 4.45dB

Remark :

- 1 The emission behaviors belong to narrowband spurious emission.
- 2 Remark"---" means that the emission level is too low to be measured
- 3 The result basic equation calculation is as follows:
- 4 $ERP/EIRP (dBm) = SG \text{ Setting}(dBm) + Antenna \text{ Gain} (dBd/dBi) - Cable \text{ loss} (dB)$

Unless otherwise stated the results shown in this test report refer only to the sample(s) tested and such sample(s) are retained for 90 days only.

除非另有說明，此報告結果僅對測試之樣品負責，同時此樣品僅保留90天。本報告未經本公司書面許可，不可部份複製。

This document is issued by the Company subject to its General Conditions of Service printed overleaf, available on request or accessible at www.sgs.com/terms_and_conditions.htm and for electronic format documents, subject to Terms and Conditions for Electronic Documents at www.sgs.com/terms_e-document.htm. Attention is drawn to the limitation of liability, indemnification and jurisdiction issues defined therein. Any holder of this document is advised that information contained hereon reflects the Company's findings at the time of its intervention only and within the limits of Client's instructions, if any. The Company's sole responsibility is to its Client and this document does not exonerate parties to a transaction from exercising all their rights and obligations under the transaction documents. This document cannot be reproduced except in full, without prior written approval of the Company. Any unauthorized alteration, forgery or falsification of the content or appearance of this document is unlawful and offenders may be prosecuted to the fullest extent of the law.

Radiated Spurious Emission Measurement Result: GPRS 1900 Mode

Operation Mode	: TX CH Low Mode	Test Date:	May, 30, 2010
Fundamental Frequency	: 1850.20MHz	Test By:	Jason
Temperature	: 25°C	Pol:	Hor
Humidity	: 65%		

Freq. (MHz)	SPA. Reading (dBuV)	Ant.Pol. H/V	S.G Output (dBm)	Antenna Gain (dBd/dBi)	Cable Loss (dB)	ERP/EIRP (dBm)	Limit (dBm)	Safe Margin (dBm)
38.73	43.15	H	-60.04	-3.25	0.90	-64.19	-13.00	-51.19
90.14	44.99	H	-58.74	-7.75	1.27	-67.76	-13.00	-54.76
155.13	37.48	H	-60.69	-7.80	1.60	-70.09	-13.00	-57.09
363.68	37.67	H	-59.32	-7.65	2.40	-69.37	-13.00	-56.37
518.88	34.75	H	-58.05	-7.74	2.86	-68.64	-13.00	-55.64
623.64	33.22	H	-57.02	-7.80	3.09	-67.91	-13.00	-54.91
1850.00	78.62	H	-25.56	9.90	5.56	-21.22	-13.00	-8.22
3700.40	43.73	H	-54.31	12.61	8.31	-50.01	-13.00	-37.01
5550.60	---	H		13.23	10.33		-13.00	
7400.80	---	H		11.50	12.08		-13.00	
9251.00	---	H		11.92	13.50		-13.00	
11101.20	---	H		11.66	15.11		-13.00	
12951.40	---	H		13.63	16.60		-13.00	
14801.60	---	H		12.76	17.95		-13.00	
16651.80	---	H		15.92	19.14		-13.00	
18502.00	---	H		18.75	10.40		-13.00	

Measurement uncertainty	30MHz - 80MHz: 5.04dB
	80MHz - 1000MHz: 3.76dB
	1GHz - 40GHz: 4.45dB

Remark :

- 1 The emission behaviors belong to narrowband spurious emission.
- 2 Remark"---" means that the emission level is too low to be measured
- 3 The result basic equation calculation is as follows:
- 4 $ERP/EIRP (dBm) = SG \text{ Setting}(dBm) + Antenna \text{ Gain} (dBd/dBi) - Cable \text{ loss} (dB)$

Unless otherwise stated the results shown in this test report refer only to the sample(s) tested and such sample(s) are retained for 90 days only.

除非另有說明，此報告結果僅對測試之樣品負責，同時此樣品僅保留90天。本報告未經本公司書面許可，不可部份複製。

This document is issued by the Company subject to its General Conditions of Service printed overleaf, available on request or accessible at www.sgs.com/terms_and_conditions.htm and for electronic format documents, subject to Terms and Conditions for Electronic Documents at www.sgs.com/terms_e-document.htm. Attention is drawn to the limitation of liability, indemnification and jurisdiction issues defined therein. Any holder of this document is advised that information contained hereon reflects the Company's findings at the time of its intervention only and within the limits of Client's instructions, if any. The Company's sole responsibility is to its Client and this document does not exonerate parties to a transaction from exercising all their rights and obligations under the transaction documents. This document cannot be reproduced except in full, without prior written approval of the Company. Any unauthorized alteration, forgery or falsification of the content or appearance of this document is unlawful and offenders may be prosecuted to the fullest extent of the law.

Radiated Spurious Emission Measurement Result: GPRS 1900 Mode

Operation Mode	: TX CH Mid Mode	Test Date:	May, 30, 2010
Fundamental Frequency	: 1880MHz	Test By:	Jason
Temperature	: 25°C	Pol:	Ver
Humidity	: 65%		

Freq. (MHz)	SPA. Reading (dBuV)	Ant.Pol. H/V	S.G Output (dBm)	Antenna Gain (dBd/dBi)	Cable Loss (dB)	ERP/EIRP (dBm)	Limit (dBm)	Safe Margin (dBm)
36.79	48.56	V	-54.17	-4.16	0.91	-59.24	-13.00	-46.24
90.14	46.97	V	-56.21	-7.75	1.27	-65.23	-13.00	-52.23
130.88	38.57	V	-60.49	-7.78	1.50	-69.78	-13.00	-56.78
256.98	39.21	V	-60.45	-7.89	2.02	-70.36	-13.00	-57.36
327.79	39.24	V	-58.67	-7.76	2.28	-68.71	-13.00	-55.71
358.83	40.81	V	-56.44	-7.64	2.39	-66.47	-13.00	-53.47
3760.00	39.28	V	-58.38	12.60	8.39	-54.16	-13.00	-41.16
5640.00	---	V		13.36	10.41		-13.00	
7520.00	---	V		11.45	12.19		-13.00	
9400.00	---	V		11.93	13.61		-13.00	
11280.00	---	V		11.92	15.27		-13.00	
13160.00	---	V		13.33	16.71		-13.00	
15040.00	---	V		13.76	18.15		-13.00	
16920.00	---	V		15.27	19.32		-13.00	
18800.00	---	V		18.68	16.58		-13.00	

Measurement uncertainty	30MHz - 80MHz: 5.04dB
	80MHz - 1000MHz: 3.76dB
	1GHz - 40GHz: 4.45dB

Remark :

- 1 The emission behaviors belong to narrowband spurious emission.
- 2 Remark"---" means that the emission level is too low to be measured
- 3 The result basic equation calculation is as follows:
- 4 $ERP/EIRP (dBm) = SG \text{ Setting}(dBm) + Antenna \text{ Gain} (dBd/dBi) - Cable \text{ loss} (dB)$

Unless otherwise stated the results shown in this test report refer only to the sample(s) tested and such sample(s) are retained for 90 days only.

除非另有說明，此報告結果僅對測試之樣品負責，同時此樣品僅保留90天。本報告未經本公司書面許可，不可部份複製。

This document is issued by the Company subject to its General Conditions of Service printed overleaf, available on request or accessible at www.sgs.com/terms_and_conditions.htm and for electronic format documents, subject to Terms and Conditions for Electronic Documents at www.sgs.com/terms_e-document.htm. Attention is drawn to the limitation of liability, indemnification and jurisdiction issues defined therein. Any holder of this document is advised that information contained hereon reflects the Company's findings at the time of its intervention only and within the limits of Client's instructions, if any. The Company's sole responsibility is to its Client and this document does not exonerate parties to a transaction from exercising all their rights and obligations under the transaction documents. This document cannot be reproduced except in full, without prior written approval of the Company. Any unauthorized alteration, forgery or falsification of the content or appearance of this document is unlawful and offenders may be prosecuted to the fullest extent of the law.

Radiated Spurious Emission Measurement Result: GPRS 1900 Mode

Operation Mode	: TX CH Mid Mode	Test Date:	May, 30, 2010
Fundamental Frequency	: 1880MHz	Test By:	Jason
Temperature	: 25°C	Pol:	Hor
Humidity	: 65%		

Freq. (MHz)	SPA. Reading (dBuV)	Ant.Pol. H/V	S.G Out-put (dBm)	Antenna Gain (dBd/dBi)	Cable Loss (dB)	ERP/EIRP (dBm)	Limit (dBm)	Safe Margin (dBm)
41.64	42.64	H	-60.87	-2.31	0.93	-64.11	-13.00	-51.11
90.14	45.08	H	-58.65	-7.75	1.27	-67.67	-13.00	-54.67
327.79	38.32	H	-59.08	-7.76	2.28	-69.12	-13.00	-56.12
431.58	35.16	H	-59.67	-7.69	2.60	-69.96	-13.00	-56.96
512.09	35.78	H	-57.25	-7.73	2.84	-67.82	-13.00	-54.82
633.34	34.20	H	-55.85	-7.80	3.12	-66.77	-13.00	-53.77
3760.00	40.59	H	-57.18	12.60	8.39	-52.97	-13.00	-39.97
5640.00	---	H		13.36	10.41		-13.00	
7520.00	---	H		11.45	12.19		-13.00	
9400.00	---	H		11.93	13.61		-13.00	
11280.00	---	H		11.92	15.27		-13.00	
13160.00	---	H		13.33	16.71		-13.00	
15040.00	---	H		13.76	18.15		-13.00	
16920.00	---	H		15.27	19.32		-13.00	
18800.00	---	H		18.68	16.58		-13.00	

Measurement uncertainty	30MHz - 80MHz: 5.04dB
	80MHz - 1000MHz: 3.76dB
	1GHz - 40GHz: 4.45dB

Remark :

- 1 The emission behaviors belong to narrowband spurious emission.
- 2 Remark"---" means that the emission level is too low to be measured
- 3 The result basic equation calculation is as follows:
- 4 $ERP/EIRP (dBm) = SG \text{ Setting}(dBm) + Antenna \text{ Gain} (dBd/dBi) - Cable \text{ loss} (dB)$

Unless otherwise stated the results shown in this test report refer only to the sample(s) tested and such sample(s) are retained for 90 days only.

除非另有說明，此報告結果僅對測試之樣品負責，同時此樣品僅保留90天。本報告未經本公司書面許可，不可部份複製。

This document is issued by the Company subject to its General Conditions of Service printed overleaf, available on request or accessible at www.sgs.com/terms_and_conditions.htm and for electronic format documents, subject to Terms and Conditions for Electronic Documents at www.sgs.com/terms_e-document.htm. Attention is drawn to the limitation of liability, indemnification and jurisdiction issues defined therein. Any holder of this document is advised that information contained hereon reflects the Company's findings at the time of its intervention only and within the limits of Client's instructions, if any. The Company's sole responsibility is to its Client and this document does not exonerate parties to a transaction from exercising all their rights and obligations under the transaction documents. This document cannot be reproduced except in full, without prior written approval of the Company. Any unauthorized alteration, forgery or falsification of the content or appearance of this document is unlawful and offenders may be prosecuted to the fullest extent of the law.

Radiated Spurious Emission Measurement Result: GPRS 1900 Mode

Operation Mode	: TX CH High Mode	Test Date:	May, 30, 2010
Fundamental Frequency	: 1909.8 MHz	Test By:	Jason
Temperature	: 25°C	Pol:	Ver
Humidity	: 65%		

Freq. (MHz)	SPA. Reading (dBuV)	Ant.Pol. H/V	S.G Out-put (dBm)	Antenna Gain (dBd/dBi)	Cable Loss (dB)	ERP/EIRP (dBm)	Limit (dBm)	Safe Margin (dBm)
36.79	48.04	V	-54.69	-4.16	0.91	-59.76	-13.00	-46.76
101.78	46.32	V	-55.44	-7.76	1.37	-64.56	-13.00	-51.56
206.54	39.79	V	-61.74	-7.85	1.75	-71.34	-13.00	-58.34
264.74	40.30	V	-59.11	-7.90	2.04	-69.05	-13.00	-56.05
363.68	40.78	V	-56.27	-7.65	2.40	-66.31	-13.00	-53.31
518.88	35.30	V	-58.22	-7.74	2.86	-68.81	-13.00	-55.81
1910.00	77.65	V	-26.68	10.08	5.66	-22.26	-13.00	-9.26
3819.60	45.05	V	-52.34	12.60	8.47	-48.21	-13.00	-35.21
5729.40	---	V		13.49	10.50		-13.00	
7639.20	---	V		11.40	12.27		-13.00	
9549.00	---	V		11.95	13.74		-13.00	
11458.80	---	V		12.17	15.43		-13.00	
13368.60	---	V		12.97	16.82		-13.00	
15278.40	---	V		15.00	18.29		-13.00	
17188.20	---	V		14.47	19.52		-13.00	
19098.00	---	V		18.66	20.78		-13.00	

Measurement uncertainty	30MHz - 80MHz: 5.04dB
	80MHz -1000MHz: 3.76dB
	1GHz - 40GHz: 4.45dB

Remark :

- 1 The emission behaviors belong to narrowband spurious emission.
- 2 Remark"---" means that the emission level is too low to be measured
- 3 The result basic equation calculation is as follows:
- 4 ERP/EIRP (dBm) = SG Setting(dBm) + Antenna Gain (dBd/dBi) – Cable loss (dB)

Unless otherwise stated the results shown in this test report refer only to the sample(s) tested and such sample(s) are retained for 90 days only.

除非另有說明，此報告結果僅對測試之樣品負責，同時此樣品僅保留90天。本報告未經本公司書面許可，不可部份複製。

This document is issued by the Company subject to its General Conditions of Service printed overleaf, available on request or accessible at www.sgs.com/terms_and_conditions.htm and for electronic format documents, subject to Terms and Conditions for Electronic Documents at www.sgs.com/terms_e-document.htm. Attention is drawn to the limitation of liability, indemnification and jurisdiction issues defined therein. Any holder of this document is advised that information contained hereon reflects the Company's findings at the time of its intervention only and within the limits of Client's instructions, if any. The Company's sole responsibility is to its Client and this document does not exonerate parties to a transaction from exercising all their rights and obligations under the transaction documents. This document cannot be reproduced except in full, without prior written approval of the Company. Any unauthorized alteration, forgery or falsification of the content or appearance of this document is unlawful and offenders may be prosecuted to the fullest extent of the law.

Radiated Spurious Emission Measurement Result: GPRS 1900 Mode

Operation Mode	: TX CH High Mode	Test Date:	May, 30, 2010
Fundamental Frequency	: 1909.8 MHz	Test By:	Jason
Temperature	: 25°C	Pol:	Hor
Humidity	: 65%		

Freq. (MHz)	SPA. Reading (dBuV)	Ant.Pol. H/V	S.G Out-put (dBm)	Antenna Gain (dBd/dBi)	Cable Loss (dB)	ERP/EIRP (dBm)	Limit (dBm)	Safe Margin (dBm)
36.79	42.82	H	-60.98	-4.16	0.91	-66.04	-13.00	-53.04
90.14	44.40	H	-59.33	-7.75	1.27	-68.35	-13.00	-55.35
208.48	40.39	H	-60.85	-7.85	1.76	-70.45	-13.00	-57.45
363.68	38.08	H	-58.91	-7.65	2.40	-68.96	-13.00	-55.96
415.09	36.03	H	-59.63	-7.67	2.56	-69.86	-13.00	-56.86
460.68	34.89	H	-58.91	-7.70	2.69	-69.30	-13.00	-56.30
1910.00	79.25	H	-24.86	10.08	5.66	-20.44	-13.00	-7.44
3819.60	43.38	H	-54.13	12.60	8.47	-49.99	-13.00	-36.99
5729.40	---	H		13.49	10.50		-13.00	
7639.20	---	H		11.40	12.27		-13.00	
9549.00	---	H		11.95	13.74		-13.00	
11458.80	---	H		12.17	15.43		-13.00	
13368.60	---	H		12.97	16.82		-13.00	
15278.40	---	H		15.00	18.29		-13.00	
17188.20	---	H		14.47	19.52		-13.00	
19098.00	---	H		18.66	20.78		-13.00	

Measurement uncertainty	30MHz - 80MHz: 5.04dB
	80MHz -1000MHz: 3.76dB
	1GHz - 40GHz: 4.45dB

Remark :

- 1 The emission behaviors belong to narrowband spurious emission.
- 2 Remark"---" means that the emission level is too low to be measured
- 3 The result basic equation calculation is as follows:
- 4 $ERP/EIRP (dBm) = SG \text{ Setting}(dBm) + Antenna \text{ Gain} (dBd/dBi) - Cable \text{ loss} (dB)$

Unless otherwise stated the results shown in this test report refer only to the sample(s) tested and such sample(s) are retained for 90 days only.

除非另有說明，此報告結果僅對測試之樣品負責，同時此樣品僅保留90天。本報告未經本公司書面許可，不可部份複製。

This document is issued by the Company subject to its General Conditions of Service printed overleaf, available on request or accessible at www.sgs.com/terms_and_conditions.htm and for electronic format documents, subject to Terms and Conditions for Electronic Documents at www.sgs.com/terms_e-document.htm. Attention is drawn to the limitation of liability, indemnification and jurisdiction issues defined therein. Any holder of this document is advised that information contained hereon reflects the Company's findings at the time of its intervention only and within the limits of Client's instructions, if any. The Company's sole responsibility is to its Client and this document does not exonerate parties to a transaction from exercising all their rights and obligations under the transaction documents. This document cannot be reproduced except in full, without prior written approval of the Company. Any unauthorized alteration, forgery or falsification of the content or appearance of this document is unlawful and offenders may be prosecuted to the fullest extent of the law.



APPENDIX 1

PHOTOGRAPHS OF SETUP

Unless otherwise stated the results shown in this test report refer only to the sample(s) tested and such sample(s) are retained for 90 days only.

除非另有說明，此報告結果僅對測試之樣品負責，同時此樣品僅保留90天。本報告未經本公司書面許可，不可部份複製。

This document is issued by the Company subject to its General Conditions of Service printed overleaf, available on request or accessible at www.sgs.com/terms_and_conditions.htm and for electronic format documents, subject to Terms and Conditions for Electronic Documents at www.sgs.com/terms_e-document.htm. Attention is drawn to the limitation of liability, indemnification and jurisdiction issues defined therein. Any holder of this document is advised that information contained hereon reflects the Company's findings at the time of its intervention only and within the limits of Client's instructions, if any. The Company's sole responsibility is to its Client and this document does not exonerate parties to a transaction from exercising all their rights and obligations under the transaction documents. This document cannot be reproduced except in full, without prior written approval of the Company. Any unauthorized alteration, forgery or falsification of the content or appearance of this document is unlawful and offenders may be prosecuted to the fullest extent of the law.

SGS Taiwan Ltd.

No.134, Wu Kung Road, Wuku Industrial Zone, Taipei County, Taiwan / 台北縣五股工業區五工路 134 號

台灣檢驗科技股份有限公司

t (886-2) 2299-3279

f (886-2) 2298-0488

www.tw.sgs.com

Member of SGS Group

Radiated Emission Set up Photos

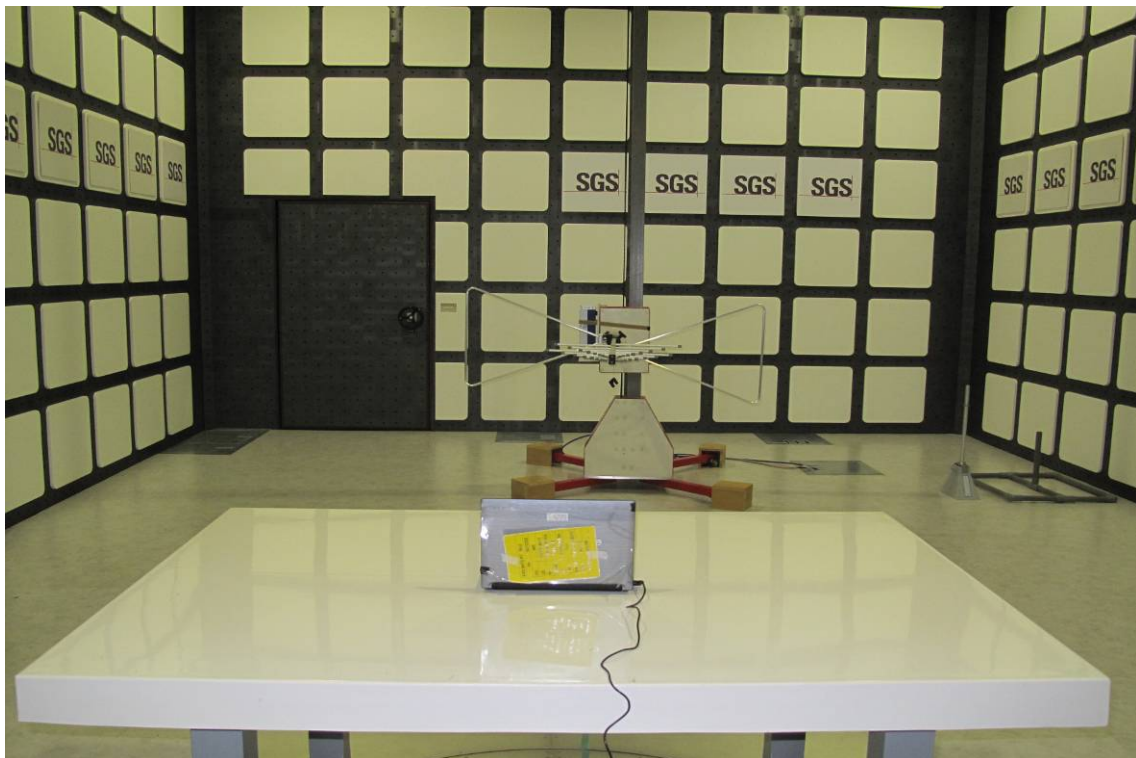

Unless otherwise stated the results shown in this test report refer only to the sample(s) tested and such sample(s) are retained for 90 days only.

除非另有說明，此報告結果僅對測試之樣品負責，同時此樣品僅保留90天。本報告未經本公司書面許可，不可部份複製。

This document is issued by the Company subject to its General Conditions of Service printed overleaf, available on request or accessible at www.sgs.com/terms_and_conditions.htm and for electronic format documents, subject to Terms and Conditions for Electronic Documents at www.sgs.com/terms_e-document.htm. Attention is drawn to the limitation of liability, indemnification and jurisdiction issues defined therein. Any holder of this document is advised that information contained hereon reflects the Company's findings at the time of its intervention only and within the limits of Client's instructions, if any. The Company's sole responsibility is to its Client and this document does not exonerate parties to a transaction from exercising all their rights and obligations under the transaction documents. This document cannot be reproduced except in full, without prior written approval of the Company. Any unauthorized alteration, forgery or falsification of the content or appearance of this document is unlawful and offenders may be prosecuted to the fullest extent of the law.

SGS Taiwan Ltd.

No.134, Wu Kung Road, Wuku Industrial Zone, Taipei County, Taiwan / 台北縣五股工業區五工路 134 號

台灣檢驗科技股份有限公司

t (886-2) 2299-3279

f (886-2) 2298-0488

www.tw.sgs.com

Member of SGS Group



APPENDIX 2

PHOTOGRAPHS OF EUT

Unless otherwise stated the results shown in this test report refer only to the sample(s) tested and such sample(s) are retained for 90 days only.

除非另有說明，此報告結果僅對測試之樣品負責，同時此樣品僅保留90天。本報告未經本公司書面許可，不可部份複製。

This document is issued by the Company subject to its General Conditions of Service printed overleaf, available on request or accessible at www.sgs.com/terms_and_conditions.htm and for electronic format documents, subject to Terms and Conditions for Electronic Documents at www.sgs.com/terms_e-document.htm. Attention is drawn to the limitation of liability, indemnification and jurisdiction issues defined therein. Any holder of this document is advised that information contained hereon reflects the Company's findings at the time of its intervention only and within the limits of Client's instructions, if any. The Company's sole responsibility is to its Client and this document does not exonerate parties to a transaction from exercising all their rights and obligations under the transaction documents. This document cannot be reproduced except in full, without prior written approval of the Company. Any unauthorized alteration, forgery or falsification of the content or appearance of this document is unlawful and offenders may be prosecuted to the fullest extent of the law.

SGS Taiwan Ltd.

No.134, Wu Kung Road, Wuku Industrial Zone, Taipei County, Taiwan / 台北縣五股工業區五工路 134 號

台灣檢驗科技股份有限公司

t (886-2) 2299-3279

f (886-2) 2298-0488

www.tw.sgs.com

Member of SGS Group

All of EUT*Front View of EUT*

Unless otherwise stated the results shown in this test report refer only to the sample(s) tested and such sample(s) are retained for 90 days only.

除非另有說明，此報告結果僅對測試之樣品負責，同時此樣品僅保留90天。本報告未經本公司書面許可，不可部份複製。

This document is issued by the Company subject to its General Conditions of Service printed overleaf, available on request or accessible at www.sgs.com/terms_and_conditions.htm and for electronic format documents, subject to Terms and Conditions for Electronic Documents at www.sgs.com/terms_e-document.htm. Attention is drawn to the limitation of liability, indemnification and jurisdiction issues defined therein. Any holder of this document is advised that information contained hereon reflects the Company's findings at the time of its intervention only and within the limits of Client's instructions, if any. The Company's sole responsibility is to its Client and this document does not exonerate parties to a transaction from exercising all their rights and obligations under the transaction documents. This document cannot be reproduced except in full, without prior written approval of the Company. Any unauthorized alteration, forgery or falsification of the content or appearance of this document is unlawful and offenders may be prosecuted to the fullest extent of the law.

SGS Taiwan Ltd.

No.134, Wu Kung Road, Wuku Industrial Zone, Taipei County, Taiwan / 台北縣五股工業區五工路 134 號

台灣檢驗科技股份有限公司

t (886-2) 2299-3279

f (886-2) 2298-0488

www.tw.sgs.com

Member of SGS Group

Back View of EUT***Side View of EUT - 1***

Unless otherwise stated the results shown in this test report refer only to the sample(s) tested and such sample(s) are retained for 90 days only.

除非另有說明，此報告結果僅對測試之樣品負責，同時此樣品僅保留90天。本報告未經本公司書面許可，不可部份複製。

This document is issued by the Company subject to its General Conditions of Service printed overleaf, available on request or accessible at www.sgs.com/terms_and_conditions.htm and for electronic format documents, subject to Terms and Conditions for Electronic Documents at www.sgs.com/terms_e-document.htm. Attention is drawn to the limitation of liability, indemnification and jurisdiction issues defined therein. Any holder of this document is advised that information contained hereon reflects the Company's findings at the time of its intervention only and within the limits of Client's instructions, if any. The Company's sole responsibility is to its Client and this document does not exonerate parties to a transaction from exercising all their rights and obligations under the transaction documents. This document cannot be reproduced except in full, without prior written approval of the Company. Any unauthorized alteration, forgery or falsification of the content or appearance of this document is unlawful and offenders may be prosecuted to the fullest extent of the law.

SGS Taiwan Ltd.

No.134, Wu Kung Road, Wuku Industrial Zone, Taipei County, Taiwan / 台北縣五股工業區五工路 134 號

台灣檢驗科技股份有限公司

t (886-2) 2299-3279

f (886-2) 2298-0488

www.tw.sgs.com

Member of SGS Group

Side View of EUT – 2*Side View of EUT – 3*

Unless otherwise stated the results shown in this test report refer only to the sample(s) tested and such sample(s) are retained for 90 days only.

除非另有說明，此報告結果僅對測試之樣品負責，同時此樣品僅保留90天。本報告未經本公司書面許可，不可部份複製。

This document is issued by the Company subject to its General Conditions of Service printed overleaf, available on request or accessible at www.sgs.com/terms_and_conditions.htm and for electronic format documents, subject to Terms and Conditions for Electronic Documents at www.sgs.com/terms_e-document.htm. Attention is drawn to the limitation of liability, indemnification and jurisdiction issues defined therein. Any holder of this document is advised that information contained hereon reflects the Company's findings at the time of its intervention only and within the limits of Client's instructions, if any. The Company's sole responsibility is to its Client and this document does not exonerate parties to a transaction from exercising all their rights and obligations under the transaction documents. This document cannot be reproduced except in full, without prior written approval of the Company. Any unauthorized alteration, forgery or falsification of the content or appearance of this document is unlawful and offenders may be prosecuted to the fullest extent of the law.

SGS Taiwan Ltd.

No.134, Wu Kung Road, Wuku Industrial Zone, Taipei County, Taiwan / 台北縣五股工業區五工路 134 號

台灣檢驗科技股份有限公司

t (886-2) 2299-3279

f (886-2) 2298-0488

www.tw.sgs.com

Member of SGS Group

Side View of EUT – 4



Side View of EUT – 5



Unless otherwise stated the results shown in this test report refer only to the sample(s) tested and such sample(s) are retained for 90 days only.

除非另有說明，此報告結果僅對測試之樣品負責，同時此樣品僅保留90天。本報告未經本公司書面許可，不可部份複製。

This document is issued by the Company subject to its General Conditions of Service printed overleaf, available on request or accessible at www.sgs.com/terms_and_conditions.htm and for electronic format documents, subject to Terms and Conditions for Electronic Documents at www.sgs.com/terms_e-document.htm. Attention is drawn to the limitation of liability, indemnification and jurisdiction issues defined therein. Any holder of this document is advised that information contained hereon reflects the Company's findings at the time of its intervention only and within the limits of Client's instructions, if any. The Company's sole responsibility is to its Client and this document does not exonerate parties to a transaction from exercising all their rights and obligations under the transaction documents. This document cannot be reproduced except in full, without prior written approval of the Company. Any unauthorized alteration, forgery or falsification of the content or appearance of this document is unlawful and offenders may be prosecuted to the fullest extent of the law.

Adaptor



Battery



Unless otherwise stated the results shown in this test report refer only to the sample(s) tested and such sample(s) are retained for 90 days only.

除非另有說明，此報告結果僅對測試之樣品負責，同時此樣品僅保留90天。本報告未經本公司書面許可，不可部份複製。

This document is issued by the Company subject to its General Conditions of Service printed overleaf, available on request or accessible at www.sgs.com/terms_and_conditions.htm and for electronic format documents, subject to Terms and Conditions for Electronic Documents at www.sgs.com/terms_e-document.htm. Attention is drawn to the limitation of liability, indemnification and jurisdiction issues defined therein. Any holder of this document is advised that information contained hereon reflects the Company's findings at the time of its intervention only and within the limits of Client's instructions, if any. The Company's sole responsibility is to its Client and this document does not exonerate parties to a transaction from exercising all their rights and obligations under the transaction documents. This document cannot be reproduced except in full, without prior written approval of the Company. Any unauthorized alteration, forgery or falsification of the content or appearance of this document is unlawful and offenders may be prosecuted to the fullest extent of the law.

SGS Taiwan Ltd. No.134, Wu Kung Road, Wuku Industrial Zone, Taipei County, Taiwan / 台北縣五股工業區五工路 134 號

Open View of EUT – 1

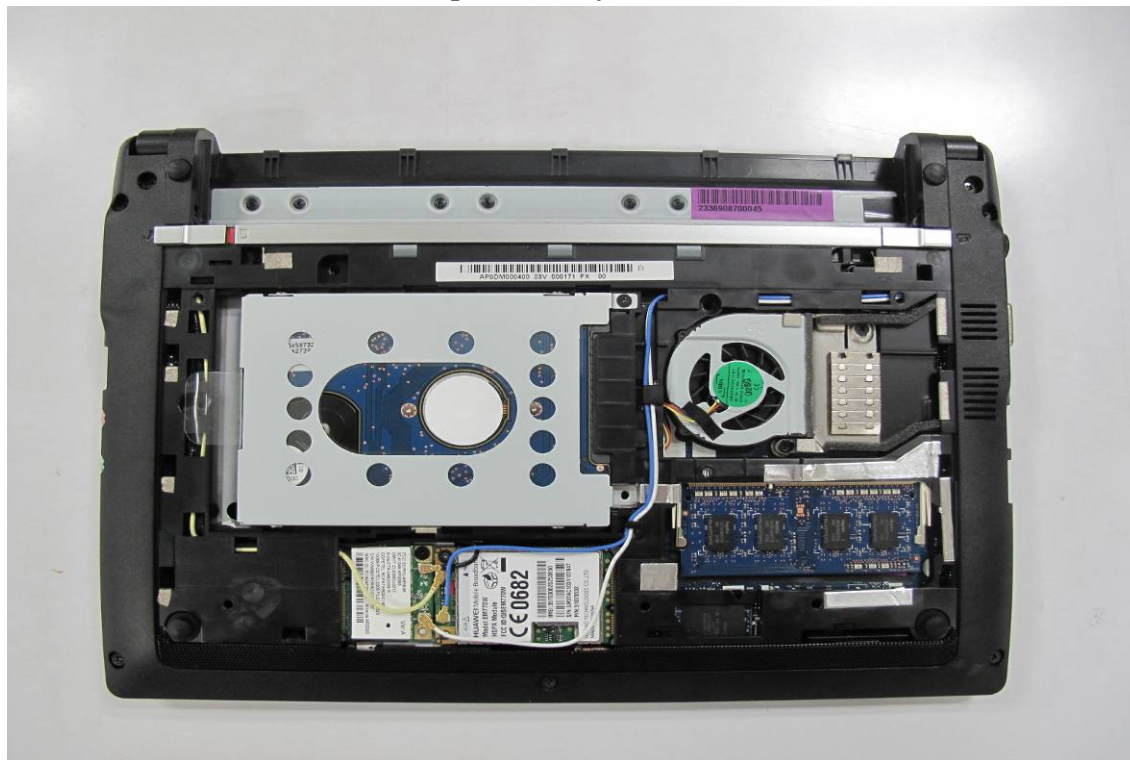

Open View of EUT – 2

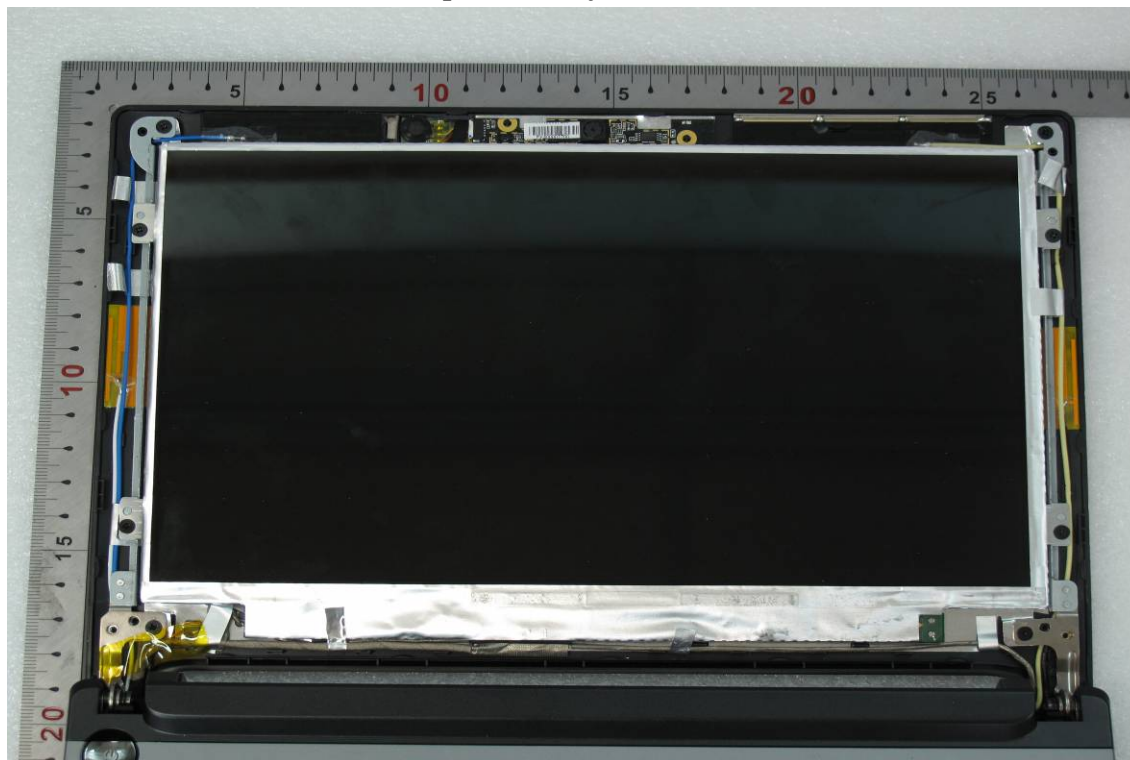

Unless otherwise stated the results shown in this test report refer only to the sample(s) tested and such sample(s) are retained for 90 days only.

除非另有說明，此報告結果僅對測試之樣品負責，同時此樣品僅保留90天。本報告未經本公司書面許可，不可部份複製。

This document is issued by the Company subject to its General Conditions of Service printed overleaf, available on request or accessible at www.sgs.com/terms_and_conditions.htm and for electronic format documents, subject to Terms and Conditions for Electronic Documents at www.sgs.com/terms_e-document.htm. Attention is drawn to the limitation of liability, indemnification and jurisdiction issues defined therein. Any holder of this document is advised that information contained hereon reflects the Company's findings at the time of its intervention only and within the limits of Client's instructions, if any. The Company's sole responsibility is to its Client and this document does not exonerate parties to a transaction from exercising all their rights and obligations under the transaction documents. This document cannot be reproduced except in full, without prior written approval of the Company. Any unauthorized alteration, forgery or falsification of the content or appearance of this document is unlawful and offenders may be prosecuted to the fullest extent of the law.

SGS Taiwan Ltd.

No.134, Wu Kung Road, Wuku Industrial Zone, Taipei County, Taiwan / 台北縣五股工業區五工路 134 號

台灣檢驗科技股份有限公司

t (886-2) 2299-3279

f (886-2) 2298-0488

www.tw.sgs.com

Member of SGS Group

Internal of EUT – 1



Internal of EUT – 2



Unless otherwise stated the results shown in this test report refer only to the sample(s) tested and such sample(s) are retained for 90 days only.

除非另有說明，此報告結果僅對測試之樣品負責，同時此樣品僅保留90天。本報告未經本公司書面許可，不可部份複製。

This document is issued by the Company subject to its General Conditions of Service printed overleaf, available on request or accessible at www.sgs.com/terms_and_conditions.htm and for electronic format documents, subject to Terms and Conditions for Electronic Documents at www.sgs.com/terms_e-document.htm. Attention is drawn to the limitation of liability, indemnification and jurisdiction issues defined therein. Any holder of this document is advised that information contained hereon reflects the Company's findings at the time of its intervention only and within the limits of Client's instructions, if any. The Company's sole responsibility is to its Client and this document does not exonerate parties to a transaction from exercising all their rights and obligations under the transaction documents. This document cannot be reproduced except in full, without prior written approval of the Company. Any unauthorized alteration, forgery or falsification of the content or appearance of this document is unlawful and offenders may be prosecuted to the fullest extent of the law.

SGS Taiwan Ltd.

No.134, Wu Kung Road, Wuku Industrial Zone, Taipei County, Taiwan / 台北縣五股工業區五工路 134 號

台灣檢驗科技股份有限公司

t (886-2) 2299-3279

f (886-2) 2298-0488

www.tw.sgs.com

Member of SGS Group

Internal of EUT – 3

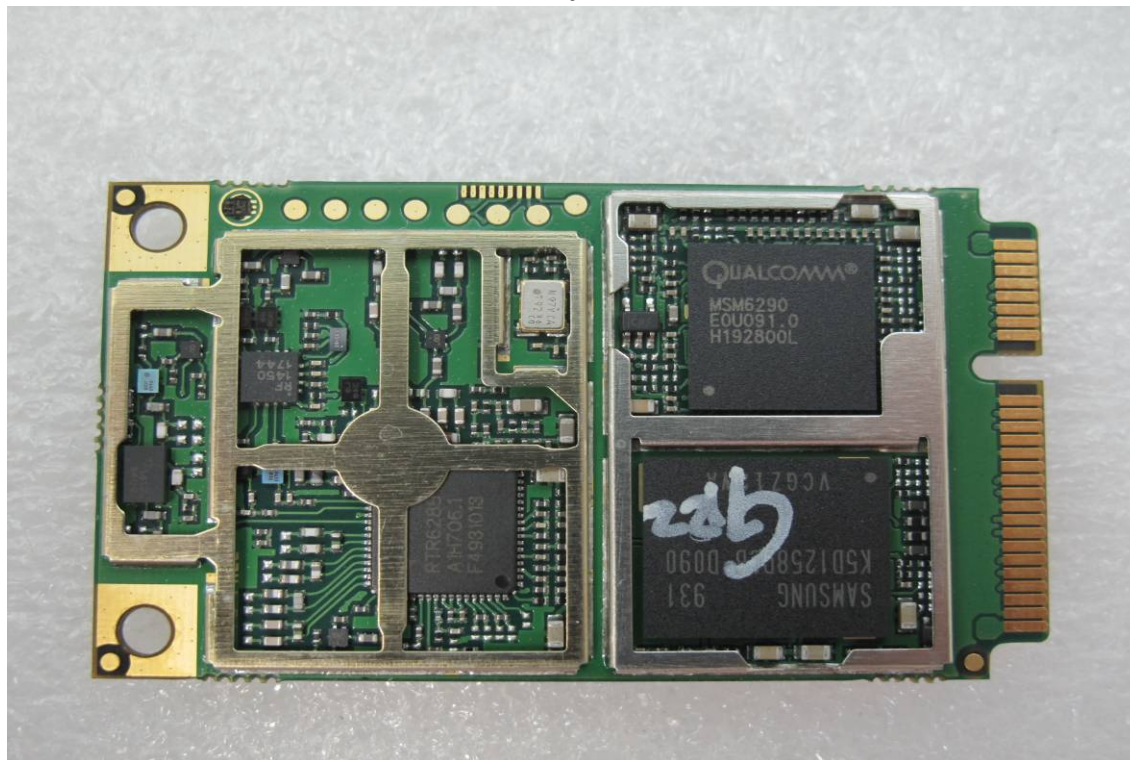

Internal of EUT – 4

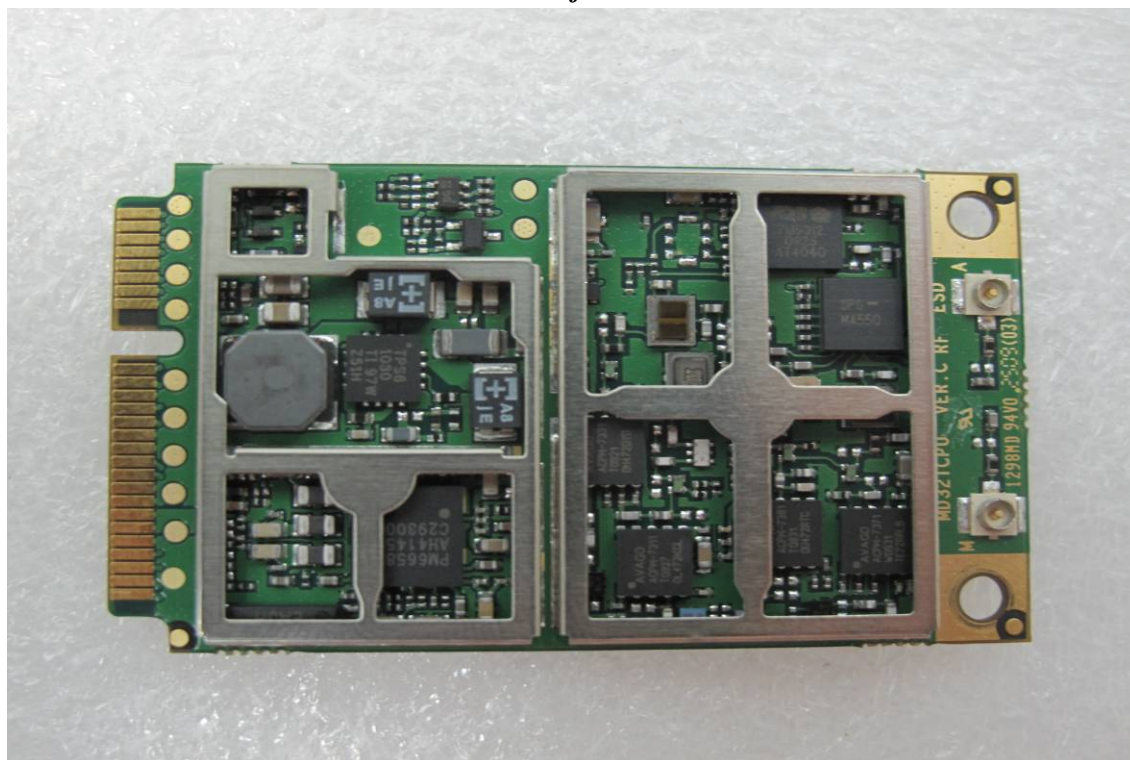

Unless otherwise stated the results shown in this test report refer only to the sample(s) tested and such sample(s) are retained for 90 days only.

除非另有說明，此報告結果僅對測試之樣品負責，同時此樣品僅保留90天。本報告未經本公司書面許可，不可部份複製。

This document is issued by the Company subject to its General Conditions of Service printed overleaf, available on request or accessible at www.sgs.com/terms_and_conditions.htm and for electronic format documents, subject to Terms and Conditions for Electronic Documents at www.sgs.com/terms_e-document.htm. Attention is drawn to the limitation of liability, indemnification and jurisdiction issues defined therein. Any holder of this document is advised that information contained hereon reflects the Company's findings at the time of its intervention only and within the limits of Client's instructions, if any. The Company's sole responsibility is to its Client and this document does not exonerate parties to a transaction from exercising all their rights and obligations under the transaction documents. This document cannot be reproduced except in full, without prior written approval of the Company. Any unauthorized alteration, forgery or falsification of the content or appearance of this document is unlawful and offenders may be prosecuted to the fullest extent of the law.

SGS Taiwan Ltd.

No.134, Wu Kung Road, Wuku Industrial Zone, Taipei County, Taiwan / 台北縣五股工業區五工路 134 號

台灣檢驗科技股份有限公司

t (886-2) 2299-3279

f (886-2) 2298-0488

www.tw.sgs.com

Member of SGS Group

Antenna- Left

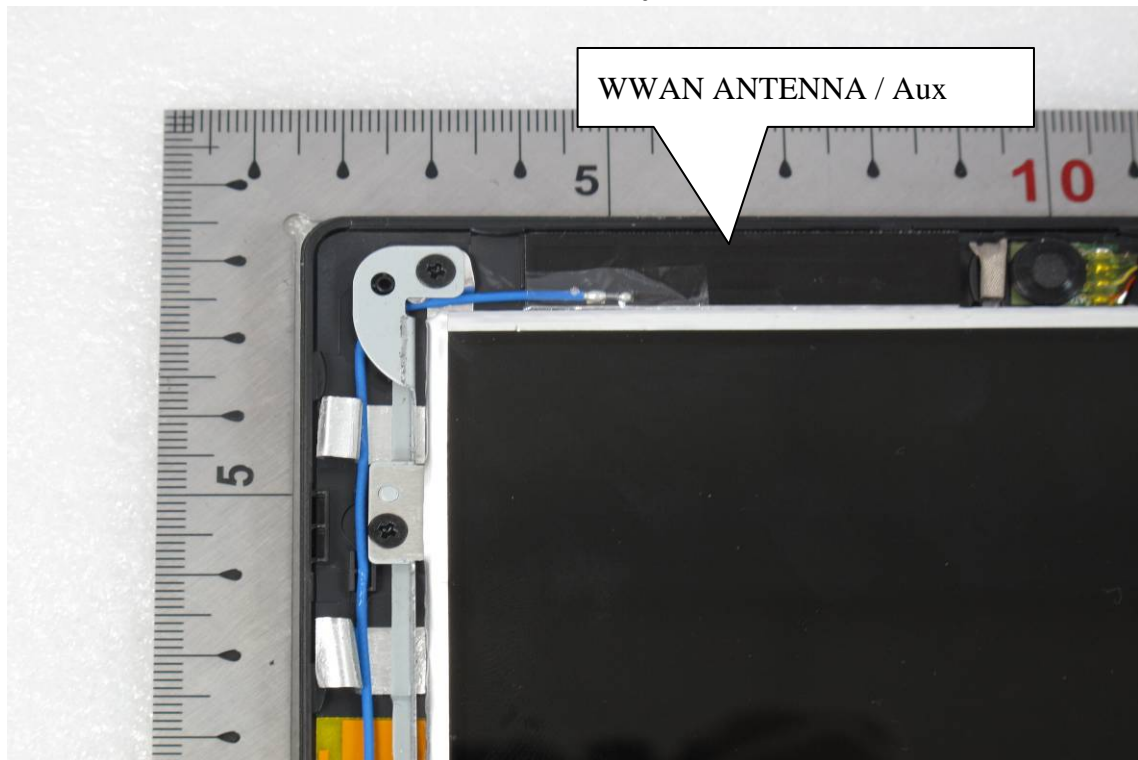

Antenna- Right



~ End of Report ~

Unless otherwise stated the results shown in this test report refer only to the sample(s) tested and such sample(s) are retained for 90 days only.

除非另有說明，此報告結果僅對測試之樣品負責，同時此樣品僅保留90天。本報告未經本公司書面許可，不可部份複製。

This document is issued by the Company subject to its General Conditions of Service printed overleaf, available on request or accessible at www.sgs.com/terms_and_conditions.htm and for electronic format documents, subject to Terms and Conditions for Electronic Documents at www.sgs.com/terms_e-document.htm. Attention is drawn to the limitation of liability, indemnification and jurisdiction issues defined therein. Any holder of this document is advised that information contained hereon reflects the Company's findings at the time of its intervention only and within the limits of Client's instructions, if any. The Company's sole responsibility is to its Client and this document does not exonerate parties to a transaction from exercising all their rights and obligations under the transaction documents. This document cannot be reproduced except in full, without prior written approval of the Company. Any unauthorized alteration, forgery or falsification of the content or appearance of this document is unlawful and offenders may be prosecuted to the fullest extent of the law.

SGS Taiwan Ltd.

No.134, Wu Kung Road, Wuku Industrial Zone, Taipei County, Taiwan / 台北縣五股工業區五工路 134 號

台灣檢驗科技股份有限公司

t (886-2) 2299-3279

f (886-2) 2298-0488

www.tw.sgs.com

Member of SGS Group