

Regulatory WWAN + WiFi, Main + Aux Antenna Information

Platform	
Platform Owner	Acer Incorporated
Brand Name	Acer Incorporated
Model Name	SJM11-MS (ZH8)
ODM	Quanta computer Inc.
Target Launch Date	
Antenna	
Brand Name	Wistron Neweb Corp.
Part Number	<input type="checkbox"/> WWAN Main Antenna: DQ6T15GBD00
	<input type="checkbox"/> WWAN Aux Antenna: DQ6T15GBD00
	<input type="checkbox"/> WiFi Main Antenna: DQ6T15GBD00
	<input type="checkbox"/> WiFi Aux Antenna: DQ6T15GBD00
Module	
With WLAN Module	
(Check Box)	

Antenna Sample / Antenna Data Requirements for worldwide regulatory approval

Section	Description of Required OEM / ODM Antenna Information	US / IC	EU	Japan	Taiwan	S.Korea
1A	Part Number for Antenna only	Required	Required	Required	Required	Required
1B	Antenna Manufacturer Name	Required	Required	Required	Required	Required
1C	Description of Antenna Type	Required	N/A	N/A	N/A	N/A
1D	Part number of Antenna Assembly / cable impedance, length & diameter.	Required	Desired	Desired	Desired	Desired
1E	Tx1, Tx2 & Tx3 antenna (Peak Gain W/ cable loss) *	Required	Required	Required	Required	Required
	1E OR 1F, 1G, 1H					
1F	Tx1, Tx2 & Tx3 antenna (Peak Gain only) *	Required	Required	Required	Required	Required
1G	VSWR of cable including connector	Required	Required	Required	Required	Required
1H	Tx1, Tx2 & Tx3 antenna (Cable loss W/ connector) *	Required	Required	Required	Required	Required
2	Dimensioned Photographs and Drawings of Tx1, Tx2, and Tx3 (or Rx3) antennas	Required	Required	Required	Required	Required
3	Radiation patterns of antennas loaded in the host platform.	Required	Desired	Required	N/A	Required
4	Platform model name / number - correlated to antenna manufacturer and antenna part number	Required	Required	Desired	Required	Desired
5	Photograph(s) or Drawings showing location of antennas in platform. (S. Korea requires photographs of antennas for approval submission). Taiwan requires pictures of each antenna type shown in the system.	Required	Required	Desired	Required (Photos)	Required (Photos)
6	Mech. drawings / photos with dimensions of antenna locations and distance from end-user (For evaluation of SAR testing requirement).	Required	N/A	N/A	N/A	N/A
7	Photograph(s) or Drawings showing the location of all antennas (WLAN, other) and distance between those transmitting antennas. Information will be used to evaluate whether co-location testing is required.	Required	N/A	N/A	N/A	N/A
8	Local representative contact information for LMA/ PARS process.	Required	N/A	N/A	N/A	N/A

NOTE:

(*) if 3rd antenna is Rx only (e.g. receive only for 4965AGN) then peak gain and cable loss not required

Antenna Information

Section 1. Antenna Assembly Specifications

Antenna Assembly Summary:

WWAN

1A Antenna Part Number	1B Manufacture	1C Antenna Type	1D Cable Assembly Part Number and Information	1E Peak Gain W/ Cable loss (dBi)	1F Peak Gain w/o Cable Loss (dBi)	1G VSWR	1H Cable Loss (dBi)
WWAN Main Antenna P/N: DQ6T15GDP00	Wistron NeWeb Corporation	PIFA	60.EJT04.038 50 ohm Coaxial. length: 665 mm diameter: 1.13 mm Connector: IPEX	824-894MHz	824-894MHz	824-894MHz	824-894MHz
				-1.17 dBi (peak)	-2.26 dBi (peak)	3.0 max	-1.09 dBi (peak)
				869-894MHz	869-894MHz	869-894MHz	869-894MHz
				-1.17 dBi (peak)	-2.26 dBi (peak)	3.0 max	-1.09 dBi (peak)
				900-925MHz	900-925MHz	900-925MHz	900-925MHz
				-0.28 dBi (peak)	-1.37 dBi (peak)	3.0 max	-1.09 dBi (peak)
				940-960MHz	940-960MHz	940-960MHz	940-960MHz
				-0.87 dBi (peak)	-1.96 dBi (peak)	3.0 max	-1.09 dBi (peak)
				1710-1805MHz	1710-1805MHz	1710-1805MHz	1710-1805MHz
				2.08 dBi (peak)	0.58 dBi (peak)	4.0 max	-1.50 dBi (peak)
1840-1910MHz	1840-1910MHz	1840-1910MHz	1840-1910MHz				
2.98 dBi (peak)	1.48 dBi (peak)	4.0 max	-1.50 dBi (peak)				
1920-1950MHz	1920-1950MHz	1920-1950MHz	1920-1950MHz				
2.90 dBi (peak)	1.40 dBi (peak)	3.0 max	-1.50 dBi (peak)				
1960-1990MHz	1960-1990MHz	1960-1990MHz	1960-1990MHz				
2.40 dBi (peak)	0.90 dBi (peak)	3.0 max	-1.50 dBi (peak)				
2110-2170MHz	2110-2170MHz	2110-2170MHz	2110-2170MHz				
0.22 dBi (peak)	-1.28 dBi (peak)	3.0 max	-1.50 dBi (peak)				

1A Antenna Part Number	1B Manufacture	1C Antenna Type	1D Cable Assembly Part Number and	1E Peak Gain W/ Cable loss (dBi)	1F Peak Gain w/o Cable Loss (dBi)	1G VSWR	1H Cable Loss (dBi)
WWAN Aux Antenna P/N: DQ6T15GDP00	Wistron Neweb Corporation	PIFA	60.EJT04.038 50 ohm Coaxial. length: 872 mm diameter: 1.13 mm Connector: IPEX	869-894MHz	869-894MHz	869-894MHz	869-894MHz
				-3.74 dBi (peak)	-5.17 dBi (peak)	3.0 max	-1.43 dBi (peak)
				1930-2170MHz	1930-2170MHz	1930-2170MHz	1930-2170MHz
				1.28 dBi (peak)	-0.68 dBi (peak)	3.0 max	-1.96 dBi (peak)

WLAN

1A Antenna Part Number	1B Manufacture	1C Antenna Type	1D Cable Assembly Part Number and Information	1E Peak Gain W/ Cable loss (dBi)	1F Peak Gain w/o Cable Loss (dBi)	1G VSWR	1H Cable Loss (dBi)
WLAN Main Antenna P/N: DQ6T15GDP00	Wistron NeWeb Corporation	PIFA	60.EJT04.038 50 ohm Coaxial. length: 531 mm diameter: 1.13 mm Connector: IPEX	2400-2500MHz	2400-2500MHz	2400-2500MHz	2400-2500MHz
				1.66 dBi (peak)	3.55 dBi (peak)	2.0 max	1.89 dBi (peak)
				5150-5350MHz	5150-5350MHz	5150-5350MHz	5150-5350MHz
				-1.62 dBi (peak)	1.20 dBi (peak)	2.0 max	2.82 dBi (peak)
5470-5850MHz	5470-5850MHz	5470-5850MHz	5470-5850MHz				
0.58 dBi (peak)	0.06 dBi (peak)	2.0 max	2.88 dBi (peak)				
WLAN Aux Antenna P/N: DQ6T15GDP00	Wistron NeWeb Corporation	PIFA	60.EJT04.038 50 ohm Coaxial. length: 801 mm diameter: 1.13 mm Connector: IPEX	2400-2500MHz	2400-2500MHz	2400-2500MHz	2400-2500MHz
				0.94 dBi (peak)	3.69 dBi (peak)	2.0 max	2.75 dBi (peak)
				5150-5350MHz	5150-5350MHz	5150-5350MHz	5150-5350MHz
				0.09 dBi (peak)	4.22 dBi (peak)	2.0 max	4.13 dBi (peak)
5470-5850MHz	5470-5850MHz	5470-5850MHz	5470-5850MHz				
0.86 dBi (peak)	5.08 dBi (peak)	2.0 max	4.22 dBi (peak)				

Antenna Peak Gain Table:

Frequency (MHz)	WWAN Main Antenna	
	Horizontal (dBi)	Vertical (dBi)
824	-3.31	-5.44
836	-3.25	-5.49
849	-2.98	-4.60
869	-3.21	-4.79
880	-2.08	-3.76
894	-1.17	-3.05
900	-0.90	-2.96
915	-0.28	-3.00
925	-0.51	-3.35
940	-0.87	-3.78
960	-1.50	-4.99
1710	2.08	-2.53
1750	1.48	-1.90
1785	0.93	-1.43
1805	0.43	-2.03
1840	1.54	-1.46
1850	1.69	-1.02
1880	2.10	-1.02
1910	2.98	-1.05
1920	2.90	-1.23
1930	2.36	-1.73
1950	2.32	-1.39
1960	2.40	-1.47
1980	2.14	-1.84
1990	2.02	0.00
2110	0.21	-2.38
2140	0.22	-1.94
2170	-0.45	-2.52

Frequency (MHz)	WWAN Aux Antenna	
	Horizontal (dBi)	Vertical (dBi)
869	-3.74	-4.36
880	-3.89	-3.96
894	-4.56	-4.81
1930	-5.50	0.23
1950	-3.36	1.28
1960	-1.90	1.24
1980	-2.14	1.13
1990	-1.28	-0.39
2110	-2.34	-0.38
2140	-2.44	-0.59
2170	-2.45	-0.47

Frequency (MHz)	WLAN Main Antenna		WLAN Aux Antenna	
	Horizontal (dBi)	Vertical (dBi)	Horizontal (dBi)	Vertical (dBi)
2400	1.43	-5.96	0.91	-1.91
2450	1.66	-6.07	0.74	-1.64
2500	0.39	-4.62	0.94	-2.76
5150	-1.80	-4.09	-0.78	-3.89
5250	-1.62	-2.64	0.09	-4.19
5350	-1.75	-2.07	-0.48	-1.94
5470	-1.29	-2.27	0.86	-2.72
5600	-0.57	-1.78	0.27	-3.26
5725	-0.77	-3.09	0.20	-2.47
5785	0.58	-3.17	-0.78	-2.49
5850	-0.56	-4.12	0.84	-3.21

- Antenna Peak Gain required being test in system basis.
- 1E frame contend absolutely peak antenna gain include H/ V/ H+V.
-

Section 2. Dimensioned Photos or Drawings of Antennas

Include a dimensioned photo and dimensioned drawing of antenna here.

WWAN + WiFi , Main + Aux Antenna Dimensioned Drawing

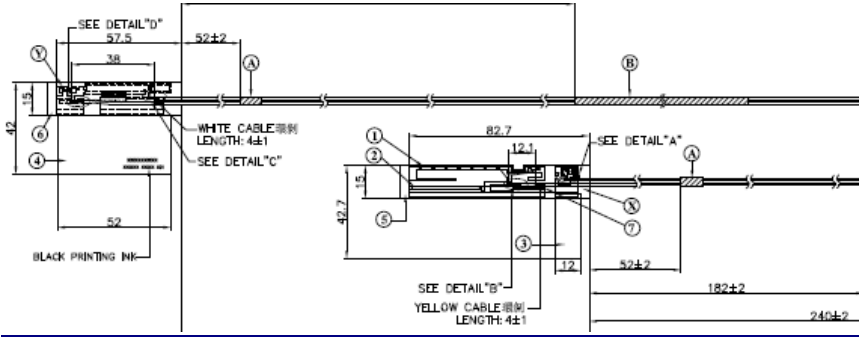

WWAN Main Antenna Photo:

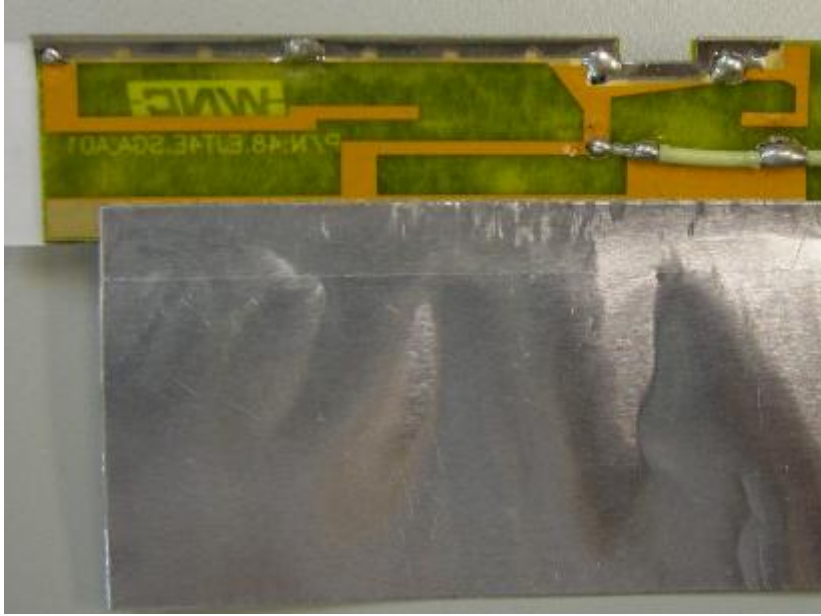

WiFi Main Antenna Photo:



WWAN Aux Antenna Photo:

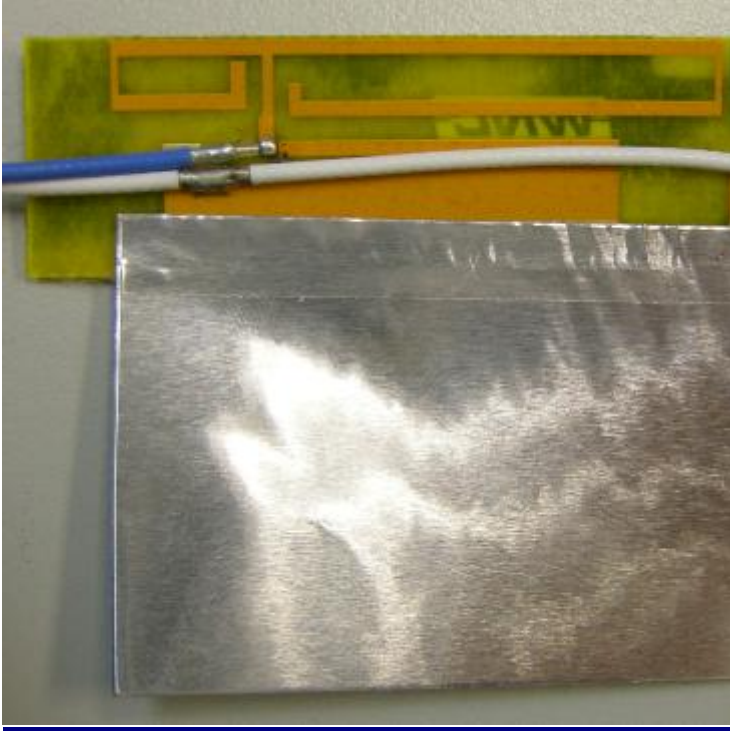

WiFi Aux Antenna Photo:



Section 3. Radiation characteristics of antennae Loaded in Host Platform

WWAN MAIN

WWAN Main antenna: 824 MHz

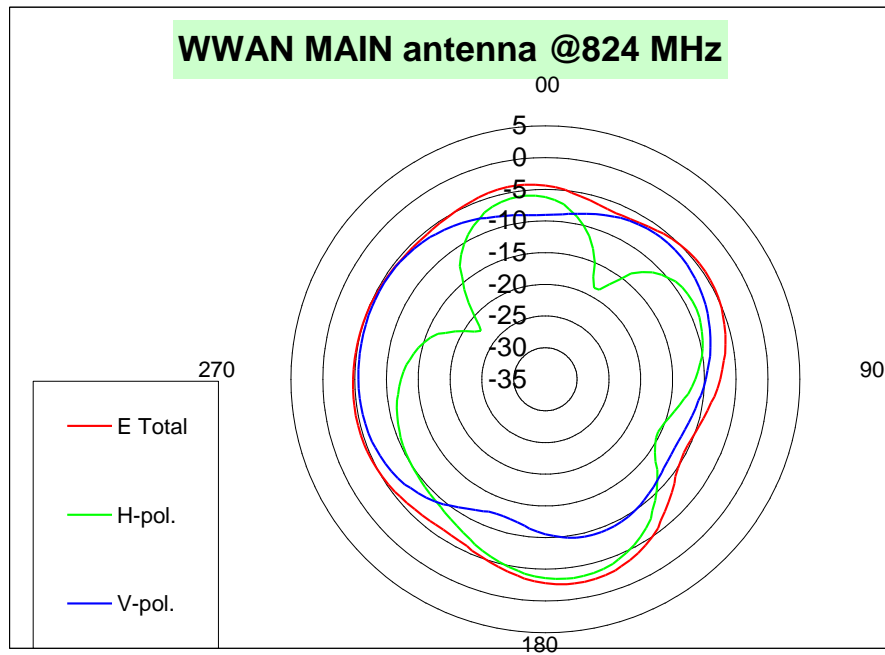

	H-pol	V pol
Peak Gain	-3.31	-5.44

WWAN Main antenna: 836 MHz

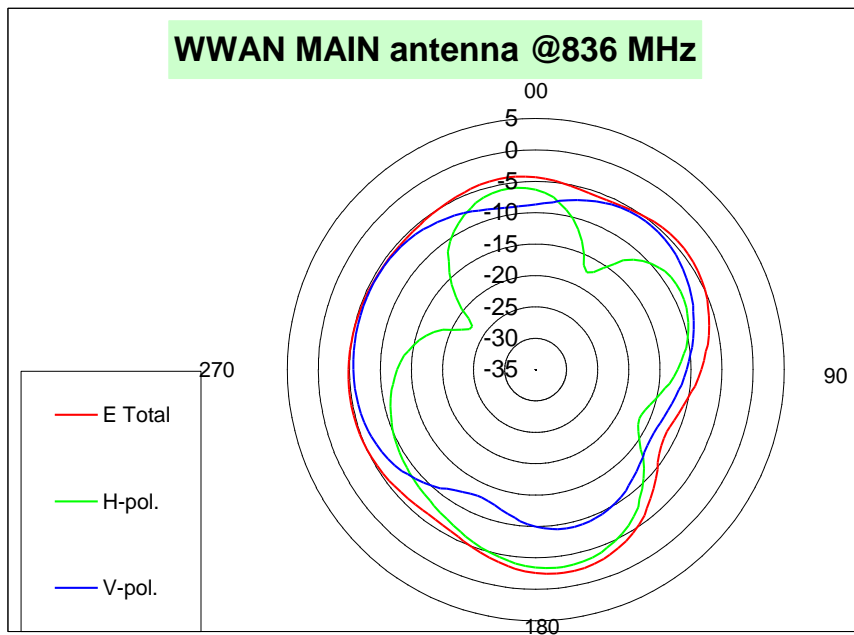

	H-pol	V pol
Peak Gain	-3.25	-5.49

WWAN Main antenna: 849 MHz

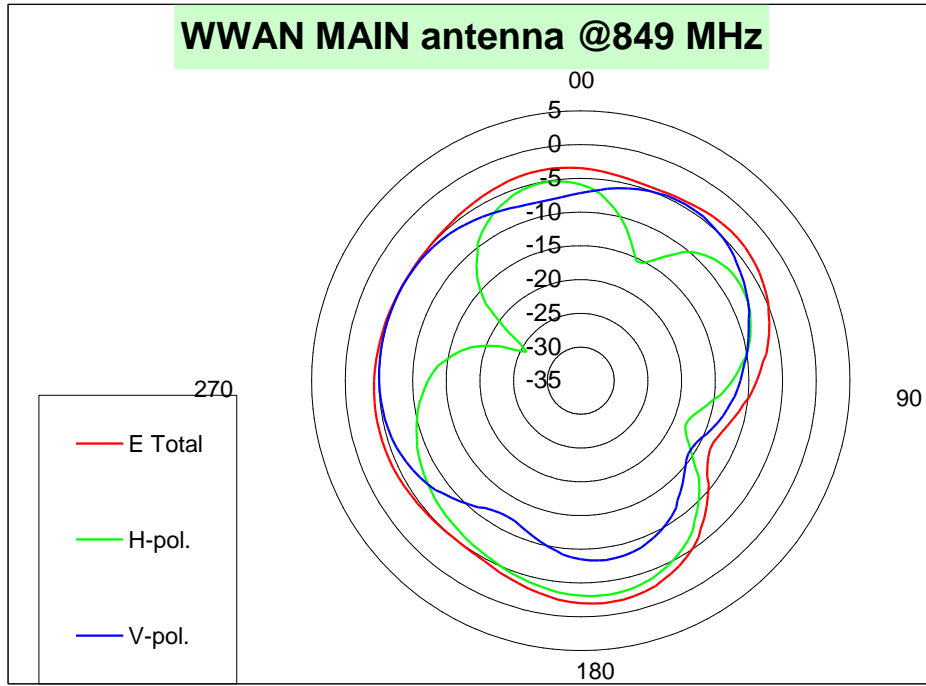

	H-pol	V pol
Peak Gain	-2.98	-4.60

WWAN Main antenna: 869 MHz

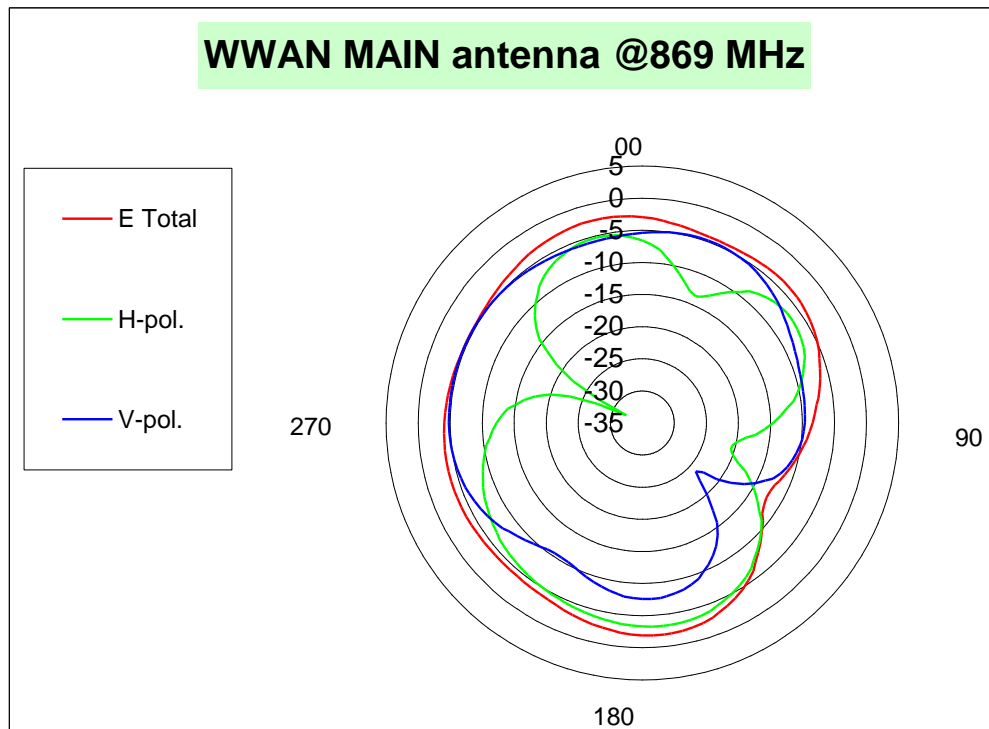

	H-pol	V pol
Peak Gain	-3.21	-4.79

WWAN Main antenna: 880 MHz

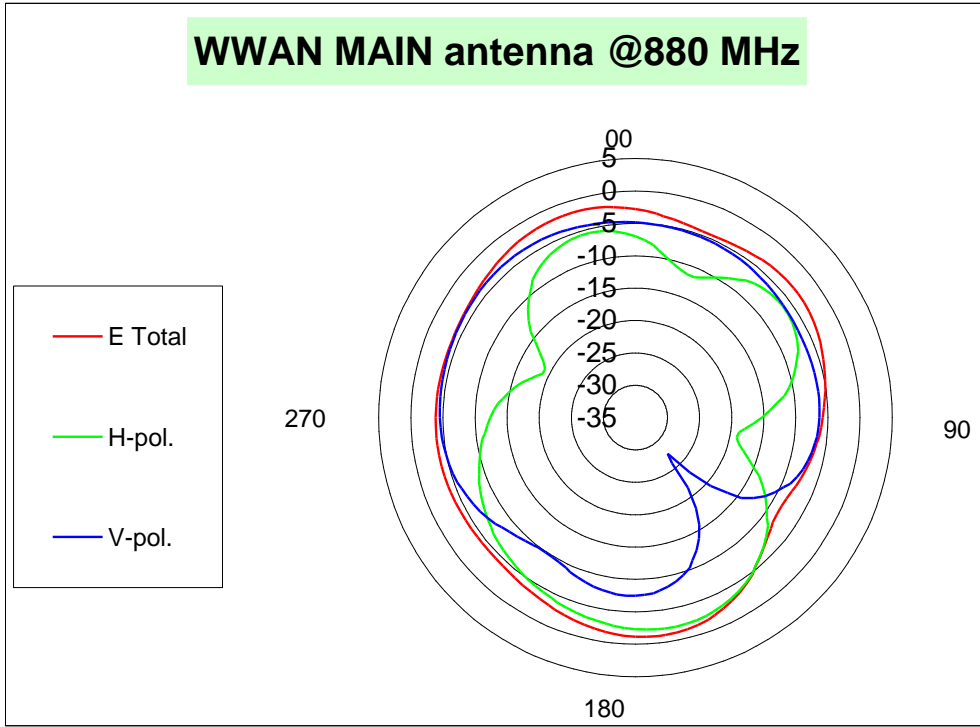

	H-pol	V pol
Peak Gain	-2.08	-3.76

WWAN Main antenna: 894 MHz

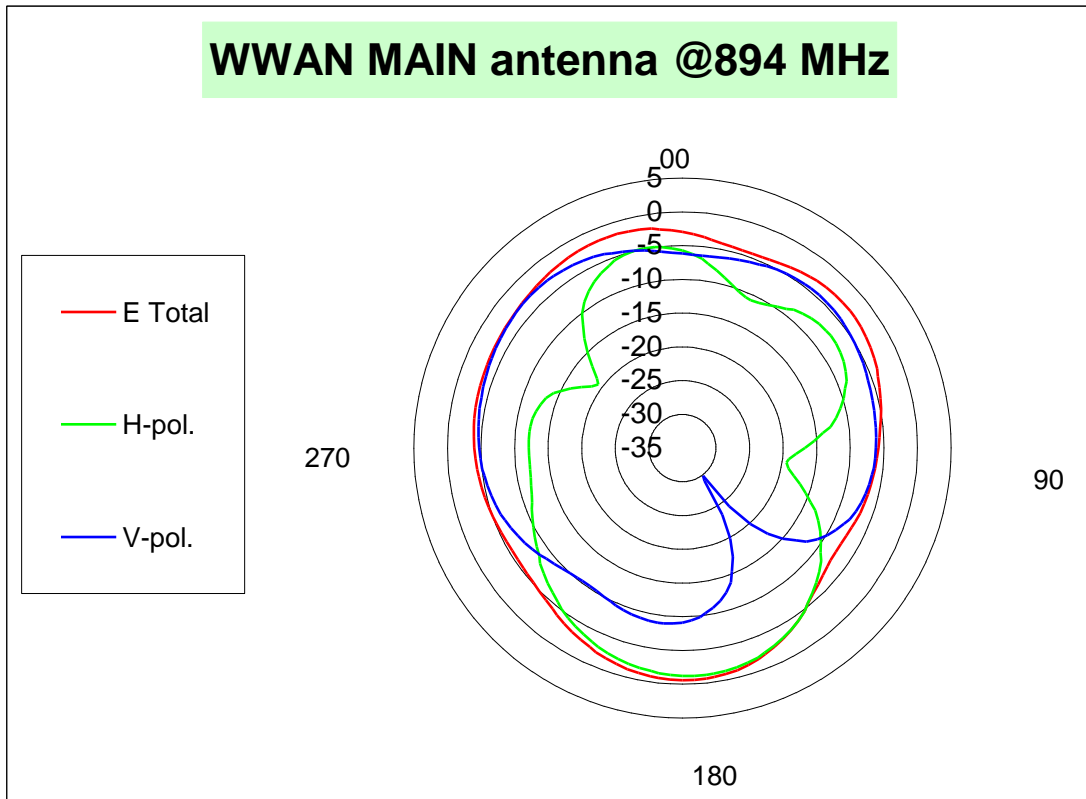

	H-pol	V pol
Peak Gain	-1.17	-3.05

WWAN Main antenna: 900 MHz

WWAN MAIN antenna @900 MHz

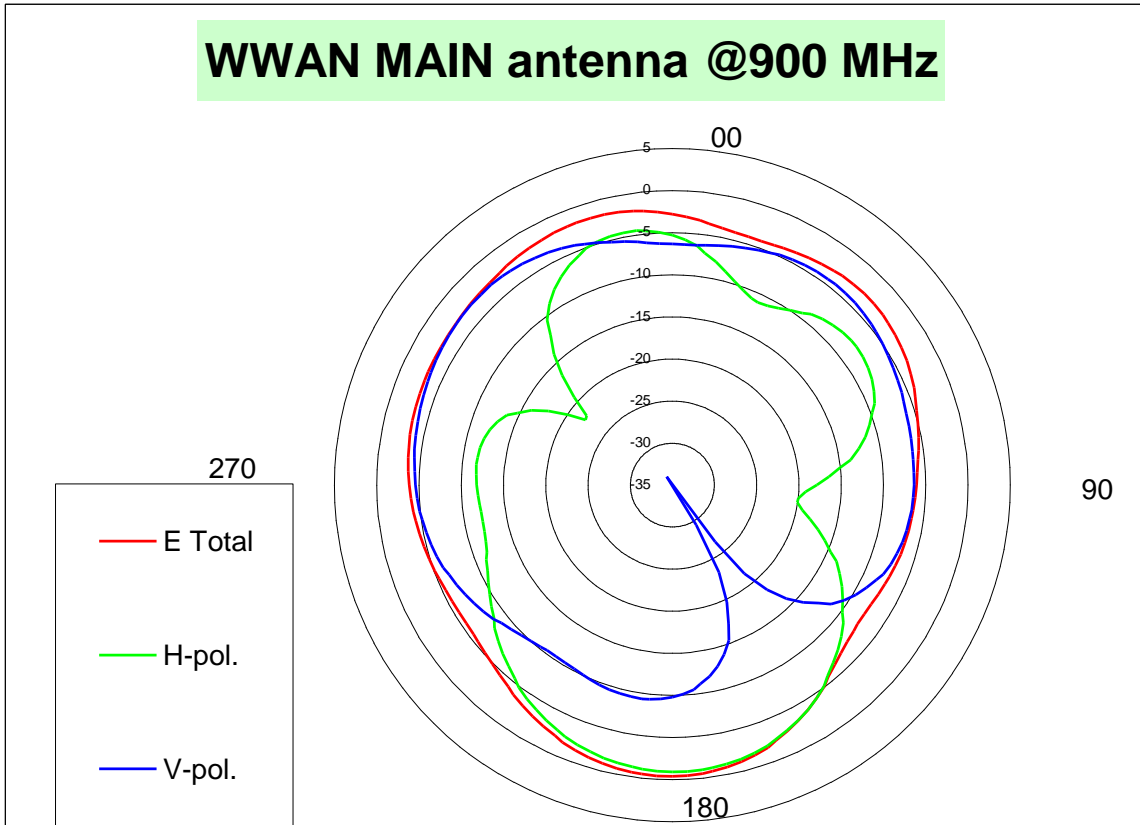

	H-pol	V pol
Peak Gain	-0.90	-2.96

WWAN Main antenna: 915 MHz

WWAN MAIN antenna @915 MHz

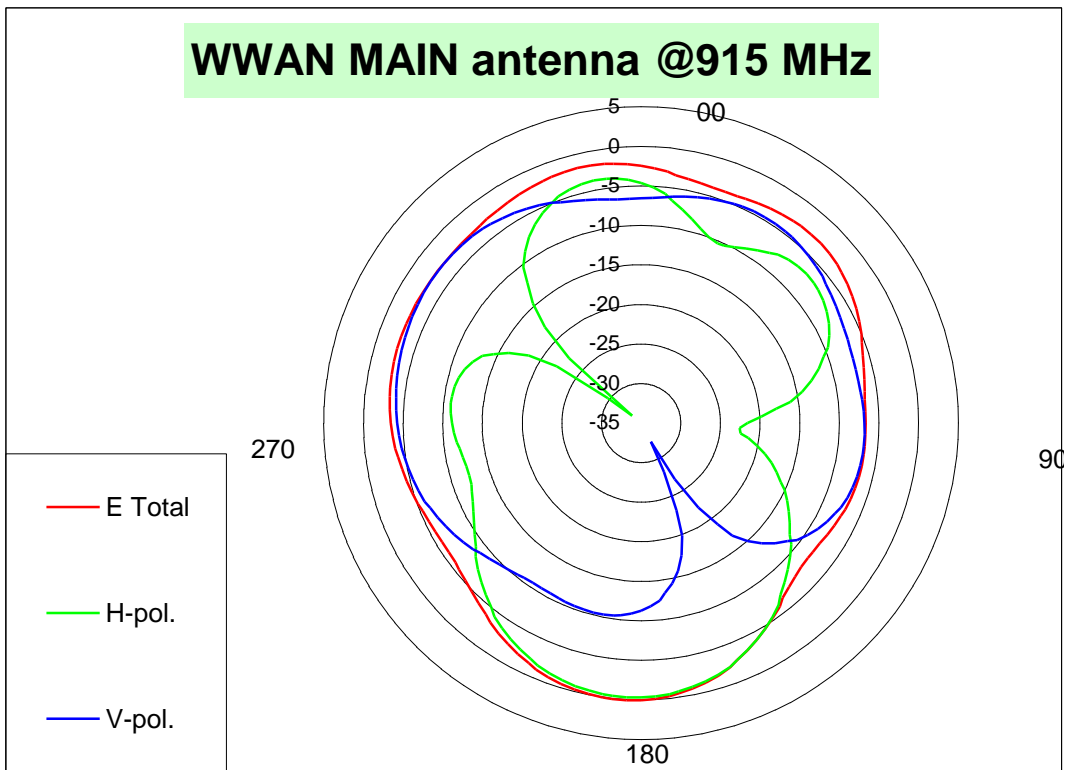

	H-pol	V pol
Peak Gain	-0.28	-3.00

WWAN Main antenna: 925 MHz

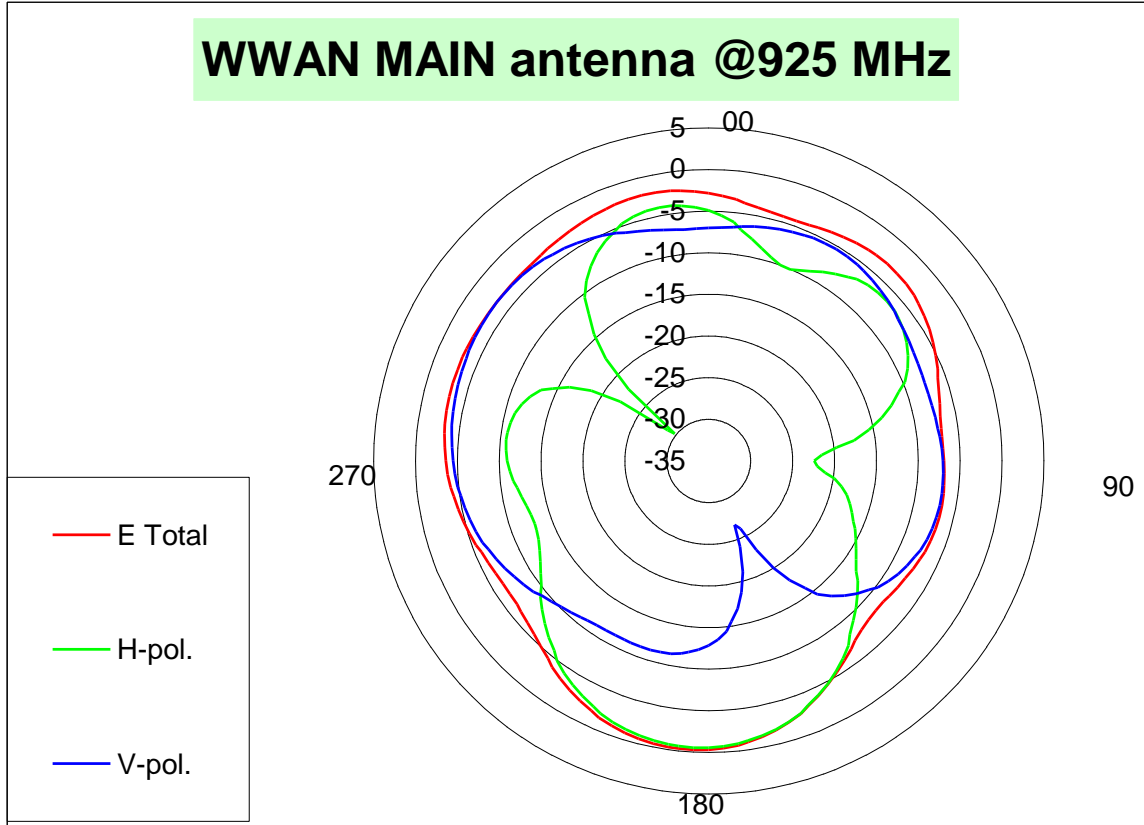

	H-pol	V pol
Peak Gain	-0.51	-3.35

WWAN Main antenna: 940 MHz

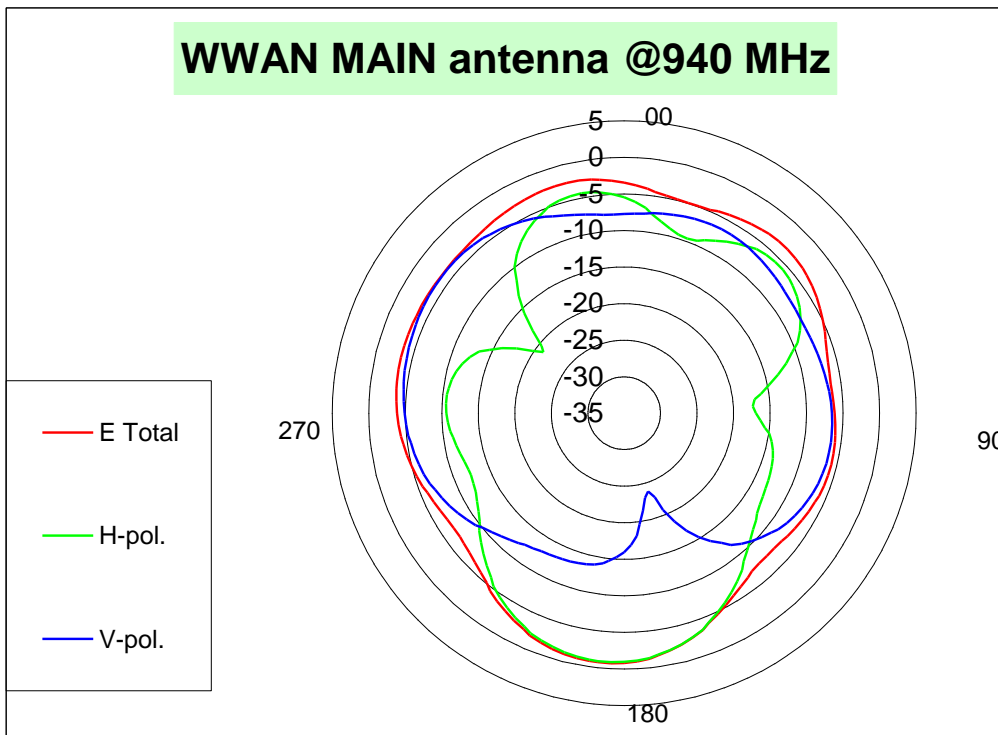

	H-pol	V pol
Peak Gain	-0.87	-3.78

WWAN Main antenna: 960 MHz

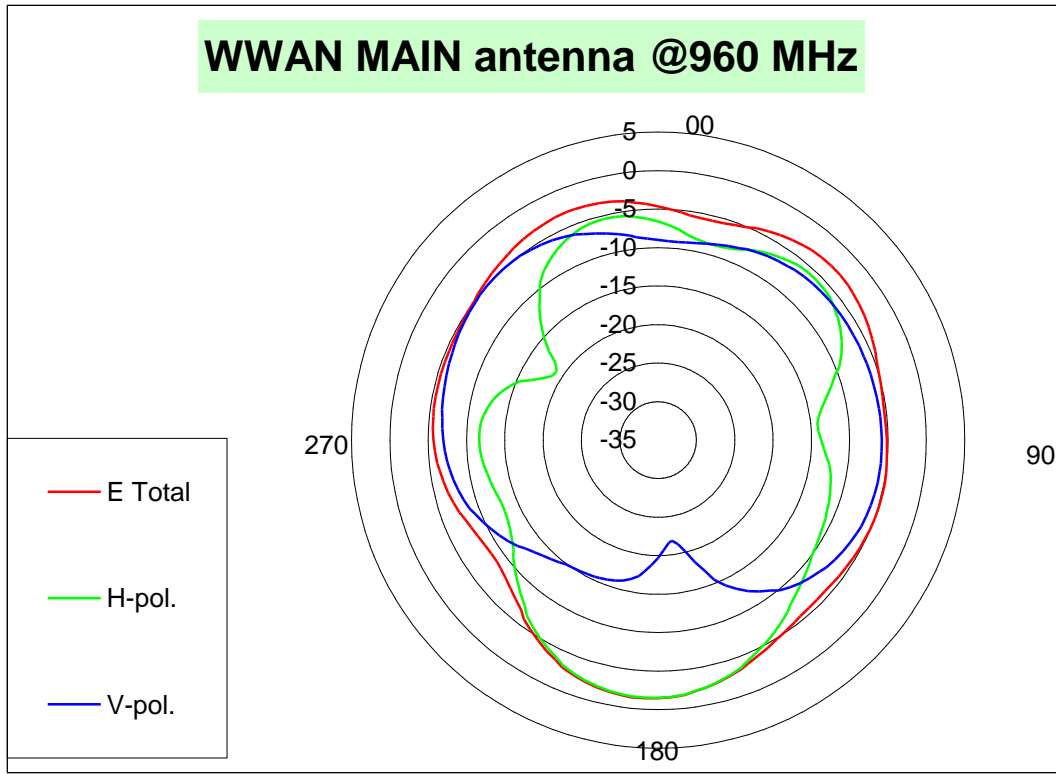

	H-pol	V pol
Peak Gain	-1.50	-4.99

WWAN Main antenna: 1710 MHz

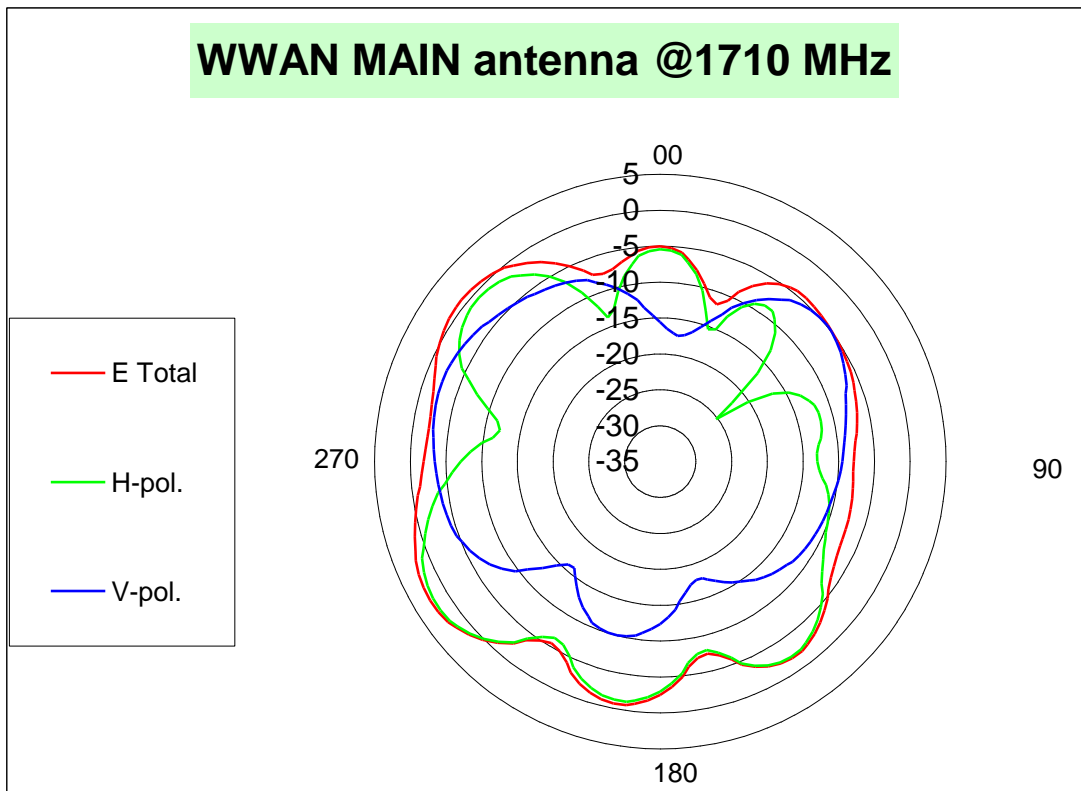

	H-pol	V pol
Peak Gain	2.08	-2.53

WWAN Main antenna: 1750 MHz

WWAN MAIN antenna @1750 MHz

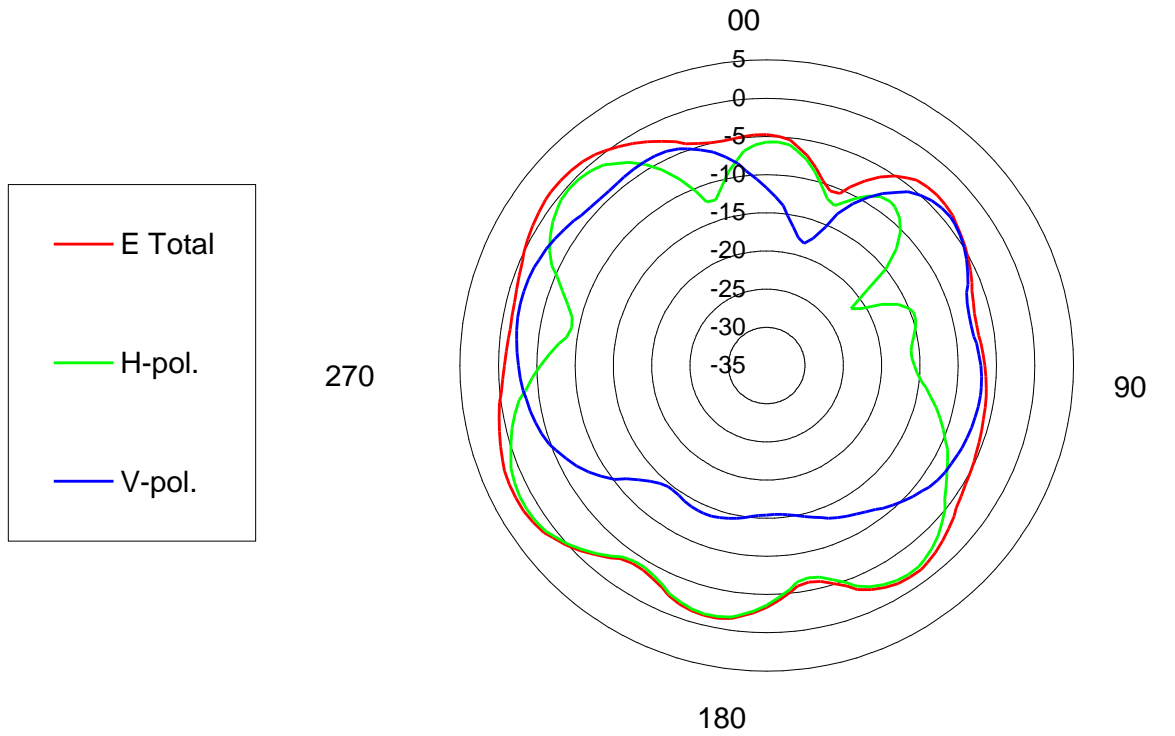

	H-pol	V pol
Peak Gain	1.48	-1.90

WWAN Main antenna: 1785 MHz

WWAN MAIN antenna @1785 MHz

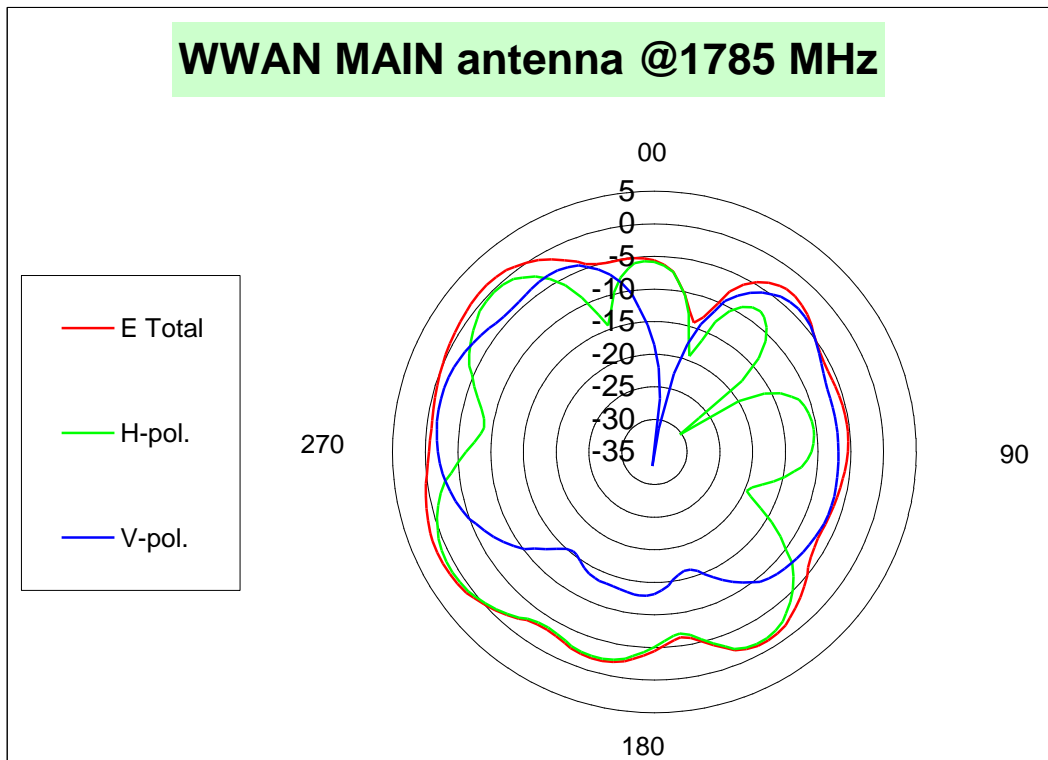

	H-pol	V pol
Peak Gain	0.93	-1.43

WWAN Main antenna: 1805 MHz

WWAN MAIN antenna @1805 MHz

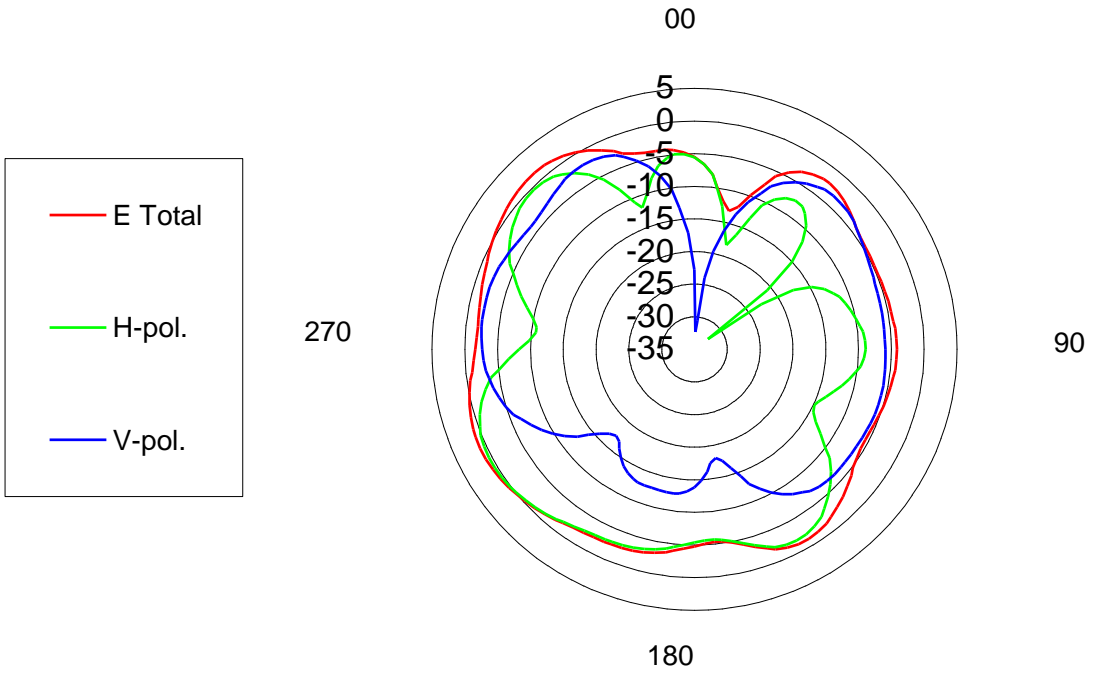

	H-pol	V pol
Peak Gain	0.43	-2.03

WWAN Main antenna: 1840 MHz

WWAN MAIN antenna @1840 MHz

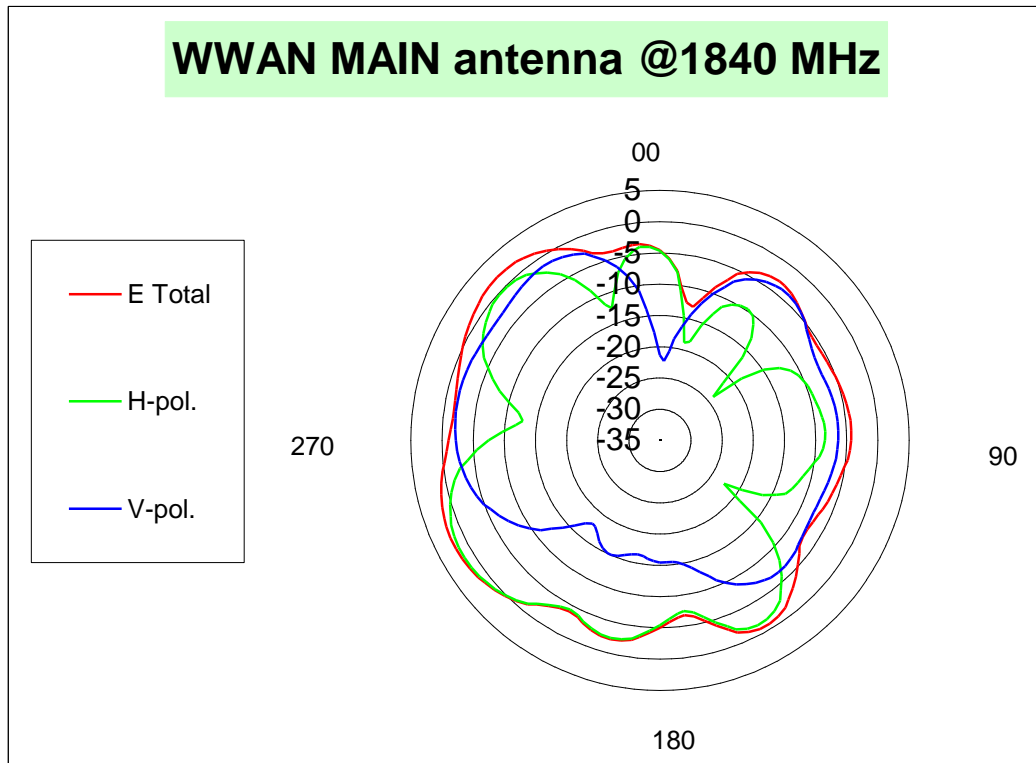

	H-pol	V pol
Peak Gain	1.54	-1.46

WWAN Main antenna: 1880 MHz

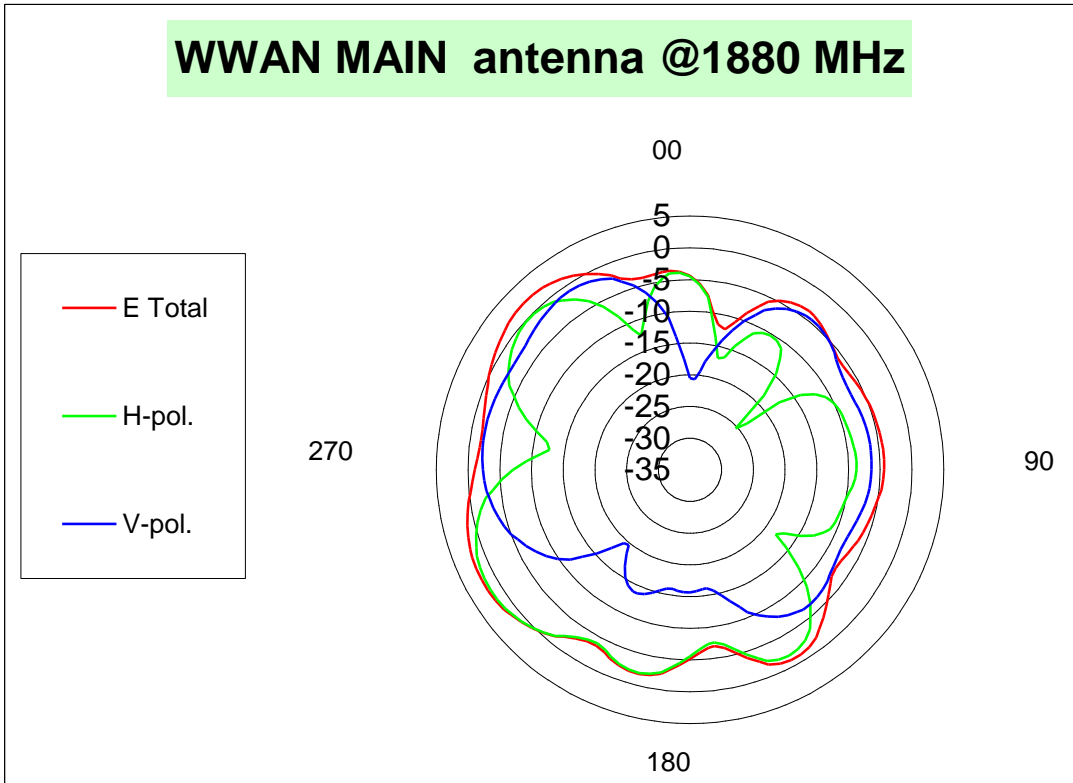

	H-pol	V pol
Peak Gain	1.69	-1.02

WWAN Main antenna: 1910 MHz

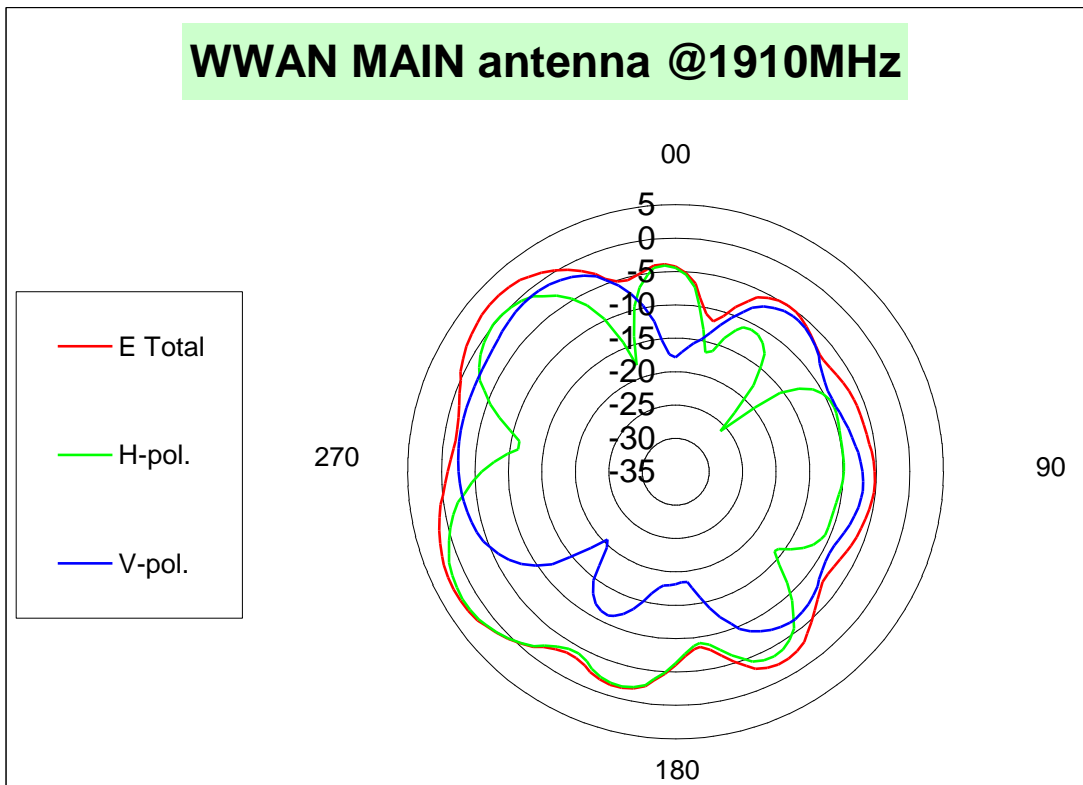

	H-pol	V pol
Peak Gain	2.10	-1.02

WWAN Main antenna: 1920 MHz

WWAN MAIN antenna @1920MHz

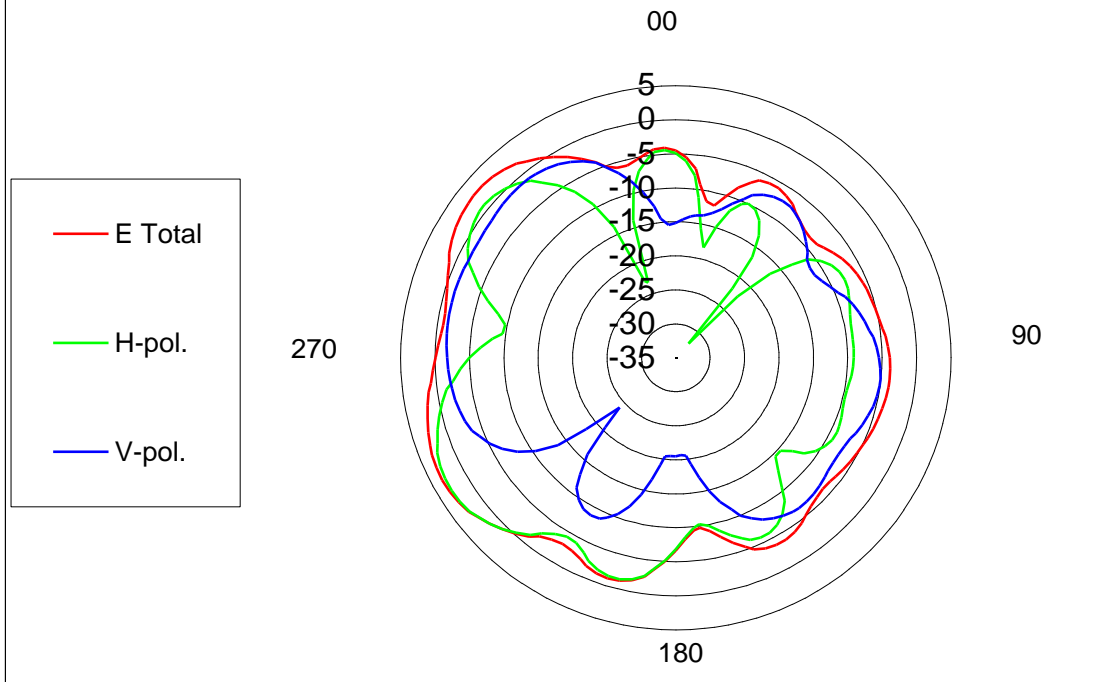

	H-pol	V pol
Peak Gain	2.98	-1.05

WWAN Main antenna: 1930 MHz

WWAN MAIN antenna @1930MHz

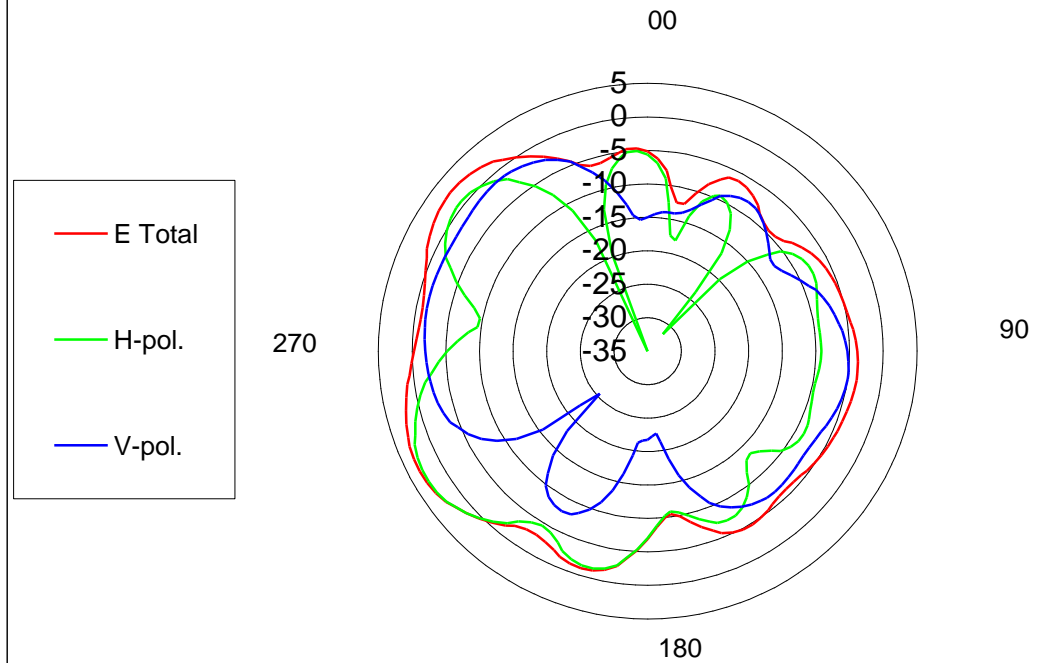

	H-pol	V pol
Peak Gain	2.90	-1.23

WWAN Main antenna: 1950 MHz

WWAN MAIN antenna @1950MHz

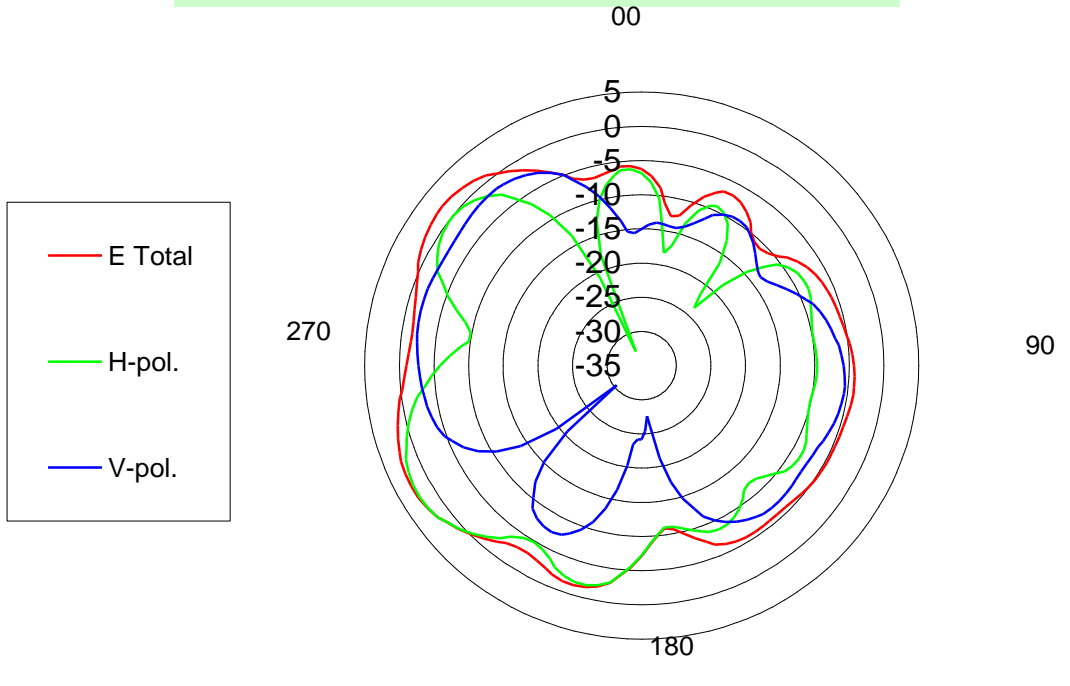

	H-pol	V pol
Peak Gain	2.36	-1.73

WWAN Main antenna: 1960 MHz

WWAN MAIN antenna @1960MHz

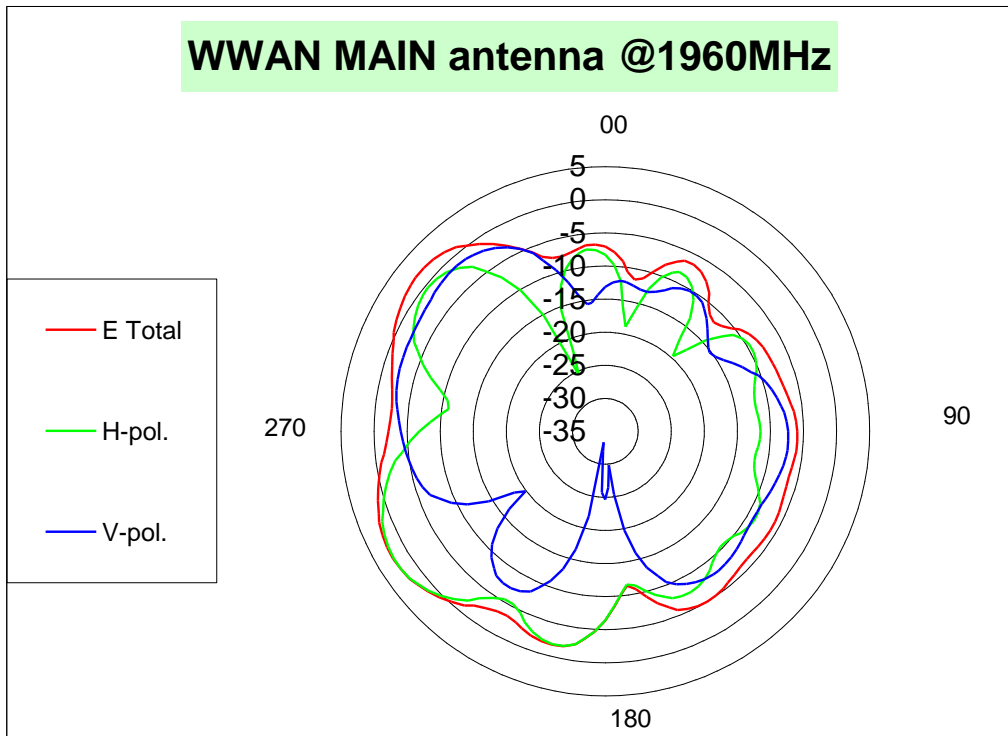

	H-pol	V pol
Peak Gain	2.32	-1.39

WWAN Main antenna: 1980 MHz

WWAN MAIN antenna @1980MHz

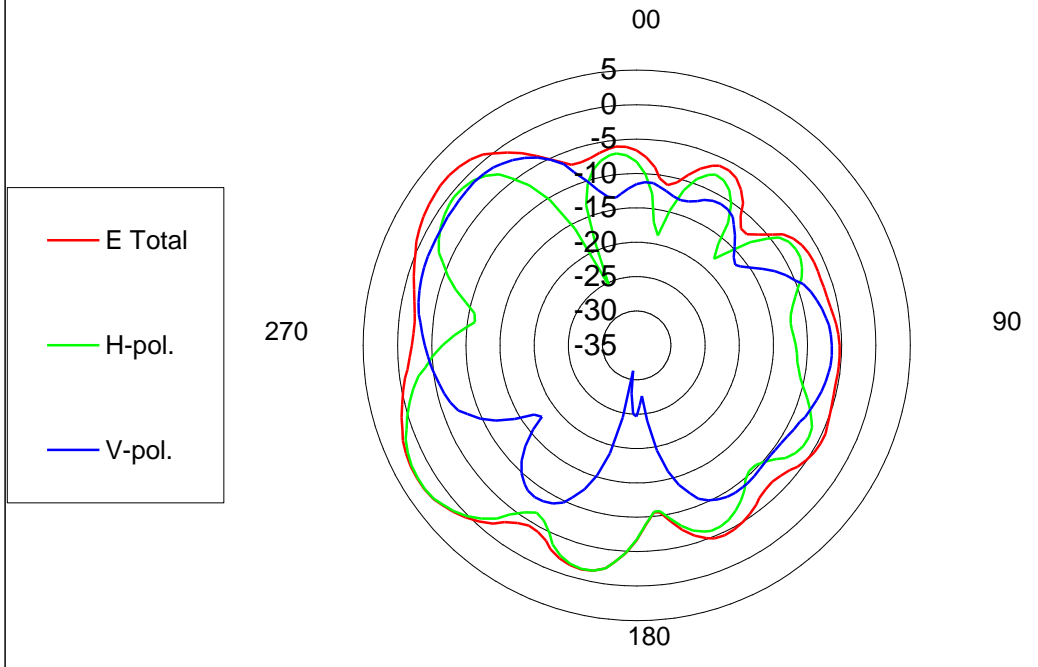

	H-pol	V pol
Peak Gain	2.40	-1.47

WWAN Main antenna: 1990 MHz

WWAN MAIN antenna @1990MHz

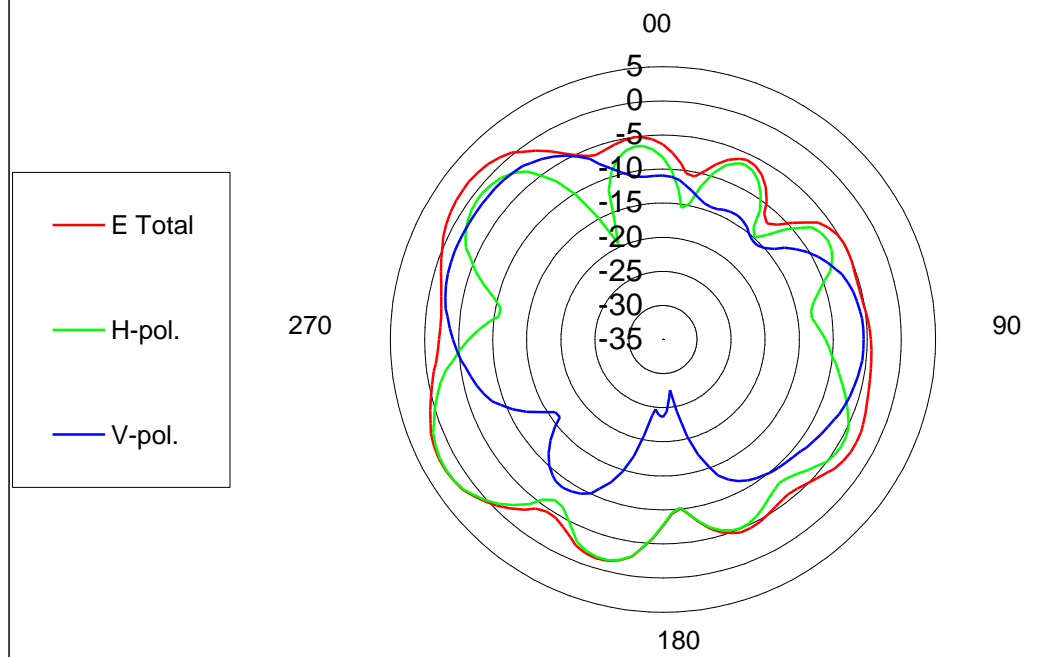

	H-pol	V pol
Peak Gain	2.14	-1.84

WWAN Main antenna: 2110 MHz

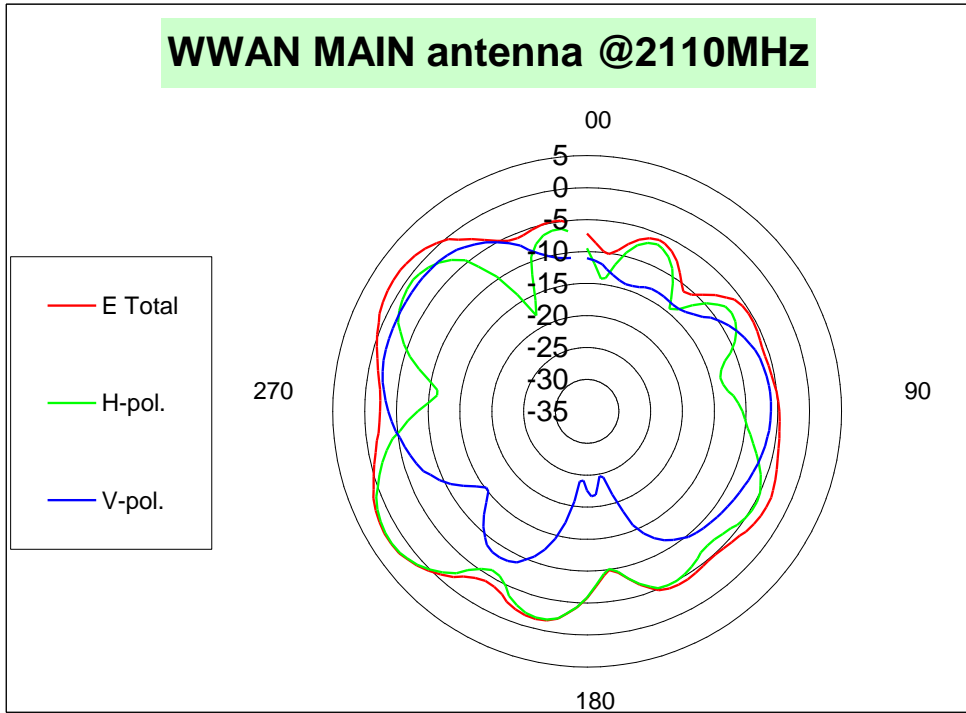

	H-pol	V pol
Peak Gain	2.02	0.00

WWAN Main antenna: 2140 MHz

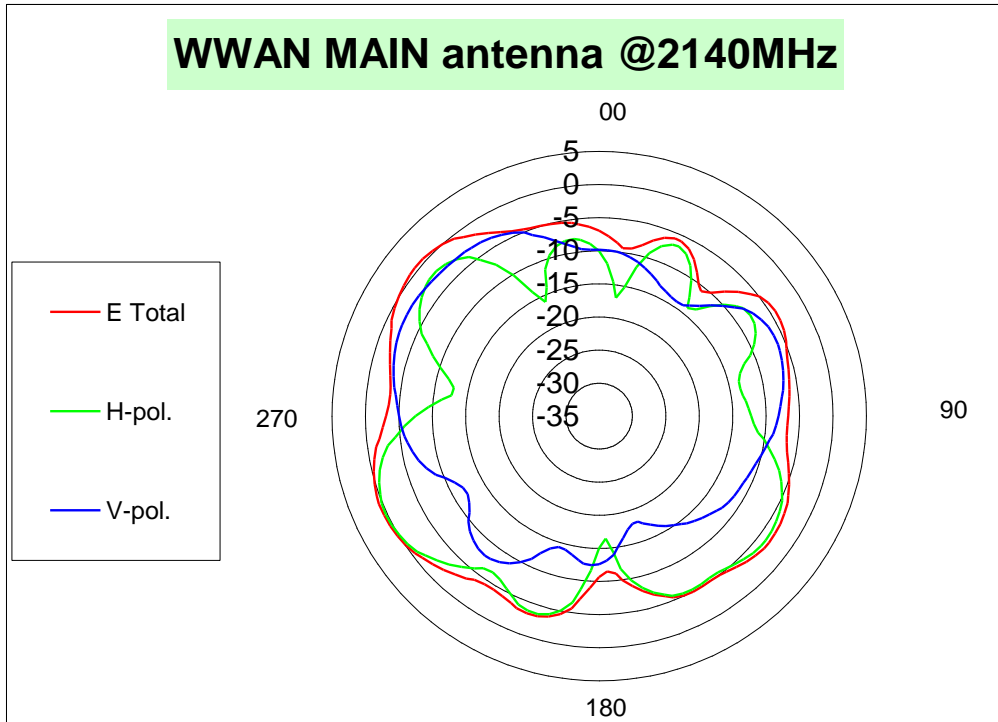

	H-pol	V pol
Peak Gain	0.21	-2.38

WWAN Main antenna: 2170 MHz

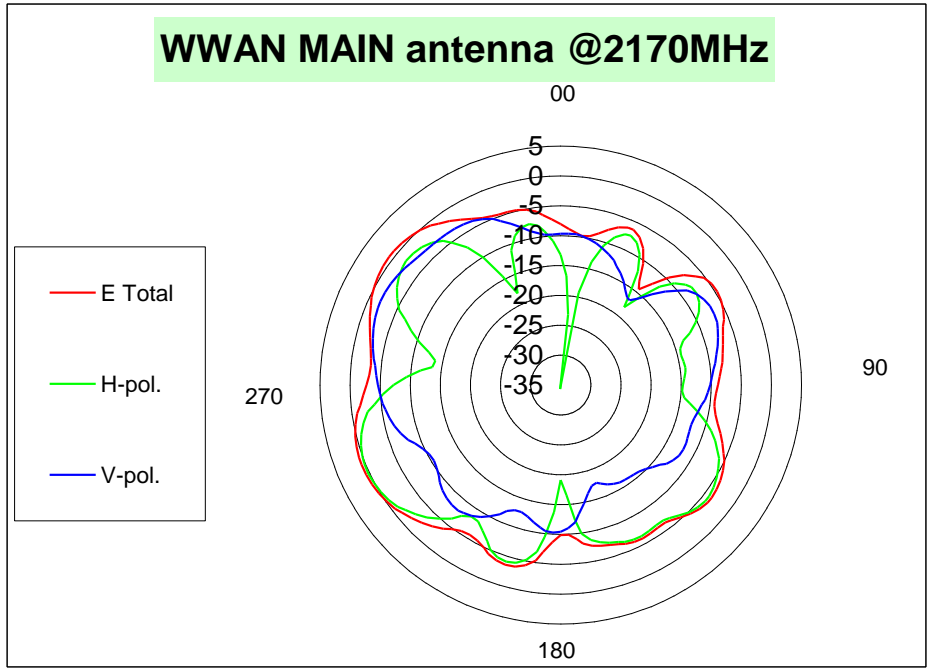

	H-pol	V pol
Peak Gain	0.22	-1.94

WWAN Aux antenna: 869 MHz

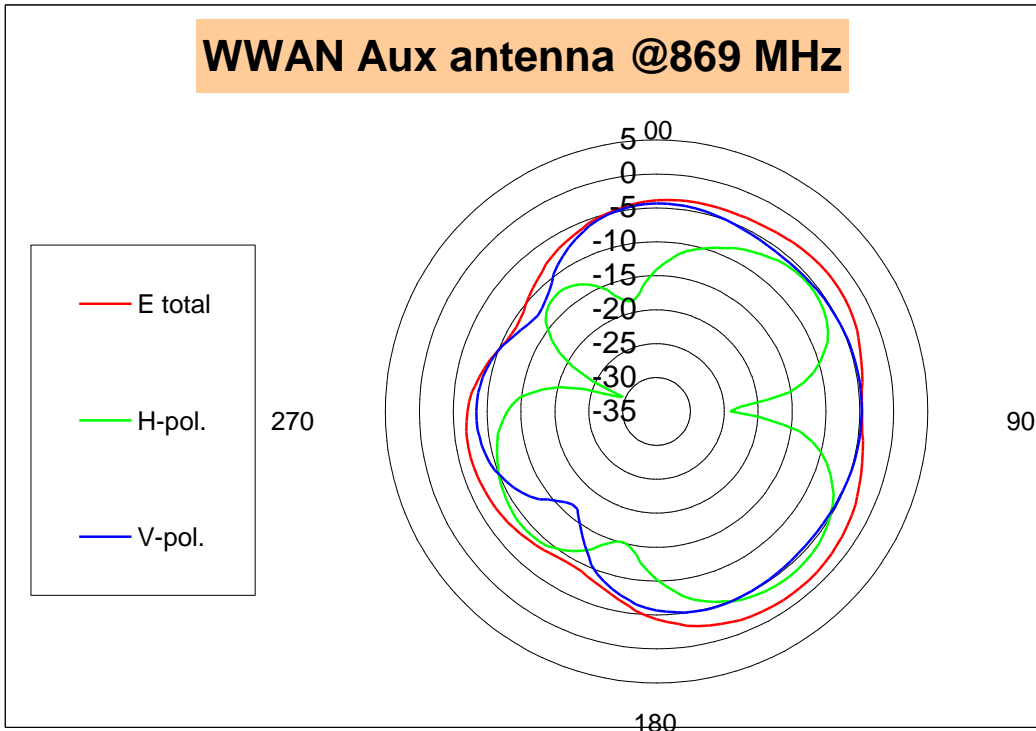

	H-pol	V pol
Peak Gain	-3.74	-4.36

WWAN Aux antenna: 880 MHz

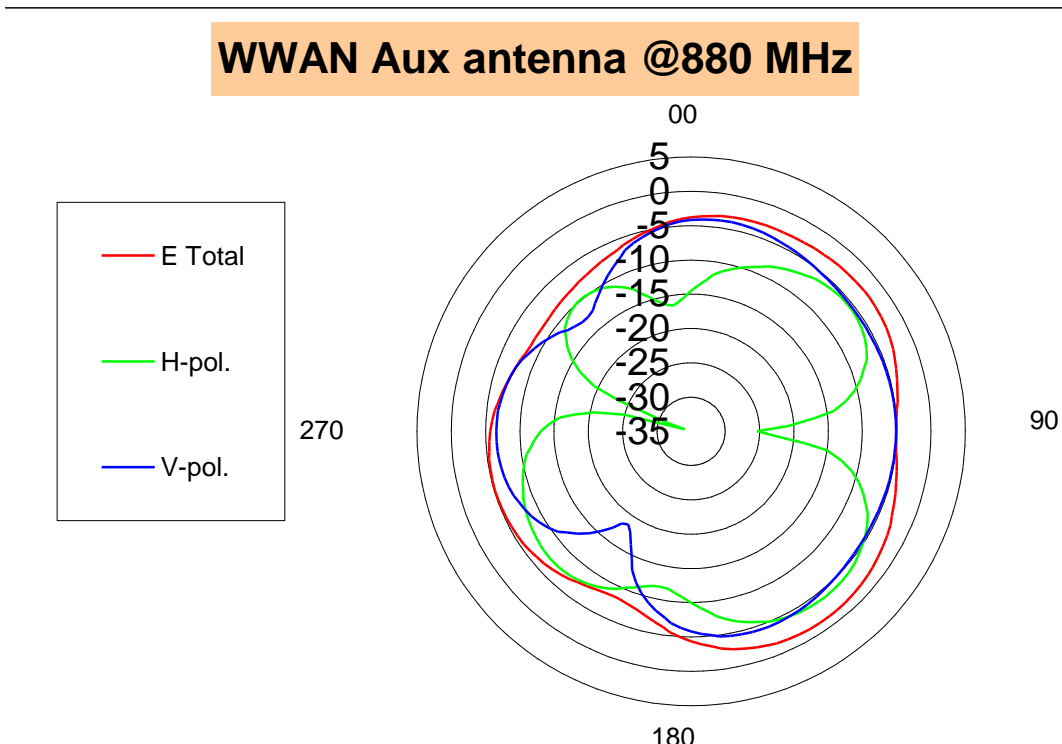

	H-pol	V pol
Peak Gain	-3.89	-3.96

WWAN Aux antenna: 894 MHz

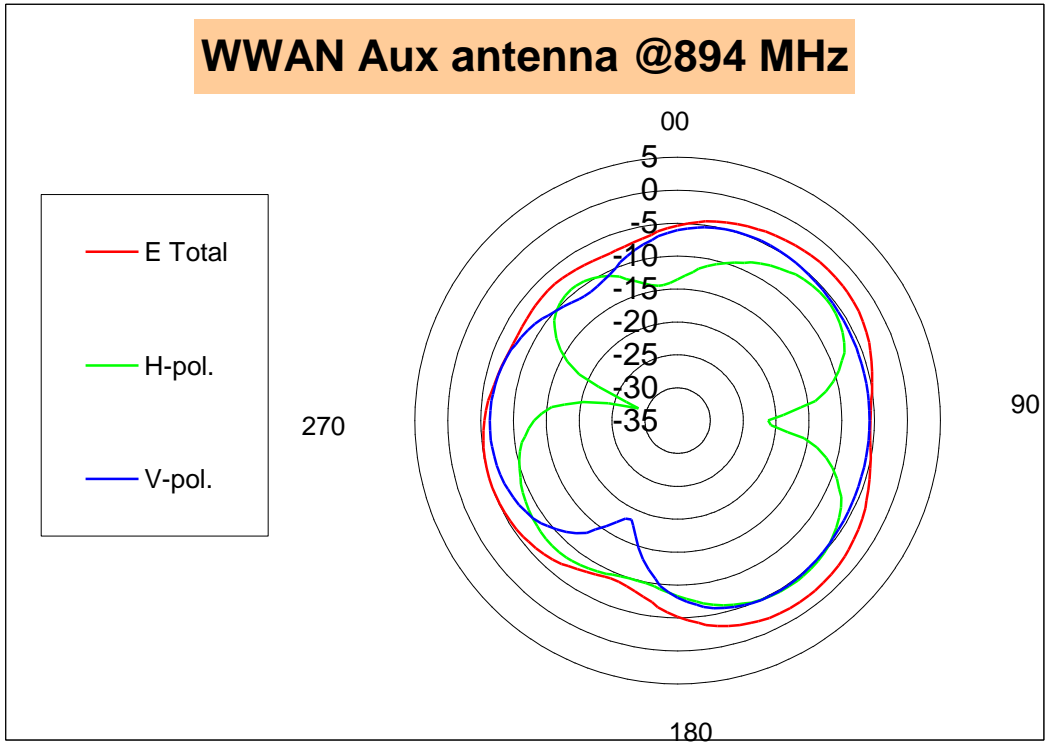

	H-pol	V pol
Peak Gain	-4.56	-4.81

WWAN Aux antenna: 1930 MHz

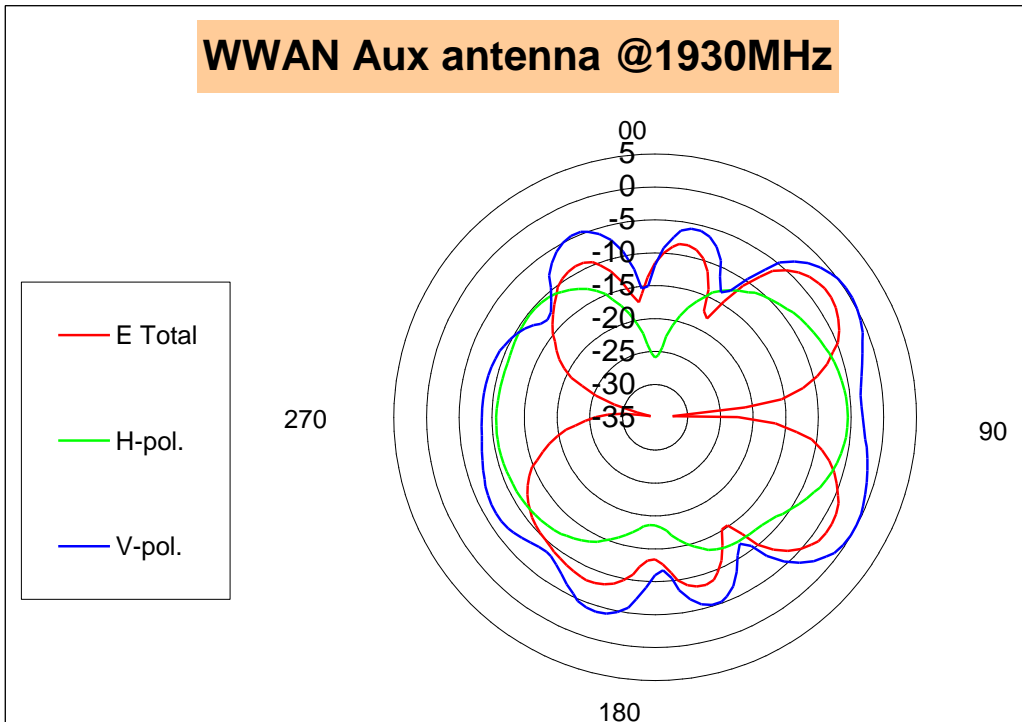

	H-pol	V pol
Peak Gain	-5.50	0.23

WWAN Aux antenna: 1950 MHz

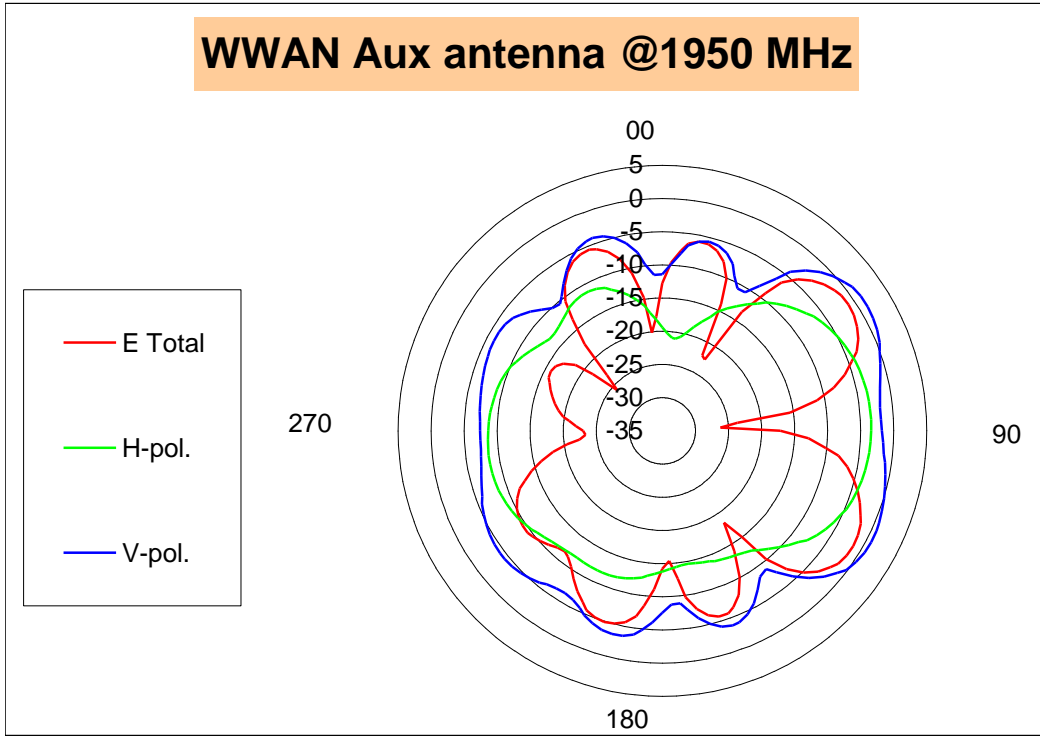

	H-pol	V pol
Peak Gain	-3.36	1.28

WWAN Aux antenna: 1960 MHz

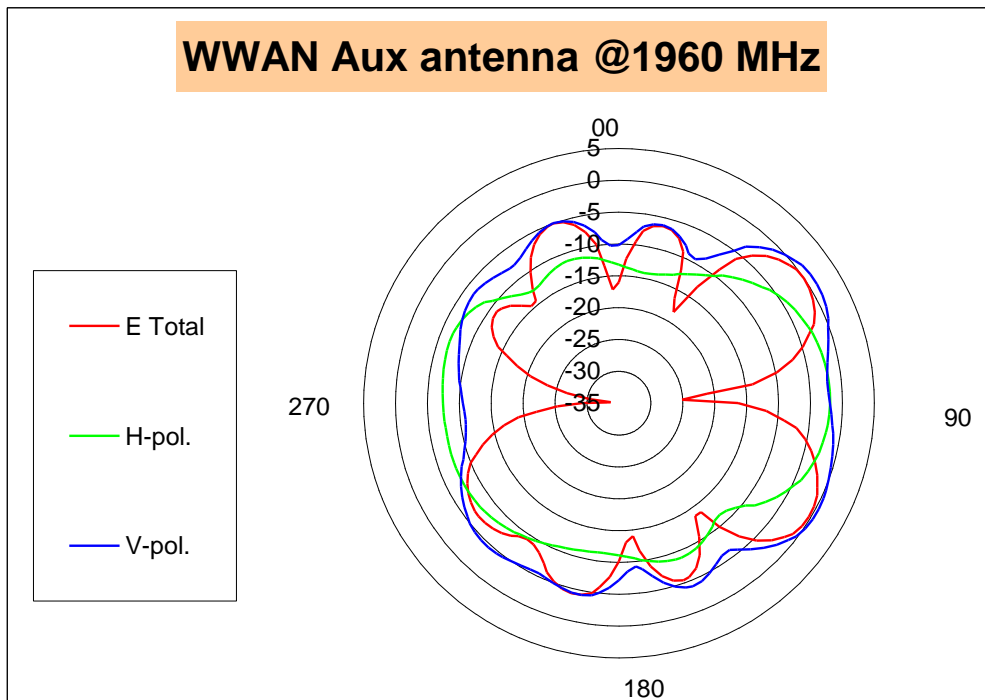

	H-pol	V pol
Peak Gain	-1.90	1.24

WWAN Aux antenna: 1980 MHz

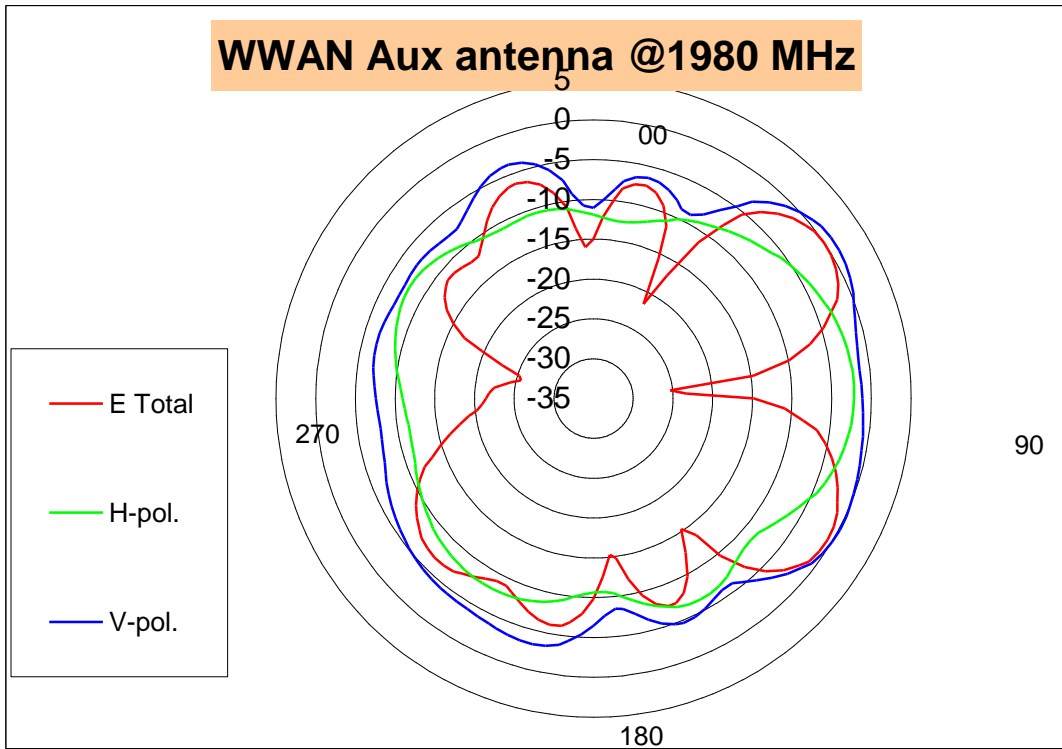

	H-pol	V pol
Peak Gain	-2.14	1.13

WWAN Aux antenna: 1990 MHz

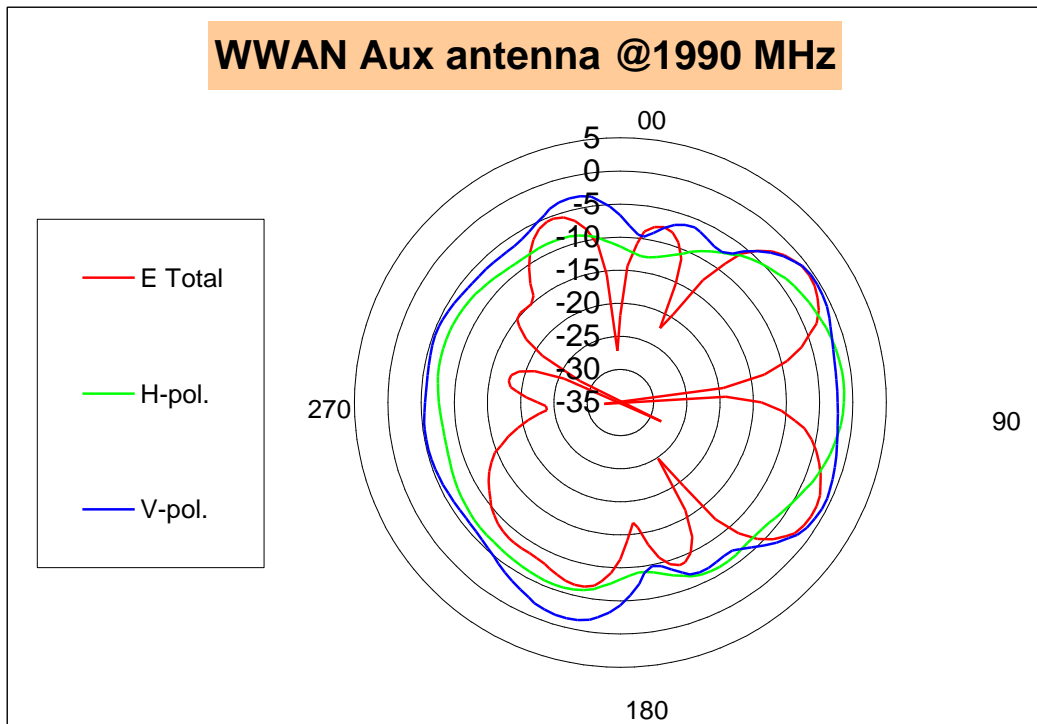

	H-pol	V pol
Peak Gain	-1.28	-0.39

WWAN Aux antenna: 2110 MHz

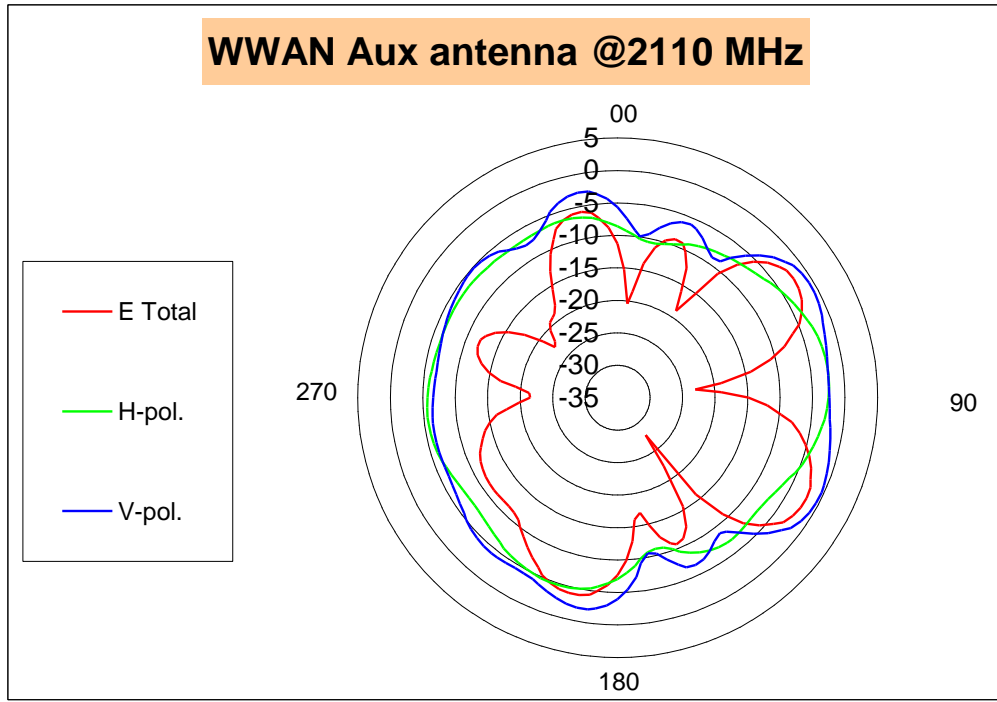

	H-pol	V pol
Peak Gain	-2.34	-0.38

WWAN Aux antenna: 2140 MHz

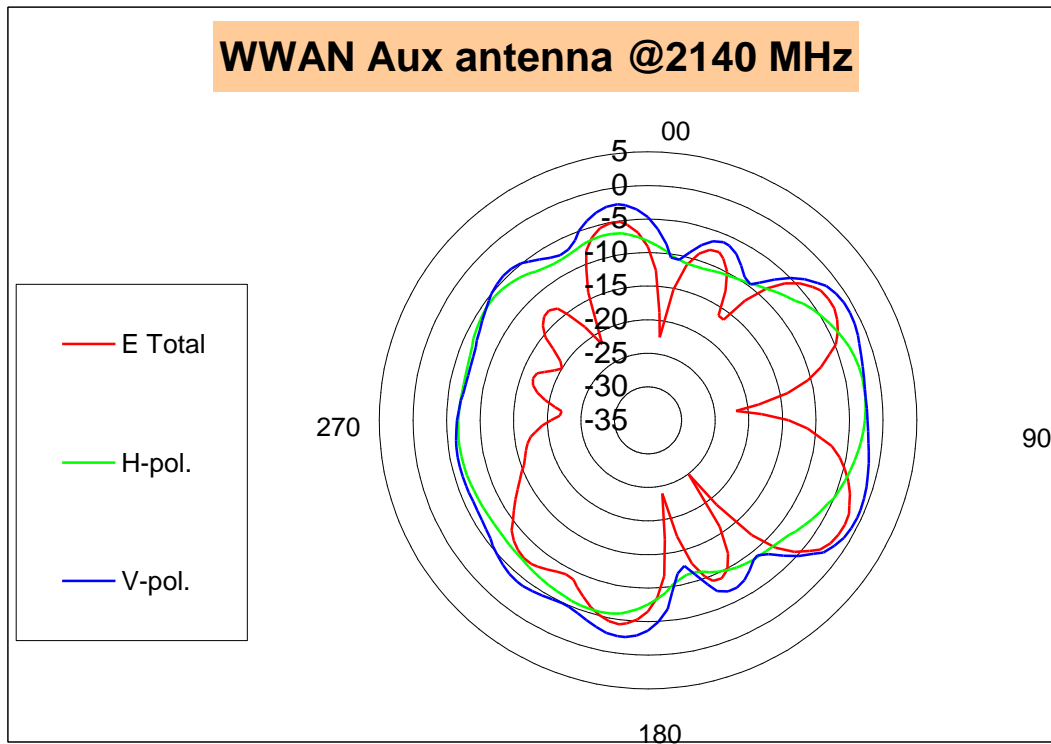

	H-pol	V pol
Peak Gain	-2.44	-0.59

WWAN Aux antenna: 2170 MHz

WWAN Aux antenna @2170 MHz

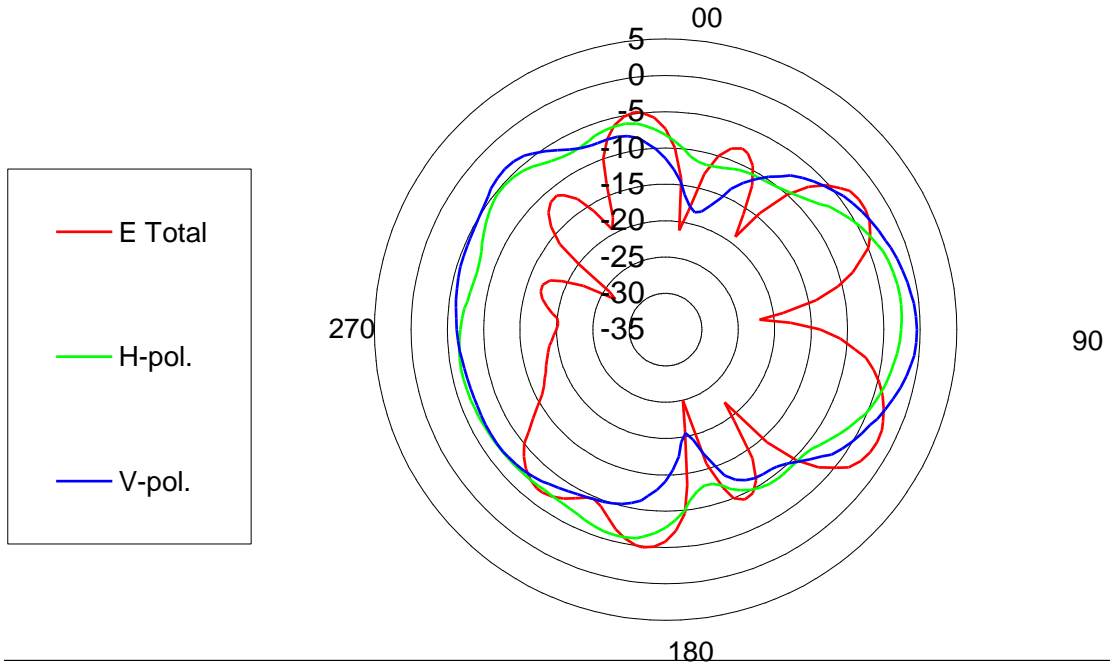

	H-pol	V pol
Peak Gain	-2.45	-0.47

WLAN MAIN antenna: 2400 MHz

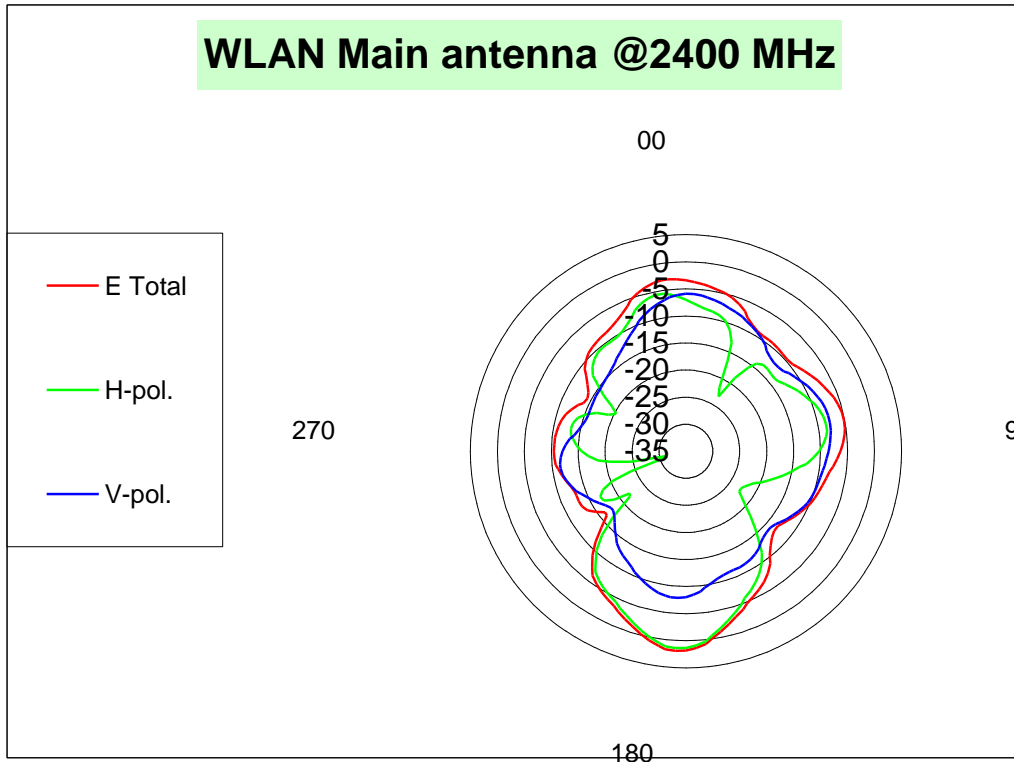

	H-pol	V pol
Peak Gain	1.43	-5.96

WLAN MAIN antenna: 2450 MHz

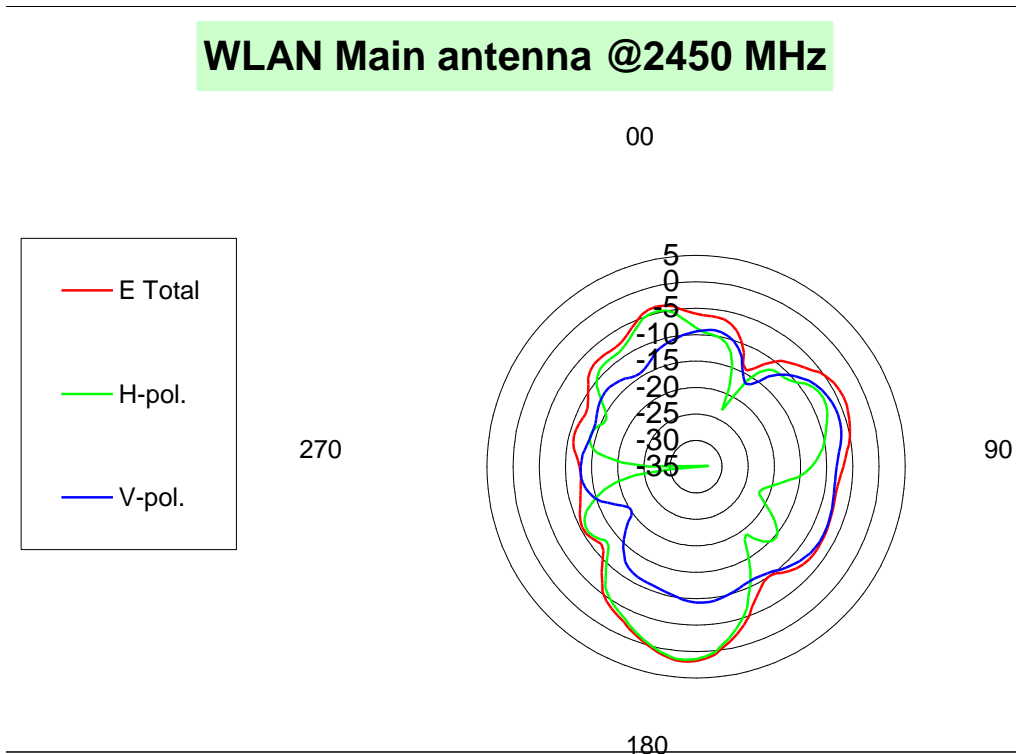

	H-pol	V pol
Peak Gain	1.66	-6.07

WLAN MAIN antenna: 2500 MHz

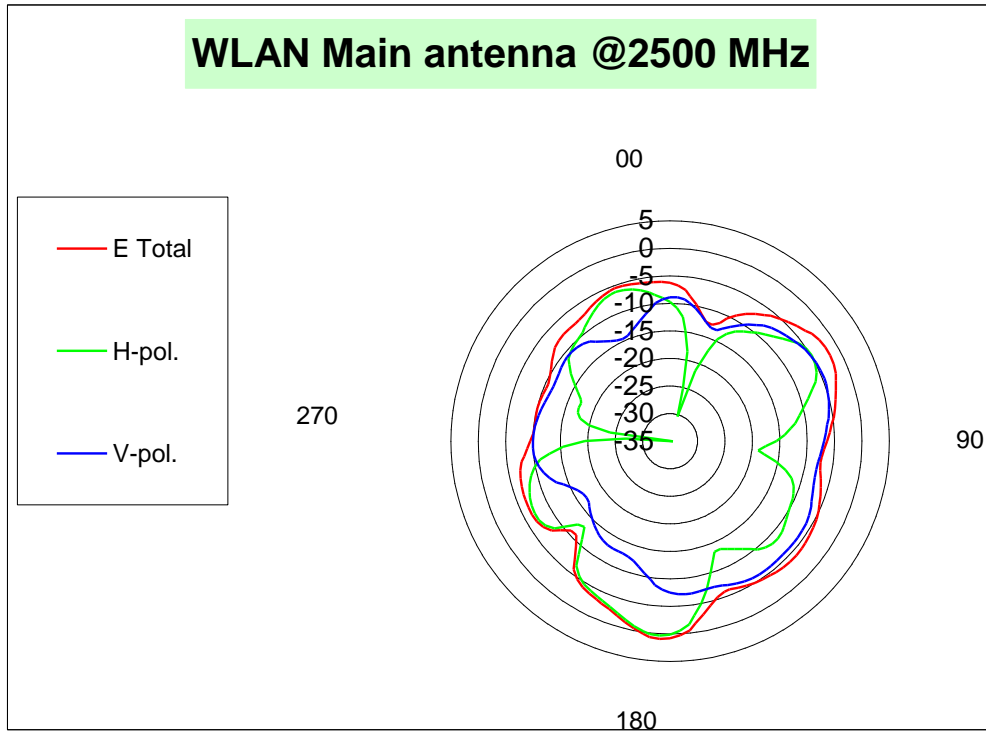

	H-pol	V pol
Peak Gain	0.39	-4.62

WLAN MAIN antenna: 5150 MHz

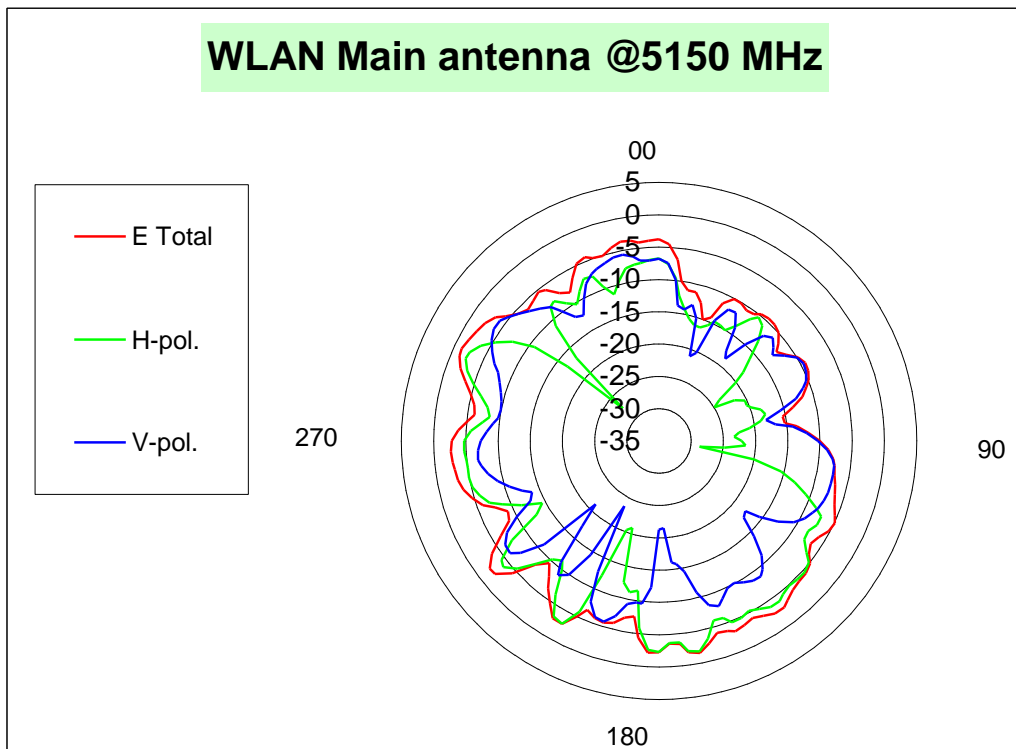

	H-pol	V pol
Peak Gain	-1.80	-4.09

WLAN MAIN antenna: 5250 MHz

WLAN Main antenna @5250 MHz

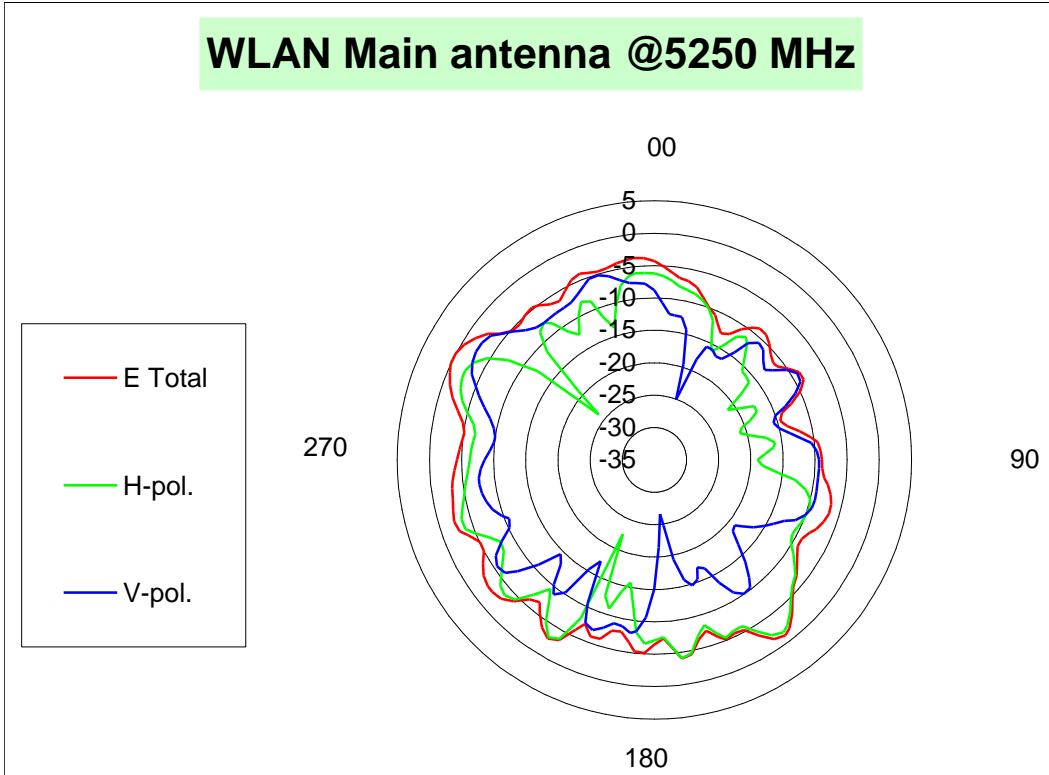

	H-pol	V pol
Peak Gain	-1.62	-2.64

WLAN MAIN antenna: 5350 MHz

WLAN Main antenna @5250 MHz

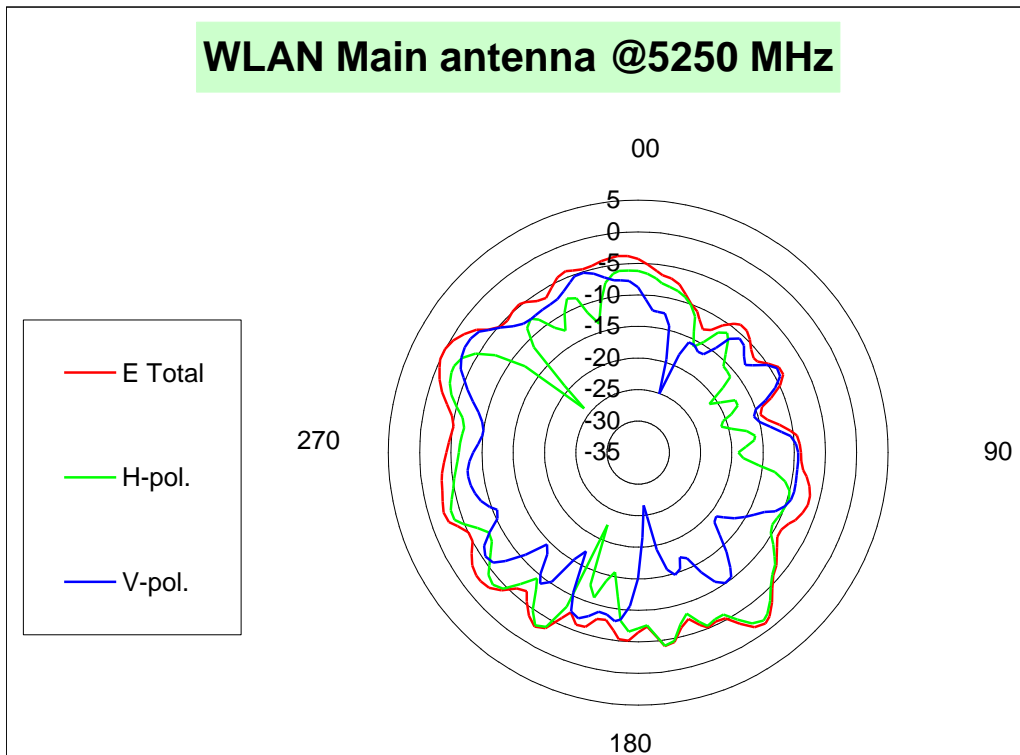

	H-pol	V pol
Peak Gain	-1.62	-2.64

WLAN MAIN antenna: 5470 MHz

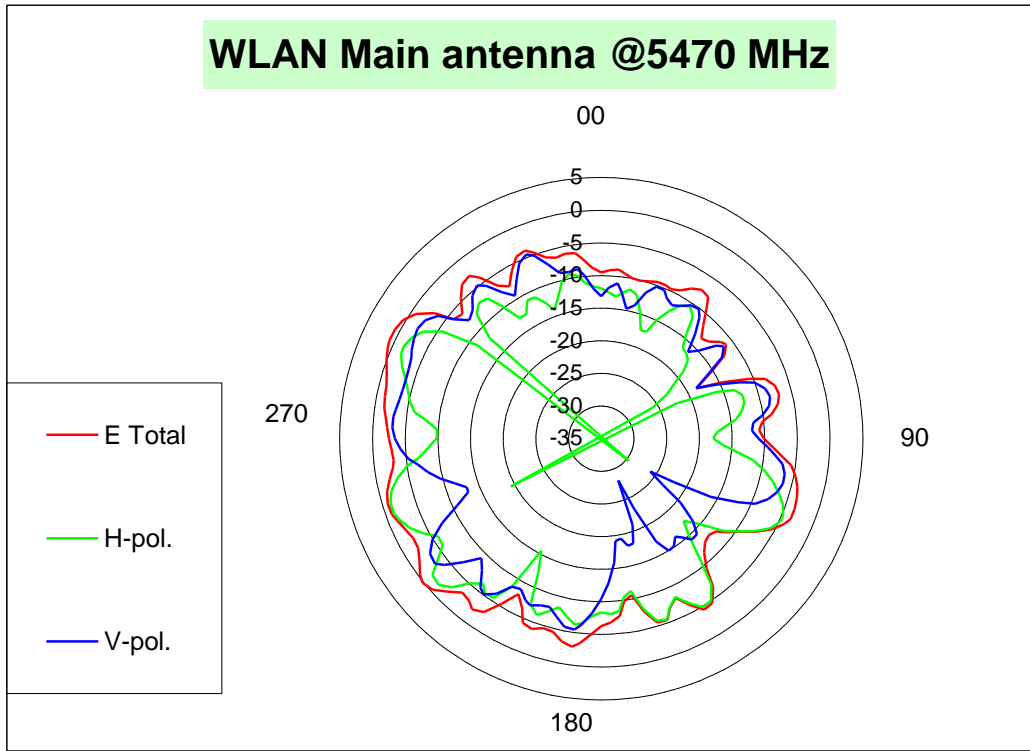

	H-pol	V pol
Peak Gain	-1.29	-2.27

WLAN MAIN antenna: 5600 MHz

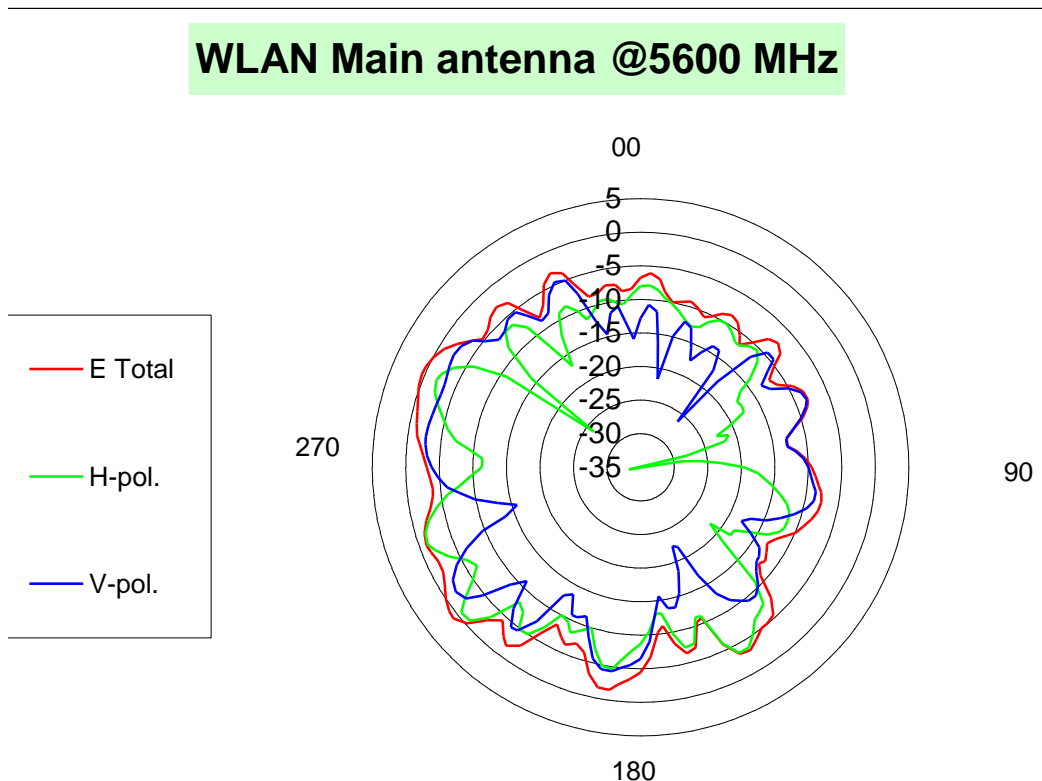

	H-pol	V pol
Peak Gain	-0.57	-1.78

WLAN MAIN antenna: 5725 MHz

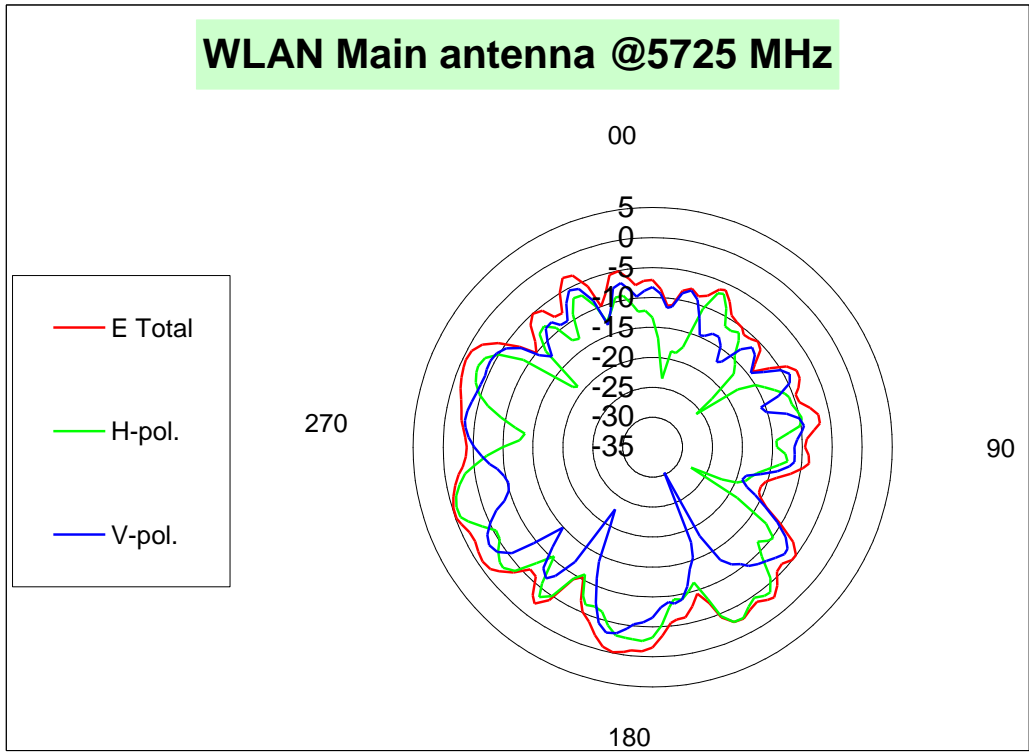

	H-pol	V pol
Peak Gain	-0.77	-3.09

WLAN MAIN antenna: 5785 MHz

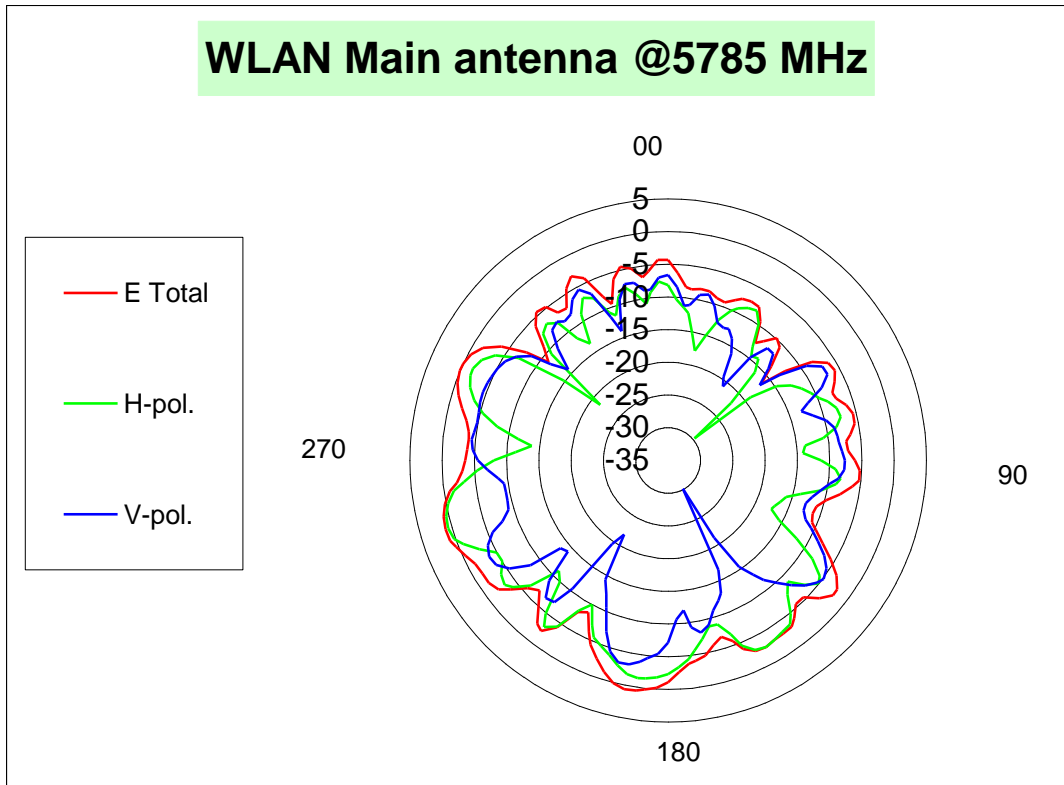

	H-pol	V pol
Peak Gain	0.58	-3.17

WLAN MAIN antenna: 5850 MHz

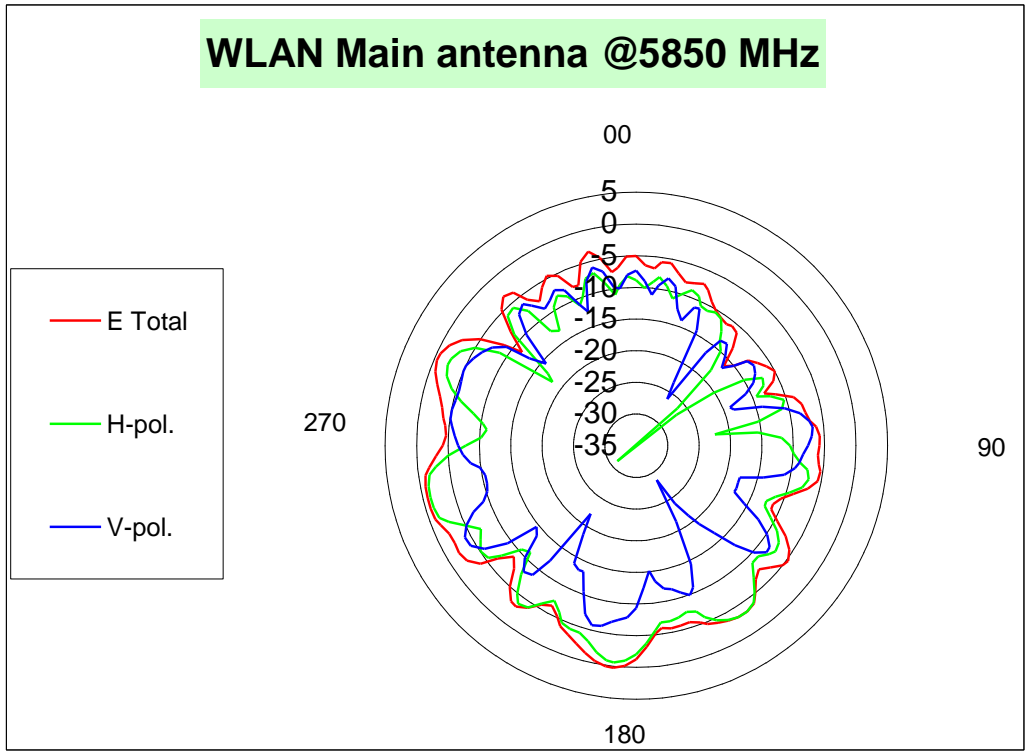

	H-pol	V pol
Peak Gain	-0.56	-4.12

WLAN AUX antenna: 2400 MHz

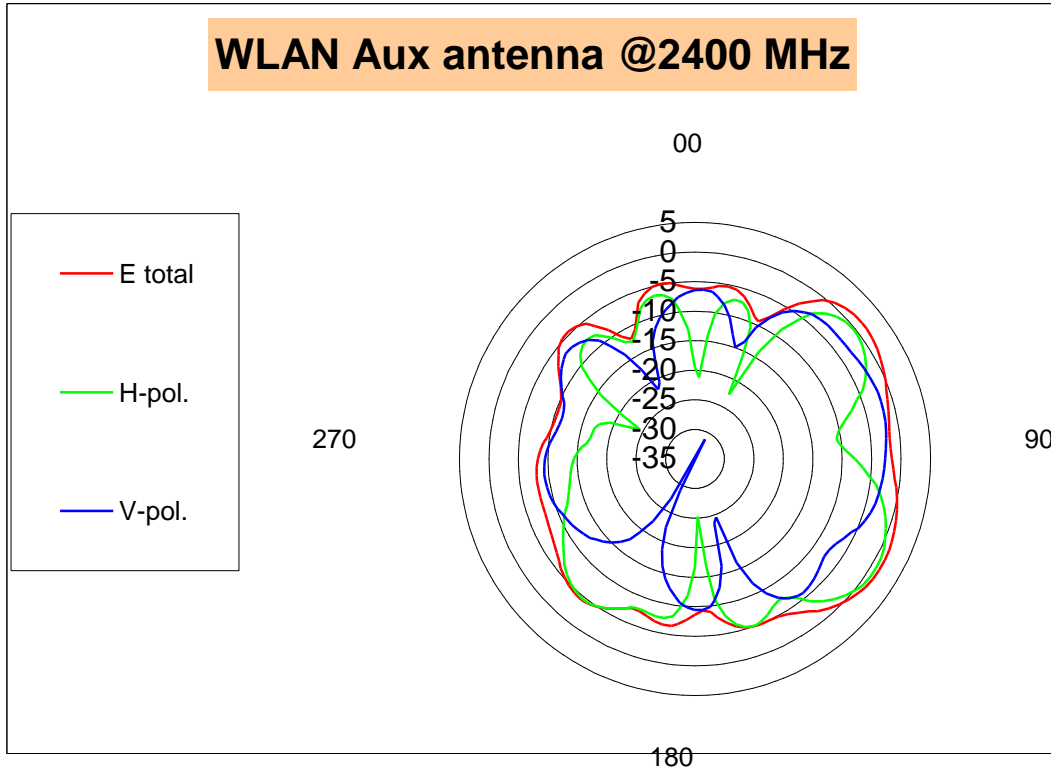

	H-pol	V pol
Peak Gain	0.91	-1.91

WLAN AUX antenna: 2450 MHz

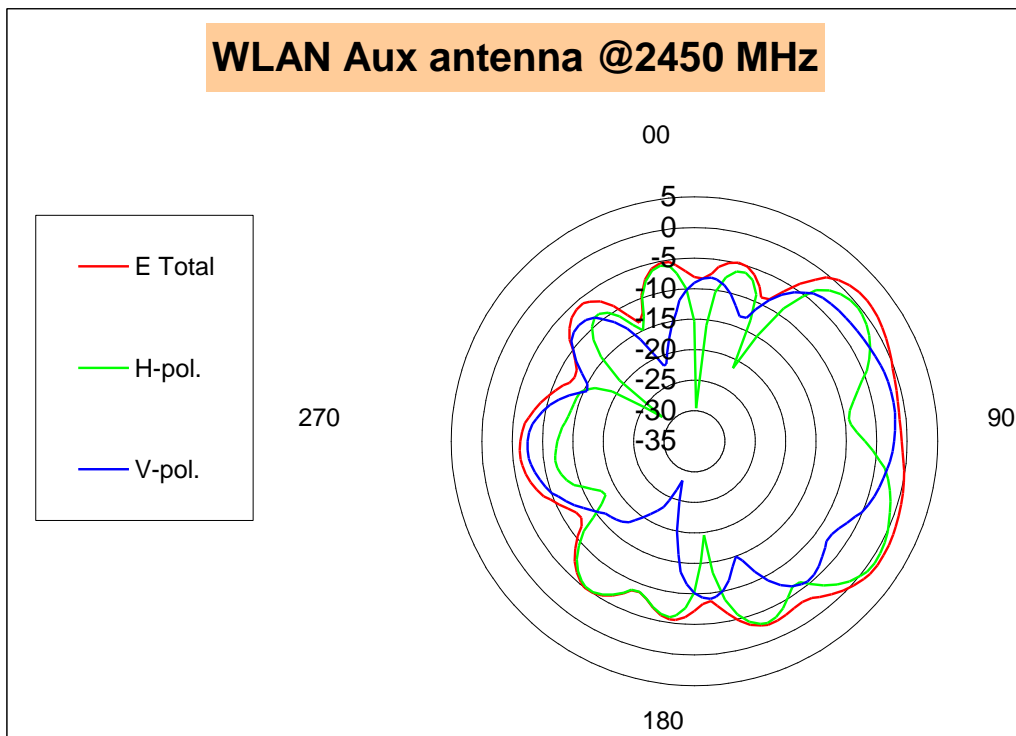

	H-pol	V pol
Peak Gain	0.74	-1.64

WLAN AUX antenna: 2500 MHz

WLAN Aux antenna @2500 MHz

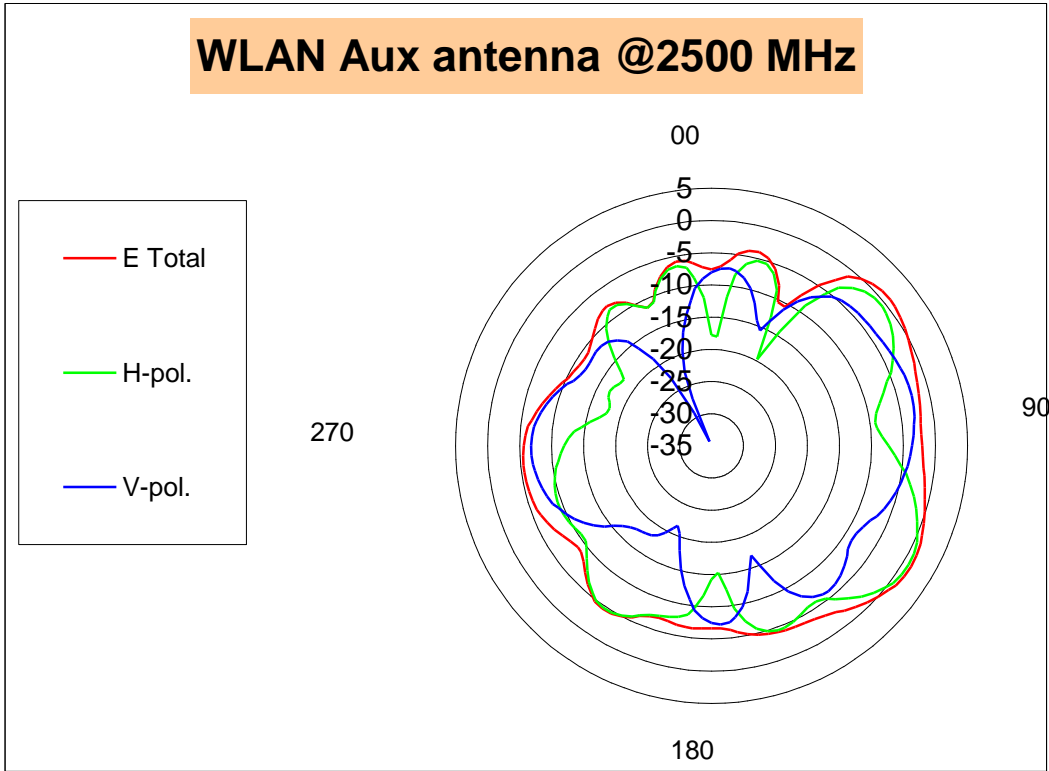

	H-pol	V pol
Peak Gain	0.94	-2.76

WLAN AUX antenna: 5150 MHz

WLAN Aux antenna @5150 MHz

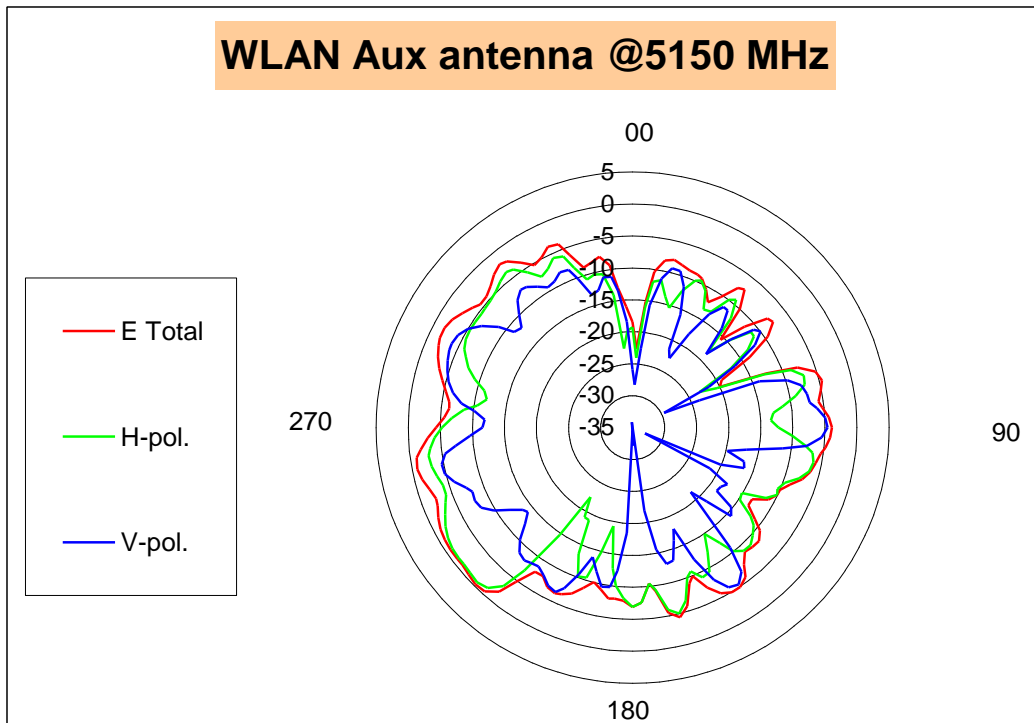

	H-pol	V pol
Peak Gain	-0.78	-3.89

WLAN AUX antenna: 5250 MHz

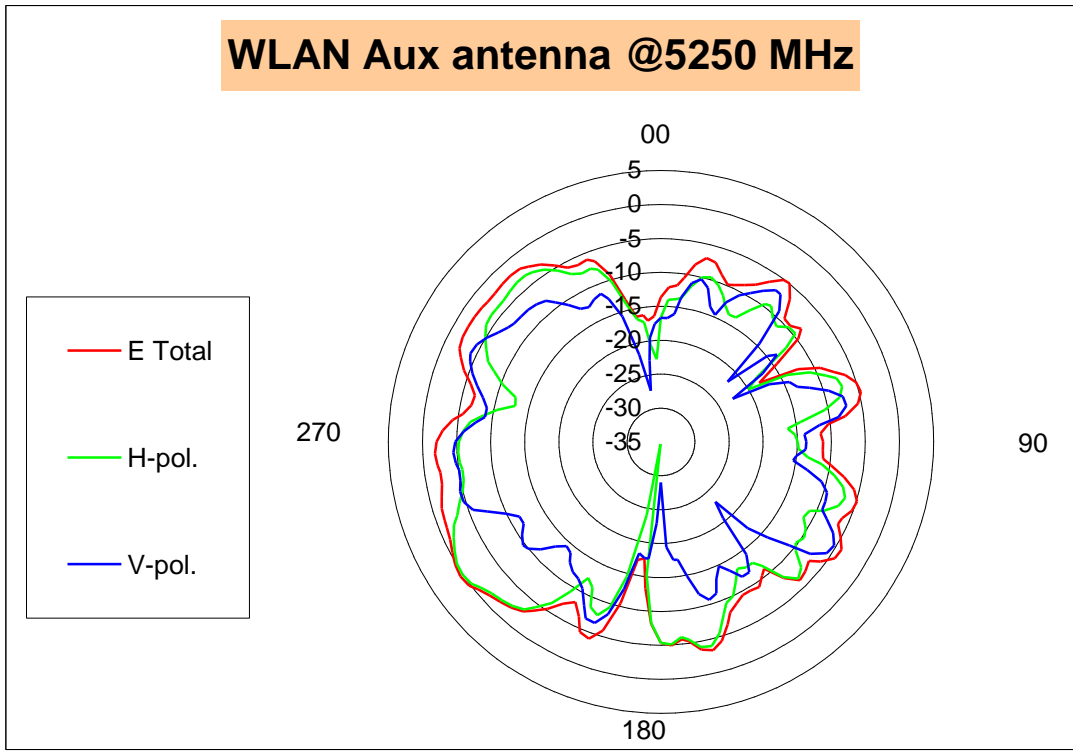

	H-pol	V pol
Peak Gain	0.09	-4.19

WLAN AUX antenna: 5350 MHz

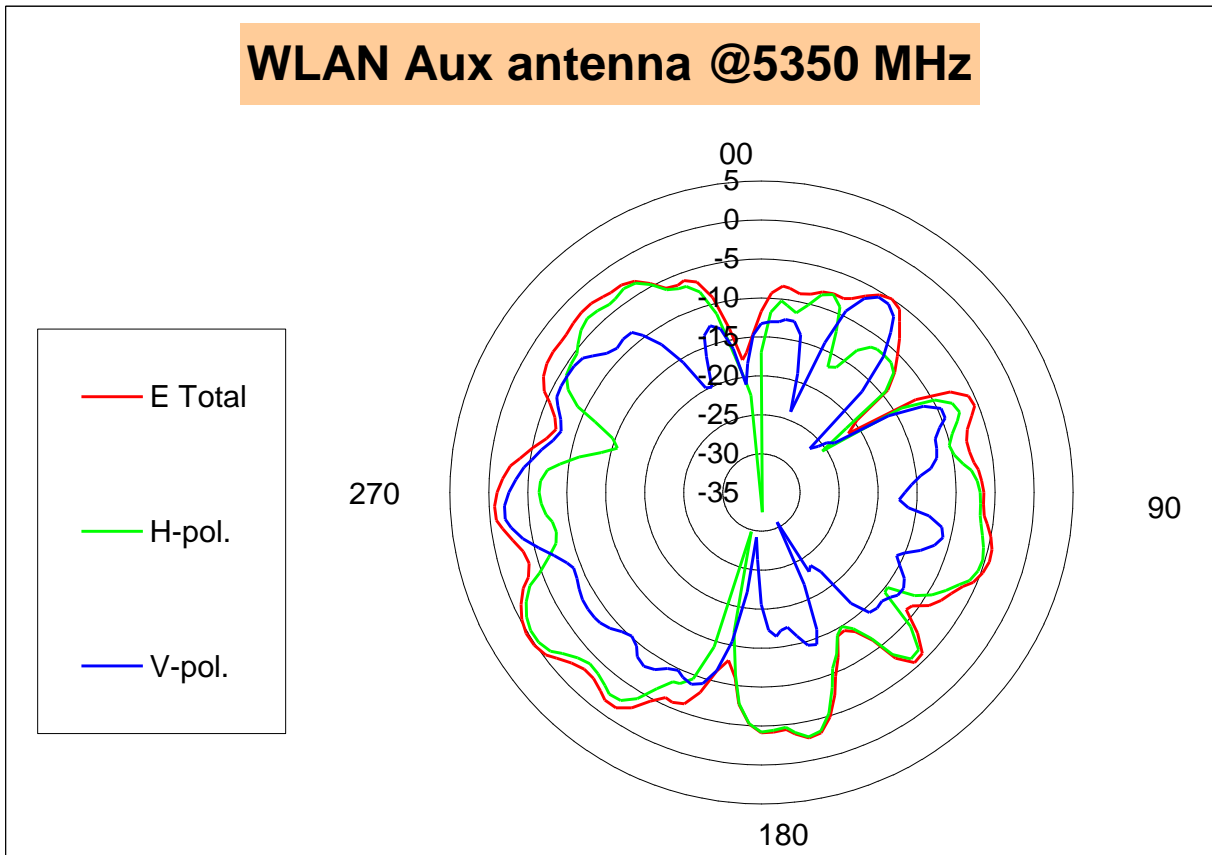

	H-pol	V pol
Peak Gain	-0.48	-1.94

WLAN AUX antenna: 5470 MHz

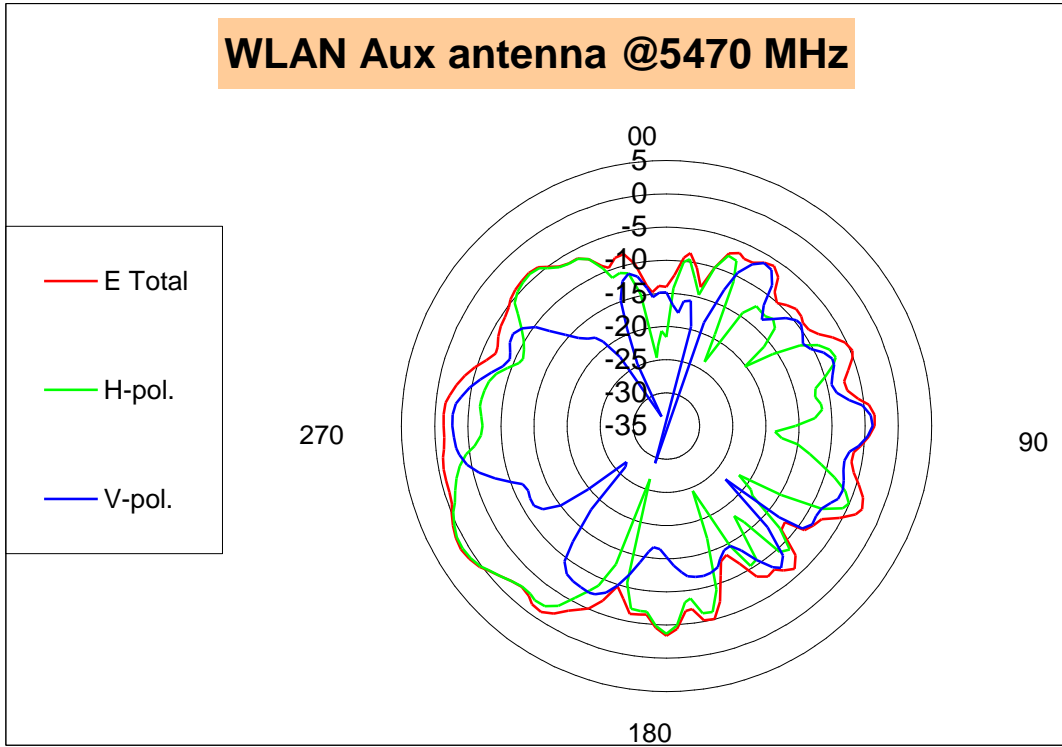

	H-pol	V pol
Peak Gain	0.86	-2.72

WLAN AUX antenna: 5600 MHz

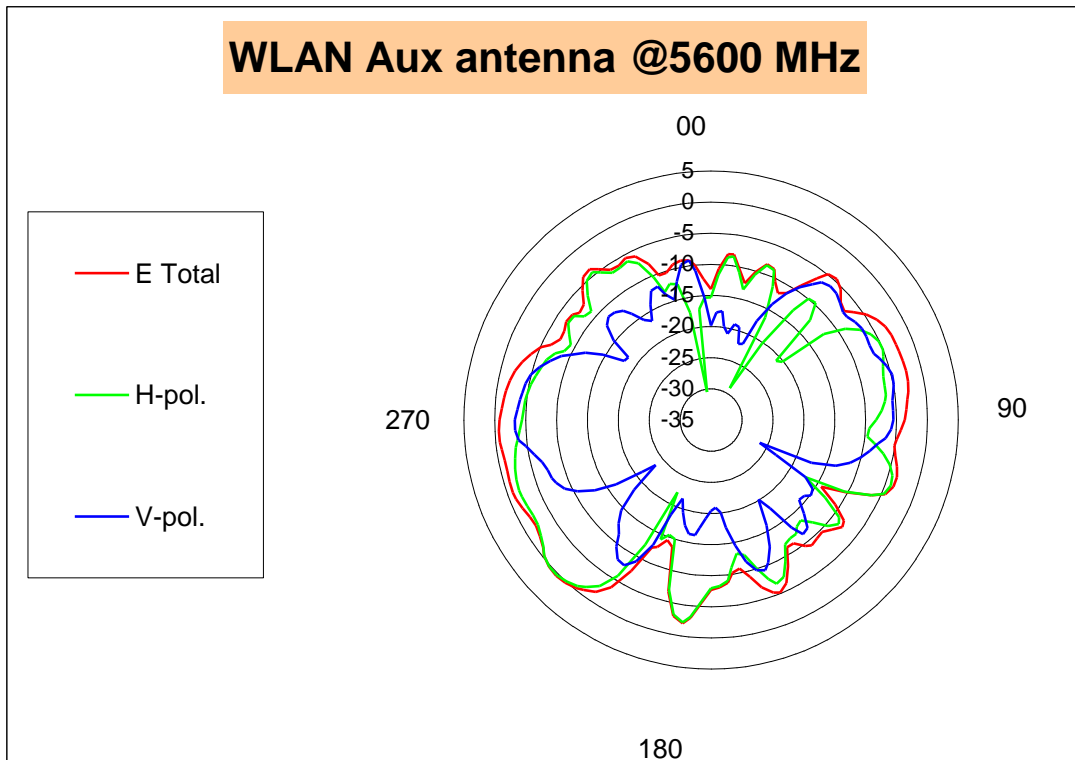

	H-pol	V pol
Peak Gain	0.27	-3.26

WLAN AUX antenna: 5725 MHz

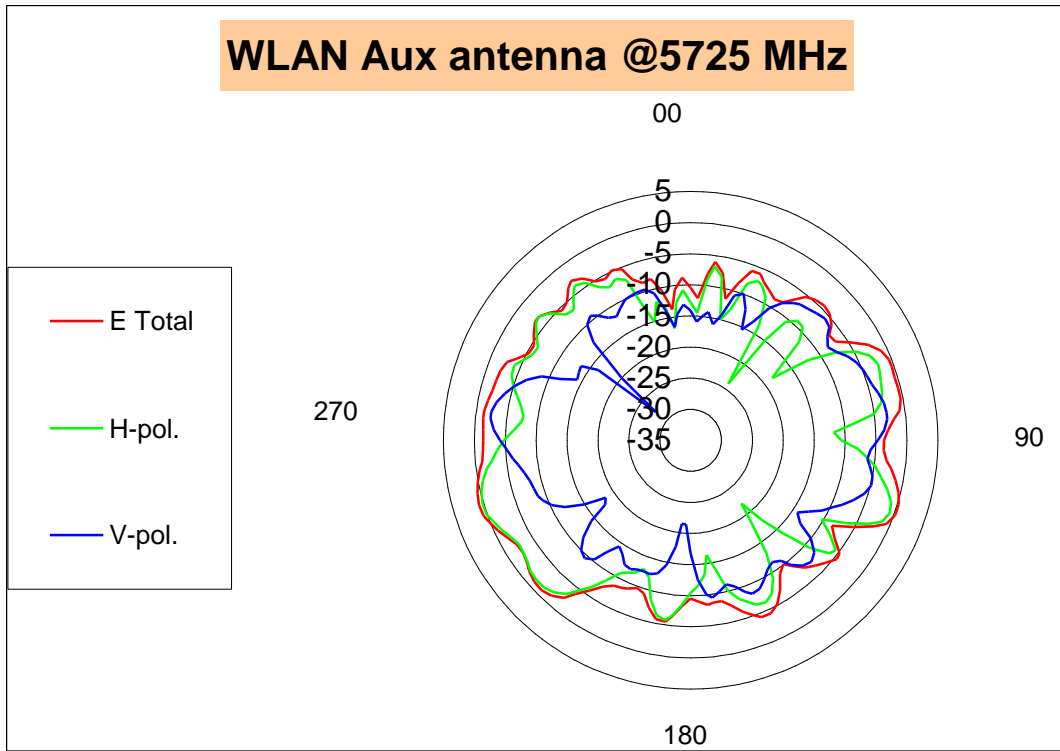

	H-pol	V pol
Peak Gain	0.20	-2.47

WLAN AUX antenna: 5785 MHz

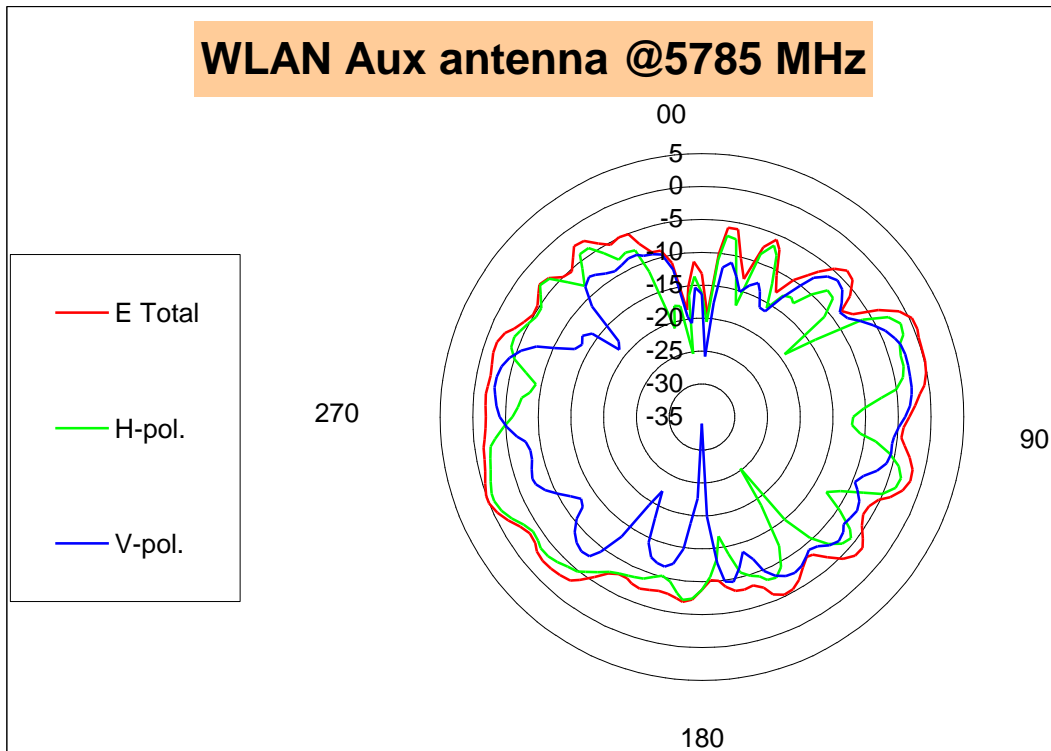

	H-pol	V pol
Peak Gain	-0.78	-2.49

WLAN AUX antenna: 5850 MHz

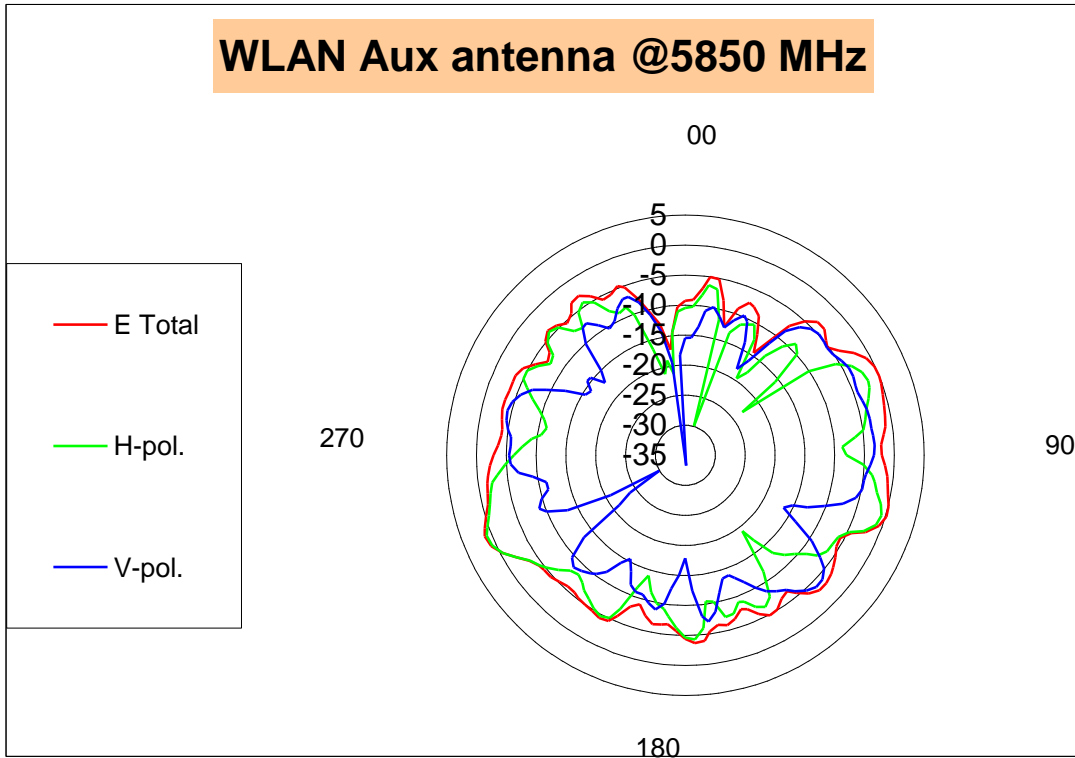

	H-pol	V pol
Peak Gain	0.84	-3.21

Section 4. Host Platform Information

OEM / ODM Host platform: (XXXXXXX) platform correlated to antenna data

Rating Label Photo:

Section 5. Antenna Host Platform Location Information

Include a **dimensioned photo or dimensioned drawing** of Main and AUX antenna placements. (Not applicable for receive-only antenna)

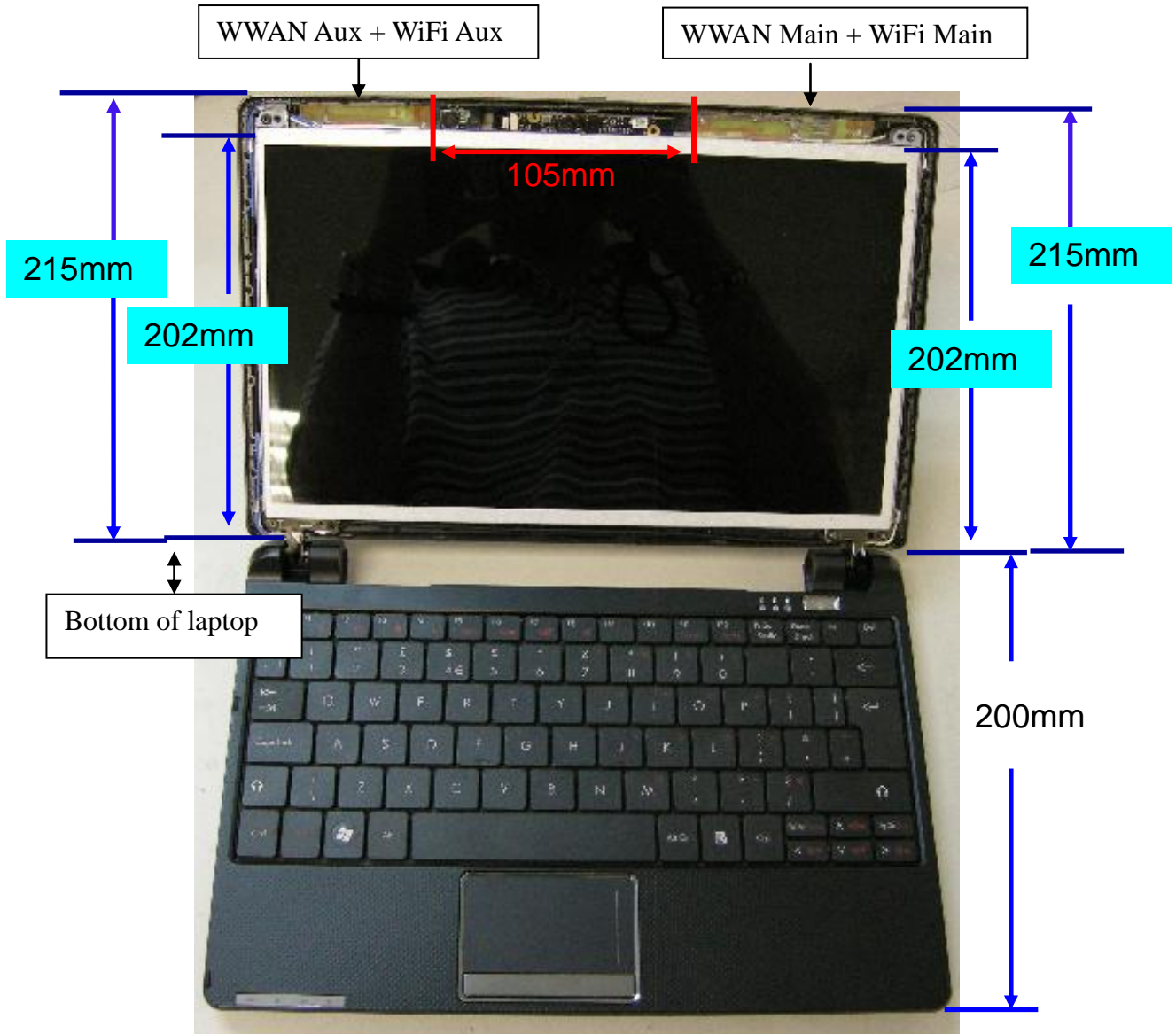

Section 6. Antenna dimensional information for SAR evaluation

Include a **dimensioned photo or dimensioned drawing** showing the distance (mm) between the transmit antennas and the user (excluding hands, wrist, feet, lap/ thigh, and ankle)

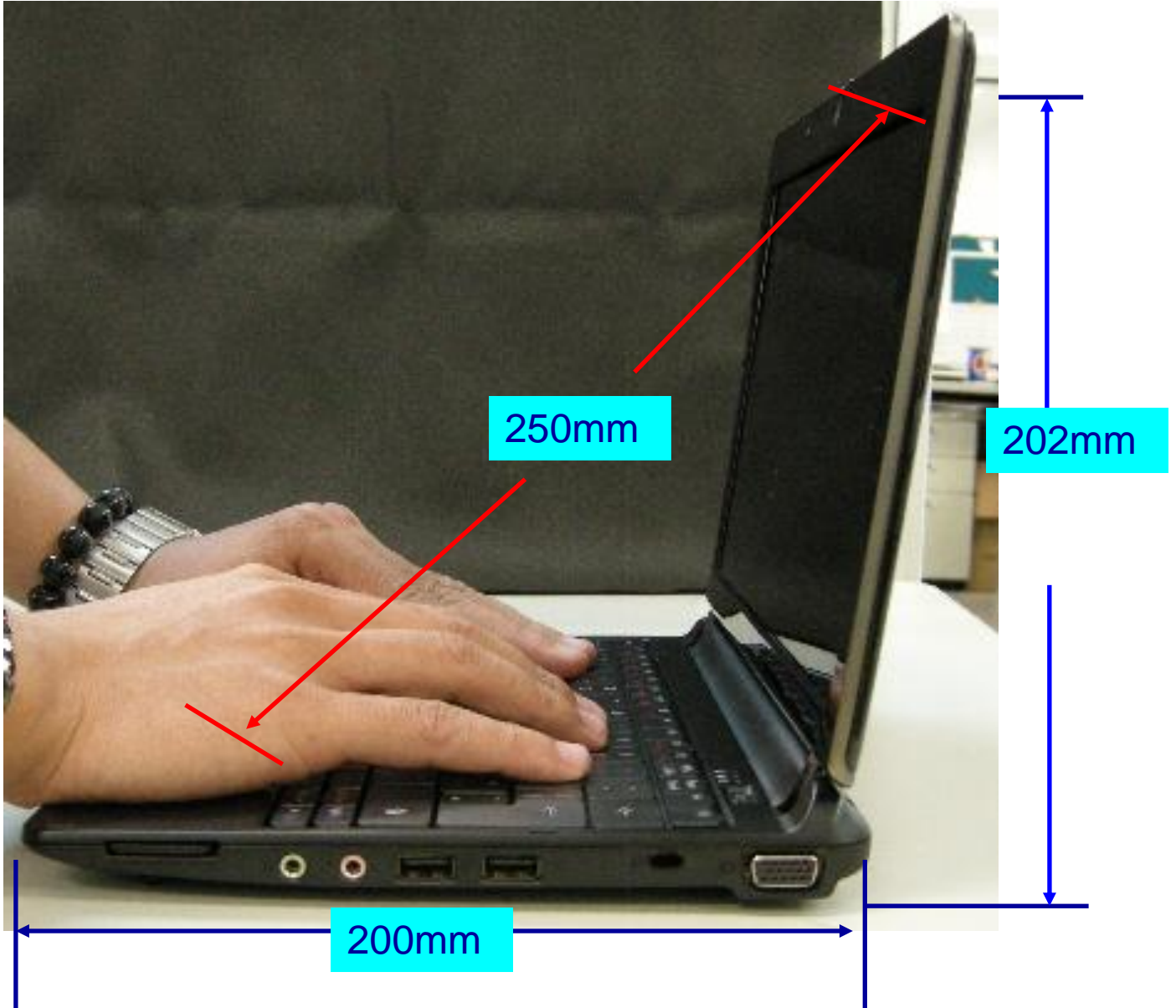

Section 7. Diagram Example of Co-Location Antenna Separation

Include a **dimensioned photo or dimensioned drawing** showing the distance (mm) between **all WWAN transmit antennas** and other co-located radiator transmit antenna such as Bluetooth, WWAN,..

(Note: Due to the evolving rules regarding co-location, each platform will need to be reviewed on a case by case basis)

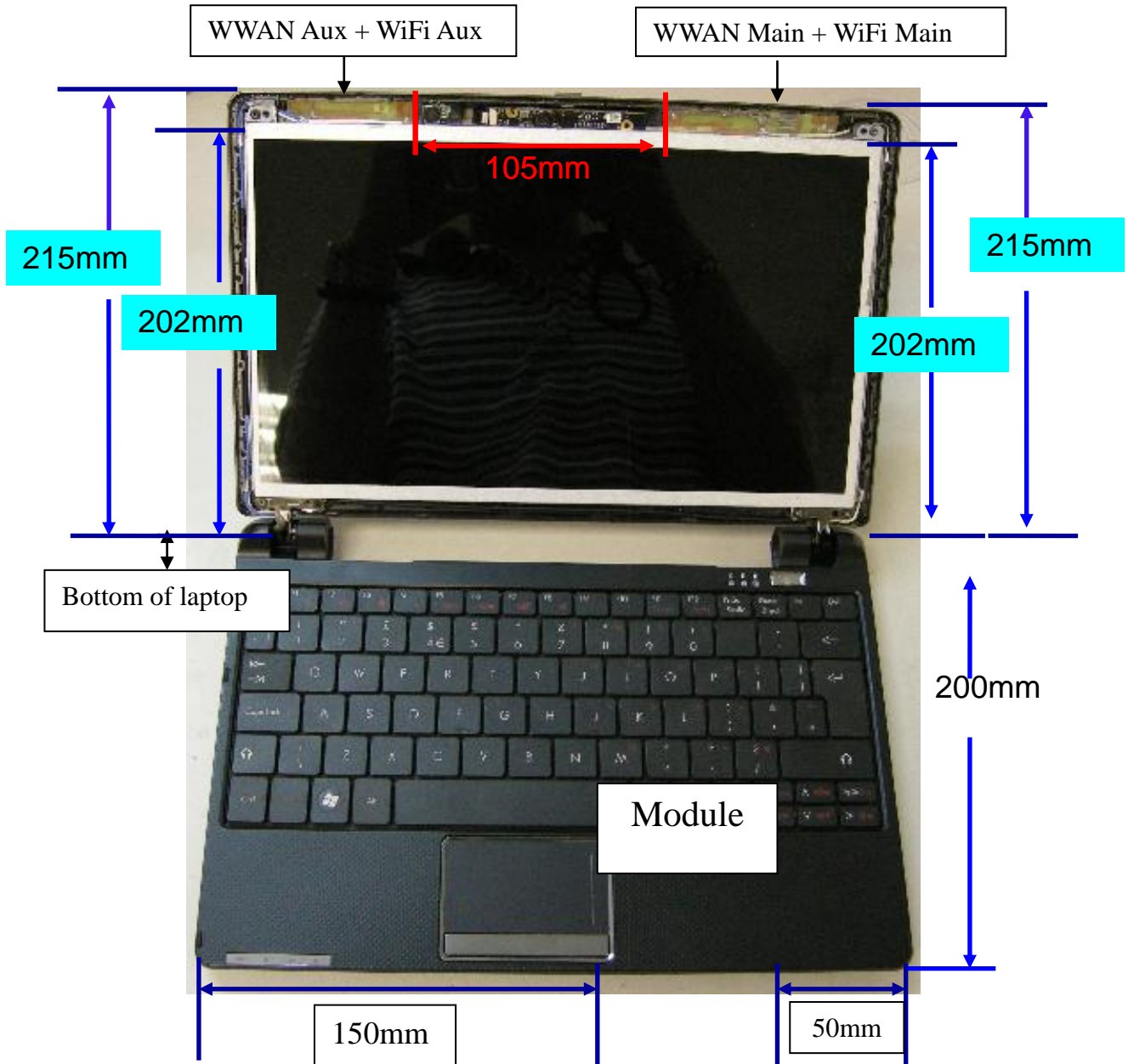

Section 8. Local representative contact information

Local representative contact information is required for regulatory support for target countries below.

	Local company name	Contact name	Phone number	FAX Number	e-Mail Address	Notes
Argentina						
Brazil						
Indonesia						
Israel						
Malaysia						
Mexico						
Singapore						Telecommunication Equipment Dealer License Required
South Africa						
USA, Canada						