



FCC RF Test Report

APPLICANT : Acer Incorporated
EQUIPMENT : Smart HandHeld
BRAND NAME : Acer
MODEL NAME : T03
MARKETING NAME : Liquid Z630
FCC ID : HLZDMZ630
STANDARD : 47 CFR Part 2, 24(E), 27(M), 27(L), 27(H)
CLASSIFICATION : PCS Licensed Transmitter Held to Ear (PCE)

The product was received on Jun. 03, 2015 and completely tested on Jul. 11, 2015. We, SPORTON INTERNATIONAL (KUNSHAN) INC., would like to declare that the tested sample has been evaluated in accordance with the test procedures given in ANSI / TIA / EIA-603-C-2004 and the testing has shown the tested sample to be in compliance with the applicable technical standards.

The test results in this report apply exclusively to the tested model / sample. Without written approval of SPORTON INTERNATIONAL (KUNSHAN) INC., the test report shall not be reproduced except in full.

Reviewed by: Joseph Lin / Supervisor

Approved by: Jones Tsai / Manager



SPORTON INTERNATIONAL (KUNSHAN) INC.
No. 3-2, PingXiang Road, Kunshan, Jiangsu Province, P. R. China



TABLE OF CONTENTS

REVISION HISTORY.....3
SUMMARY OF TEST RESULT4
1 GENERAL DESCRIPTION6
1.1 Applicant.....6
1.2 Manufacturer.....6
1.3 Product Feature of Equipment Under Test.....6
1.4 Product Specification subjective to this standard7
1.5 Modification of EUT8
1.6 Emission Designator.....8
1.7 Testing Location10
1.8 Applicable Standards.....10
2 TEST CONFIGURATION OF EQUIPMENT UNDER TEST11
2.1 Test Mode.....11
2.2 Connection Diagram of Test System.....13
2.3 Support Unit used in test configuration and system14
2.4 Measurement Results Explanation Example.....14
3 CONDUCTED TEST ITEMS15
3.1 Measuring Instruments15
3.2 Test Setup15
3.3 Test Result of Conducted Test15
3.4 Conducted Output Power and ERP/EIRP16
3.5 Peak-to-Average Ratio17
3.6 Occupied Bandwidth.....18
3.7 Conducted Band Edge19
3.8 Conducted Spurious Emission21
3.9 Frequency Stability22
4 RADIATED TEST ITEMS23
4.1 Measuring Instruments23
4.2 Test Setup23
4.3 Test Result of Radiated Test23
4.4 Effective Radiated Power and Effective Isotropic Radiated Power24
4.5 Radiated Spurious Emission26
5 LIST OF MEASURING EQUIPMENT28
6 UNCERTAINTY OF EVALUATION29
APPENDIX A. TEST RESULTS OF CONDUCTED TEST
APPENDIX B. TEST RESULTS OF RADIATED TEST
APPENDIX C. TEST SETUP PHOTOGRAPHS



REVISION HISTORY

REPORT NO.	VERSION	DESCRIPTION	ISSUED DATE
FG560322B	Rev. 01	Initial issue of report	Aug. 18, 2015



SUMMARY OF TEST RESULT

Report Section	FCC Rule	Description	Limit	Result	Remark
3.4	§2.1046	Conducted Output Power	Reporting Only	PASS	-
3.5	§24.232(d)	Peak-to-Average Ratio	<13 dB	PASS	-
3.6	§2.1049	Occupied Bandwidth	Reporting Only	PASS	-
3.7	§2.1051 §24.238(a) §27.53(g) §27.53(h)	Conducted Band Edge Measurement (Band 2) (Band 4) (Band 12)	< 43+10log10(P[Watts])	PASS	-
	§2.1051 §27.53(m)(4)	Conducted Band Edge Measurement (Band 7)	Offset 0 ~ 5MHz: < 40+10log10(P[Watts]) Offset 5 ~ 6MHz or EBW: < 43+10log10(P[Watts])		



Report Section	FCC Rule	Description	Limit	Result	Remark
3.8	§2.1051 §24.238(a) §27.53(g) §27.53(h)	Conducted Spurious Emission (Band 2) (Band 4) (Band 12)	$< 43+10\log_{10}(P[\text{Watts}])$	PASS	-
	§2.1051 §27.53(m)(4)	Conducted Spurious Emission (Band 7)	$< 55+10\log_{10}(P[\text{Watts}])$		
3.9	§2.1055 §24.235 §27.54	Frequency Stability Temperature & Voltage	Within Authorized Band	PASS	-
4.4	§27.50(c)(10)	Effective Radiated Power (Band 12)	ERP < 3 Watt	PASS	-
	§24.232(c) §27.50(h)(2)	Equivalent Isotropic Radiated Power (Band 2) (Band 7)	EIRP < 2Watt		
	§27.50(d)(4)	Equivalent Isotropic Radiated Power (Band 4)	EIRP < 1Watt		
4.5	§2.1053 §24.238(a) §27.53(g) §27.53(h)	Radiated Spurious Emission (Band 2) (Band 4) (Band 12)	$< 43+10\log_{10}(P[\text{Watts}])$	PASS	Under limit 17.15 dB at 7592.000 MHz
	§2.1053 §27.53(m)(4)	Radiated Spurious Emission (Band 7)	$< 55+10\log_{10}(P[\text{Watts}])$		



1 General Description

1.1 Applicant

Acer Incorporated

8F., No. 88, Sec. 1, Xintai 5th Rd., Xizhi Dist., New Taipei City 22181, Taiwan (R.O.C)

1.2 Manufacturer

Shanghai Sunrise Simcom Limited

No. 888, Shengli Rd., Qingpu, Shanghai, P.R.China 201700

1.3 Product Feature of Equipment Under Test

Product Feature	
Equipment	Smart HandHeld
Brand Name	Acer
Model Name	T03
Marketing Name	Liquid Z630
FCC ID	HLZDMZ630
EUT supports Radios application	GSM/GPRS/EGPRS/WCDMA/HSPA/HSPA+/DC-HSDPA/LTE WLAN2.4GHz 802.11b/g/n HT20/HT40 Bluetooth v3.0+EDR Bluetooth v4.0 LE
IMEI Code	Conducted: 352784070000438/352784070001857 Radiation: 352784070000370/352784070001790 for LTE Band 2 / 4 / 12 352784070000388/352784070001808 for LTE Band 7 ERP/EIRP: 352784070000388/352784070001808
EUT Stage	Identical Prototype

Remark: The above EUT's information was declared by manufacturer. Please refer to the specifications or user's manual for more detailed description.



1.4 Product Specification subjective to this standard

Product Specification subjective to this standard	
Tx Frequency	LTE Band 2 : 1850.7 MHz ~ 1909.3 MHz LTE Band 4 : 1710.7 MHz ~ 1754.3 MHz LTE Band 7 : 2502.5 MHz ~ 2567.5 MHz LTE Band 12 : 699.7 MHz ~ 715.3 MHz
Rx Frequency	LTE Band 2 : 1930.7 MHz ~ 1989.3 MHz LTE Band 4 : 2110.7 MHz ~ 2154.3 MHz LTE Band 7 : 2622.5MHz ~ 2687.5 MHz LTE Band 12 : 729.7 MHz ~ 745.3 MHz
Bandwidth	LTE Band 2 : 1.4MHz / 3MHz / 5MHz / 10MHz / 15MHz / 20MHz LTE Band 4 : 1.4MHz / 3MHz / 5MHz / 10MHz / 15MHz / 20MHz LTE Band 7 : 5MHz/ 10MHz / 15MHz / 20MHz LTE Band 12 : 1.4MHz / 3MHz / 5MHz / 10MHz
Maximum Output Power to Antenna	LTE Band 2 : 22.71 dBm LTE Band 4 : 22.70 dBm LTE Band 7 : 22.68 dBm LTE Band 12 : 22.87 dBm
Type of Modulation	QPSK / 16QAM / 64QAM(Downlink only)



1.5 Modification of EUT

No modifications are made to the EUT during all test items.

1.6 Emission Designator

LTE Band 2		QPSK			16QAM		
BW(MHz)	Emission Designator (99%OBW)	Frequency Tolerance (ppm)	Maximum EIRP(W)	Emission Designator (99%OBW)	Frequency Tolerance (ppm)	Maximum EIRP(W)	
1.4	1M10G7D	-	0.2799	1M10W7D	-	0.2529	
3	2M73G7D	-	0.2838	2M72W7D	-	0.2547	
5	4M52G7D	-	0.2884	4M51W7D	-	0.2377	
10	9M07G7D	0.0282	0.2793	9M03W7D	-	0.2523	
15	13M5G7D	-	0.2931	13M5W7D	-	0.2924	
20	18M4G7D	-	0.3304	18M5W7D	-	0.3055	
LTE Band 4		QPSK			16QAM		
BW(MHz)	Emission Designator (99%OBW)	Frequency Tolerance (ppm)	Maximum EIRP(W)	Emission Designator (99%OBW)	Frequency Tolerance (ppm)	Maximum EIRP(W)	
1.4	1M10G7D	-	0.2410	1M10W7D	-	0.1950	
3	2M74G7D	-	0.2291	2M72W7D	-	0.1986	
5	4M52G7D	-	0.2183	4M51W7D	-	0.1791	
10	9M13G7D	0.0061	0.2163	9M05W7D	-	0.1563	
15	13M6G7D	-	0.1603	13M5W7D	-	0.1236	
20	18M6G7D	-	0.1679	18M6W7D	-	0.1507	



LTE Band 7		QPSK			16QAM		
BW(MHz)	Emission Designator (99%OBW)	Frequency Tolerance (ppm)	Maximum EIRP(W)	Emission Designator (99%OBW)	Frequency Tolerance (ppm)	Maximum EIRP(W)	
5	4M52G7D	-	0.1995	4M51W7D	-	0.1841	
10	9M11G7D	0.0241	0.2037	9M03W7D	-	0.1762	
15	13M6G7D	-	0.1950	13M5W7D	-	0.1694	
20	18M5G7D	-	0.1754	18M5W7D	-	0.1524	
LTE Band 12		QPSK			16QAM		
BW(MHz)	Emission Designator (99%OBW)	Frequency Tolerance (ppm)	Maximum ERP(W)	Emission Designator (99%OBW)	Frequency Tolerance (ppm)	Maximum ERP(W)	
1.4	1M10G7D	-	0.0570	1M10W7D	-	0.0516	
3	2M72G7D	-	0.0555	2M73W7D	-	0.0492	
5	4M52G7D	-	0.0483	4M51W7D	-	0.0459	
10	9M13G7D	0.0170	0.0577	9M07W7D	-	0.0509	



1.7 Testing Location

Test Site	SPORTON INTERNATIONAL (KUNSHAN) INC.		
Test Site Location	No. 3-2, PingXiang Road, Kunshan, Jiangsu Province, P. R. China TEL: +86-0512-5790-0158 FAX: +86-0512-5790-0958		
Test Site No.	Sporton Site No.		FCC Registration No.
	TH01-KS	03CH02-KS	418269

1.8 Applicable Standards

According to the specifications of the manufacturer, the EUT must comply with the requirements of the following standards:

- ♦ 47 CFR Part 2, 24(E), 27(L), 27(M), 27(H)
- ♦ ANSI / TIA / EIA-603-C-2004
- ♦ FCC KDB 971168 D01 Power Meas. License Digital Systems v02r02

Remark:

1. All test items were verified and recorded according to the standards and without any deviation during the test.
2. This EUT has also been tested and complied with the requirements of FCC Part 15, Subpart B, recorded in a separate test report.



2 Test Configuration of Equipment Under Test

2.1 Test Mode

Antenna port conducted and radiated test items listed below are performed according to KDB 971168 D01 Power Meas. License Digital Systems v02r02 with maximum output power.

Radiated measurements are performed by rotating the EUT in three different orthogonal test planes to find the maximum emission.

Test Items	Band	Bandwidth (MHz)						Modulation		RB #			Test Channel		
		1.4	3	5	10	15	20	QPSK	16QAM	1	Half	Full	L	M	H
Max. Output Power	2	Y	Y	Y	Y	Y	Y	Y	Y	Y	Y	Y	Y	Y	Y
	4	Y	Y	Y	Y	Y	Y	Y	Y	Y	Y	Y	Y	Y	Y
	7	-	-	Y	Y	Y	Y	Y	Y	Y	Y	Y	Y	Y	Y
	12	Y	Y	Y	Y	-	-	Y	Y	Y	Y	Y	Y	Y	Y
Peak-to-Average Ratio	2						Y	Y	Y	Y		Y	Y	Y	Y
	4						Y	Y	Y	Y		Y	Y	Y	Y
	7	-	-				Y	Y	Y	Y		Y	Y	Y	Y
	12				Y	-	-	Y	Y	Y		Y	Y	Y	Y
26dB and 99% Bandwidth	2	Y	Y	Y	Y	Y	Y	Y	Y			Y	Y	Y	Y
	4	Y	Y	Y	Y	Y	Y	Y	Y			Y	Y	Y	Y
	7	-	-	Y	Y	Y	Y	Y	Y			Y	Y	Y	Y
	12	Y	Y	Y	Y	-	-	Y	Y			Y	Y	Y	Y
Conducted Band Edge	2	Y	Y	Y	Y	Y	Y	Y	Y	Y		Y	Y		Y
	4	Y	Y	Y	Y	Y	Y	Y	Y	Y		Y	Y		Y
	7	-	-	Y	Y	Y	Y	Y	Y	Y		Y	Y		Y
	12	Y	Y	Y	Y	-	-	Y	Y	Y		Y	Y		Y



Test Items	Band	Bandwidth (MHz)						Modulation		RB #			Test Channel		
		1.4	3	5	10	15	20	QPSK	16QAM	1	Half	Full	L	M	H
Conducted Spurious Emission	2	√	√	√	√	√	√	√	√	√	√		√	√	√
	4	√	√	√	√	√	√	√	√	√	√		√	√	√
	7	-	-	√	√	√	√	√	√	√	√		√	√	√
	12	√	√	√	√	-	-	√	√	√	√		√	√	√
Frequency Stability	2				√			√				√		√	
	4				√			√				√		√	
	7	-	-		√			√				√		√	
	12				√	-	-	√				√		√	
E.R.P/ E.I.R.P.	2	√	√	√	√	√	√	√	√	√	√		√	√	√
	4	√	√	√	√	√	√	√	√	√	√		√	√	√
	7	-	-	√	√	√	√	√	√	√	√		√	√	√
	12	√	√	√	√	-	-	√	√	√	√		√	√	√
Radiated Spurious Emission	2	√	√	√	√	√	√	√		√			√	√	√
	4	√	√	√	√	√	√	√		√			√	√	√
	7	-	-	√	√	√	√	√		√			√	√	√
	12	√	√	√	√	-	-	√		√			√	√	√
Note	<p>1. The mark “√” means that this configuration is chosen for testing</p> <p>2. The mark “-” means that this bandwidth is not supported.</p> <p>3. The device is investigated from 30MHz to 10 times of fundamental signal for radiated spurious emission test under different RB size/offset and modulations in exploratory test. Subsequently, only the worst case emissions are reported.</p>														

2.2 Connection Diagram of Test System

For Band 2 / 4 / 7

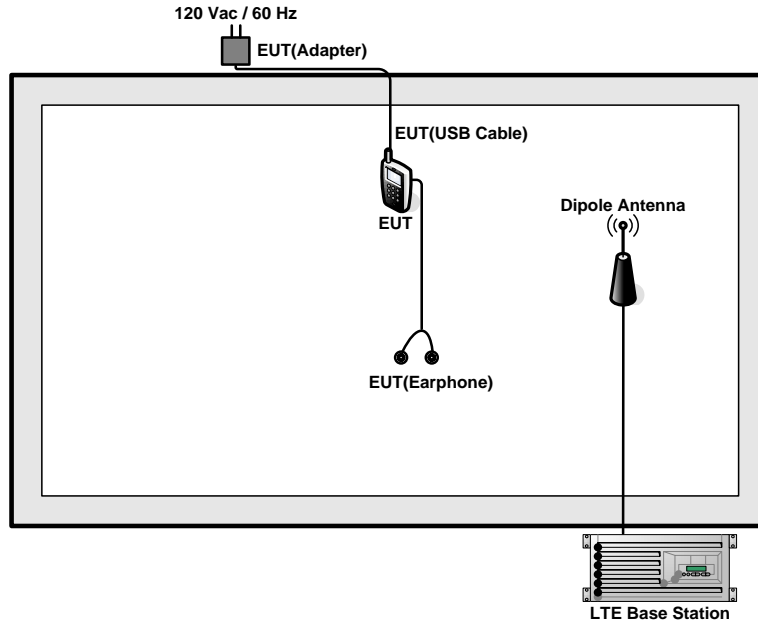

For Band 12

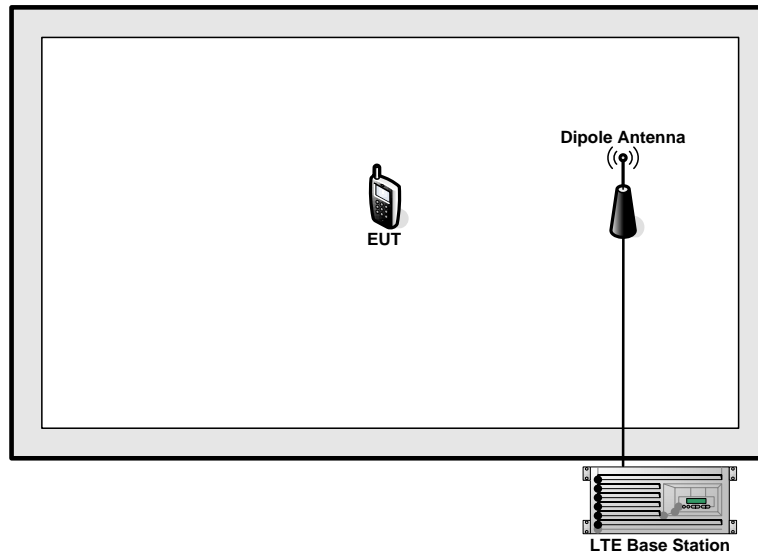



2.3 Support Unit used in test configuration and system

Item	Equipment	Trade Name	Model No.	FCC ID	Data Cable	Power Cord
1.	LTE Base Station	Anritsu	MT8820C	N/A	N/A	Unshielded, 1.8 m
2.	DC Power Supply	GW INSTRON	GPD-2303S	N/A	N/A	Unshielded, 1.8 m

2.4 Measurement Results Explanation Example

For all conducted test items:

The offset level is set in the spectrum analyzer to compensate the RF cable loss between EUT conducted output port and spectrum analyzer. With the offset compensation, the spectrum analyzer reading level is exactly the EUT RF output level.

The spectrum analyzer offset is derived from RF cable loss.

Offset = RF cable loss.

Following shows an offset computation example with cable loss 5.5 dB.

Example :

$$\begin{aligned} \text{Offset(dB)} &= \text{RF cable loss(dB)}. \\ &= 5.5 \text{ (dB)} \end{aligned}$$

3 Conducted Test Items

3.1 Measuring Instruments

See list of measuring instruments of this test report.

3.2 Test Setup

3.2.1 Conducted Output Power



3.2.2 Peak-to-Average Ratio, Occupied Bandwidth ,Conducted Band-Edge and Conducted Spurious Emission

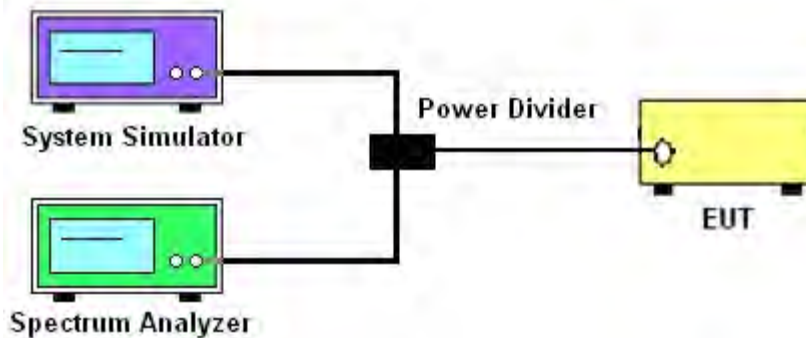

3.2.3 Frequency Stability

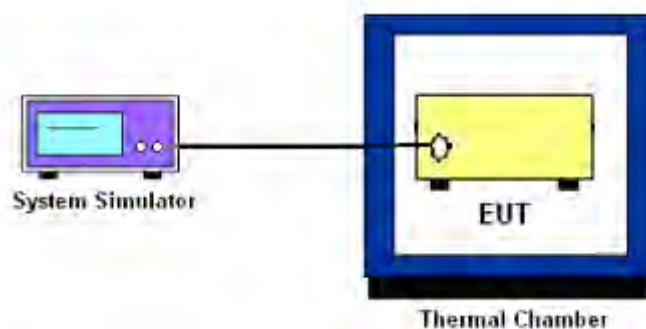

3.3 Test Result of Conducted Test

Please refer to Appendix A.



3.4 Conducted Output Power

3.4.1 Description of the Conducted Output Power Measurement

A system simulator was used to establish communication with the EUT. Its parameters were set to force the EUT transmitting at maximum output power. The measured power in the radio frequency on the transmitter output terminals shall be reported.

3.4.2 Test Procedures

1. The transmitter output port was connected to the system simulator.
2. Set EUT at maximum power through the system simulator.
3. Select lowest, middle, and highest channels for each band and different modulation.
4. Measure and record the power level from the system simulator.



3.5 Peak-to-Average Ratio

3.5.1 Description of the PAR Measurement

Power Complementary Cumulative Distribution Function (CCDF) curves provide a means for characterizing the power peaks of a digitally modulated signal on a statistical basis. A CCDF curve depicts the probability of the peak signal amplitude exceeding the average power level. Most contemporary measurement instrumentation include the capability to produce CCDF curves for an input signal provided that the instrument's resolution bandwidth can be set wide enough to accommodate the entire input signal bandwidth. In measuring transmissions in this band using an average power technique, the peak-to-average ratio (PAR) of the transmission may not exceed 13 dB.

3.5.2 Test Procedures

1. The testing follows FCC KDB 971168 v02r02 Section 5.7.1.
2. The EUT was connected to spectrum and system simulator via a power divider.
3. Set the CCDF (Complementary Cumulative Distribution Function) option in spectrum analyzer.
4. The highest RF powers were measured and recorded the maximum PAPR level associated with a probability of 0.1 %.
5. Record the deviation as Peak to Average Ratio.



3.6 Occupied Bandwidth

3.6.1 Description of Occupied Bandwidth Measurement

The occupied bandwidth is the width of a frequency band such that, below the lower and above the upper frequency limits, the mean powers emitted are each equal to a specified percentage 0.5% of the total mean transmitted power.

The 26 dB emission bandwidth is defined as the frequency range between two points, one above and one below the carrier frequency, at which the spectral density of the emission is attenuated 26 dB below the maximum in-band spectral density of the modulated signal. Spectral density (power per unit bandwidth) is to be measured with a detector of resolution bandwidth equal to approximately 1.0% of the emission bandwidth.

3.6.2 Test Procedures

1. The testing follows FCC KDB 971168 v02r02 Section 4.2.
2. The EUT was connected to spectrum analyzer and system simulator via a power divider.



3.7 Conducted Band Edge

3.7.1 Description of Conducted Band Edge Measurement

24.238 (a) for Band 2

For operations in the 1850-1910 and 1930-1990 MHz band, the FCC limit is $43 + 10\log_{10}(P[\text{Watts}])$ dB below the transmitter power $P(\text{Watts})$ in a 1MHz bandwidth. However, in the 1 MHz bands immediately outside and adjacent to the frequency block a resolution bandwidth of at least one percent of the emission bandwidth of the fundamental emission of the transmitter may be employed.

27.53 (g) for Band 12

For operations in the 698 -746 MHz band, the FCC limit is $43 + 10\log_{10}(P[\text{Watts}])$ dB below the transmitter power $P(\text{Watts})$ in a 100 kHz bandwidth. However, in the 100 kilohertz bands immediately outside and adjacent to a licensee's frequency block, a resolution bandwidth of at least 30 kHz may be employed.

27.53 (h) for Band 4

For operations in the 1710 – 1755 MHz band, the FCC limit is $43 + 10\log_{10}(P[\text{Watts}])$ dB below the transmitter power $P(\text{Watts})$ in a 1 MHz bandwidth. However, in the 1MHz bands immediately outside and adjacent to the licensee's frequency block, a resolution bandwidth of at least one percent of the emission bandwidth of the fundamental emission of the transmitter may be employed.

27.53(m)(4) for Band 7:

For mobile digital stations, the attenuation factor shall be not less than $40 + 10 \log (P)$ dB on all frequencies between the channel edge and 5 megahertz from the channel edge, $43 + 10 \log (P)$ dB on all frequencies between 5 megahertz and X megahertz from the channel edge, and $55 + 10 \log (P)$ dB on all frequencies more than X megahertz from the channel edge, where X is the greater of 6 megahertz or the actual emission bandwidth as defined in paragraph (m)(6) of this section. In addition, the attenuation factor shall not be less that $43 + 10 \log (P)$ dB on all frequencies between 2490.5 MHz and 2496 MHz and $55 + 10 \log (P)$ dB at or below 2490.5 MHz. Mobile Satellite Service licensees operating on frequencies below 2495 MHz may also submit a documented interference complaint against BRS licensees operating on channel BRS Channel 1 on the same terms and conditions as adjacent channel BRS or EBS licensees.



3.7.2 Test Procedures

1. The testing follows FCC KDB 971168 v02r02 Section 6.0.
2. The EUT was connected to spectrum analyzer and system simulator via a power divider.
3. The band edges of low and high channels for the highest RF powers were measured. Set RBW \geq 1% EBW in the 1MHz band immediately outside and adjacent to the band edge.
4. Set spectrum analyzer with RMS detector.
5. The RF fundamental frequency should be excluded against the limit line in the operating frequency band.
6. The limit line is derived from $43 + 10\log(P)$ dB below the transmitter power P(Watts)
 $= P(W) - [43 + 10\log(P)]$ (dB)
 $= [30 + 10\log(P)]$ (dBm) - $[43 + 10\log(P)]$ (dB)
 $= -13$ dBm.
For LTE Band 7:
 7. The limit line is derived from $40 + 10\log(P)$ dB below the transmitter power P(Watts)
 $= P(W) - [40 + 10\log(P)]$ (dB)
 $= [30 + 10\log(P)]$ (dBm) - $[40 + 10\log(P)]$ (dB)
 $= -10$ dBm
 8. The limit line is derived from $43 + 10\log(P)$ dB below the transmitter power P(Watts)
 $= P(W) - [43 + 10\log(P)]$ (dB)
 $= [30 + 10\log(P)]$ (dBm) - $[43 + 10\log(P)]$ (dB)
 $= -13$ dBm.
 9. The limit line is derived from $55 + 10\log(P)$ dB below the transmitter power P(Watts)
 $= P(W) - [55 + 10\log(P)]$ (dB)
 $= [55 + 10\log(P)]$ (dBm) - $[55 + 10\log(P)]$ (dB)
 $= -25$ dBm



3.8 Conducted Spurious Emission

3.8.1 Description of Conducted Spurious Emission Measurement

The power of any emission outside of the authorized operating frequency ranges must be lower than the transmitter power (P) by a factor of at least $43 + 10 \log (P)$ dB.

For Band 7:

The power of any emission outside of the authorized operating frequency ranges must be lower than the transmitter power (P) by a factor of at least $55 + 10 \log (P)$ dB.

It is measured by means of a calibrated spectrum analyzer and scanned from 30 MHz up to a frequency including its 10th harmonic.

3.8.2 Test Procedures

1. The testing follows FCC KDB 971168 v02r02 Section 6.0.
2. The EUT was connected to spectrum analyzer and system simulator via a power divider.
3. The RF output of EUT was connected to the spectrum analyzer by RF cable and attenuator. The path loss was compensated to the results for each measurement.
4. The middle channel for the highest RF power within the transmitting frequency was measured.
5. The conducted spurious emission for the whole frequency range was taken.
6. Make the measurement with the spectrum analyzer's RBW = 1MHz, VBW = 3MHz.
7. Set spectrum analyzer with RMS detector.
8. Taking the record of maximum spurious emission.
9. The RF fundamental frequency should be excluded against the limit line in the operating frequency band.
10. The limit line is derived from $43 + 10\log(P)$ dB below the transmitter power P(Watts)
= $P(W) - [43 + 10\log(P)]$ (dB)
= $[30 + 10\log(P)]$ (dBm) - $[43 + 10\log(P)]$ (dB)
= -13dBm.
11. For Band 7
The limit line is derived from $55 + 10\log(P)$ dB below the transmitter power P(Watts)



3.9 Frequency Stability

3.9.1 Description of Frequency Stability Measurement

The frequency stability shall be measured by variation of ambient temperature and variation of primary supply voltage to ensure that the fundamental emission stays within the authorized frequency block. The frequency stability of the transmitter shall be maintained within $\pm 0.00025\%$ ($\pm 2.5\text{ppm}$) of the center frequency.

3.9.2 Test Procedures for Temperature Variation

1. The EUT was set up in the thermal chamber and connected with the system simulator.
2. With power OFF, the temperature was decreased to -30°C and the EUT was stabilized before testing. Power was applied and the maximum change in frequency was recorded within one minute.
3. With power OFF, the temperature was raised in 10°C step up to 50°C . The EUT was stabilized at each step for at least half an hour. Power was applied and the maximum frequency change was recorded within one minute.

3.9.3 Test Procedures for Voltage Variation

1. The testing follows FCC KDB 971168 v02r02 Section 9.0.
2. The EUT was placed in a temperature chamber at $25\pm 5^{\circ}\text{C}$ and connected with the system simulator.
3. The power supply voltage to the EUT was varied from 85% to 115% of the nominal value measured at the input to the EUT.
4. The variation in frequency was measured for the worst case.

4 Radiated Test Items

4.1 Measuring Instruments

See list of measuring instruments of this test report.

4.2 Test Setup

4.2.1 For radiated test from 30MHz to 1GHz

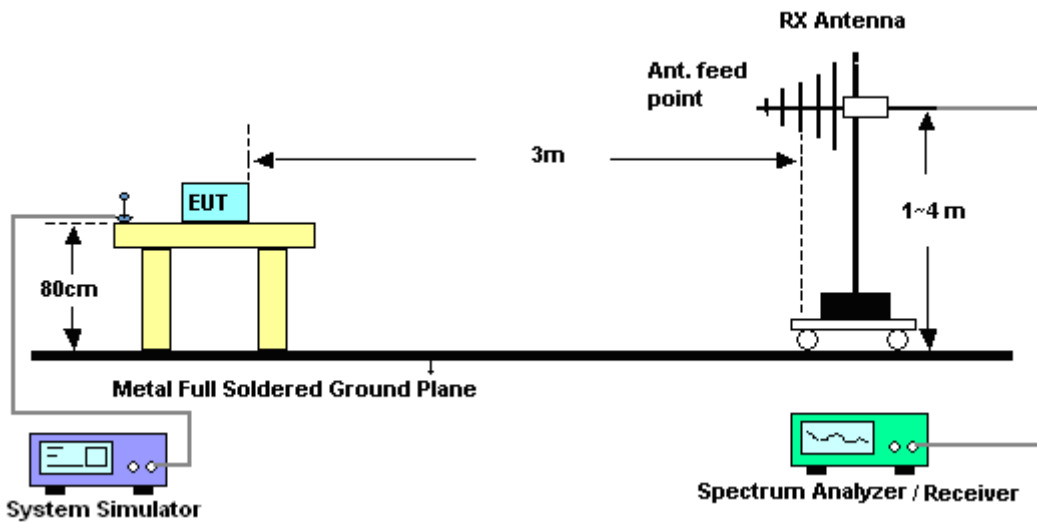

4.2.2 For radiated test above 1GHz

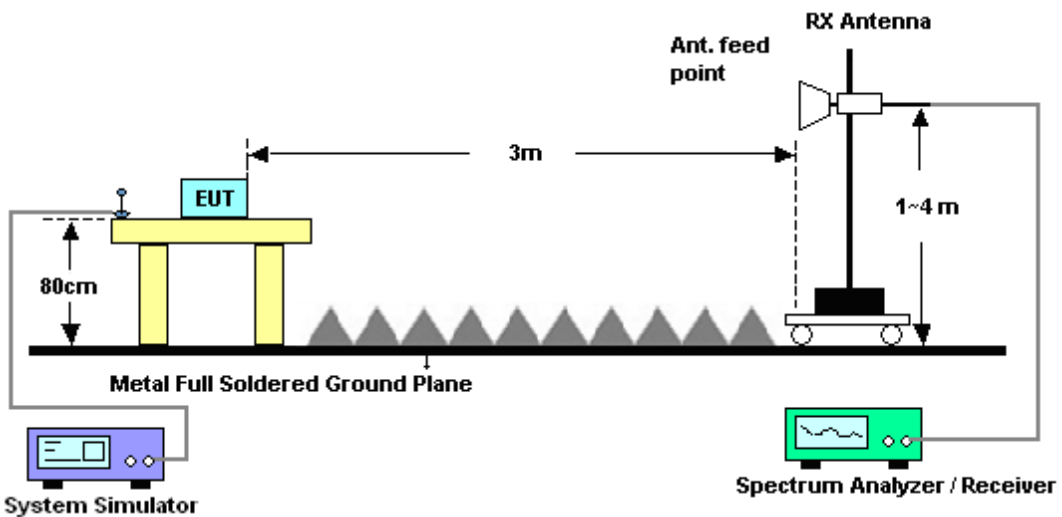

4.3 Test Result of Radiated Test

Please refer to Appendix B.



4.4 Effective Radiated Power and Effective Isotropic Radiated Power

4.4.1 Description of the ERP/EIRP Measurement

Effective radiated power output measurements by substitution method according to ANSI / TIA / EIA-603-C-2004, and the spectrum analyzer configuration follows KDB 971168 D01 Power Meas. License Digital Systems v02r02. Mobile and portable (hand-held) stations operating are limited to average ERP of 3 watts with LTE band 12.

Equivalent isotropic radiated power output measurements by substitution method according to ANSI / TIA / EIA-603-C-2004, and the spectrum analyzer configuration follows KDB 971168 D01 Power Meas. License Digital Systems v02r02. Mobile and portable (hand-held) stations operating are limited to average EIRP of 2 watts with LTE band 2 / 7 and 1 watt with LTE band 4.

4.4.2 Test Procedures

1. The EUT was placed on a non-conductive rotating platform 0.8 meters high in a semi-anechoic chamber. The radiated emission at the fundamental frequency was measured at 3 m with a test antenna and a spectrum analyzer with RMS detector per section 5. of KDB 971168 D01.
2. During the measurement, the system simulator parameters were set to force the EUT transmitting at maximum output power. The maximum emission was recorded from analyzer power level (LVL) from the 360 degrees rotation of the turntable and the test antenna raised and lowered over a range from 1 to 4 meters in both horizontally and vertically polarized orientations.
3. Effective Isotropic Radiated Power (EIRP) was measured by substitution method according to TIA/EIA-603-C. The EUT was replaced by the substitution antenna at same location, and then a known power from S.G. was applied into the dipole antenna through a Tx cable, and then recorded the maximum Analyzer reading through raised and lowered the test antenna. The correction factor (in dB) = S.G. - Tx Cable loss + Substitution antenna gain - Analyzer reading. Then the EUT's EIRP was calculated with the correction factor, $EIRP = LVL + \text{Correction factor}$ and $ERP = EIRP - 2.15$. Take the record of the output power at substitution antenna.



	LTE Average					
LTE BW	1.4M	3M	5M	10M	15M	20M
Span	3MHz	6MHz	10MHz	20MHz	30MHz	40MHz
RBW	30kHz	100kHz	100kHz	300kHz	300kHz	300kHz
VBW	100kHz	300kHz	300kHz	1MHz	1MHz	1MHz
Detector	RMS	RMS	RMS	RMS	RMS	RMS
Trace	Average	Average	Average	Average	Average	Average
Average Type	Power	Power	Power	Power	Power	Power
Sweep Count	100	100	100	100	100	100



4.5 Radiated Spurious Emission

4.5.1 Description of Radiated Spurious Emission

The radiated spurious emission was measured by substitution method according to ANSI / TIA / EIA-603-C-2004. The power of any emission outside of the authorized operating frequency ranges must be attenuated below the transmitter power (P) by a factor of at least $43 + 10 \log (P)$ dB.

For Band 7

The power of any emission outside of the authorized operating frequency ranges must be attenuated below the transmitter power (P) by a factor of at least $55 + 10 \log (P)$ dB.

For LTE Band 12

For operations in the 746-758 MHz, 775-788 MHz, and 805-806 MHz bands, emissions in the band 1559-1610 MHz shall be limited to -70 dBW/MHz equivalent isotropically radiated power (EIRP) for wideband signals, and -80 dBW EIRP for discrete emissions of less than 700 Hz bandwidth.

The spectrum is scanned from 30 MHz up to a frequency including its 10th harmonic.



4.5.2 Test Procedures

1. The testing follows FCC KDB 971168 v02r02 Section 5.8 and ANSI / TIA-603-C-2004 Section 2.2.12.
2. The EUT was placed on a rotatable wooden table with 0.8 meter above ground.
3. The EUT was set 3 meters from the receiving antenna, which was mounted on the antenna tower.
4. The table was rotated 360 degrees to determine the position of the highest spurious emission.
5. The height of the receiving antenna is varied between one meter and four meters to search the maximum spurious emission for both horizontal and vertical polarizations.
6. Make the measurement with the spectrum analyzer's RBW = 1MHz, VBW = 3MHz, taking the record of maximum spurious emission.
7. A horn antenna was substituted in place of the EUT and was driven by a signal generator.
8. Tune the output power of signal generator to the same emission level with EUT maximum spurious emission.
9. Taking the record of output power at antenna port.
10. Repeat step 7 to step 8 for another polarization.
11. The RF fundamental frequency should be excluded against the limit line in the operating frequency band.

The limit line is derived from $43 + 10\log(P)$ dB below the transmitter power P(Watts)
= $P(W) - [43 + 10\log(P)]$ (dB)
= $[30 + 10\log(P)]$ (dBm) - $[43 + 10\log(P)]$ (dB)
= -13dBm.

For Band 7:

The limit line is derived from $55 + 10\log(P)$ dB below the transmitter power P(Watts)

12. EIRP (dBm) = S.G. Power – Tx Cable Loss + Tx Antenna Gain
13. ERP (dBm) = EIRP - 2.15



5 List of Measuring Equipment

Instrument	Manufacturer	Model No.	Serial No.	Characteristics	Calibration Date	Test Date	Due Date	Remark
Spectrum Analyzer	R&S	FSV30	101338	9kHz~30GHz	May 04, 2015	Jul. 06, 2015~ Jul. 07, 2015	May 03, 2016	Conducted (TH01-KS)
Thermal Chamber	Ten Billion	TTC-B3S	TBN-960502	-40~+150°C	Oct. 25, 2014	Jul. 06, 2015~ Jul. 07, 2015	Oct. 24, 2015	Conducted (TH01-KS)
EMI Test Receiver	R&S	ESR7	101403	9kHz~7GHz; Max 30dBm	Sep. 29, 2014	Jul. 08, 2015~ Jul. 11, 2015	Sep. 28, 2015	Radiation (03CH02-KS)
Spectrum Analyzer	R&S	FSV40	101040	10kHz~40GHz;Ma x 30dBm	Sep. 25, 2014	Jul. 08, 2015~ Jul. 11, 2015	Sep. 24, 2015	Radiation (03CH02-KS)
Bilog Antenna	TeseQ	CBL6112D	37879	30MHz~2GHz	Sep. 13, 2014	Jul. 08, 2015~ Jul. 11, 2015	Sep. 12, 2015	Radiation (03CH02-KS)
Double Ridge Horn Antenna	ETS-Lindgren	3117	75957	1GHz~18GHz	Nov. 08, 2014	Jul. 08, 2015~ Jul. 11, 2015	Nov. 07, 2015	Radiation (03CH02-KS)
Active Horn Antenna	com-power	AHA-118	701030	1GHz~18GHz	Nov. 08, 2014	Jul. 08, 2015~ Jul. 11, 2015	Nov. 07, 2015	Radiation (03CH02-KS)
SHF-EHF Horn	com-power	AH-840	101070	18GHz~40GHz	Sep. 04, 2014	Jul. 08, 2015~ Jul. 11, 2015	Sep. 03, 2015	Radiation (03CH02-KS)
Amplifier	com-power	PA-103A	161069	1kHz~1000MHz / 32 dB	May 04, 2015	Jul. 08, 2015~ Jul. 11, 2015	May 03, 2016	Radiation (03CH02-KS)
Amplifier	Agilent	8449B	3008A02384	1GHz~26.5GHz Gain 30dB	Oct. 28, 2014	Jul. 08, 2015~ Jul. 11, 2015	Oct. 27, 2015	Radiation (03CH02-KS)
AC Power Source	Chroma	61601	616010002473	N/A	NCR	Jul. 08, 2015~ Jul. 11, 2015	NCR	Radiation (03CH02-KS)
Turn Table	MF	MF7802	N/A	0~360 degree	NCR	Jul. 08, 2015~ Jul. 11, 2015	NCR	Radiation (03CH02-KS)
Antenna Mast	MF	MF7802	N/A	1 m~4 m	NCR	Jul. 08, 2015~ Jul. 11, 2015	NCR	Radiation (03CH02-KS)



6 Uncertainty of Evaluation

Uncertainty of Radiated Emission Measurement (30 MHz ~ 1000 MHz)

Measuring Uncertainty for a Level of Confidence of 95% ($U = 2Uc(y)$)	5.1 dB
---	--------



Appendix A. Test Results of Conducted Test

Conducted Output Power(Average power)

LTE Band 2 Maximum Average Power [dBm]						
BW [MHz]	RB Size	RB Offset	Mod	Lowest	Middle	Highest
1.4	1	0	QPSK	21.90	22.23	22.64
1.4	1	2		21.98	22.31	22.60
1.4	1	5		21.89	22.23	22.53
1.4	3	0		21.99	22.33	22.61
1.4	3	1		21.95	22.26	22.58
1.4	3	2		21.95	22.26	22.53
1.4	6	0		20.95	21.28	21.87
1.4	1	0	16-QAM	21.12	21.43	21.93
1.4	1	2		21.19	21.53	21.99
1.4	1	5		21.13	21.44	21.94
1.4	3	0		20.98	21.31	21.85
1.4	3	1		20.95	21.26	21.82
1.4	3	2		20.95	21.24	21.78
1.4	6	0		20.01	20.33	20.92
3	1	0	QPSK	21.83	22.17	22.63
3	1	7		21.90	22.21	22.61
3	1	14		21.84	22.20	22.57
3	8	0		20.97	21.27	21.88
3	8	4		20.97	21.28	21.90
3	8	7		20.96	21.28	21.91
3	15	0		20.97	21.28	21.88
3	1	0	16-QAM	21.07	21.39	21.89
3	1	7		21.11	21.41	21.93
3	1	14		21.06	21.40	21.92
3	8	0		19.99	20.29	20.86
3	8	4		19.99	20.30	20.88
3	8	7		19.99	20.30	20.91
3	15	0		19.96	20.26	20.87



LTE Band 2 Maximum Average Power [dBm]						
BW [MHz]	RB Size	RB Offset	Mod	Lowest	Middle	Highest
5	1	0	QPSK	21.92	22.21	22.68
5	1	12		21.95	22.24	22.62
5	1	24		21.90	22.21	22.45
5	12	0		21.00	21.32	21.82
5	12	6		21.00	21.29	21.85
5	12	11		21.01	21.31	21.86
5	25	0		20.97	21.27	21.84
5	1	0	16-QAM	21.11	21.43	21.82
5	1	12		21.17	21.45	21.93
5	1	24		21.12	21.42	21.87
5	12	0		19.99	20.29	20.78
5	12	6		20.00	20.27	20.81
5	12	11		20.00	20.28	20.86
5	25	0		19.97	20.25	20.80
10	1	0	QPSK	21.91	22.22	22.56
10	1	24		21.99	22.26	22.59
10	1	49		21.94	22.30	22.14
10	25	0		20.99	21.28	21.67
10	25	12		21.03	21.27	21.73
10	25	24		21.03	21.32	21.85
10	50	0		21.04	21.31	21.79
10	1	0	16-QAM	21.14	21.44	21.75
10	1	24		21.23	21.48	21.84
10	1	49		21.20	21.50	21.54
10	25	0		19.98	20.24	20.62
10	25	12		20.01	20.23	20.68
10	25	24		20.02	20.29	20.79
10	50	0		20.00	20.27	20.74



LTE Band 2 Maximum Average Power [dBm]						
BW [MHz]	RB Size	RB Offset	Mod	Lowest	Middle	Highest
15	1	0	QPSK	21.96	22.25	22.47
15	1	37		22.02	22.27	22.59
15	1	74		22.00	22.36	22.40
15	36	0		21.08	21.31	21.60
15	36	18		21.08	21.31	21.67
15	36	37		21.06	21.37	21.77
15	75	0		21.07	21.33	21.68
15	1	0	16-QAM	21.18	21.47	21.68
15	1	37		21.23	21.46	21.79
15	1	74		21.24	21.57	21.83
15	36	0		20.05	20.29	20.56
15	36	18		20.06	20.28	20.63
15	36	37		20.04	20.33	20.73
15	75	0		20.04	20.30	20.64
20	1	0	QPSK	21.94	22.22	22.41
20	1	49		22.03	22.23	22.48
20	1	99		22.04	22.33	22.71
20	50	0		21.06	21.28	21.54
20	50	24		21.05	21.30	21.61
20	50	49		21.08	21.36	21.74
20	100	0		21.07	21.31	21.64
20	1	0	16-QAM	21.21	21.47	21.63
20	1	49		21.27	21.59	21.85
20	1	99		21.26	21.47	21.72
20	50	0		20.04	20.26	20.51
20	50	24		20.04	20.27	20.56
20	50	49		20.06	20.35	20.69
20	100	0		20.02	20.27	20.59



LTE Band 4 Maximum Average Power [dBm]						
BW [MHz]	RB Size	RB Offset	Mod	Lowest	Middle	Highest
1.4	1	0	QPSK	22.28	22.36	22.56
1.4	1	2		22.37	22.43	22.44
1.4	1	5		22.28	22.37	22.33
1.4	3	0		22.39	22.47	22.51
1.4	3	1		22.33	22.43	22.46
1.4	3	2		22.31	22.42	22.40
1.4	6	0		21.37	21.47	21.79
1.4	1	0	16-QAM	21.49	21.49	21.90
1.4	1	2		21.58	21.57	21.82
1.4	1	5		21.49	21.52	21.72
1.4	3	0		21.34	21.41	21.76
1.4	3	1		21.29	21.37	21.69
1.4	3	2		21.28	21.36	21.63
1.4	6	0		20.41	20.51	20.94
3	1	0	QPSK	22.23	22.35	22.66
3	1	7		22.30	22.36	22.57
3	1	14		22.26	22.37	22.31
3	8	0		21.37	21.46	21.91
3	8	4		21.38	21.45	21.92
3	8	7		21.36	21.47	21.85
3	15	0		21.39	21.50	21.91
3	1	0	16-QAM	21.48	21.48	21.81
3	1	7		21.50	21.51	21.90
3	1	14		21.44	21.53	21.72
3	8	0		20.41	20.48	20.84
3	8	4		20.40	20.47	20.87
3	8	7		20.40	20.50	20.86
3	15	0		20.38	20.48	20.86



LTE Band 4 Maximum Average Power [dBm]						
BW [MHz]	RB Size	RB Offset	Mod	Lowest	Middle	Highest
5	1	0	QPSK	22.32	22.44	22.63
5	1	12		22.36	22.40	22.41
5	1	24		22.31	22.43	22.15
5	12	0		21.42	21.51	21.86
5	12	6		21.42	21.48	21.76
5	12	11		21.42	21.51	21.61
5	25	0		21.39	21.50	21.76
5	1	0	16-QAM	21.52	21.57	21.85
5	1	12		21.51	21.55	21.76
5	1	24		21.44	21.61	21.58
5	12	0		20.41	20.50	20.81
5	12	6		20.41	20.46	20.82
5	12	11		20.40	20.50	20.76
5	25	0		20.36	20.47	20.81
10	1	0	QPSK	22.35	22.46	22.63
10	1	24		22.40	22.38	22.65
10	1	49		22.30	22.56	22.11
10	25	0		21.44	21.56	21.78
10	25	12		21.43	21.51	21.82
10	25	24		21.45	21.58	21.72
10	50	0		21.48	21.60	21.91
10	1	0	16-QAM	21.56	21.61	21.87
10	1	24		21.55	21.55	21.81
10	1	49		21.45	21.77	21.16
10	25	0		20.41	20.51	20.73
10	25	12		20.38	20.48	20.75
10	25	24		20.41	20.56	20.79
10	50	0		20.44	20.56	20.81



LTE Band 4 Maximum Average Power [dBm]						
BW [MHz]	RB Size	RB Offset	Mod	Lowest	Middle	Highest
15	1	0	QPSK	22.37	22.53	22.66
15	1	37		22.39	22.40	22.64
15	1	74		22.34	22.59	22.13
15	36	0		21.46	21.61	21.81
15	36	18		21.47	21.56	21.80
15	36	37		21.47	21.65	21.84
15	75	0		21.48	21.63	21.85
15	1	0	16-QAM	21.59	21.63	21.97
15	1	37		21.54	21.57	21.87
15	1	74		21.45	21.80	21.40
15	36	0		20.44	20.58	20.78
15	36	18		20.44	20.53	20.75
15	36	37		20.43	20.62	20.79
15	75	0		20.44	20.59	20.79
20	1	0	QPSK	22.41	22.53	22.70
20	1	49		22.36	22.35	22.68
20	1	99		22.36	22.48	22.06
20	50	0		21.53	21.63	21.84
20	50	24		21.49	21.58	21.80
20	50	49		21.50	21.62	21.83
20	100	0		21.48	21.59	21.83
20	1	0	16-QAM	21.61	21.80	21.88
20	1	49		21.50	21.56	21.78
20	1	99		21.51	21.59	21.40
20	50	0		20.46	20.57	20.82
20	50	24		20.44	20.54	20.75
20	50	49		20.46	20.61	20.76
20	100	0		20.43	20.57	20.76



LTE Band 7 Maximum Average Power [dBm]						
BW [MHz]	RB Size	RB Offset	Mod	Lowest	Middle	Highest
5	1	0	QPSK	21.84	21.44	21.62
5	1	12		21.53	21.03	21.30
5	1	24		22.21	21.52	21.95
5	12	0		20.62	20.17	20.36
5	12	6		20.63	20.15	20.34
5	12	11		20.75	20.24	20.48
5	25	0		20.70	20.22	20.45
5	1	0	16-QAM	21.20	20.89	20.97
5	1	12		20.94	20.50	20.68
5	1	24		21.58	21.03	21.38
5	12	0		19.87	19.45	19.60
5	12	6		19.81	19.44	19.58
5	12	11		20.03	19.53	19.72
5	25	0		19.98	19.52	19.68
10	1	0	QPSK	21.55	21.08	21.41
10	1	24		21.87	21.02	21.20
10	1	49		22.22	21.52	21.62
10	25	0		20.63	20.16	20.37
10	25	12		20.99	20.19	20.34
10	25	24		21.28	20.33	20.40
10	50	0		20.94	20.24	20.42
10	1	0	16-QAM	20.66	20.48	20.71
10	1	24		21.27	20.55	20.56
10	1	49		21.59	20.69	20.77
10	25	0		19.90	19.43	19.56
10	25	12		20.21	19.49	19.51
10	25	24		20.49	19.59	19.65
10	50	0		20.22	19.54	19.61



LTE Band 7 Maximum Average Power [dBm]						
BW [MHz]	RB Size	RB Offset	Mod	Lowest	Middle	Highest
15	1	0	QPSK	21.95	21.33	22.17
15	1	37		22.38	21.18	21.48
15	1	74		22.65	21.84	21.79
15	36	0		20.98	20.26	20.94
15	36	18		21.36	20.22	20.63
15	36	37		21.66	20.48	20.57
15	75	0		21.32	20.37	20.81
15	1	0	16-QAM	20.98	20.80	21.45
15	1	37		21.76	20.56	20.85
15	1	74		21.94	21.34	21.16
15	36	0		20.18	19.47	20.14
15	36	18		20.56	19.51	19.85
15	36	37		20.84	19.70	19.77
15	75	0		20.55	19.65	19.97
20	1	0	QPSK	22.01	22.00	22.47
20	1	49		22.68	22.25	22.52
20	1	99		22.62	22.07	22.24
20	50	0		21.30	21.45	21.23
20	50	24		21.68	21.46	21.65
20	50	49		21.97	21.56	21.80
20	100	0		21.65	21.25	21.43
20	1	0	16-QAM	21.19	21.15	21.74
20	1	49		21.94	20.62	21.18
20	1	99		21.95	21.55	21.27
20	50	0		20.46	19.62	20.39
20	50	24		20.84	19.63	20.13
20	50	49		20.94	19.95	19.88
20	100	0		20.81	19.81	20.17



LTE Band 12 Maximum Average Power [dBm]						
BW [MHz]	RB Size	RB Offset	Mod	Lowest	Middle	Highest
1.4	1	0	QPSK	22.70	22.70	22.72
1.4	1	2		22.64	22.72	22.68
1.4	1	5		22.84	22.63	22.86
1.4	3	0		22.67	22.77	22.70
1.4	3	1		22.68	22.72	22.72
1.4	3	2		22.72	22.71	22.76
1.4	6	0		21.89	21.78	21.89
1.4	1	0	16-QAM	22.07	21.95	22.24
1.4	1	2		22.05	21.97	22.25
1.4	1	5		22.18	21.88	22.40
1.4	3	0		21.87	21.79	22.06
1.4	3	1		21.89	21.75	22.09
1.4	3	2		21.92	21.73	22.13
1.4	6	0		21.13	20.85	21.31
3	1	0	QPSK	22.82	22.78	22.65
3	1	7		22.79	22.68	22.70
3	1	14		22.86	22.57	22.80
3	8	0		22.00	21.86	21.82
3	8	4		22.01	21.79	21.92
3	8	7		22.03	21.79	22.08
3	15	0		22.08	21.83	21.95
3	1	0	16-QAM	22.11	22.07	21.98
3	1	7		22.16	21.95	22.06
3	1	14		22.13	21.84	22.37
3	8	0		21.13	20.91	21.02
3	8	4		21.09	20.83	21.14
3	8	7		21.09	20.84	21.28
3	15	0		21.07	20.82	21.13



LTE Band 12 Maximum Average Power [dBm]						
BW [MHz]	RB Size	RB Offset	Mod	Lowest	Middle	Highest
5	1	0	QPSK	22.64	22.79	22.30
5	1	12		22.52	22.47	22.11
5	1	24		22.85	22.26	22.79
5	12	0		21.62	21.96	21.17
5	12	6		21.73	21.85	21.19
5	12	11		22.01	21.52	21.37
5	25	0		21.93	21.86	21.31
5	1	0	16-QAM	22.03	22.17	21.64
5	1	12		21.88	21.90	21.39
5	1	24		22.09	21.69	22.14
5	12	0		20.80	20.96	20.35
5	12	6		20.88	20.86	20.37
5	12	11		21.06	20.76	20.54
5	25	0		21.02	20.86	20.48
10	1	0	QPSK	22.82	22.87	22.76
10	1	24		22.57	22.62	22.12
10	1	49		22.18	22.30	22.58
10	25	0		21.92	22.00	21.74
10	25	12		21.88	21.99	21.18
10	25	24		21.41	21.96	21.25
10	50	0		21.95	21.98	21.54
10	1	0	16-QAM	22.14	22.17	22.07
10	1	24		21.99	22.03	21.36
10	1	49		21.46	21.76	21.99
10	25	0		20.93	21.03	20.82
10	25	12		20.87	21.00	20.39
10	25	24		20.61	20.95	20.46
10	50	0		20.94	20.98	20.74



Peak-to-Average Ratio

Mode	LTE Band 2 / 20MHz				
Mod.	QPSK		16QAM		Limit: 13dB
RB Size	1RB	Full RB	1RB	Full RB	Result
Lowest CH	4.23	5.04	5.16	5.88	PASS
Middle CH	4.12	4.87	5.10	5.74	
Highest CH	4.20	4.81	5.30	5.68	

Mode	LTE Band 4 / 20MHz				
Mod.	QPSK		16QAM		Limit: 13dB
RB Size	1RB	Full RB	1RB	RB Size	Result
Lowest CH	3.77	4.32	4.99	5.33	PASS
Middle CH	3.25	4.61	3.80	5.54	
Highest CH	3.28	4.46	4.38	5.51	

Mode	LTE Band 7 / 20MHz				
Mod.	QPSK		16QAM		Limit: 13dB
RB Size	1RB	Full RB	1RB	RB Size	Result
Lowest CH	3.77	4.72	4.58	5.54	PASS
Middle CH	4.52	5.54	4.72	6.41	
Highest CH	3.42	5.04	3.77	5.88	

Mode	LTE Band 12 / 10MHz				
Mod.	QPSK		16QAM		Limit: 13dB
RB Size	1RB	Full RB	1RB	RB Size	Result
Lowest CH	3.94	4.96	5.33	5.86	PASS
Middle CH	4.46	5.16	5.39	5.97	
Highest CH	3.68	5.51	4.75	6.17	



LTE Band 2 / 20MHz / QPSK

Lowest Channel / 1RB



Date: 6 JUL 2015 16:30:59

Lowest Channel / Full RB



Date: 6 JUL 2015 16:30:48

Middle Channel / 1RB



Date: 6 JUL 2015 16:32:01

Middle Channel / Full RB



Date: 6 JUL 2015 16:31:51

Highest Channel / 1RB



Date: 6 JUL 2015 16:32:32

Highest Channel / Full RB



Date: 6 JUL 2015 16:32:42



LTE Band 2 / 20MHz / 16QAM

Lowest Channel / 1RB

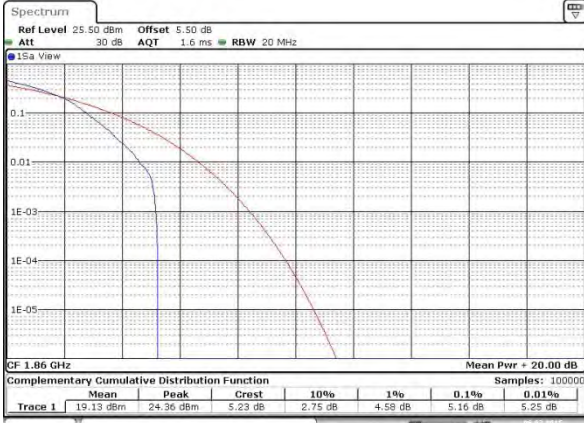

Date: 6 JUL 2015 16:30:14

Lowest Channel / Full RB



Date: 6 JUL 2015 16:30:29

Middle Channel / 1RB



Date: 6 JUL 2015 16:31:09

Middle Channel / Full RB



Date: 6 JUL 2015 16:31:41

Highest Channel / 1RB

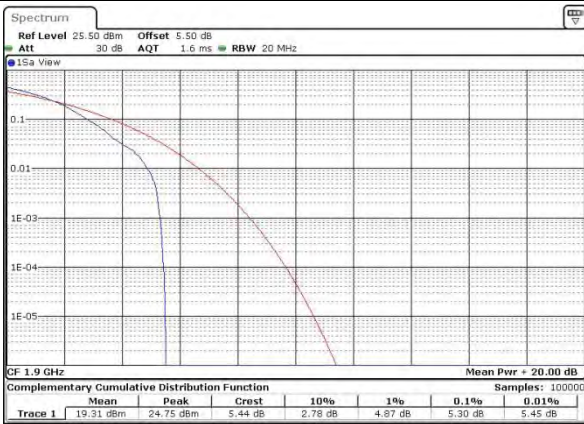

Date: 6 JUL 2015 16:32:12

Highest Channel / Full RB



Date: 6 JUL 2015 16:32:22



LTE Band 4 / 20MHz / QPSK

Lowest Channel / 1RB



Date: 6 JUL 2015 20:07:46

Lowest Channel / Full RB



Date: 6 JUL 2015 20:07:36

Middle Channel / 1RB

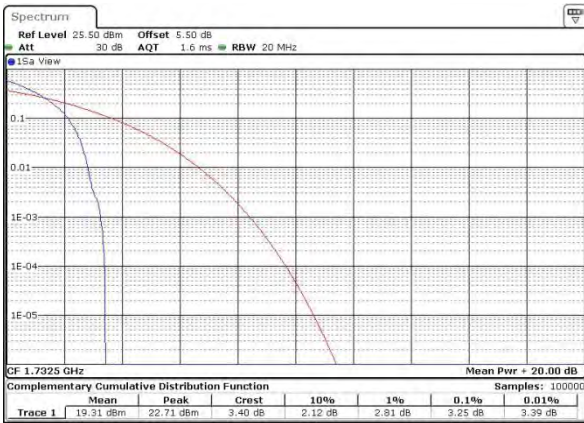

Date: 6 JUL 2015 20:08:54

Middle Channel / Full RB



Date: 6 JUL 2015 20:08:41

Highest Channel / 1RB



Date: 6 JUL 2015 20:09:23

Highest Channel / Full RB



Date: 6 JUL 2015 20:09:11



LTE Band 4 / 20MHz / 16QAM

Lowest Channel / 1RB

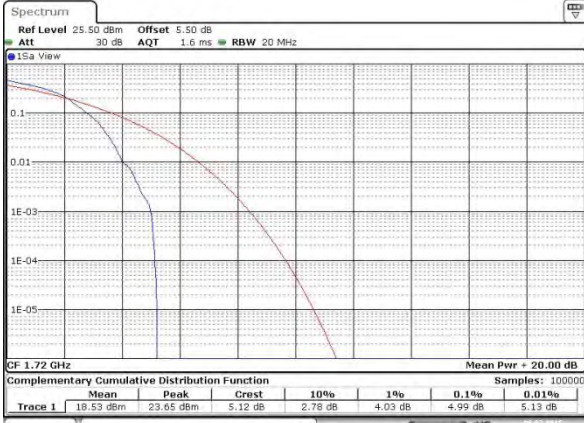

Date: 6 JUL 2015 20:07:14

Lowest Channel / Full RB



Date: 6 JUL 2015 20:07:25

Middle Channel / 1RB



Date: 6 JUL 2015 20:08:13

Middle Channel / Full RB



Date: 6 JUL 2015 20:08:24

Highest Channel / 1RB



Date: 6 JUL 2015 20:09:34

Highest Channel / Full RB



Date: 6 JUL 2015 20:09:47



LTE Band 7 / 20MHz / QPSK

Lowest Channel / 1RB

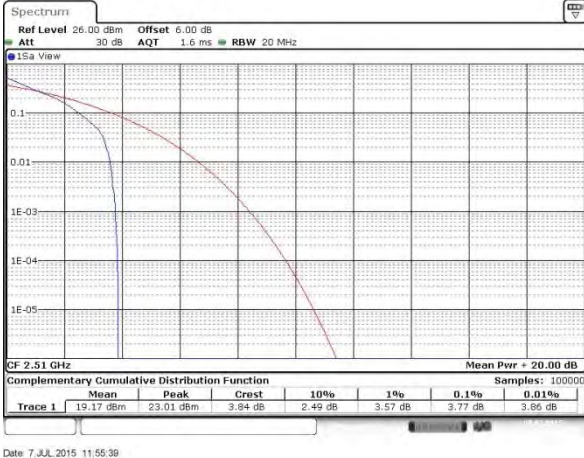

Date: 7 JUL 2015 11:55:39

Lowest Channel / Full RB



Date: 7 JUL 2015 11:56:48

Middle Channel / 1RB

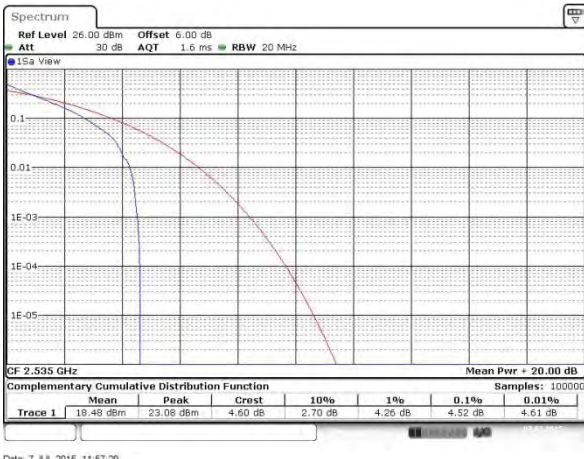

Date: 7 JUL 2015 11:57:28

Middle Channel / Full RB

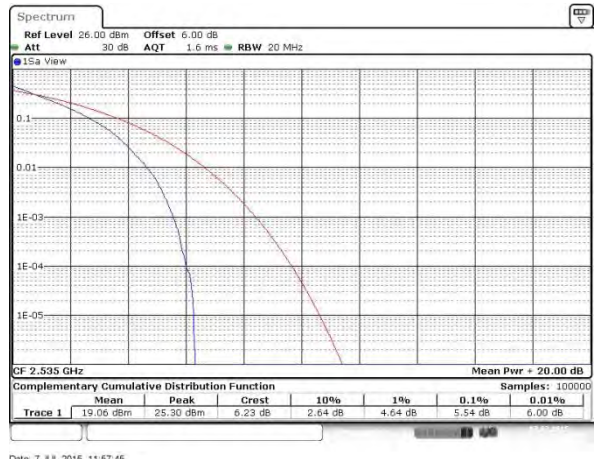

Date: 7 JUL 2015 11:57:45

Highest Channel / 1RB



Date: 7 JUL 2015 11:57:59

Highest Channel / Full RB

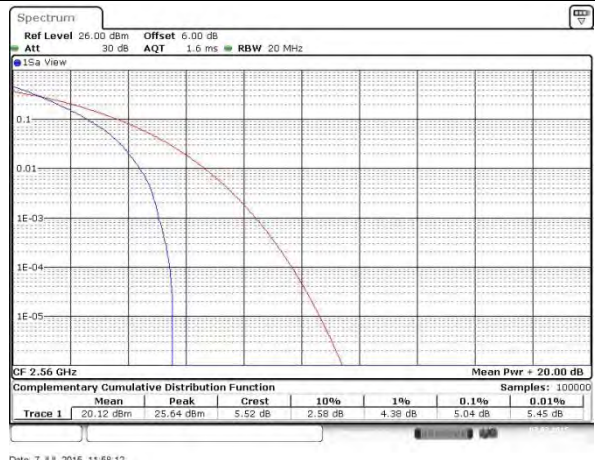

Date: 7 JUL 2015 11:58:12



LTE Band 7 / 20MHz / 16QAM

Lowest Channel / 1RB



Date: 7 JUL 2015 11:50:43

Lowest Channel / Full RB



Date: 7 JUL 2015 11:50:54

Middle Channel / 1RB



Date: 7 JUL 2015 11:51:48

Middle Channel / Full RB



Date: 7 JUL 2015 11:52:48

Highest Channel / 1RB



Date: 7 JUL 2015 11:53:36

Highest Channel / Full RB



Date: 7 JUL 2015 11:54:11



LTE Band 12 / 10MHz / QPSK

Lowest Channel / 1RB

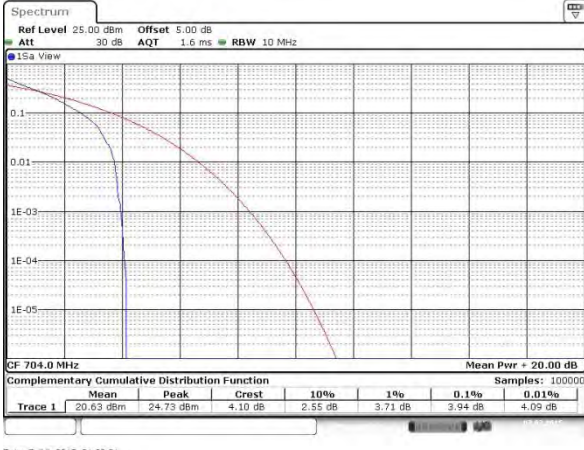

Date: 7 JUL 2015 01:20:21

Lowest Channel / Full RB

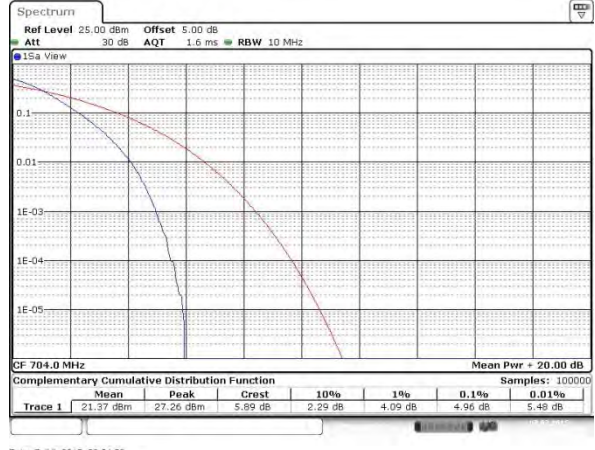

Date: 7 JUL 2015 02:24:58

Middle Channel / 1RB

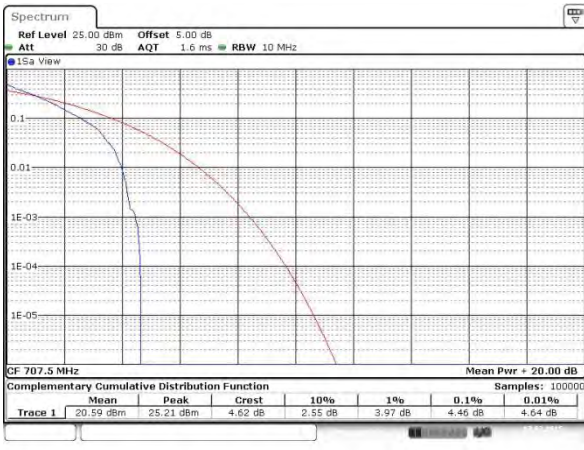

Date: 7 JUL 2015 01:21:18

Middle Channel / Full RB

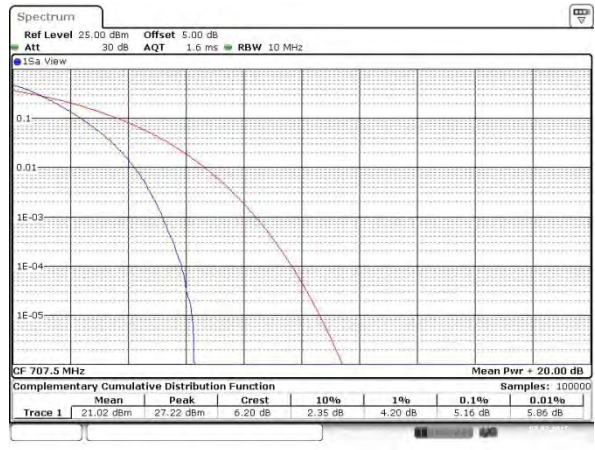

Date: 7 JUL 2015 01:21:07

Highest Channel / 1RB

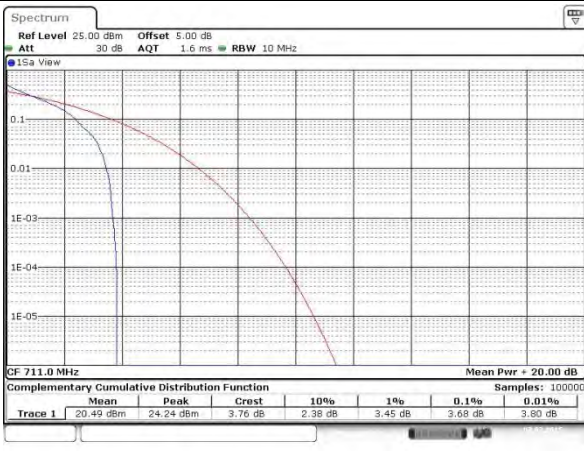

Date: 7 JUL 2015 01:21:53

Highest Channel / Full RB



Date: 7 JUL 2015 01:22:03



LTE Band 12 / 10MHz / 16QAM

Lowest Channel / 1RB

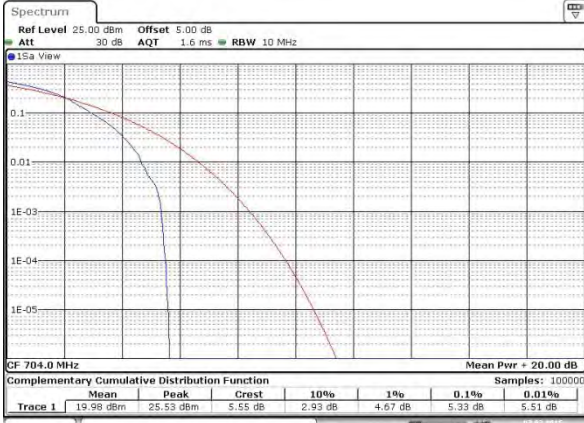

Date: 7 JUL 2015 01:20:11

Lowest Channel / Full RB



Date: 7 JUL 2015 01:20:43

Middle Channel / 1RB



Date: 7 JUL 2015 01:21:30

Middle Channel / Full RB



Date: 7 JUL 2015 01:20:55

Highest Channel / 1RB



Date: 7 JUL 2015 01:21:41

Highest Channel / Full RB



Date: 7 JUL 2015 01:22:15



26dB Bandwidth

Mode	LTE Band 2 : 26dB BW(MHz)											
	1.4MHz		3MHz		5MHz		10MHz		15MHz		20MHz	
Mod.	QPSK	16QAM	QPSK	16QAM	QPSK	16QAM	QPSK	16QAM	QPSK	16QAM	QPSK	16QAM
Lowest CH	1.26	1.28	3.03	3.05	5.09	5.07	9.99	10.01	14.78	14.87	20.50	20.30
Middle CH	1.27	1.28	3.03	3.06	5.12	5.06	10.19	9.97	14.78	14.78	20.42	20.26
Highest CH	1.27	1.29	3.06	3.05	5.11	5.06	10.05	10.01	14.69	14.75	20.34	20.30

Mode	LTE Band 4 : 26dB BW(MHz)											
	1.4MHz		3MHz		5MHz		10MHz		15MHz		20MHz	
Mod.	QPSK	16QAM	QPSK	16QAM	QPSK	16QAM	QPSK	16QAM	QPSK	16QAM	QPSK	16QAM
Lowest CH	1.26	1.28	3.02	3.04	5.11	5.06	10.15	9.97	14.78	14.78	20.18	20.38
Middle CH	1.27	1.28	3.03	3.03	5.11	5.08	10.13	10.05	14.84	14.93	20.42	20.58
Highest CH	1.29	1.30	3.10	3.05	5.14	5.08	10.19	9.97	14.84	14.96	20.42	20.54

Mode	LTE Band 7 : 26dB BW(MHz)											
	1.4MHz		3MHz		5MHz		10MHz		15MHz		20MHz	
Mod.	QPSK	16QAM	QPSK	16QAM	QPSK	16QAM	QPSK	16QAM	QPSK	16QAM	QPSK	16QAM
Lowest CH	-	-	-	-	5.08	5.08	9.95	9.95	14.66	14.63	20.42	20.62
Middle CH	-	-	-	-	5.07	5.10	10.11	10.01	14.72	14.72	20.58	20.46
Highest CH	-	-	-	-	5.09	5.09	10.03	9.91	14.69	14.81	20.54	20.58

Mode	LTE Band 12 : 26dB BW(MHz)											
	1.4MHz		3MHz		5MHz		10MHz		15MHz		20MHz	
Mod.	QPSK	16QAM	QPSK	16QAM	QPSK	16QAM	QPSK	16QAM	QPSK	16QAM	QPSK	16QAM
Lowest CH	1.27	1.28	3.02	3.03	5.05	5.05	9.93	9.95	-	-	-	-
Middle CH	1.27	1.28	3.04	3.03	5.08	5.06	10.11	10.01	-	-	-	-
Highest CH	1.27	1.28	3.03	3.03	5.11	5.06	10.17	9.99	-	-	-	-



LTE Band 2

Lowest Channel / 1.4MHz / QPSK

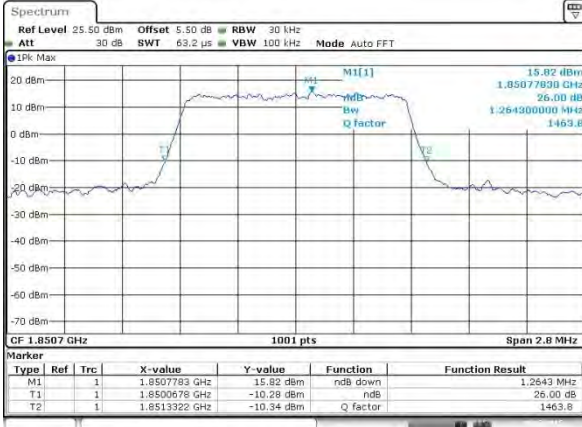

Date: 6 JUL 2015 14:38:32

Lowest Channel / 1.4MHz / 16QAM

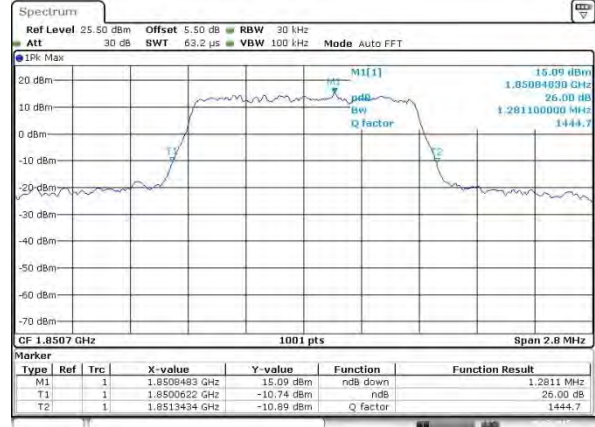

Date: 6 JUL 2015 14:38:44

Middle Channel / 1.4MHz / QPSK

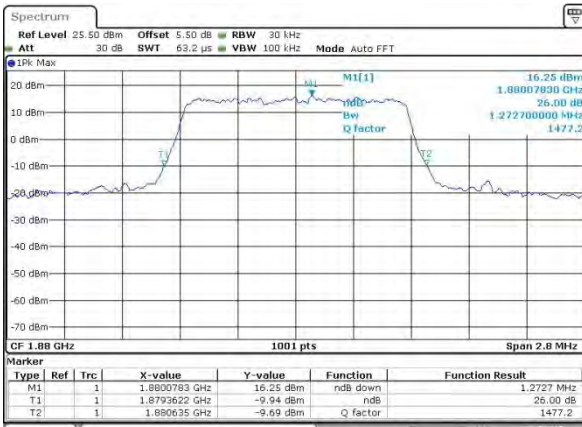

Date: 6 JUL 2015 14:46:14

Middle Channel / 1.4MHz / 16QAM

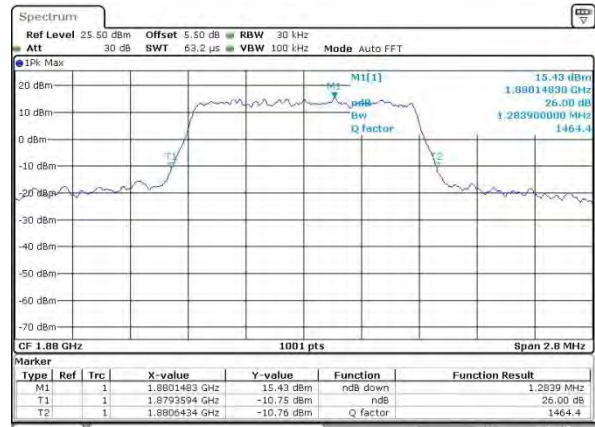

Date: 6 JUL 2015 14:46:27

Highest Channel / 1.4MHz / QPSK

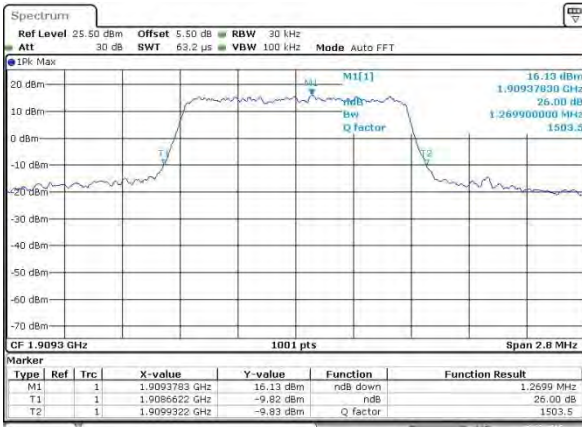

Date: 6 JUL 2015 14:49:22

Highest Channel / 1.4MHz / 16QAM

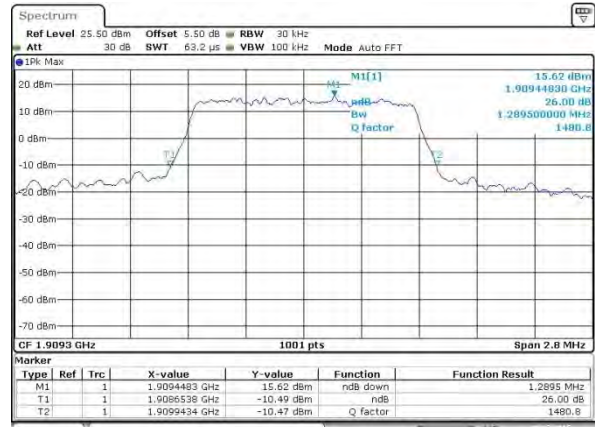

Date: 6 JUL 2015 14:49:36



LTE Band 2

Lowest Channel / 3MHz / QPSK

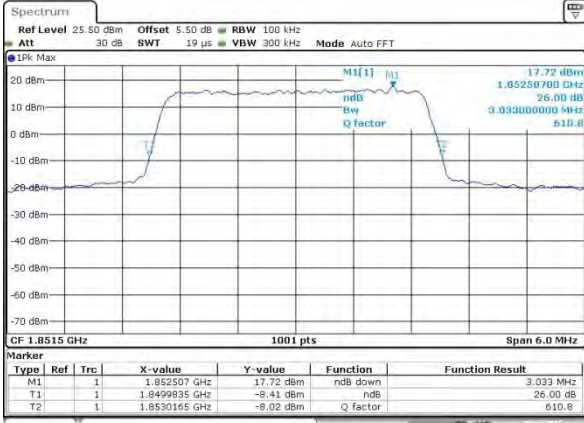

Date: 6 JUL 2015 14:57:05

Lowest Channel / 3MHz / 16QAM

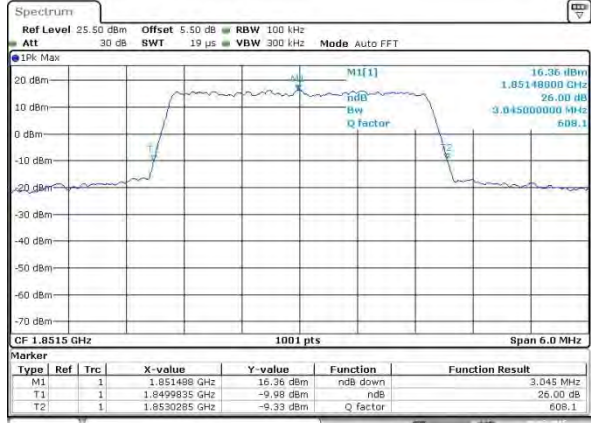

Date: 6 JUL 2015 14:57:17

Middle Channel / 3MHz / QPSK

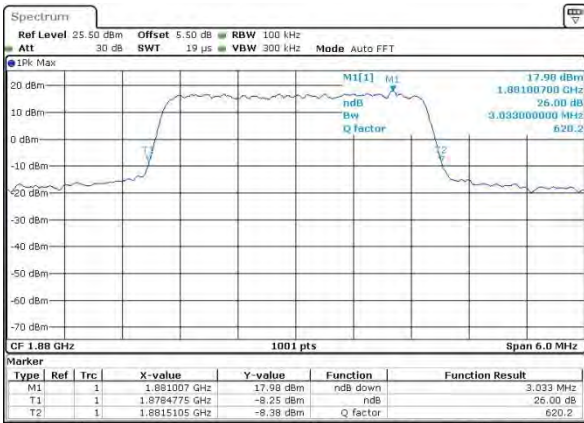

Date: 6 JUL 2015 15:04:47

Middle Channel / 3MHz / 16QAM

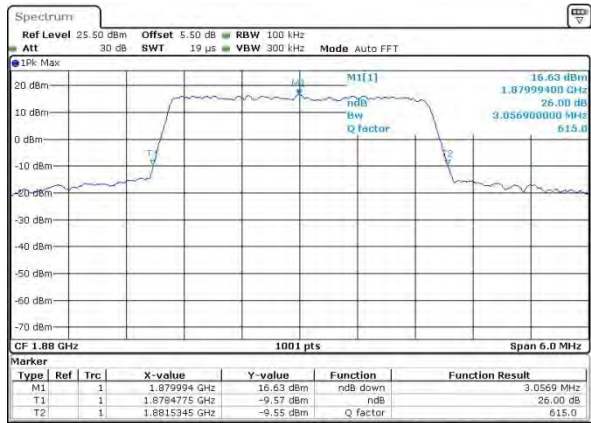

Date: 6 JUL 2015 15:05:00

Highest Channel / 3MHz / QPSK

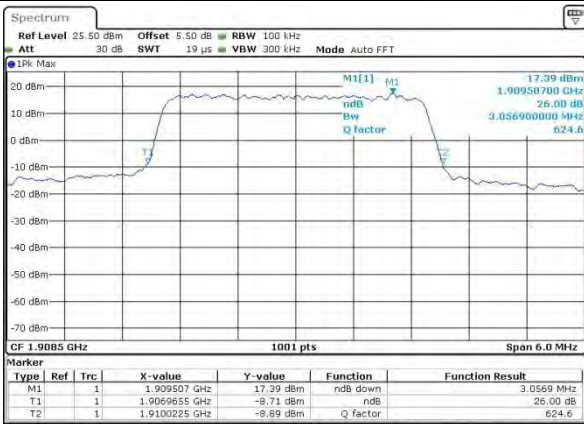

Date: 6 JUL 2015 15:07:56

Highest Channel / 3MHz / 16QAM

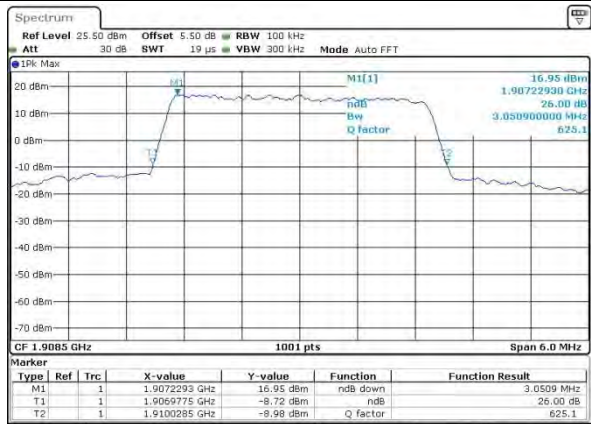

Date: 6 JUL 2015 15:08:09



LTE Band 2

Lowest Channel / 5MHz / QPSK

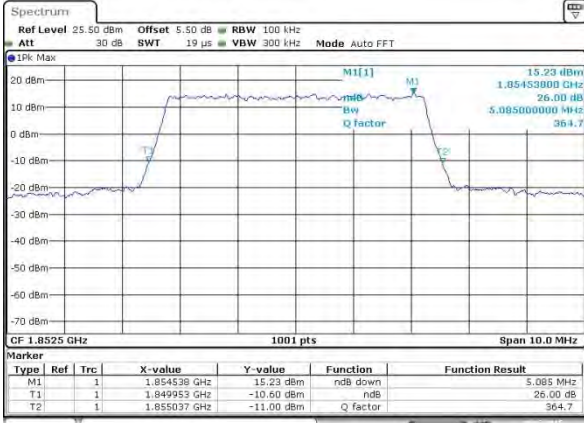

Date: 6 JUL 2015 15:16:15

Lowest Channel / 5MHz / 16QAM

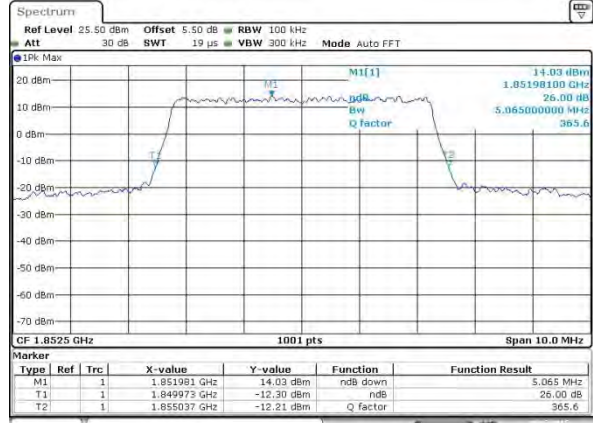

Date: 6 JUL 2015 15:16:28

Middle Channel / 5MHz / QPSK

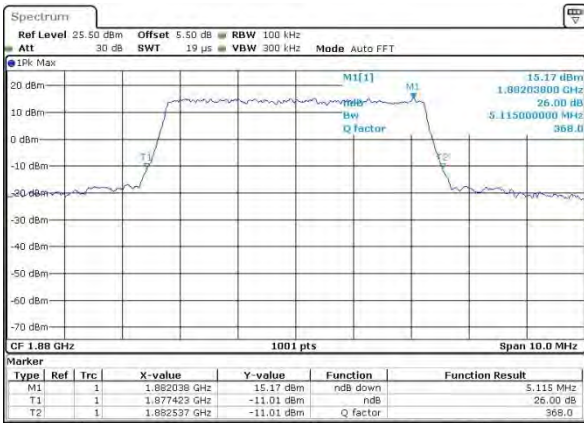

Date: 6 JUL 2015 15:23:57

Middle Channel / 5MHz / 16QAM

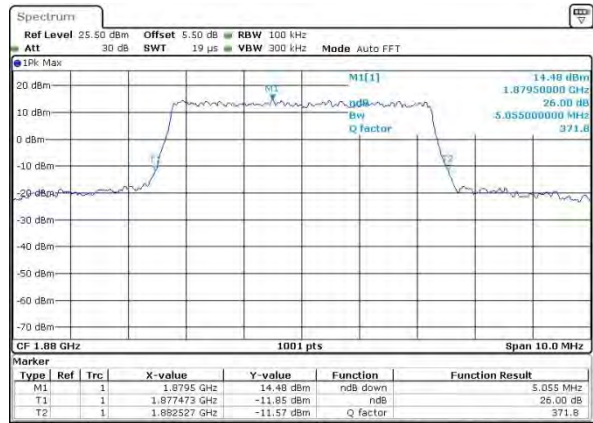

Date: 6 JUL 2015 15:24:10

Highest Channel / 5MHz / QPSK

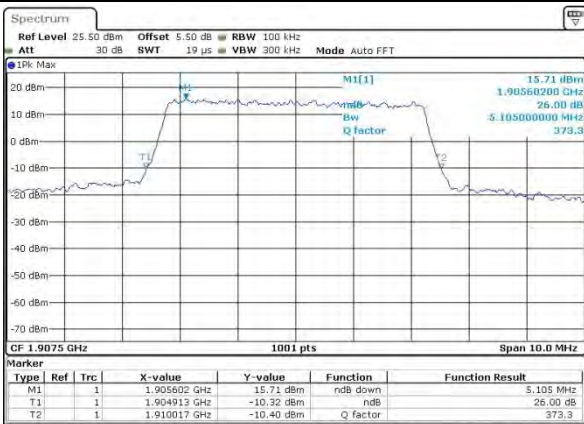

Date: 6 JUL 2015 15:27:06

Highest Channel / 5MHz / 16QAM

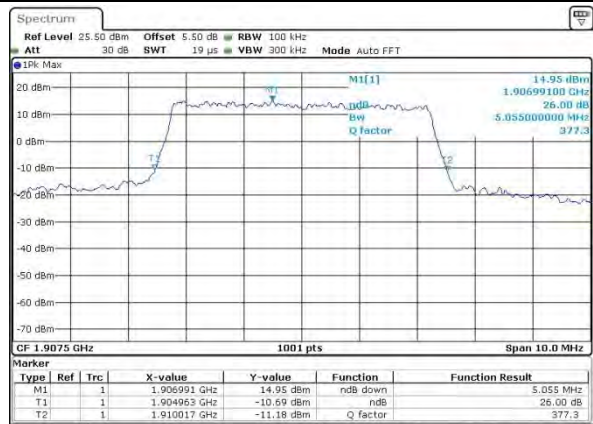

Date: 6 JUL 2015 15:27:18



LTE Band 2

Lowest Channel / 10MHz / QPSK

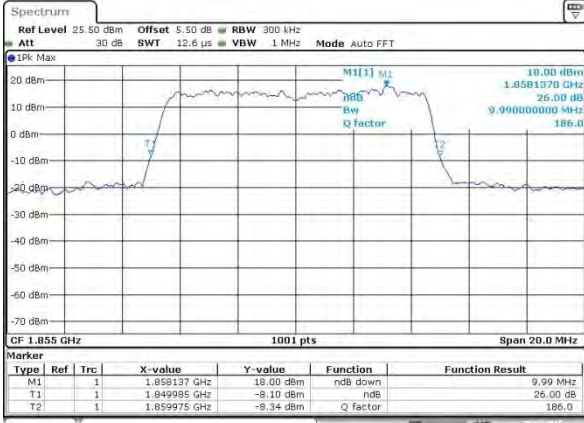

Date: 6 JUL 2015 15:34:46

Lowest Channel / 10MHz / 16QAM



Date: 6 JUL 2015 15:35:01

Middle Channel / 10MHz / QPSK

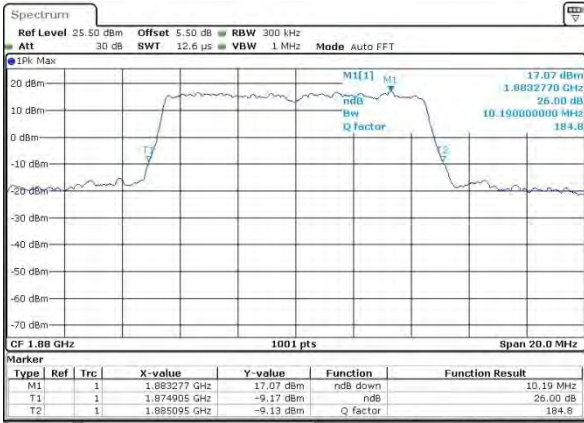

Date: 6 JUL 2015 15:42:31

Middle Channel / 10MHz / 16QAM

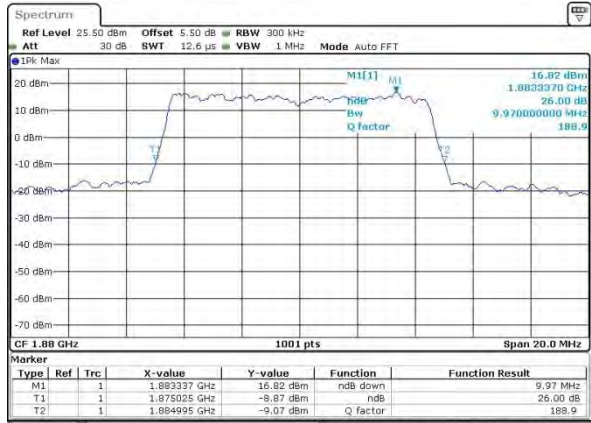

Date: 6 JUL 2015 15:42:44

Highest Channel / 10MHz / QPSK

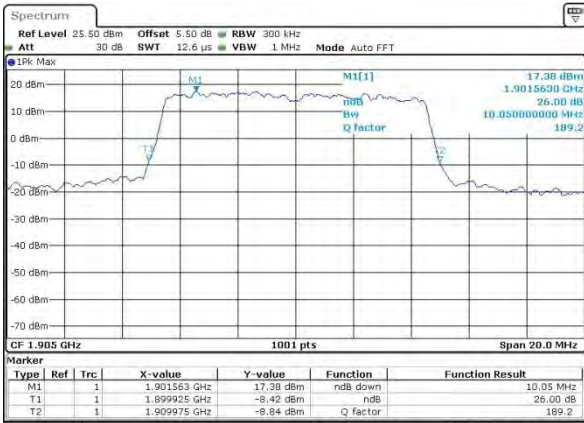

Date: 6 JUL 2015 15:45:40

Highest Channel / 10MHz / 16QAM

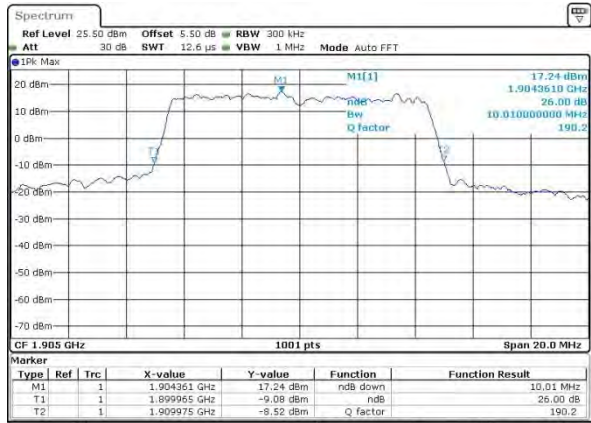

Date: 6 JUL 2015 15:45:52



LTE Band 2

Lowest Channel / 15MHz / QPSK

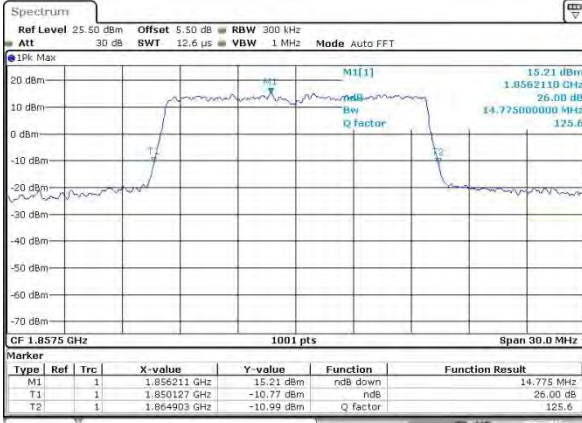

Date: 6 JUL 2015 16:53:22

Lowest Channel / 15MHz / 16QAM

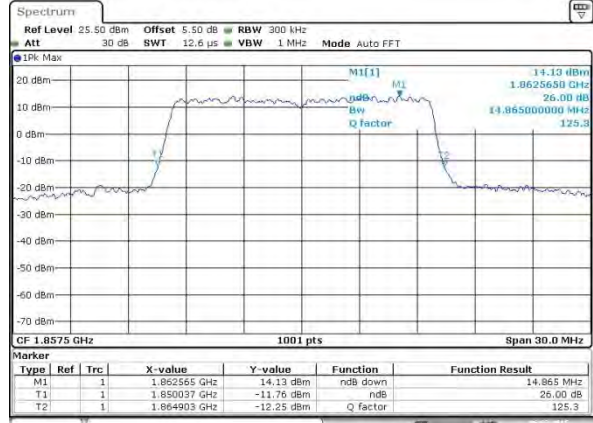

Date: 6 JUL 2015 16:53:34

Middle Channel / 15MHz / QPSK

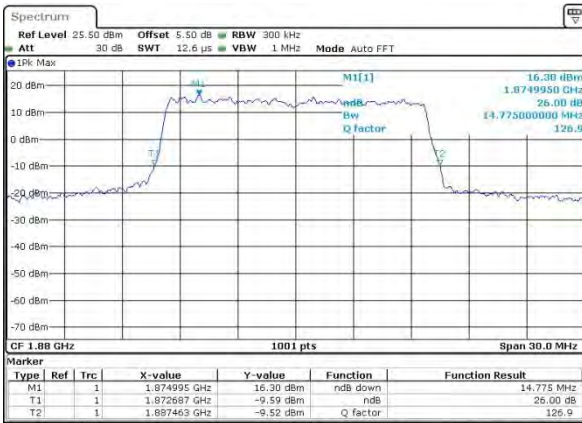

Date: 6 JUL 2015 16:01:04

Middle Channel / 15MHz / 16QAM

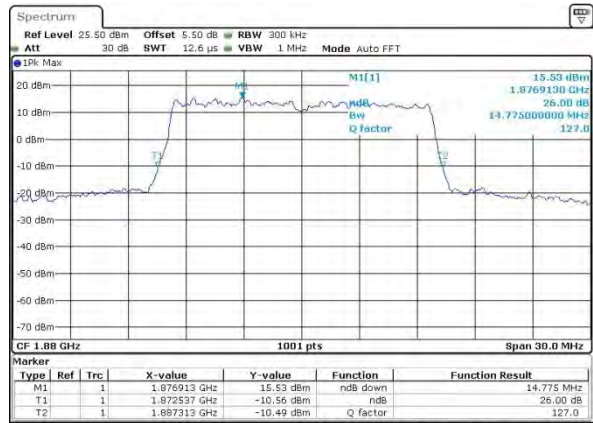

Date: 6 JUL 2015 16:01:17

Highest Channel / 15MHz / QPSK

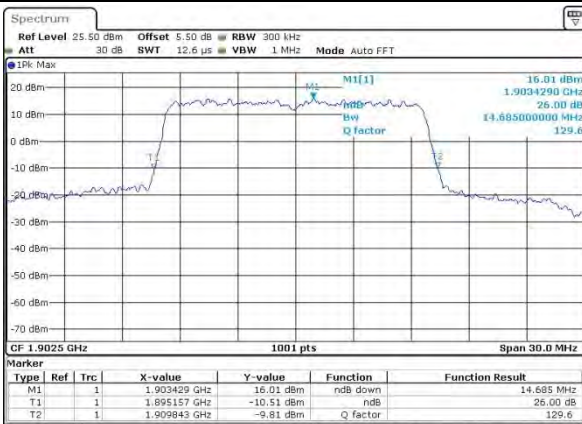

Date: 6 JUL 2015 16:04:13

Highest Channel / 15MHz / 16QAM

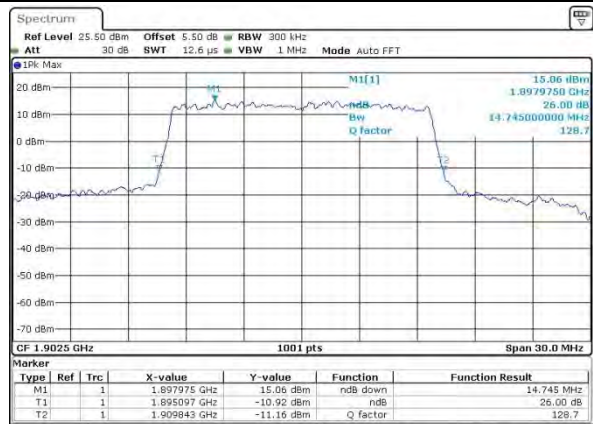

Date: 6 JUL 2015 16:04:26



LTE Band 2

Lowest Channel / 20MHz / QPSK

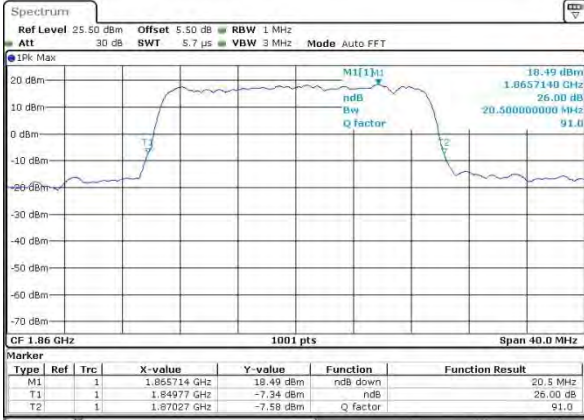

Date: 6 JUL 2015 16:11:57

Lowest Channel / 20MHz / 16QAM

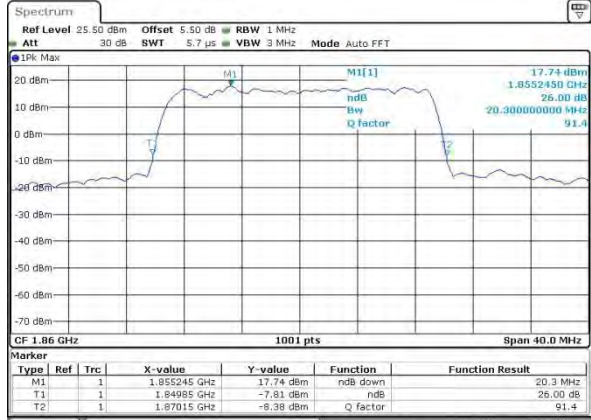

Date: 6 JUL 2015 16:12:09

Middle Channel / 20MHz / QPSK

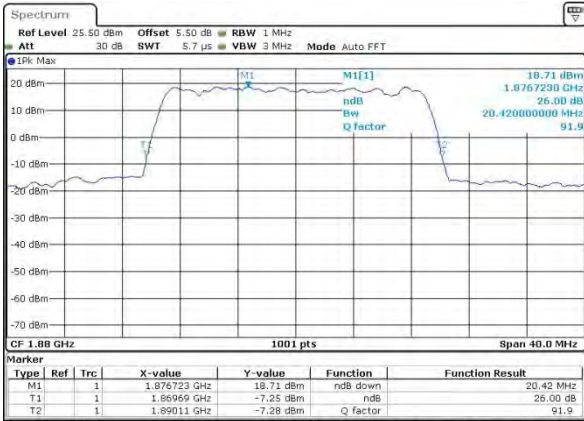

Date: 6 JUL 2015 16:19:39

Middle Channel / 20MHz / 16QAM

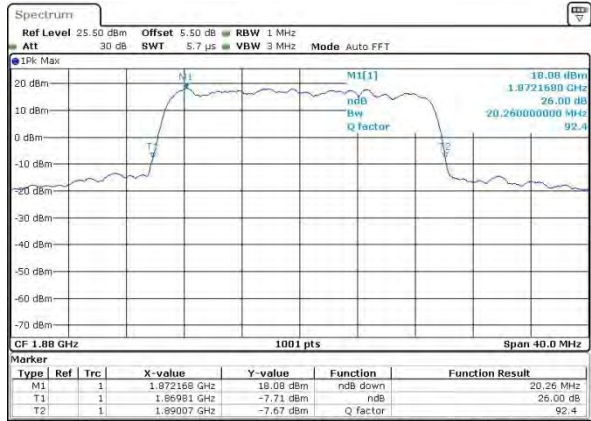

Date: 6 JUL 2015 16:19:52

Highest Channel / 20MHz / QPSK

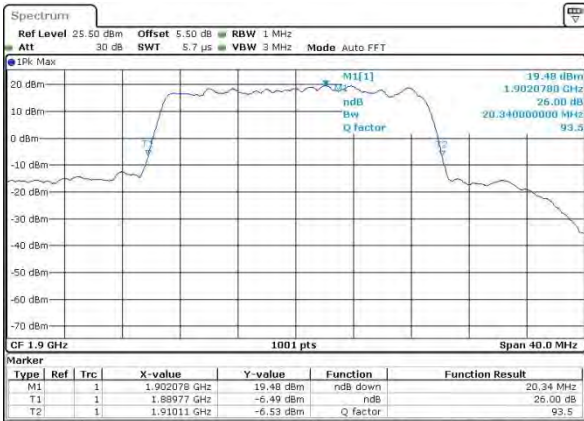

Date: 6 JUL 2015 16:22:47

Highest Channel / 20MHz / 16QAM

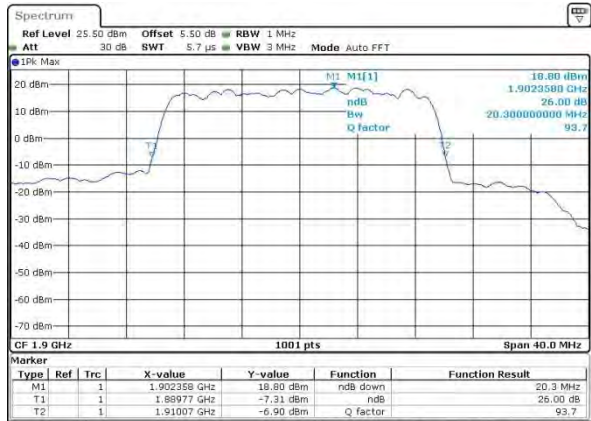

Date: 6 JUL 2015 16:23:00



LTE Band 4

Lowest Channel / 1.4MHz / QPSK

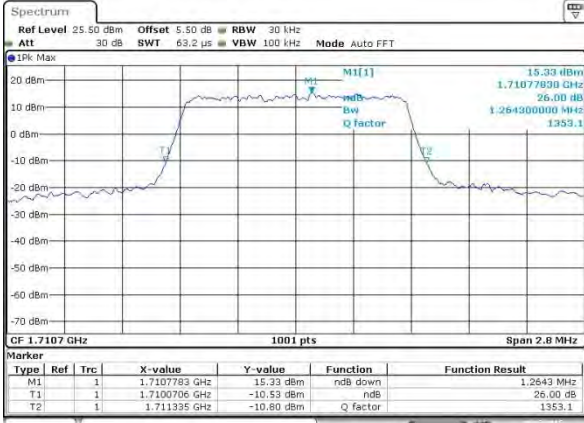

Date: 6 JUL 2015 19:10:56

Lowest Channel / 1.4MHz / 16QAM

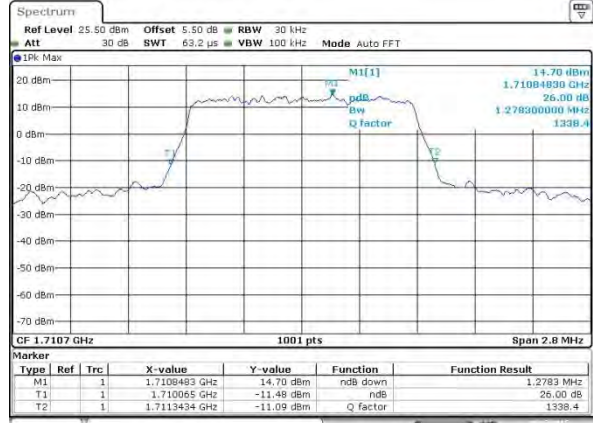

Date: 6 JUL 2015 19:11:09

Middle Channel / 1.4MHz / QPSK

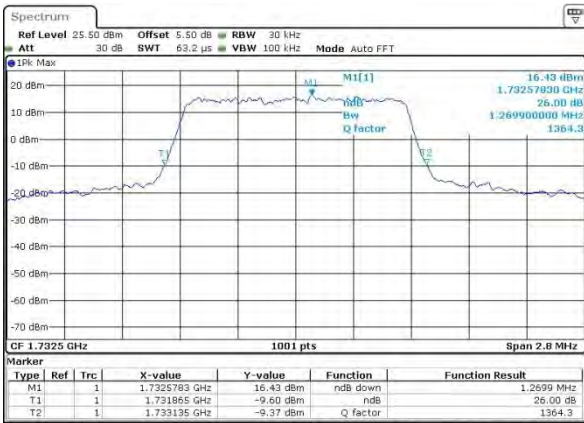

Date: 6 JUL 2015 19:14:05

Middle Channel / 1.4MHz / 16QAM

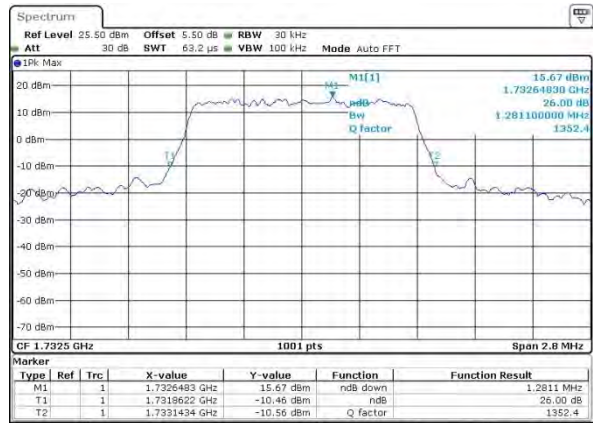

Date: 6 JUL 2015 19:14:16

Highest Channel / 1.4MHz / QPSK

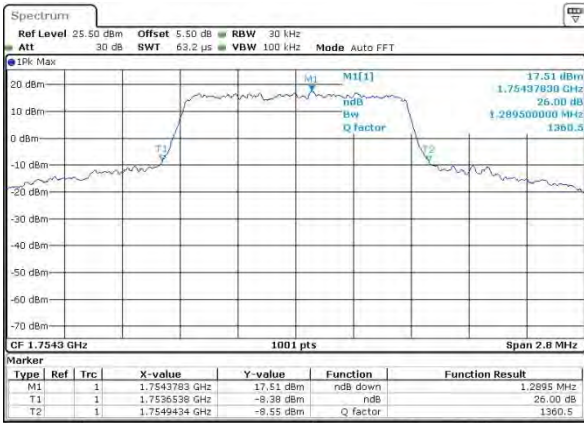

Date: 6 JUL 2015 19:17:13

Highest Channel / 1.4MHz / 16QAM

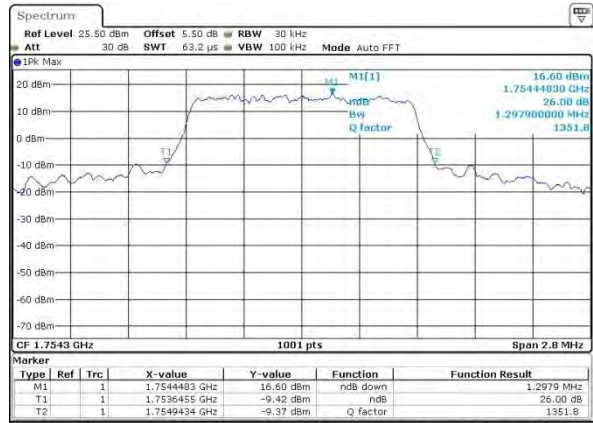

Date: 6 JUL 2015 19:17:26



LTE Band 4

Lowest Channel / 3MHz / QPSK



Date: 6 JUL 2015 19:20:22

Lowest Channel / 3MHz / 16QAM

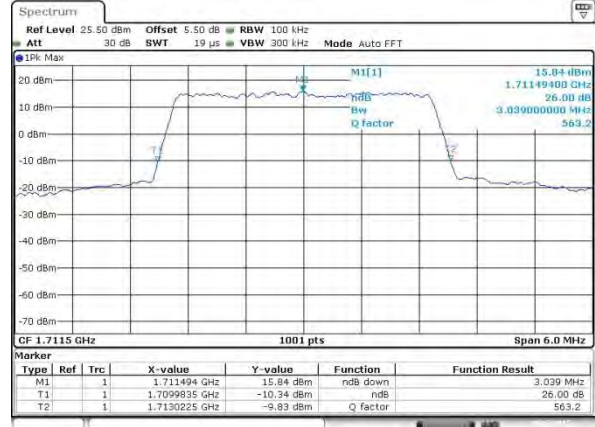

Date: 6 JUL 2015 19:20:34

Middle Channel / 3MHz / QPSK

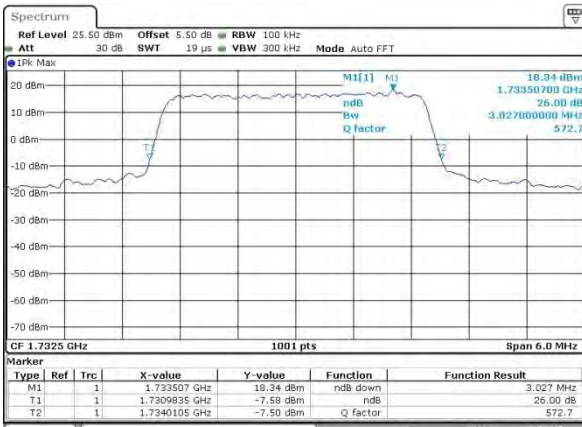

Date: 6 JUL 2015 19:23:30

Middle Channel / 3MHz / 16QAM

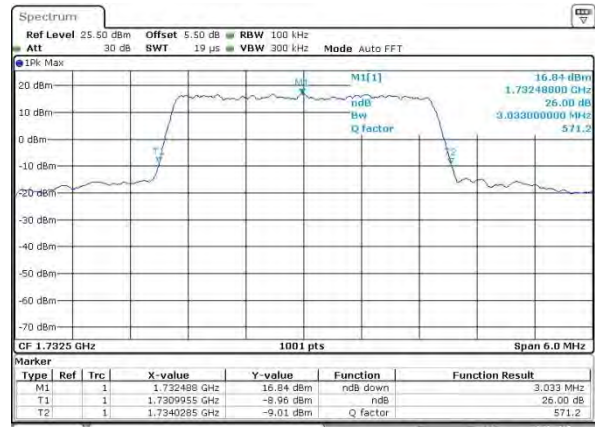

Date: 6 JUL 2015 19:23:45

Highest Channel / 3MHz / QPSK

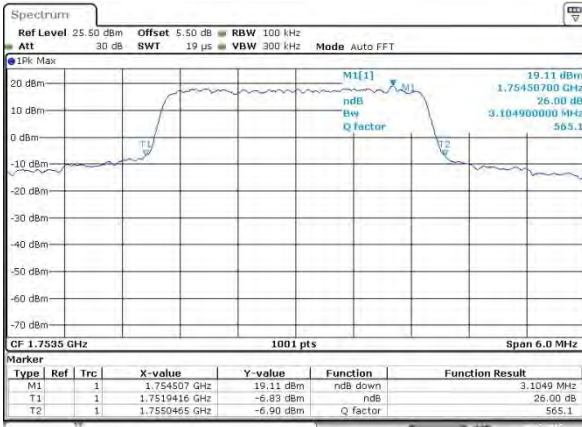

Date: 6 JUL 2015 19:26:38

Highest Channel / 3MHz / 16QAM

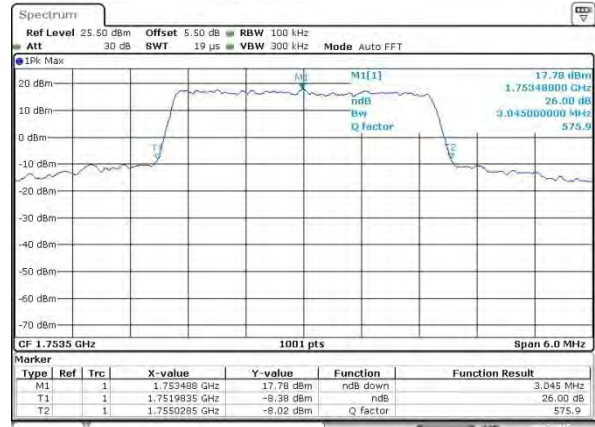

Date: 6 JUL 2015 19:26:51



LTE Band 4

Lowest Channel / 5MHz / QPSK

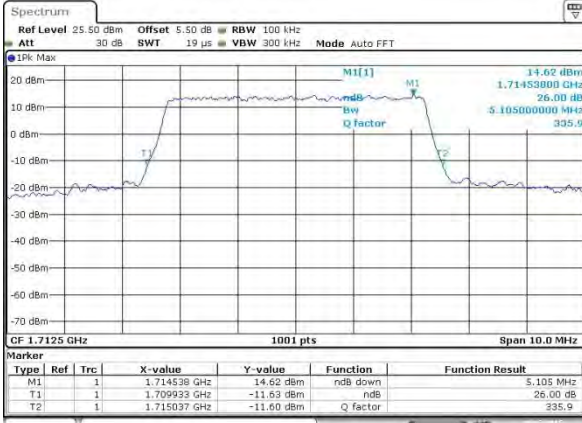

Date: 6 JUL 2015 19:29:47

Lowest Channel / 5MHz / 16QAM

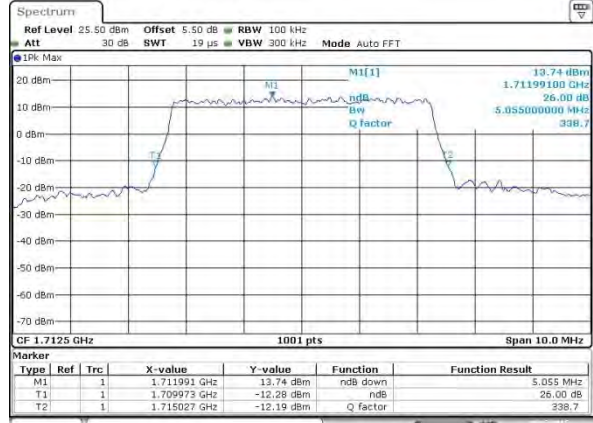

Date: 6 JUL 2015 19:30:00

Middle Channel / 5MHz / QPSK

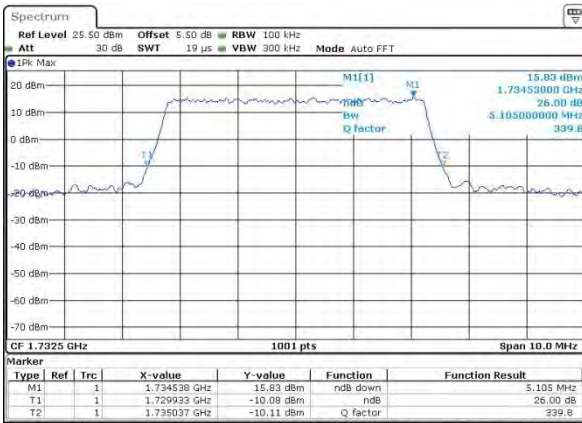

Date: 6 JUL 2015 19:32:56

Middle Channel / 5MHz / 16QAM

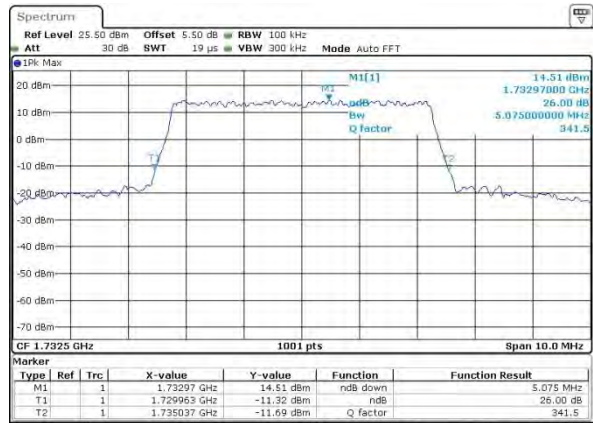

Date: 6 JUL 2015 19:33:06

Highest Channel / 5MHz / QPSK

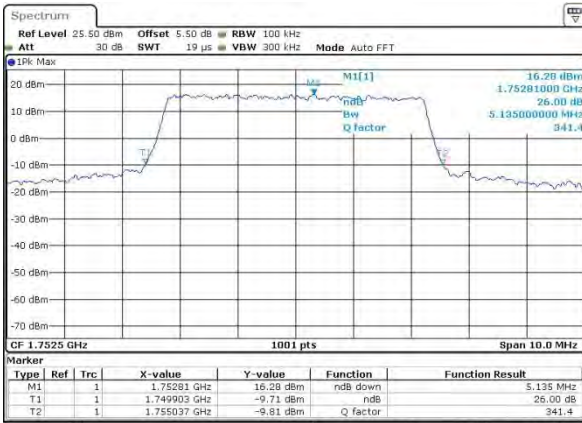

Date: 6 JUL 2015 19:36:04

Highest Channel / 5MHz / 16QAM

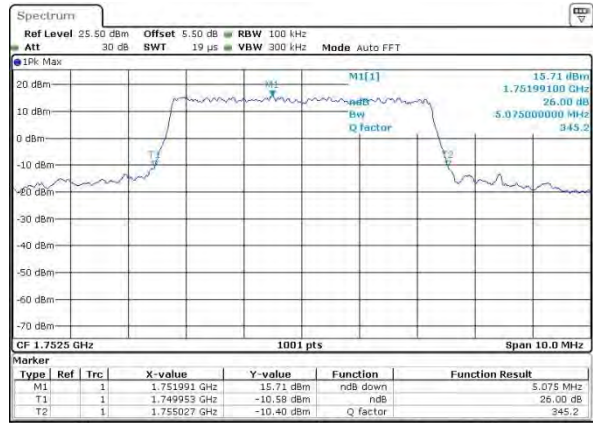

Date: 6 JUL 2015 19:36:17



LTE Band 4

Lowest Channel / 10MHz / QPSK

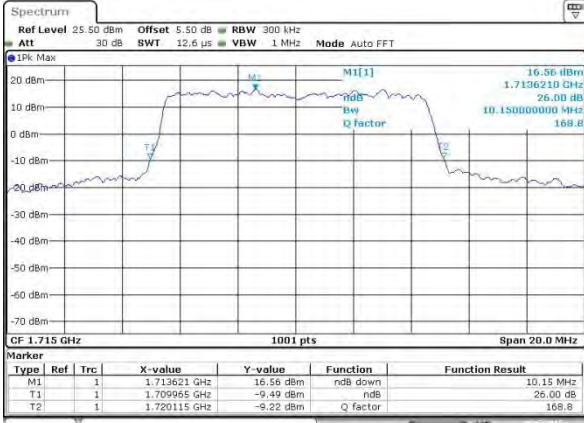

Date: 6 JUL 2015 19:39:13

Lowest Channel / 10MHz / 16QAM



Date: 6 JUL 2015 19:39:25

Middle Channel / 10MHz / QPSK



Date: 6 JUL 2015 19:42:21

Middle Channel / 10MHz / 16QAM

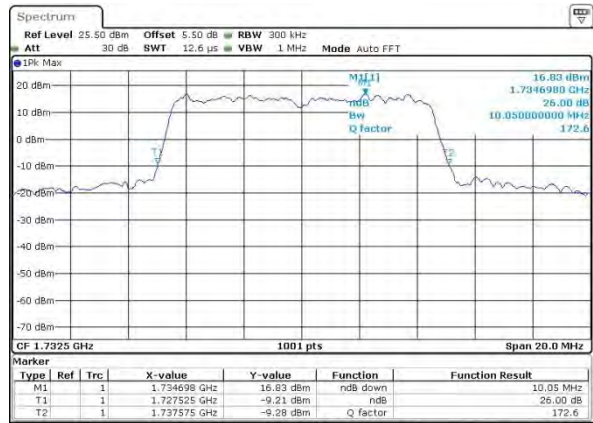

Date: 6 JUL 2015 19:42:34

Highest Channel / 10MHz / QPSK



Date: 6 JUL 2015 19:45:30

Highest Channel / 10MHz / 16QAM

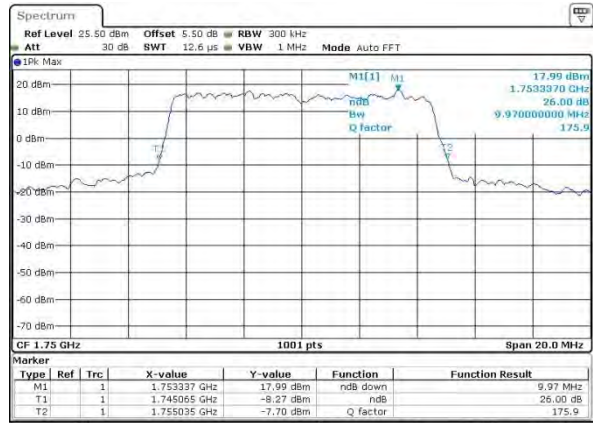

Date: 6 JUL 2015 19:45:43



LTE Band 4

Lowest Channel / 15MHz / QPSK

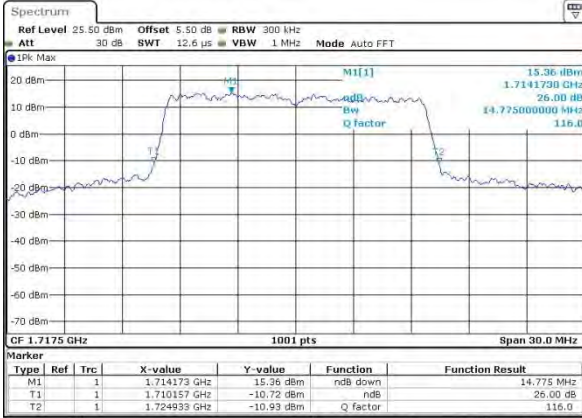

Date: 6 JUL 2015 19:48:38

Lowest Channel / 15MHz / 16QAM

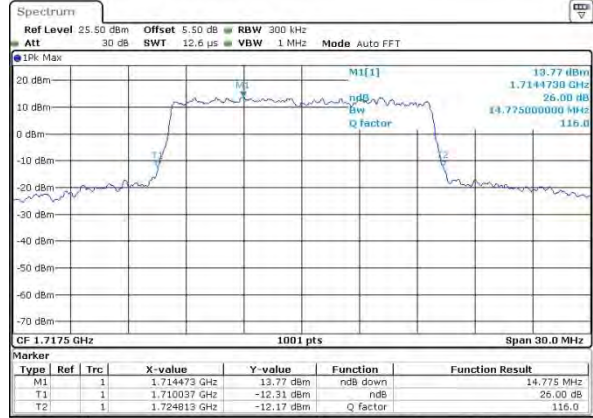

Date: 6 JUL 2015 19:48:51

Middle Channel / 15MHz / QPSK

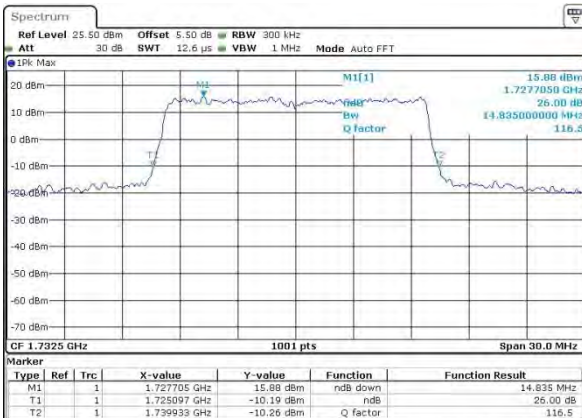

Date: 6 JUL 2015 19:51:47

Middle Channel / 15MHz / 16QAM

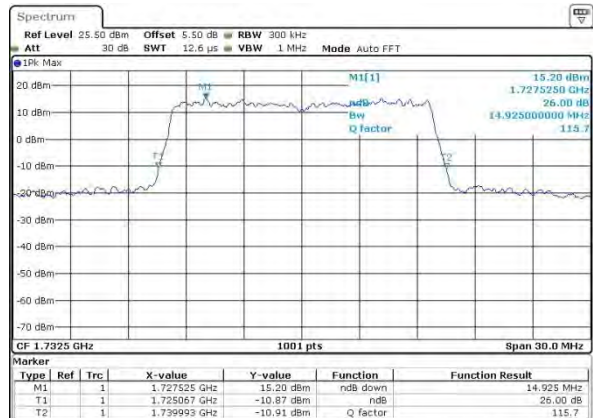

Date: 6 JUL 2015 19:52:00

Highest Channel / 15MHz / QPSK

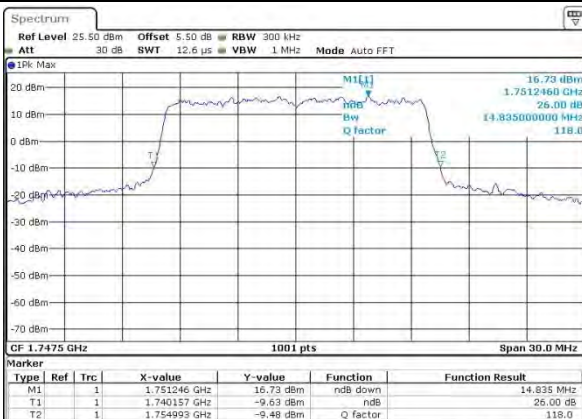

Date: 6 JUL 2015 19:54:56

Highest Channel / 15MHz / 16QAM

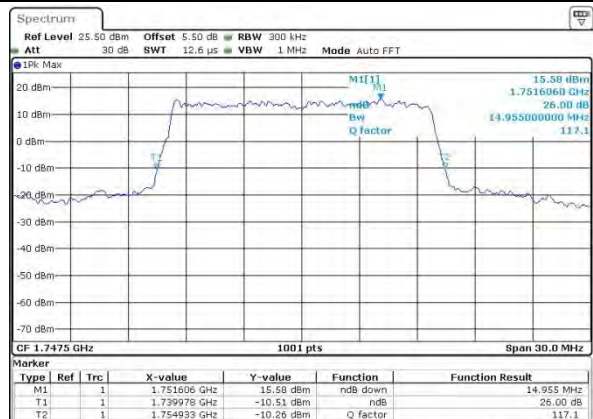

Date: 6 JUL 2015 19:55:08



LTE Band 4

Lowest Channel / 20MHz / QPSK

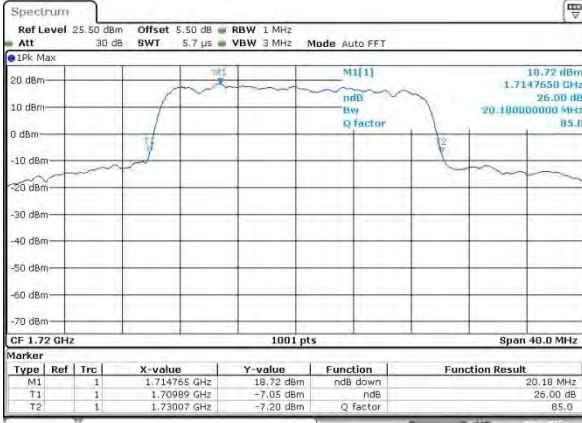

Date: 6 JUL 2015 19:58:04

Lowest Channel / 20MHz / 16QAM

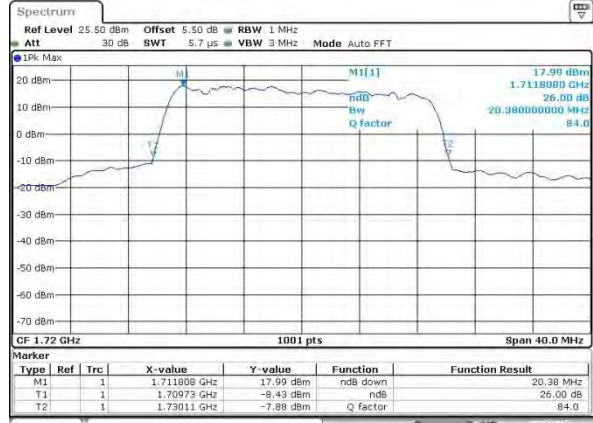

Date: 6 JUL 2015 19:58:17

Middle Channel / 20MHz / QPSK

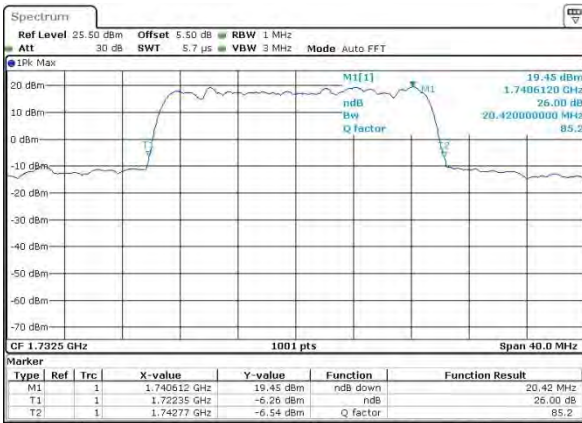

Date: 6 JUL 2015 20:01:13

Middle Channel / 20MHz / 16QAM

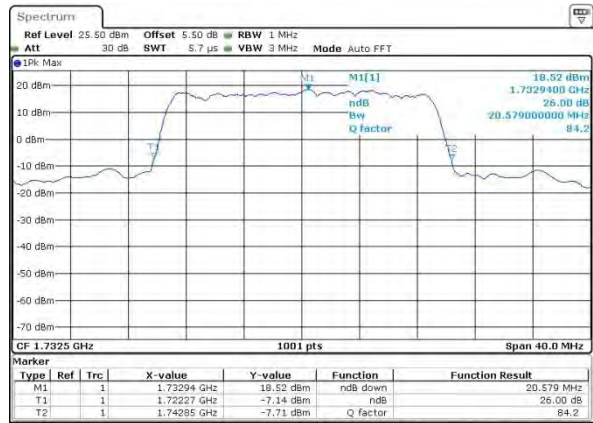

Date: 6 JUL 2015 20:01:25

Highest Channel / 20MHz / QPSK

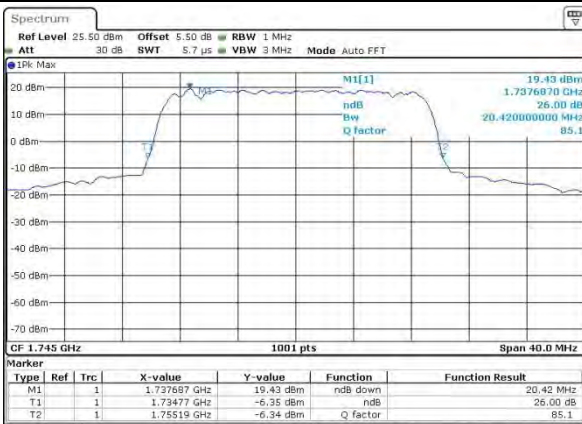

Date: 6 JUL 2015 20:04:21

Highest Channel / 20MHz / 16QAM

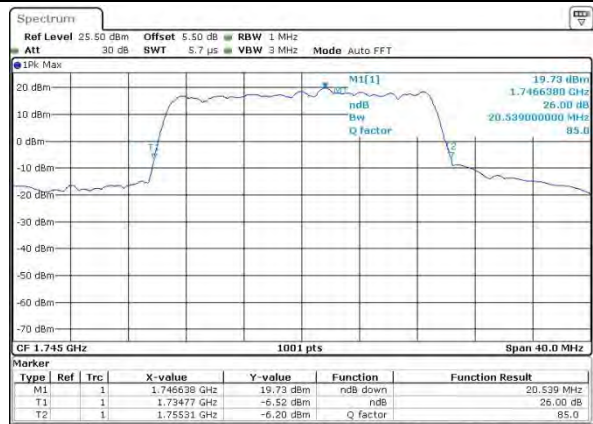

Date: 6 JUL 2015 20:04:34



LTE Band 7

Lowest Channel / 5MHz / QPSK

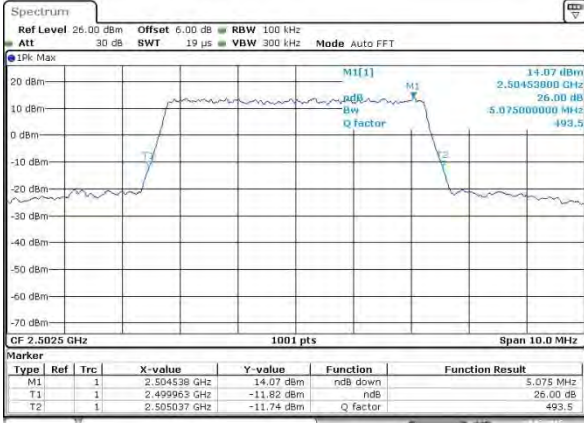

Date: 7 JUL 2015 10:37:16

Lowest Channel / 5MHz / 16QAM

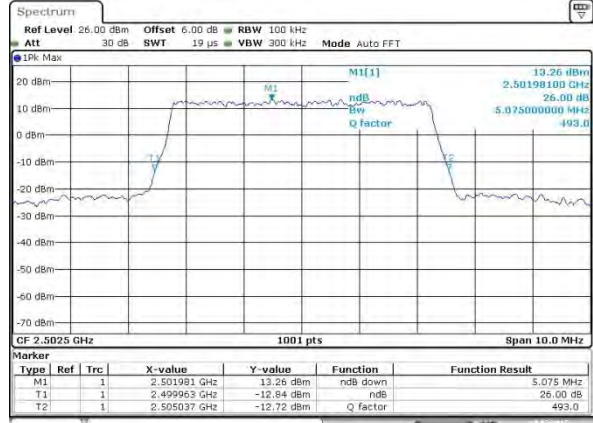

Date: 7 JUL 2015 10:37:31

Middle Channel / 5MHz / QPSK

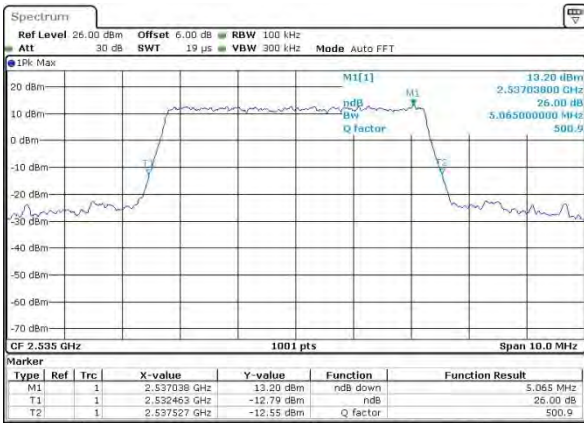

Date: 7 JUL 2015 10:44:56

Middle Channel / 5MHz / 16QAM

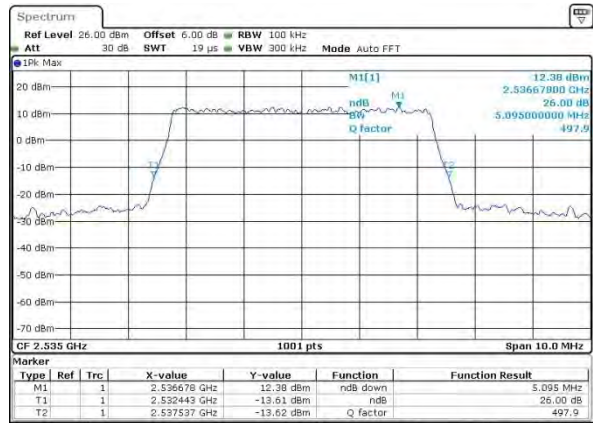

Date: 7 JUL 2015 10:45:06

Highest Channel / 5MHz / QPSK

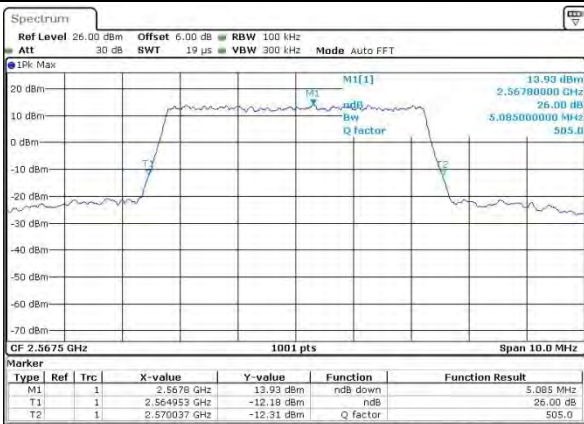

Date: 7 JUL 2015 10:48:00

Highest Channel / 5MHz / 16QAM

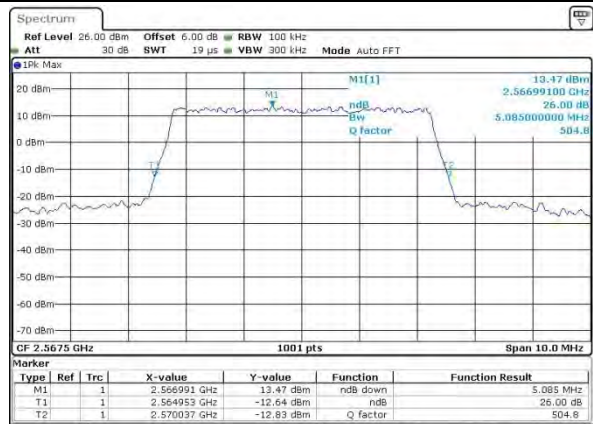

Date: 7 JUL 2015 10:48:13



LTE Band 7

Lowest Channel / 10MHz / QPSK

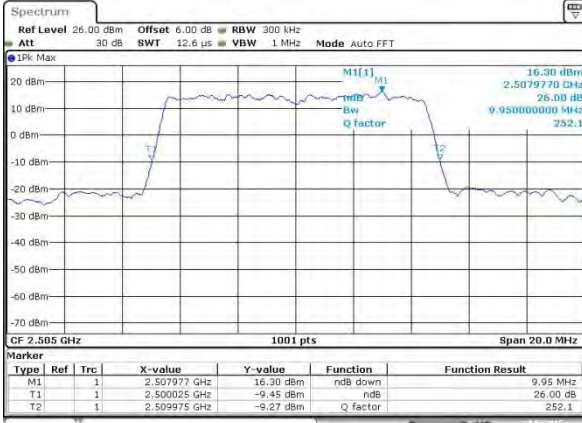

Date 7 JUL 2015 10:55:56

Lowest Channel / 10MHz / 16QAM

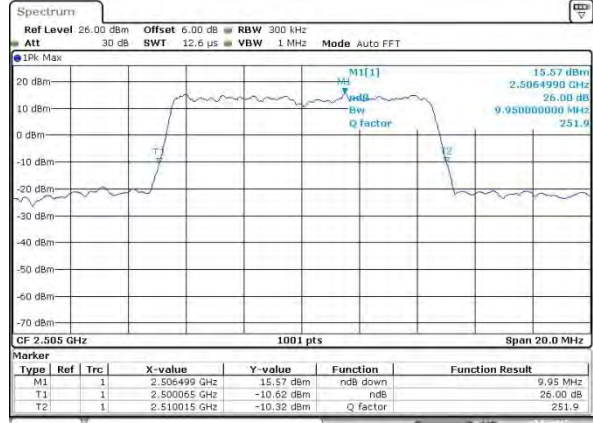

Date 7 JUL 2015 10:56:06

Middle Channel / 10MHz / QPSK

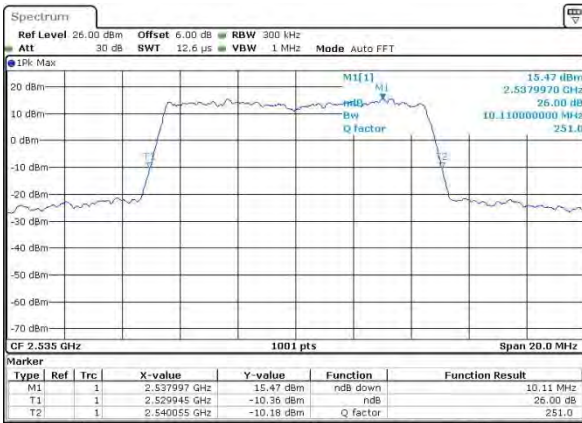

Date 7 JUL 2015 11:03:33

Middle Channel / 10MHz / 16QAM

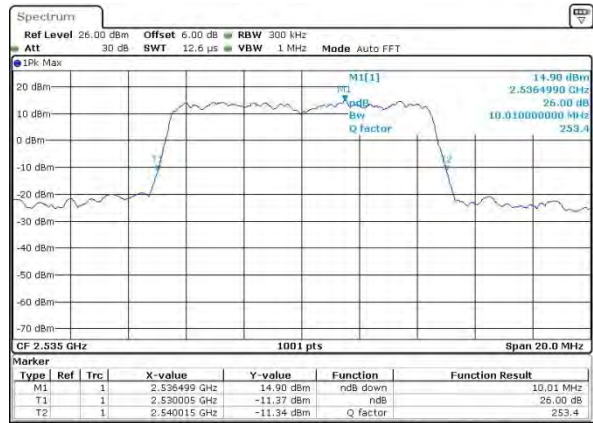

Date 7 JUL 2015 11:03:46

Highest Channel / 10MHz / QPSK

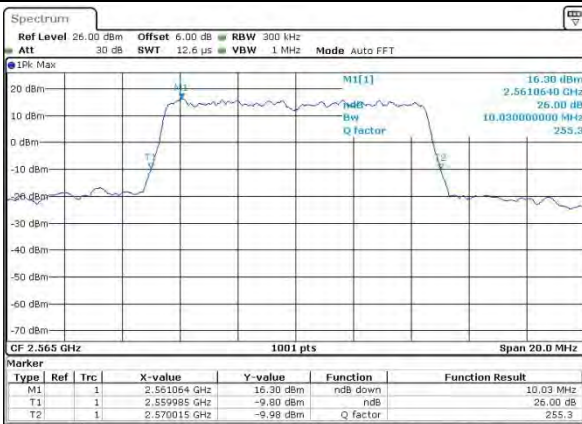

Date 7 JUL 2015 11:06:37

Highest Channel / 10MHz / 16QAM

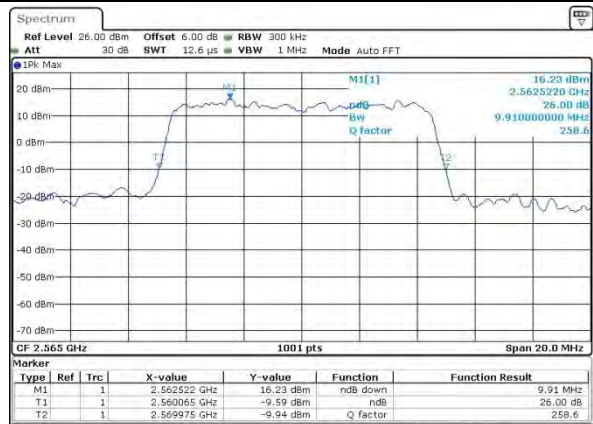

Date 7 JUL 2015 11:06:50



LTE Band 7

Lowest Channel / 15MHz / QPSK

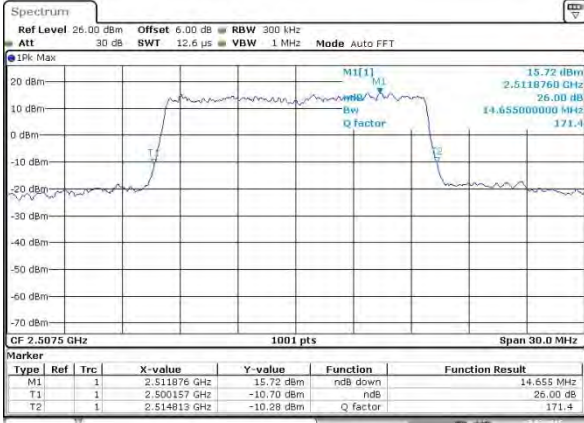

Date: 7 JUL 2015 11:14:16

Lowest Channel / 15MHz / 16QAM

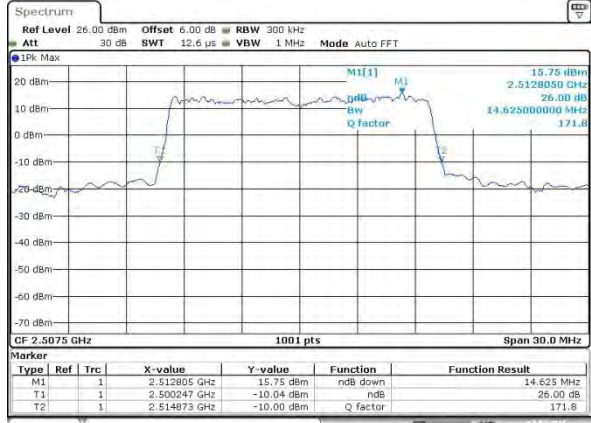

Date: 7 JUL 2015 11:14:28

Middle Channel / 15MHz / QPSK

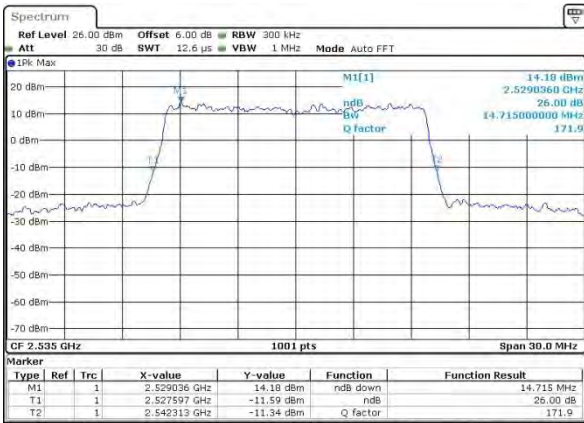

Date: 7 JUL 2015 11:21:54

Middle Channel / 15MHz / 16QAM

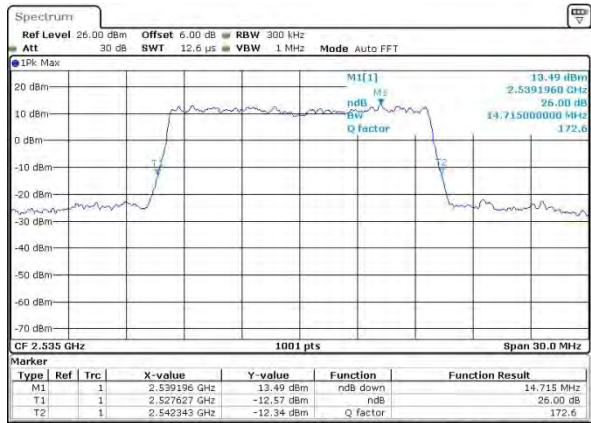

Date: 7 JUL 2015 11:22:06

Highest Channel / 15MHz / QPSK

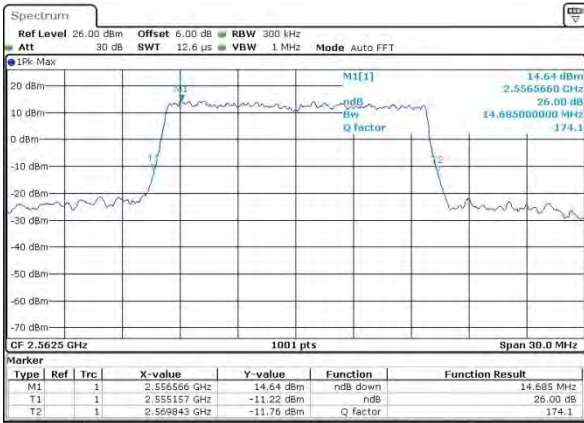

Date: 7 JUL 2015 11:24:56

Highest Channel / 15MHz / 16QAM

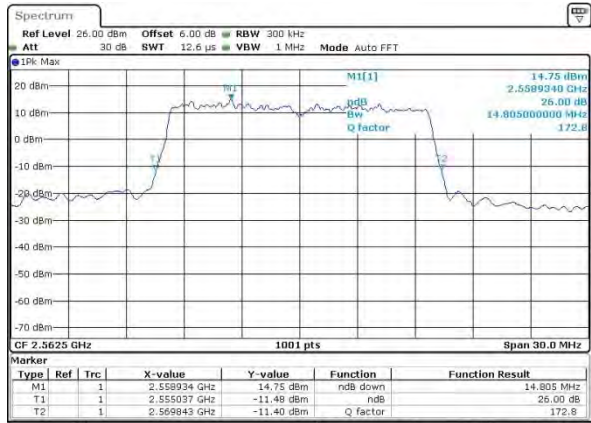

Date: 7 JUL 2015 11:25:11



LTE Band 7

Lowest Channel / 20MHz / QPSK

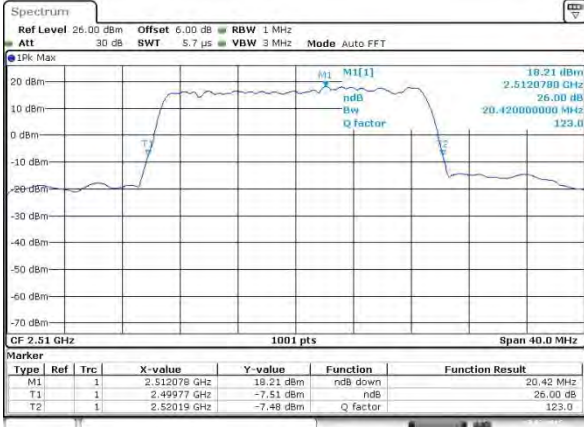

Date: 7 JUL 2015 11:32:37

Lowest Channel / 20MHz / 16QAM

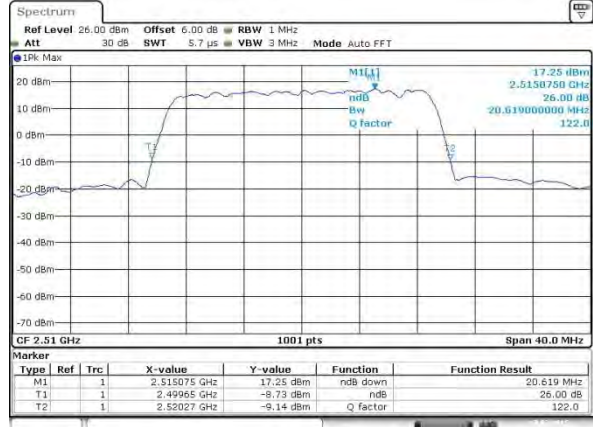

Date: 7 JUL 2015 11:32:49

Middle Channel / 20MHz / QPSK

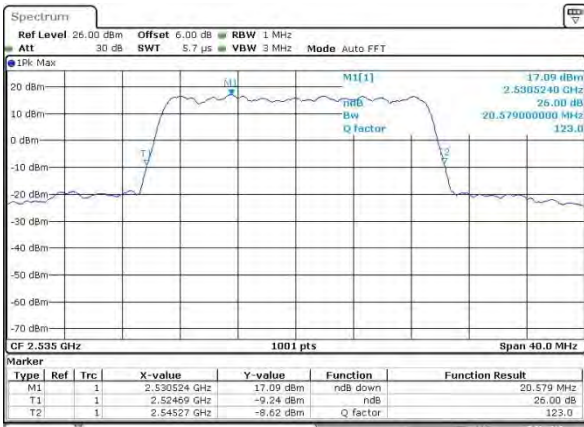

Date: 7 JUL 2015 11:40:15

Middle Channel / 20MHz / 16QAM

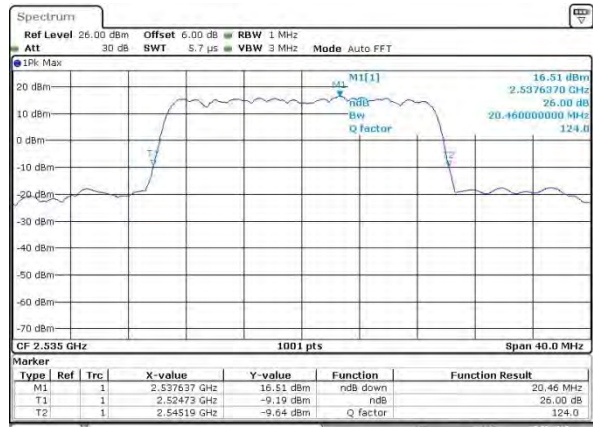

Date: 7 JUL 2015 11:40:27

Highest Channel / 20MHz / QPSK

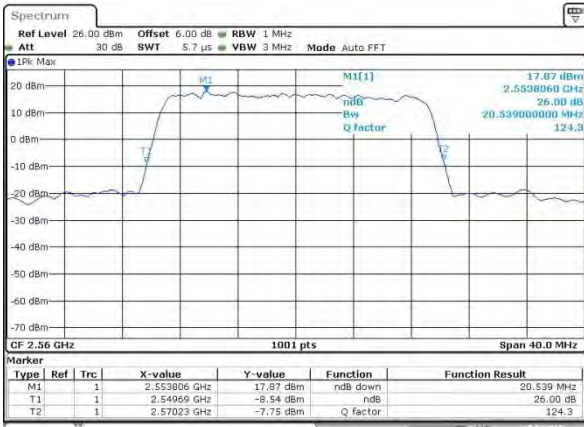

Date: 7 JUL 2015 11:43:19

Highest Channel / 20MHz / 16QAM

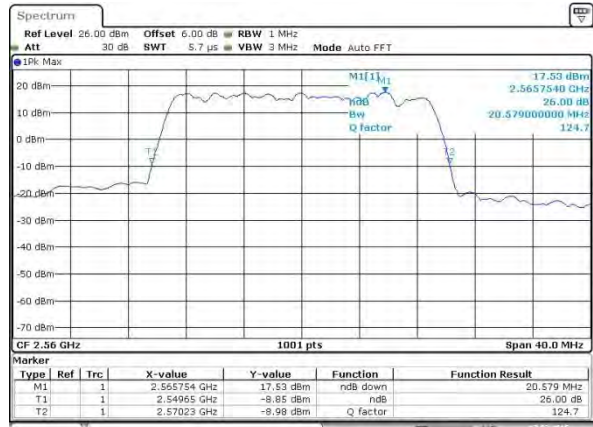

Date: 7 JUL 2015 11:43:31



LTE Band 12

Lowest Channel / 1.4MHz / QPSK

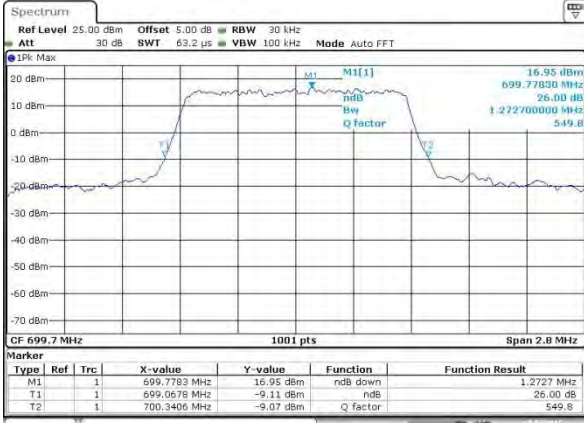

Date: 7 JUL 2015 00:17:56

Lowest Channel / 1.4MHz / 16QAM

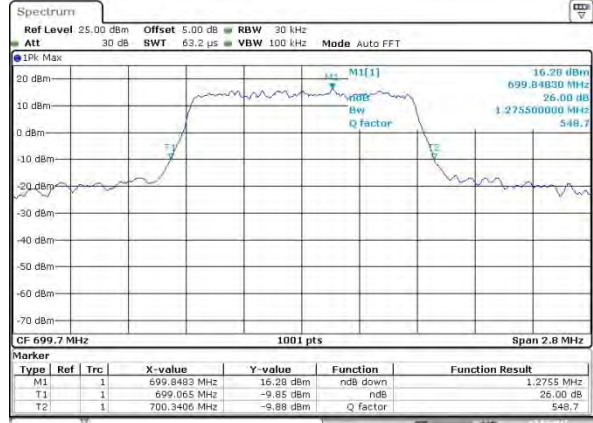

Date: 7 JUL 2015 00:18:08

Middle Channel / 1.4MHz / QPSK

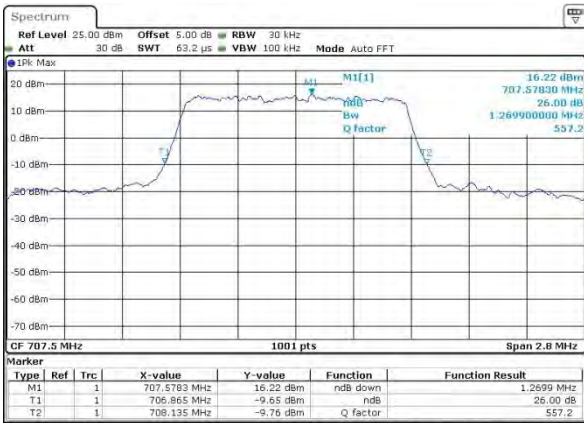

Date: 7 JUL 2015 00:18:33

Middle Channel / 1.4MHz / 16QAM

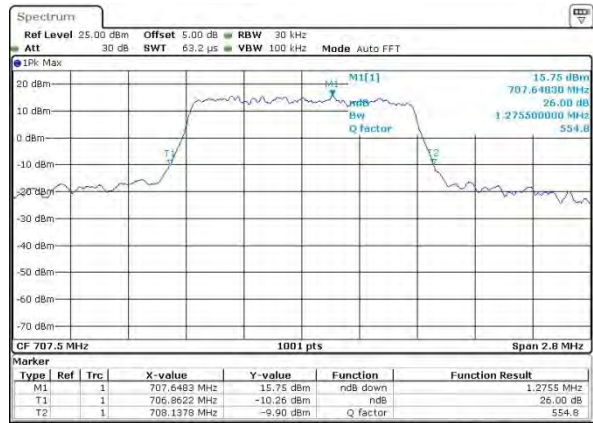

Date: 7 JUL 2015 00:18:20

Highest Channel / 1.4MHz / QPSK

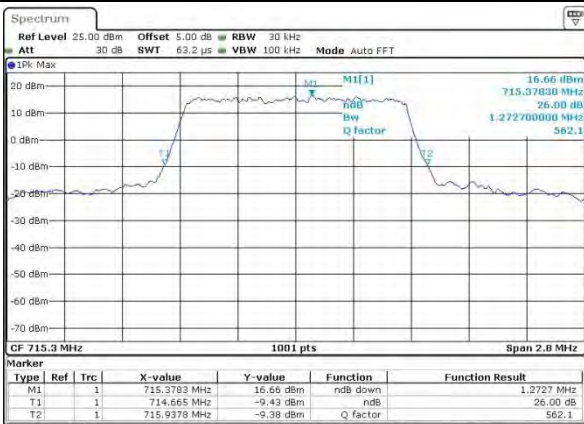

Date: 7 JUL 2015 00:18:45

Highest Channel / 1.4MHz / 16QAM

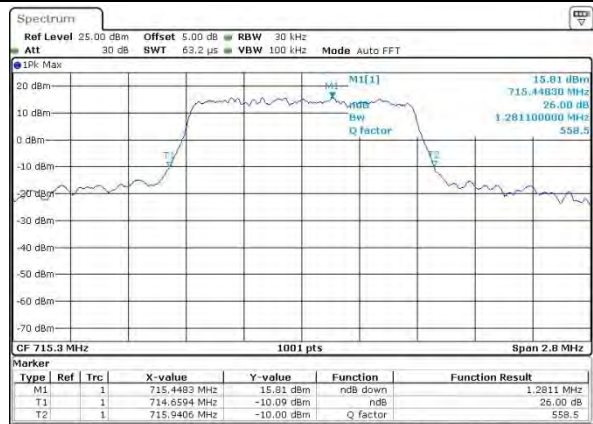

Date: 7 JUL 2015 00:18:58



LTE Band 12

Lowest Channel / 3MHz / QPSK

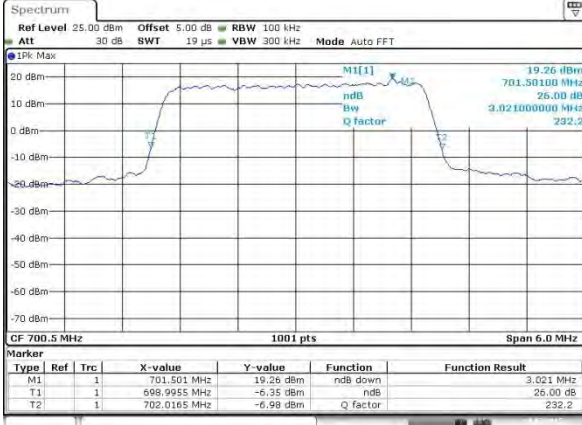

Date: 7 JUL 2015 00:27:30

Lowest Channel / 3MHz / 16QAM

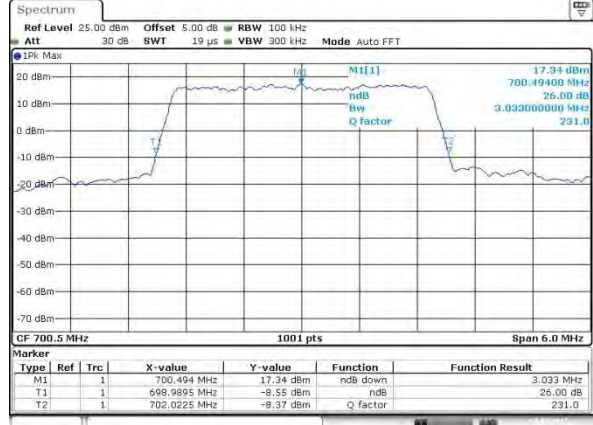

Date: 7 JUL 2015 00:27:18

Middle Channel / 3MHz / QPSK

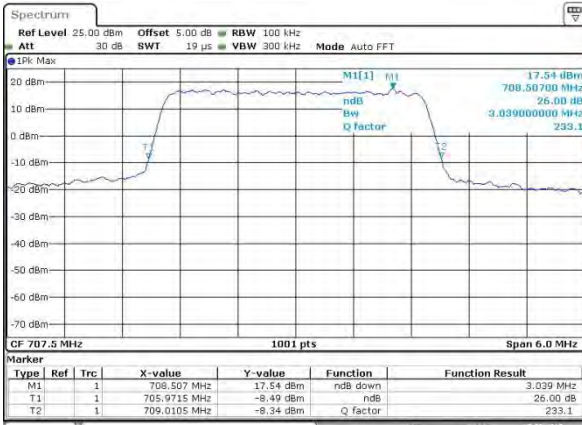

Date: 7 JUL 2015 00:27:43

Middle Channel / 3MHz / 16QAM

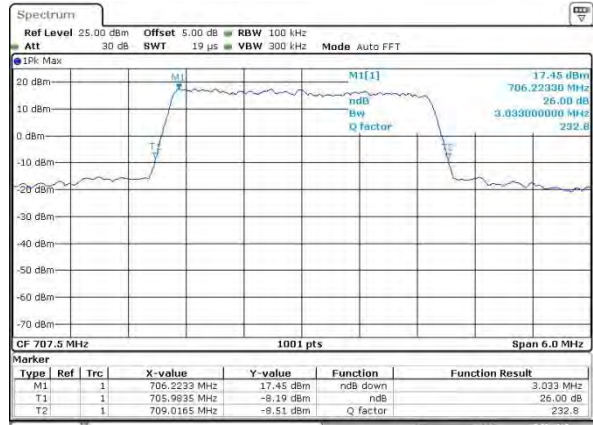

Date: 7 JUL 2015 02:08:02

Highest Channel / 3MHz / QPSK

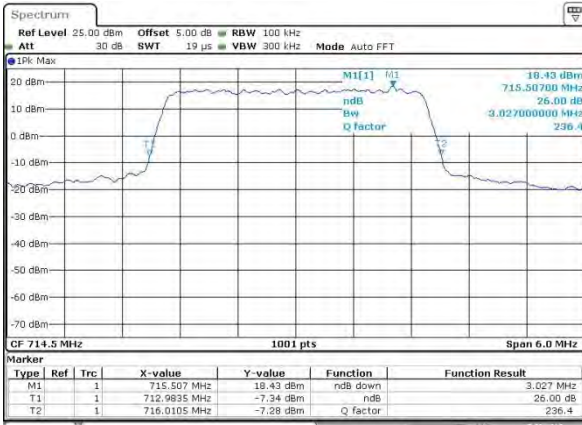

Date: 7 JUL 2015 00:28:21

Highest Channel / 3MHz / 16QAM

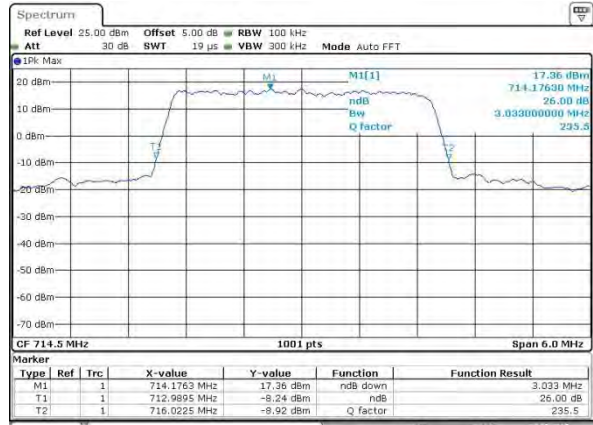

Date: 7 JUL 2015 00:28:08



LTE Band 12

Lowest Channel / 5MHz / QPSK

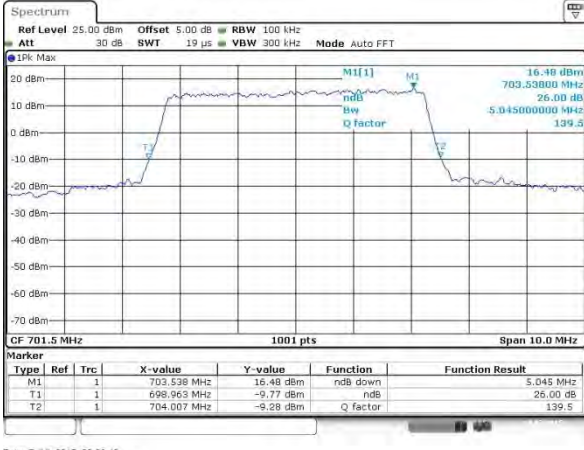

Date: 7 JUL 2015 00:36:40

Lowest Channel / 5MHz / 16QAM

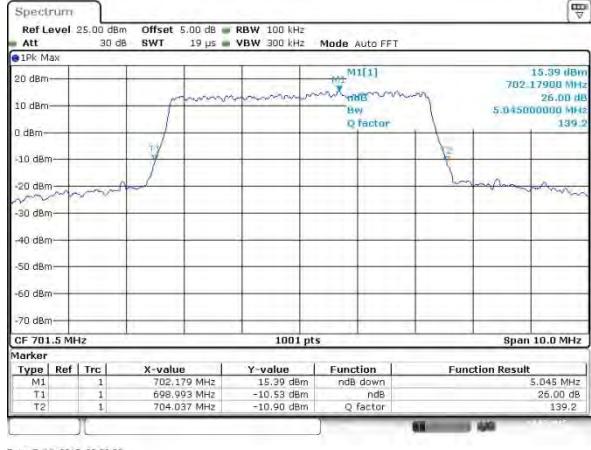

Date: 7 JUL 2015 00:36:53

Middle Channel / 5MHz / QPSK

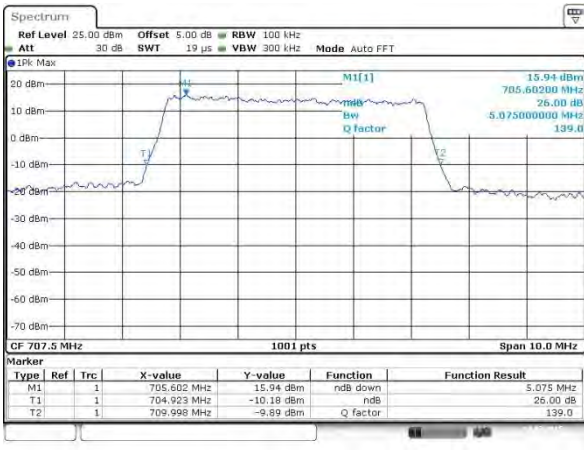

Date: 7 JUL 2015 00:37:18

Middle Channel / 5MHz / 16QAM

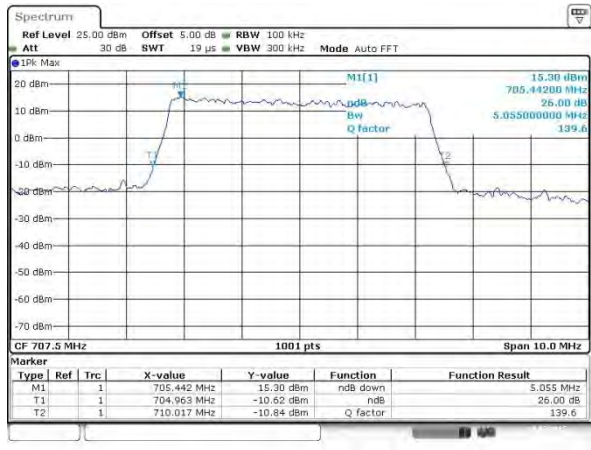

Date: 7 JUL 2015 00:37:05

Highest Channel / 5MHz / QPSK

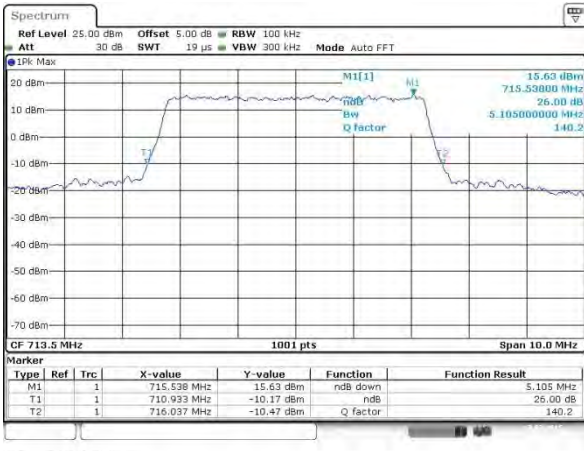

Date: 7 JUL 2015 00:37:31

Highest Channel / 5MHz / 16QAM

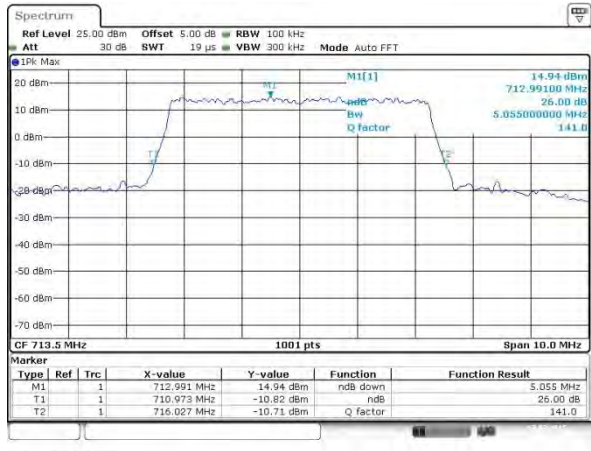

Date: 7 JUL 2015 00:37:43



LTE Band 12

Lowest Channel / 10MHz / QPSK

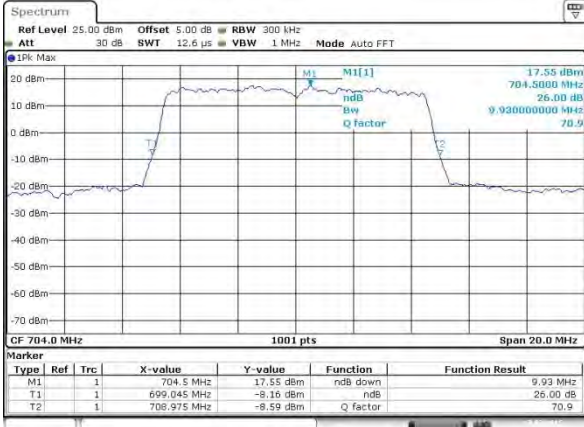

Date: 7 JUL 2015 01:12:05

Lowest Channel / 10MHz / 16QAM

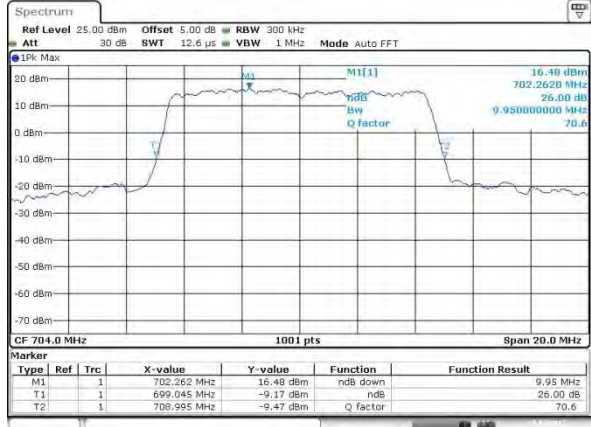

Date: 7 JUL 2015 01:11:52

Middle Channel / 10MHz / QPSK

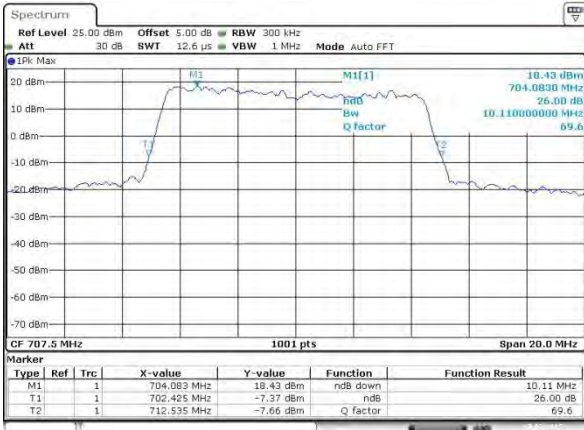

Date: 7 JUL 2015 02:20:57

Middle Channel / 10MHz / 16QAM

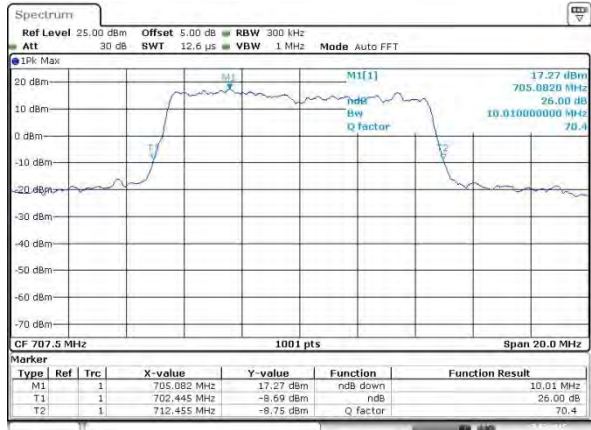

Date: 7 JUL 2015 01:12:30

Highest Channel / 10MHz / QPSK

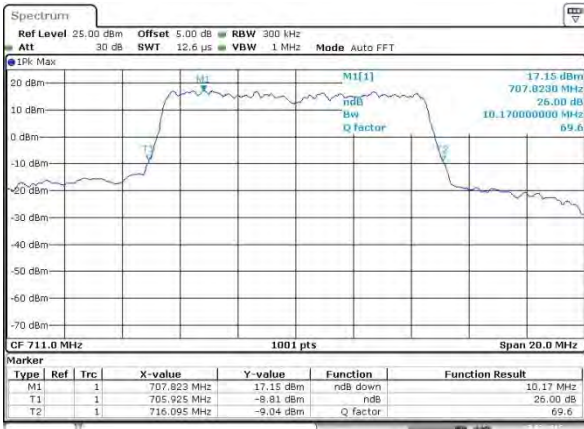

Date: 7 JUL 2015 01:12:55

Highest Channel / 10MHz / 16QAM

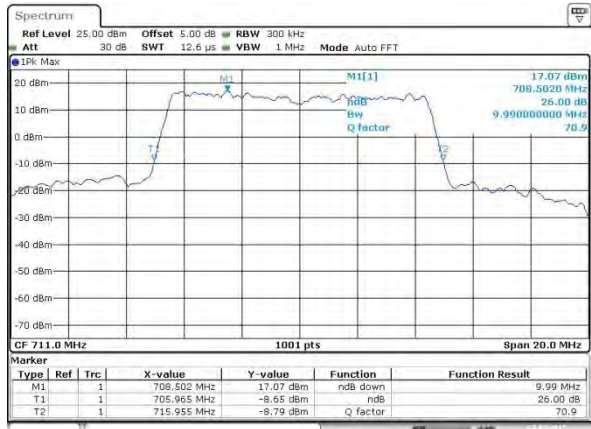

Date: 7 JUL 2015 01:12:43



Occupied Bandwidth

Mode	LTE Band 2 : 99%OBW(MHz)											
	1.4MHz		3MHz		5MHz		10MHz		15MHz		20MHz	
Mod.	QPSK	16QAM	QPSK	16QAM	QPSK	16QAM	QPSK	16QAM	QPSK	16QAM	QPSK	16QAM
Lowest CH	1.09	1.10	2.73	2.72	4.51	4.51	9.07	9.01	13.46	13.49	18.42	18.54
Middle CH	1.10	1.10	2.72	2.72	4.52	4.51	9.05	9.03	13.46	13.46	18.42	18.30
Highest CH	1.10	1.10	2.73	2.72	4.52	4.51	9.05	9.01	13.43	13.43	18.30	18.34

Mode	LTE Band 4 : 99%OBW(MHz)											
	1.4MHz		3MHz		5MHz		10MHz		15MHz		20MHz	
Mod.	QPSK	16QAM	QPSK	16QAM	QPSK	16QAM	QPSK	16QAM	QPSK	16QAM	QPSK	16QAM
Lowest CH	1.09	1.10	2.71	2.72	4.50	4.51	9.05	8.99	13.52	13.46	18.54	18.46
Middle CH	1.10	1.10	2.73	2.72	4.51	4.50	9.13	9.05	13.55	13.49	18.58	18.58
Highest CH	1.10	1.10	2.74	2.72	4.52	4.51	9.09	9.01	13.43	13.46	18.30	18.42

Mode	LTE Band 7 : 99%OBW(MHz)											
	1.4MHz		3MHz		5MHz		10MHz		15MHz		20MHz	
Mod.	QPSK	16QAM	QPSK	16QAM	QPSK	16QAM	QPSK	16QAM	QPSK	16QAM	QPSK	16QAM
Lowest CH	-	-	-	-	4.52	4.51	9.05	9.01	13.46	13.49	18.42	18.46
Middle CH	-	-	-	-	4.51	4.51	9.11	9.03	13.55	13.49	18.46	18.50
Highest CH	-	-	-	-	4.51	4.51	9.11	9.03	13.49	13.46	18.38	18.38

Mode	LTE Band 12 : 99%OBW(MHz)											
	1.4MHz		3MHz		5MHz		10MHz		15MHz		20MHz	
Mod.	QPSK	16QAM	QPSK	16QAM	QPSK	16QAM	QPSK	16QAM	QPSK	16QAM	QPSK	16QAM
Lowest CH	1.09	1.10	2.72	2.73	4.49	4.49	8.99	8.97	-	-	-	-
Middle CH	1.10	1.10	2.72	2.73	4.52	4.51	9.13	9.05	-	-	-	-
Highest CH	1.10	1.10	2.72	2.73	4.51	4.50	9.05	9.07	-	-	-	-



LTE Band 2

Lowest Channel / 1.4MHz / QPSK

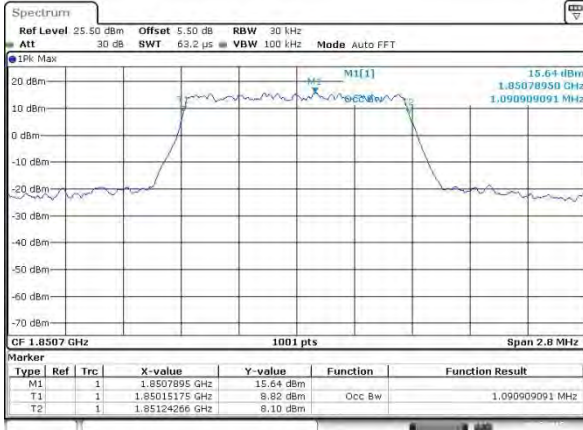

Date: 6 JUL 2015 14:38:08

Lowest Channel / 1.4MHz / 16QAM

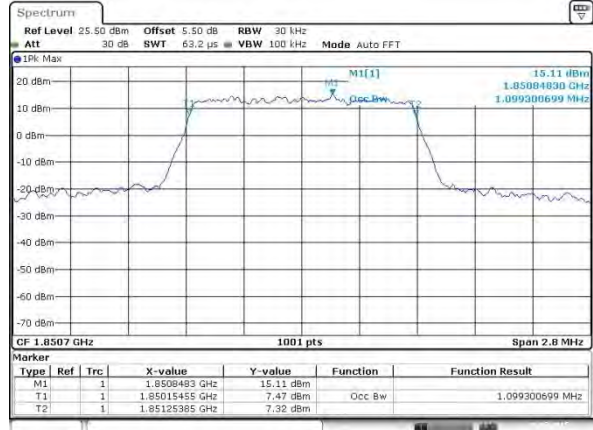

Date: 6 JUL 2015 14:38:18

Middle Channel / 1.4MHz / QPSK

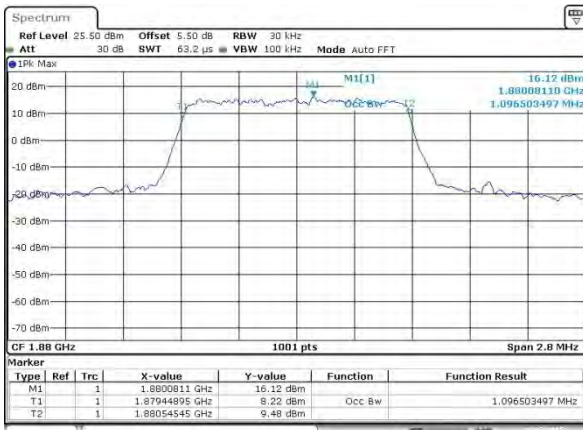

Date: 6 JUL 2015 14:45:51

Middle Channel / 1.4MHz / 16QAM

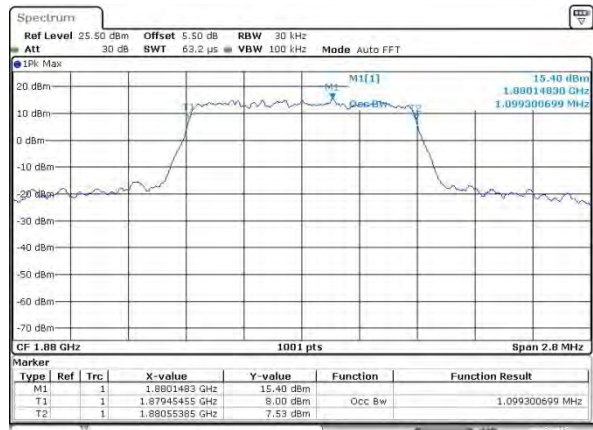

Date: 6 JUL 2015 14:46:01

Highest Channel / 1.4MHz / QPSK

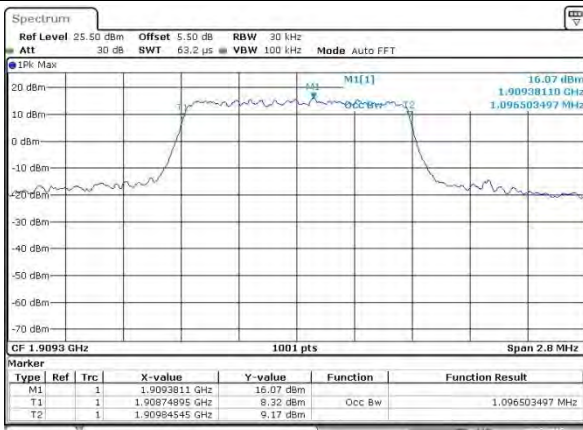

Date: 6 JUL 2015 14:48:58

Highest Channel / 1.4MHz / 16QAM

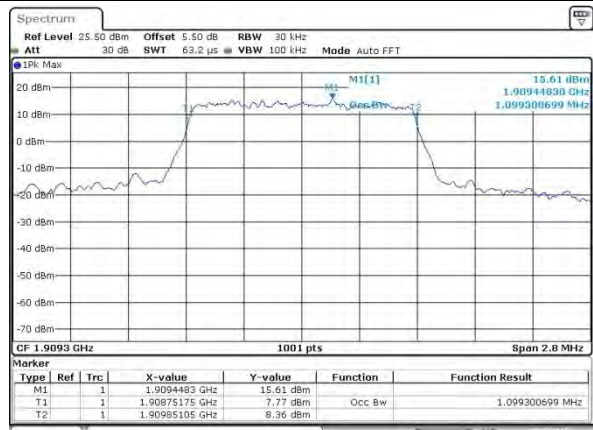

Date: 6 JUL 2015 14:48:10



LTE Band 2

Lowest Channel / 3MHz / QPSK

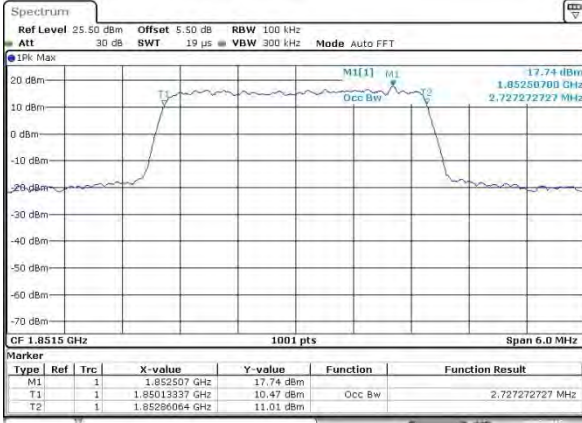

Date: 6 JUL 2015 14:56:41

Lowest Channel / 3MHz / 16QAM

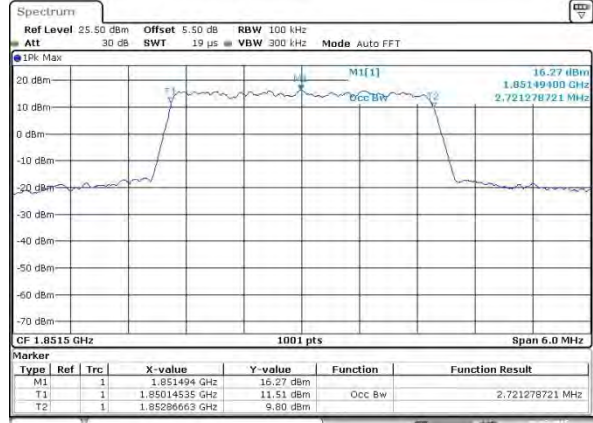

Date: 6 JUL 2015 14:56:52

Middle Channel / 3MHz / QPSK

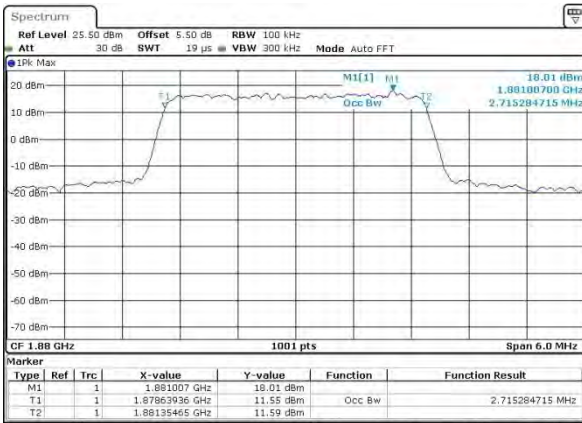

Date: 6 JUL 2015 15:04:24

Middle Channel / 3MHz / 16QAM

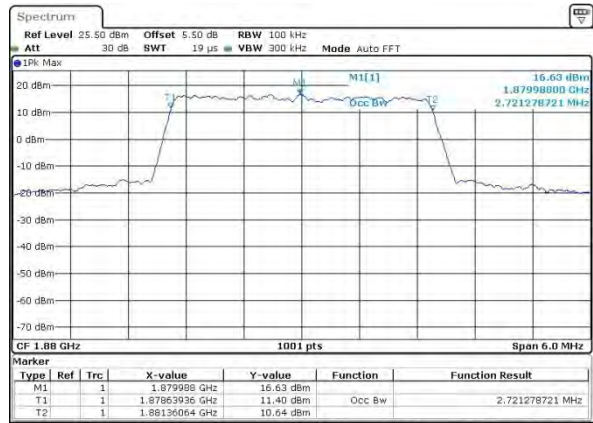

Date: 6 JUL 2015 15:04:36

Highest Channel / 3MHz / QPSK

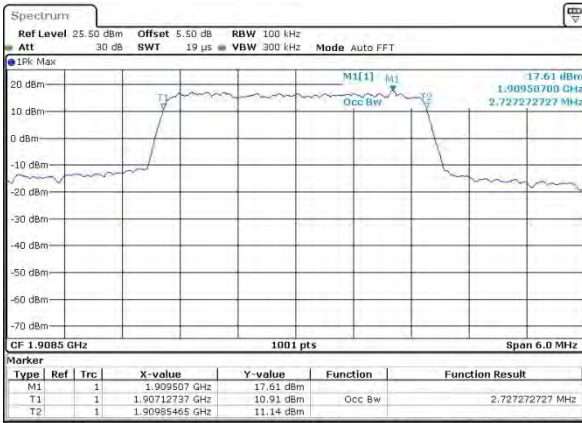

Date: 6 JUL 2015 15:07:32

Highest Channel / 3MHz / 16QAM

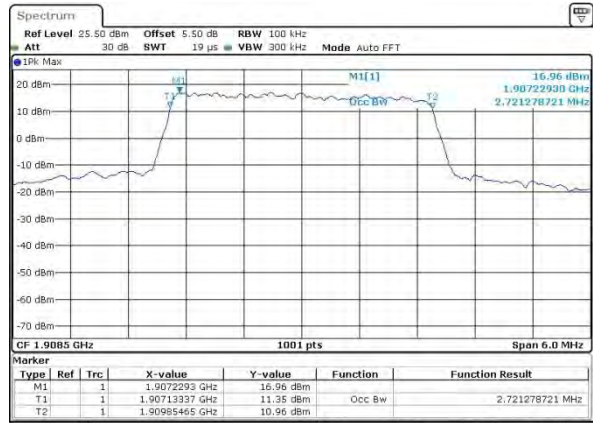

Date: 6 JUL 2015 15:07:43



LTE Band 2

Lowest Channel / 5MHz / QPSK

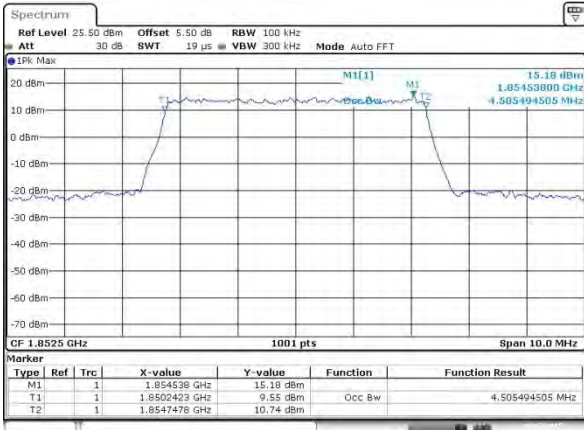

Date: 6 JUL 2015 15:15:52

Lowest Channel / 5MHz / 16QAM

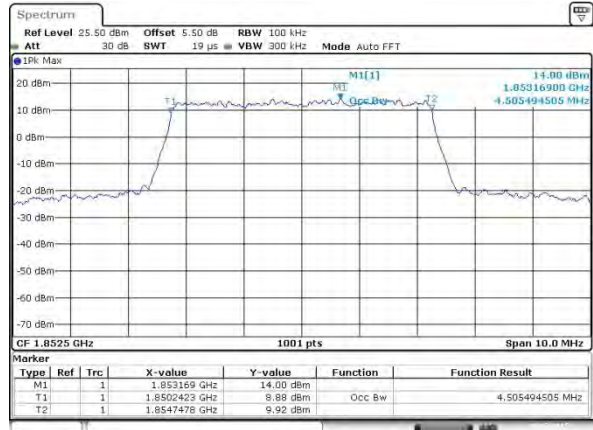

Date: 6 JUL 2015 15:16:02

Middle Channel / 5MHz / QPSK

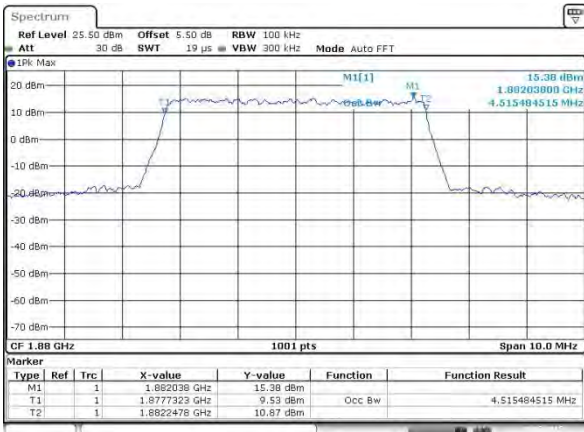

Date: 6 JUL 2015 15:23:34

Middle Channel / 5MHz / 16QAM

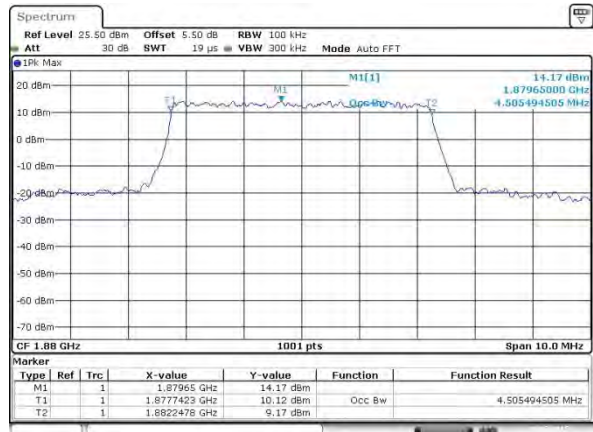

Date: 6 JUL 2015 15:23:45

Highest Channel / 5MHz / QPSK

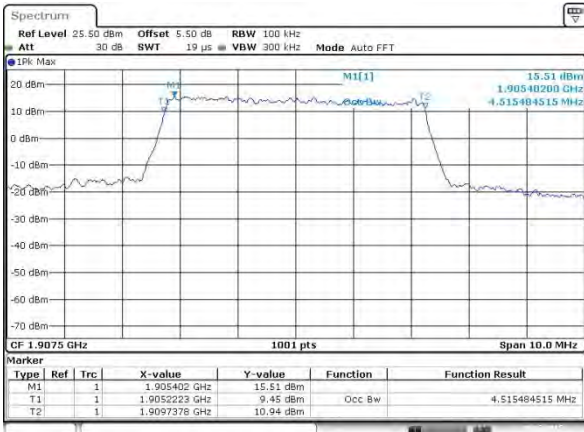

Date: 6 JUL 2015 15:26:42

Highest Channel / 5MHz / 16QAM

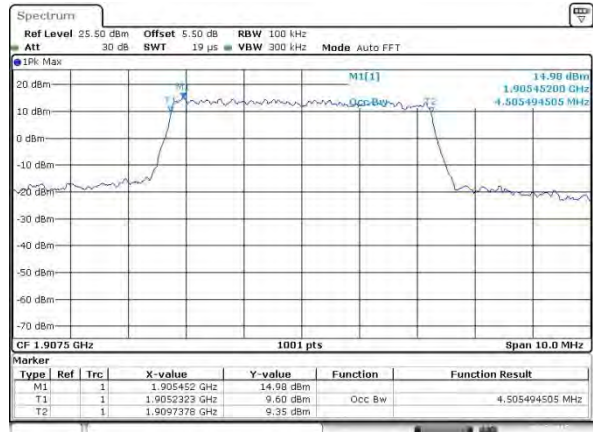

Date: 6 JUL 2015 15:26:53



LTE Band 2

Lowest Channel / 10MHz / QPSK

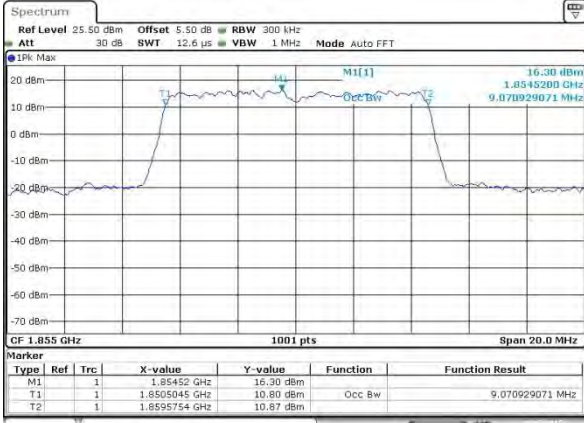

Date: 6 JUL 2015 15:34:26

Lowest Channel / 10MHz / 16QAM

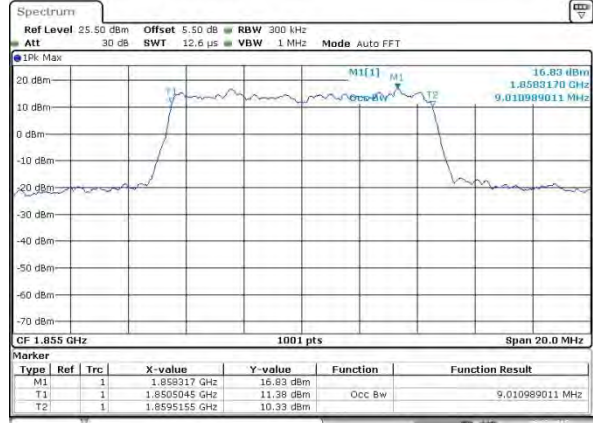

Date: 6 JUL 2015 15:34:36

Middle Channel / 10MHz / QPSK

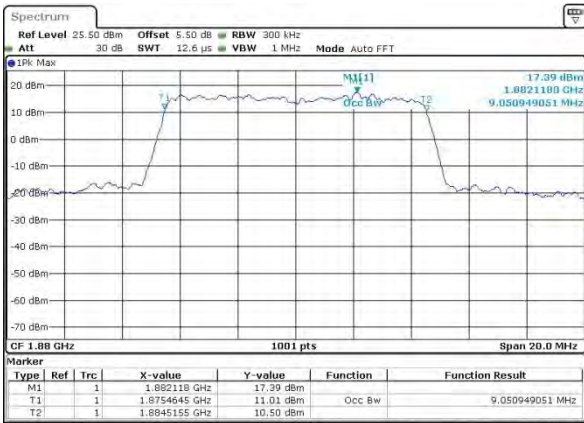

Date: 6 JUL 2015 15:42:08

Middle Channel / 10MHz / 16QAM

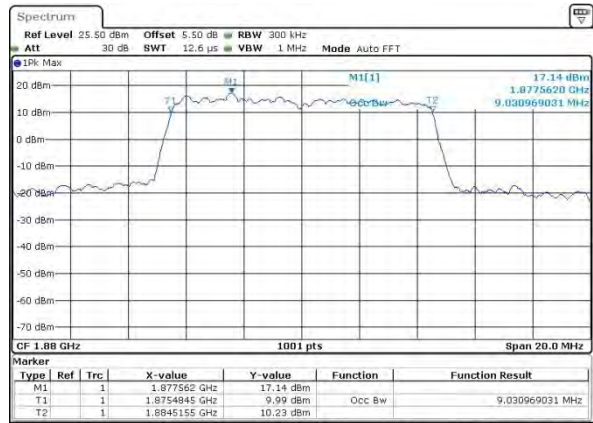

Date: 6 JUL 2015 15:42:18

Highest Channel / 10MHz / QPSK

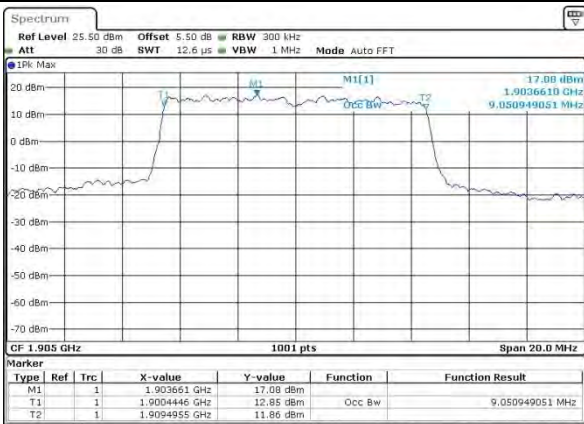

Date: 6 JUL 2015 15:45:16

Highest Channel / 10MHz / 16QAM

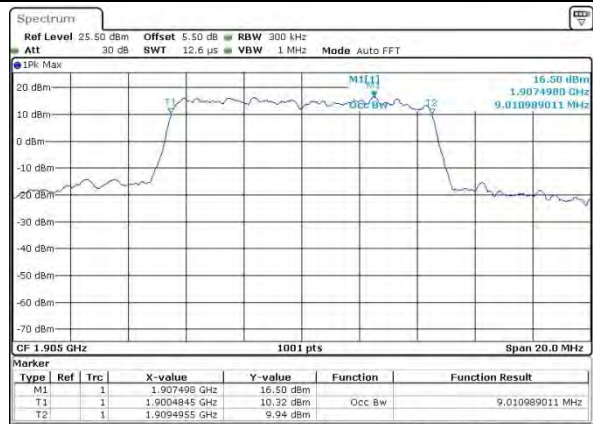

Date: 6 JUL 2015 15:45:27



LTE Band 2

Lowest Channel / 15MHz / QPSK

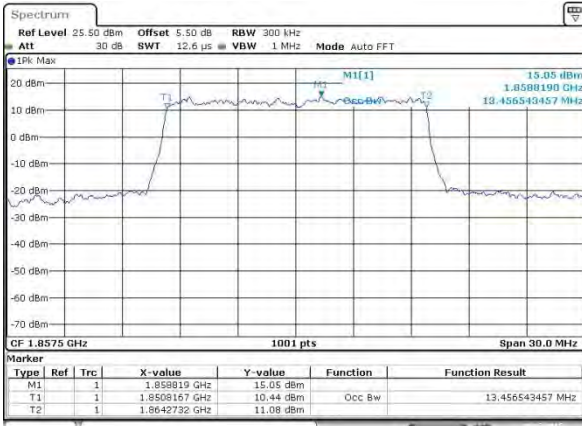

Date: 6 JUL 2015 15:52:56

Lowest Channel / 15MHz / 16QAM

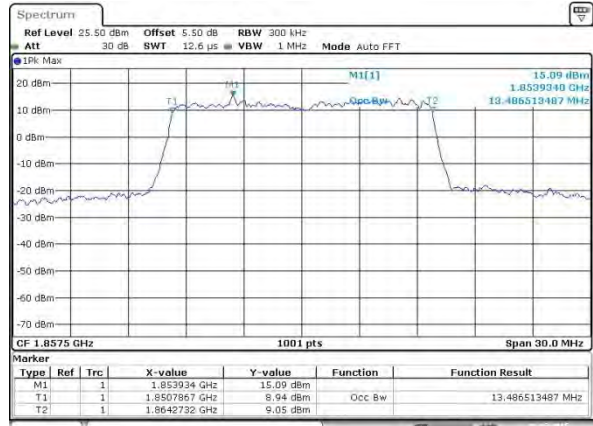

Date: 6 JUL 2015 15:53:09

Middle Channel / 15MHz / QPSK

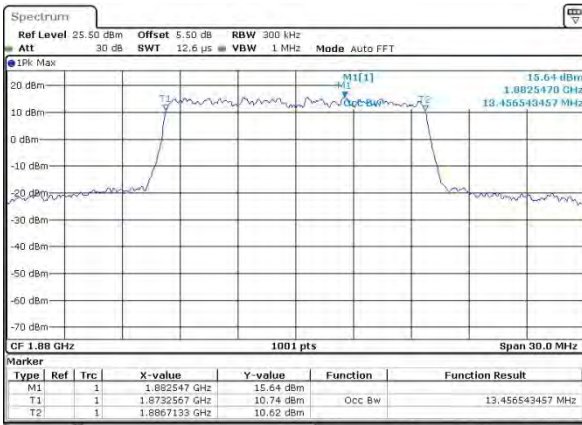

Date: 6 JUL 2015 16:00:41

Middle Channel / 15MHz / 16QAM

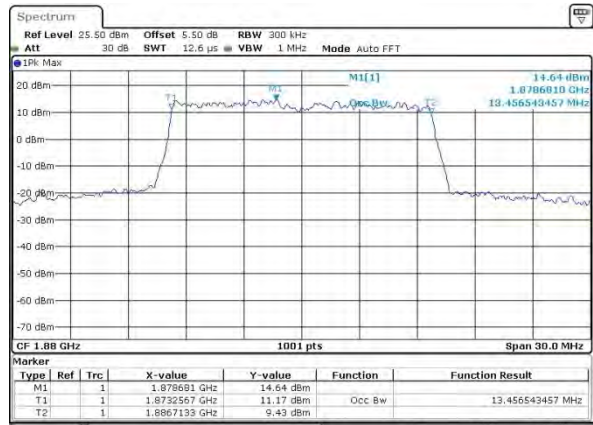

Date: 6 JUL 2015 16:00:52

Highest Channel / 15MHz / QPSK

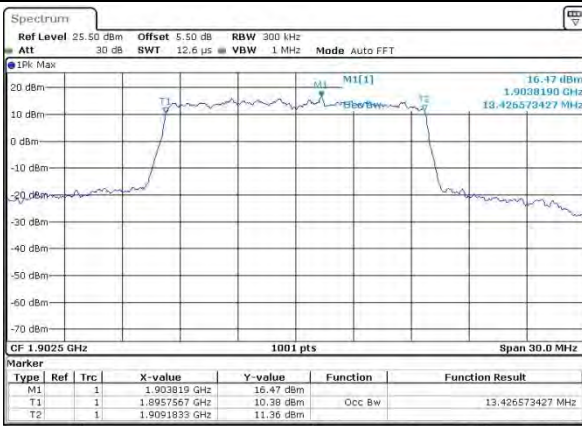

Date: 6 JUL 2015 16:03:50

Highest Channel / 15MHz / 16QAM

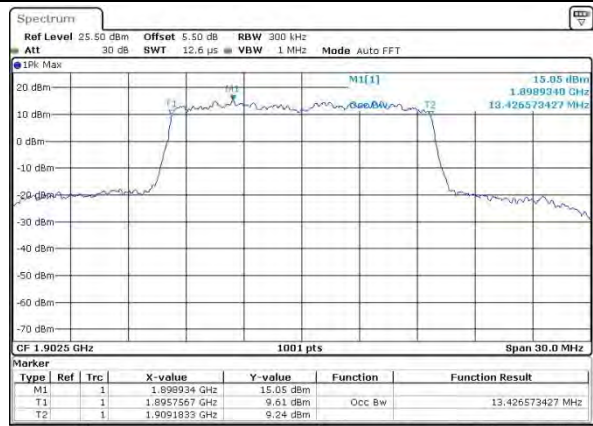

Date: 6 JUL 2015 16:04:00



LTE Band 2

Lowest Channel / 20MHz / QPSK

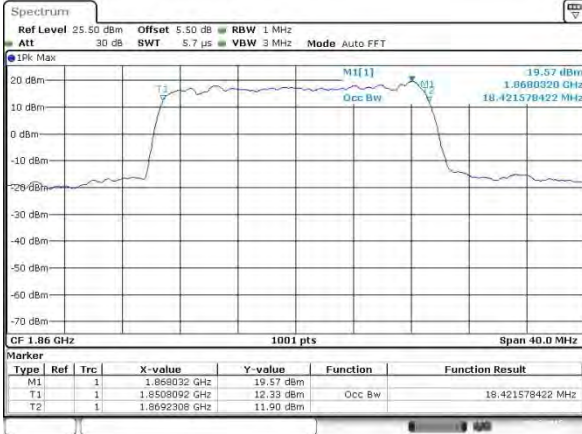

Date: 6 JUL 2015 16:11:33

Lowest Channel / 20MHz / 16QAM

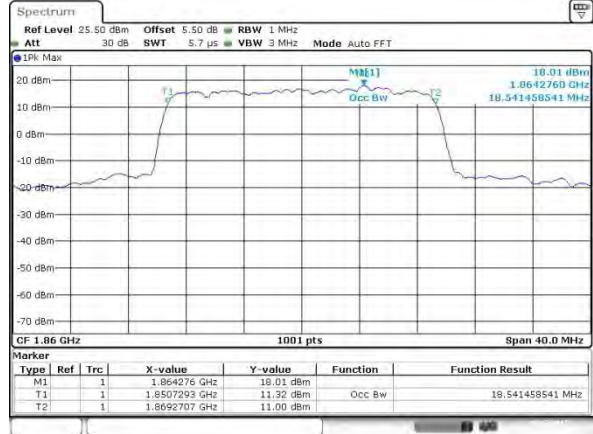

Date: 6 JUL 2015 16:11:44

Middle Channel / 20MHz / QPSK

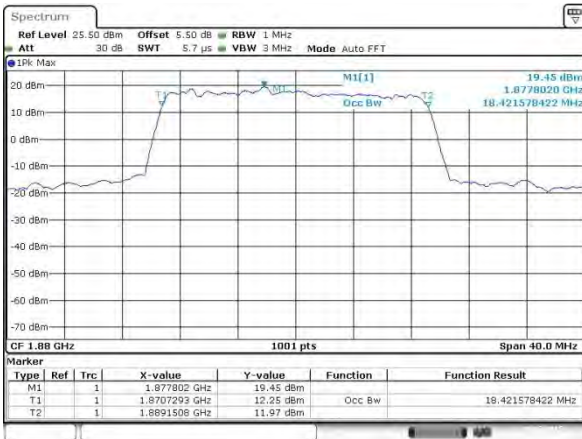

Date: 6 JUL 2015 16:19:16

Middle Channel / 20MHz / 16QAM

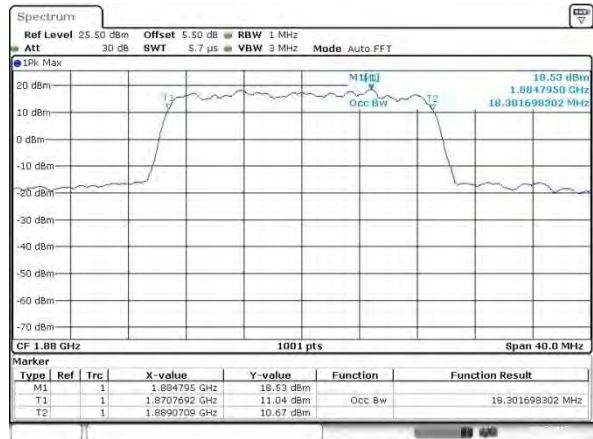

Date: 6 JUL 2015 16:19:26

Highest Channel / 20MHz / QPSK

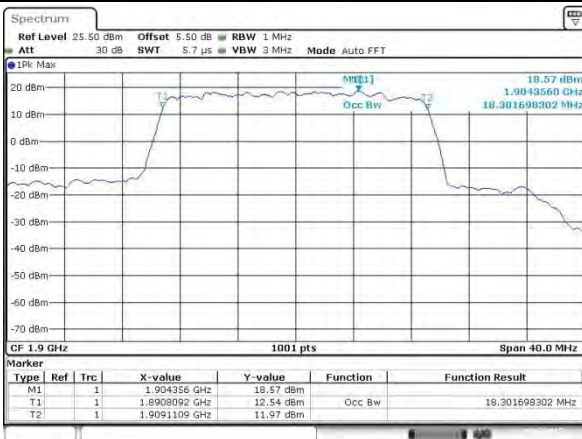

Date: 6 JUL 2015 16:22:24

Highest Channel / 20MHz / 16QAM

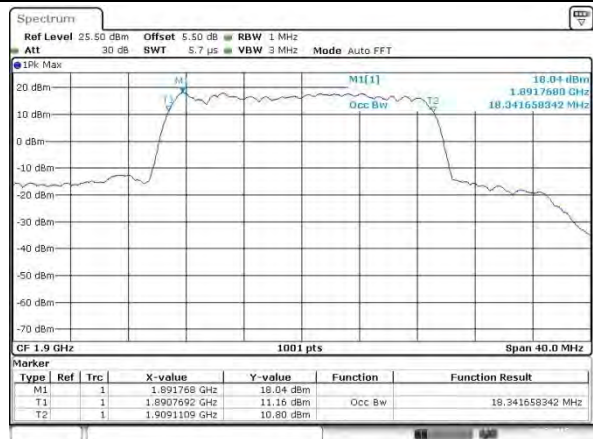

Date: 6 JUL 2015 16:22:35