



# FCC RF Test Report

**APPLICANT** : Acer Incorporated  
**EQUIPMENT** : Smart HandHeld  
**BRAND NAME** : Acer  
**MODEL NAME** : Z500  
**FCC ID** : HLZDMZ500  
**STANDARD** : FCC 47 CFR Part 2, 22(H), 24(E)  
**CLASSIFICATION** : PCS Licensed Transmitter Held to Ear (PCE)

The product was received on Aug. 04, 2014 and testing was completed on Aug. 19, 2014. We, SPORTON INTERNATIONAL (KUNSHAN) INC., would like to declare that the tested sample has been evaluated in accordance with the test procedures given in ANSI / TIA / EIA-603-C-2004 and has been in compliance with the applicable technical standards.

The test results in this report apply exclusively to the tested model / sample. Without written approval of SPORTON INTERNATIONAL (KUNSHAN) INC., the test report shall not be reproduced except in full.

Reviewed by: Joseph Lin / Supervisor

Approved by: Jones Tsai / Manager



**SPORTON INTERNATIONAL (KUNSHAN) INC.**  
No. 3-2, PingXiang Road, Kunshan, Jiangsu Province, P.R.C.



# TABLE OF CONTENTS

**REVISION HISTORY..... 3**

**SUMMARY OF TEST RESULT ..... 4**

**1 GENERAL DESCRIPTION ..... 5**

    1.1 Applicant..... 5

    1.2 Manufacturer ..... 5

    1.3 Product Feature of Equipment Under Test ..... 5

    1.4 Product Specification subjective to this standard..... 6

    1.5 Modification of EUT ..... 7

    1.6 Maximum ERP/EIRP Power, Frequency Tolerance, and Emission Designator ..... 7

    1.7 Testing Location ..... 7

    1.8 Applicable Standards ..... 8

**2 TEST CONFIGURATION OF EQUIPMENT UNDER TEST ..... 9**

    2.1 Test Mode..... 9

    2.2 Connection Diagram of Test System ..... 12

    2.3 Support Unit used in test configuration ..... 13

    2.4 Measurement Results Explanation Example ..... 13

**3 TEST RESULT ..... 14**

    3.1 Conducted Output Power Measurement..... 14

    3.2 Peak-to-Average Ratio ..... 16

    3.3 Effective Radiated Power and Effective Isotropic Radiated Power Measurement ..... 24

    3.4 99% Occupied Bandwidth and 26dB Bandwidth Measurement..... 30

    3.5 Band Edge Measurement..... 50

    3.6 Conducted Spurious Emission Measurement..... 63

    3.7 Field Strength of Spurious Radiation Measurement ..... 109

    3.8 Frequency Stability Measurement..... 129

**4 LIST OF MEASURING EQUIPMENT ..... 134**

**5 UNCERTAINTY OF EVALUATION ..... 135**

**APPENDIX A. SETUP PHOTOGRAPHS**





## SUMMARY OF TEST RESULT

Report Section	FCC Rule	IC Rule	Description	Limit	Result	Remark
3.1	§2.1046	RSS-132 (5.4) RSS-133 (6.4)	Conducted Output Power	N/A	PASS	-
3.2	§24.232(d)	RSS-132 (5.4) RSS-133(6.4)	Peak-to-Average Ratio	<13 dB	PASS	-
3.3	§22.913(a)(2)	RSS-132(5.4) SRSP-503(5.1.3)	Effective Radiated Power	< 7 Watts	PASS	-
3.3	§24.232(c)	RSS-133 (6.4) SRSP-510(5.1.2)	Equivalent Isotropic Radiated Power	< 2 Watts	PASS	-
3.4	§2.1049 §22.917(b) §24.238(b)	RSS-GEN(4.6.1) RSS-133(2.3)	Occupied Bandwidth	N/A	PASS	-
3.5	§2.1051 §22.917(a) §24.238(a)	RSS-132 (5.5) RSS-133 (6.5)	Band Edge Measurement	< 43+10log <sub>10</sub> (P[Watts])	PASS	-
3.6	§2.1051 §22.917(a) §24.238(a)	RSS-132 (5.5) RSS-133 (6.5)	Conducted Spurious Emission	< 43+10log <sub>10</sub> (P[Watts])	PASS	-
3.7	§2.1053 §22.917(a) §24.238(a)	RSS-132 (5.5) RSS-133 (6.5)	Field Strength of Spurious Radiation	< 43+10log <sub>10</sub> (P[Watts])	PASS	Under limit 24.71 dB at 5643.000 MHz
3.8	§2.1055 §22.355 §24.235	RSS-132(5.3) RSS-133(6.3)	Frequency Stability for Temperature & Voltage	< 2.5 ppm	PASS	-



# 1 General Description

## 1.1 Applicant

**Acer Incorporated**

8F., No. 88, Sec. 1, Xintai 5th Rd., Xizhi Dist., New Taipei City 22181, Taiwan (R.O.C.)

## 1.2 Manufacturer

**Compal Communications (Nanjing) Co., Ltd.**

No. 68-2, Suyuan Road, Nanjing Export Processing Zone(South Area), China

## 1.3 Product Feature of Equipment Under Test

Product Feature	
Equipment	Smart HandHeld
Brand Name	Acer
Model Name	Z500
FCC ID	HLZDMZ500
EUT supports Radios application	GSM/GPRS/EGPRS/WCDMA/HSPA/HSPA+(Downlink Only) WLAN2.4GHz 802.11b/g/n HT20/HT40 Bluetooth v3.0+EDR Bluetooth v4.0 LE
EUT Stage	Identical Prototype

**Remark:** The above EUT's information was declared by manufacturer. Please refer to the specifications or user's manual for more detailed description.



### 1.4 Product Specification subjective to this standard

Product Specification subjective to this standard	
<b>Tx Frequency</b>	GSM850: 824.2 MHz ~ 848.8 MHz GSM1900: 1850.2 MHz ~ 1909.8MHz WCDMA Band V: 826.4 MHz ~ 846.6 MHz WCDMA Band II: 1852.4 MHz ~ 1907.6 MHz
<b>Rx Frequency</b>	GSM850: 869.2 MHz ~ 893.8 MHz GSM1900: 1930.2 MHz ~ 1989.8 MHz WCDMA Band V: 871.4 MHz ~ 891.6 MHz WCDMA Band II: 1932.4 MHz ~ 1987.6 MHz
<b>Maximum Output Power to Antenna</b>	GSM850 : 32.07 dBm GSM1900 : 29.30 dBm WCDMA Band V : 23.12 dBm WCDMA Band II : 22.70 dBm
<b>Antenna Type</b>	IFA Antenna
<b>Type of Modulation</b>	GSM: GMSK GPRS: GMSK EDGE: GMSK / 8PSK WCDMA: QPSK (Uplink) HSDPA: QPSK (Uplink) HSUPA: QPSK (Uplink) HSPA+: 16QAM (Downlink Only)



### 1.5 Modification of EUT

No modifications are made to the EUT during all test items.

### 1.6 Maximum ERP/EIRP Power, Frequency Tolerance, and Emission Designator

FCC Rule	System	Type of Modulation	Maximum ERP/EIRP (W)	Frequency Tolerance (ppm)	Emission Designator
Part 22	GSM850 GSM	GMSK	1.1324	0.03 ppm	250KGXW
Part 22	GSM850 EDGE class 8	8PSK	0.3624	0.02 ppm	250KG7W
Part 22	WCDMA Band V RMC 12.2Kbps	QPSK	0.1064	0.02 ppm	4M16F9W
Part 24	GSM1900 GSM	GMSK	1.5812	0.01 ppm	246KGXW
Part 24	GSM1900 EDGE class 8	8PSK	0.5715	0.01 ppm	248KG7W
Part 24	WCDMA Band II RMC 12.2Kbps	QPSK	0.3133	0.01 ppm	4M20F9W

### 1.7 Testing Location

<b>Test Site</b>	SPORTON INTERNATIONAL (KUNSHAN) INC.		
<b>Test Site Location</b>	No. 3-2, PingXiang Road, Kunshan, Jiangsu Province, P.R.C. TEL: +86-0512-5790-0158 FAX: +86-0512-5790-0958		
<b>Test Site No.</b>	<b>Sporton Site No.</b>		<b>FCC/IC Registration No.</b>
	TH01-KS	03CH01-KS	149928/4086E-1



## 1.8 Applicable Standards

According to the specifications of the manufacturer, the EUT must comply with the requirements of the following standards:

- ♦ FCC 47 CFR Part 2, 22(H), 24(E)
- ♦ ANSI / TIA / EIA-603-C-2004
- ♦ FCC KDB 971168 D01 Power Meas. License Digital Systems v02r01
- ♦ IC RSS-132 Issue 3
- ♦ IC RSS-133 Issue 6
- ♦ IC RSS-Gen Issue 3
- ♦ NOTICE 2012-DRS0126

### Remark:

1. All test items were verified and recorded according to the standards and without any deviation during the test.
2. This EUT has also been tested and complied with the requirements of FCC Part 15, Subpart B, recorded in a separate test report.
3. Per the section 2.2.3 of Notice of 2012-DRS0126, " Receivers Excluded from Industry Canada Requirements", only radiocommunication receivers operating in stand-alone mode within the band 30-960 MHz and scanner receivers are subject to Industry Canada requirements.





## 2 Test Configuration of Equipment Under Test

### 2.1 Test Mode

Antenna port conducted and radiated test items were performed according to KDB 971168 D01 Power Meas. License Digital Systems v02r01 with maximum output power.

Radiated measurements were performed with rotating EUT in different three orthogonal test planes to find the maximum emission.

Frequency range investigated for radiated emission: 30MHz to 10th harmonic.

All modes and data rates and positions were investigated.

Test modes are chosen to be reported as the worst case configuration below:

Test Modes		
Band	Radiated TCs	Conducted TCs
GSM 850	<ul style="list-style-type: none"><li>■ GSM Link</li><li>■ EDGE class 8 Link</li></ul>	<ul style="list-style-type: none"><li>■ GSM Link</li><li>■ EDGE class 8 Link</li></ul>
GSM 1900	<ul style="list-style-type: none"><li>■ GSM Link</li><li>■ EDGE class 8 Link</li></ul>	<ul style="list-style-type: none"><li>■ GSM Link</li><li>■ EDGE class 8 Link</li></ul>
WCDMA Band V	<ul style="list-style-type: none"><li>■ RMC 12.2Kbps Link</li></ul>	<ul style="list-style-type: none"><li>■ RMC 12.2Kbps Link</li></ul>
WCDMA Band II	<ul style="list-style-type: none"><li>■ RMC 12.2Kbps Link</li></ul>	<ul style="list-style-type: none"><li>■ RMC 12.2Kbps Link</li></ul>



Conducted Power Measurement Results:

SIM 1 Card:

Conducted Power (*Unit: dBm)						
Band	GSM850			GSM1900		
Channel	128	189	251	512	661	810
Frequency	824.2	836.4	848.8	1850.2	1880.0	1909.8
GSM	32.07	32.07	32.04	29.16	29.14	29.30
GPRS class 8	31.94	31.93	31.91	29.08	29.08	29.27
GPRS class 10	31.43	31.44	31.42	28.37	28.36	28.53
GPRS class 11	29.85	29.83	29.80	26.60	26.64	26.84
GPRS class 12	28.82	28.80	28.72	25.51	25.52	25.71
EGPRS class 8	28.90	28.67	28.65	25.37	25.38	25.39
EGPRS class 10	27.85	27.50	27.48	24.15	24.19	24.19
EGPRS class 11	26.50	26.28	26.25	22.15	22.22	22.20
EGPRS class 12	25.25	25.00	24.90	21.06	21.09	21.10

Conducted Power (*Unit: dBm)						
Band	WCDMA Band V			WCDMA Band II		
Channel	4132	4182	4233	9262	9400	9538
Frequency	826.4	836.4	846.6	1852.4	1880.0	1907.6
AMR 12.2K	23.11	22.75	23.08	22.68	22.52	22.45
RMC 12.2K	23.12	22.74	23.08	22.70	22.54	22.44
HSDPA Subtest-1	22.06	21.75	22.11	21.67	21.56	21.46
HSDPA Subtest-2	22.06	21.75	22.11	21.71	21.56	21.45
HSDPA Subtest-3	21.61	21.30	21.56	21.24	21.10	20.98
HSDPA Subtest-4	21.59	21.28	21.55	21.23	21.09	20.97
HSUPA Subtest-1	19.82	19.59	19.96	19.40	19.56	19.27
HSUPA Subtest-2	19.81	19.62	19.96	19.39	19.57	19.27
HSUPA Subtest-3	20.82	20.60	20.97	20.39	20.55	20.26
HSUPA Subtest-4	19.28	19.08	19.49	18.87	19.02	18.72
HSUPA Subtest-5	21.30	21.09	21.43	20.85	21.03	20.74



SIM 2 Card:

Conducted Power (*Unit: dBm)						
Band	GSM850			GSM1900		
Channel	128	189	251	512	661	810
Frequency	824.2	836.4	848.8	1850.2	1880.0	1909.8
GSM	32.04	32.04	32.02	29.10	29.11	29.26
GPRS class 8	31.89	31.88	31.87	29.05	29.05	29.25
GPRS class 10	31.41	31.41	31.38	28.32	28.34	28.49
GPRS class 11	29.80	29.79	29.76	26.54	26.60	26.81
GPRS class 12	28.81	28.79	28.70	25.48	25.50	25.70
EGPRS class 8	28.89	28.66	28.63	25.34	25.33	25.36
EGPRS class 10	27.82	27.48	27.46	24.15	24.16	24.13
EGPRS class 11	26.51	26.26	26.23	22.09	22.18	22.16
EGPRS class 12	25.26	25.01	24.89	21.03	21.04	21.08

Conducted Power (*Unit: dBm)						
Band	WCDMA Band V			WCDMA Band II		
Channel	4132	4182	4233	9262	9400	9538
Frequency	826.4	836.4	846.6	1852.4	1880.0	1907.6
AMR 12.2K	23.05	22.71	23.02	22.63	22.49	22.39
RMC 12.2K	23.06	22.69	23.06	22.65	22.48	22.39
HSDPA Subtest-1	22.01	21.69	22.07	21.64	21.52	21.43
HSDPA Subtest-2	22.02	21.73	22.08	21.67	21.52	21.40
HSDPA Subtest-3	21.55	21.28	21.53	21.20	21.05	20.96
HSDPA Subtest-4	21.55	21.22	21.53	21.20	21.05	20.93
HSUPA Subtest-1	19.76	19.55	19.92	19.36	19.53	19.24
HSUPA Subtest-2	19.77	19.57	19.90	19.36	19.53	19.21
HSUPA Subtest-3	20.79	20.57	20.94	20.36	20.51	20.22
HSUPA Subtest-4	19.25	19.03	19.45	18.84	18.99	18.68
HSUPA Subtest-5	21.29	21.06	21.41	20.81	20.97	20.71

## 2.2 Connection Diagram of Test System

For 22H

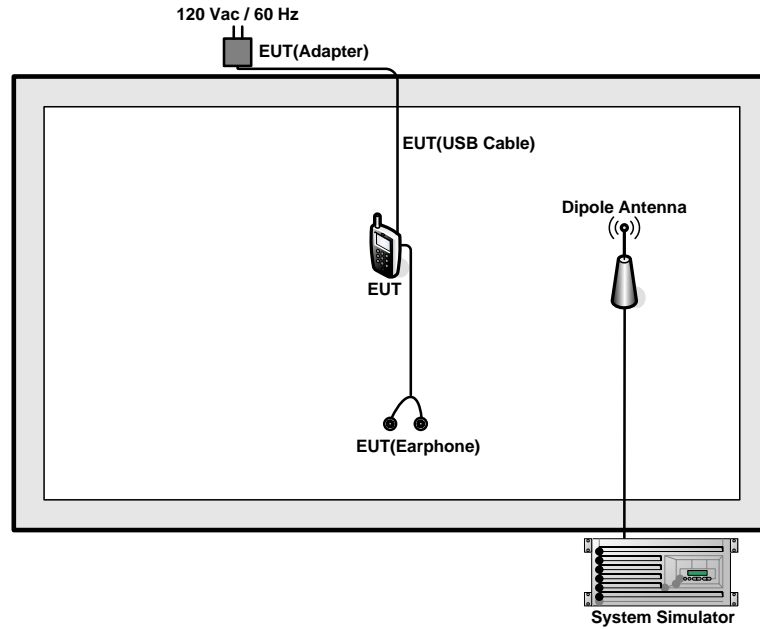

For 24E

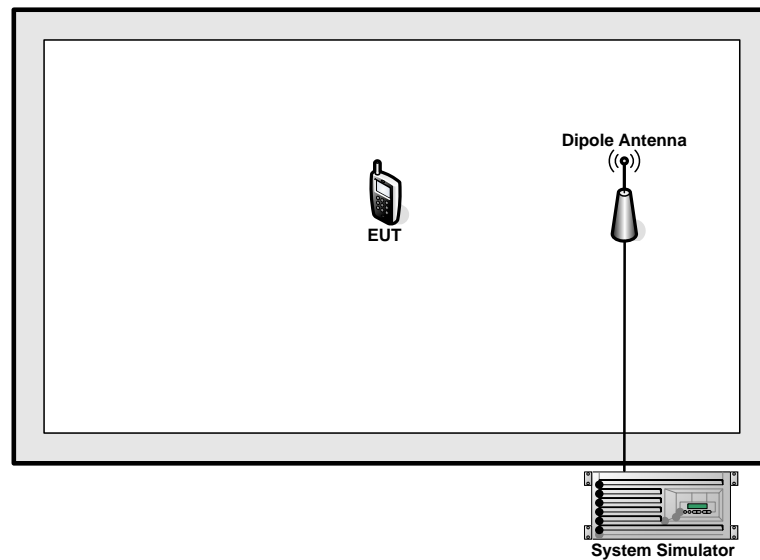



### 2.3 Support Unit used in test configuration

Item	Equipment	Trade Name	Model No.	FCC ID	Data Cable	Power Cord
1.	System Simulator	R&S	CMU 200	N/A	N/A	Unshielded, 1.8 m
2.	DC Power Supply	GWINSTEK	GPS-3030D	N/A	N/A	N/A

### 2.4 Measurement Results Explanation Example

For all conducted test items:

The offset level is set in the spectrum analyzer to compensate the RF cable loss and attenuator factor between RF conducted output port and spectrum analyzer. With the offset compensation, the spectrum analyzer reading level will be exactly the RF output level.

The spectrum analyzer offset is derived from RF cable loss and attenuator factor.

$$\text{Offset} = \text{RF cable loss} + \text{attenuator factor}.$$

The following shows an offset computation example with RF cable loss 5.2 dB and a 10dB attenuator.

Example :

$$\begin{aligned} \text{Offset(dB)} &= \text{RF cable loss(dB)} + \text{attenuator factor(dB)}. \\ &= 5.2 + 10 = 15.2 \text{ (dB)} \end{aligned}$$

### **3 Test Result**

#### **3.1 Conducted Output Power Measurement**

##### **3.1.1 Description of the Conducted Output Power Measurement**

A system simulator was used to establish communication with the EUT. Its parameters were set to enforce EUT transmitting at the maximum power. The measured power in the radio frequency on the transmitter output terminals shall be reported.

##### **3.1.2 Measuring Instruments**

The measuring equipment is listed in the section 4 of this test report.

##### **3.1.3 Test Procedures**

1. The transmitter output port was connected to the system simulator.
2. Set EUT at maximum power through system simulator.
3. Select lowest, middle, and highest channels for each band and different modulation.
4. Measure the maximum burst average power for GSM and maximum average power for other modulation signal.

##### **3.1.4 Test Setup**

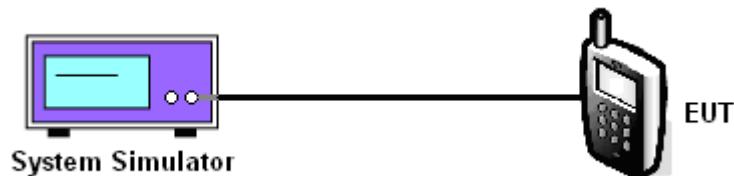

### 3.1.5 Test Result of Conducted Output Power

Cellular Band									
Modes	GSM850 (GSM)			GSM850 (EDGE class 8)			WCDMA Band V (RMC 12.2Kbps)		
Channel	128 (Low)	189 (Mid)	251 (High)	128 (Low)	189 (Mid)	251 (High)	4132 (Low)	4182 (Mid)	4233 (High)
Frequency (MHz)	824.2	836.4	848.8	824.2	836.4	848.8	826.4	836.4	846.6
Conducted Power (dBm)	32.07	32.07	32.04	28.90	28.67	28.65	23.12	22.74	23.08

PCS Band									
Modes	GSM1900 (GSM)			GSM1900 (EDGE class 8)			WCDMA Band II (RMC 12.2Kbps)		
Channel	512 (Low)	661 (Mid)	810 (High)	512 (Low)	661 (Mid)	810 (High)	9262 (Low)	9400 (Mid)	9538 (High)
Frequency (MHz)	1850.2	1880	1909.8	1850.2	1880	1909.8	1852.4	1880	1907.6
Conducted Power (dBm)	29.16	29.14	29.30	25.37	25.38	25.39	22.70	22.54	22.44

**Note:** maximum burst average power for GSM, and maximum average power for WCDMA.

## 3.2 Peak-to-Average Ratio

### 3.2.1 Description of the PAR Measurement

The peak-to-average ratio (PAR) of the transmission may not exceed 13 dB.

### 3.2.2 Measuring Instruments

The measuring equipment is listed in the section 4 of this test report.

### 3.2.3 Test Procedures

1. The testing follows FCC KDB 971168 v02r01 Section 5.7.1.
2. The EUT was connected to the spectrum analyzer and system simulator via a power divider.
3. For GSM/EGPRS operating modes:
  - a. Set EUT in maximum power output.
  - b. Set the RBW = 1MHz, VBW = 3MHz, Peak detector on spectrum analyzer for first trace.
  - c. Set the RBW = 1MHz, VBW = 3MHz, RMS detector on spectrum analyzer for second trace.
  - d. The wanted burst signal is triggered by spectrum analyzer, and measured respectively the peak level and Mean level without burst-off time, after system simulator has synchronized with the spectrum analyzer.
4. For UMTS operating modes:
  - a. Set the CCDF (Complementary Cumulative Distribution Function) option on the spectrum analyzer.
  - b. The highest RF powers were measured and recorded the maximum PAPR level associated with a probability of 0.1 %.
5. Record the deviation as Peak to Average Ratio.

### 3.2.4 Test Setup

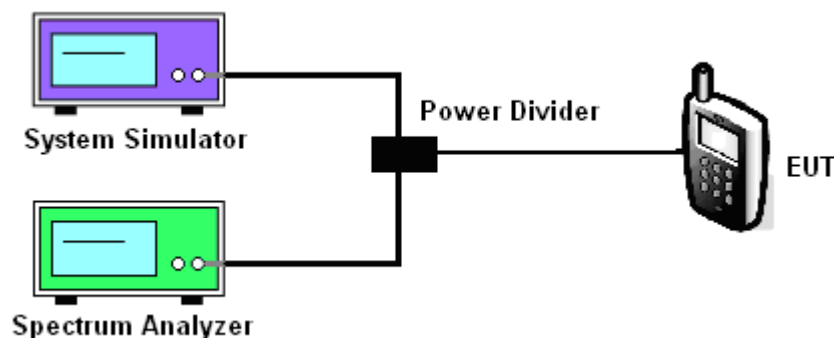





### 3.2.5 Test Result of Peak-to-Average Ratio

PCS Band									
Modes	GSM1900 (GSM)			GSM1900 (EDGE class 8)			WCDMA Band II (RMC 12.2Kbps)		
Channel	512 (Low)	661 (Mid)	810 (High)	512 (Low)	661 (Mid)	810 (High)	9262 (Low)	9400 (Mid)	9538 (High)
Frequency (MHz)	1850.2	1880	1909.8	1850.2	1880	1909.8	1852.4	1880	1907.6
Peak-to-Average Ratio (dB)	0.37	0.37	0.39	2.88	2.77	2.94	2.88	2.88	2.68



### 3.2.6 Test Result (Plots) of Peak-to-Average Ratio

Band :	GSM 1900	Test Mode :	GSM Link (GMSK)
--------	----------	-------------	-----------------

Peak-to-Average Ratio on Channel 512 (1850.2 MHz)

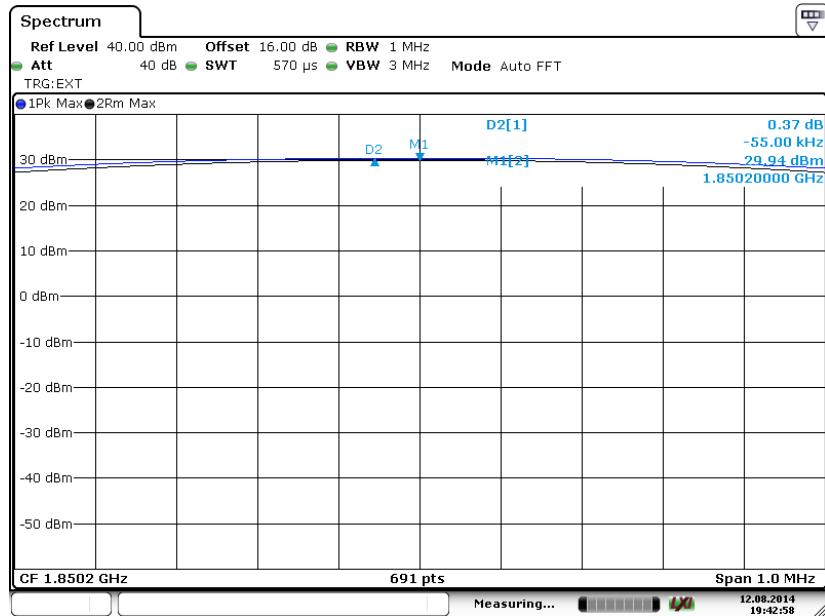

Date: 12 AUG. 2014 19:42:57

Peak-to-Average Ratio on Channel 661 (1880.0 MHz)

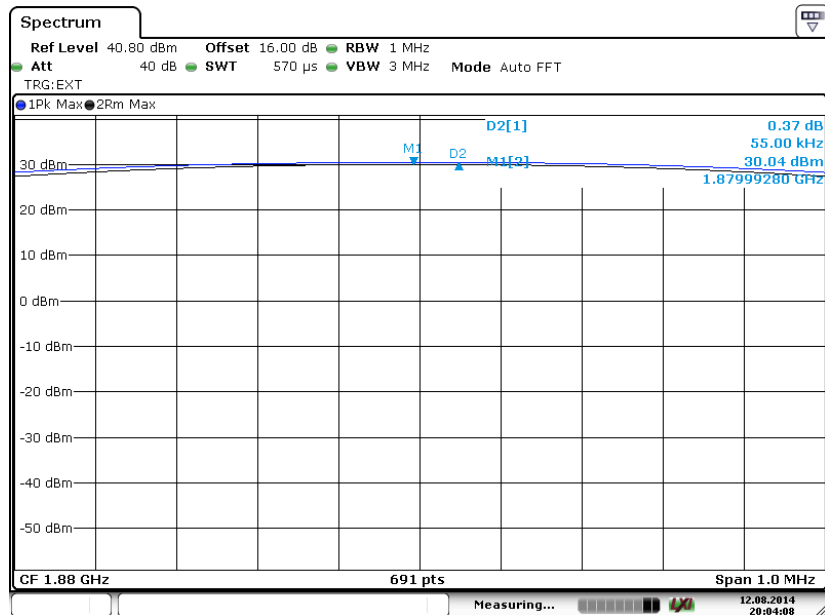

Date: 12 AUG. 2014 20:04:08



Peak-to-Average Ratio on Channel 810 (1909.8 MHz)

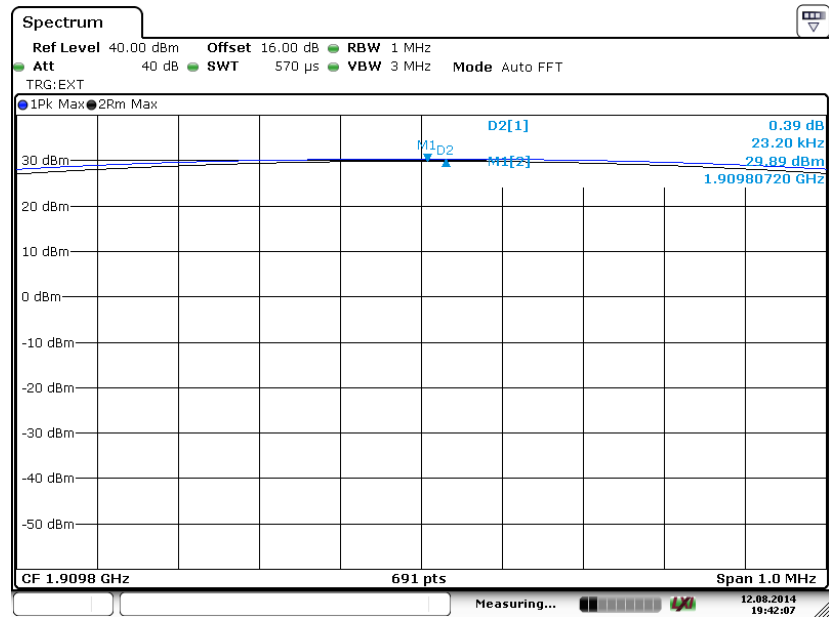

Date: 12 AUG 2014 19:42:07



<b>Band :</b>	GSM 1900	<b>Test Mode :</b>	EDGE class 8 Link (8PSK)
---------------	----------	--------------------	--------------------------

Peak-to-Average Ratio on Channel 512 (1850.2 MHz)

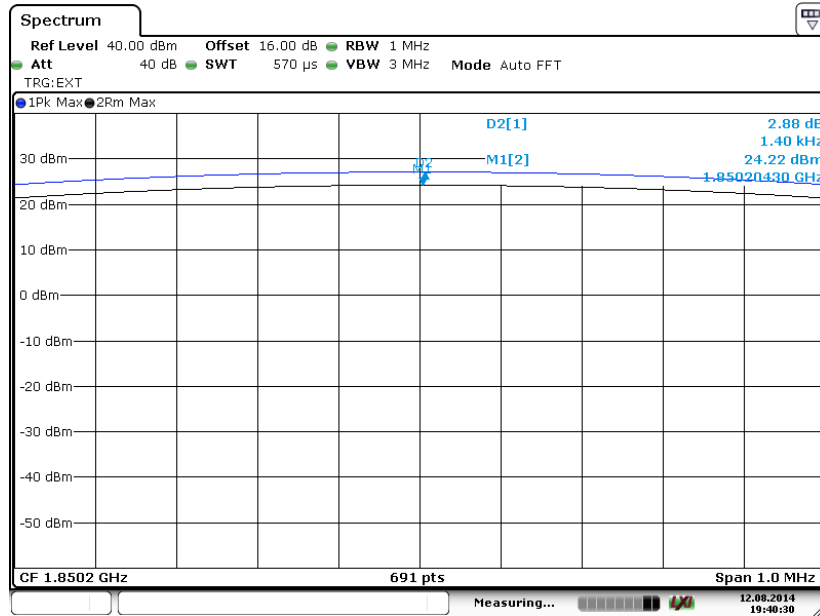

Date: 12 AUG .2014 19:40:29

Peak-to-Average Ratio on Channel 661 (1880.0 MHz)

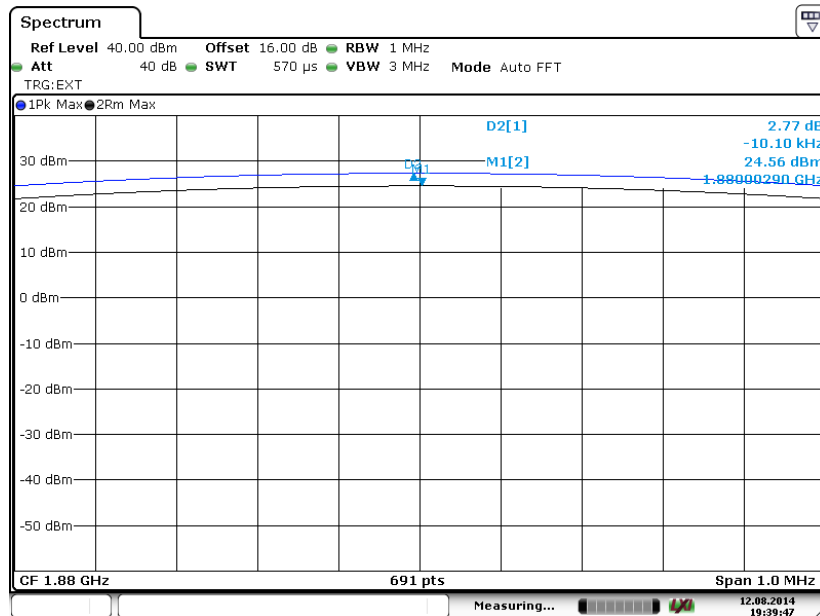

Date: 12 AUG .2014 19:39:47



Peak-to-Average Ratio on Channel 810 (1909.8 MHz)

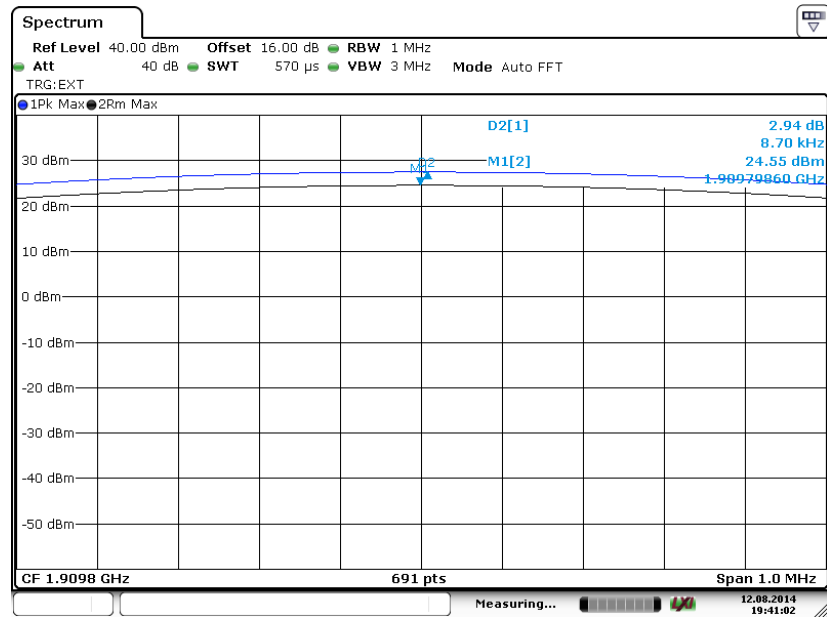

Date: 12 AUG 2014 19:41:02



<b>Band :</b>	WCDMA Band II	<b>Test Mode :</b>	RMC 12.2Kbps Link (QPSK)
---------------	---------------	--------------------	--------------------------

**Peak-to-Average Ratio on Channel 9262 (1852.4 MHz)**

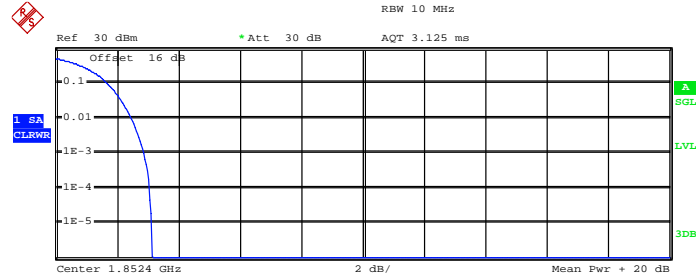

Complementary Cumulative Distribution Function (100000 samples)

Trace 1

Mean	23.12 dBm
Peak	26.26 dBm
Crest	3.15 dB
10 %	1.68 dB
1 %	2.48 dB
.1 %	2.88 dB
.01 %	3.08 dB

Date: 19.AUG.2014 18:07:34

**Peak-to-Average Ratio on Channel 9400 (1880.0 MHz)**

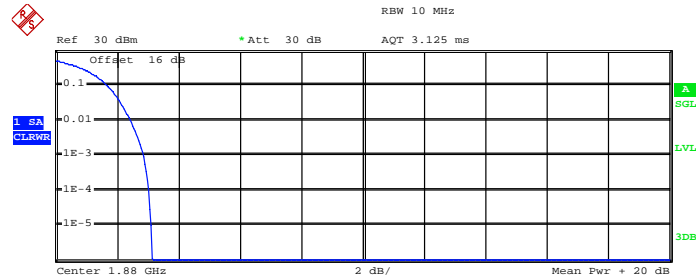

Complementary Cumulative Distribution Function (100000 samples)

Trace 1

Mean	23.26 dBm
Peak	26.40 dBm
Crest	3.15 dB
10 %	1.68 dB
1 %	2.44 dB
.1 %	2.88 dB
.01 %	3.04 dB

Date: 19.AUG.2014 18:07:12



Peak-to-Average Ratio on Channel 9538 (1907.6 MHz)

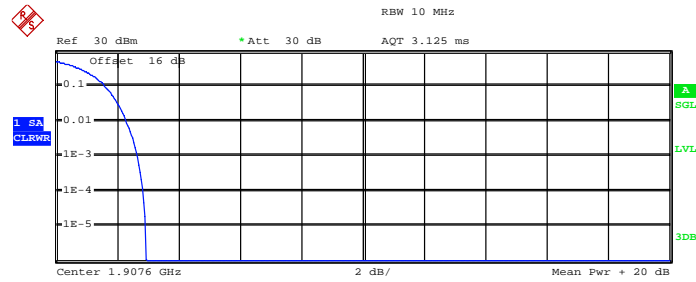

Complementary Cumulative Distribution Function (100000 samples)

Trace 1

Mean	23.04 dBm
Peak	25.98 dBm
Crest	2.94 dB
10 %	1.60 dB
1 %	2.32 dB
.1 %	2.68 dB
.01 %	2.84 dB

Date: 19.AUG.2014 18:06:52



### 3.3 Effective Radiated Power and Effective Isotropic Radiated Power Measurement

#### 3.3.1 Description of the ERP/EIRP Measurement

The substitution method, in ANSI / TIA / EIA-603-C-2004, was used for ERP/EIRP measurement, and the spectrum analyzer configuration follows KDB 971168 D01 Power Meas. License Digital Systems v02r01. The ERP of mobile transmitters must not exceed 7 Watts and the EIRP of mobile transmitters are limited to 2 Watts.

#### 3.3.2 Measuring Instruments

The measuring equipment is listed in the section 4 of this test report.

#### 3.3.3 Test Procedures

1. The testing follows FCC KDB 971168 v02r01 Section 5.2.1. (for CDMA/WCDMA), Section 5.2.2.2 (for GSM/GPRS/EDGE) and ANSI / TIA-603-C-2004 Section 2.2.17.
2. The EUT was placed on a non-conductive rotating platform 0.8 meters high in a semi-anechoic chamber. The radiated emission at the fundamental frequency was measured at 3 m with a test antenna and a spectrum analyzer with RMS detector per section 5. of KDB 971168 D01.
3. During the measurement, the system simulator parameters were set to force the EUT transmitting at maximum output power. The maximum emission was recorded from analyzer power level (LVL) from the 360 degrees rotation of the turntable and the test antenna raised and lowered over a range from 1 to 4 meters in both horizontally and vertically polarized orientations.
4. Effective Isotropic Radiated Power (EIRP) was measured by substitution method according to TIA/EIA-603-C. The EUT was replaced by dipole antenna (substitution antenna) at the same location, and then a known power from S.G. was applied into the dipole antenna through a Tx cable, and then recorded the maximum Analyzer reading through raised and lowered the test antenna. The correction factor (in dB) = S.G. - Tx Cable loss + Substitution antenna gain - Analyzer reading. Then the EUT's EIRP was calculated with the correction factor,  $EIRP = LVL + \text{Correction factor}$  and  $ERP = EIRP - 2.15$ .



### 3.3.4 Test Setup

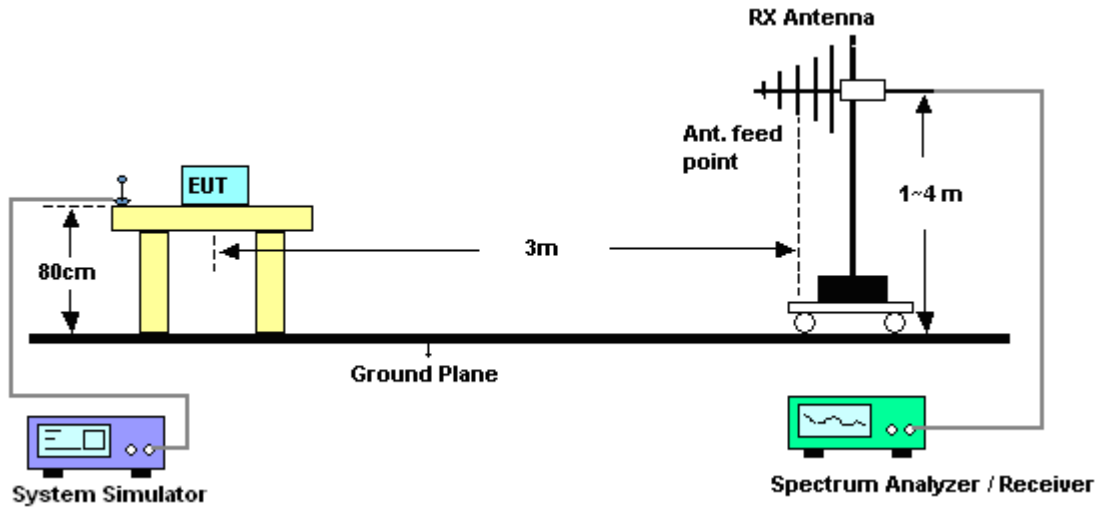

3.3.5 Test Result of ERP

GSM850 (GSM) Radiated Power ERP				
Horizontal Polarization				
Frequency (MHz)	LVL (dBm)	Correction Factor (dB)	ERP (dBm)	ERP (W)
824.2	3.36	29.11	30.32	1.0765
836.4	3.49	29.20	30.54	1.1324
848.8	2.91	29.40	30.16	1.0375
Vertical Polarization				
Frequency (MHz)	LVL (dBm)	Correction Factor (dB)	ERP (dBm)	ERP (W)
824.2	-13.64	33.23	17.44	0.0555
836.4	-12.55	33.00	18.30	0.0676
848.8	-12.16	32.95	18.64	0.0731

\* ERP = LVL (dBm) + Correction Factor (dB) – 2.15

GSM850 (EDGE class 8) Radiated Power ERP				
Horizontal Polarization				
Frequency (MHz)	LVL (dBm)	Correction Factor (dB)	ERP (dBm)	ERP (W)
824.2	-3.24	29.11	23.72	0.2355
836.4	-2.36	29.2	24.69	0.2942
848.8	-1.66	29.4	25.59	0.3624
Vertical Polarization				
Frequency (MHz)	LVL (dBm)	Correction Factor (dB)	ERP (dBm)	ERP (W)
824.2	-20.19	33.23	10.89	0.0123
836.4	-18.90	33	11.95	0.0157
848.8	-17.26	32.95	13.54	0.0226

\* ERP = LVL (dBm) + Correction Factor (dB) – 2.15



WCDMA Band V (RMC 12.2Kbps) Radiated Power ERP				
Horizontal Polarization				
Frequency (MHz)	LVL (dBm)	Correction Factor (dB)	ERP (dBm)	ERP (W)
826.40	-7.61	29.11	19.35	0.0861
836.40	-8.59	29.20	18.46	0.0701
846.60	-6.98	29.40	20.27	0.1064
Vertical Polarization				
Frequency (MHz)	LVL (dBm)	Correction Factor (dB)	ERP (dBm)	ERP (W)
826.40	-24.30	33.23	6.78	0.0048
836.40	-24.46	33.00	6.39	0.0044
846.60	-24.34	32.95	6.46	0.0044

\* ERP = LVL (dBm) + Correction Factor (dB) – 2.15

3.3.6 Test Result of EIRP

GSM1900 (GSM) Radiated Power EIRP				
Horizontal Polarization				
Frequency (MHz)	LVL (dBm)	Correction Factor (dB)	EIRP (dBm)	EIRP (W)
1850.2	-11.01	42.76	31.75	1.4962
1880.0	-10.71	42.32	31.61	1.4488
1909.8	-10.75	41.95	31.20	1.3183
Vertical Polarization				
Frequency (MHz)	LVL (dBm)	Correction Factor (dB)	EIRP (dBm)	EIRP (W)
1850.2	-10.14	42.13	31.99	1.5812
1880.0	-11.14	42.79	31.65	1.4622
1909.8	-11.54	42.83	31.29	1.3459

\* EIRP = LVL (dBm) + Correction Factor (dB)

GSM1900 (EDGE class 8) Radiated Power EIRP				
Horizontal Polarization				
Frequency (MHz)	LVL (dBm)	Correction Factor (dB)	EIRP (dBm)	EIRP (W)
1850.2	-15.43	42.76	27.33	0.5408
1880.0	-15.75	42.32	26.57	0.4539
1909.8	-15.27	41.95	26.68	0.4656
Vertical Polarization				
Frequency (MHz)	LVL (dBm)	Correction Factor (dB)	EIRP (dBm)	EIRP (W)
1850.2	-14.56	42.13	27.57	0.5715
1880.0	-15.62	42.79	27.17	0.5212
1909.8	-16.28	42.83	26.55	0.4519

\* EIRP = LVL (dBm) + Correction Factor (dB)



WCDMA Band II (RMC 12.2Kbps) Radiated Power EIRP				
Horizontal Polarization				
Frequency (MHz)	LVL (dBm)	Correction Factor (dB)	EIRP (dBm)	EIRP (W)
1852.40	-17.99	42.76	24.77	0.2999
1880.00	-17.78	42.32	24.54	0.2844
1907.60	-17.33	41.95	24.62	0.2897
Vertical Polarization				
Frequency (MHz)	LVL (dBm)	Correction Factor (dB)	EIRP (dBm)	EIRP (W)
1852.40	-17.17	42.13	24.96	0.3133
1880.00	-18.23	42.79	24.56	0.2858
1907.60	-18.14	42.83	24.69	0.2944

\* EIRP = LVL (dBm) + Correction Factor (dB)

## 3.4 99% Occupied Bandwidth and 26dB Bandwidth Measurement

### 3.4.1 Description of 99% Occupied Bandwidth and 26dB Bandwidth Measurement

The 99% occupied bandwidth is the width of a frequency band such that, below the lower and above the upper frequency limits, the mean powers emitted are each equal to a specified percentage 0.5% of the total mean transmitted power.

The emission bandwidth is defined as the width of the signal between two points, located at the 2 sides of the carrier frequency, outside of which all emissions are attenuated at least 26 dB below the transmitter power.

### 3.4.2 Measuring Instruments

The measuring equipment is listed in the section 4 of this test report.

### 3.4.3 Test Procedures

1. The testing follows FCC KDB 971168 v02r01 Section 4.2.
2. The EUT was connected to the spectrum analyzer and system simulator via a power divider.
3. The RF output of the EUT was connected to the spectrum analyzer by RF cable and attenuator. The path loss was compensated to the results for each measurement.
4. The 99% occupied bandwidth were measured, set RBW= 1% of span, VBW= 3\*RBW, sample detector, trace maximum hold.
5. The 26dB bandwidth were measured, set RBW= 1% of EBW, VBW= 3\*RBW, peak detector, trace maximum hold.

### 3.4.4 Test Setup

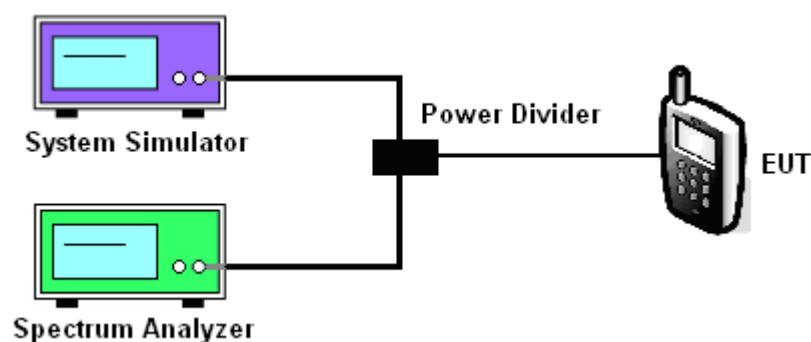



3.4.5 Test Result of Occupied Bandwidth and 26dB Bandwidth

Cellular Band						
Modes	GSM850 (GSM)			GSM850 (EDGE class 8)		
Channel	128 (Low)	189 (Mid)	251 (High)	128 (Low)	189 (Mid)	251 (High)
Frequency (MHz)	824.2	836.4	848.8	824.2	836.4	848.8
99% OBW (kHz)	246.00	250.00	244.00	250.00	246.00	242.00
26dB BW (kHz)	312.00	314.00	312.00	312.00	312.00	318.00

PCS Band						
Modes	GSM1900 (GSM)			GSM1900 (EDGE class 8)		
Channel	512 (Low)	661 (Mid)	810 (High)	512 (Low)	661 (Mid)	810 (High)
Frequency (MHz)	1850.2	1880	1909.8	1850.2	1880	1909.8
99% OBW (kHz)	246.00	244.00	246.00	246.00	248.00	246.00
26dB BW (kHz)	316.00	316.00	316.00	318.00	316.00	314.00

Cellular Band			
Modes	WCDMA Band V (RMC 12.2Kbps)		
Channel	4132 (Low)	4182 (Mid)	4233 (High)
Frequency (MHz)	826.4	836.4	846.6
99% OBW (MHz)	4.16	4.16	4.16
26dB BW (MHz)	4.68	4.72	4.68

PCS Band			
Modes	WCDMA Band II (RMC 12.2Kbps)		
Channel	9262 (Low)	9400 (Mid)	9538 (High)
Frequency (MHz)	1852.4	1880	1907.6
99% OBW (MHz)	4.16	4.20	4.20
26dB BW (MHz)	4.72	4.72	4.74



### 3.4.6 Test Result (Plots) of Occupied Bandwidth and 26dB Bandwidth

Band :	GSM 850	Test Mode :	GSM Link (GMSK)
--------	---------	-------------	-----------------

99% Occupied Bandwidth Plot on Channel 128 (824.2 MHz)

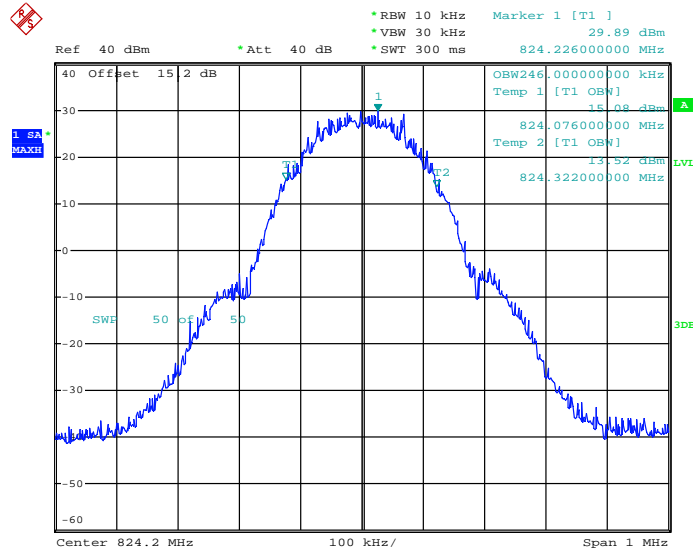

Date: 11.AUG.2014 12:54:31

26dB Bandwidth Plot on Channel 128 (824.2 MHz)

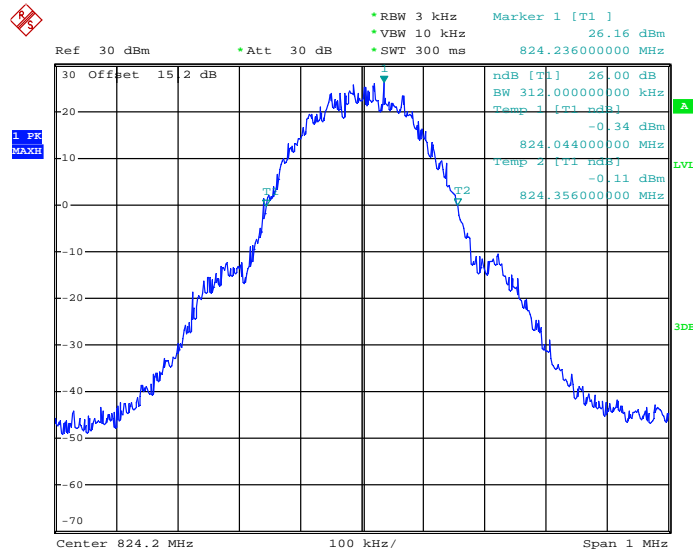

Date: 11.AUG.2014 12:43:51





99% Occupied Bandwidth Plot on Channel 189 (836.4 MHz)

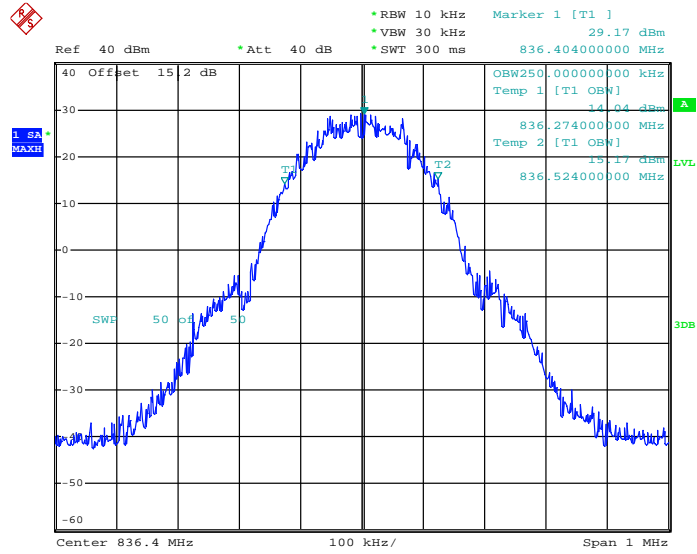

Date: 11.AUG.2014 12:52:13

26dB Bandwidth Plot on Channel 189 (836.4 MHz)

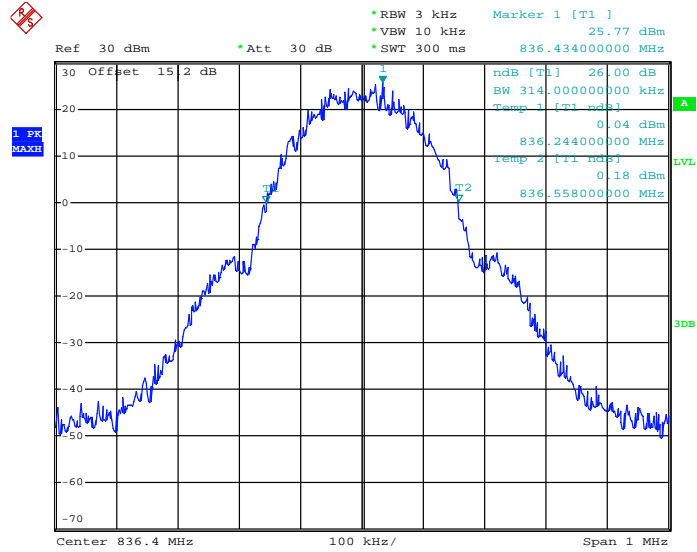

Date: 11.AUG.2014 12:44:48



99% Occupied Bandwidth Plot on Channel 251 (848.8 MHz)

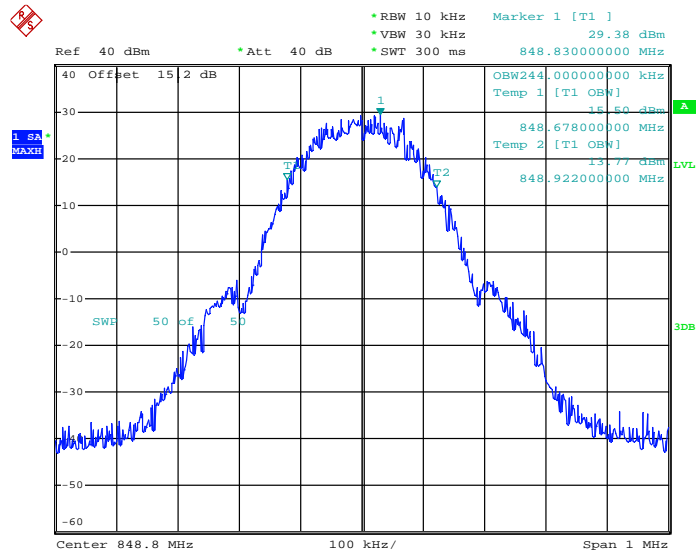

Date: 11.AUG.2014 12:51:12

26dB Bandwidth Plot on Channel 251 (848.8 MHz)

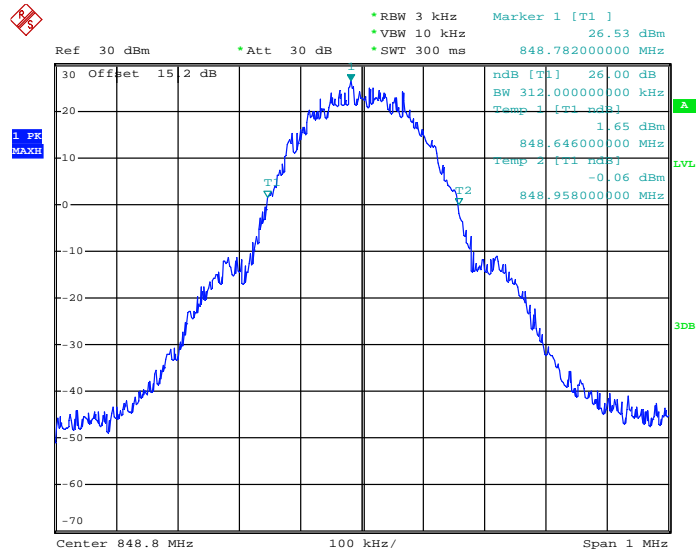

Date: 11.AUG.2014 12:45:25



<b>Band :</b>	GSM 850	<b>Test Mode :</b>	EDGE class 8 Link (8PSK)
---------------	---------	--------------------	--------------------------

99% Occupied Bandwidth Plot on Channel 128 (824.2 MHz)

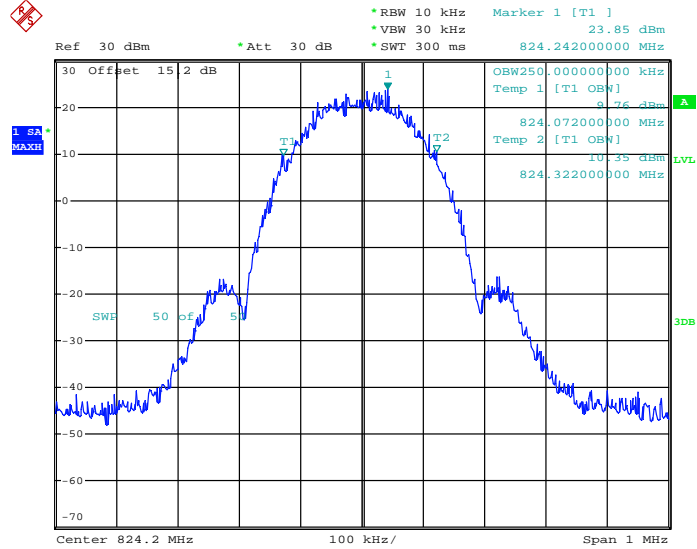

Date: 11.AUG.2014 17:21:17

26dB Bandwidth Plot on Channel 128 (824.2 MHz)

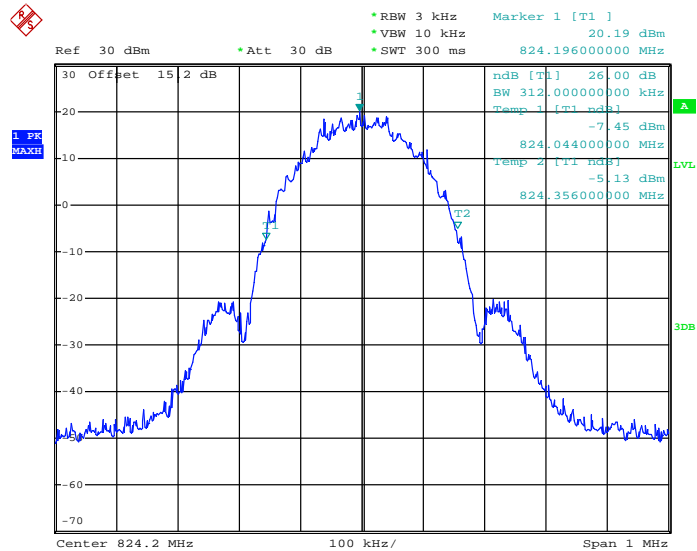

Date: 11.AUG.2014 15:42:19



99% Occupied Bandwidth Plot on Channel 189 (836.4 MHz)

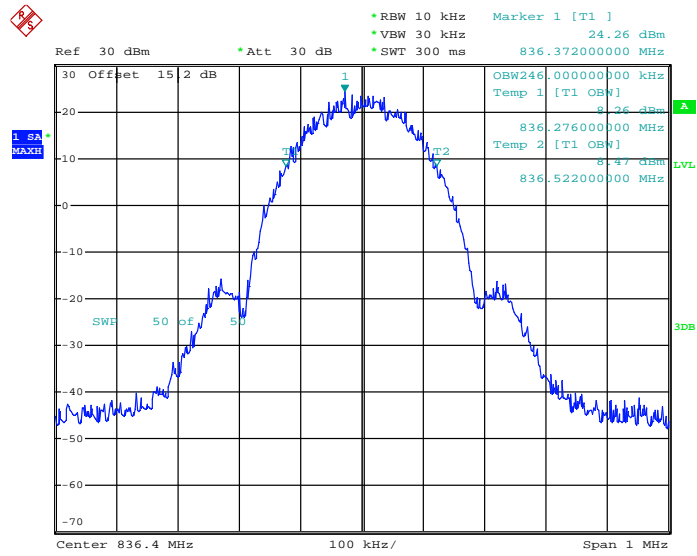

Date: 11.AUG.2014 17:24:18

26dB Bandwidth Plot on Channel 189 (836.4 MHz)

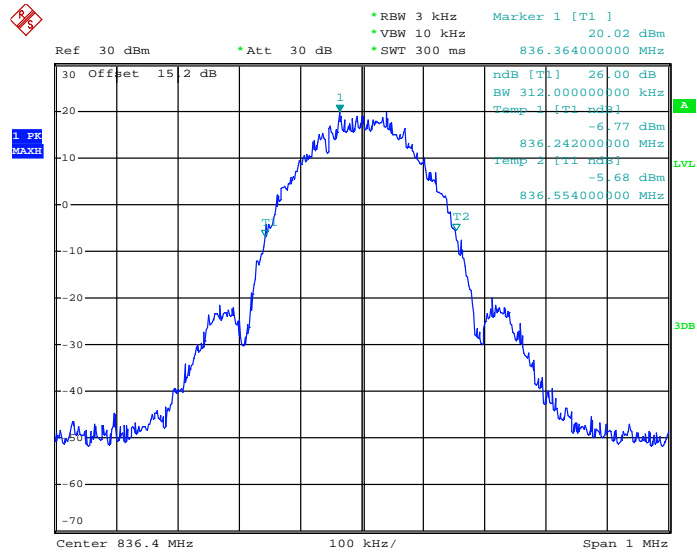

Date: 11.AUG.2014 16:55:10



99% Occupied Bandwidth Plot on Channel 251 (848.8 MHz)

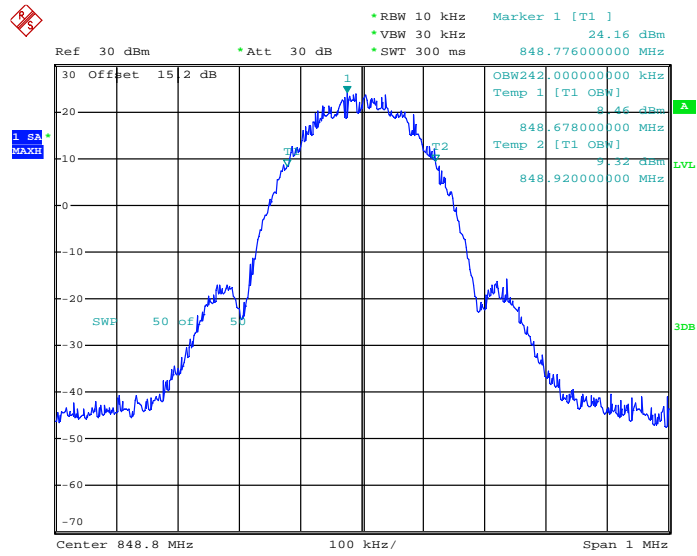

Date: 11.AUG.2014 17:32:16

26dB Bandwidth Plot on Channel 251 (848.8 MHz)

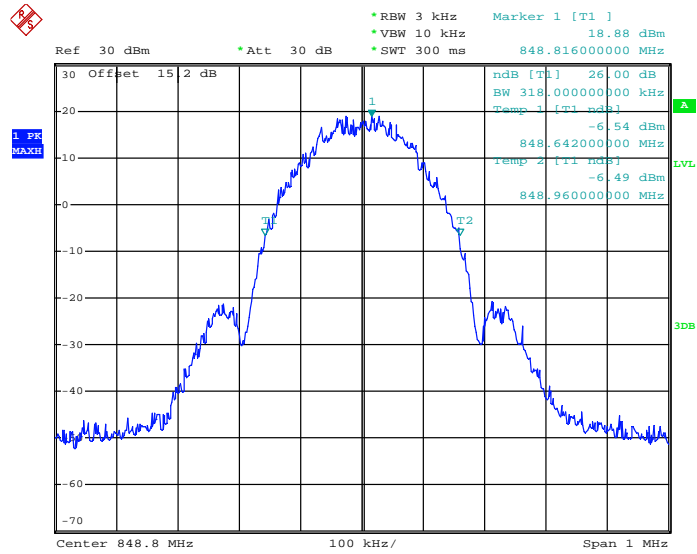

Date: 11.AUG.2014 15:43:54



Band :	GSM 1900	Test Mode :	GSM Link (GMSK)
--------	----------	-------------	-----------------

99% Occupied Bandwidth Plot on Channel 512 (1850.2 MHz)

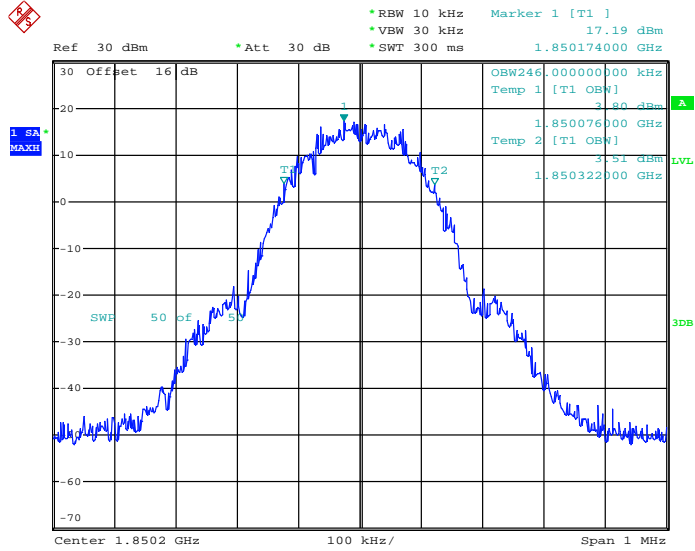

Date: 12.AUG.2014 14:37:59

26dB Bandwidth Plot on Channel 512 (1850.2 MHz)

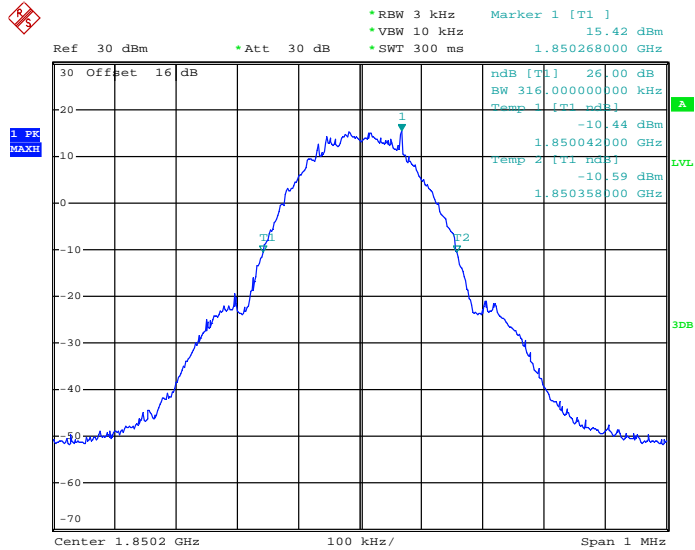

Date: 12.AUG.2014 14:29:10



99% Occupied Bandwidth Plot on Channel 661 (1880.0 MHz)

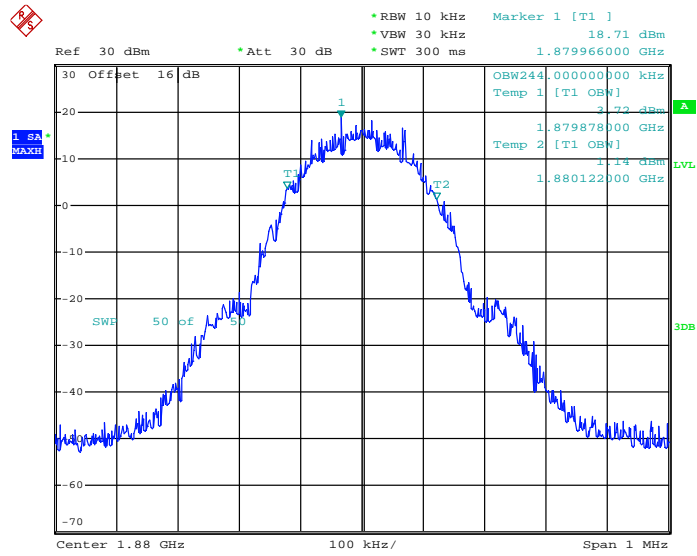

Date: 12.AUG.2014 14:36:26

26dB Bandwidth Plot on Channel 661 (1880.0 MHz)

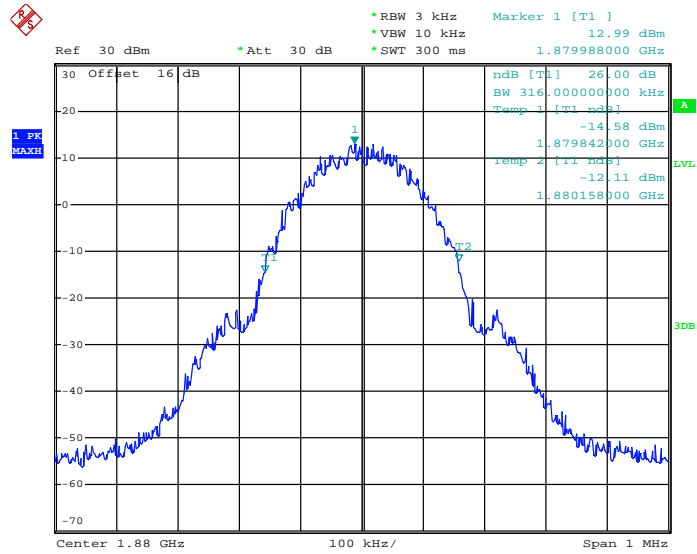

Date: 12.AUG.2014 14:30:14



### 99% Occupied Bandwidth Plot on Channel 810 (1909.8 MHz)

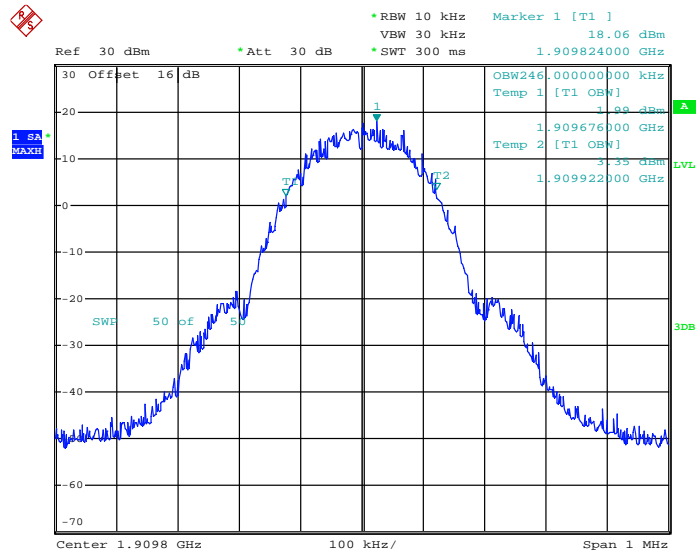

Date: 12.AUG.2014 15:16:50

### 26dB Bandwidth Plot on Channel 810 (1909.8 MHz)

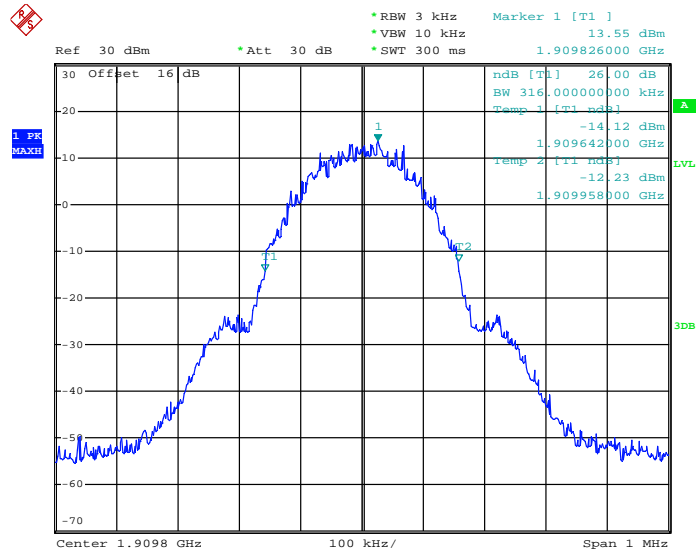

Date: 12.AUG.2014 14:31:11





<b>Band :</b>	GSM 1900	<b>Test Mode :</b>	EDGE class 8 Link (8PSK)
---------------	----------	--------------------	--------------------------

99% Occupied Bandwidth Plot on Channel 512 (1850.2 MHz)

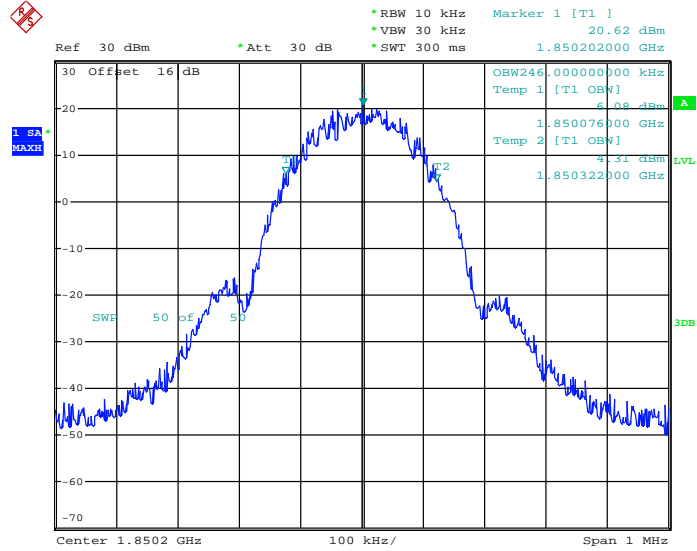

Date: 12.AUG.2014 11:52:38

26dB Bandwidth Plot on Channel 512 (1850.2 MHz)

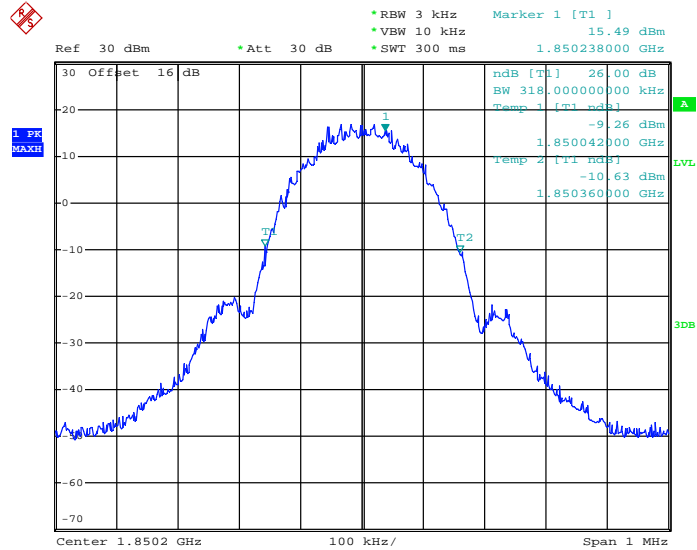

Date: 12.AUG.2014 11:42:08



### 99% Occupied Bandwidth Plot on Channel 661 (1880.0 MHz)

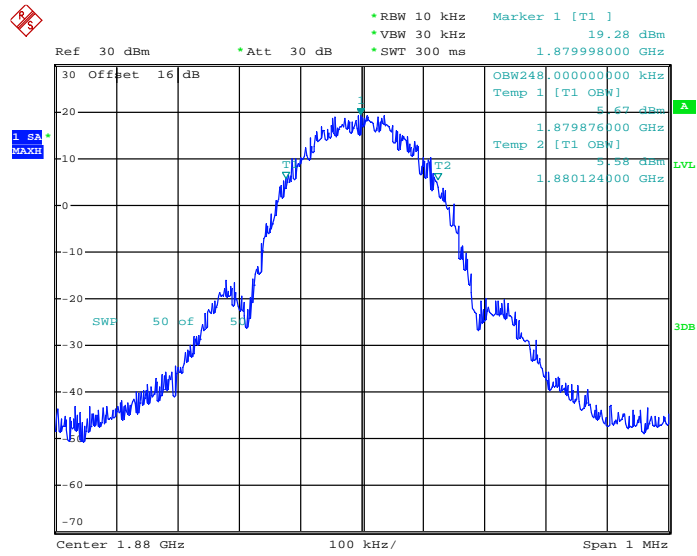

Date: 12.AUG.2014 11:51:00

### 26dB Bandwidth Plot on Channel 661 (1880.0 MHz)

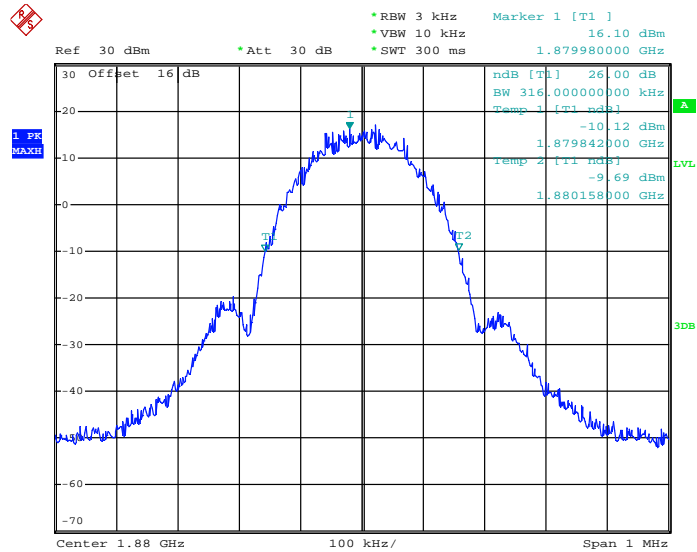

Date: 12.AUG.2014 11:43:44



### 99% Occupied Bandwidth Plot on Channel 810 (1909.8 MHz)

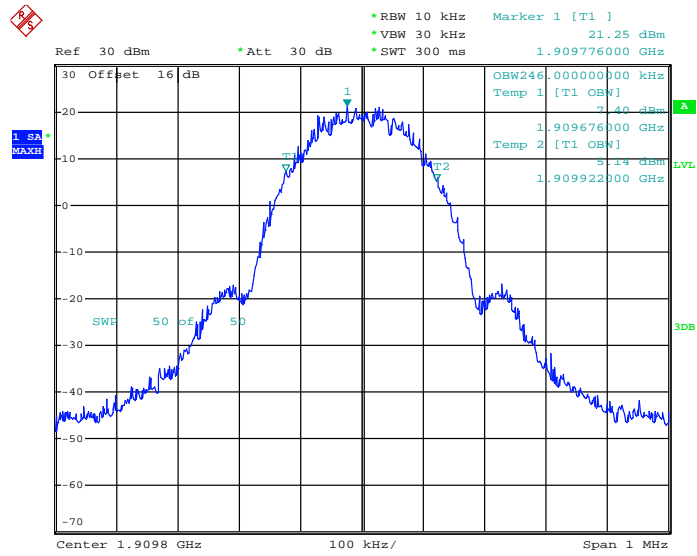

Date: 12.AUG.2014 11:58:09

### 26dB Bandwidth Plot on Channel 810 (1909.8 MHz)

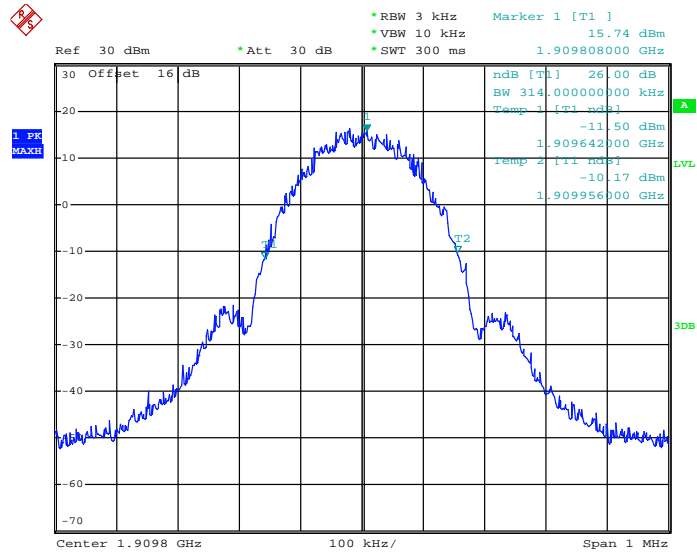

Date: 12.AUG.2014 11:45:43



<b>Band :</b>	WCDMA Band V	<b>Test Mode :</b>	RMC 12.2Kbps Link (QPSK)
---------------	--------------	--------------------	--------------------------

99% Occupied Bandwidth Plot on Channel 4132 (826.4 MHz)

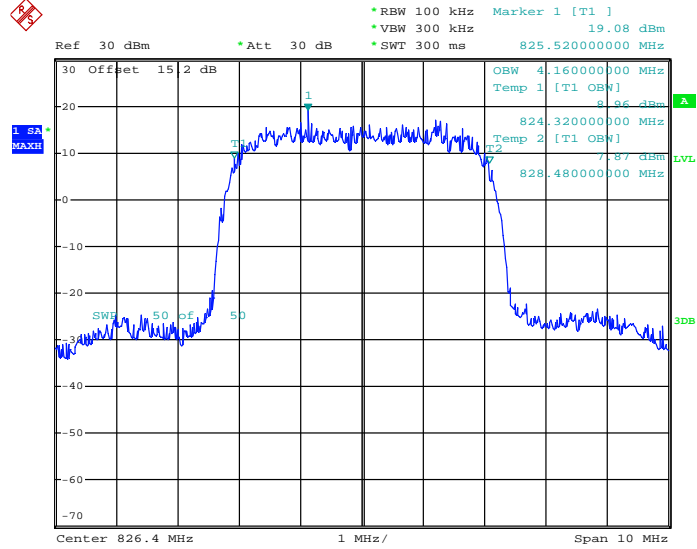

Date: 12.AUG.2014 15:53:54

26dB Bandwidth Plot on Channel 4132 (826.4 MHz)

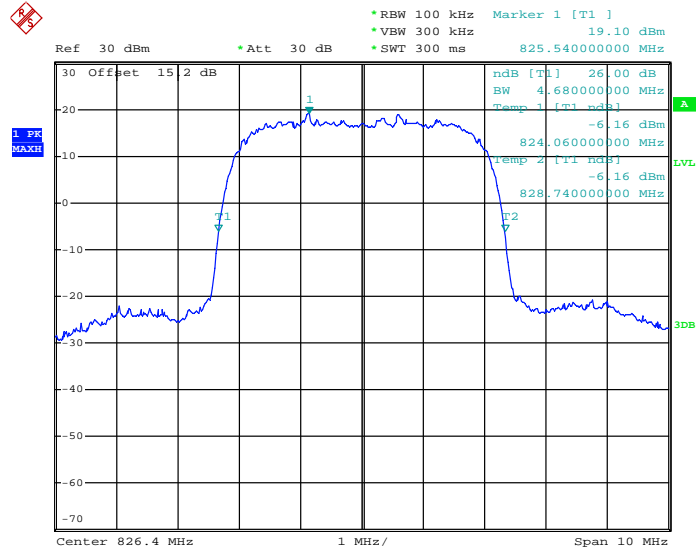

Date: 12.AUG.2014 15:51:23



99% Occupied Bandwidth Plot on Channel 4182 (836.4 MHz)

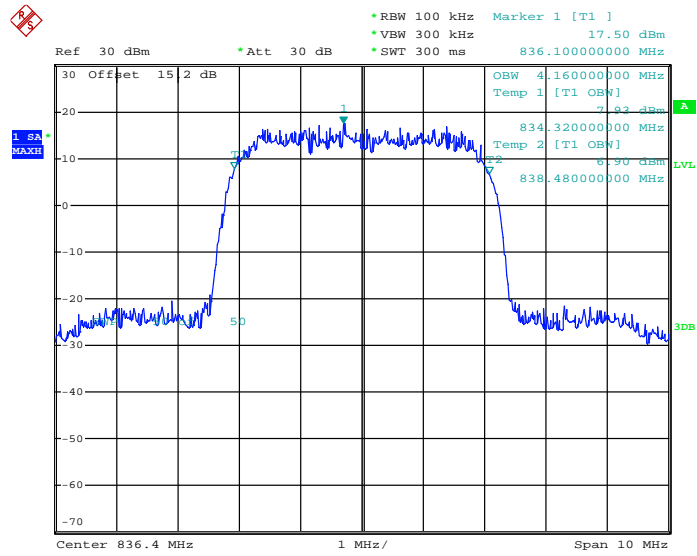

Date: 12.AUG.2014 15:54:15

26dB Bandwidth Plot on Channel 4182 (836.4 MHz)

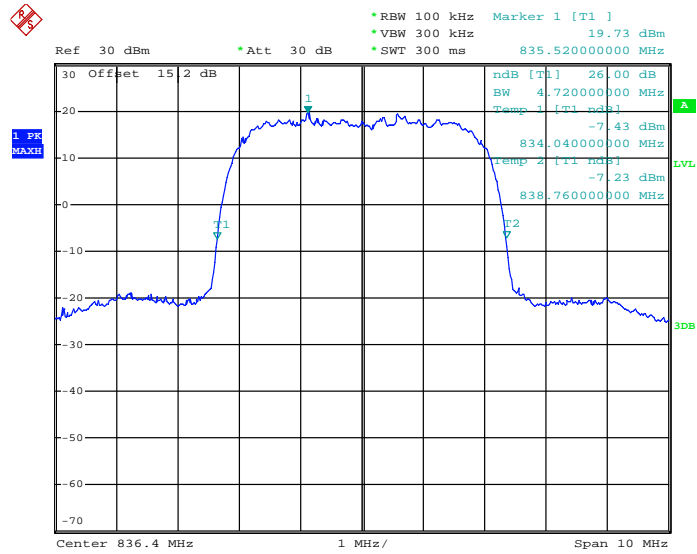

Date: 12.AUG.2014 15:51:49



99% Occupied Bandwidth Plot on Channel 4233 (846.6 MHz)

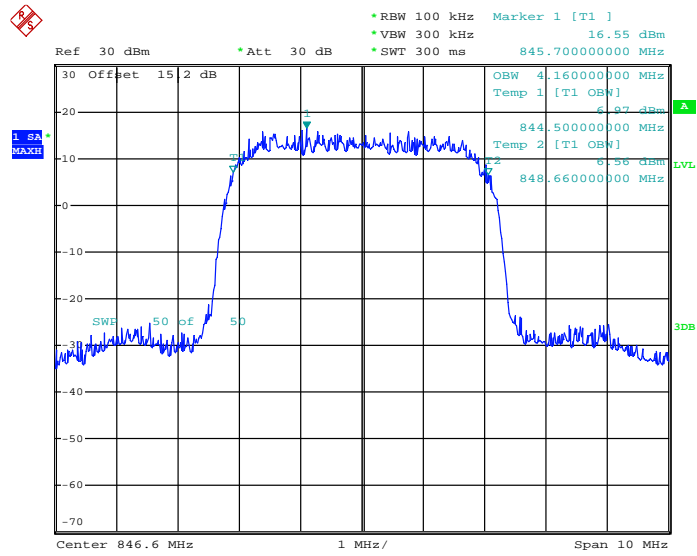

Date: 12.AUG.2014 15:54:35

26dB Bandwidth Plot on Channel 4233 (846.6 MHz)

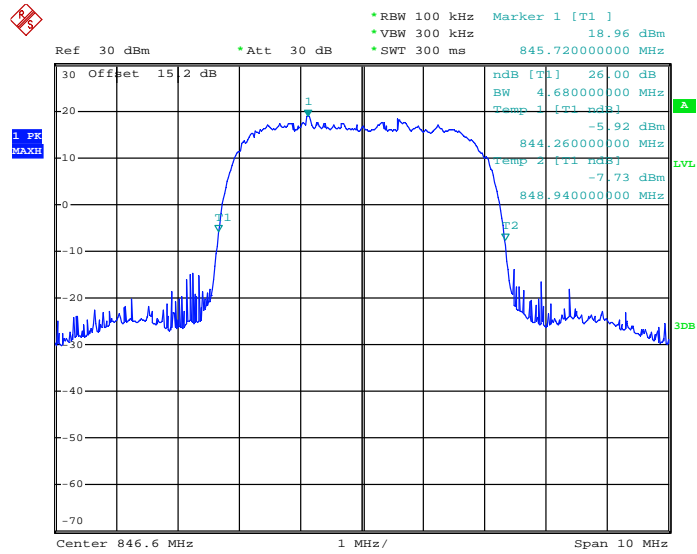

Date: 12.AUG.2014 15:52:15





### 99% Occupied Bandwidth Plot on Channel 9400 (1880.0 MHz)

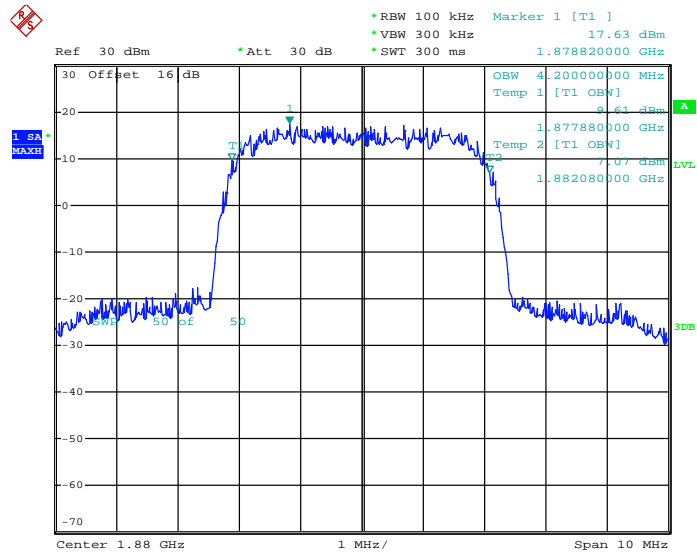

Date: 12.AUG.2014 16:48:45

### 26dB Bandwidth Plot on Channel 9400 (1880.0 MHz)

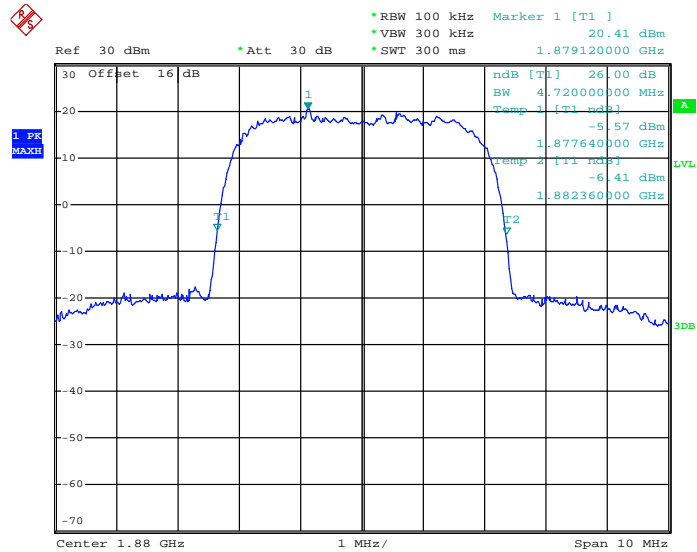

Date: 12.AUG.2014 16:46:20





### 99% Occupied Bandwidth Plot on Channel 9538 (1907.6 MHz)

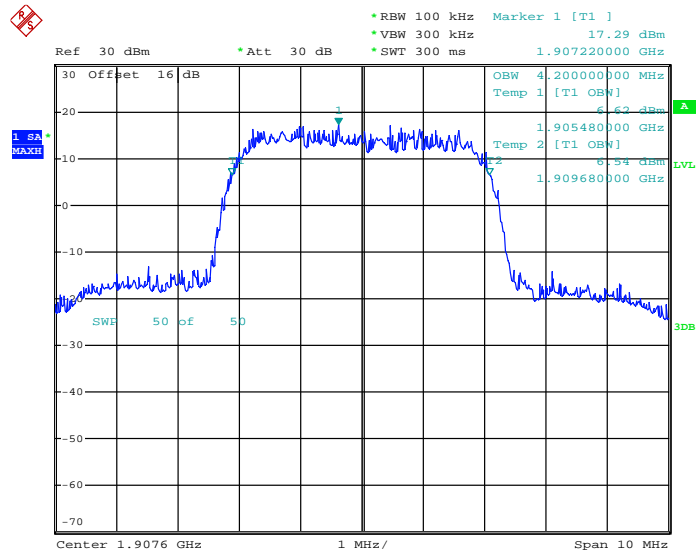

Date: 12.AUG.2014 16:49:06

### 26dB Bandwidth Plot on Channel 9538 (1907.6 MHz)

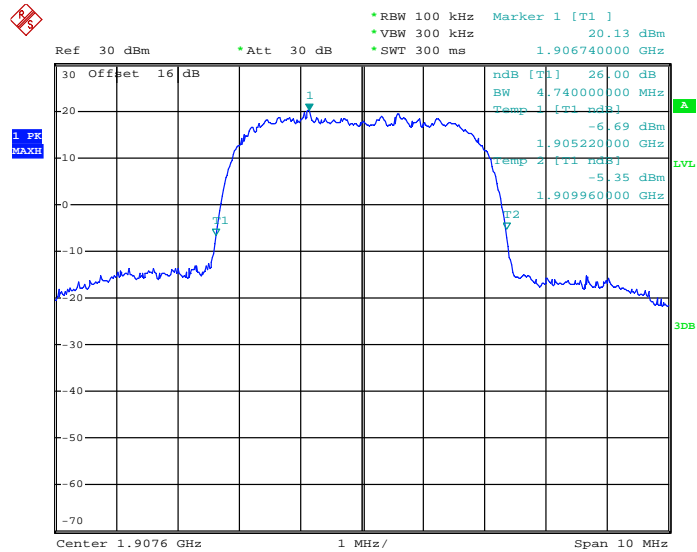

Date: 12.AUG.2014 16:46:46

## 3.5 Band Edge Measurement

### 3.5.1 Description of Band Edge Measurement

The power of any emission outside of the authorized operating frequency ranges must be lower than the transmitter power (P) by a factor of at least  $43 + 10 \log (P)$  dB.

### 3.5.2 Measuring Instruments

The measuring equipment is listed in the section 4 of this test report.

### 3.5.3 Test Procedures

1. The testing follows FCC KDB 971168 v02r01 Section 6.0.
2. The EUT was connected to the spectrum analyzer and system simulator via a power divider.
3. The RF output of EUT was connected to the spectrum analyzer by an RF cable and attenuator. The path loss was compensated to the results for each measurement.
4. The band edges of low and high channels for the highest RF powers were measured.
5. The RF fundamental frequency should be excluded against the limit line in the operating frequency band.
6. The limit line is derived from  $43 + 10\log(P)$  dB below the transmitter power P(Watts)  
 $= P(W) - [43 + 10\log(P)] \text{ (dB)}$   
 $= [30 + 10\log(P)] \text{ (dBm)} - [43 + 10\log(P)] \text{ (dB)}$   
 $= -13\text{dBm}.$

### 3.5.4 Test Setup

<Conducted Band Edge >

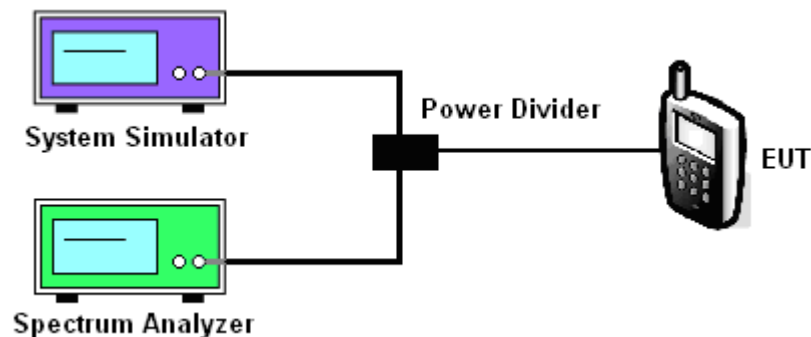

### 3.5.5 Test Result (Plots) of Conducted Band Edge

Band :	GSM850	Test Mode :	GSM Link (GMSK)
Correction Factor :	0.20dB	Maximum 26dB Bandwidth :	0.314MHz
Band Edge :	-15.07dBm	Measurement Value :	-15.27dBm

Lower Band Edge Plot on Channel 128 (824.2 MHz)

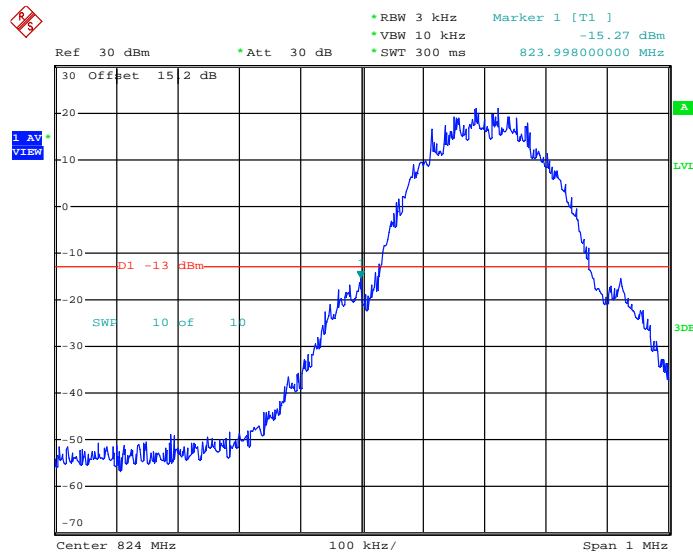

Date: 11.AUG.2014 12:40:05

1. Correction Factor(dB)=  $10\log(1\% \text{ Emission BW/RBW})$
2. Band Edge= Measurement Value + Correction Factor(dB)



Band :	GSM850	Test Mode :	GSM Link (GMSK)
Correction Factor :	0.20dB	Maximum 26dB Bandwidth :	0.314MHz
Band Edge :	-15.02dBm	Measurement Value :	-15.22dBm

Higher Band Edge Plot on Channel 251 (848.8 MHz)

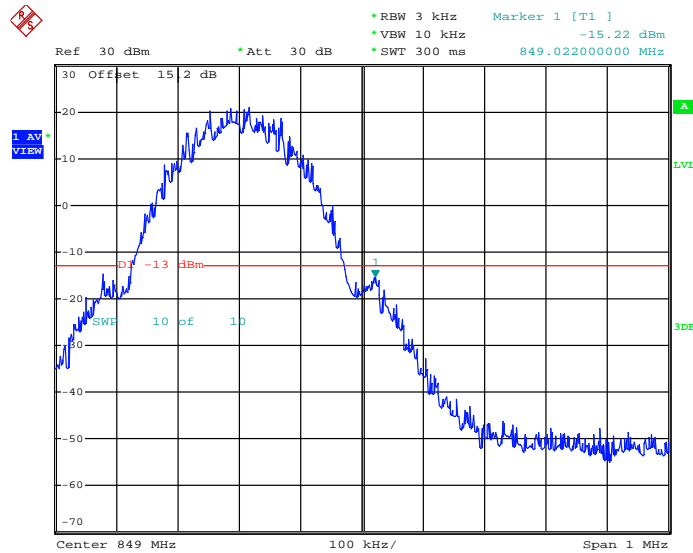

Date: 11.AUG.2014 12:40:34

1. Correction Factor(dB)= 10log(1% Emission BW/RBW)
2. Band Edge= Measurement Value + Correction Factor(dB)



Band :	GSM850	Test Mode :	EDGE class 8 Link (8PSK)
Correction Factor :	0.25dB	Maximum 26dB Bandwidth :	0.318MHz
Band Edge :	-25.57dBm	Measurement Value :	-25.82dBm

Lower Band Edge Plot on Channel 128 (824.2 MHz)

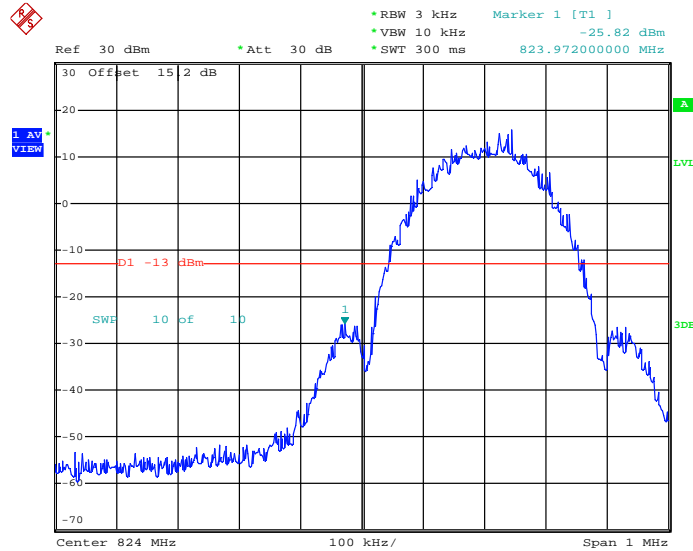

Date: 11.AUG.2014 15:59:35

1. Correction Factor(dB)= 10log(1% Emission BW/RBW)
2. Band Edge= Measurement Value + Correction Factor(dB)



Band :	GSM850	Test Mode :	EDGE class 8 Link (8PSK)
Correction Factor :	0.25dB	Maximum 26dB Bandwidth :	0.318MHz
Band Edge :	-25.53dBm	Measurement Value :	-25.78dBm

Higher Band Edge Plot on Channel 251 (848.8 MHz)

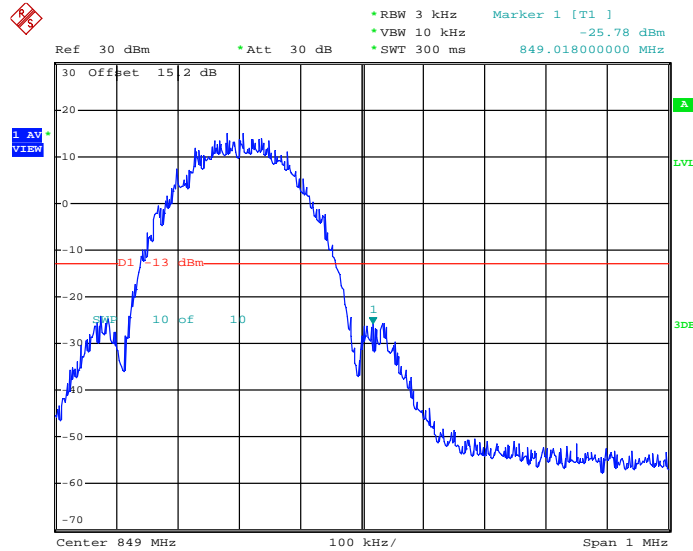

Date: 11.AUG.2014 15:58:28

1. Correction Factor(dB)= 10log(1% Emission BW/RBW)
2. Band Edge= Measurement Value + Correction Factor(dB)



Band :	GSM1900	Test Mode :	GSM Link (GMSK)
Correction Factor :	0.23dB	Maximum 26dB Bandwidth :	0.316MHz
Band Edge :	-25.62dBm	Measurement Value :	-25.85dBm

Lower Band Edge Plot on Channel 512 (1850.2 MHz)

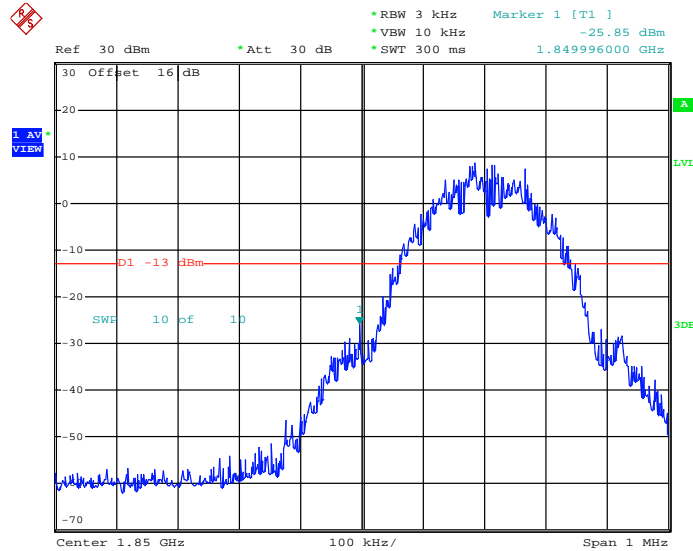

Date: 12.AUG.2014 14:46:15

1. Correction Factor(dB)= 10log(1% Emission BW/RBW)
2. Band Edge= Measurement Value + Correction Factor(dB)



Band :	GSM1900	Test Mode :	GSM Link (GMSK)
Correction Factor :	0.23dB	Maximum 26dB Bandwidth :	0.316MHz
Band Edge :	-27.77dBm	Measurement Value :	-28.00dBm

Higher Band Edge Plot on Channel 810 (1909.8 MHz)

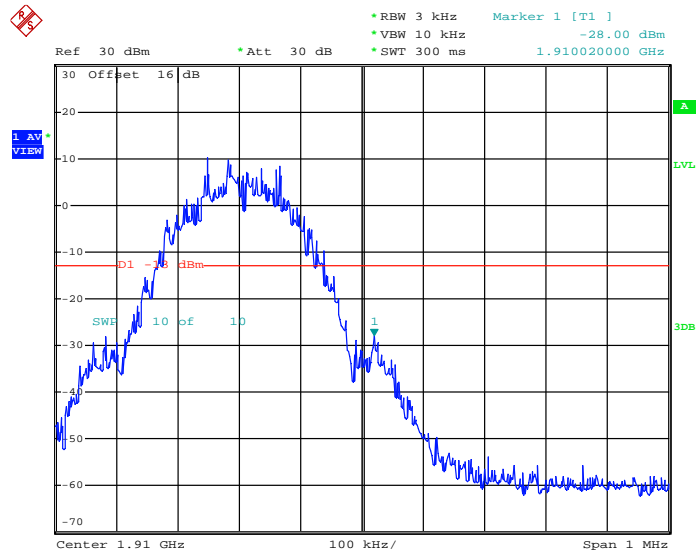

Date: 12.AUG.2014 14:45:02

1. Correction Factor(dB)= 10log(1% Emission BW/RBW)
2. Band Edge= Measurement Value + Correction Factor(dB)





Band :	GSM1900	Test Mode :	EDGE class 8 Link (8PSK)
Correction Factor :	0.25dB	Maximum 26dB Bandwidth :	0.318MHz
Band Edge :	-24.06dBm	Measurement Value :	-24.31dBm

Lower Band Edge Plot on Channel 512 (1850.2 MHz)

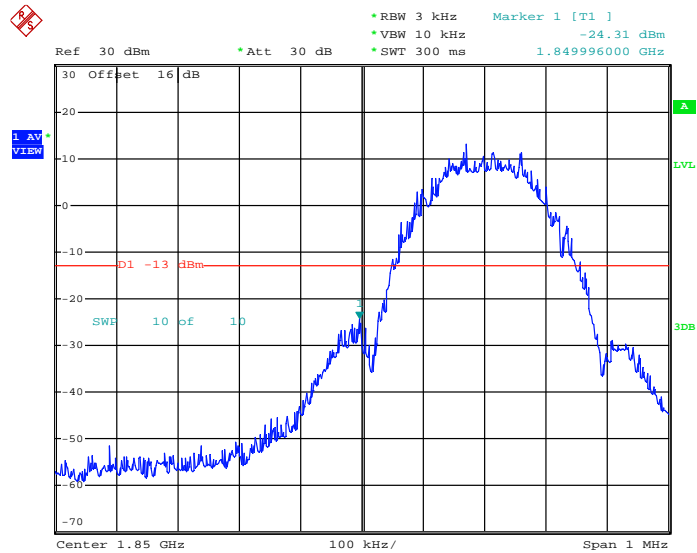

Date: 12.AUG.2014 12:12:49

1. Correction Factor(dB)=  $10\log(1\% \text{ Emission BW/RBW})$
2. Band Edge= Measurement Value + Correction Factor(dB)



Band :	GSM1900	Test Mode :	EDGE class 8 Link (8PSK)
Correction Factor :	0.25dB	Maximum 26dB Bandwidth :	0.318MHz
Band Edge :	-26.48dBm	Measurement Value :	-26.73dBm

Higher Band Edge Plot on Channel 810 (1909.8 MHz)

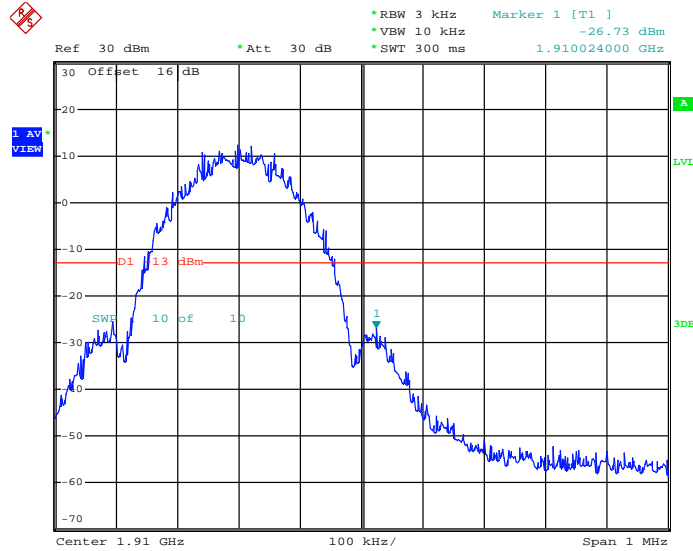

Date: 12.AUG.2014 12:14:43

1. Correction Factor(dB)= 10log(1% Emission BW/RBW)
2. Band Edge= Measurement Value + Correction Factor(dB)



Band :	WCDMA Band V	Test Mode :	RMC 12.2Kbps Link (QPSK)
Correction Factor :	-3.26dB	Maximum 26dB Bandwidth :	4.720MHz
Band Edge :	-27.22dBm	Measurement Value :	-23.96dBm

Lower Band Edge Plot on Channel 4132 (826.4 MHz)

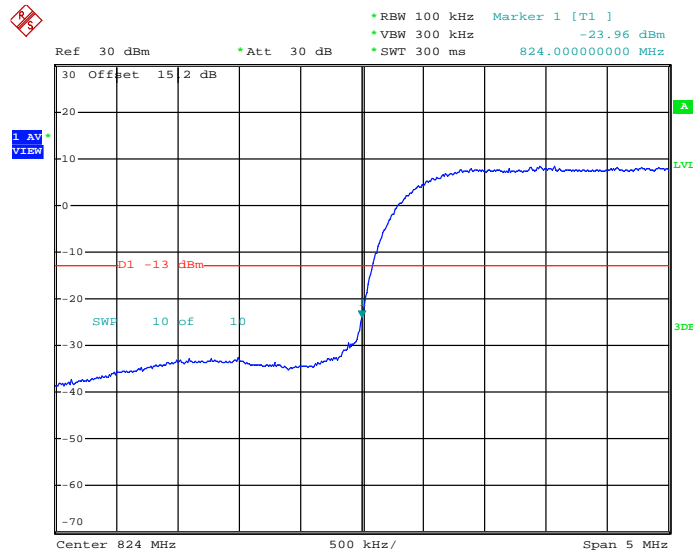

Date: 12.AUG.2014 15:55:58

1. Correction Factor(dB)= 10log(1% Emission BW/RBW)
2. Band Edge= Measurement Value + Correction Factor(dB)



Band :	WCDMA Band V	Test Mode :	RMC 12.2Kbps Link (QPSK)
Correction Factor :	-3.26dB	Maximum 26dB Bandwidth :	4.720MHz
Band Edge :	-28.41dBm	Measurement Value :	-25.15dBm

Higher Band Edge Plot on Channel 4233 (846.6 MHz)

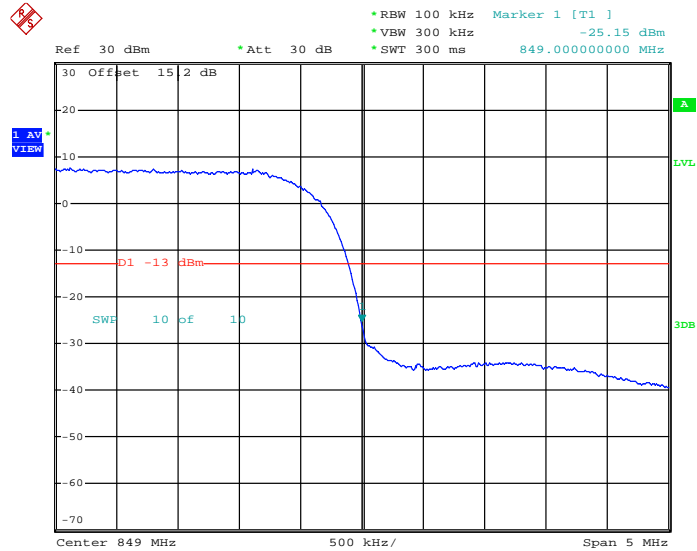

Date: 12.AUG.2014 15:56:27

1. Correction Factor(dB)= 10log(1% Emission BW/RBW)
2. Band Edge= Measurement Value + Correction Factor(dB)



<b>Band :</b>	WCDMA Band II	<b>Test Mode :</b>	RMC 12.2Kbps Link (QPSK)
<b>Correction Factor :</b>	-3.24dB	<b>Maximum 26dB Bandwidth :</b>	4.740MHz
<b>Band Edge :</b>	-26.03dBm	<b>Measurement Value :</b>	-22.79dBm

Lower Band Edge Plot on Channel 9262 (1852.4 MHz)

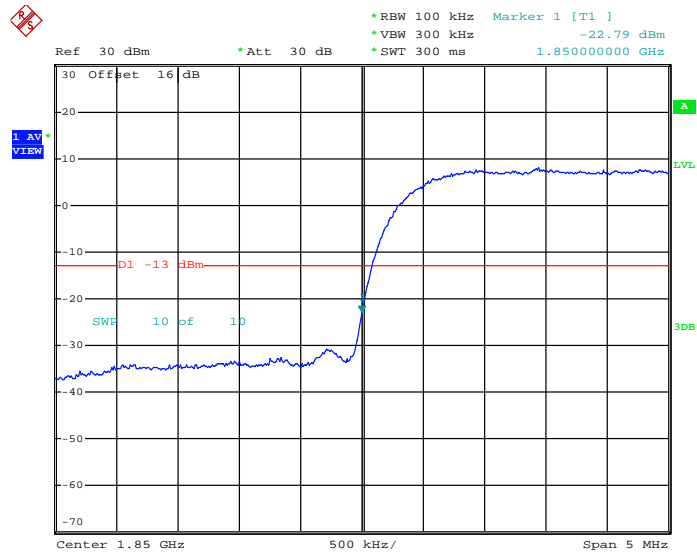

Date: 12.AUG.2014 16:50:28

1. Correction Factor(dB)= 10log(1% Emission BW/RBW)
2. Band Edge= Measurement Value + Correction Factor(dB)



<b>Band :</b>	WCDMA Band II	<b>Test Mode :</b>	RMC 12.2Kbps Link (QPSK)
<b>Correction Factor :</b>	-3.24dB	<b>Maximum 26dB Bandwidth :</b>	4.740MHz
<b>Band Edge :</b>	-19.39dBm	<b>Measurement Value :</b>	-16.15dBm

Higher Band Edge Plot on Channel 9538 (1907.6 MHz)

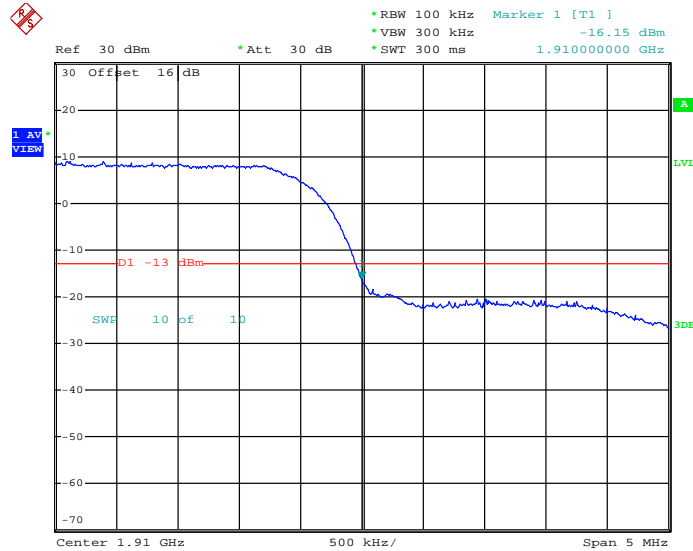

Date: 12.AUG.2014 16:50:58

1. Correction Factor(dB)= 10log(1% Emission BW/RBW)
2. Band Edge= Measurement Value + Correction Factor(dB)

## 3.6 Conducted Spurious Emission Measurement

### 3.6.1 Description of Conducted Spurious Emission Measurement

The power of any emission outside of the authorized operating frequency ranges must be lower than the transmitter power (P) by a factor of at least  $43 + 10 \log (P)$  dB.

It is measured by means of a calibrated spectrum analyzer and scanned from 30 MHz up to a frequency including its 10<sup>th</sup> harmonic.

### 3.6.2 Measuring Instruments

The measuring equipment is listed in the section 4 of this test report.

### 3.6.3 Test Procedures

1. The testing follows FCC KDB 971168 v02r01 Section 6.0.
2. The EUT was connected to the spectrum analyzer and system simulator via a power divider.
3. The RF output of EUT was connected to the spectrum analyzer by an RF cable and attenuator. The path loss was compensated to the results for each measurement.
4. The middle channel for the highest RF power within the transmitting frequency was measured.
5. The conducted spurious emission for the whole frequency range was taken.
6. The RF fundamental frequency should be excluded against the limit line in the operating frequency band.
7. The limit line is derived from  $43 + 10\log(P)$  dB below the transmitter power P(Watts)  
 $= P(W) - [43 + 10\log(P)]$  (dB)  
 $= [30 + 10\log(P)]$  (dBm) -  $[43 + 10\log(P)]$  (dB)  
 $= -13\text{dBm}$ .

### 3.6.4 Test Setup

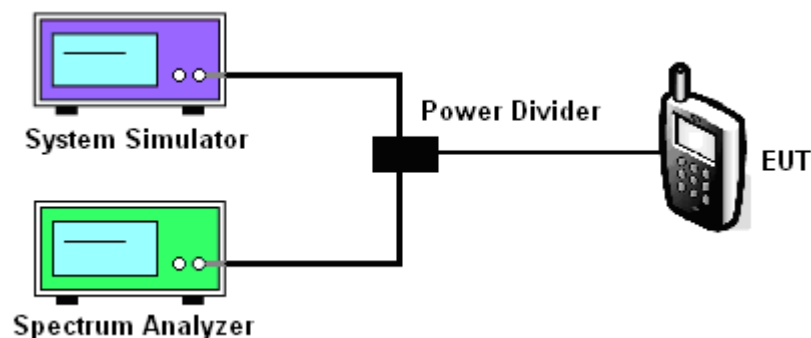



### 3.6.5 Test Result (Plots) of Conducted Spurious Emission

Band :	GSM850	Channel :	CH128
Test Mode :	GSM Link (GMSK)	Frequency :	824.2 MHz

Conducted Spurious Emission Plot between 30MHz ~ 1GHz

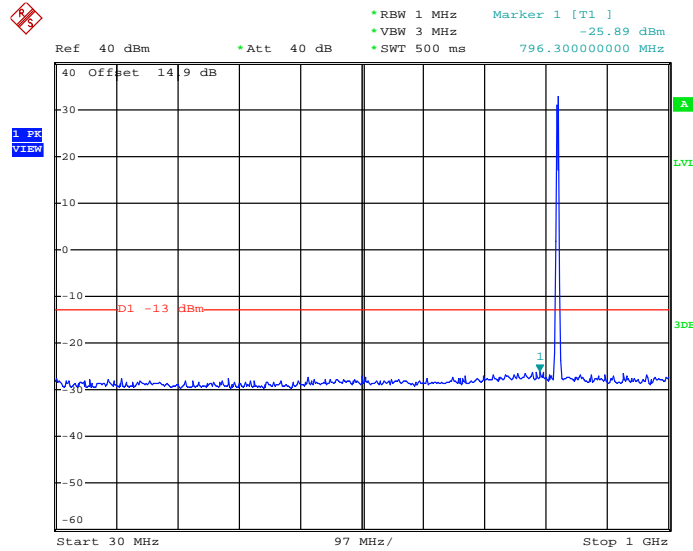

Date: 12.AUG.2014 15:21:42

Conducted Spurious Emission Plot between 1GHz ~ 3GHz

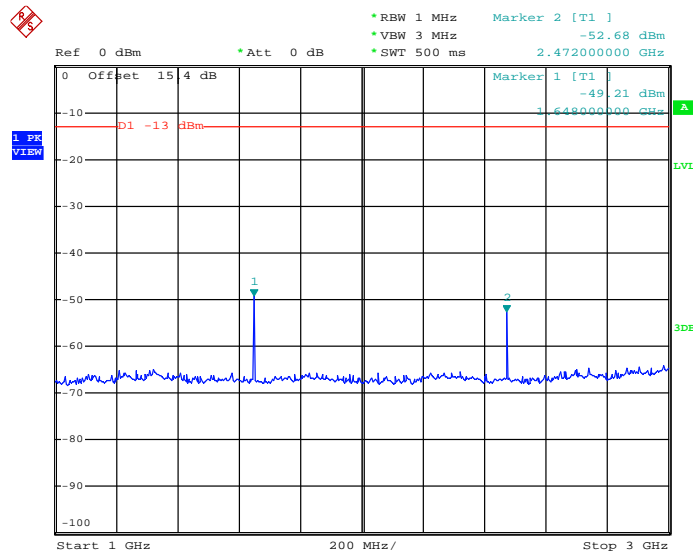

Date: 12.AUG.2014 15:30:04





### Conducted Spurious Emission Plot between 3GHz ~ 7GHz

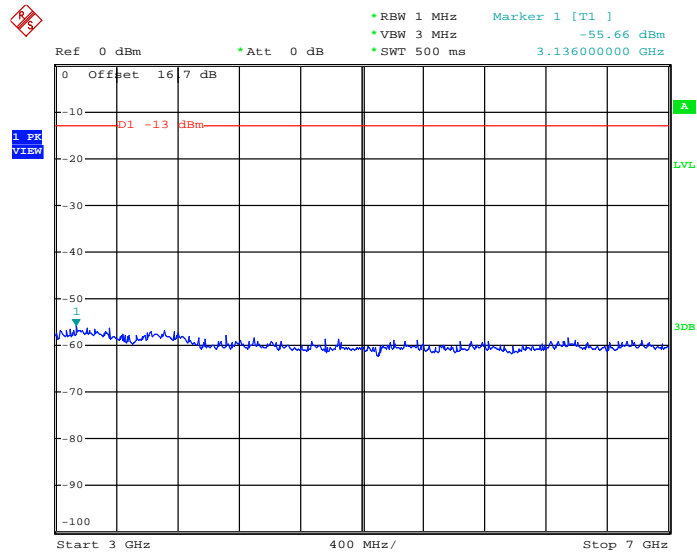

Date: 12.AUG.2014 15:32:26

### Conducted Spurious Emission Plot between 7GHz ~ 9GHz

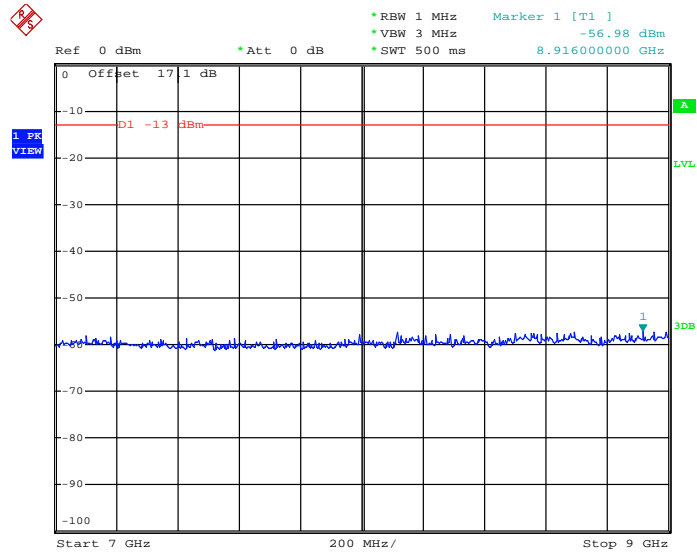

Date: 12.AUG.2014 15:36:34



Band :	GSM850	Channel :	CH189
Test Mode :	GSM Link (GMSK)	Frequency :	836.4 MHz

Conducted Spurious Emission Plot between 30MHz ~ 1GHz

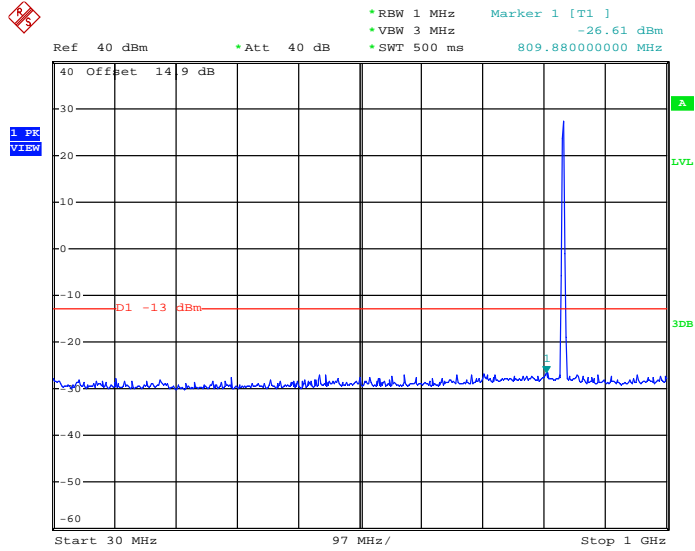

Date: 12.AUG.2014 15:23:05

Conducted Spurious Emission Plot between 1GHz ~ 3GHz

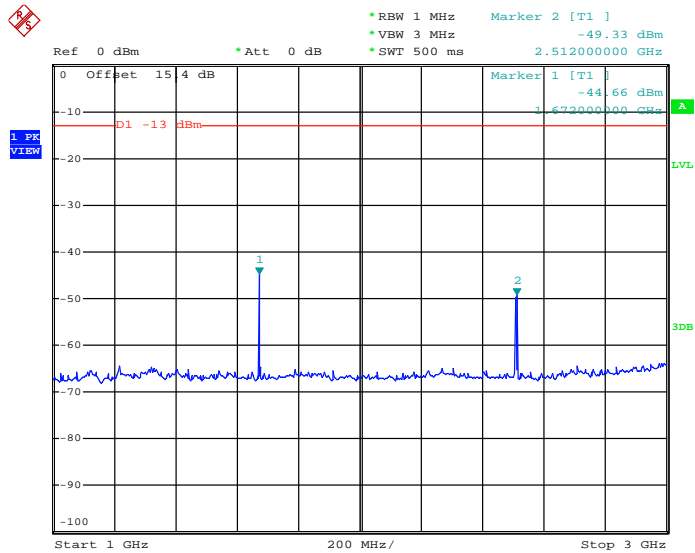

Date: 12.AUG.2014 15:29:24



### Conducted Spurious Emission Plot between 3GHz ~ 7GHz

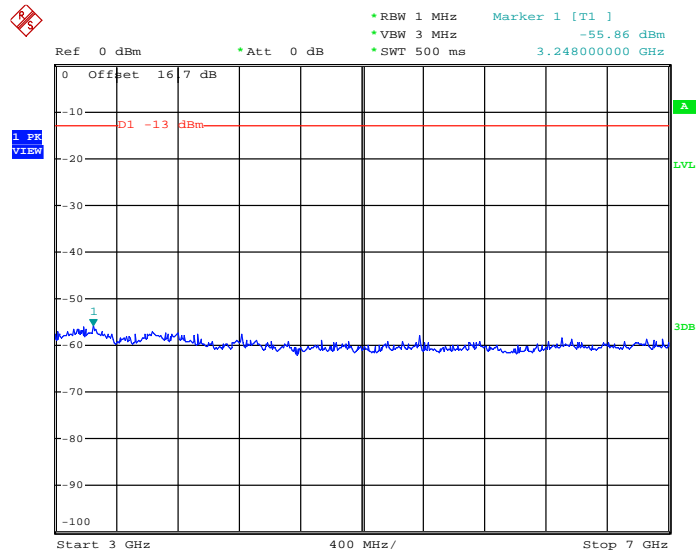

Date: 12.AUG.2014 15:32:55

### Conducted Spurious Emission Plot between 7GHz ~ 9GHz

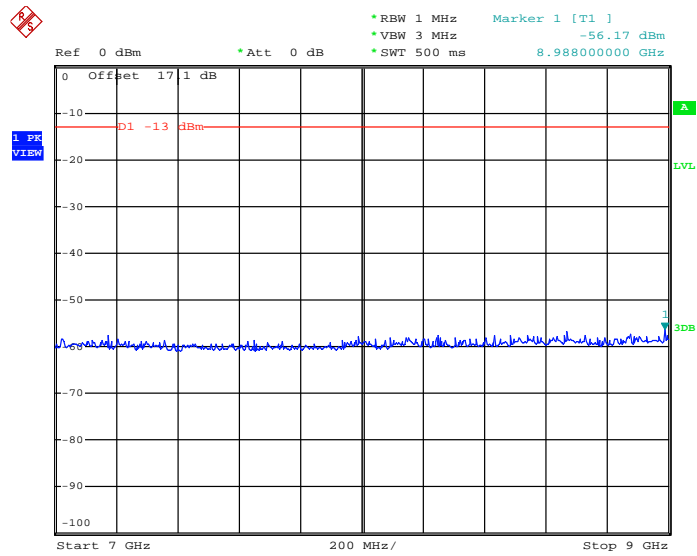

Date: 12.AUG.2014 15:36:00



Band :	GSM850	Channel :	CH251
Test Mode :	GSM Link (GMSK)	Frequency :	848.8 MHz

Conducted Spurious Emission Plot between 30MHz ~ 1GHz

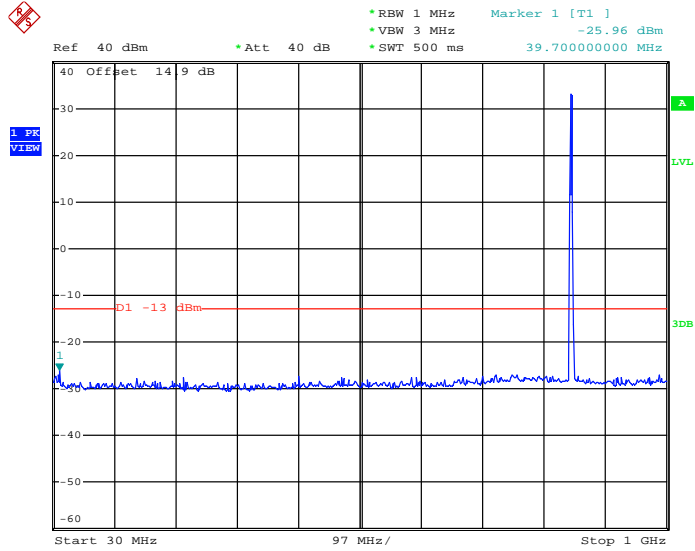

Date: 12.AUG.2014 15:24:01

Conducted Spurious Emission Plot between 1GHz ~ 3GHz

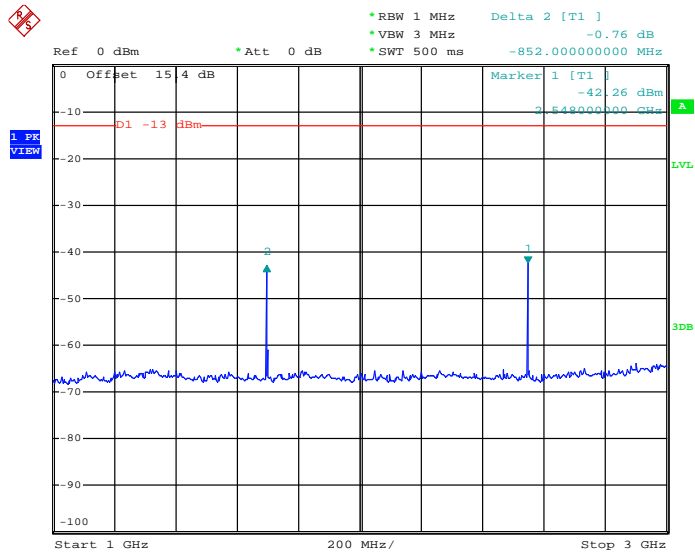

Date: 12.AUG.2014 15:27:12



### Conducted Spurious Emission Plot between 3GHz ~ 7GHz

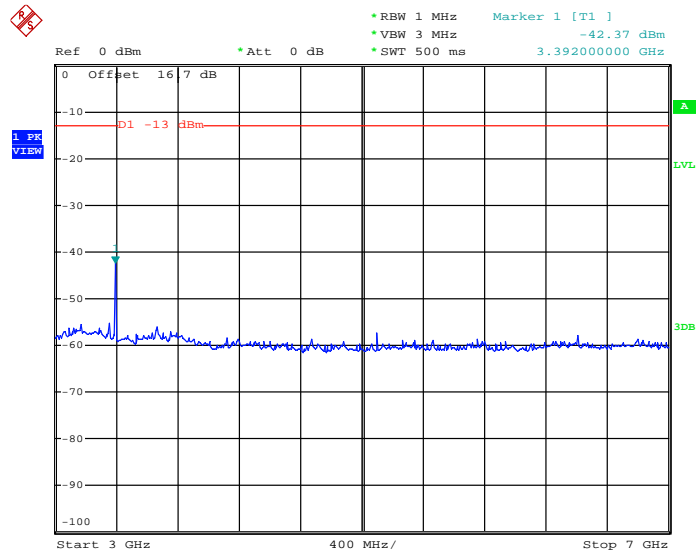

Date: 12.AUG.2014 15:33:58

### Conducted Spurious Emission Plot between 7GHz ~ 9GHz

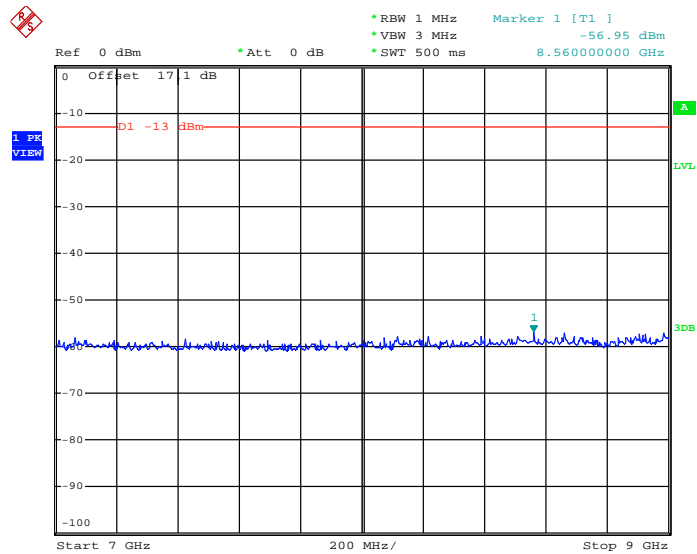

Date: 12.AUG.2014 15:35:07



Band :	GSM850	Channel :	CH128
Test Mode :	EDGE class 8 Link (8PSK)	Frequency :	824.2 MHz

Conducted Spurious Emission Plot between 30MHz ~ 1GHz

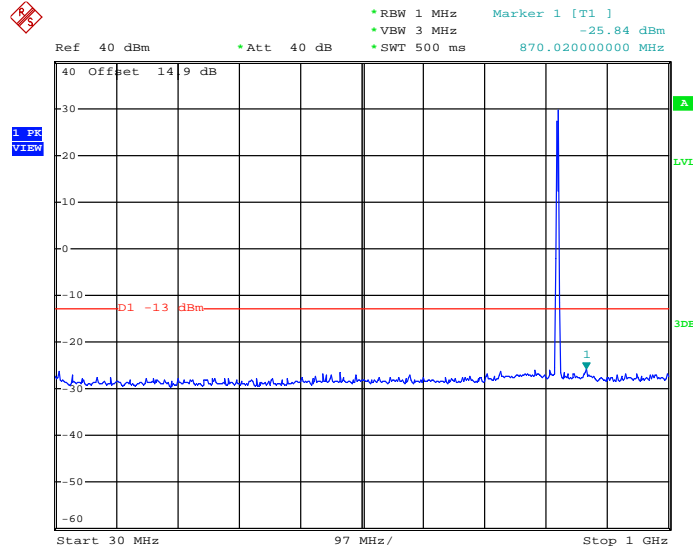

Date: 11.AUG.2014 17:43:56

Conducted Spurious Emission Plot between 1GHz ~ 3GHz

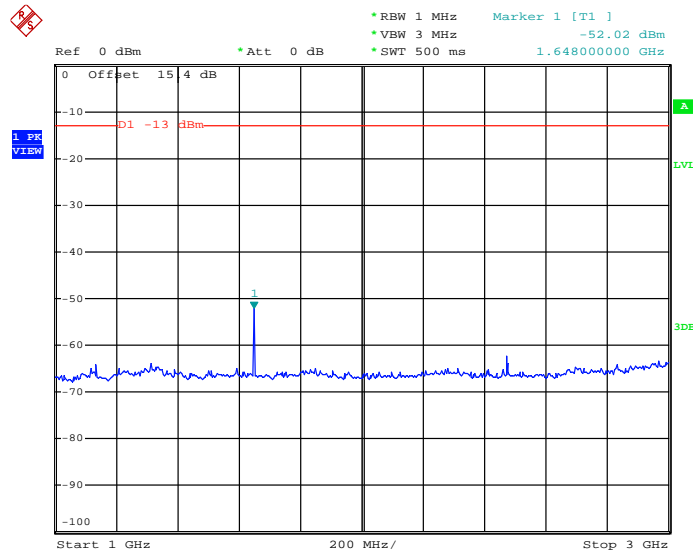

Date: 11.AUG.2014 18:41:43



### Conducted Spurious Emission Plot between 3GHz ~ 7GHz

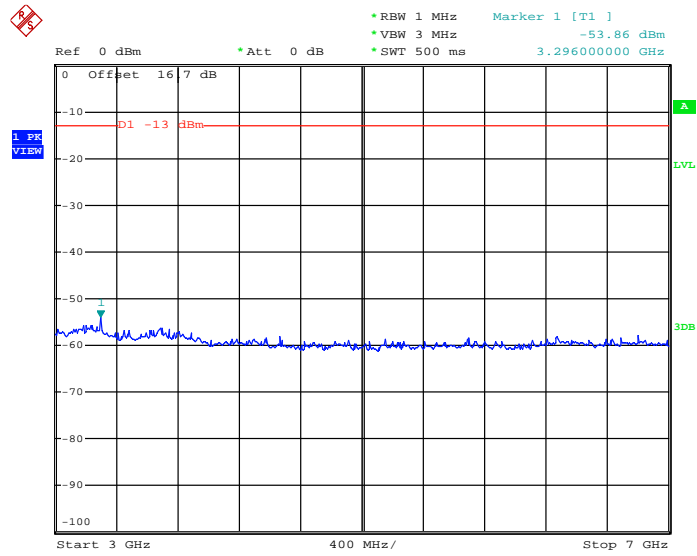

Date: 11.AUG.2014 18:44:05

### Conducted Spurious Emission Plot between 7GHz ~ 9GHz

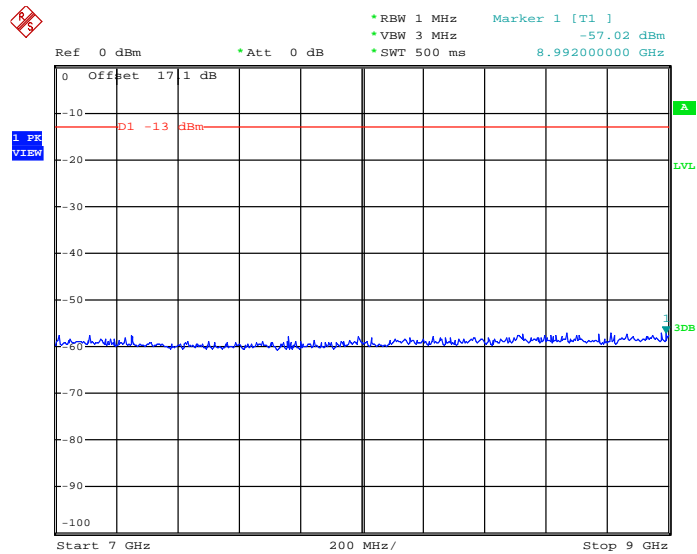

Date: 11.AUG.2014 19:17:00



Band :	GSM850	Channel :	CH189
Test Mode :	EDGE class 8 Link (8PSK)	Frequency :	836.4 MHz

Conducted Spurious Emission Plot between 30MHz ~ 1GHz

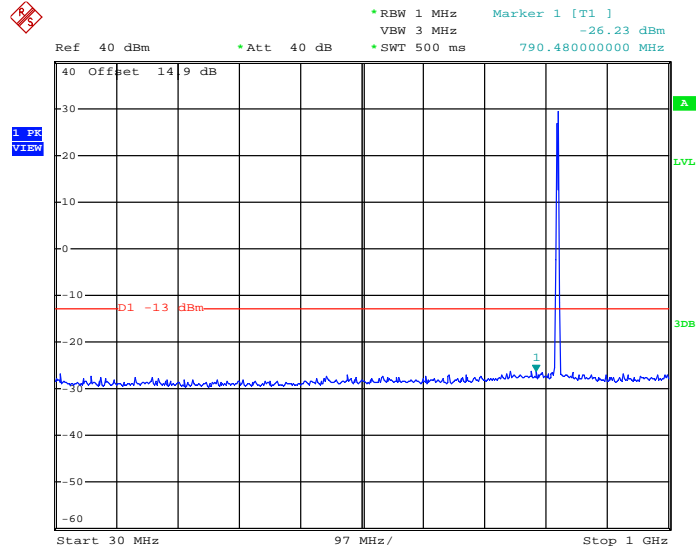

Date: 11.AUG.2014 19:26:18

Conducted Spurious Emission Plot between 1GHz ~ 3GHz

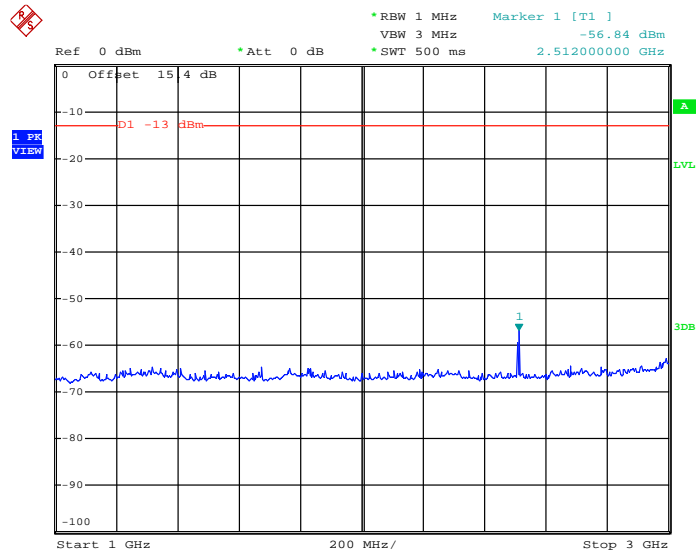

Date: 11.AUG.2014 19:43:10





### Conducted Spurious Emission Plot between 3GHz ~ 7GHz

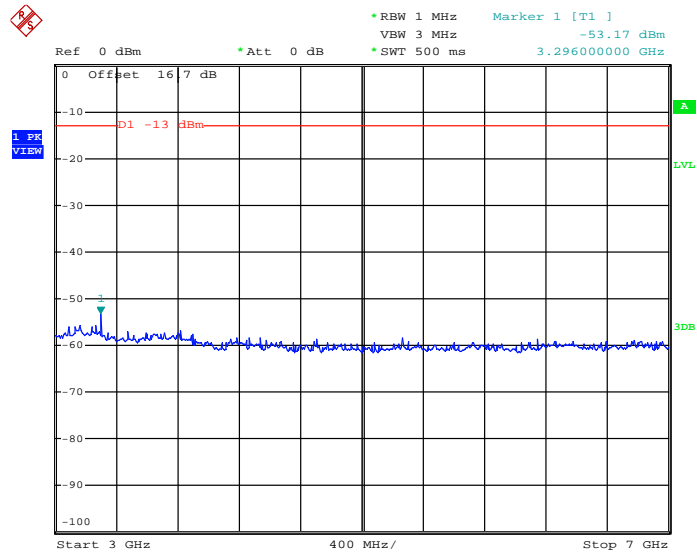

Date: 11.AUG.2014 19:33:46

### Conducted Spurious Emission Plot between 7GHz ~ 9GHz

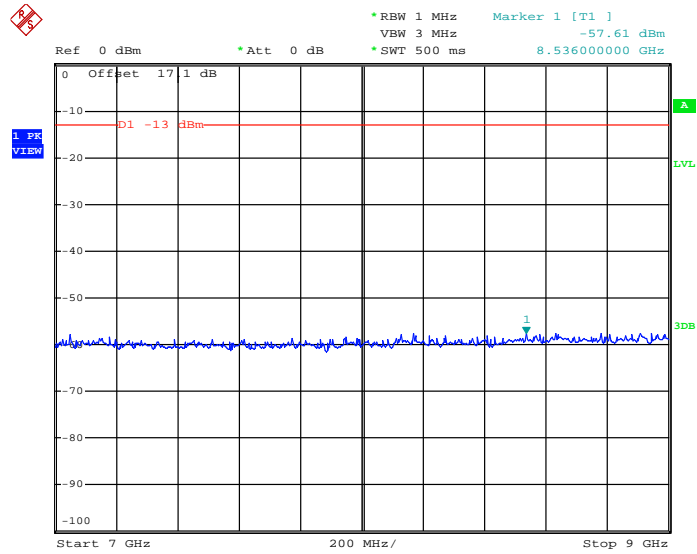

Date: 11.AUG.2014 19:34:57



Band :	GSM850	Channel :	CH251
Test Mode :	EDGE class 8 Link (8PSK)	Frequency :	848.8 MHz

Conducted Spurious Emission Plot between 30MHz ~ 1GHz

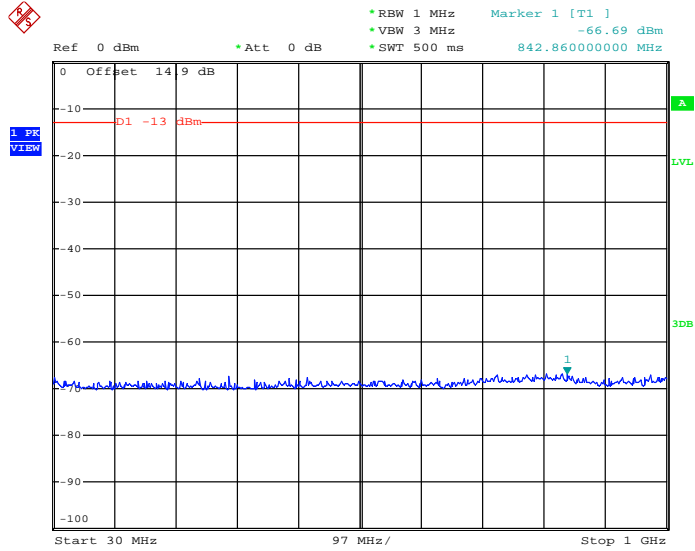

Date: 11.AUG.2014 16:27:29

Conducted Spurious Emission Plot between 1GHz ~ 3GHz

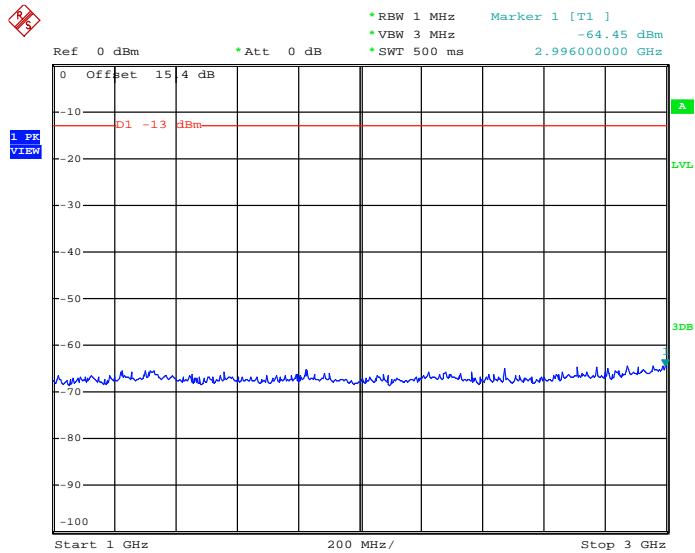

Date: 11.AUG.2014 16:17:26



### Conducted Spurious Emission Plot between 3GHz ~ 7GHz

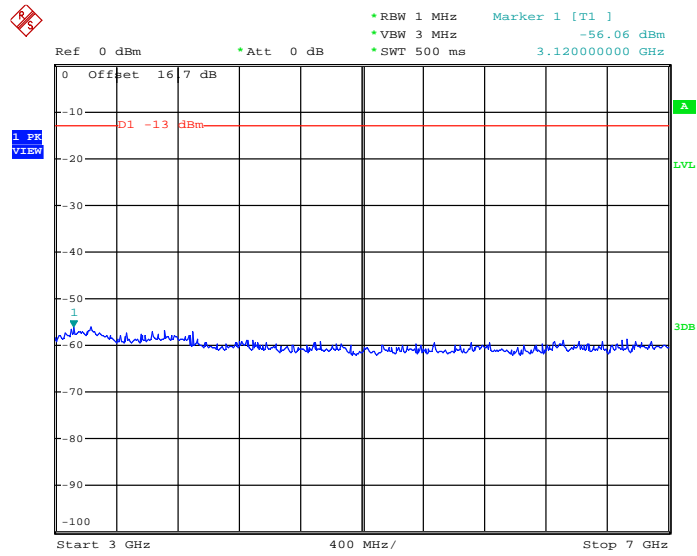

Date: 11.AUG.2014 16:19:07

### Conducted Spurious Emission Plot between 7GHz ~ 9GHz

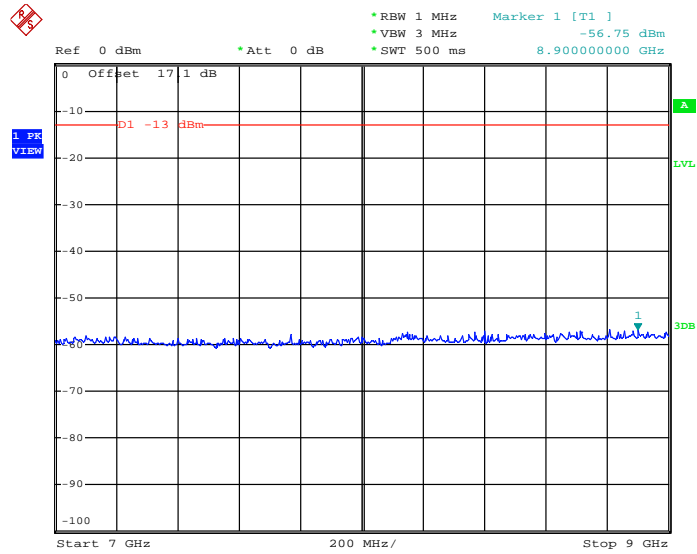

Date: 11.AUG.2014 16:20:45



<b>Band :</b>	GSM1900	<b>Channel :</b>	CH512
<b>Test Mode :</b>	GSM Link (GMSK)	<b>Frequency :</b>	1850.2 MHz

Conducted Spurious Emission Plot between 30MHz ~ 1GHz

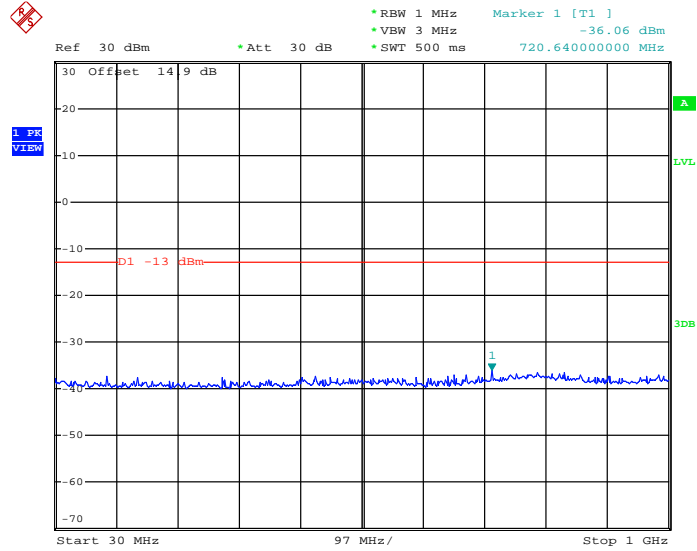

Date: 12.AUG.2014 14:49:33

Conducted Spurious Emission Plot between 1GHz ~ 3GHz

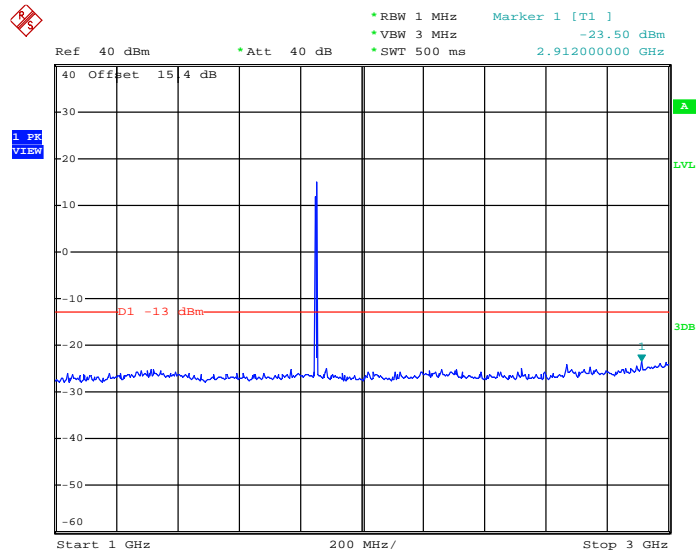

Date: 12.AUG.2014 14:55:39



### Conducted Spurious Emission Plot between 3GHz ~ 7GHz

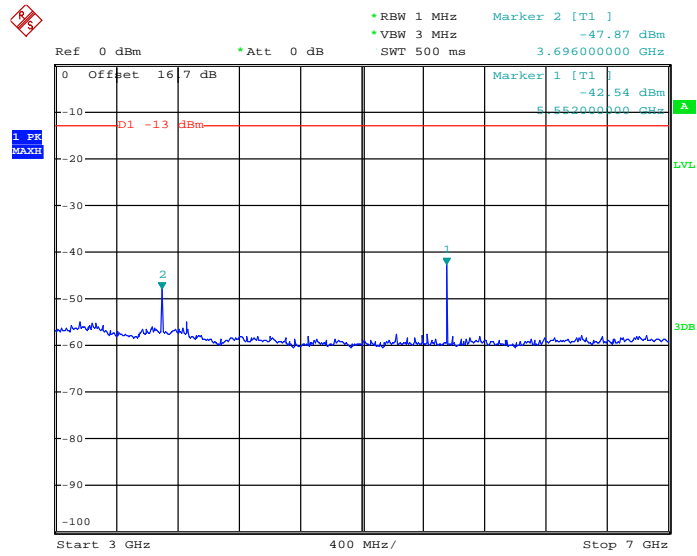

Date: 12.AUG.2014 14:58:00

### Conducted Spurious Emission Plot between 7GHz ~ 13.6GHz

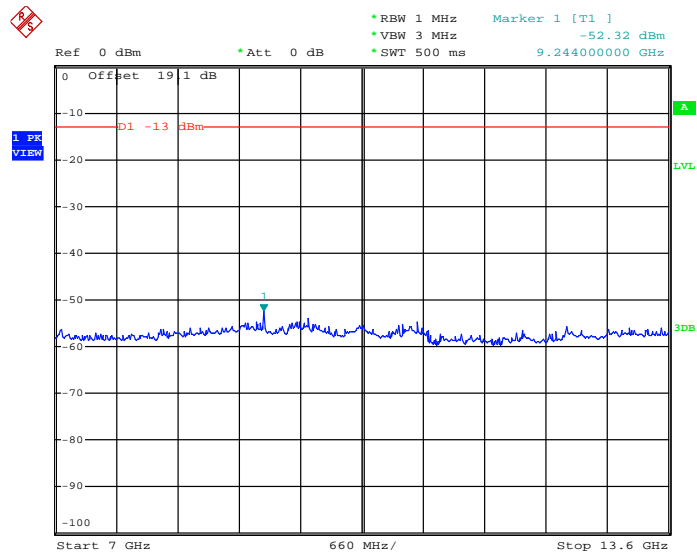

Date: 12.AUG.2014 15:04:48



Conducted Spurious Emission Plot between 13.6GHz ~ 19.1GHz

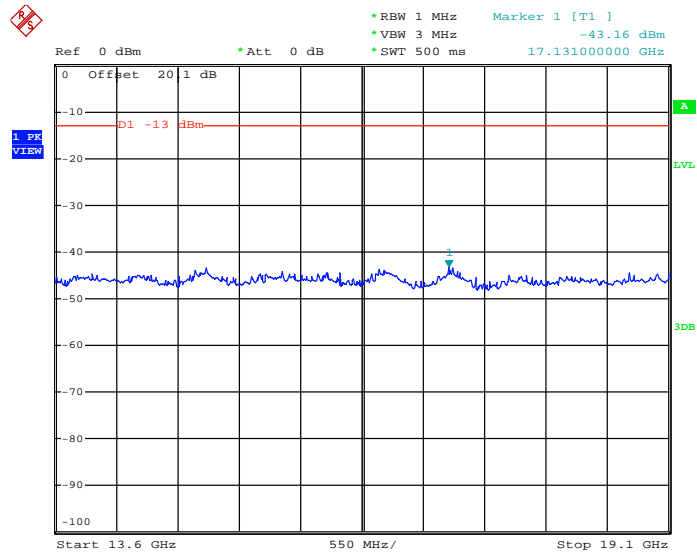

Date: 12.AUG.2014 15:06:43



Band :	GSM1900	Channel :	CH661
Test Mode :	GSM Link (GMSK)	Frequency :	1880.0 MHz

Conducted Spurious Emission Plot between 30MHz ~ 1GHz

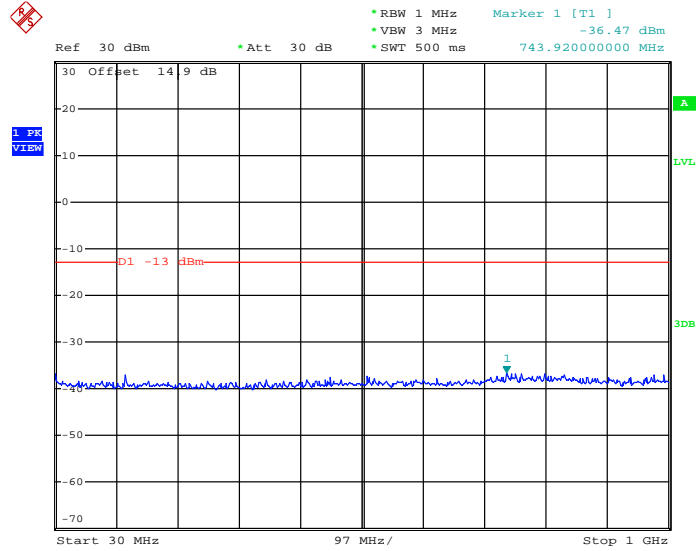

Date: 12.AUG.2014 14:50:15

Conducted Spurious Emission Plot between 1GHz ~ 3GHz

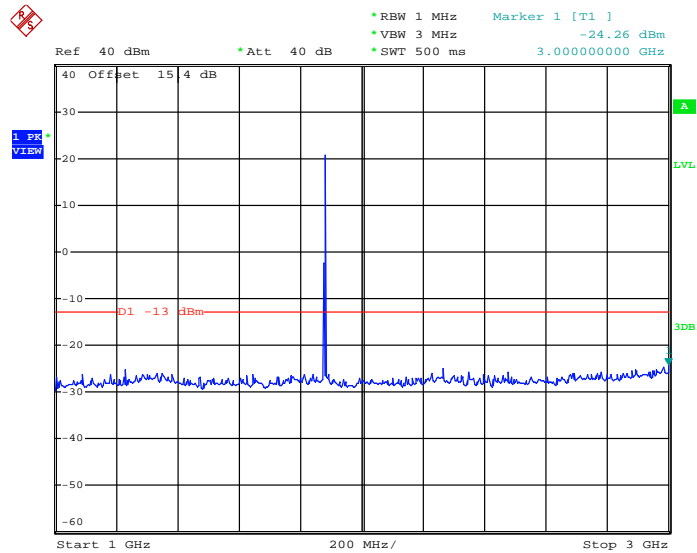

Date: 12.AUG.2014 14:54:01



### Conducted Spurious Emission Plot between 3GHz ~ 7GHz

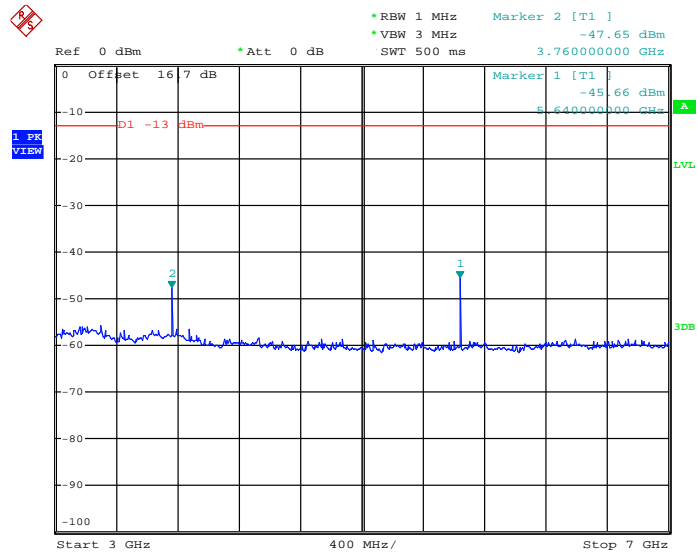

Date: 12.AUG.2014 14:59:09

### Conducted Spurious Emission Plot between 7GHz ~ 13.6GHz

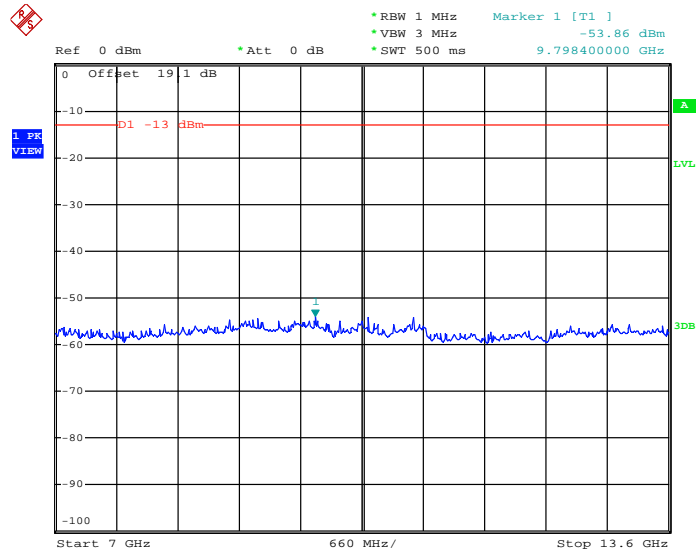

Date: 12.AUG.2014 15:04:12





Conducted Spurious Emission Plot between 13.6GHz ~ 19.1GHz

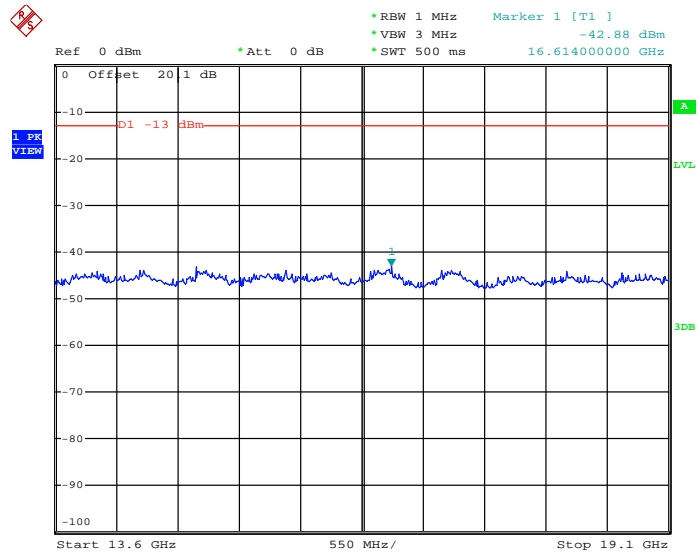

Date: 12.AUG.2014 15:07:21



Band :	GSM1900	Channel :	CH810
Test Mode :	GSM Link (GMSK)	Frequency :	1909.8 MHz

Conducted Spurious Emission Plot between 30MHz ~ 1GHz

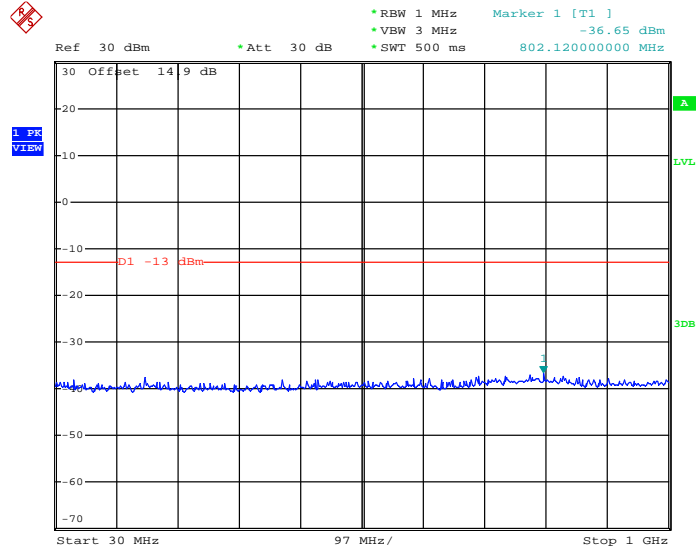

Date: 12.AUG.2014 14:50:47

Conducted Spurious Emission Plot between 1GHz ~ 3GHz

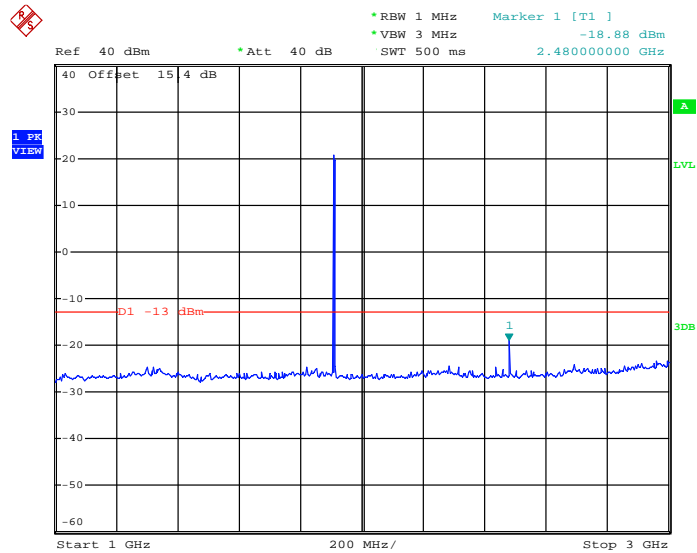

Date: 12.AUG.2014 14:52:30



### Conducted Spurious Emission Plot between 3GHz ~ 7GHz

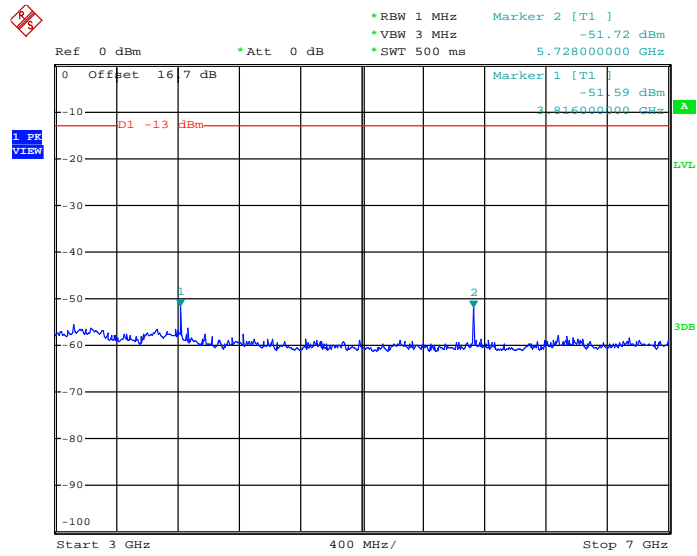

Date: 12.AUG.2014 15:00:58

### Conducted Spurious Emission Plot between 7GHz ~ 13.6GHz

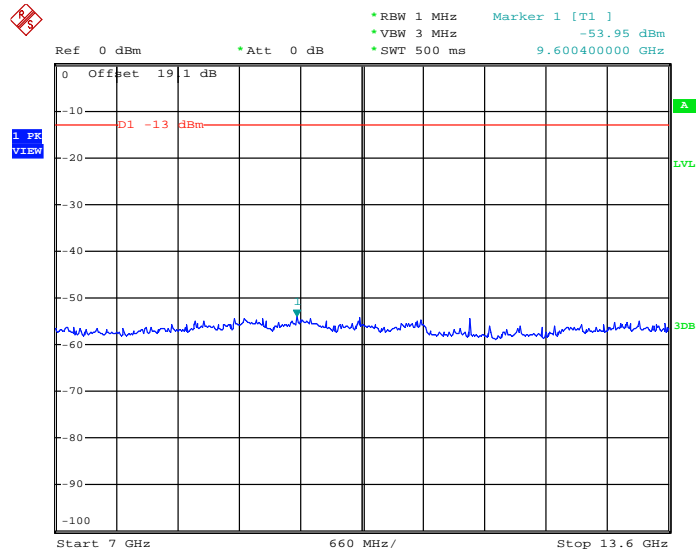

Date: 12.AUG.2014 15:03:36



Conducted Spurious Emission Plot between 13.6GHz ~ 19.1GHz

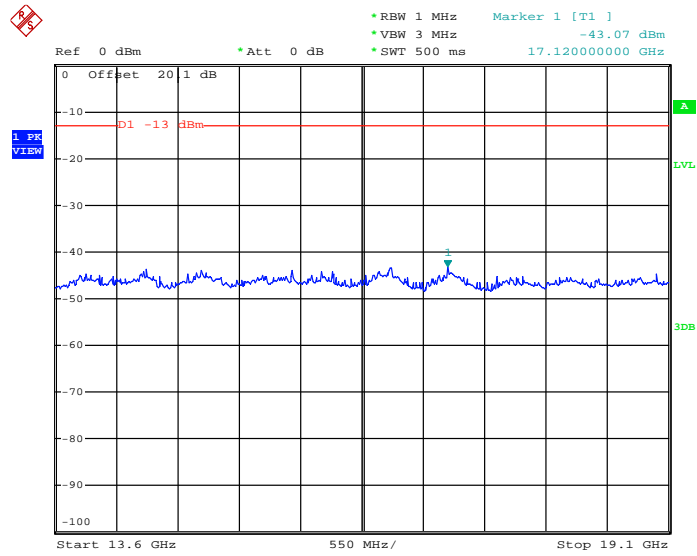

Date: 12.AUG.2014 15:07:53



Band :	GSM1900	Channel :	CH512
Test Mode :	EDGE class 8 Link (8PSK)	Frequency :	1850.2 MHz

Conducted Spurious Emission Plot between 30MHz ~ 1GHz

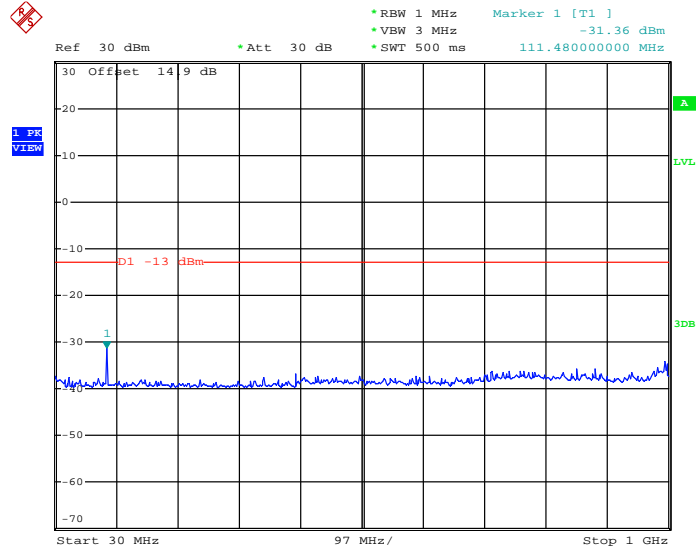

Date: 12.AUG.2014 12:24:16

Conducted Spurious Emission Plot between 1GHz ~ 3GHz

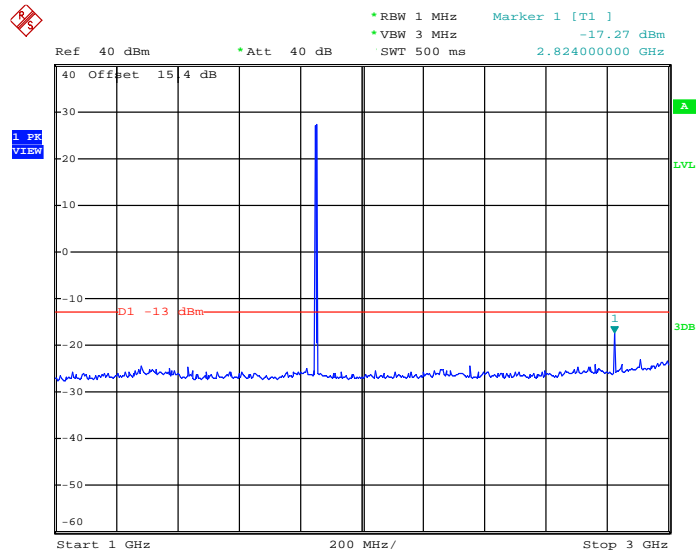

Date: 12.AUG.2014 12:26:37



### Conducted Spurious Emission Plot between 3GHz ~ 7GHz

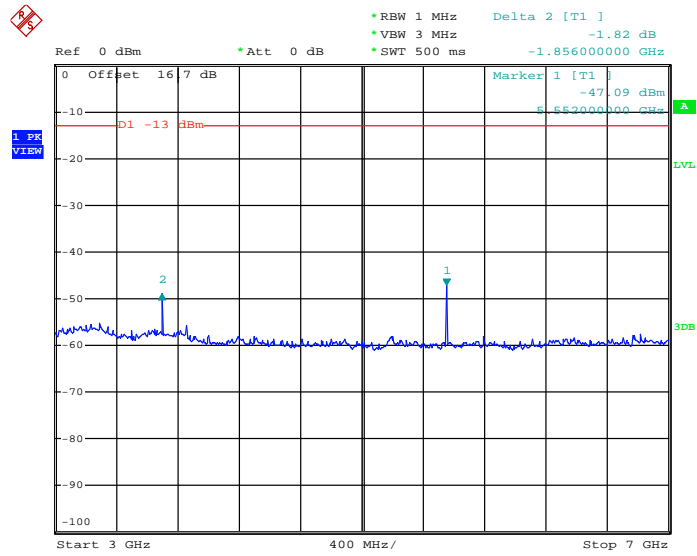

Date: 12.AUG.2014 12:50:43

### Conducted Spurious Emission Plot between 7GHz ~ 13.6GHz

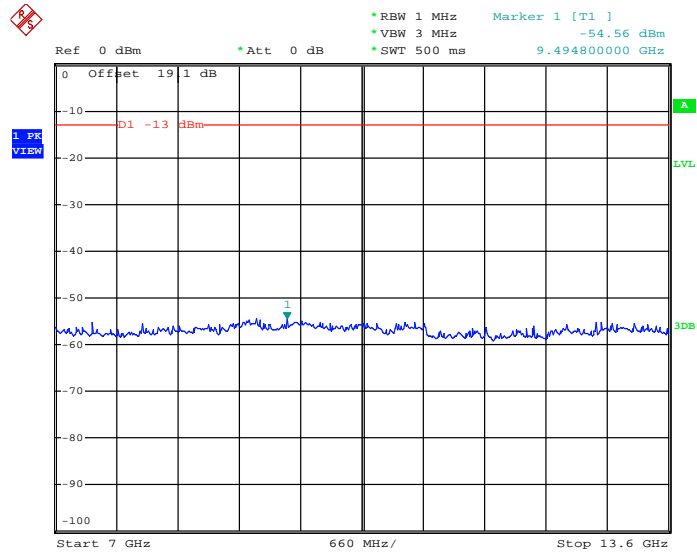

Date: 12.AUG.2014 12:37:36



Conducted Spurious Emission Plot between 13.6GHz ~ 19.1GHz

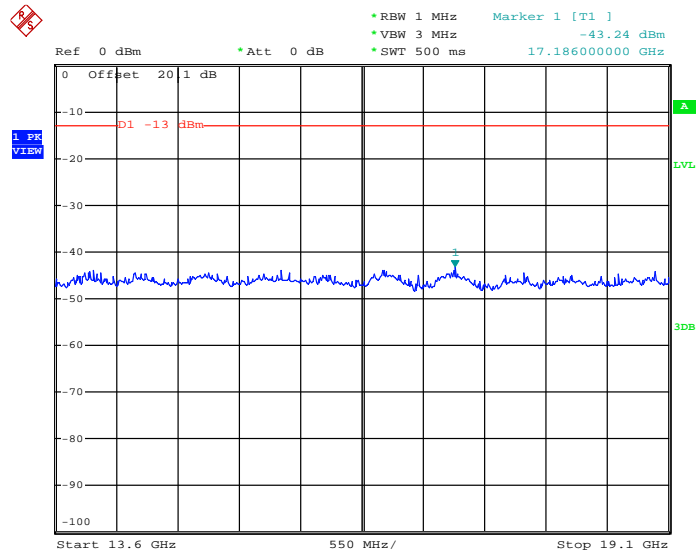

Date: 12.AUG.2014 12:56:09



<b>Band :</b>	GSM1900	<b>Channel :</b>	CH661
<b>Test Mode :</b>	EDGE class 8 Link (8PSK)	<b>Frequency :</b>	1880.0 MHz

Conducted Spurious Emission Plot between 30MHz ~ 1GHz

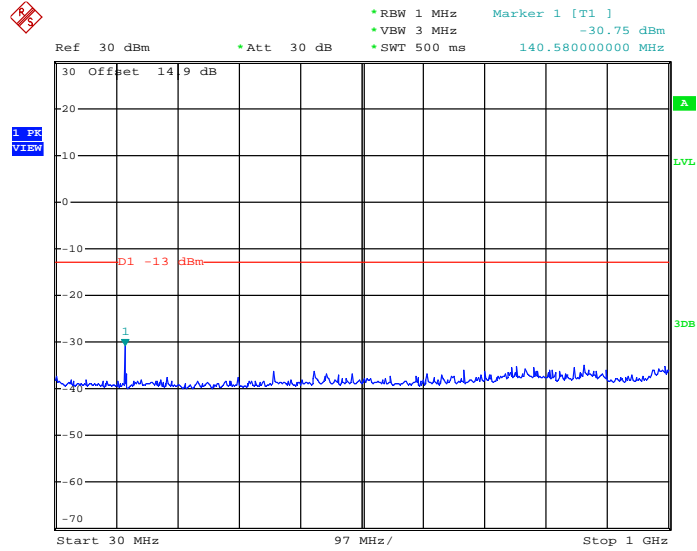

Date: 12.AUG.2014 12:23:29

Conducted Spurious Emission Plot between 1GHz ~ 3GHz

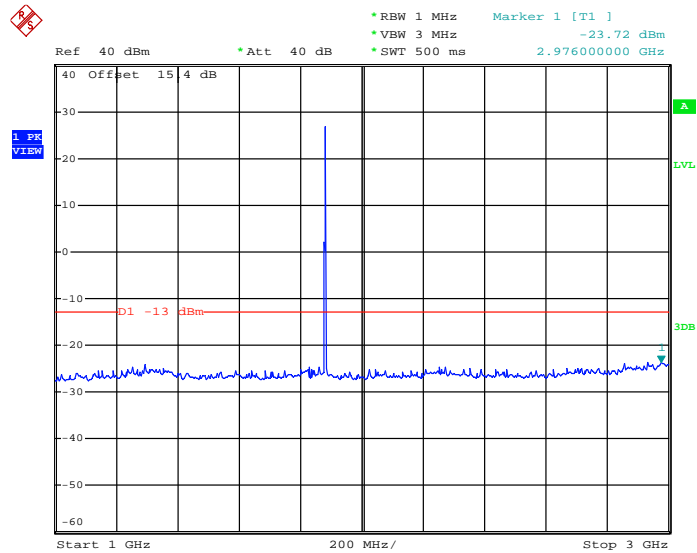

Date: 12.AUG.2014 12:28:01





### Conducted Spurious Emission Plot between 3GHz ~ 7GHz

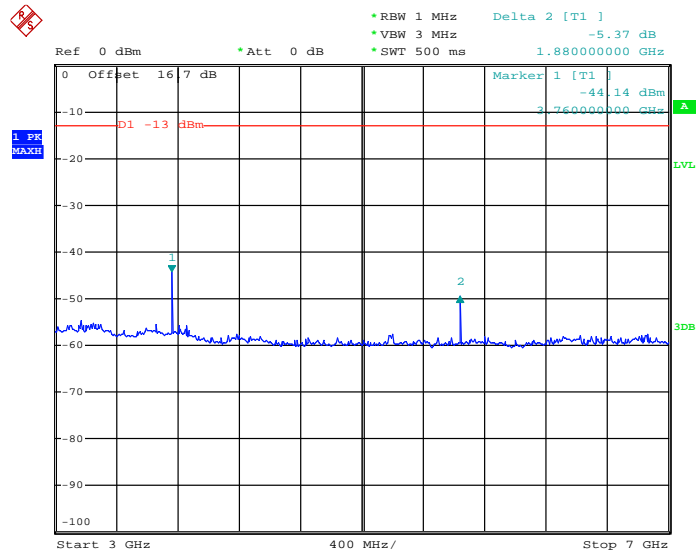

Date: 12.AUG.2014 12:52:11

### Conducted Spurious Emission Plot between 7GHz ~ 13.6GHz

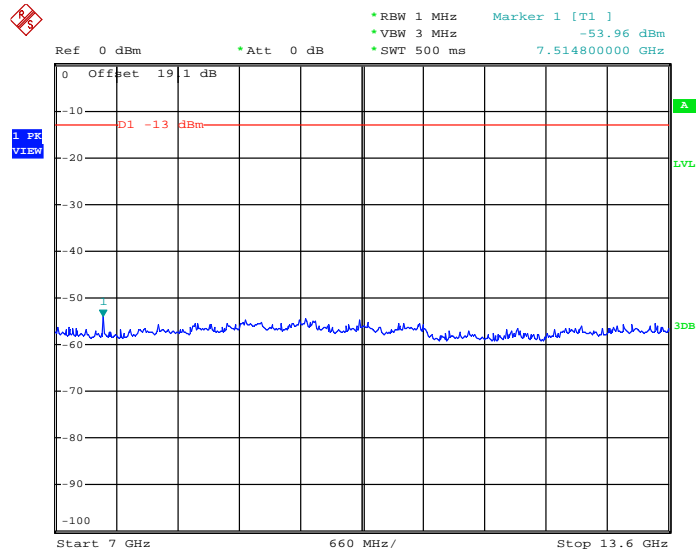

Date: 12.AUG.2014 12:38:20



Conducted Spurious Emission Plot between 13.6GHz ~ 19.1GHz

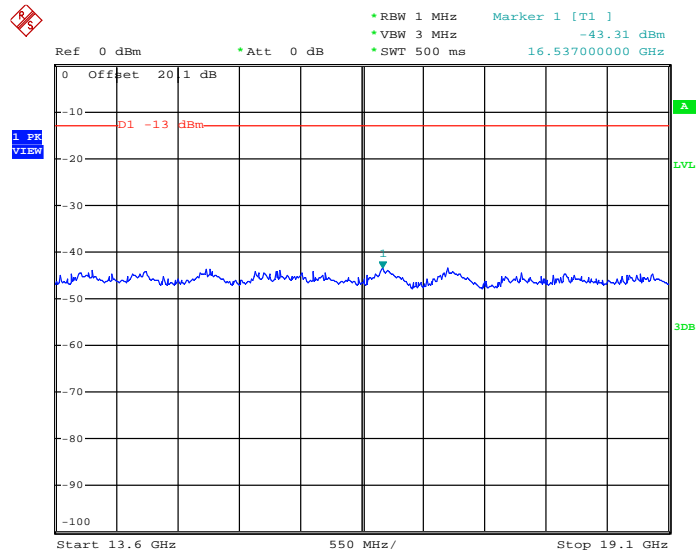

Date: 12.AUG.2014 12:55:36



<b>Band :</b>	GSM1900	<b>Channel :</b>	CH810
<b>Test Mode :</b>	EDGE class 8 Link (8PSK)	<b>Frequency :</b>	1909.8 MHz

Conducted Spurious Emission Plot between 30MHz ~ 1GHz

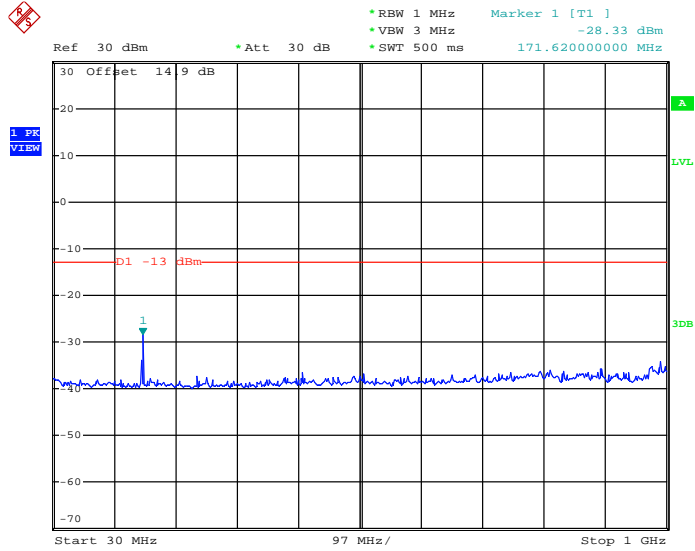

Date: 12.AUG.2014 12:22:08

Conducted Spurious Emission Plot between 1GHz ~ 3GHz

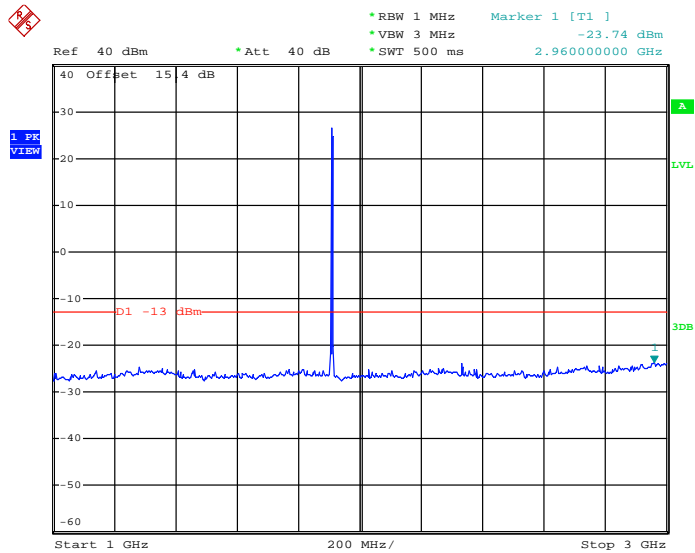

Date: 12.AUG.2014 12:29:25



### Conducted Spurious Emission Plot between 3GHz ~ 7GHz

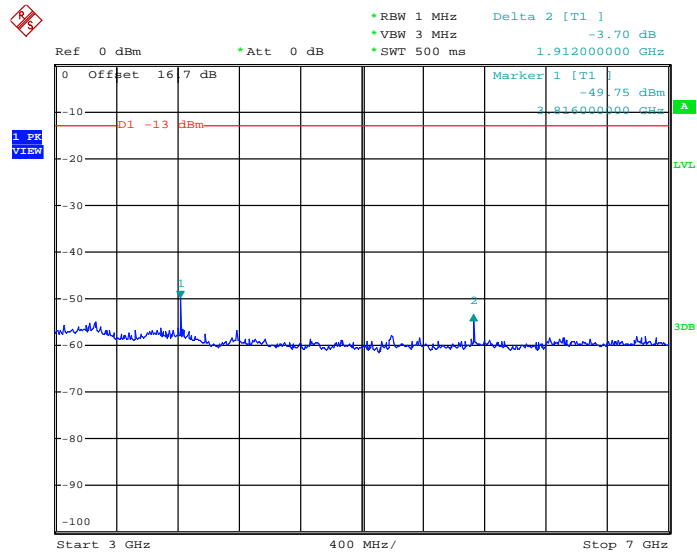

Date: 12.AUG.2014 12:53:00

### Conducted Spurious Emission Plot between 7GHz ~ 13.6GHz

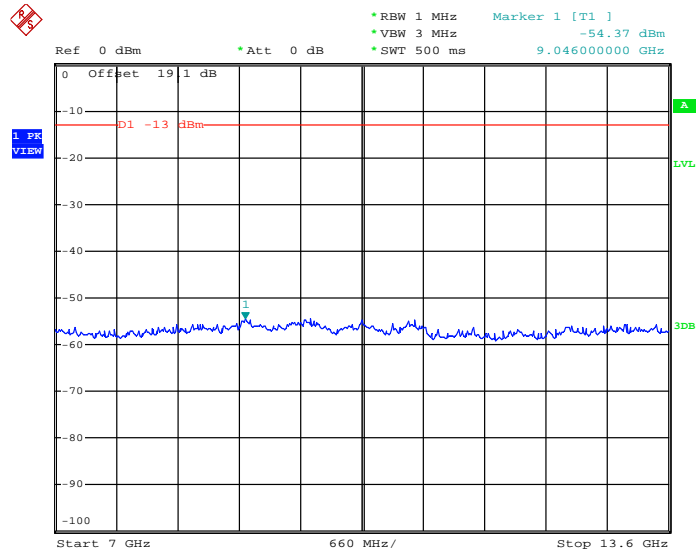

Date: 12.AUG.2014 12:39:01



Conducted Spurious Emission Plot between 13.6GHz ~ 19.1GHz

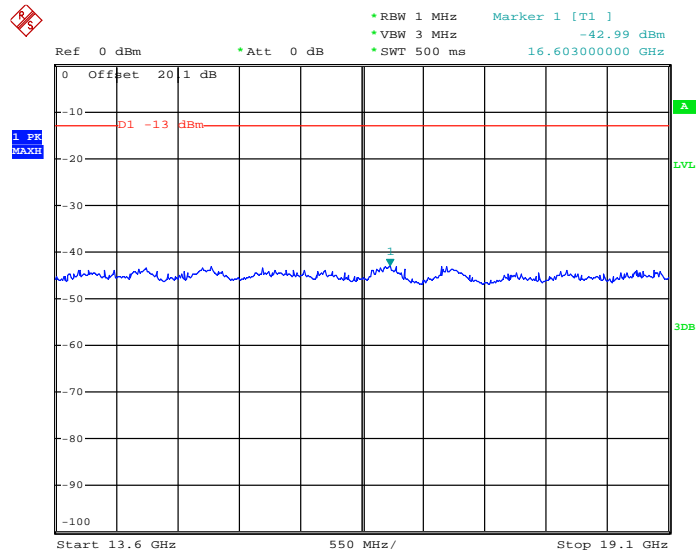

Date: 12.AUG.2014 12:55:00



Band :	WCDMA Band V	Channel :	CH4132
Test Mode :	RMC 12.2Kbps Link (QPSK)	Frequency :	826.4 MHz

Conducted Spurious Emission Plot between 30MHz ~ 1GHz

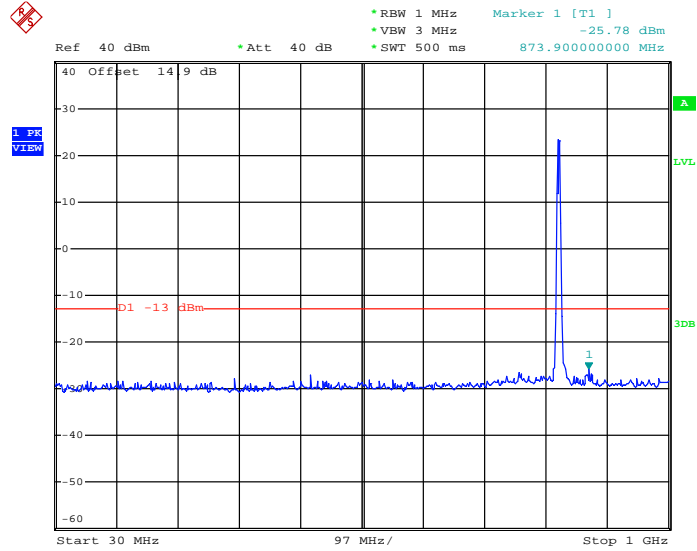

Date: 12.AUG.2014 19:09:30

Conducted Spurious Emission Plot between 1GHz ~ 3GHz

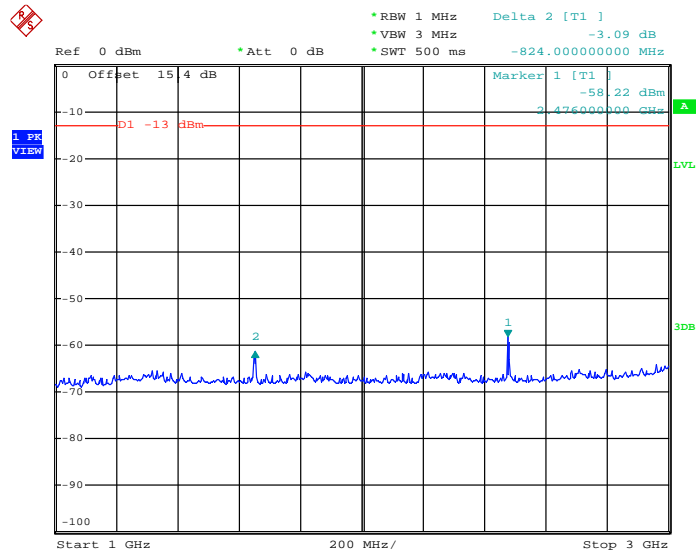

Date: 12.AUG.2014 19:20:33



### Conducted Spurious Emission Plot between 3GHz ~ 7GHz

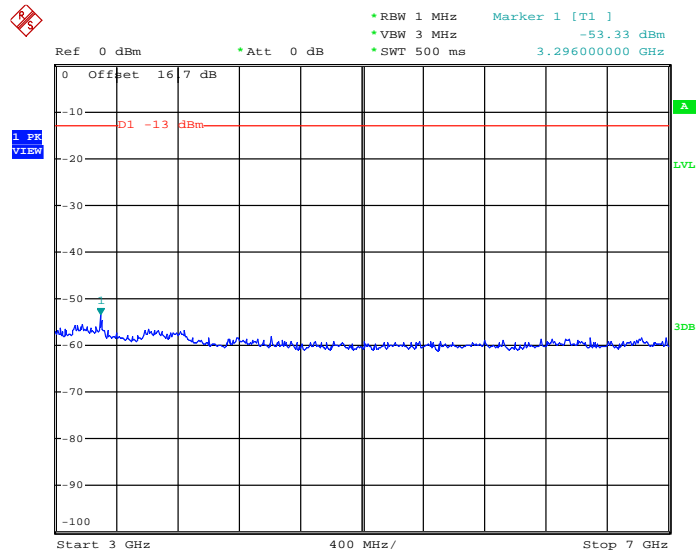

Date: 12.AUG.2014 19:30:40

### Conducted Spurious Emission Plot between 7GHz ~ 9GHz

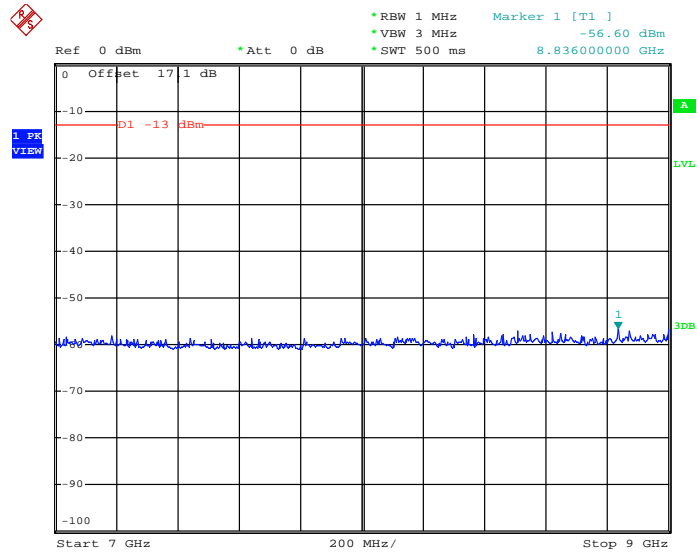

Date: 12.AUG.2014 19:34:12



Band :	WCDMA Band V	Channel :	CH4182
Test Mode :	RMC 12.2Kbps Link (QPSK)	Frequency :	836.4 MHz

Conducted Spurious Emission Plot between 30MHz ~ 1GHz

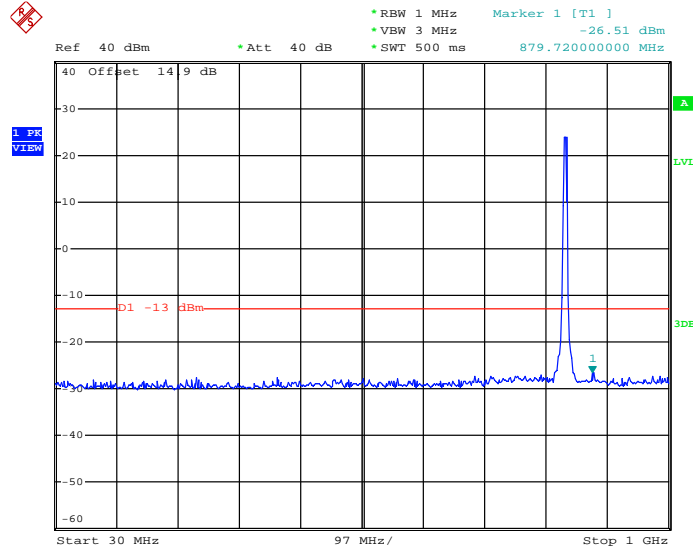

Date: 12.AUG.2014 19:10:37

Conducted Spurious Emission Plot between 1GHz ~ 3GHz

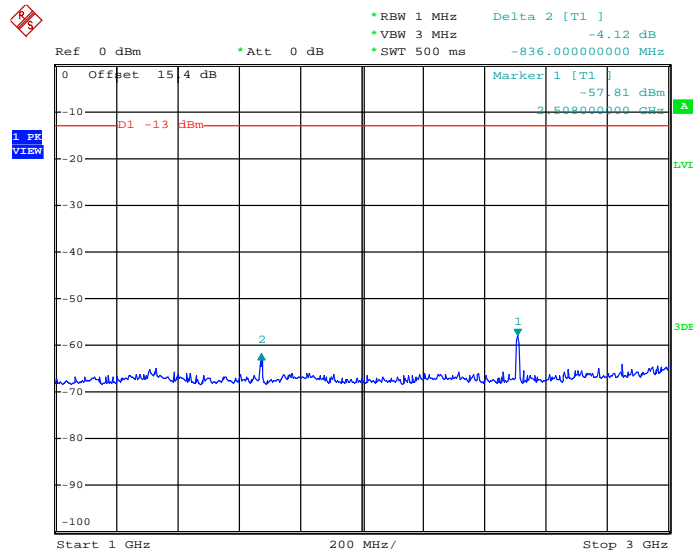

Date: 12.AUG.2014 19:19:41





### Conducted Spurious Emission Plot between 3GHz ~ 7GHz

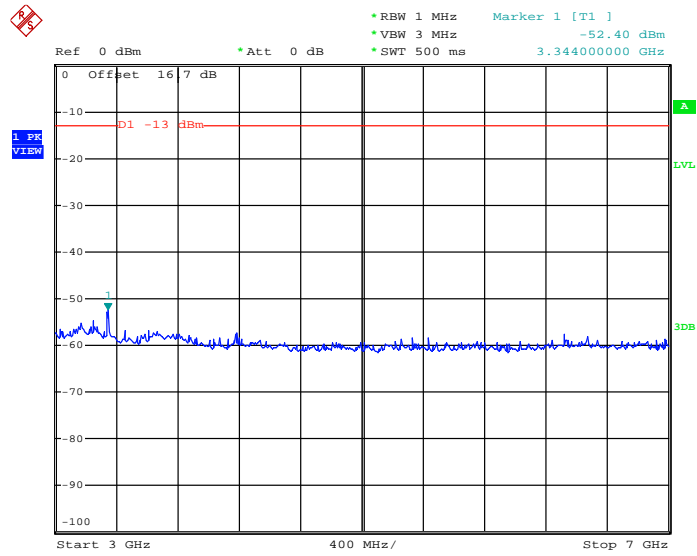

Date: 12.AUG.2014 19:31:29

### Conducted Spurious Emission Plot between 7GHz ~ 9GHz

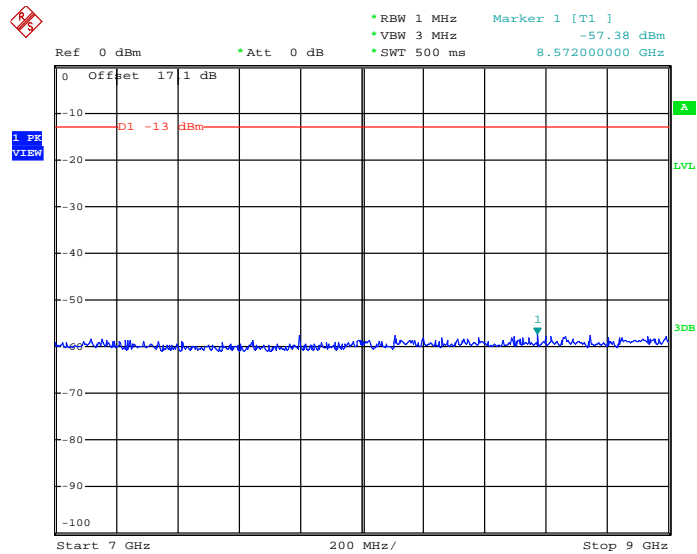

Date: 12.AUG.2014 19:33:47



Band :	WCDMA Band V	Channel :	CH4233
Test Mode :	RMC 12.2Kbps Link (QPSK)	Frequency :	846.6 MHz

Conducted Spurious Emission Plot between 30MHz ~ 1GHz

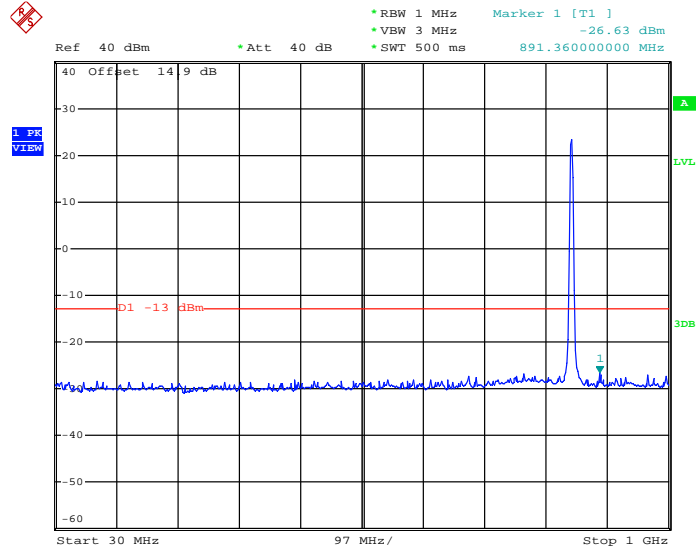

Date: 12.AUG.2014 19:11:29

Conducted Spurious Emission Plot between 1GHz ~ 3GHz

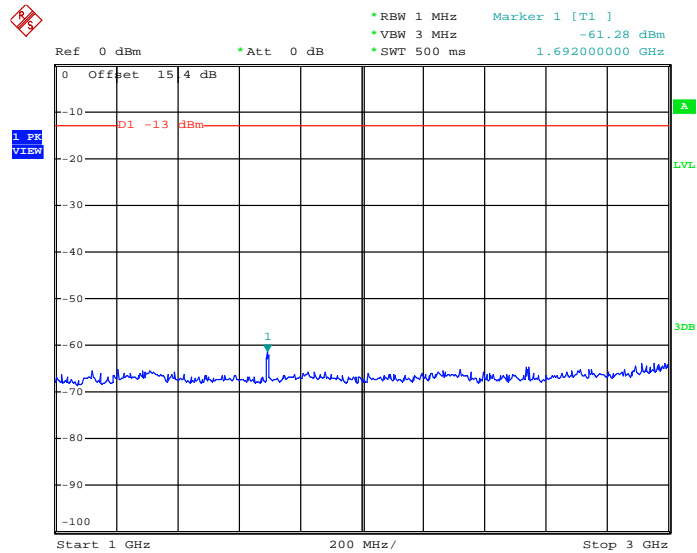

Date: 12.AUG.2014 19:18:49



### Conducted Spurious Emission Plot between 3GHz ~ 7GHz

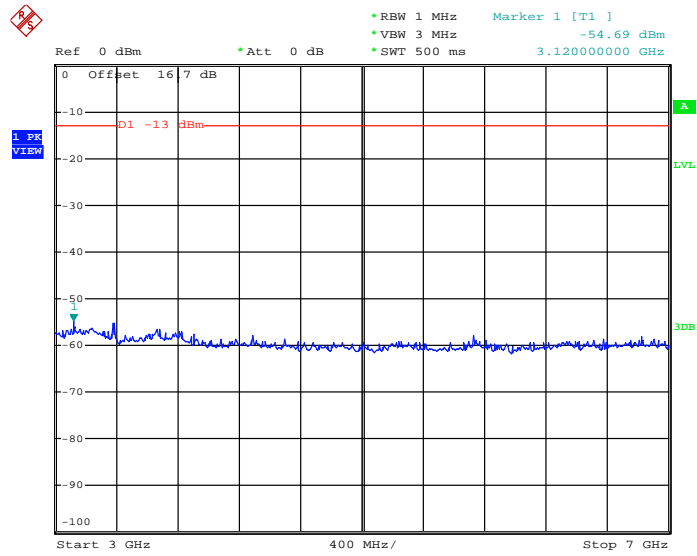

Date: 12.AUG.2014 19:32:06

### Conducted Spurious Emission Plot between 7GHz ~ 9GHz

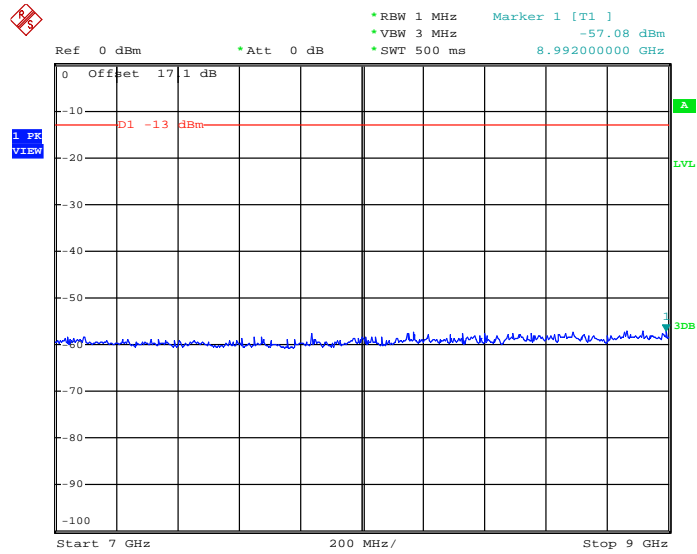

Date: 12.AUG.2014 19:33:17



Band :	WCDMA Band II	Channel :	CH9262
Test Mode :	RMC 12.2Kbps Link (QPSK)	Frequency :	1852.4 MHz

Conducted Spurious Emission Plot between 30MHz ~ 1GHz

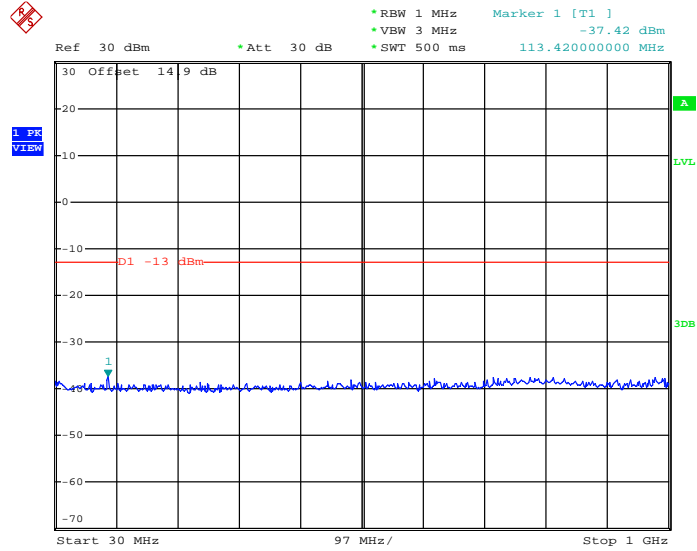

Date: 12.AUG.2014 17:45:11

Conducted Spurious Emission Plot between 1GHz ~ 3GHz

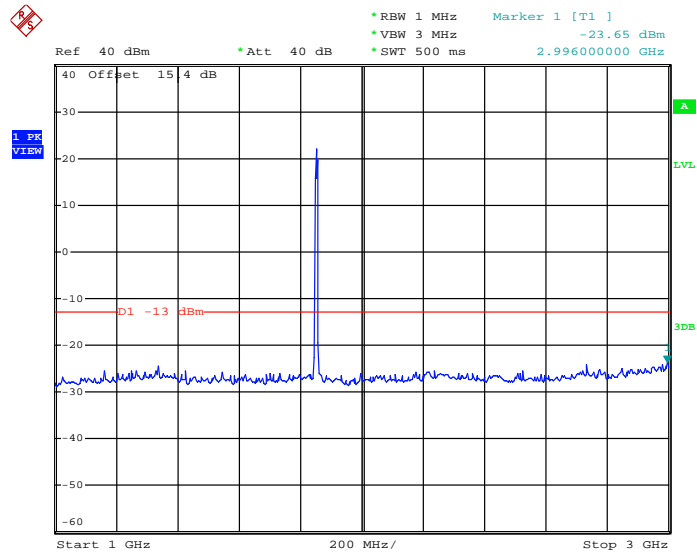

Date: 12.AUG.2014 17:47:41



### Conducted Spurious Emission Plot between 3GHz ~ 7GHz

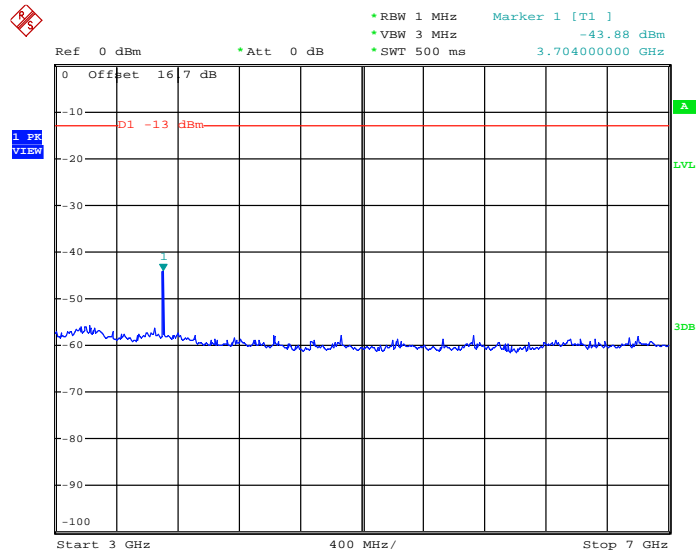

Date: 12.AUG.2014 17:54:33

### Conducted Spurious Emission Plot between 7GHz ~ 13.6GHz

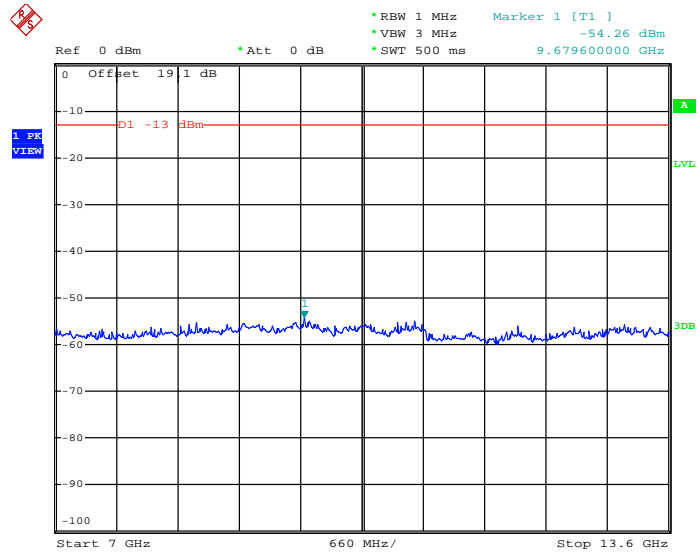

Date: 12.AUG.2014 17:56:48



Conducted Spurious Emission Plot between 13.6GHz ~ 19.1GHz

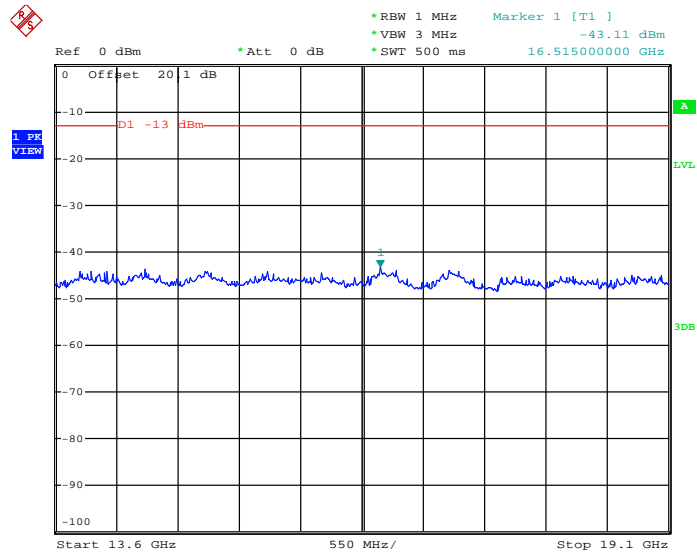

Date: 12.AUG.2014 18:40:19



Band :	WCDMA Band II	Channel :	CH9400
Test Mode :	RMC 12.2Kbps Link (QPSK)	Frequency :	1880.0 MHz

Conducted Spurious Emission Plot between 30MHz ~ 1GHz

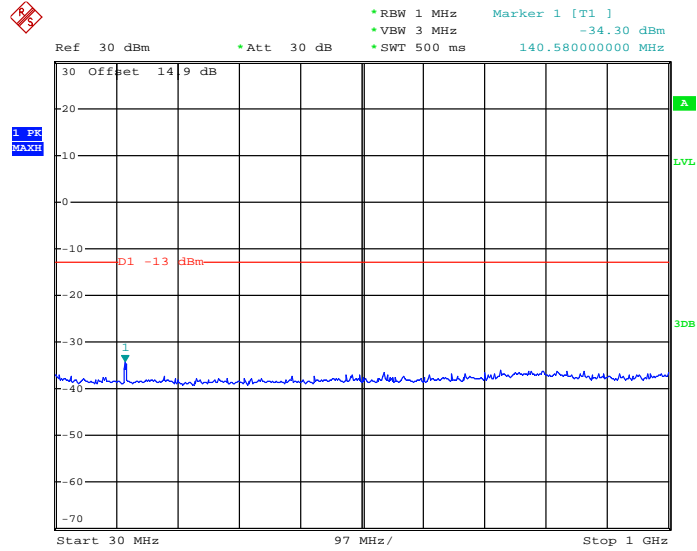

Date: 12.AUG.2014 17:44:20

Conducted Spurious Emission Plot between 1GHz ~ 3GHz

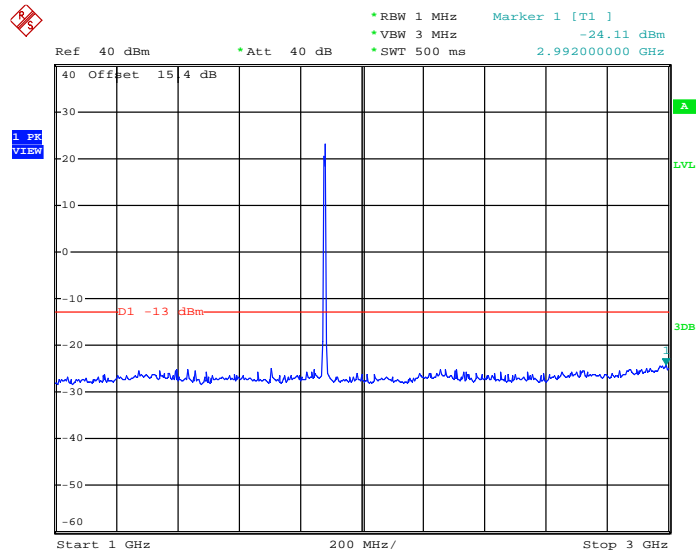

Date: 12.AUG.2014 17:48:56



### Conducted Spurious Emission Plot between 3GHz ~ 7GHz

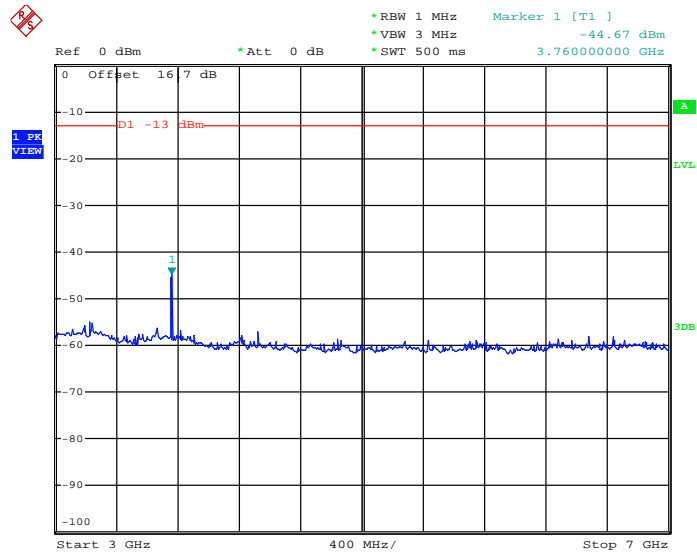

Date: 12.AUG.2014 17:53:33

### Conducted Spurious Emission Plot between 7GHz ~ 13.6GHz

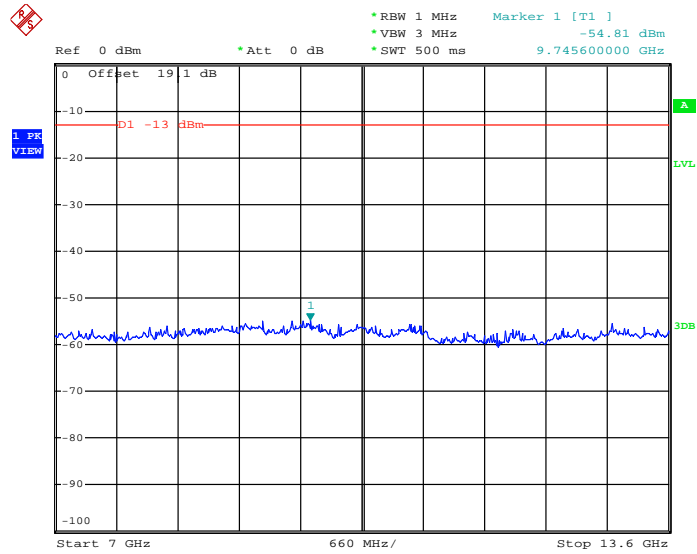

Date: 12.AUG.2014 17:57:27





Conducted Spurious Emission Plot between 13.6GHz ~ 19.1GHz

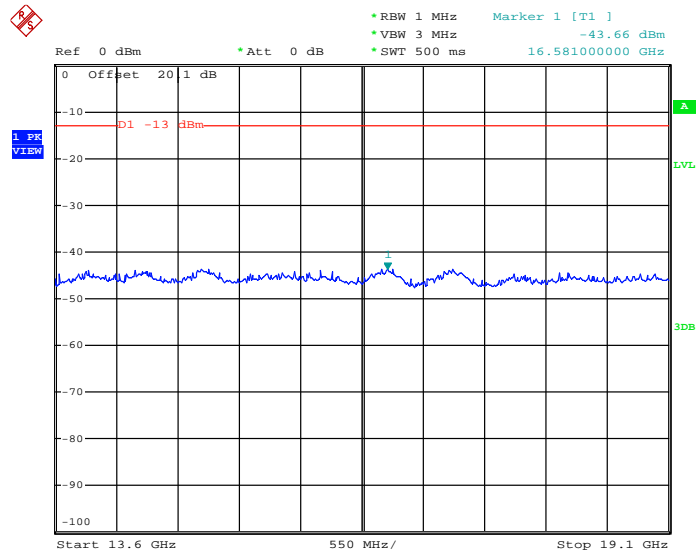

Date: 12.AUG.2014 18:38:21



Band :	WCDMA Band II	Channel :	CH9538
Test Mode :	RMC 12.2Kbps Link (QPSK)	Frequency :	1907.6 MHz

Conducted Spurious Emission Plot between 30MHz ~ 1GHz

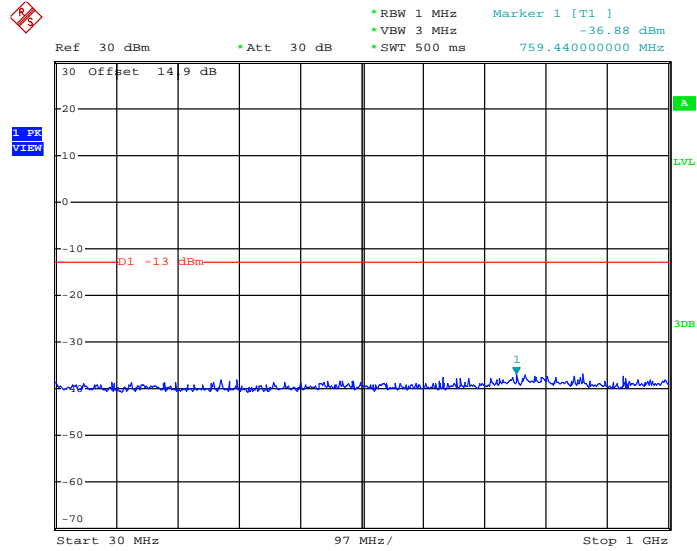

Date: 12.AUG.2014 16:56:59

Conducted Spurious Emission Plot between 1GHz ~ 3GHz

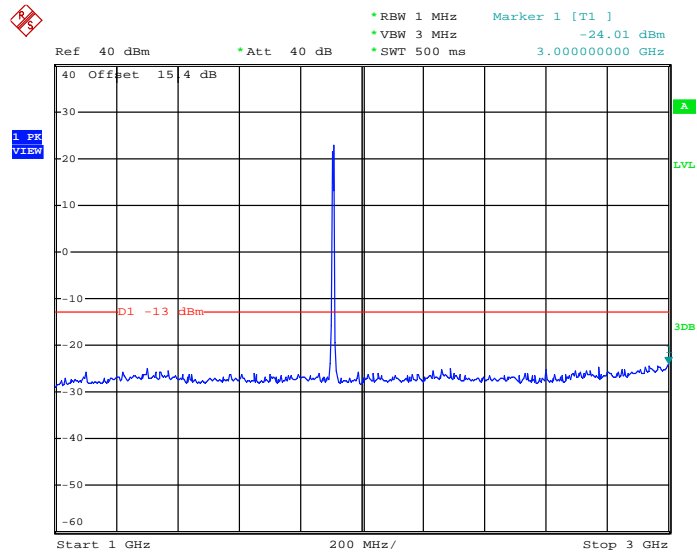

Date: 12.AUG.2014 17:51:07



### Conducted Spurious Emission Plot between 3GHz ~ 7GHz

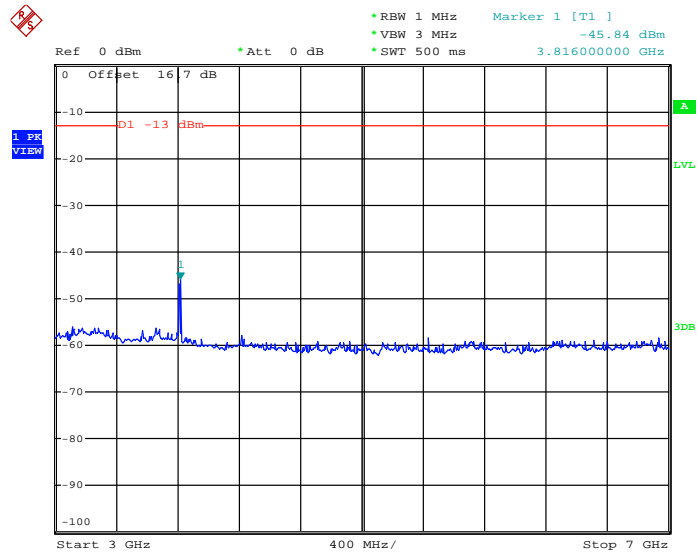

Date: 12.AUG.2014 17:52:50

### Conducted Spurious Emission Plot between 7GHz ~ 13.6GHz

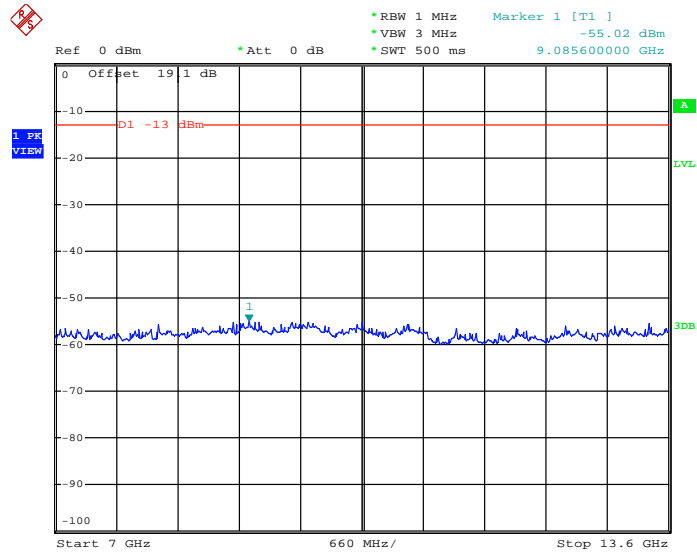

Date: 12.AUG.2014 17:58:05



Conducted Spurious Emission Plot between 13.6GHz ~ 19.1GHz

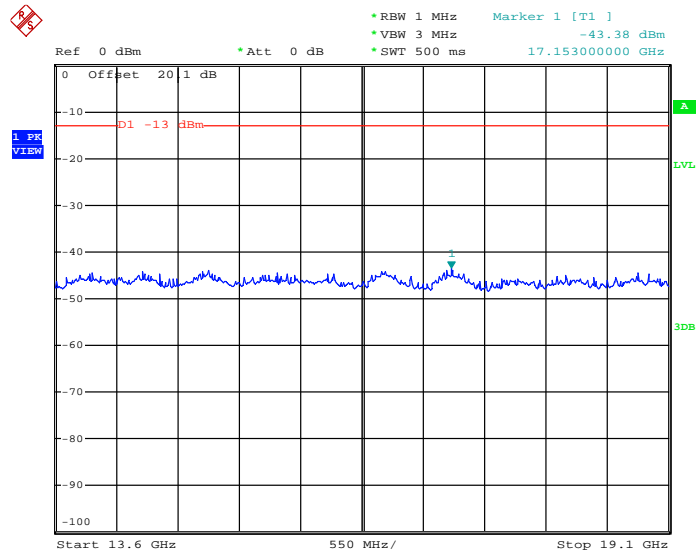

Date: 12.AUG.2014 18:39:36



### 3.7 Field Strength of Spurious Radiation Measurement

#### 3.7.1 Description of Field Strength of Spurious Radiated Measurement

The power of any emission outside of the authorized operating frequency ranges must be attenuated below the transmitter power (P) by a factor of at least  $43 + 10 \log (P)$  dB. The spectrum is scanned from 30 MHz up to a frequency including its 10th harmonic.

#### 3.7.2 Measuring Instruments

The measuring equipment is listed in the section 4 of this test report.

#### 3.7.3 Test Procedures

1. The testing follows FCC KDB 971168 v02r01 Section 5.8 and ANSI / TIA-603-C-2004 Section 2.2.12.
2. The EUT was placed on a rotatable wooden table 0.8 meters above the ground.
3. The EUT was set 3 meters from the receiving antenna, which was mounted on the antenna tower.
4. The table was rotated 360 degrees to determine the position of the highest spurious emission.
5. The height of the receiving antenna is varied between one meter and four meters to search for the maximum spurious emission for both horizontal and vertical polarizations.
6. Make the measurement with the spectrum analyzer's RBW = 1MHz, VBW = 3MHz, taking record of maximum spurious emission.
7. A horn antenna was substituted in place of the EUT and was driven by a signal generator.
8. Tune the output power of signal generator to the same emission level with EUT maximum spurious emission.
9. Taking the record of output power at antenna port.
10. Repeat step 7 to step 8 for another polarization.
11.  $EIRP (dBm) = S.G. Power - Tx Cable Loss + Tx Antenna Gain$
12.  $ERP (dBm) = EIRP - 2.15$
13. The RF fundamental frequency should be excluded against the limit line in the operating frequency band.
14. The limit line is derived from  $43 + 10\log(P)$  dB below the transmitter power P(Watts)  
=  $P(W) - [43 + 10\log(P)] (dB)$   
=  $[30 + 10\log(P)] (dBm) - [43 + 10\log(P)] (dB)$   
= -13dBm.

### 3.7.4 Test Setup

For radiated emissions from 30MHz to 1GHz

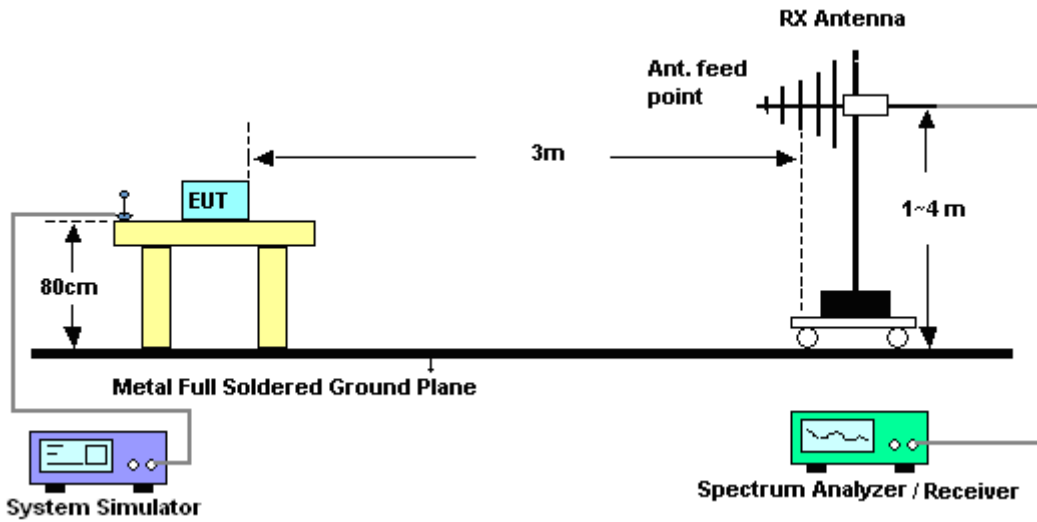

For radiated emissions above 1GHz

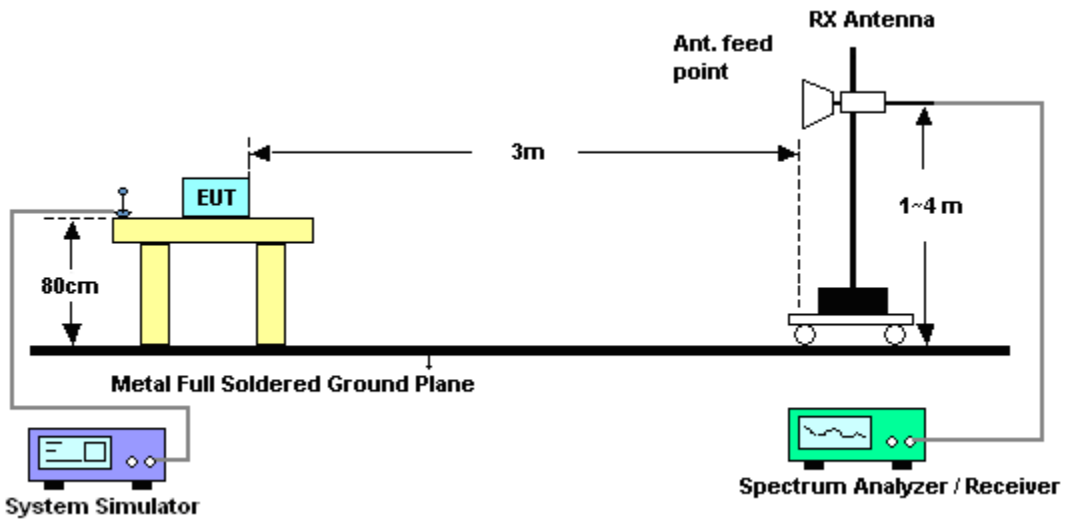



3.7.5 Test Result of Field Strength of Spurious Radiated

<b>Band :</b>	GSM850 for CH128				<b>Temperature :</b>	22~23°C			
<b>Test Mode :</b>	GSM Link (GMSK)				<b>Relative Humidity :</b>	42~43%			
<b>Test Engineer :</b>	Star Wei				<b>Polarization :</b>	Horizontal			
<b>Remark :</b>	Spurious emissions within 30-1000MHz were found more than 20dB below limit line.								
Frequency ( MHz )	ERP ( dBm )	Limit ( dBm )	Over Limit ( dB )	SPA Reading ( dBm )	S.G. Power ( dBm )	TX Cable loss ( dB )	TX Antenna Gain ( dBi )	Polarization ( H/V )	Result
1648	-55.62	-13	-42.62	-52.51	-56.27	0.57	3.37	H	Pass
2474	-56.55	-13	-43.55	-57.17	-58.78	0.78	5.16	H	Pass
3296	-61.36	-13	-48.36	-60.99	-65.00	0.87	6.66	H	Pass

<b>Band :</b>	GSM850 for CH128				<b>Temperature :</b>	22~23°C			
<b>Test Mode :</b>	GSM Link (GMSK)				<b>Relative Humidity :</b>	42~43%			
<b>Test Engineer :</b>	Star Wei				<b>Polarization :</b>	Vertical			
<b>Remark :</b>	Spurious emissions within 30-1000MHz were found more than 20dB below limit line.								
Frequency ( MHz )	ERP ( dBm )	Limit ( dBm )	Over Limit ( dB )	SPA Reading ( dBm )	S.G. Power ( dBm )	TX Cable loss ( dB )	TX Antenna Gain ( dBi )	Polarization ( H/V )	Result
1648	-47.17	-13	-34.17	-50.60	-47.82	0.57	3.37	V	Pass
2474	-50.05	-13	-37.05	-56.88	-52.28	0.78	5.16	V	Pass
3298	-61.09	-13	-48.09	-62.15	-64.73	0.87	6.66	V	Pass



<b>Band :</b>	GSM850 for CH189				<b>Temperature :</b>	22~23°C			
<b>Test Mode :</b>	GSM Link (GMSK)				<b>Relative Humidity :</b>	42~43%			
<b>Test Engineer :</b>	Star Wei				<b>Polarization :</b>	Horizontal			
<b>Remark :</b>	Spurious emissions within 30-1000MHz were found more than 20dB below limit line.								
Frequency ( MHz )	ERP ( dBm )	Limit ( dBm )	Over Limit ( dB )	SPA Reading ( dBm )	S.G. Power ( dBm )	TX Cable loss ( dB )	TX Antenna Gain ( dBi )	Polarization ( H/V )	Result
1674	-50.70	-13	-37.70	-48.75	-51.35	0.57	3.37	H	Pass
2510	-54.33	-13	-41.33	-55.65	-56.56	0.78	5.16	H	Pass
3346	-60.04	-13	-47.04	-59.67	-63.68	0.87	6.66	H	Pass
4182	-65.39	-13	-52.39	-65.08	-69.98	0.97	7.71	H	Pass

<b>Band :</b>	GSM850 for CH189				<b>Temperature :</b>	22~23°C			
<b>Test Mode :</b>	GSM Link (GMSK)				<b>Relative Humidity :</b>	42~43%			
<b>Test Engineer :</b>	Star Wei				<b>Polarization :</b>	Vertical			
<b>Remark :</b>	Spurious emissions within 30-1000MHz were found more than 20dB below limit line.								
Frequency ( MHz )	ERP ( dBm )	Limit ( dBm )	Over Limit ( dB )	SPA Reading ( dBm )	S.G. Power ( dBm )	TX Cable loss ( dB )	TX Antenna Gain ( dBi )	Polarization ( H/V )	Result
1674	-39.63	-13	-26.63	-43.84	-40.28	0.57	3.37	V	Pass
2510	-45.29	-13	-32.29	-53.50	-47.52	0.78	5.16	V	Pass
3346	-62.41	-13	-49.41	-63.47	-66.05	0.87	6.66	V	Pass
4184	-59.82	-13	-46.82	-62.61	-64.41	0.97	7.71	V	Pass





<b>Band :</b>	GSM850 for CH251				<b>Temperature :</b>	22~23°C			
<b>Test Mode :</b>	GSM Link (GMSK)				<b>Relative Humidity :</b>	42~43%			
<b>Test Engineer :</b>	Star Wei				<b>Polarization :</b>	Horizontal			
<b>Remark :</b>	Spurious emissions within 30-1000MHz were found more than 20dB below limit line.								
Frequency ( MHz )	ERP ( dBm )	Limit ( dBm )	Over Limit ( dB )	SPA Reading ( dBm )	S.G. Power ( dBm )	TX Cable loss ( dB )	TX Antenna Gain ( dBi )	Polarization ( H/V )	Result
1698	-53.50	-13	-40.50	-51.06	-54.15	0.57	3.37	H	Pass
2548	-48.77	-13	-35.77	-51.65	-51.00	0.78	5.16	H	Pass
3396	-61.63	-13	-48.63	-61.26	-65.27	0.87	6.66	H	Pass

<b>Band :</b>	GSM850 for CH251				<b>Temperature :</b>	22~23°C			
<b>Test Mode :</b>	GSM Link (GMSK)				<b>Relative Humidity :</b>	42~43%			
<b>Test Engineer :</b>	Star Wei				<b>Polarization :</b>	Vertical			
<b>Remark :</b>	Spurious emissions within 30-1000MHz were found more than 20dB below limit line.								
Frequency ( MHz )	ERP ( dBm )	Limit ( dBm )	Over Limit ( dB )	SPA Reading ( dBm )	S.G. Power ( dBm )	TX Cable loss ( dB )	TX Antenna Gain ( dBi )	Polarization ( H/V )	Result
1698	-41.96	-13	-28.96	-46.05	-42.61	0.57	3.37	V	Pass
2548	-42.23	-13	-29.23	-50.97	-44.46	0.78	5.16	V	Pass
3396	-62.33	-13	-49.33	-63.39	-65.97	0.87	6.66	V	Pass



<b>Band :</b>	GSM850 for CH128					<b>Temperature :</b>	22~23°C		
<b>Test Mode :</b>	EDGE class 8 Link (8PSK)					<b>Relative Humidity :</b>	42~43%		
<b>Test Engineer :</b>	Star Wei					<b>Polarization :</b>	Horizontal		
<b>Remark :</b>	Spurious emissions within 30-1000MHz were found more than 20dB below limit line.								
Frequency ( MHz )	ERP ( dBm )	Limit ( dBm )	Over Limit ( dB )	SPA Reading ( dBm )	S.G. Power ( dBm )	TX Cable loss ( dB )	TX Antenna Gain ( dBi )	Polarization ( H/V )	Result
1648	-63.33	-13	-50.33	-57.22	-63.98	0.57	3.37	H	Pass
2474	-61.87	-13	-48.87	-60.54	-64.10	0.78	5.16	H	Pass
3296	-64.55	-13	-51.55	-64.18	-68.19	0.87	6.66	H	Pass

<b>Band :</b>	GSM850 for CH128					<b>Temperature :</b>	22~23°C		
<b>Test Mode :</b>	EDGE class 8 Link (8PSK)					<b>Relative Humidity :</b>	42~43%		
<b>Test Engineer :</b>	Star Wei					<b>Polarization :</b>	Vertical		
<b>Remark :</b>	Spurious emissions within 30-1000MHz were found more than 20dB below limit line.								
Frequency ( MHz )	ERP ( dBm )	Limit ( dBm )	Over Limit ( dB )	SPA Reading ( dBm )	S.G. Power ( dBm )	TX Cable loss ( dB )	TX Antenna Gain ( dBi )	Polarization ( H/V )	Result
1648	-56.76	-13	-43.76	-57.53	-57.41	0.57	3.37	V	Pass
2474	-43.77	-13	-30.77	-52.29	-46.00	0.78	5.16	V	Pass
3296	-64.39	-13	-51.39	-65.45	-68.03	0.87	6.66	V	Pass



<b>Band :</b>	GSM850 for CH189					<b>Temperature :</b>	22~23°C		
<b>Test Mode :</b>	EDGE class 8 Link (8PSK)					<b>Relative Humidity :</b>	42~43%		
<b>Test Engineer :</b>	Star Wei					<b>Polarization :</b>	Horizontal		
<b>Remark :</b>	Spurious emissions within 30-1000MHz were found more than 20dB below limit line.								
Frequency ( MHz )	ERP ( dBm )	Limit ( dBm )	Over Limit ( dB )	SPA Reading ( dBm )	S.G. Power ( dBm )	TX Cable loss ( dB )	TX Antenna Gain ( dBi )	Polarization ( H/V )	Result
1674	-64.79	-13	-51.79	-58.29	-65.44	0.57	3.37	H	Pass
2510	-55.20	-13	-42.20	-56.30	-57.43	0.78	5.16	H	Pass
3344	-66.91	-13	-53.91	-66.54	-70.55	0.87	6.66	H	Pass

<b>Band :</b>	GSM850 for CH189					<b>Temperature :</b>	22~23°C		
<b>Test Mode :</b>	EDGE class 8 Link (8PSK)					<b>Relative Humidity :</b>	42~43%		
<b>Test Engineer :</b>	Star Wei					<b>Polarization :</b>	Vertical		
<b>Remark :</b>	Spurious emissions within 30-1000MHz were found more than 20dB below limit line.								
Frequency ( MHz )	ERP ( dBm )	Limit ( dBm )	Over Limit ( dB )	SPA Reading ( dBm )	S.G. Power ( dBm )	TX Cable loss ( dB )	TX Antenna Gain ( dBi )	Polarization ( H/V )	Result
1672	-61.30	-13	-48.30	-60.23	-61.95	0.57	3.37	V	Pass
2510	-50.52	-13	-37.52	-57.23	-52.75	0.78	5.16	V	Pass
3344	-65.85	-13	-52.85	-66.91	-69.49	0.87	6.66	V	Pass



<b>Band :</b>	GSM850 for CH251					<b>Temperature :</b>	22~23°C		
<b>Test Mode :</b>	EDGE class 8 Link (8PSK)					<b>Relative Humidity :</b>	42~43%		
<b>Test Engineer :</b>	Star Wei					<b>Polarization :</b>	Horizontal		
<b>Remark :</b>	Spurious emissions within 30-1000MHz were found more than 20dB below limit line.								
Frequency ( MHz )	ERP ( dBm )	Limit ( dBm )	Over Limit ( dB )	SPA Reading ( dBm )	S.G. Power ( dBm )	TX Cable loss ( dB )	TX Antenna Gain ( dBi )	Polarization ( H/V )	Result
1698	-69.54	-13	-56.54	-60.66	-70.19	0.57	3.37	H	Pass
2548	-60.52	-13	-47.52	-59.27	-62.75	0.78	5.16	H	Pass
3396	-67.51	-13	-54.51	-67.14	-71.15	0.87	6.66	H	Pass

<b>Band :</b>	GSM850 for CH251					<b>Temperature :</b>	22~23°C		
<b>Test Mode :</b>	EDGE class 8 Link (8PSK)					<b>Relative Humidity :</b>	42~43%		
<b>Test Engineer :</b>	Star Wei					<b>Polarization :</b>	Vertical		
<b>Remark :</b>	Spurious emissions within 30-1000MHz were found more than 20dB below limit line.								
Frequency ( MHz )	ERP ( dBm )	Limit ( dBm )	Over Limit ( dB )	SPA Reading ( dBm )	S.G. Power ( dBm )	TX Cable loss ( dB )	TX Antenna Gain ( dBi )	Polarization ( H/V )	Result
1698	-68.86	-13	-55.86	-65.06	-69.51	0.57	3.37	V	Pass
2548	-42.83	-13	-29.83	-51.52	-45.06	0.78	5.16	V	Pass
3396	-65.39	-13	-52.39	-66.45	-69.03	0.87	6.66	V	Pass



<b>Band :</b>	GSM1900 for CH512					<b>Temperature :</b>	22~23°C		
<b>Test Mode :</b>	GSM Link (GMSK)					<b>Relative Humidity :</b>	42~43%		
<b>Test Engineer :</b>	Star Wei					<b>Polarization :</b>	Horizontal		
<b>Remark :</b>	Spurious emissions within 30-1000MHz were found more than 20dB below limit line.								
Frequency ( MHz )	EIRP ( dBm )	Limit ( dBm )	Over Limit ( dB )	SPA Reading ( dBm )	S.G. Power ( dBm )	TX Cable loss ( dB )	TX Antenna Gain ( dBi )	Polarization ( H/V )	Result
3699	-63.71	-13	-50.71	-67.06	-70.09	0.78	7.16	H	Pass
5553	-45.02	-13	-32.02	-57.71	-53.56	1.04	9.58	H	Pass
7401	-55.87	-13	-42.87	-67.41	-65.98	1.35	11.46	H	Pass

<b>Band :</b>	GSM1900 for CH512					<b>Temperature :</b>	22~23°C		
<b>Test Mode :</b>	GSM Link (GMSK)					<b>Relative Humidity :</b>	42~43%		
<b>Test Engineer :</b>	Star Wei					<b>Polarization :</b>	Vertical		
<b>Remark :</b>	Spurious emissions within 30-1000MHz were found more than 20dB below limit line.								
Frequency ( MHz )	EIRP ( dBm )	Limit ( dBm )	Over Limit ( dB )	SPA Reading ( dBm )	S.G. Power ( dBm )	TX Cable loss ( dB )	TX Antenna Gain ( dBi )	Polarization ( H/V )	Result
3699	-55.92	-13	-42.92	-64.32	-62.30	0.78	7.16	V	Pass
5553	-39.47	-13	-26.47	-55.73	-48.01	1.04	9.58	V	Pass
7401	-53.75	-13	-40.75	-67.84	-63.86	1.35	11.46	V	Pass



<b>Band :</b>	GSM1900 for CH661					<b>Temperature :</b>	22~23°C		
<b>Test Mode :</b>	GSM Link (GMSK)					<b>Relative Humidity :</b>	42~43%		
<b>Test Engineer :</b>	Star Wei					<b>Polarization :</b>	Horizontal		
<b>Remark :</b>	Spurious emissions within 30-1000MHz were found more than 20dB below limit line.								
Frequency ( MHz )	EIRP ( dBm )	Limit ( dBm )	Over Limit ( dB )	SPA Reading ( dBm )	S.G. Power ( dBm )	TX Cable loss ( dB )	TX Antenna Gain ( dBi )	Polarization ( H/V )	Result
3759	-55.52	-13	-42.52	-60.71	-61.90	0.78	7.16	H	Pass
5643	-45.98	-13	-32.98	-58.62	-54.52	1.04	9.58	H	Pass
7521	-55.29	-13	-42.29	-66.83	-65.40	1.35	11.46	H	Pass
9399	-53.87	-13	-40.87	-66.30	-64.93	1.75	12.81	H	Pass

<b>Band :</b>	GSM1900 for CH661					<b>Temperature :</b>	22~23°C		
<b>Test Mode :</b>	GSM Link (GMSK)					<b>Relative Humidity :</b>	42~43%		
<b>Test Engineer :</b>	Star Wei					<b>Polarization :</b>	Vertical		
<b>Remark :</b>	Spurious emissions within 30-1000MHz were found more than 20dB below limit line.								
Frequency ( MHz )	EIRP ( dBm )	Limit ( dBm )	Over Limit ( dB )	SPA Reading ( dBm )	S.G. Power ( dBm )	TX Cable loss ( dB )	TX Antenna Gain ( dBi )	Polarization ( H/V )	Result
3759	-51.40	-13	-38.40	-60.01	-57.78	0.78	7.16	V	Pass
5643	-37.71	-13	-24.71	-54.16	-46.25	1.04	9.58	V	Pass
7521	-50.31	-13	-37.31	-64.4	-60.42	1.35	11.46	V	Pass
9399	-50.42	-13	-37.42	-62.95	-61.48	1.75	12.81	V	Pass



<b>Band :</b>	GSM1900 for CH810					<b>Temperature :</b>	22~23°C		
<b>Test Mode :</b>	GSM Link (GMSK)					<b>Relative Humidity :</b>	42~43%		
<b>Test Engineer :</b>	Star Wei					<b>Polarization :</b>	Horizontal		
<b>Remark :</b>	Spurious emissions within 30-1000MHz were found more than 20dB below limit line.								
Frequency ( MHz )	EIRP ( dBm )	Limit ( dBm )	Over Limit ( dB )	SPA Reading ( dBm )	S.G. Power ( dBm )	TX Cable loss ( dB )	TX Antenna Gain ( dBi )	Polarization ( H/V )	Result
3819	-58.01	-13	-45.01	-61.67	-64.39	0.78	7.16	H	Pass
5730	-37.78	-13	-24.78	-52.92	-46.32	1.04	9.58	H	Pass
7641	-55.28	-13	-42.28	-66.82	-65.39	1.35	11.46	H	Pass

<b>Band :</b>	GSM1900 for CH810					<b>Temperature :</b>	22~23°C		
<b>Test Mode :</b>	GSM Link (GMSK)					<b>Relative Humidity :</b>	42~43%		
<b>Test Engineer :</b>	Star Wei					<b>Polarization :</b>	Vertical		
<b>Remark :</b>	Spurious emissions within 30-1000MHz were found more than 20dB below limit line.								
Frequency ( MHz )	EIRP ( dBm )	Limit ( dBm )	Over Limit ( dB )	SPA Reading ( dBm )	S.G. Power ( dBm )	TX Cable loss ( dB )	TX Antenna Gain ( dBi )	Polarization ( H/V )	Result
3819	-52.32	-13	-39.32	-60.72	-58.70	0.78	7.16	V	Pass
5730	-42.85	-13	-29.85	-58.41	-51.39	1.04	9.58	V	Pass
7641	-48.99	-13	-35.99	-63.08	-59.10	1.35	11.46	V	Pass



<b>Band :</b>	GSM1900 for CH512					<b>Temperature :</b>	22~23°C		
<b>Test Mode :</b>	EDGE class 8 Link (8PSK)					<b>Relative Humidity :</b>	42~43%		
<b>Test Engineer :</b>	Star Wei					<b>Polarization :</b>	Horizontal		
<b>Remark :</b>	Spurious emissions within 30-1000MHz were found more than 20dB below limit line.								
Frequency ( MHz )	EIRP ( dBm )	Limit ( dBm )	Over Limit ( dB )	SPA Reading ( dBm )	S.G. Power ( dBm )	TX Cable loss ( dB )	TX Antenna Gain ( dBi )	Polarization ( H/V )	Result
3699	-63.27	-13	-50.27	-66.62	-69.65	0.78	7.16	H	Pass
5553	-54.63	-13	-41.63	-64.69	-63.17	1.04	9.58	H	Pass
7404	-54.35	-13	-41.35	-65.89	-64.46	1.35	11.46	H	Pass

<b>Band :</b>	GSM1900 for CH512					<b>Temperature :</b>	22~23°C		
<b>Test Mode :</b>	EDGE class 8 Link (8PSK)					<b>Relative Humidity :</b>	42~43%		
<b>Test Engineer :</b>	Star Wei					<b>Polarization :</b>	Vertical		
<b>Remark :</b>	Spurious emissions within 30-1000MHz were found more than 20dB below limit line.								
Frequency ( MHz )	EIRP ( dBm )	Limit ( dBm )	Over Limit ( dB )	SPA Reading ( dBm )	S.G. Power ( dBm )	TX Cable loss ( dB )	TX Antenna Gain ( dBi )	Polarization ( H/V )	Result
3705	-57.59	-13	-44.59	-65.99	-63.97	0.78	7.16	V	Pass
5553	-53.15	-13	-40.15	-65.8	-61.69	1.04	9.58	V	Pass
7401	-51.70	-13	-38.70	-65.79	-61.81	1.35	11.46	V	Pass





<b>Band :</b>	GSM1900 for CH661					<b>Temperature :</b>	22~23°C		
<b>Test Mode :</b>	EDGE class 8 Link (8PSK)					<b>Relative Humidity :</b>	42~43%		
<b>Test Engineer :</b>	Star Wei					<b>Polarization :</b>	Horizontal		
<b>Remark :</b>	Spurious emissions within 30-1000MHz were found more than 20dB below limit line.								
Frequency ( MHz )	EIRP ( dBm )	Limit ( dBm )	Over Limit ( dB )	SPA Reading ( dBm )	S.G. Power ( dBm )	TX Cable loss ( dB )	TX Antenna Gain ( dBi )	Polarization ( H/V )	Result
3759	-62.31	-13	-49.31	-65.66	-68.69	0.78	7.16	H	Pass
5643	-52.37	-13	-39.37	-62.43	-60.91	1.04	9.58	H	Pass
7521	-56.12	-13	-43.12	-67.66	-66.23	1.35	11.46	H	Pass

<b>Band :</b>	GSM1900 for CH661					<b>Temperature :</b>	22~23°C		
<b>Test Mode :</b>	EDGE class 8 Link (8PSK)					<b>Relative Humidity :</b>	42~43%		
<b>Test Engineer :</b>	Star Wei					<b>Polarization :</b>	Vertical		
<b>Remark :</b>	Spurious emissions within 30-1000MHz were found more than 20dB below limit line.								
Frequency ( MHz )	EIRP ( dBm )	Limit ( dBm )	Over Limit ( dB )	SPA Reading ( dBm )	S.G. Power ( dBm )	TX Cable loss ( dB )	TX Antenna Gain ( dBi )	Polarization ( H/V )	Result
3759	-56.38	-13	-43.38	-64.78	-62.76	0.78	7.16	V	Pass
5643	-52.46	-13	-39.46	-65.11	-61.00	1.04	9.58	V	Pass
7521	-53.26	-13	-40.26	-67.35	-63.37	1.35	11.46	V	Pass



<b>Band :</b>	GSM1900 for CH810					<b>Temperature :</b>	22~23°C		
<b>Test Mode :</b>	EDGE class 8 Link (8PSK)					<b>Relative Humidity :</b>	42~43%		
<b>Test Engineer :</b>	Star Wei					<b>Polarization :</b>	Horizontal		
<b>Remark :</b>	Spurious emissions within 30-1000MHz were found more than 20dB below limit line.								
Frequency ( MHz )	EIRP ( dBm )	Limit ( dBm )	Over Limit ( dB )	SPA Reading ( dBm )	S.G. Power ( dBm )	TX Cable loss ( dB )	TX Antenna Gain ( dBi )	Polarization ( H/V )	Result
3819	-60.18	-13	-47.18	-63.53	-66.56	0.78	7.16	H	Pass
5730	-49.71	-13	-36.71	-61.08	-58.25	1.04	9.58	H	Pass
7638	-55.21	-13	-42.21	-66.75	-65.32	1.35	11.46	H	Pass

<b>Band :</b>	GSM1900 for CH810					<b>Temperature :</b>	22~23°C		
<b>Test Mode :</b>	EDGE class 8 Link (8PSK)					<b>Relative Humidity :</b>	42~43%		
<b>Test Engineer :</b>	Star Wei					<b>Polarization :</b>	Vertical		
<b>Remark :</b>	Spurious emissions within 30-1000MHz were found more than 20dB below limit line.								
Frequency ( MHz )	EIRP ( dBm )	Limit ( dBm )	Over Limit ( dB )	SPA Reading ( dBm )	S.G. Power ( dBm )	TX Cable loss ( dB )	TX Antenna Gain ( dBi )	Polarization ( H/V )	Result
3819	-57.64	-13	-44.64	-66.04	-64.02	0.78	7.16	V	Pass
5730	-46.50	-13	-33.50	-60.5	-55.04	1.04	9.58	V	Pass
7641	-51.22	-13	-38.22	-65.31	-61.33	1.35	11.46	V	Pass



<b>Band :</b>	WCDMA Band V for CH4132				<b>Temperature :</b>	22~23°C			
<b>Test Mode :</b>	RMC 12.2Kbps Link (QPSK)				<b>Relative Humidity :</b>	42~43%			
<b>Test Engineer :</b>	Star Wei				<b>Polarization :</b>	Horizontal			
<b>Remark :</b>	Spurious emissions within 30-1000MHz were found more than 20dB below limit line.								
Frequency ( MHz )	ERP ( dBm )	Limit ( dBm )	Over Limit ( dB )	SPA Reading ( dBm )	S.G. Power ( dBm )	TX Cable loss ( dB )	TX Antenna Gain ( dBi )	Polarization ( H/V )	Result
1650	-64.20	-13	-51.20	-57.80	-64.85	0.57	3.37	H	Pass
2482	-57.72	-13	-44.72	-57.95	-59.95	0.78	5.16	H	Pass
3306	-64.90	-13	-51.90	-64.53	-68.54	0.87	6.66	H	Pass

<b>Band :</b>	WCDMA Band V for CH4132				<b>Temperature :</b>	22~23°C			
<b>Test Mode :</b>	RMC 12.2Kbps Link (QPSK)				<b>Relative Humidity :</b>	42~43%			
<b>Test Engineer :</b>	Star Wei				<b>Polarization :</b>	Vertical			
<b>Remark :</b>	Spurious emissions within 30-1000MHz were found more than 20dB below limit line.								
Frequency ( MHz )	ERP ( dBm )	Limit ( dBm )	Over Limit ( dB )	SPA Reading ( dBm )	S.G. Power ( dBm )	TX Cable loss ( dB )	TX Antenna Gain ( dBi )	Polarization ( H/V )	Result
1652	-60.21	-13	-47.21	-59.50	-60.86	0.57	3.37	V	Pass
2478	-47.32	-13	-34.32	-54.99	-49.55	0.78	5.16	V	Pass
3306	-64.37	-13	-51.37	-65.43	-68.01	0.87	6.66	V	Pass



<b>Band :</b>	WCDMA Band V for CH4182				<b>Temperature :</b>	22~23°C			
<b>Test Mode :</b>	RMC 12.2Kbps Link (QPSK)				<b>Relative Humidity :</b>	42~43%			
<b>Test Engineer :</b>	Star Wei				<b>Polarization :</b>	Horizontal			
<b>Remark :</b>	Spurious emissions within 30-1000MHz were found more than 20dB below limit line.								
Frequency ( MHz )	ERP ( dBm )	Limit ( dBm )	Over Limit ( dB )	SPA Reading ( dBm )	S.G. Power ( dBm )	TX Cable loss ( dB )	TX Antenna Gain ( dBi )	Polarization ( H/V )	Result
1672	-68.34	-13	-55.34	-59.79	-68.99	0.57	3.37	H	Pass
2512	-63.34	-13	-50.34	-62.01	-65.57	0.78	5.16	H	Pass
3346	-63.91	-13	-50.91	-63.54	-67.55	0.87	6.66	H	Pass

<b>Band :</b>	WCDMA Band V for CH4182				<b>Temperature :</b>	22~23°C			
<b>Test Mode :</b>	RMC 12.2Kbps Link (QPSK)				<b>Relative Humidity :</b>	42~43%			
<b>Test Engineer :</b>	Star Wei				<b>Polarization :</b>	Vertical			
<b>Remark :</b>	Spurious emissions within 30-1000MHz were found more than 20dB below limit line.								
Frequency ( MHz )	ERP ( dBm )	Limit ( dBm )	Over Limit ( dB )	SPA Reading ( dBm )	S.G. Power ( dBm )	TX Cable loss ( dB )	TX Antenna Gain ( dBi )	Polarization ( H/V )	Result
1676	-66.26	-13	-53.26	-62.46	-66.91	0.57	3.37	V	Pass
2512	-55.56	-13	-42.56	-60.11	-57.79	0.78	5.16	V	Pass
3344	-65.28	-13	-52.28	-66.34	-68.92	0.87	6.66	V	Pass



<b>Band :</b>	WCDMA Band V for CH4233		<b>Temperature :</b>	22~23°C					
<b>Test Mode :</b>	RMC 12.2Kbps Link (QPSK)		<b>Relative Humidity :</b>	42~43%					
<b>Test Engineer :</b>	Star Wei		<b>Polarization :</b>	Horizontal					
<b>Remark :</b>	Spurious emissions within 30-1000MHz were found more than 20dB below limit line.								
Frequency ( MHz )	ERP ( dBm )	Limit ( dBm )	Over Limit ( dB )	SPA Reading ( dBm )	S.G. Power ( dBm )	TX Cable loss ( dB )	TX Antenna Gain ( dBi )	Polarization ( H/V )	Result
1696	-63.70	-13	-50.70	-57.45	-64.35	0.57	3.37	H	Pass
2538	-57.12	-13	-44.12	-57.54	-59.35	0.78	5.16	H	Pass
3386	-65.18	-13	-52.18	-64.81	-68.82	0.87	6.66	H	Pass

<b>Band :</b>	WCDMA Band V for CH4233		<b>Temperature :</b>	22~23°C					
<b>Test Mode :</b>	RMC 12.2Kbps Link (QPSK)		<b>Relative Humidity :</b>	42~43%					
<b>Test Engineer :</b>	Star Wei		<b>Polarization :</b>	Vertical					
<b>Remark :</b>	Spurious emissions within 30-1000MHz were found more than 20dB below limit line.								
Frequency ( MHz )	ERP ( dBm )	Limit ( dBm )	Over Limit ( dB )	SPA Reading ( dBm )	S.G. Power ( dBm )	TX Cable loss ( dB )	TX Antenna Gain ( dBi )	Polarization ( H/V )	Result
1694	-66.67	-13	-53.67	-62.87	-67.32	0.57	3.37	V	Pass
2544	-43.31	-13	-30.31	-51.92	-45.54	0.78	5.16	V	Pass
3386	-65.65	-13	-52.65	-66.71	-69.29	0.87	6.66	V	Pass



<b>Band :</b>	WCDMA Band II for CH9262	<b>Temperature :</b>	22~23°C						
<b>Test Mode :</b>	RMC 12.2Kbps Link (QPSK)	<b>Relative Humidity :</b>	42~43%						
<b>Test Engineer :</b>	Star Wei	<b>Polarization :</b>	Horizontal						
<b>Remark :</b>	Spurious emissions within 30-1000MHz were found more than 20dB below limit line.								
Frequency ( MHz )	EIRP ( dBm )	Limit ( dBm )	Over Limit ( dB )	SPA Reading ( dBm )	S.G. Power ( dBm )	TX Cable loss ( dB )	TX Antenna Gain ( dBi )	Polarization ( H/V )	Result
3705	-58.81	-13	-45.81	-62.22	-65.19	0.78	7.16	H	Pass
5557	-57.06	-13	-44.06	-67.12	-65.60	1.04	9.58	H	Pass
7410	-55.65	-13	-42.65	-67.19	-65.76	1.35	11.46	H	Pass

<b>Band :</b>	WCDMA Band II for CH9262	<b>Temperature :</b>	22~23°C						
<b>Test Mode :</b>	RMC 12.2Kbps Link (QPSK)	<b>Relative Humidity :</b>	42~43%						
<b>Test Engineer :</b>	Star Wei	<b>Polarization :</b>	Vertical						
<b>Remark :</b>	Spurious emissions within 30-1000MHz were found more than 20dB below limit line.								
Frequency ( MHz )	EIRP ( dBm )	Limit ( dBm )	Over Limit ( dB )	SPA Reading ( dBm )	S.G. Power ( dBm )	TX Cable loss ( dB )	TX Antenna Gain ( dBi )	Polarization ( H/V )	Result
3705	-50.01	-13	-37.01	-59.07	-56.39	0.78	7.16	V	Pass
5557	-53.98	-13	-40.98	-66.63	-62.52	1.04	9.58	V	Pass
7410	-52.94	-13	-39.94	-67.03	-63.05	1.35	11.46	V	Pass



<b>Band :</b>	WCDMA Band II for CH9400	<b>Temperature :</b>	22~23°C						
<b>Test Mode :</b>	RMC 12.2Kbps Link (QPSK)	<b>Relative Humidity :</b>	42~43%						
<b>Test Engineer :</b>	Star Wei	<b>Polarization :</b>	Horizontal						
<b>Remark :</b>	Spurious emissions within 30-1000MHz were found more than 20dB below limit line.								
Frequency ( MHz )	EIRP ( dBm )	Limit ( dBm )	Over Limit ( dB )	SPA Reading ( dBm )	S.G. Power ( dBm )	TX Cable loss ( dB )	TX Antenna Gain ( dBi )	Polarization ( H/V )	Result
3759	-61.56	-13	-48.56	-64.91	-67.94	0.78	7.16	H	Pass
5640	-58.09	-13	-45.09	-68.15	-66.63	1.04	9.58	H	Pass
7521	-55.99	-13	-42.99	-67.53	-66.10	1.35	11.46	H	Pass

<b>Band :</b>	WCDMA Band II for CH9400	<b>Temperature :</b>	22~23°C						
<b>Test Mode :</b>	RMC 12.2Kbps Link (QPSK)	<b>Relative Humidity :</b>	42~43%						
<b>Test Engineer :</b>	Star Wei	<b>Polarization :</b>	Vertical						
<b>Remark :</b>	Spurious emissions within 30-1000MHz were found more than 20dB below limit line.								
Frequency ( MHz )	EIRP ( dBm )	Limit ( dBm )	Over Limit ( dB )	SPA Reading ( dBm )	S.G. Power ( dBm )	TX Cable loss ( dB )	TX Antenna Gain ( dBi )	Polarization ( H/V )	Result
3762	-49.69	-13	-36.69	-58.78	-56.07	0.78	7.16	V	Pass
5640	-54.07	-13	-41.07	-66.72	-62.61	1.04	9.58	V	Pass
7521	-53.69	-13	-40.69	-67.78	-63.80	1.35	11.46	V	Pass



<b>Band :</b>	WCDMA Band II for CH9538	<b>Temperature :</b>	22~23°C						
<b>Test Mode :</b>	RMC 12.2Kbps Link (QPSK)	<b>Relative Humidity :</b>	42~43%						
<b>Test Engineer :</b>	Star Wei	<b>Polarization :</b>	Horizontal						
<b>Remark :</b>	Spurious emissions within 30-1000MHz were found more than 20dB below limit line.								
Frequency ( MHz )	EIRP ( dBm )	Limit ( dBm )	Over Limit ( dB )	SPA Reading ( dBm )	S.G. Power ( dBm )	TX Cable loss ( dB )	TX Antenna Gain ( dBi )	Polarization ( H/V )	Result
3816	-62.57	-13	-49.57	-65.92	-68.95	0.78	7.16	H	Pass
5723	-54.82	-13	-41.82	-64.88	-63.36	1.04	9.58	H	Pass
7629	-55.25	-13	-42.25	-66.79	-65.36	1.35	11.46	H	Pass

<b>Band :</b>	WCDMA Band II for CH9538	<b>Temperature :</b>	22~23°C						
<b>Test Mode :</b>	RMC 12.2Kbps Link (QPSK)	<b>Relative Humidity :</b>	42~43%						
<b>Test Engineer :</b>	Star Wei	<b>Polarization :</b>	Vertical						
<b>Remark :</b>	Spurious emissions within 30-1000MHz were found more than 20dB below limit line.								
Frequency ( MHz )	EIRP ( dBm )	Limit ( dBm )	Over Limit ( dB )	SPA Reading ( dBm )	S.G. Power ( dBm )	TX Cable loss ( dB )	TX Antenna Gain ( dBi )	Polarization ( H/V )	Result
3816	-52.50	-13	-39.50	-60.9	-58.88	0.78	7.16	V	Pass
5723	-54.63	-13	-41.63	-67.28	-63.17	1.04	9.58	V	Pass
7629	-52.79	-13	-39.79	-66.88	-62.90	1.35	11.46	V	Pass





## 3.8 Frequency Stability Measurement

### 3.8.1 Description of Frequency Stability Measurement

The frequency stability shall be measured by variation of ambient temperature and variation of primary supply voltage to ensure that the fundamental emission stays within the authorized frequency block. The frequency stability of the transmitter shall be maintained within  $\pm 0.00025\%$  ( $\pm 2.5\text{ppm}$ ) of the center frequency.

### 3.8.2 Measuring Instruments

The measuring equipment is listed in the section 4 of this test report.

### 3.8.3 Test Procedures for Temperature Variation

1. The testing follows FCC KDB 971168 v02r01 Section 9.0.
2. The EUT was set up in the thermal chamber and connected with the system simulator.
3. With power OFF, the temperature was decreased to  $-30^{\circ}\text{C}$  and the EUT was stabilized before testing. Power was applied and the maximum change in frequency was recorded within one minute.
4. With power OFF, the temperature was raised in  $10^{\circ}\text{C}$  steps up to  $50^{\circ}\text{C}$ . The EUT was stabilized at each step for at least half an hour. Power was applied and the maximum frequency change was recorded within one minute.

### 3.8.4 Test Procedures for Voltage Variation

1. The testing follows FCC KDB 971168 v02r01 Section 9.0.
2. The EUT was placed in a temperature chamber at  $25\pm 5^{\circ}\text{C}$  and connected with the system simulator.
3. The power supply voltage to the EUT was varied from BEP to 115% of the nominal value measured at the input to the EUT.
4. The variation in frequency was measured for the worst case.

### 3.8.5 Test Setup

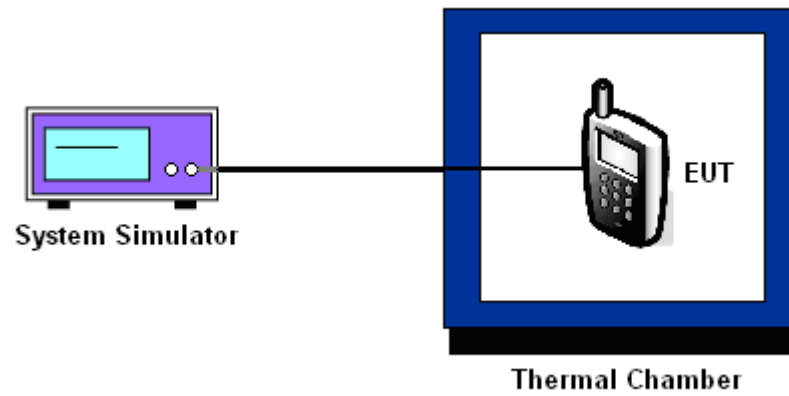



3.8.6 Test Result of Temperature Variation

Band :	GSM 850	Channel :	189
Limit (ppm) :	2.5	Frequency :	836.4 MHz

Temperature (°C)	GSM		EDGE class 8		Result
	Freq. Dev. (Hz)	Deviation (ppm)	Freq. Dev. (Hz)	Deviation (ppm)	
-30	22	+0.03	16	+0.02	PASS
-20	18	+0.02	-8	-0.01	
-10	14	+0.02	-9	-0.01	
0	-16	-0.02	13	+0.02	
10	9	+0.01	14	+0.02	
20(Ref.)	14	+0.02	12	+0.01	
30	13	+0.02	-14	-0.02	
40	11	+0.01	16	+0.02	
50	-15	-0.02	9	+0.01	

Band :	GSM 1900	Channel :	661
Limit (ppm) :	within authorized band	Frequency :	1880.0 MHz

Temperature (°C)	GSM		EDGE class 8		Result
	Freq. Dev. (Hz)	Deviation (ppm)	Freq. Dev. (Hz)	Deviation (ppm)	
-30	-12	-0.01	-17	-0.01	PASS
-20	16	+0.01	16	+0.01	
-10	18	+0.01	14	+0.01	
0	21	+0.01	18	+0.01	
10	17	+0.01	-18	-0.01	
20(Ref.)	-16	-0.01	21	+0.01	
30	13	+0.01	16	+0.01	
40	11	+0.01	13	+0.01	
50	17	+0.01	11	+0.01	

Note: The frequency fundamental emissions stay within the authorized frequency block based on the frequency deviation measured is small.



<b>Band :</b>	WCDMA Band V	<b>Channel :</b>	4182
<b>Limit (ppm) :</b>	2.5	<b>Frequency :</b>	836.4 MHz

Temperature (°C)	RMC 12.2Kbps		Result
	Freq. Dev. (Hz)	Deviation (ppm)	
-30	-16	-0.02	PASS
-20	-21	-0.02	
-10	14	+0.02	
0	17	+0.02	
10	11	+0.01	
20(Ref.)	13	+0.02	
30	15	+0.02	
40	-12	-0.01	
50	14	+0.02	

<b>Band :</b>	WCDMA Band II	<b>Channel :</b>	9400
<b>Limit (ppm) :</b>	within authorized band	<b>Frequency :</b>	1880.0 MHz

Temperature (°C)	RMC 12.2Kbps		Result
	Freq. Dev. (Hz)	Deviation (ppm)	
-30	-27	-0.01	PASS
-20	16	+0.01	
-10	13	+0.01	
0	18	+0.01	
10	-14	-0.01	
20(Ref.)	15	+0.01	
30	-19	-0.01	
40	21	+0.01	
50	17	+0.01	

Note: The frequency fundamental emissions stay within the authorized frequency block based on the frequency deviation measured is small.



3.8.7 Test Result of Voltage Variation

Band & Channel	Mode	Voltage (Volt)	Freq. Dev. (Hz)	Deviation (ppm)	Limit (ppm)	Result
GSM 850 CH189	GSM	3.80	14	+0.02	2.5 (Note 3.)	PASS
		BEP	13	+0.02		
		4.35	-15	-0.02		
	EDGE class 8	3.80	-14	-0.02		
		BEP	16	+0.02		
		4.35	9	+0.01		
GSM 1900 CH661	GSM	3.80	-16	-0.01		
		BEP	12	+0.01		
		4.35	19	+0.01		
	EDGE class 8	3.80	-11	-0.01		
		BEP	17	+0.01		
		4.35	13	+0.01		
WCDMA Band V CH4182	RMC 12.2Kbps	3.80	-12	-0.01		
		BEP	13	+0.02		
		4.35	16	+0.02		
WCDMA Band II CH9400	RMC 12.2Kbps	3.80	-16	-0.01		
		BEP	21	+0.01		
		4.35	18	+0.01		

Note:

1. Normal Voltage = 3.80V.
2. Battery End Point (BEP) = 3.45 V.
3. The frequency fundamental emissions stay within the authorized frequency block based on the frequency deviation measured is small.



## 4 List of Measuring Equipment

Instrument	Manufacturer	Model No.	Serial No.	Characteristics	Calibration Date	Test Date	Due Date	Remark
Spectrum Analyzer	R&S	FSP40	100319	9kHz~40GHz	Dec. 28, 2013	Aug. 11, 2014~ Aug. 19, 2014	Dec. 27, 2014	Conducted (TH01-KS)
Spectrum Analyzer	R&S	FSV30	101338	9kHz~30GHz	May 04, 2014	Aug. 11, 2014~ Aug. 19, 2014	May 03, 2015	Conducted (TH01-KS)
Thermal Chamber	Ten Billion	TTC-B3S	TBN-960502	-40~+150°C	Dec. 10, 2013	Aug. 11, 2014~ Aug. 19, 2014	Dec. 09, 2014	Conducted (TH01-KS)
EMI Test Receiver	R&S	ESCI	100534	9kHz~3GHz	Nov. 05, 2013	Aug. 18, 2014	Nov. 04, 2014	Radiation (03CH01-KS)
Spectrum Analyzer	R&S	FSP30	101399	9kHz~30GHz	May 04, 2014	Aug. 18, 2014	May 03, 2015	Radiation (03CH01-KS)
Bilog Antenna	SCHAFFNER	CBL6112D	23182	25MHz~2GHz	Jan. 08, 2014	Aug. 18, 2014	Jan. 07, 2015	Radiation (03CH01-KS)
Double Ridge Horn Antenna	ETS-Lindgren	3117	75959	1GHz~18GHz	Jan. 08, 2014	Aug. 18, 2014	Jan. 07, 2015	Radiation (03CH01-KS)
Active Horn Antenna	com-power	AHA-118	701030	1GHz~18GHz	Nov. 18, 2013	Aug. 18, 2014	Nov. 17, 2014	Radiation (03CH01-KS)
SHF-EHF Horn	Schwarzbeck	BBHA 9170	BBHA170249	15GHz~40GHz	Mar. 10, 2014	Aug. 18, 2014	Mar. 09, 2015	Radiation (03CH01-KS)
Amplifier	com-power	PA-103A	161073	1MHz~1GHz	May 04, 2014	Aug. 18, 2014	May 03, 2015	Radiation (03CH01-KS)
Amplifier	Agilent	8449B	3008A02371	1GHz~26.5GHz	Dec. 10, 2013	Aug. 18, 2014	Dec. 09, 2014	Radiation (03CH01-KS)
AC Power Source	Chroma	61601	F104090004	N/A	NCR	Aug. 18, 2014	NCR	Radiation (03CH01-KS)
Turn Table	MF	MF7802	N/A	0~360 degree	NCR	Aug. 18, 2014	NCR	Radiation (03CH01-KS)
Antenna Mast	MF	MF7802	N/A	1 m~4 m	NCR	Aug. 18, 2014	NCR	Radiation (03CH01-KS)



## 5 Uncertainty of Evaluation

### Uncertainty of Radiated Emission Measurement (30 MHz ~ 1000 MHz)

Measuring Uncertainty for a Level of Confidence of 95% ( $U = 2Uc(y)$ )	2.5
---	-----