



FCC RF Test Report

APPLICANT : Acer Incorporated
EQUIPMENT : Smart HandHeld
BRAND NAME : Acer
MODEL NAME : Z200, Z205
MARKETING NAME : Liquid Z200, Liquid Z205
FCC ID : HLZDMZ200
STANDARD : FCC Part 15 Subpart C §15.247
CLASSIFICATION : (DTS) Digital Transmission System

The product was received on Jun. 11, 2014 and testing was completed on Jul. 02, 2014. We, SPORTON INTERNATIONAL (KUNSHAN) INC., would like to declare that the tested sample has been evaluated in accordance with the test procedures and has been in compliance with the applicable technical standards.

The test results in this report apply exclusively to the tested model / sample. Without written approval of SPORTON INTERNATIONAL (KUNSHAN) INC., the test report shall not be reproduced except in full.

Reviewed by: Joseph Lin / Supervisor

Approved by: Jones Tsai / Manager



SPORTON INTERNATIONAL (KUNSHAN) INC.
No. 3-2, PingXiang Road, Kunshan, Jiangsu Province, P.R.C.



TABLE OF CONTENTS

REVISION HISTORY.....	3
SUMMARY OF TEST RESULT	4
1 GENERAL DESCRIPTION.....	5
1.1 Applicant.....	5
1.2 Manufacturer.....	5
1.3 Product Feature of Equipment Under Test.....	5
1.4 Product Specification subjective to this standard	5
1.5 Modification of EUT	6
1.6 Testing Location	6
1.7 Applicable Standards.....	6
2 TEST CONFIGURATION OF EQUIPMENT UNDER TEST.....	7
2.1 Descriptions of Test Mode.....	7
2.2 Test Mode.....	8
2.3 Connection Diagram of Test System.....	9
2.4 Support Unit used in test configuration and system.....	10
2.5 EUT Operation Test Setup	10
2.6 Measurement Results Explanation Example.....	10
3 TEST RESULT	11
3.1 6dB and 99% Bandwidth Measurement.....	11
3.2 Peak Output Power Measurement	16
3.3 Power Spectral Density Measurement	18
3.4 Conducted Band Edges and Spurious Emission Measurement	24
3.5 Radiated Band Edges and Spurious Emission Measurement	33
3.6 AC Conducted Emission Measurement.....	42
3.7 Antenna Requirements.....	46
4 LIST OF MEASURING EQUIPMENT.....	47
5 UNCERTAINTY OF EVALUATION.....	48
APPENDIX A. SETUP PHOTOGRAPHS	



SUMMARY OF TEST RESULT

Report Section	FCC Rule	IC Rule	Description	Limit	Result	Remark
3.1	15.247(a)(2)	RSS-210 A8.2(a)	6dB Bandwidth	$\geq 0.5\text{MHz}$	Pass	-
3.1	-	RSS-Gen 4.6.1	99% Bandwidth	-	Pass	-
3.2	15.247(b)(1)	RSS-210 A8.1(b)	Peak Output Power	$\leq 30\text{dBm}$	Pass	-
3.3	15.247(e)	RSS-210 A8.2(b)	Power Spectral Density	$\leq 8\text{dBm}$	Pass	-
3.4	15.247(d)	RSS-210 A8.5	Conducted Band Edges and Spurious Emission	$\leq 20\text{dBc}$	Pass	-
3.5	15.247(d)	RSS-210 A8.5	Radiated Band Edges and Spurious Emission	15.209(a) & 15.247(d)	Pass	Under limit 5.64 dB at 30.970 MHz
3.6	15.207	RSS-Gen 7.2.4	AC Conducted Emission	15.207(a)	Pass	Under limit 11.48 dB at 3.940 MHz
3.7	15.203 & 15.247(b)	RSS-210 A8.4	Antenna Requirement	N/A	Pass	-



1 General Description

1.1 Applicant

Acer Incorporated

8F, No. 88, Sec. 1, Xintai 5th Rd, Xizhi Dist, New Taipei City 22181, Taiwan (R.O.C)

1.2 Manufacturer

Shanghai Wingtech Electronic Technology Co, Ltd.

6th Floor, G Block, No. 668, East Beijing Road, HuangPu District, Shanghai, P.R.China

1.3 Product Feature of Equipment Under Test

Product Feature	
Equipment	Smart HandHeld
Brand Name	Acer
Model Name	Z200, Z205
Marketing Name	Liquid Z200, Liquid Z205
FCC ID	HLZDMZ200
EUT supports Radios application	GSM/GPRS/EGPRS/WCDMA/HSPA/HSPA+(Downlink Only) WLAN 2.4GHz 802. 11b/g/n HT20/ HT40 Bluetooth v3.0 + EDR/Bluetooth v4.0 LE
EUT Stage	Identical Prototype

Remark:

1. The above EUT's information was declared by manufacturer. Please refer to the specifications or user's manual for more detailed description.
2. The difference between model name Z200 and Z205 is only for the designation of appearance which does not affect any test items, so we only choose the sample 1 Z200 for all tests.

1.4 Product Specification subjective to this standard

Product Specification subjective to this standard	
Tx/Rx Frequency Range	2402 MHz ~ 2480 MHz
Number of Channels	40
Carrier Frequency of Each Channel	40 Channel(37 hopping + 3 advertising channel)
Maximum Output Power to Antenna	-0.77 dBm (0.00084 W)
99% Occupied Bandwidth	1.02MHz
Antenna Type	PIFA Antenna with gain 1.24 dBi
Type of Modulation	Bluetooth LE : GFSK



1.5 Modification of EUT

No modifications are made to the EUT during all test items.

1.6 Testing Location

Test Site	SPORTON INTERNATIONAL (KUNSHAN) INC.			
Test Site Location	No. 3-2, PingXiang Road, Kunshan, Jiangsu Province, P.R.C. TEL: +86-0512-5790-0158 FAX: +86-0512-5790-0958			
Test Site No.	Sporton Site No.			FCC/IC Registration No.
	TH01-KS	03CH01-KS	CO01-KS	149928/4086E-1

1.7 Applicable Standards

According to the specifications of the manufacturer, the EUT must comply with the requirements of the following standards:

- ♦ FCC Part 15 Subpart C §15.247
- ♦ FCC KDB Publication No. 558074 D01 DTS Meas. Guidance v03r02
- ♦ ANSI C63.4-2003
- ♦ IC RSS-210 Issue 8
- ♦ IC RSS-Gen Issue 3
- ♦ NOTICE 2012-DRS0126

Remark:

1. All test items were verified and recorded according to the standards and without any deviation during the test.
2. This EUT has also been tested and complied with the requirements of FCC Part 15, Subpart B, recorded in a separate test report.



2 Test Configuration of Equipment Under Test

2.1 Descriptions of Test Mode

The RF output power was recorded in the following table:

Channel	Frequency	Bluetooth 4.0 LE RF Output Power
		Data Rate / Modulation
		GFSK
		1Mbps
Ch00	2402MHz	-1.01 dBm
Ch19	2440MHz	-0.77 dBm
Ch39	2480MHz	-0.96 dBm

- a. The EUT has been associated with peripherals and configuration operated in a manner tended to maximize its emission characteristics in a typical application. Frequency range investigated: conduction (150 kHz to 30 MHz), radiation (9 kHz to the 10th harmonic of the highest fundamental frequency or to 40 GHz, whichever is lower). Pre-scanned tests, X, Y, Z in three orthogonal panels to determine the final configuration (Z plane as worst plane) from all possible combinations.

- b. AC power line Conducted Emission was tested under maximum output power.



2.2 Test Mode

The following summary table is showing all test modes to demonstrate in compliance with the standard.

Summary table of Test Cases	
Test Item	Data Rate / Modulation
	Bluetooth 4.0 LE / GFSK
Conducted TCs	Mode 1: Bluetooth Tx CH00_2402 MHz_1Mbps Mode 2: Bluetooth Tx CH19_2440 MHz_1Mbps Mode 3: Bluetooth Tx CH39_2480 MHz_1Mbps
Radiated TCs	Mode 1: Bluetooth Tx CH00_2402 MHz_1Mbps Mode 2: Bluetooth Tx CH19_2440 MHz_1Mbps Mode 3: Bluetooth Tx CH39_2480 MHz_1Mbps
AC Conducted Emission	Mode 1: GSM 850Idle + Bluetooth Link + WLAN Link + USB Cable (Charging from Adapter) + Earphone
Remark: For radiated TCs, the tests were performed with adapter, USB cable and Earphone.	

2.3 Connection Diagram of Test System

<Bluetooth 4.0 LE Tx Mode>

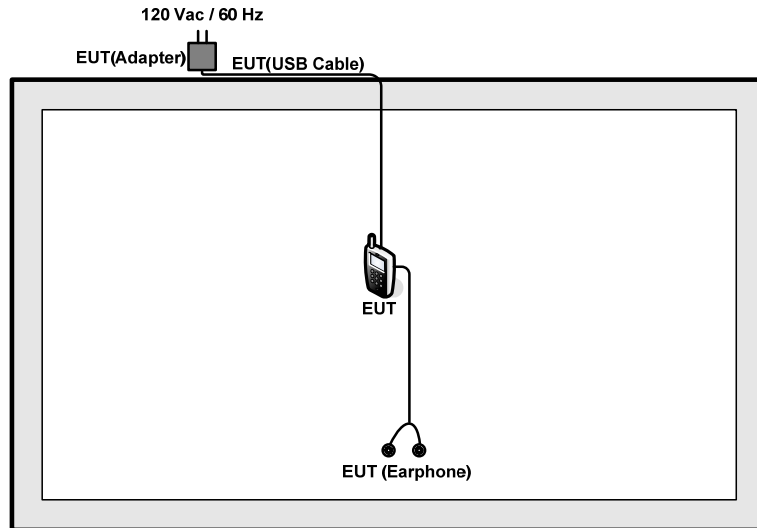

<AC Conducted Emission Mode>

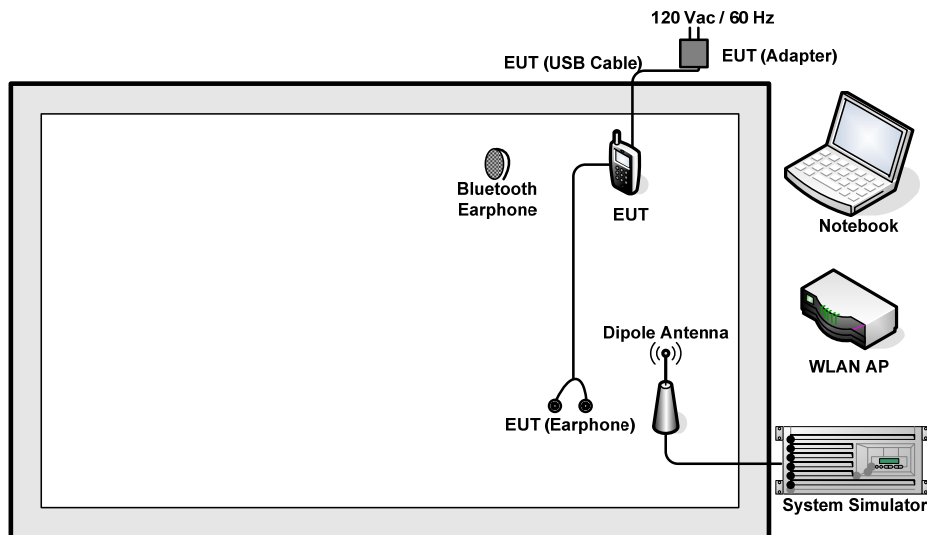

2.4 Support Unit used in test configuration and system

Item	Equipment	Trade Name	Model Name	FCC ID	Data Cable	Power Cord
1.	System Simulator	R&S	CMU 200	N/A	N/A	Unshielded, 1.8 m
2.	WLAN AP	D-Link	DIR-855	KA2DIR855A2	N/A	Unshielded, 1.8 m
3.	Notebook	Lenovo	G480	PRC4	N/A	AC I/P: Unshielded, 1.8 m DC O/P: Shielded, 1.8 m
4.	Bluetooth Earphone	Nokia	BH-102	PYAHS-107W	N/A	N/A

2.5 EUT Operation Test Setup

For Bluetooth function, the engineering test program was provided and enabled to make EUT continuous transmit/receive.

For AC power line conducted emissions, the EUT was set to connect with the WLAN AP under large package sizes transmission.

2.6 Measurement Results Explanation Example

For all conducted test items:

The offset level is set in the spectrum analyzer to compensate the RF cable loss and attenuator factor between EUT conducted output port and spectrum analyzer. With the offset compensation, the spectrum analyzer reading level is exactly the EUT RF output level.

Example :

The spectrum analyzer offset is derived from RF cable loss and attenuator factor.

Offset = RF cable loss + attenuator factor.

Following shows an offset computation example with cable loss 6.0 dB and 10dB attenuator.

$$\begin{aligned}
 \text{Offset(dB)} &= \text{RF cable loss(dB)} + \text{attenuator factor(dB)}. \\
 &= 6.0 + 10 = 16.0 \text{ (dB)}
 \end{aligned}$$

3 Test Result

3.1 6dB and 99% Bandwidth Measurement

3.1.1 Limit of 6dB and 99% Bandwidth

The minimum 6 dB bandwidth shall be at least 500 kHz.

3.1.2 Measuring Instruments

The section 4.0 of List of Measuring Equipment of this test report is used for test.

3.1.3 Test Procedures

1. The testing follows FCC KDB Publication No. 558074 D01 DTS Meas. Guidance v03r02.
2. The RF output of EUT was connected to the spectrum analyzer by RF cable and attenuator. The path loss was compensated to the results for each measurement.
3. Set to the maximum power setting and enable the EUT transmit continuously.
4. Make the measurement with the spectrum analyzer's resolution bandwidth (RBW) = 100 kHz. Set the Video bandwidth (VBW) = 300 kHz. In order to make an accurate measurement. The 6 dB bandwidth must be greater than 500 kHz.
5. For 99% Bandwidth Measurement, the spectrum analyzer's resolution bandwidth (RBW) is set 30kHz and set the Video bandwidth (VBW) = 100kHz.
6. Measure and record the results in the test report.

3.1.4 Test Setup

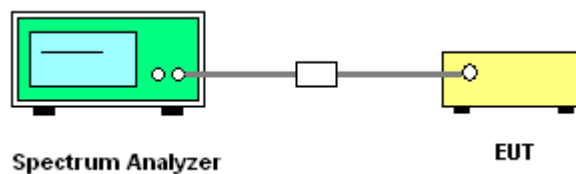



3.1.5 Test Result of 6dB Bandwidth

Test Mode :	Bluetooth 4.0 LE	Temperature :	23~24°C
Test Engineer :	Adonis Li	Relative Humidity :	47~48%

Channel	Frequency (MHz)	6dB Bandwidth (MHz)	6dB Bandwidth Min. Limit (MHz)	Pass/Fail
00	2402	0.680	0.5	Pass
19	2440	0.688	0.5	Pass
39	2480	0.692	0.5	Pass

6 dB Bandwidth Plot on Channel 00

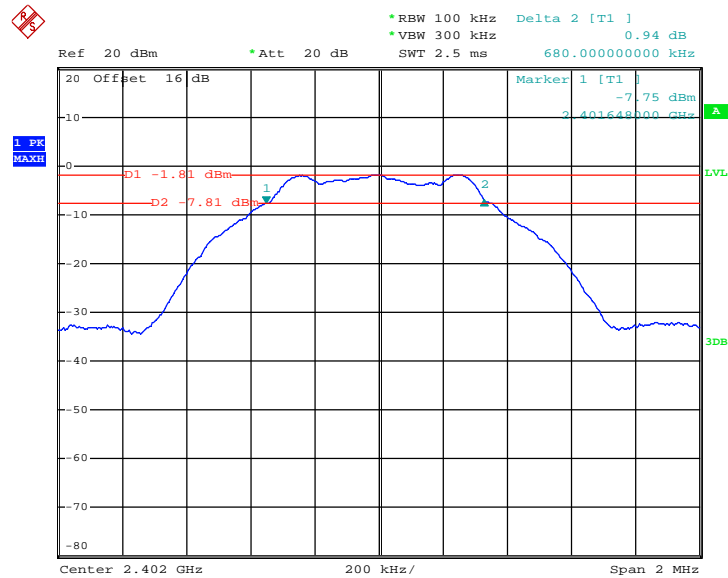

Date: 20.JUN.2014 07:22:36



6 dB Bandwidth Plot on Channel 19

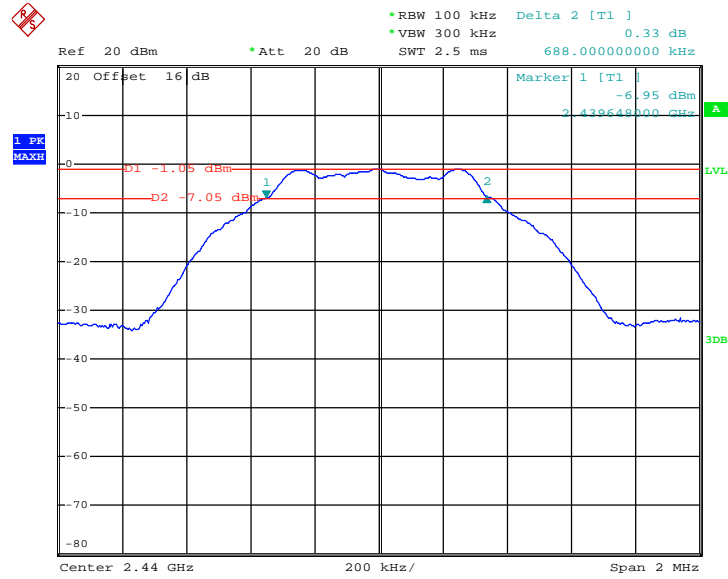

Date: 20.JUN.2014 07:23:40

6 dB Bandwidth Plot on Channel 39

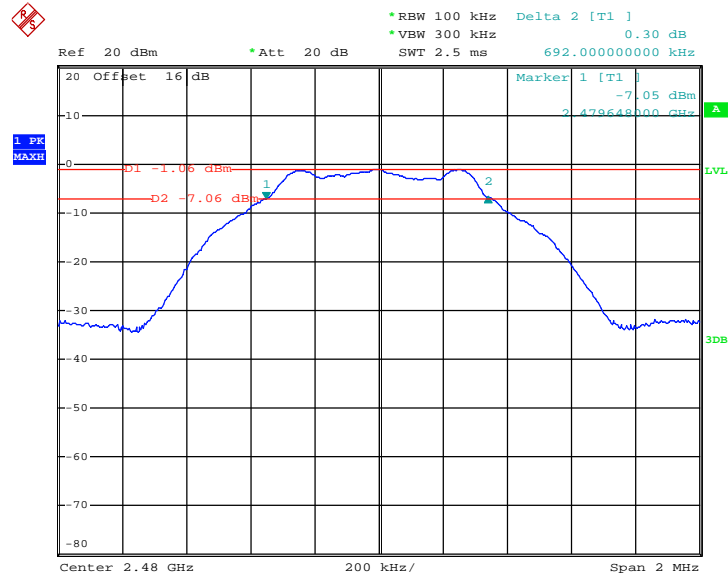

Date: 20.JUN.2014 07:24:39



3.1.6 Test Result of 99% Occupied Bandwidth

Test Mode :	Bluetooth 4.0 LE	Temperature :	23~24°C
Test Engineer :	Adonis Li	Relative Humidity :	47~48%

Channel	Frequency (MHz)	99% Occupied Bandwidth (MHz)
00	2402	1.02
19	2440	1.02
39	2480	1.02

99% Bandwidth Plot on Channel 0

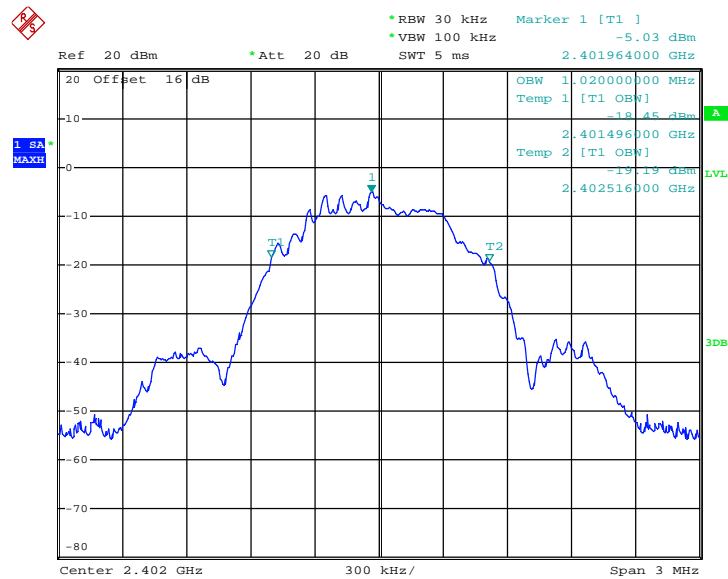

Date: 20.JUN.2014 07:34:35



99% Occupied Bandwidth Plot on Channel 19

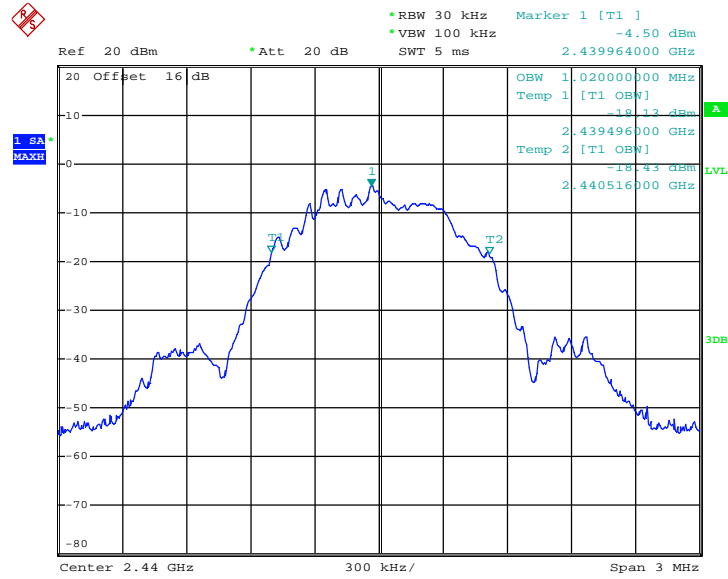

Date: 20.JUN.2014 07:35:00

99% Occupied Bandwidth Plot on Channel 39

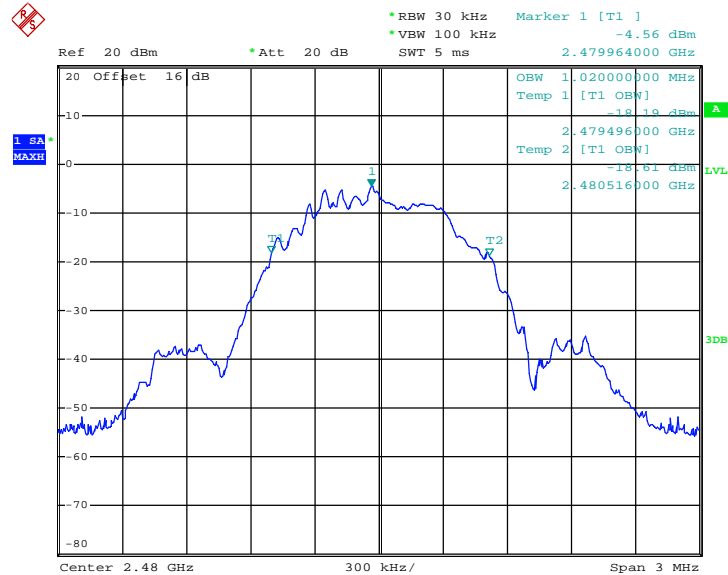

Date: 20.JUN.2014 07:35:23

3.2 Peak Output Power Measurement

3.2.1 Limit of Peak Output Power

For systems using digital modulation in the 2400-2483.5MHz, the limit for peak output power is 30dBm. If transmitting antenna of directional gain greater than 6dBi is used, the peak output power from the intentional radiator shall be reduced below the above stated value by the amount in dB that the directional gain of the antenna exceeds 6 dBi. In case of point-to-point operation, the limit has to be reduced by 1dB for every 3dB that the directional gain of the antenna exceeds 6dBi.

3.2.2 Measuring Instruments

The section 4.0 of List of Measuring Equipment of this test report is used for test.

3.2.3 Test Procedures

1. The testing follows the Measurement Procedure of FCC KDB No. 558074 DTS D01 Meas. Guidance v03r02.
2. The RF output of EUT was connected to the power meter by RF cable and attenuator. The path loss was compensated to the results for each measurement.
3. Set to the maximum power setting and enable the EUT transmit continuously.
4. Measure the conducted output power and record the results in the test report.

3.2.4 Test Setup

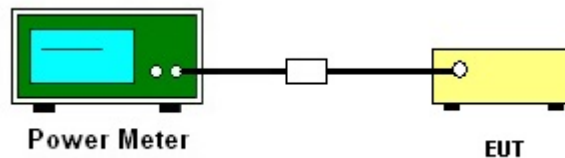



3.2.5 Test Result of Peak Output Power

Test Mode :	Bluetooth 4.0 LE	Temperature :	23~24°C
Test Engineer :	Adonis Li	Relative Humidity :	47~48%

Channel	Frequency (MHz)	RF Power (dBm)		
		GFSK	Max. Limits (dBm)	Pass/Fail
		1 Mbps		
00	2402	-1.01	30.00	Pass
19	2440	-0.77	30.00	Pass
39	2480	-0.96	30.00	Pass

3.3 Power Spectral Density Measurement

3.3.1 Limit of Power Spectral Density

The peak power spectral density shall not be greater than 8dBm in any 3kHz band at any time interval of continuous transmission.

3.3.2 Measuring Instruments

The section 4.0 of List of Measuring Equipment of this test report is used for test.

3.3.3 Test Procedures

1. The testing follows Measurement Procedure 10.2 Method PKPSD of FCC KDB Publication No. 558074 D01 DTS Meas. Guidance v03r02
2. The RF output of EUT was connected to the spectrum analyzer by RF cable and attenuator. The path loss was compensated to the results for each measurement.
3. Set to the maximum power setting and enable the EUT transmit continuously.
4. Make the measurement with the spectrum analyzer's resolution bandwidth (RBW) = 3 kHz. Video bandwidth VBW = 10 kHz In order to make an accurate measurement, set the span to 1.5 times DTS Channel Bandwidth. (6dB BW)
5. Detector = peak, Sweep time = auto couple, Trace mode = max hold, Allow trace to fully stabilize. Use the peak marker function to determine the maximum power level.
6. Measure and record the results in the test report.
7. The Measured power density (dBm)/ 100kHz is a reference level and used as 20dBc down limit line for Conducted Band Edges and Conducted Spurious Emission.

3.3.4 Test Setup

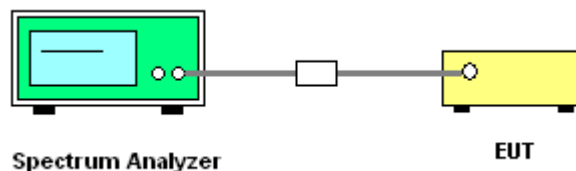



3.3.5 Test Result of Power Spectral Density

Test Mode :	Bluetooth 4.0 LE	Temperature :	23~24°C
Test Engineer :	Adonis Li	Relative Humidity :	47~48%

Channel	Frequency (MHz)	Power Density		Max. Limits (dBm/3kHz)	Pass/Fail
		PSD/100kHz (dBm)	PSD/3kHz (dBm)		
00	2402	-1.52	-16.06	8	Pass
19	2440	-1.04	-15.51	8	Pass
39	2480	-1.19	-15.64	8	Pass

Note:

1. Measured power density (dBm) has offset with cable loss.
2. The Measured power density (dBm)/ 100kHz is reference level and used as 20dBc down for Conducted Band Edges and Conducted Spurious Emission limit line.



3.3.6 Test Result of Power Spectral Density Plots (100kHz)

PSD 100kHz Plot on Channel 00

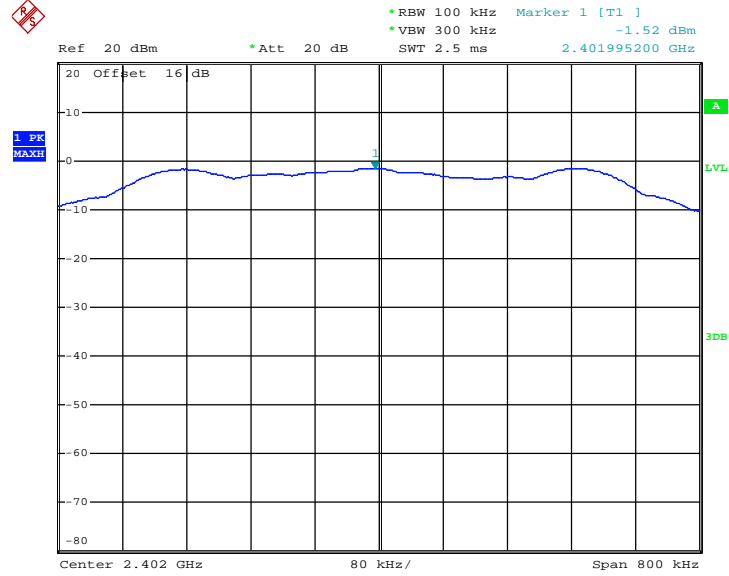

Date: 20.JUN.2014 07:26:16



PSD 100kHz Plot on Channel 19

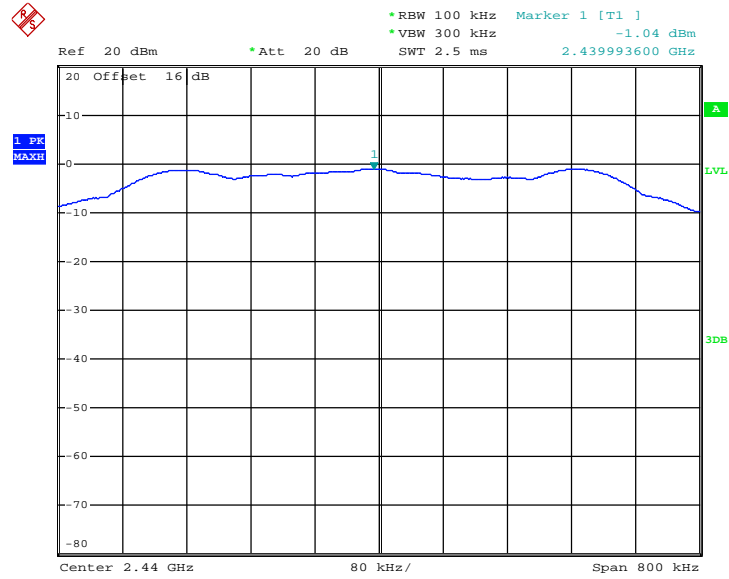

Date: 20.JUN.2014 07:25:54

PSD 100kHz Plot on Channel 39

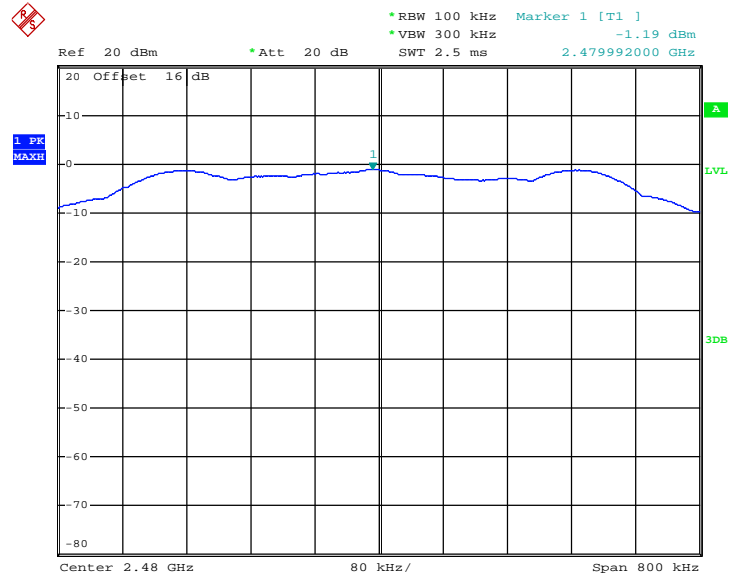

Date: 20.JUN.2014 07:25:29



3.3.7 Test Result of Power Spectral Density Plots (3kHz)

PSD 3kHz Plot on Channel 00

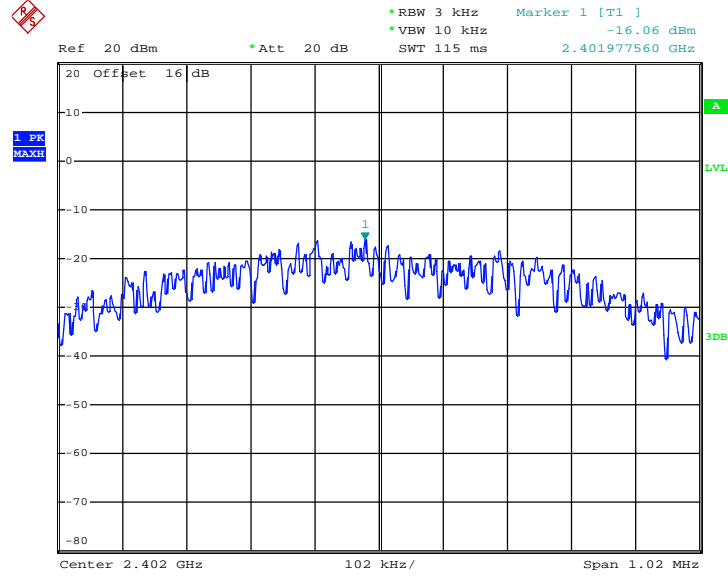

Date: 20.JUN.2014 07:33:41



PSD 3kHz Plot on Channel 19

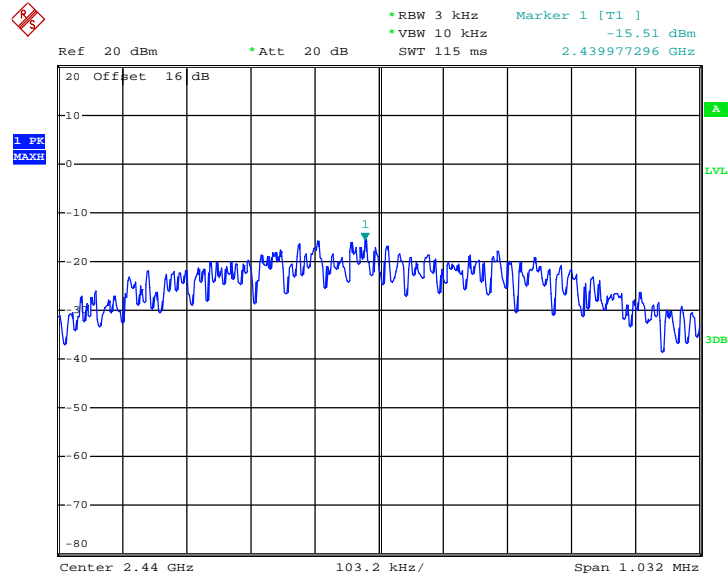

Date: 20.JUN.2014 07:33:06

PSD 3kHz Plot on Channel 39

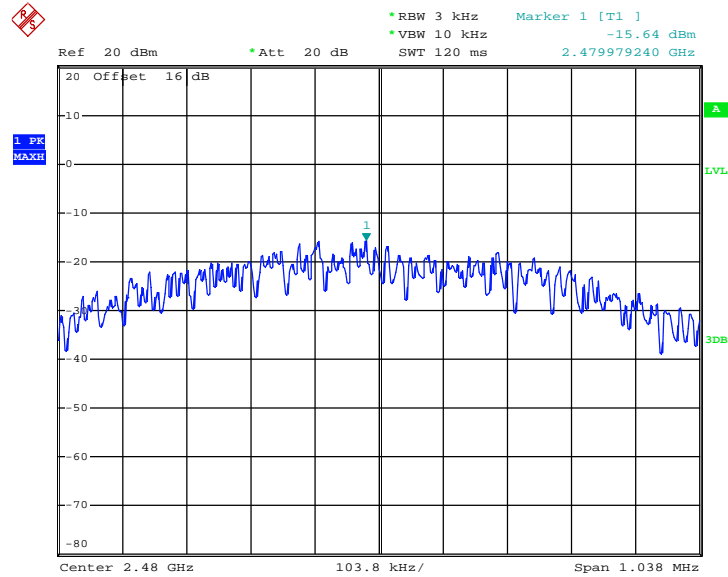

Date: 20.JUN.2014 07:32:33

3.4 Conducted Band Edges and Spurious Emission Measurement

3.4.1 Limit of Conducted Band Edges and Spurious Emission

All harmonics/spurious must be at least 20 dB down from the highest emission level within the authorized band.

3.4.2 Measuring Instruments

The section 4.0 of List of Measuring Equipment of this test report is used for test.

3.4.3 Test Procedure

1. The testing follows FCC KDB Publication No. 558074 D01 DTS Meas. Guidance v03r02.
2. The RF output of EUT was connected to the spectrum analyzer by RF cable and attenuator. The path loss was compensated to the results for each measurement.
3. Set to the maximum power setting and enable the EUT transmit continuously.
4. Set RBW = 100 kHz, VBW=300 kHz, Peak Detector. Unwanted Emissions measured in any 100 kHz bandwidth outside of the authorized frequency band shall be attenuated by at least 20 dB relative to the maximum in-band peak PSD level in 100 kHz when maximum peak conducted output power procedure is used. If the transmitter complies with the conducted power limits based on the use of RMS averaging over a time interval, the attenuation required under this paragraph shall be 30 dB instead of 20 dB per 15.247(d).
5. Measure and record the results in the test report.
6. The RF fundamental frequency should be excluded against the limit line in the operating frequency band.

3.4.4 Test Setup

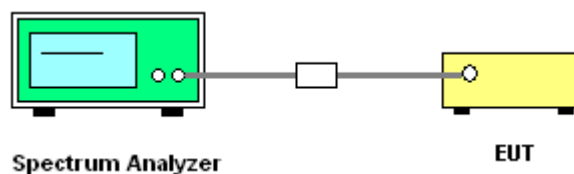



3.4.5 Test Result of Conducted Band Edges

Test Mode :	Bluetooth 4.0 LE	Temperature :	23~24°C
Test Channel :	00 and 39	Relative Humidity :	47~48%
		Test Engineer :	Adonis Li

Low Band Edge Plot on Channel 00

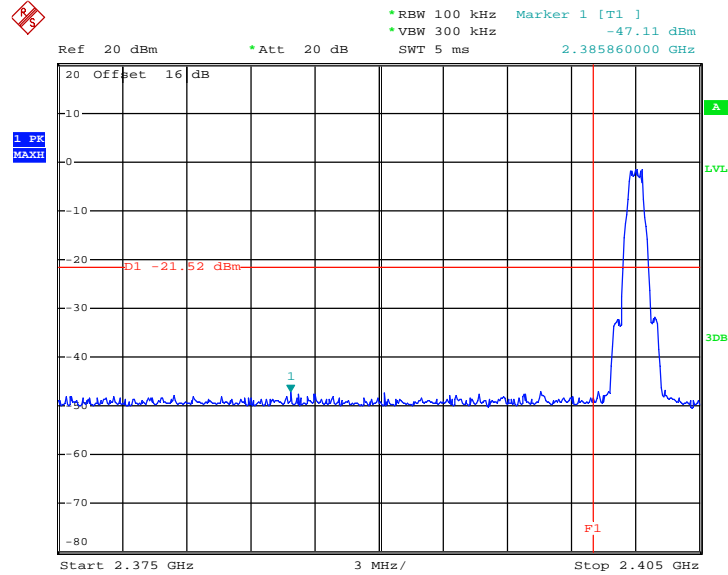

Date: 20.JUN.2014 07:30:05



High Band Edge Plot on Channel 39

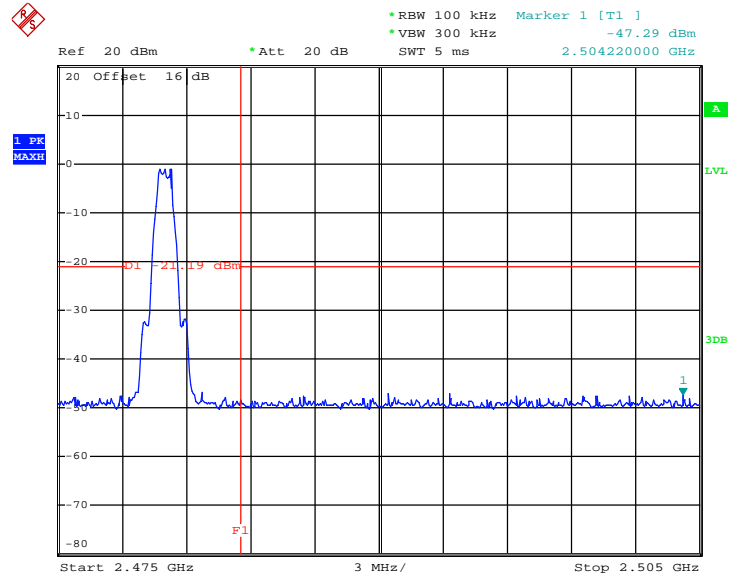

Date: 20.JUN.2014 07:31:28



3.4.6 Test Result of Conducted Spurious Emission

Test Mode :	Bluetooth 4.0 LE	Temperature :	23~24°C
Test Channel :	00	Relative Humidity :	47~48%
		Test Engineer :	Adonis Li

Conducted Spurious Emission Plot on Bluetooth LE 1Mbps GFSK Channel 00

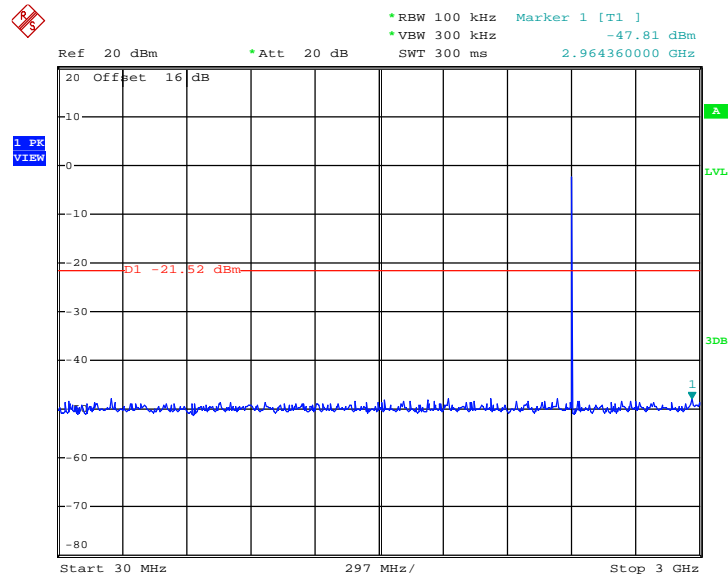

Date: 20.JUN.2014 07:37:06



Conducted Spurious Emission Plot on Bluetooth LE 1Mbps GFSK Channel 00

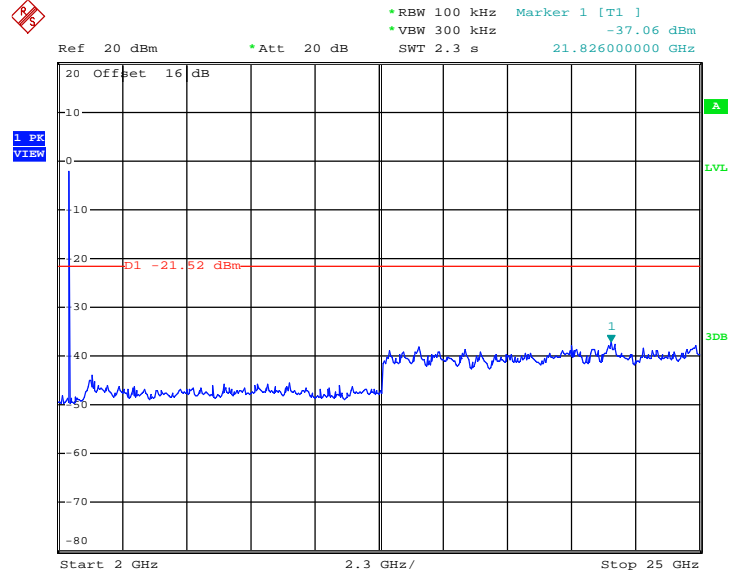

Date: 20.JUN.2014 07:37:50



Test Mode :	Bluetooth 4.0 LE	Temperature :	23~24°C
Test Channel :	19	Relative Humidity :	47~48%
		Test Engineer :	Adonis Li

Conducted Spurious Emission Plot on Bluetooth LE 1Mbps
GFSK Channel 19

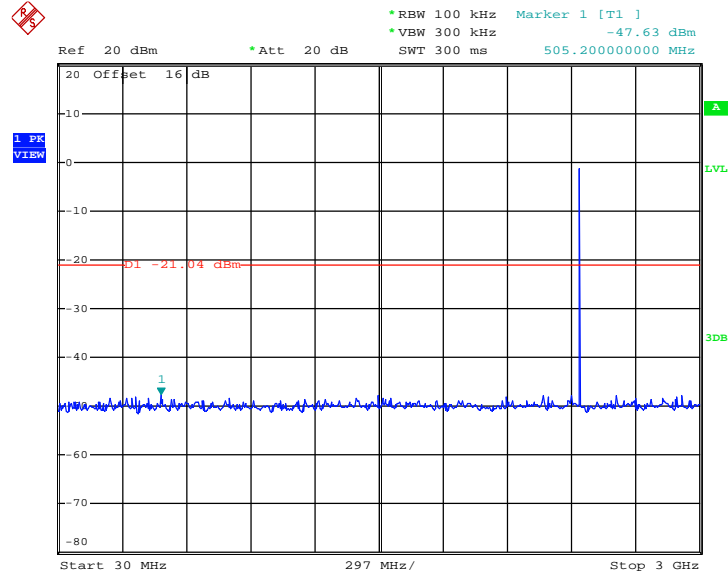

Date: 20.JUN.2014 07:39:13



Conducted Spurious Emission Plot on Bluetooth LE 1Mbps
GFSK Channel 19

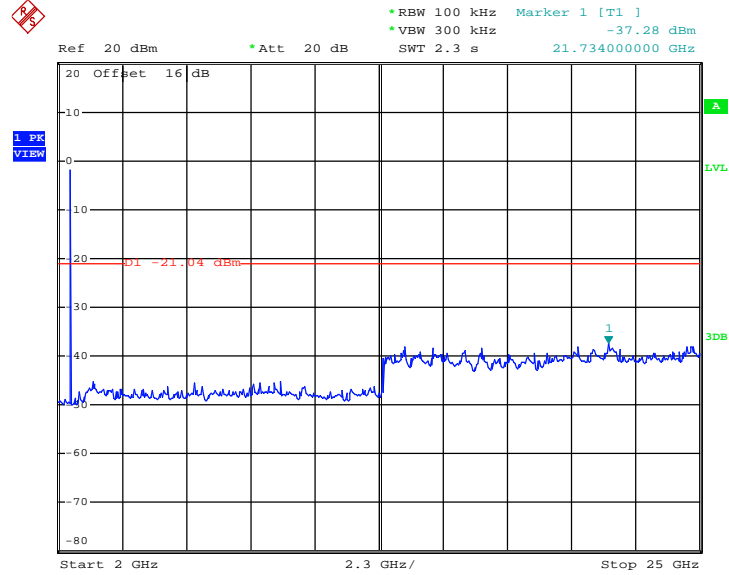

Date: 20.JUN.2014 07:38:22



Test Mode :	Bluetooth 4.0 LE	Temperature :	23~24°C
Test Channel :	39	Relative Humidity :	47~48%
		Test Engineer :	Adonis Li

**Conducted Spurious Emission Plot on Bluetooth LE 1Mbps
GFSK Channel 39**

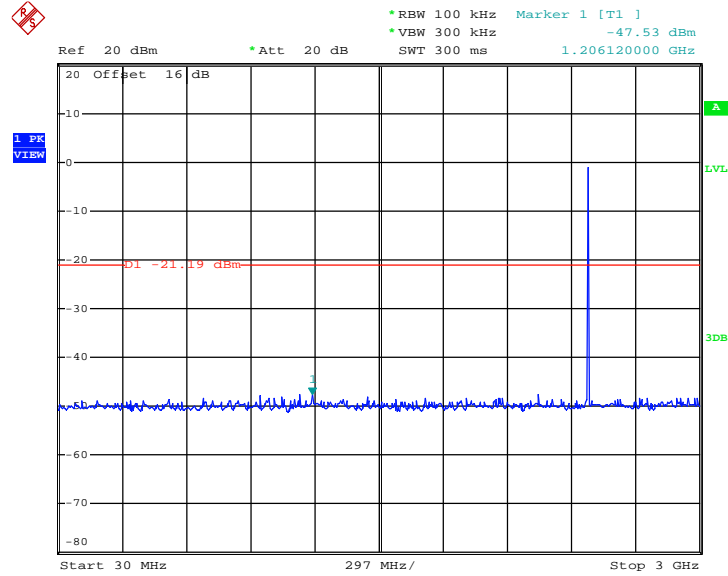

Date: 20.JUN.2014 07:40:27



Conducted Spurious Emission Plot on Bluetooth LE 1Mbps
GFSK Channel 39

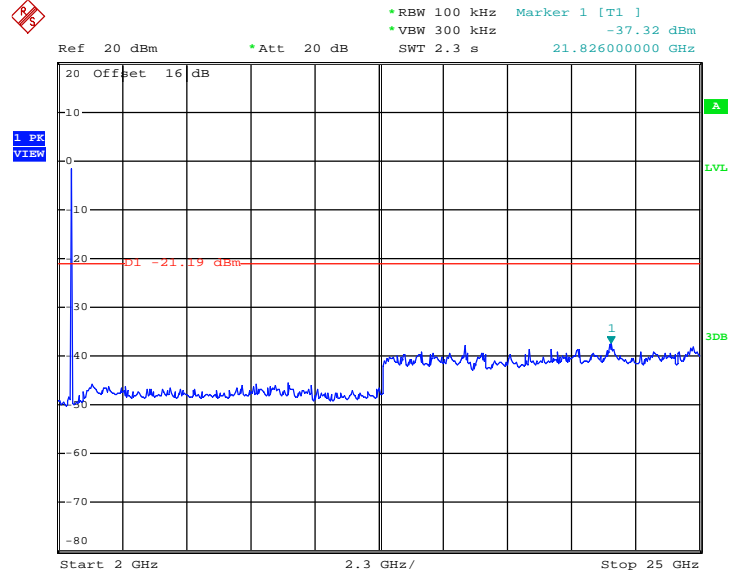

Date: 20.JUN.2014 07:41:08



3.5 Radiated Band Edges and Spurious Emission Measurement

3.5.1 Limit of Radiated Band Edges and Spurious Emission

In any 100 kHz bandwidth outside the intentional radiator frequency band, all harmonics/spurious must be at least 20 dB below the highest emission level within the authorized band. If the output power of this device was measured by spectrum analyzer, the attenuation under this paragraph shall be 30 dB instead of 20 dB. In addition, radiated emissions which fall in the restricted bands must also comply with the FCC section 15.209 limits as below.

Frequency (MHz)	Field Strength (microvolts/meter)	Measurement Distance (meters)
0.009 – 0.490	2400/F(kHz)	300
0.490 – 1.705	24000/F(kHz)	30
1.705 – 30.0	30	30
30 – 88	100	3
88 – 216	150	3
216 - 960	200	3
Above 960	500	3

3.5.2 Measuring Instruments

The section 4.0 of List of Measuring Equipment of this test report is used for test.



3.5.3 Test Procedures

1. The testing follows FCC KDB Publication No. 558074 D01 DTS Meas. Guidance v03r02.
2. The EUT was arranged to its worst case and then tune the antenna tower (from 1 m to 4 m) and turntable (from 0 degree to 360 degrees) to find the maximum reading. A pre-amp and a high pass filter are used for the test in order to get better signal level.
3. The EUT was placed on a turntable with 0.8 meter above ground.
4. The EUT was set 3 meters from the interference receiving antenna, which was mounted on the top of a variable height antenna tower.
5. Corrected Reading: Antenna Factor + Cable Loss + Read Level - Preamp Factor = Level
6. For measurement below 1GHz, If the emission level of the EUT measured by the peak detector is 3 dB lower than the applicable limit, the peak emission level will be reported. Otherwise, the emission measurement will be repeated using the quasi-peak detector and reported.
7. Use the following spectrum analyzer settings:
 - (1) Span shall wide enough to fully capture the emission being measured;
 - (2) Set RBW=100 kHz for $f < 1$ GHz; $VBW \geq RBW$; Sweep = auto; Detector function = peak; Trace = max hold;
 - (3) Set RBW = 1 MHz, VBW= 3MHz for $f \geq 1$ GHz for peak measurement.

For average measurement:

 - $VBW = 10$ Hz, when duty cycle is no less than 98 percent.
 - $VBW \geq 1/T$, when duty cycle is less than 98 percent where T is the minimum transmission duration over which the transmitter is on and is transmitting at its maximum power control level for the tested mode of operation.

Band	Duty Cycle(%)	T(ms)	1/T(kHz)	VBW Setting
Bluetooth 4.0 LE	60.00	0.37	2.67	3kHz

3.5.4 Test Setup

For radiated emissions below 30MHz

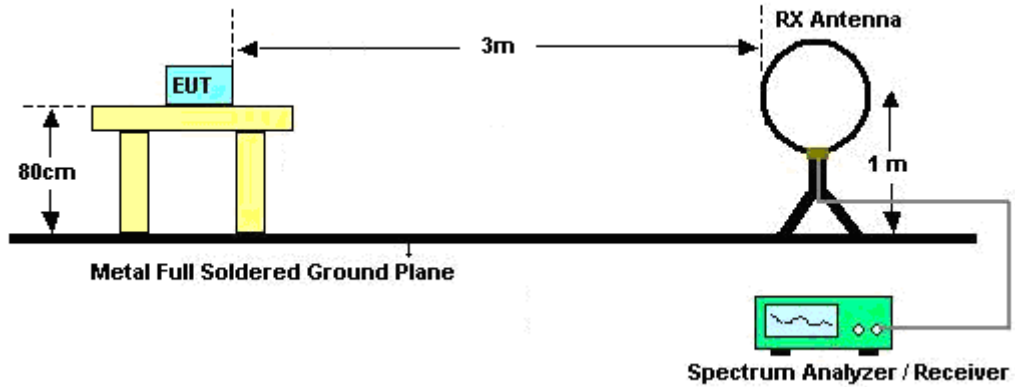

For radiated emissions from 30MHz to 1GHz

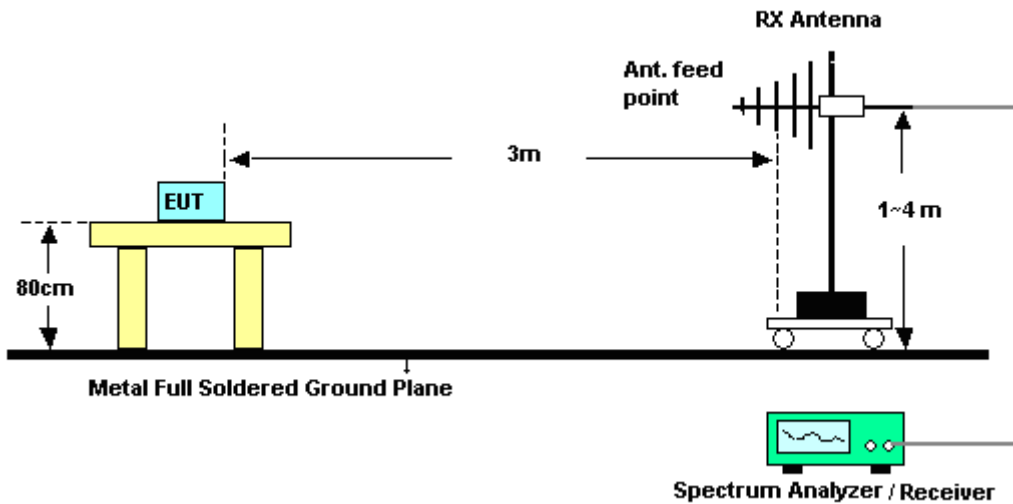

For radiated emissions above 1GHz

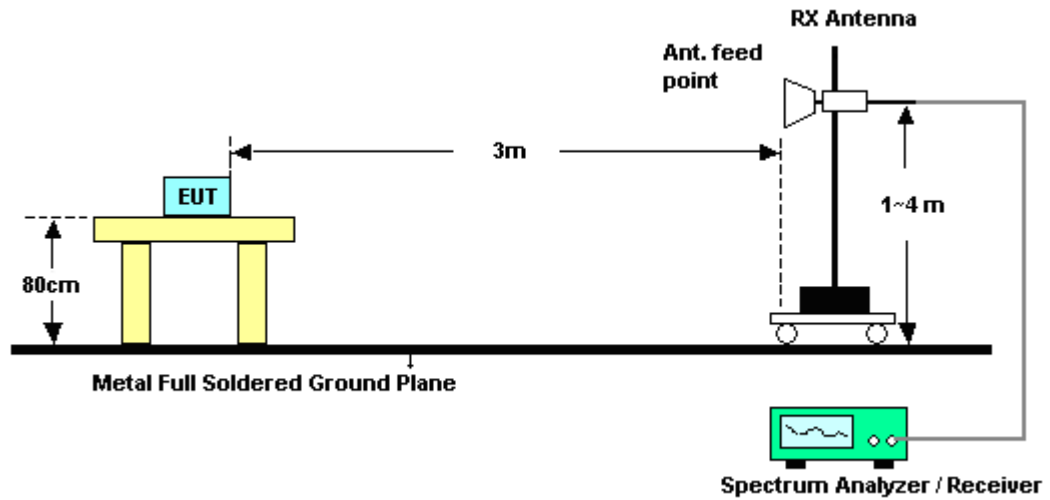

3.5.5 Test Results of Radiated Spurious Emissions (9 kHz ~ 30 MHz)

The low frequency, which started from 9 kHz to 30MHz, was pre-scanned and the result which was 20dB lower than the limit line per 15.31(o) was not reported.



3.5.6 Test Result of Radiated Spurious at Band Edges

Test Mode :	Mode 1	Temperature :	22~23°C
Test Channel :	00	Relative Humidity :	42~43%
		Test Engineer :	Star Wei

ANTENNA POLARITY : HORIZONTAL										
Frequency (MHz)	Level (dBμV /m)	Over Limit (dB)	Limit Line (dBμV /m)	Read Level (dBμV)	Antenna Factor (dB)	Cable Loss (dB)	Preamp Factor (dB)	Ant Pos (cm)	Table Pos (deg)	Remark
2389.11	49.57	-24.43	74	51.65	31.96	2.64	36.68	143	303	Peak
2389.38	37.29	-16.71	54	39.37	31.96	2.64	36.68	143	303	Average

ANTENNA POLARITY : VERTICAL										
Frequency (MHz)	Level (dBμV /m)	Over Limit (dB)	Limit Line (dBμV /m)	Read Level (dBμV)	Antenna Factor (dB)	Cable Loss (dB)	Preamp Factor (dB)	Ant Pos (cm)	Table Pos (deg)	Remark
2358.96	49.3	-24.7	74	51.46	31.91	2.62	36.69	100	239	Peak
2389.92	37.29	-16.71	54	39.37	31.96	2.64	36.68	100	239	Average

Test Mode :	Mode 3	Temperature :	22~23°C
Test Channel :	39	Relative Humidity :	42~43%
		Test Engineer :	Star Wei

ANTENNA POLARITY : HORIZONTAL										
Frequency (MHz)	Level (dBμV /m)	Over Limit (dB)	Limit Line (dBμV /m)	Read Level (dBμV)	Antenna Factor (dB)	Cable Loss (dB)	Preamp Factor (dB)	Ant Pos (cm)	Table Pos (deg)	Remark
2483.5	58.77	-15.23	74	60.66	32.08	2.68	36.65	169	308	Peak
2483.5	40.16	-13.84	54	42.05	32.08	2.68	36.65	109	308	Average

ANTENNA POLARITY : VERTICAL										
Frequency (MHz)	Level (dBμV /m)	Over Limit (dB)	Limit Line (dBμV /m)	Read Level (dBμV)	Antenna Factor (dB)	Cable Loss (dB)	Preamp Factor (dB)	Ant Pos (cm)	Table Pos (deg)	Remark
2483.5	57.13	-16.87	74	59.02	32.08	2.68	36.65	100	267	Peak
2483.5	38.36	-15.64	54	40.25	32.08	2.68	36.65	100	267	Average

Note: In order to reduce the noise floor, 6dB EMI filter is used for the radiated band edge measurement.



3.5.7 Test Result of Radiated Spurious Emission (30MHz ~ 10th Harmonic)

Note: Pre-scanned all test modes and only choose the worst case mode recorded in the test report for radiated spurious emission below 1GHz.

Test Mode :	Mode 1	Temperature :	22~23°C
Test Channel :	00	Relative Humidity :	42~43%
Test Engineer :	Star Wei	Polarization :	Horizontal
Remark :	1. 2402 MHz is fundamental signal which can be ignored. 2. Average measurement was not performed if peak level went lower than the average limit.		

Frequency (MHz)	Level (dBμV/m)	Over Limit (dB)	Limit Line (dBμV/m)	Read Level (dBμV)	Antenna Factor (dB)	Cable Loss (dB)	Preamp Factor (dB)	Ant Pos (cm)	Table Pos (deg)	Remark
2402	97.16	-	-	99.23	31.96	2.65	36.68	143	303	Peak
2402	95.91	-	-	97.98	31.96	2.65	36.68	143	303	Average
4804	50.09	-23.91	74	47.48	34.09	3.78	35.26	100	74	Peak

Note: Other harmonics are lower than background noise.

Test Mode :	Mode 1	Temperature :	22~23°C
Test Channel :	00	Relative Humidity :	42~43%
Test Engineer :	Star Wei	Polarization :	Vertical
Remark :	1. 2402 MHz is fundamental signal which can be ignored. 2. Average measurement was not performed if peak level went lower than the average limit.		

Frequency (MHz)	Level (dBμV/m)	Over Limit (dB)	Limit Line (dBμV/m)	Read Level (dBμV)	Antenna Factor (dB)	Cable Loss (dB)	Preamp Factor (dB)	Ant Pos (cm)	Table Pos (deg)	Remark
2402	98.07	-	-	100.14	31.96	2.65	36.68	100	239	Peak
2402	97.25	-	-	99.32	31.96	2.65	36.68	100	239	Average
4804	50.03	-23.97	74	47.42	34.09	3.78	35.26	100	199	Peak

Note: Other harmonics are lower than background noise.



Test Mode :	Mode 2	Temperature :	22~23°C
Test Channel :	19	Relative Humidity :	42~43%
Test Engineer :	Star Wei	Polarization :	Horizontal
Remark :	1. 2440 MHz is fundamental signal which can be ignored. 2. Average measurement was not performed if peak level went lower than the average limit.		

Frequency (MHz)	Level (dBμV/m)	Over Limit (dB)	Limit Line (dBμV/m)	Read Level (dBμV)	Antenna Factor (dB)	Cable Loss (dB)	Preamp Factor (dB)	Ant Pos (cm)	Table Pos (deg)	Remark
2440	98.11	-	-	100.09	32.03	2.66	36.67	180	311	Peak
2440	97.17	-	-	99.15	32.03	2.66	36.67	180	311	Average
4880	50.99	-23.01	74	48.36	34.02	3.78	35.17	100	102	Peak
7320	48.18	-25.82	74	42.37	35.73	4.74	34.66	100	205	Peak

Note: Other harmonics are lower than background noise.

Test Mode :	Mode 2	Temperature :	22~23°C
Test Channel :	19	Relative Humidity :	42~43%
Test Engineer :	Star Wei	Polarization :	Vertical
Remark :	1. 2440 MHz is fundamental signal which can be ignored. 2. Average measurement was not performed if peak level went lower than the average limit.		

Frequency (MHz)	Level (dBμV/m)	Over Limit (dB)	Limit Line (dBμV/m)	Read Level (dBμV)	Antenna Factor (dB)	Cable Loss (dB)	Preamp Factor (dB)	Ant Pos (cm)	Table Pos (deg)	Remark
2440	97.56	-	-	99.54	32.03	2.66	36.67	100	259	Peak
2440	96.7	-	-	98.68	32.03	2.66	36.67	100	259	Average
4880	50.15	-23.85	74	47.52	34.02	3.78	35.17	100	194	Peak
7320	48.48	-25.52	74	42.67	35.73	4.74	34.66	100	302	Peak

Note: Other harmonics are lower than background noise.



Test Mode :	Mode 3	Temperature :	22~23°C
Test Channel :	39	Relative Humidity :	42~43%
Test Engineer :	Star Wei	Polarization :	Horizontal
Remark :	1. 2480 MHz is fundamental signal which can be ignored. 2. Average measurement was not performed if peak level went lower than the average limit.		

Frequency (MHz)	Level (dBμV/m)	Over Limit (dB)	Limit Line (dBμV/m)	Read Level (dBμV)	Antenna Factor (dB)	Cable Loss (dB)	Preamp Factor (dB)	Ant Pos (cm)	Table Pos (deg)	Remark
30	23.65	-16.35	40	38.12	18	0.19	32.66	-	-	Peak
95.96	27.44	-16.06	43.5	49.66	9.95	0.43	32.6	100	195	Peak
142.52	22.78	-20.72	43.5	43.89	10.78	0.67	32.56	-	-	Peak
298.69	22.62	-23.38	46	41.22	12.98	0.81	32.39	-	-	Peak
442.25	18.77	-27.23	46	33.39	16.32	1.2	32.14	-	-	Peak
813.76	24.87	-21.13	46	35.05	20.16	1.56	31.9	-	-	Peak
2480	96.75	-	-	98.65	32.08	2.67	36.65	169	308	Peak
2480	95.97	-	-	97.87	32.08	2.67	36.65	169	308	Average
4960	50.6	-23.4	74	47.94	33.93	3.78	35.05	100	51	Peak
7440	49.75	-24.25	74	43.89	35.78	4.8	34.72	100	192	Peak

Note: Other harmonics are lower than background noise.



Test Mode :	Mode 3	Temperature :	22~23°C
Test Channel :	39	Relative Humidity :	42~43%
Test Engineer :	Star Wei	Polarization :	Vertical
Remark :	1. 2480 MHz is fundamental signal which can be ignored. 2. Average measurement was not performed if peak level went lower than the average limit.		

Frequency (MHz)	Level (dBμV/m)	Over Limit (dB)	Limit Line (dBμV/m)	Read Level (dBμV)	Antenna Factor (dB)	Cable Loss (dB)	Preamp Factor (dB)	Ant Pos (cm)	Table Pos (deg)	Remark
30.97	34.36	-5.64	40	49.43	17.4	0.19	32.66	100	91	Peak
101.78	29.63	-13.87	43.5	50.93	10.9	0.43	32.63	-	-	Peak
155.13	27.94	-15.56	43.5	49.98	9.7	0.82	32.56	-	-	Peak
349.13	26.31	-19.69	46	43.26	14.51	0.9	32.36	-	-	Peak
667.29	23.31	-22.69	46	35	19	1.27	31.96	-	-	Peak
797.27	21.75	-24.25	46	32.27	19.82	1.54	31.88	-	-	Peak
2480	94.76	-	-	96.66	32.08	2.67	36.65	100	267	Peak
2480	93.92	-	-	95.82	32.08	2.67	36.65	100	267	Average
4960	49.48	-24.52	74	46.82	33.93	3.78	35.05	100	41	Peak
7440	49.79	-24.21	74	43.93	35.78	4.8	34.72	100	71	Peak

Note: Other harmonics are lower than background noise.



3.6 AC Conducted Emission Measurement

3.6.1 Limit of AC Conducted Emission

For equipment that is designed to be connected to the public utility (AC) power line, the radio frequency voltage that is conducted back onto the AC power line on any frequency or frequencies within the band 150 kHz to 30 MHz shall not exceed the limits in the following table.

Frequency of emission (MHz)	Conducted limit (dB μ V)	
	Quasi-peak	Average
0.15-0.5	66 to 56*	56 to 46*
0.5-5	56	46
5-30	60	50

*Decreases with the logarithm of the frequency.

3.6.2 Measuring Instruments

The section 4.0 of List of Measuring Equipment of this test report is used for test.

3.6.3 Test Procedures

1. The EUT was placed 0.4 meter from the conducting wall of the shielding room was kept at least 80 centimeters from any other grounded conducting surface.
2. Connect EUT to the power mains through a line impedance stabilization network (LISN).
3. All the support units are connecting to the other LISN.
4. The LISN provides 50 ohm coupling impedance for the measuring instrument.
5. The FCC states that a 50 ohm, 50 microhenry LISN should be used.
6. Both sides of AC line were checked for maximum conducted interference.
7. The frequency range from 150 kHz to 30 MHz was searched.
8. Set the test-receiver system to Peak Detect Function and specified bandwidth with Maximum Hold Mode.

3.6.4 Test Setup

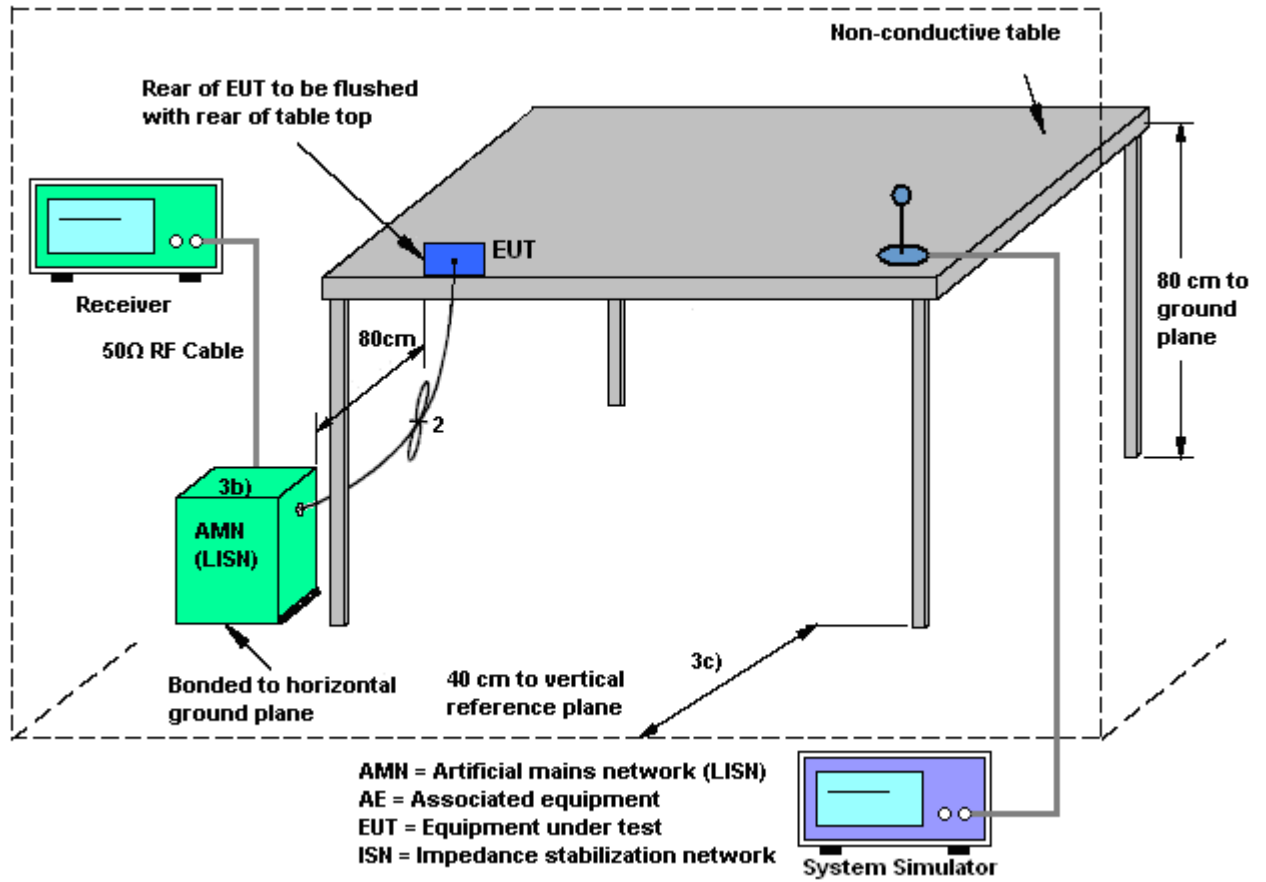



3.6.5 Test Result of AC Conducted Emission

Test Mode :	Mode 1	Temperature :	22~24°C
Test Engineer :	Eligah Wang	Relative Humidity :	37~39%
Test Voltage :	120Vac / 60Hz	Phase :	Line
Function Type :	GSM850 Idle + Bluetooth Link + WLAN Link + USB Cable (Charging from Adapter) + Earphone		

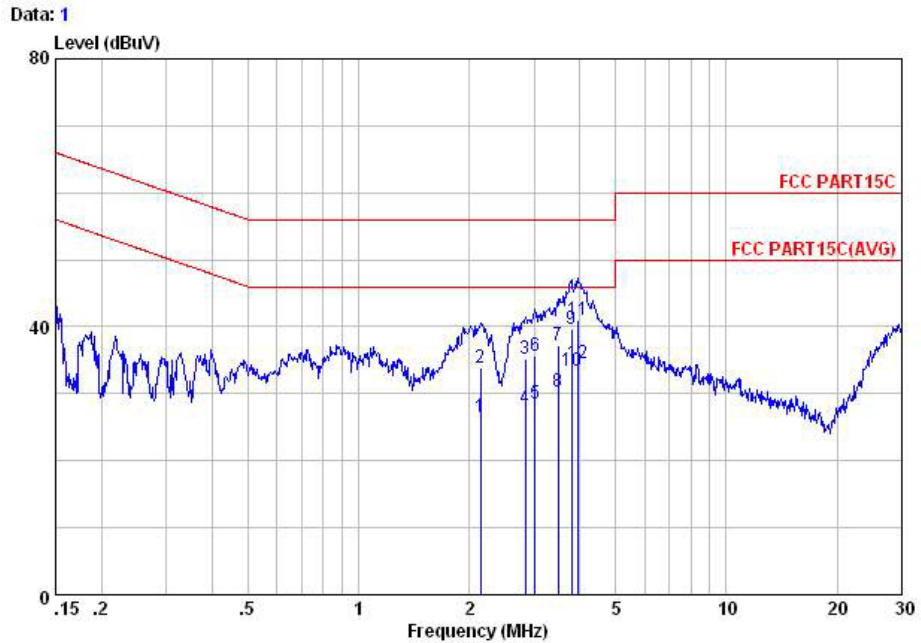

Site : C001-KS
 Condition: FCC PART15C LISN-L20130306 LINE

mode : Mode 1

	Freq	Level	Over	Limit	Read	LISN	Cable	Remark
	MHz	dBuV	Limit	Line	Level	Factor	Loss	
			dB	dBuV	dBuV	dB	dB	
1	2.14	26.60	-19.40	46.00	16.31	0.10	10.19	Average
2	2.14	33.90	-22.10	56.00	23.61	0.10	10.19	QP
3	2.84	35.14	-20.86	56.00	24.79	0.13	10.22	QP
4	2.84	27.94	-18.06	46.00	17.59	0.13	10.22	Average
5	3.03	28.46	-17.54	46.00	18.10	0.14	10.22	Average
6	3.03	35.66	-20.34	56.00	25.30	0.14	10.22	QP
7	3.49	37.30	-18.70	56.00	26.90	0.17	10.23	QP
8	3.49	30.20	-15.80	46.00	19.80	0.17	10.23	Average
9	3.80	39.72	-16.28	56.00	29.30	0.18	10.24	QP
10	3.80	33.32	-12.68	46.00	22.90	0.18	10.24	Average
11	3.94	41.02	-14.98	56.00	30.60	0.18	10.24	QP
12	3.94	34.52	-11.48	46.00	24.10	0.18	10.24	Average



Test Mode :	Mode 1	Temperature :	22~24°C
Test Engineer :	Eligah Wang	Relative Humidity :	37~39%
Test Voltage :	120Vac / 60Hz	Phase :	Neutral
Function Type :	GSM 850Idle + Bluetooth Link + WLAN Link + USB Cable (Charging from Adapter)+Earphone		

Data: 2

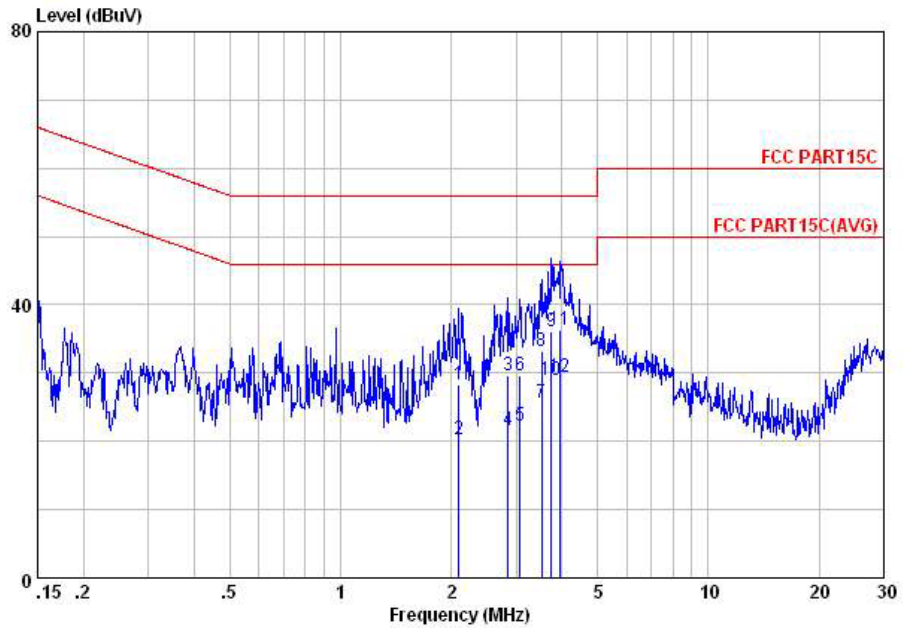

Site : C001-KS
 Condition: FCC PART15C LISN-N20130306 NEUTRAL

mode : Mode 1

	Freq	Level	Over	Limit	Read	LISN	Cable	Remark
	MHz	dBuV	Limit	Line	Level	Factor	Loss	
			dB	dBuV	dBuV	dB	dB	
1	2.10	28.19	-27.81	56.00	17.90	0.10	10.19	QP
2	2.10	20.19	-25.81	46.00	9.90	0.10	10.19	Average
3	2.85	29.65	-26.35	56.00	19.30	0.13	10.22	QP
4	2.85	21.65	-24.35	46.00	11.30	0.13	10.22	Average
5	3.07	22.27	-23.73	46.00	11.91	0.14	10.22	Average
6	3.07	29.67	-26.33	56.00	19.31	0.14	10.22	QP
7	3.53	25.70	-20.30	46.00	15.30	0.17	10.23	Average
8	3.53	33.30	-22.70	56.00	22.90	0.17	10.23	QP
9	3.74	36.01	-19.99	56.00	25.59	0.18	10.24	QP
10	3.74	29.01	-16.99	46.00	18.59	0.18	10.24	Average
11	3.96	36.32	-19.68	56.00	25.90	0.18	10.24	QP
12	3.96	29.32	-16.68	46.00	18.90	0.18	10.24	Average



3.7 Antenna Requirements

3.7.1 Standard Applicable

If directional gain of transmitting antennas is greater than 6dBi, the power shall be reduced by the same level in dB comparing to gain minus 6dBi. The use of a permanently attached antenna or of an antenna that uses a unique coupling to the intentional radiator shall be considered sufficient to comply with the FCC rule.

3.7.2 Antenna Anti-Replacement Construction

An embedded-in antenna design is used.

3.7.3 Antenna Gain

The antenna peak gain of EUT is less than 6 dBi. Therefore, it is not necessary to reduce maximum peak output power limit.



4 List of Measuring Equipment

Instrument	Manufacturer	Model No.	Serial No.	Characteristics	Calibration Date	Test Date	Due Date	Remark
Spectrum Analyzer	R&S	FSP40	100319	9kHz~40GHz	Dec. 28, 2013	Jun. 20, 2014 ~ Jul. 01, 2014	Dec. 27, 2014	Conducted (TH01-KS)
Pulse Power Sensor	Anritsu	MA2411B	0917070	30MHz~40GHz	Feb. 27, 2014	Jun. 20, 2014 ~ Jul. 01, 2014	Feb. 26, 2015	Conducted (TH01-KS)
Power Meter	Anritsu	ML2495A	1005002	50MHz Bandwidth	Feb. 27, 2014	Jun. 20, 2014 ~ Jul. 01, 2014	Feb. 26, 2015	Conducted (TH01-KS)
EMI Test Receiver	R&S	ESCI	100534	9kHz~3GHz	Nov. 05, 2013	Jul. 02, 2014	Nov. 04, 2014	Radiation (03CH01-KS)
Spectrum Analyzer	R&S	FSP30	101399	9kHz~30GHz	May 04, 2014	Jul. 02, 2014	May 03, 2015	Radiation (03CH01-KS)
Loop Antenna	R&S	HFH2-Z2	100321	9kHz~30MHz	Oct. 09, 2013	Jul. 02, 2014	Oct. 08, 2014	Radiation (03CH01-KS)
Bilog Antenna	SCHAFFNER	CBL6112D	23182	25MHz~2GHz	Jan. 08, 2014	Jul. 02, 2014	Jan. 07, 2015	Radiation (03CH01-KS)
Double Ridge Horn Antenna	ETS-Lindgren	3117	75959	1GHz~18GHz	Jan. 08, 2014	Jul. 02, 2014	Jan. 07, 2015	Radiation (03CH01-KS)
SHF-EHF Horn	Schwarzbeck	BBHA 9170	BBHA1702 49	15GHz~40GHz	Mar. 10, 2014	Jul. 02, 2014	Mar. 09, 2015	Radiation (03CH01-KS)
Amplifier	com-power	PA-103A	161073	1MHz~1GHz	May 04, 2014	Jul. 02, 2014	May 03, 2015	Radiation (03CH01-KS)
Amplifier	Agilent	8449B	3008A023 71	1GHz~26.5GHz	Dec. 10, 2013	Jul. 02, 2014	Dec. 09, 2014	Radiation (03CH01-KS)
AC Power Source	Chroma	61601	F1040900 04	N/A	NCR	Jul. 02, 2014	NCR	Radiation (03CH01-KS)
Turn Table	MF	MF7802	N/A	0~360 degree	NCR	Jul. 02, 2014	NCR	Radiation (03CH01-KS)
Antenna Mast	MF	MF7802	N/A	1 m~4 m	NCR	Jul. 02, 2014	NCR	Radiation (03CH01-KS)
EMI Receiver	R&S	ESCI7	100768	9kHz~7GHz;	May 04, 2014	Jul. 02, 2014	May 03, 2015	Conduction (CO01-KS)
AC LISN	MessTec	AN3016	060103	9kHz~30MHz	Dec. 10, 2013	Jul. 02, 2014	Dec. 09, 2014	Conduction (CO01-KS)
AC LISN (for auxiliary equipment)	MessTec	AN3016	060105	9kHz~30MHz	Dec. 10, 2013	Jul. 02, 2014	Dec. 09, 2014	Conduction (CO01-KS)
AC Power Source	Chroma	61602	ABP00000 0811	AC 0V~300V, 45Hz~1000Hz	Nov. 12, 2013	Jul. 02, 2014	Nov. 11, 2014	Conduction (CO01-KS)



5 Uncertainty of Evaluation

Uncertainty of Conducted Emission Measurement (150 kHz ~ 30 MHz)

Measuring Uncertainty for a Level of Confidence of 95% ($U = 2Uc(y)$)	2.3
---	-----

Uncertainty of Radiated Emission Measurement (30 MHz ~ 1000 MHz)

Measuring Uncertainty for a Level of Confidence of 95% ($U = 2Uc(y)$)	2.5
---	-----