



FCC RF Test Report

APPLICANT : Acer Incorporated
EQUIPMENT : Smart HandHeld
BRAND NAME : Acer
MODEL NAME : Z200, Z205
MARKETING NAME : Liquid Z200, Liquid Z205
FCC ID : HLZDMZ200
STANDARD : FCC Part 15 Subpart C §15.247
CLASSIFICATION : (DTS) Digital Transmission System

The product was received on Jun. 11, 2014 and testing was completed on Jul. 02, 2014. We, SPORTON INTERNATIONAL (KUNSHAN) INC., would like to declare that the tested sample has been evaluated in accordance with the test procedures and has been in compliance with the applicable technical standards.

The test results in this report apply exclusively to the tested model / sample. Without written approval of SPORTON INTERNATIONAL (KUNSHAN) INC., the test report shall not be reproduced except in full.

Reviewed by: Joseph Lin / Supervisor

Approved by: Jones Tsai / Manager



SPORTON INTERNATIONAL (KUNSHAN) INC.
No. 3-2, PingXiang Road, Kunshan, Jiangsu Province, P.R.C.



TABLE OF CONTENTS

REVISION HISTORY..... 3

SUMMARY OF TEST RESULT 4

1 GENERAL DESCRIPTION 5

 1.1 Applicant 5

 1.2 Manufacturer 5

 1.3 Product Feature of Equipment Under Test 5

 1.4 Product Specification subjective to this standard 5

 1.5 Modification of EUT 6

 1.6 Testing Location 6

 1.7 Applicable Standards 6

2 TEST CONFIGURATION OF EQUIPMENT UNDER TEST 7

 2.1 Carrier Frequency Channel 7

 2.2 Pre-Scanned RF Power 8

 2.3 Test Mode 9

 2.4 Connection Diagram of Test System 10

 2.5 Support Unit used in test configuration and system 11

 2.6 EUT Operation Test Setup 11

 2.7 Measurement Results Explanation Example 11

3 TEST RESULT 12

 3.1 6dB and 99% Bandwidth Measurement 12

 3.2 Output Power Measurement 14

 3.3 Power Spectral Density Measurement 17

 3.4 Conducted Band Edges and Spurious Emission Measurement 19

 3.5 Radiated Band Edges and Spurious Emission Measurement 32

 3.6 AC Conducted Emission Measurement 54

 3.7 Antenna Requirements 58

4 LIST OF MEASURING EQUIPMENT 59

5 UNCERTAINTY OF EVALUATION 60

APPENDIX A. SETUP PHOTOGRAPHS



REVISION HISTORY

REPORT NO.	VERSION	DESCRIPTION	ISSUED DATE
FR461192C	Rev. 01	Initial issue of report	Jul. 21, 2014

**SUMMARY OF TEST RESULT**

Report Section	FCC Rule	IC Rule	Description	Limit	Result	Remark
3.1	15.247(a)(2)	RSS-210 A8.2(a)	6dB Bandwidth	$\geq 0.5\text{MHz}$	Pass	-
3.1	-	RSS-Gen 4.6.1	99% Bandwidth	-	Pass	-
3.2	15.247(b)	RSS-210 A8.4	Power Output Measurement	$\leq 30\text{dBm}$	Pass	-
3.3	15.247(e)	RSS-210 A8.2(b)	Power Spectral Density	$\leq 8\text{dBm}/3\text{kHz}$	Pass	-
3.4	15.247(d)	RSS-210 A8.5	Conducted Band Edges	$\leq 20\text{dBc}$	Pass	-
			Conducted Spurious Emission		Pass	-
3.5	15.247(d)	RSS-210 A8.5	Radiated Band Edges and Radiated Spurious Emission	15.209(a) & 15.247(d)	Pass	Under limit 3.60 dB at 2388.750 MHz
3.6	15.207	RSS-Gen 7.2.4	AC Conducted Emission	15.207(a)	Pass	Under limit 11.48 dB at 3.940 MHz
3.7	15.203 & 15.247(b)	RSS-210 A8.4	Antenna Requirement	N/A	Pass	-

1 General Description

1.1 Applicant

Acer Incorporated

8F., No. 88, Sec. 1, Xintai 5th Rd., Xizhi Dist., New Taipei City 22181, Taiwan (R.O.C)

1.2 Manufacturer

Shanghai Wingtech Electronic Technology Co., Ltd.

6th Floor, G Block, No. 668, East Beijing Road, HuangPu District, Shanghai, P.R.China

1.3 Product Feature of Equipment Under Test

Product Feature	
Equipment	Smart HandHeld
Brand Name	Acer
Model Name	Z200, Z205
Marketing Name	Liquid Z200, Liquid Z205
FCC ID	HLZDMZ200
EUT supports Radios application	GSM/GPRS/EGPRS/WCDMA/HSPA/HSPA+(Downlink Only) WLAN2.4GHz 802.11b/g/n HT20/HT40 Bluetooth v3.0+EDR Bluetooth v4.0 LE
EUT Stage	Identical Prototype

Remark:

1. The above EUT's information was declared by manufacturer. Please refer to the specifications or user's manual for more detailed description.
2. The difference between model name Z200 and Z205 is only for the designation of appearance which does not affect any test items, so we only choose the sample 1 Z200 for all tests.

1.4 Product Specification subjective to this standard

Product Specification subjective to this standard	
Tx/Rx Channel Frequency Range	802.11b/g/n : 2412 MHz ~ 2462 MHz
Maximum (Peak) Output Power to Antenna	802.11b : 16.17 dBm (0.0414 W) 802.11g : 19.81 dBm (0.0957 W) 802.11n HT20 : 19.31 dBm (0.0853 W) 802.11n HT40 : 19.02 dBm (0.0798 W)
99% Occupied Bandwidth	802.11b : 12.39MHz 802.11g : 17.78MHz 802.11n HT20 : 18.43MHz 802.11n HT40 : 36.46MHz
Antenna Type	802.11b/g/n : PIFA Antenna with gain 1.24 dBi
Type of Modulation	802.11b : DSSS (DBPSK / DQPSK / CCK) 802.11g/n : OFDM (BPSK / QPSK / 16QAM / 64QAM)



1.5 Modification of EUT

No modifications are made to the EUT during all test items.

1.6 Testing Location

Test Site	SPORTON INTERNATIONAL (KUNSHAN) INC.			
Test Site Location	No. 3-2, PingXiang Road, Kunshan, Jiangsu Province, P.R.C. TEL: +86-0512-5790-0158 FAX: +86-0512-5790-0958			
Test Site No.	Sporton Site No.			FCC/IC Registration No.
	TH01-KS	CO01-KS	03CH01-KS	149928/4086E-1

1.7 Applicable Standards

According to the specifications of the manufacturer, the EUT must comply with the requirements of the following standards:

- FCC Part 15 Subpart C §15.247
- FCC KDB Publication No. 558074 D01 DTS Meas. Guidance v03r02
- ANSI C63.4-2003
- IC RSS-210 Issue 8
- IC RSS-Gen Issue 3
- NOTICE 2012-DRS0126

Remark:

1. All test items were verified and recorded according to the standards and without any deviation during the test.
2. This EUT has also been tested and complied with the requirements of FCC Part 15, Subpart B, recorded in a separate test report.
3. Per the section 2.2.3 of Notice of 2012-DRS0126, “ Receivers Excluded from Industry Canada Requirements”, only radiocommunication receivers operating in stand-alone mode within the band 30-960 MHz and scanner receivers are subject to Industry Canada requirements.



2 Test Configuration of Equipment Under Test

The EUT has been associated with peripherals and configuration operated in a manner tended to maximize its emission characteristics in a typical application. Frequency range investigated: conducted emission (150 kHz to 30 MHz) and radiated emission (9 kHz to the 10th harmonic of the highest fundamental frequency or to 40 GHz, whichever is lower). For radiated measurement, pre-scanned in three orthogonal panels, X, Y, Z. The worst cases (Z plane) were recorded in this report.

The final configuration from all the combinations and the worst-case data rates were investigated by measuring the maximum power across all the data rates and modulation modes under section 2.2.

Based on the worst configuration found above, the RF power setting is set individually to meet FCC compliance limit for the final conducted and radiated tests shown in section 2.3.

2.1 Carrier Frequency Channel

Frequency Band	Channel	Freq. (MHz)	Channel	Freq. (MHz)
2400-2483.5 MHz	1	2412	7	2442
	2	2417	8	2447
	3	2422	9	2452
	4	2427	10	2457
	5	2432	11	2462
	6	2437	-	-



2.2 Pre-Scanned RF Power

Preliminary tests were performed in different data rate and data rate associated with the highest power were chosen for full test shown in the following tables.

2.4GHz 802.11b RF Output Power (dBm)						
Power vs. Channel			Power vs. Data Rate			
Channel	Frequency (MHz)	Data Rate 1Mbps	Channel	2Mbps	5.5Mbps	11Mbps
CH 01	2412 MHz	16.17	CH 01	15.68	15.92	15.74
CH 06	2437 MHz	15.84				
CH 11	2462 MHz	16.16				

2.4GHz 802.11g RF Output Power (dBm)										
Power vs. Channel			Power vs. Data Rate							
Channel	Frequency (MHz)	Data Rate 6Mbps	Channel	9Mbps	12Mbps	18Mbps	24Mbps	36Mbps	48Mbps	54Mbps
CH 01	2412 MHz	19.58	CH 11	19.52	19.36	19.67	19.54	19.15	19.43	19.53
CH 06	2437 MHz	19.06								
CH 11	2462 MHz	19.81								

2.4GHz 802.11n HT20 RF Output Power (dBm)										
Power vs. Channel			Power vs. MCS Index							
Channel	Frequency (MHz)	MCS Index MCS0	Channel	MCS1	MCS2	MCS3	MCS4	MCS5	MCS6	MCS7
CH 01	2412 MHz	19.03	CH 11	19.18	18.65	18.85	18.59	18.92	18.68	18.86
CH 06	2437 MHz	19.26								
CH 11	2462 MHz	19.31								

2.4GHz 802.11n HT40 RF Output Power (dBm)										
Power vs. Channel			Power vs. MCS Index							
Channel	Frequency (MHz)	MCS Index MCS0	Channel	MCS1	MCS2	MCS3	MCS4	MCS5	MCS6	MCS7
CH 03	2422 MHz	19.02	CH 03	17.35	17.17	17.41	16.66	16.81	16.61	17.22
CH 06	2437 MHz	18.97								
CH 09	2452 MHz	18.89								



2.3 Test Mode

Final results of test modes, data rates and test channels are shown as following table.

Test Cases				
	Test Items	Mode	Data Rate	Test Channel
Conducted TCs	6dB and 99% BW Power Spectral Density	802.11b	1 Mbps	1/6/11
		802.11g	6 Mbps	1/6/11
		802.11n HT20	MCS0	1/6/11
		802.11n HT40	MCS0	3/6/9
	Output Power	802.11b	1 Mbps	1/6/11
		802.11g	6 Mbps	1/6/11
		802.11n HT20	MCS0	1/6/11
		802.11n HT40	MCS0	3/6/9
	Conducted Band Edge	802.11b	1 Mbps	1/11
		802.11g	6 Mbps	1/11
		802.11n HT20	MCS0	1/11
		802.11n HT40	MCS0	3/9
	Conducted Spurious Emission	802.11b	1 Mbps	1/6/11
		802.11g	6 Mbps	1/6/11
		802.11n HT20	MCS0	1/6/11
		802.11n HT40	MCS0	3/6/9
Radiated TCs	Radiated Band Edge	802.11b	1 Mbps	1/11
		802.11g	6 Mbps	1/11
		802.11n HT20	MCS0	1/11
		802.11n HT40	MCS0	3/9
	Radiated Spurious Emission	802.11b	1 Mbps	1/6/11
		802.11g	6 Mbps	1/6/11
		802.11n HT20	MCS0	1/6/11
		802.11n HT40	MCS0	3/6/9
AC Conducted Emission	Mode 1 : GSM850 Idle + Bluetooth Link + WLAN Link + USB Cable (Charging from Adapter) + Earphone			

2.4 Connection Diagram of Test System

<WLAN Tx Mode>

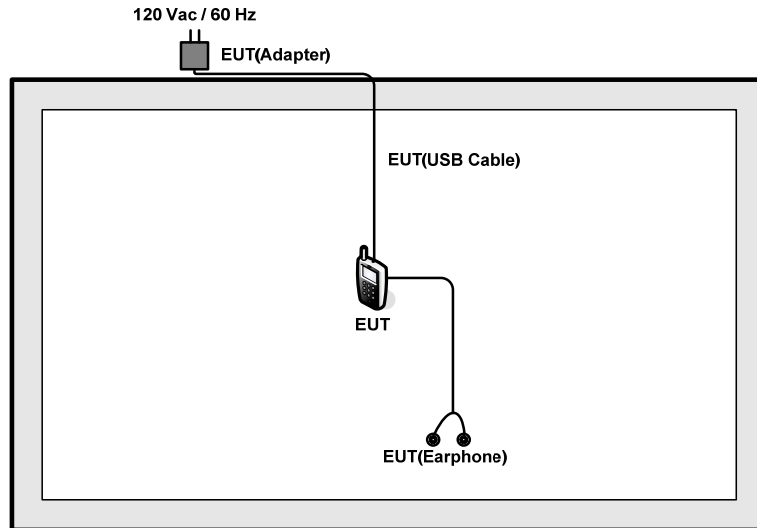

<AC Conducted Emission Mode>

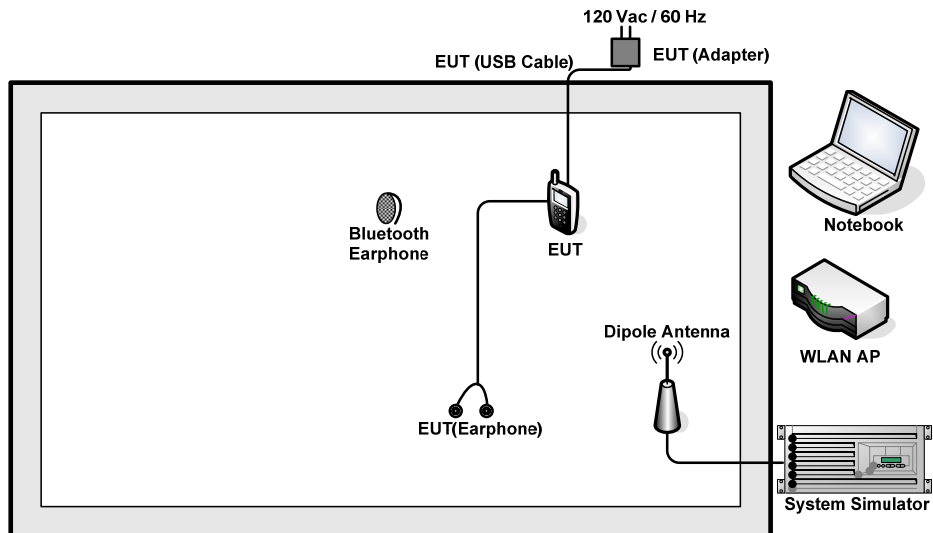

2.5 Support Unit used in test configuration and system

Item	Equipment	Trade Name	Model Name	FCC ID	Data Cable	Power Cord
1.	System Simulator	R&S	CMU 200	N/A	N/A	Unshielded, 1.8 m
2.	WLAN AP	D-Link	DIR-855	KA2DIR855A2	N/A	Unshielded, 1.8 m
3.	Notebook	Lenovo	G480	PRC4	N/A	AC I/P: Unshielded, 1.8 m DC O/P: Shielded, 1.8 m
4.	Bluetooth Earphone	Nokia	BH-102	PYAHS-107W	N/A	N/A

2.6 EUT Operation Test Setup

For WLAN function, the engineering test program was provided and enabled to make EUT continuous transmit/receive.

For AC power line conducted emissions, the EUT was set to connect with the WLAN AP under large package sizes transmission.

2.7 Measurement Results Explanation Example

For all conducted test items:

The offset level is set in the spectrum analyzer to compensate the RF cable loss and attenuator factor between EUT conducted output port and spectrum analyzer. With the offset compensation, the spectrum analyzer reading level is exactly the EUT RF output level.

Example :

The spectrum analyzer offset is derived from RF cable loss and attenuator factor.

Offset = RF cable loss + attenuator factor.

Following shows an offset computation example with cable loss 6 dB and 10dB attenuator.

$$\begin{aligned}
 \text{Offset(dB)} &= \text{RF cable loss(dB)} + \text{attenuator factor(dB)}. \\
 &= 6 + 10 = 16 \text{ (dB)}
 \end{aligned}$$

3 Test Result

3.1 6dB and 99% Bandwidth Measurement

3.1.1 Limit of 6dB and 99% Bandwidth

The minimum 6 dB bandwidth shall be at least 500 kHz.

3.1.2 Measuring Instruments

The measuring equipment is listed in the section 4 of this test report.

3.1.3 Test Procedures

1. The testing follows FCC KDB Publication No. 558074 DTS D01 Meas. Guidance v03r02.
2. The RF output of EUT was connected to the spectrum analyzer by RF cable and attenuator. The path loss was compensated to the results for each measurement.
3. Set to the maximum power setting and enable the EUT transmit continuously.
4. Make the measurement with the spectrum analyzer's resolution bandwidth (RBW) = 100 kHz. Set the Video bandwidth (VBW) = 300 kHz. In order to make an accurate measurement. The 6 dB bandwidth must be greater than 500 kHz.
5. For 99% Bandwidth Measurement, the spectrum analyzer's resolution bandwidth (RBW) = 1MHz and set the Video bandwidth (VBW) = 3MHz.
6. Measure and record the results in the test report.

3.1.4 Test Setup

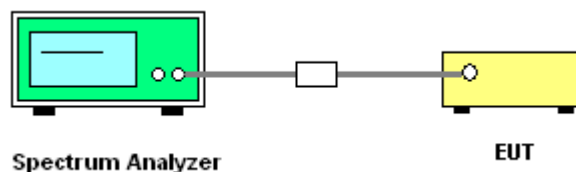



3.1.5 Test Result of 6dB and 99% Occupied Bandwidth

Test Band :	2.4GHz	Temperature :	23~24°C
Test Engineer :	Adonis Li	Relative Humidity :	47~48%

Mod.	Data Rate	N _{TX}	Channel	Freq. (MHz)	99% Bandwidth (MHz)	6dB Bandwidth (MHz)	6dB Bandwidth Min. Limit (MHz)	Pass/Fail
11b	1Mbps	1	1	2412	12.39	9.55	0.5	Pass
11b	1Mbps	1	6	2437	12.39	9.07	0.5	Pass
11b	1Mbps	1	11	2462	12.39	9.53	0.5	Pass
11g	6Mbps	1	1	2412	17.78	16.42	0.5	Pass
11g	6Mbps	1	6	2437	17.68	16.34	0.5	Pass
11g	6Mbps	1	11	2462	17.73	16.34	0.5	Pass
HT20	MCS0	1	1	2412	18.33	17.58	0.5	Pass
HT20	MCS0	1	6	2437	18.43	17.58	0.5	Pass
HT20	MCS0	1	11	2462	18.38	17.58	0.5	Pass
HT40	MCS0	1	3	2422	36.46	36.28	0.5	Pass
HT40	MCS0	1	6	2437	36.46	36.04	0.5	Pass
HT40	MCS0	1	9	2452	36.46	36.04	0.5	Pass

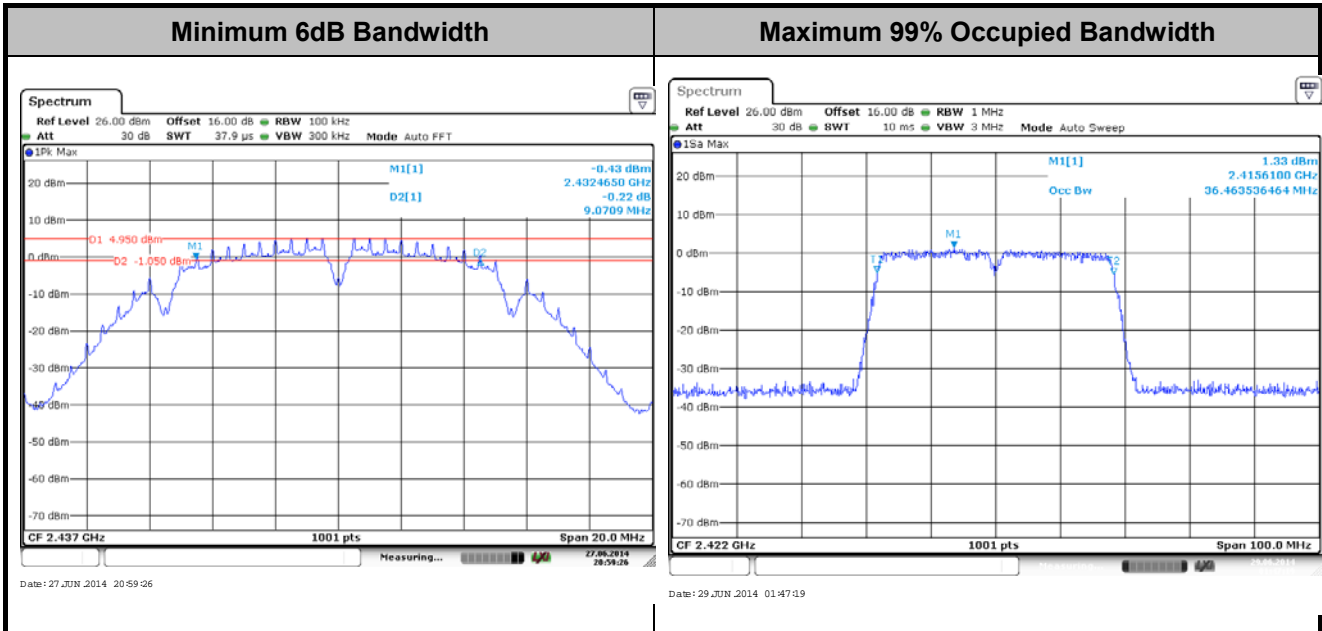

Note : The occupied channel bandwidth is maintained within the band of operation for all of the modulations.

3.2 Output Power Measurement

3.2.1 Limit of Output Power

For systems using digital modulation in the 2400-2483.5MHz, the limit for peak output power is 30dBm. If transmitting Antenna of directional gain greater than 6dBi are used the peak output power from the intentional radiator shall be reduced below the above stated value by the amount in dB that the directional gain of the Antenna exceeds 6 dBi. In case of point-to-point operation, the limit has to be reduced by 1dB for every 3dB that the directional gain of the Antenna exceeds 6dBi.

3.2.2 Measuring Instruments

The measuring equipment is listed in the section 4 of this test report.

3.2.3 Test Procedures

1. The testing follows the Measurement Procedure of FCC KDB No. 558074 DTS D01 Meas. Guidance v03r02.
2. The RF output of EUT was connected to the power meter by RF cable and attenuator. The path loss was compensated to the results for each measurement.
3. Set to the maximum power setting and enable the EUT transmit continuously.
4. Measure the conducted output power and record the results in the test report.

3.2.4 Test Setup

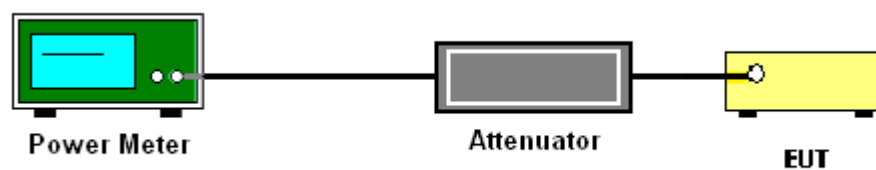



3.2.5 Test Result of Peak Output Power

Test Mode :	2.4GHz	Temperature :	23~24°C
Test Engineer :	Adonis Li	Relative Humidity :	47~48%

Mod.	Data Rate	N _{TX}	Channel	Freq. (MHz)	RF Output Power (dBm)	Power Limit (dBm)	DG (dBi)	Pass/Fail
11b	1Mbps	1	1	2412	16.17	30	1.24	Pass
11b	1Mbps	1	6	2437	15.84	30	1.24	Pass
11b	1Mbps	1	11	2462	16.16	30	1.24	Pass
11g	6Mbps	1	1	2412	19.58	30	1.24	Pass
11g	6Mbps	1	6	2437	19.06	30	1.24	Pass
11g	6Mbps	1	11	2462	19.81	30	1.24	Pass
HT20	MCS0	1	1	2412	19.03	30	1.24	Pass
HT20	MCS0	1	6	2437	19.26	30	1.24	Pass
HT20	MCS0	1	11	2462	19.31	30	1.24	Pass
HT40	MCS0	1	3	2422	19.02	30	1.24	Pass
HT40	MCS0	1	6	2437	18.97	30	1.24	Pass
HT40	MCS0	1	9	2452	18.89	30	1.24	Pass

Note: Measured power (dBm) has offset with cable loss.



3.2.6 Test Result of Average output Power (Reporting Only)

Test Mode :	2.4GHz	Temperature :	23~24°C
Test Engineer :	Adonis Li	Relative Humidity :	47~48%

Mod.	Data Rate	N _{TX}	Channel	Freq. (MHz)	Duty Factor (dB)	Average Output Power (dBm)	Power Limit (dBm)	DG (dBi)	Pass/Fail
11b	1Mbps	1	1	2412	0.09	12.95	30	1.24	Pass
11b	1Mbps	1	6	2437	0.09	12.78	30	1.24	Pass
11b	1Mbps	1	11	2462	0.09	12.86	30	1.24	Pass
11g	6Mbps	1	1	2412	0.51	8.84	30	1.24	Pass
11g	6Mbps	1	6	2437	0.51	9.38	30	1.24	Pass
11g	6Mbps	1	11	2462	0.51	9.69	30	1.24	Pass
HT20	MCS0	1	1	2412	0.51	8.45	30	1.24	Pass
HT20	MCS0	1	6	2437	0.51	8.65	30	1.24	Pass
HT20	MCS0	1	11	2462	0.51	8.89	30	1.24	Pass
HT40	MCS0	1	3	2422	1.02	7.40	30	1.24	Pass
HT40	MCS0	1	6	2437	1.02	7.31	30	1.24	Pass
HT40	MCS0	1	9	2452	1.02	7.17	30	1.24	Pass

Note: Measured power (dBm) has offset with cable loss and duty factor.

3.3 Power Spectral Density Measurement

3.3.1 Limit of Power Spectral Density

The peak power spectral density shall not be greater than 8dBm in any 3kHz band at any time interval of continuous transmission.

3.3.2 Measuring Instruments

The measuring equipment is listed in the section 4 of this test report.

3.3.3 Test Procedures

1. The testing follows Measurement Procedure 10.2 Method PKPSD of FCC KDB Publication No. 558074 D01 DTS Meas. Guidance v03r02
2. The RF output of EUT was connected to the spectrum analyzer by RF cable and attenuator. The path loss was compensated to the results for each measurement.
3. Set to the maximum power setting and enable the EUT transmit continuously.
4. Make the measurement with the spectrum analyzer's resolution bandwidth (RBW) = 3 kHz. Video bandwidth VBW = 10 kHz In order to make an accurate measurement, set the span to 1.5 times DTS Channel Bandwidth. (6dB BW)
5. Detector = peak, Sweep time = auto couple, Trace mode = max hold, Allow trace to fully stabilize. Use the peak marker function to determine the maximum power level.
6. Measure and record the results in the test report.

3.3.4 Test Setup

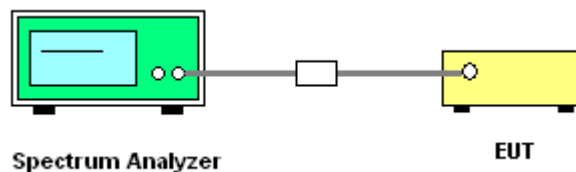



3.3.5 Test Result of Power Spectral Density

Test Mode :	2.4GHz	Temperature :	23~24°C
Test Engineer :	Adonis Li	Relative Humidity :	47~48%

Mod.	Data Rate	N _{TX}	Channel	Freq. (MHz)	Peak Power Density (dBm/3kHz)	Max. Limits (dBm/3kHz)	DG (dBi)	Pass/Fail
11b	1Mbps	1	1	2412	4.63	8	1.24	Pass
11b	1Mbps	1	6	2437	3.49	8	1.24	Pass
11b	1Mbps	1	11	2462	5.02	8	1.24	Pass
11g	6Mbps	1	1	2412	-13.79	8	1.24	Pass
11g	6Mbps	1	6	2437	-14.37	8	1.24	Pass
11g	6Mbps	1	11	2462	-13.18	8	1.24	Pass
HT20	MCS0	1	1	2412	-14.36	8	1.24	Pass
HT20	MCS0	1	6	2437	-15.41	8	1.24	Pass
HT20	MCS0	1	11	2462	-15.10	8	1.24	Pass
HT40	MCS0	1	3	2422	-18.52	8	1.24	Pass
HT40	MCS0	1	6	2437	-19.78	8	1.24	Pass
HT40	MCS0	1	9	2452	-19.87	8	1.24	Pass

Note: Measured power density (dBm) has offset with cable loss.

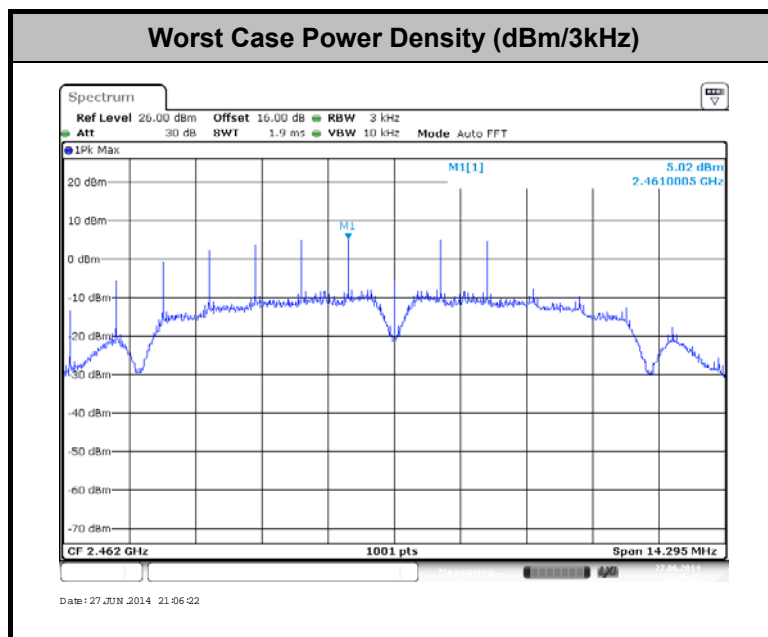

3.4 Conducted Band Edges and Spurious Emission Measurement

3.4.1 Limit of Conducted Band Edges and Spurious Emission Measurement

In any 100 kHz bandwidth outside of the authorized frequency band, the emissions which fall in the non-restricted bands shall be attenuated at least 20 dB / 30dB relative to the maximum PSD level in 100 kHz by RF conducted measurement and radiated emissions which fall in the restricted bands, as defined in Section 15.205(a), must also comply with the radiated emission limits specified in Section 15.209(a).

3.4.2 Measuring Instruments

The measuring equipment is listed in the section 4 of this test report.

3.4.3 Test Procedures

1. The testing follows FCC KDB Publication No. 558074 D01 DTS Meas. Guidance v03r02.
2. The RF output of EUT was connected to the spectrum analyzer by RF cable and attenuator. The path loss was compensated to the results for each measurement.
3. Set to the maximum power setting and enable the EUT transmit continuously.
4. Set RBW = 100 kHz, VBW=300 kHz, Peak Detector. Unwanted Emissions measured in any 100 kHz bandwidth outside of the authorized frequency band shall be attenuated by at least 20 dB relative to the maximum in-band peak PSD level in 100 kHz when maximum peak conducted output power procedure is used. If the transmitter complies with the conducted power limits based on the use of RMS averaging over a time interval, the attenuation required under this paragraph shall be 30 dB instead of 20 dB per 15.247(d).
5. Measure and record the results in the test report.
6. The RF fundamental frequency should be excluded against the limit line in the operating frequency band.

3.4.4 Test Setup

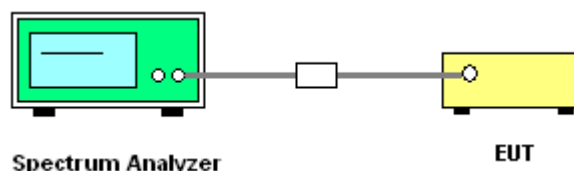



3.4.5 Test Result of Conducted Band Edges and Spurious Emission

Test Mode :	802.11b	Temperature :	23~24°C
Test Band :	2.4GHz Low	Relative Humidity :	47~48%
Test Channel :	01	Test Engineer :	Adonis Li

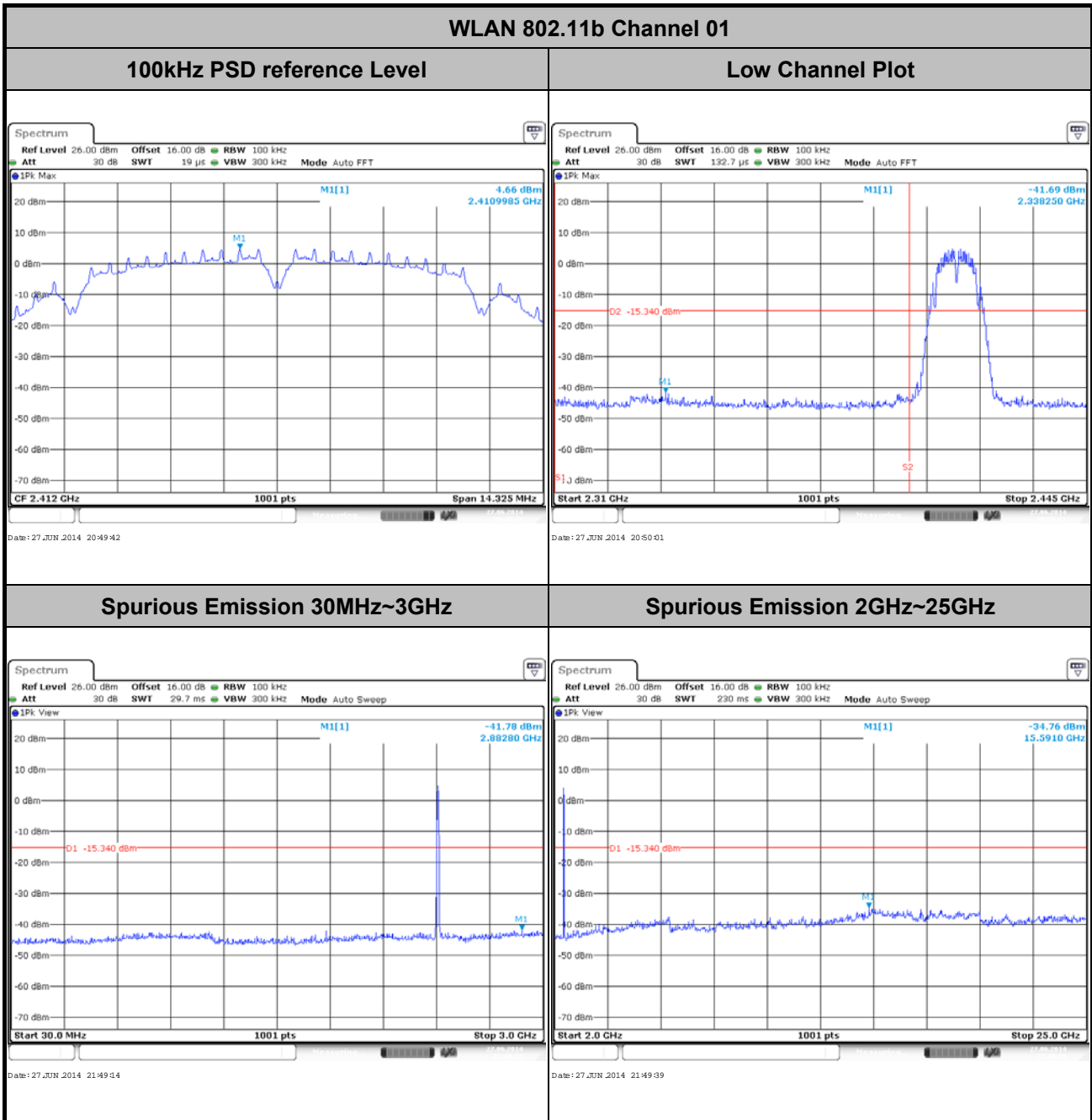



Test Mode :	802.11b	Temperature :	23~24°C
Test Band :	2.4GHz Mid	Relative Humidity :	47~48%
Test Channel :	06	Test Engineer :	Adonis Li

WLAN 802.11b Channel 06

100kHz PSD reference Level

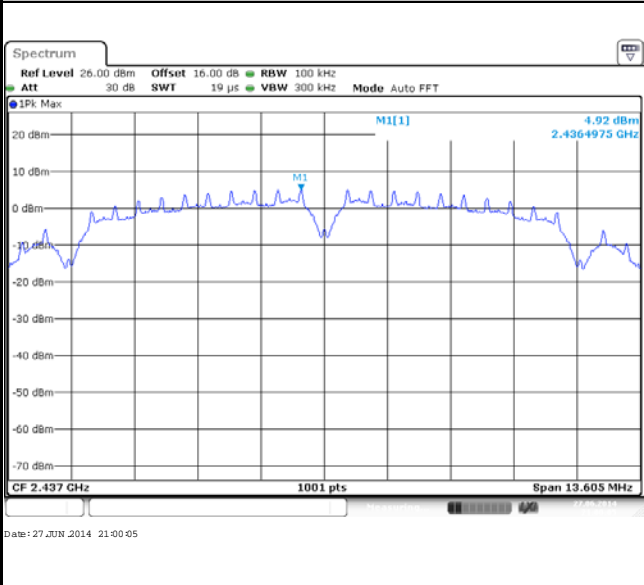

Spurious Emission 30MHz~3GHz

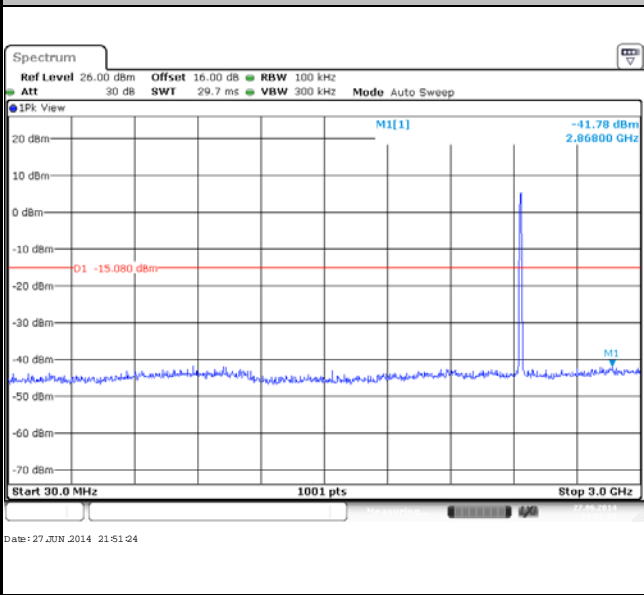

Spurious Emission 2GHz~25GHz

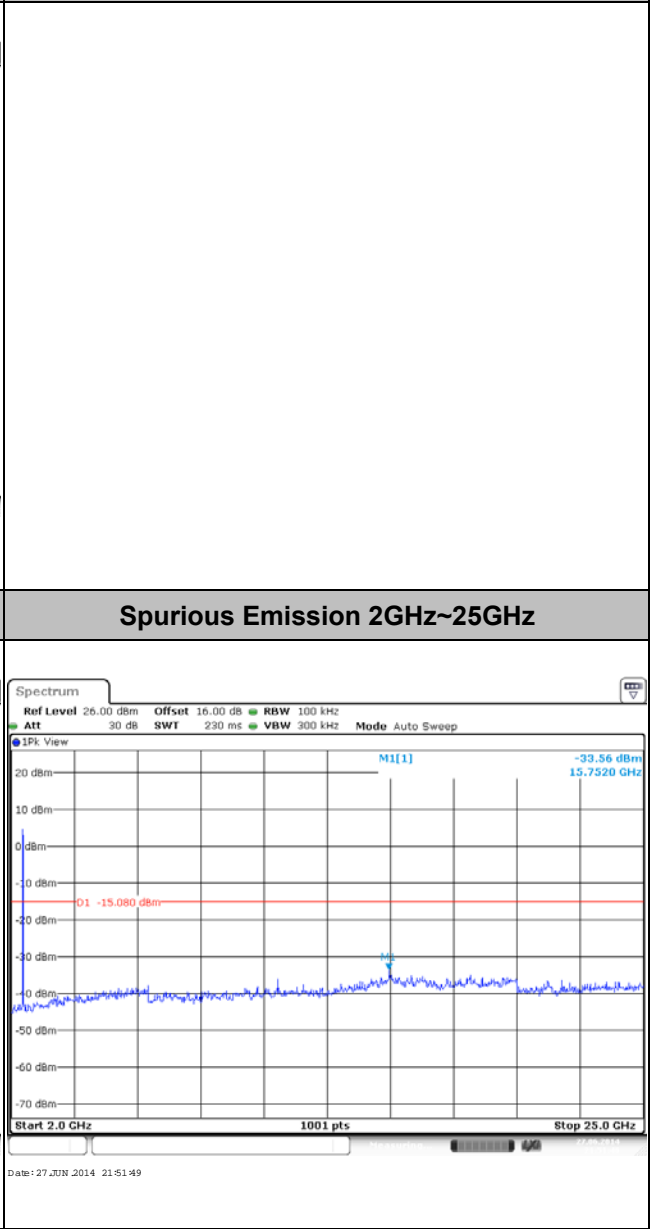



Test Mode :	802.11b	Temperature :	23~24°C
Test Band :	2.4GHz High	Relative Humidity :	47~48%
Test Channel :	11	Test Engineer :	Adonis Li

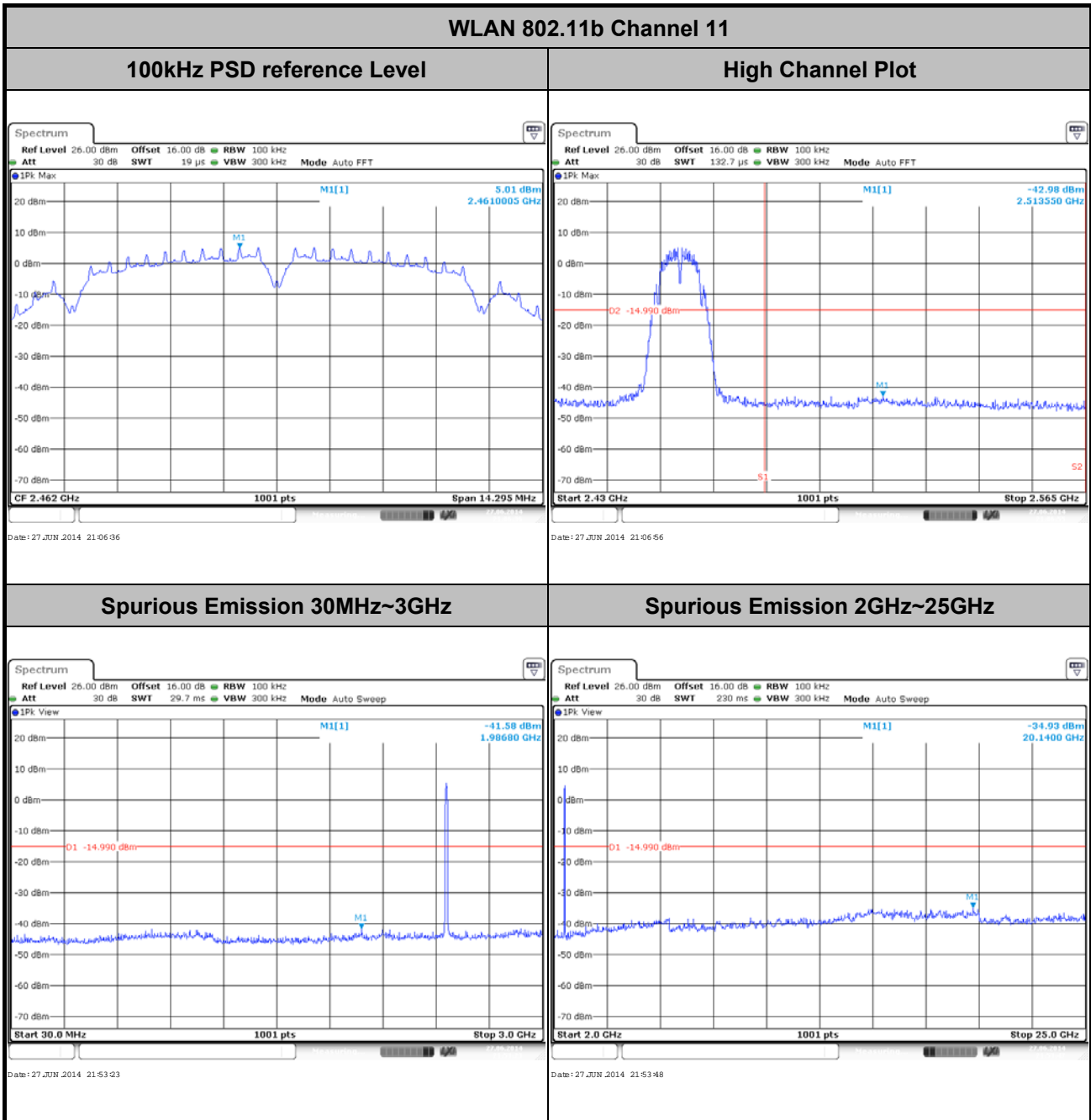



Test Mode :	802.11g	Temperature :	23~24°C
Test Band :	2.4GHz Low	Relative Humidity :	47~48%
Test Channel :	01	Test Engineer :	Adonis Li

WLAN 802.11g Channel 01

100kHz PSD reference Level	Low Channel Plot
----------------------------	------------------

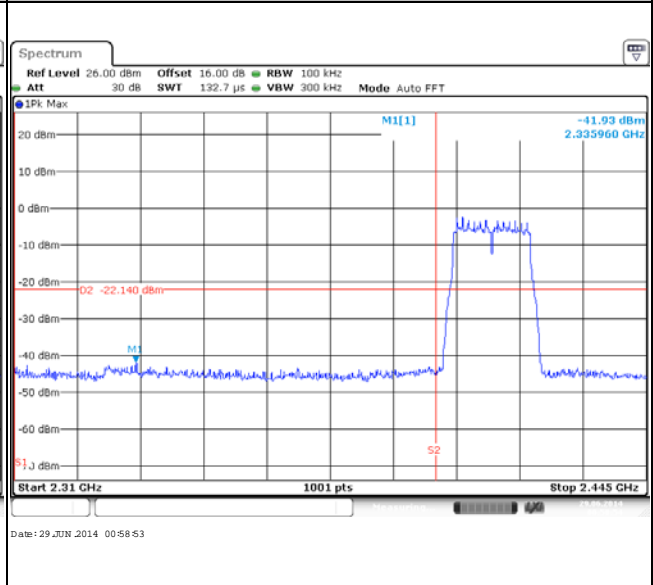
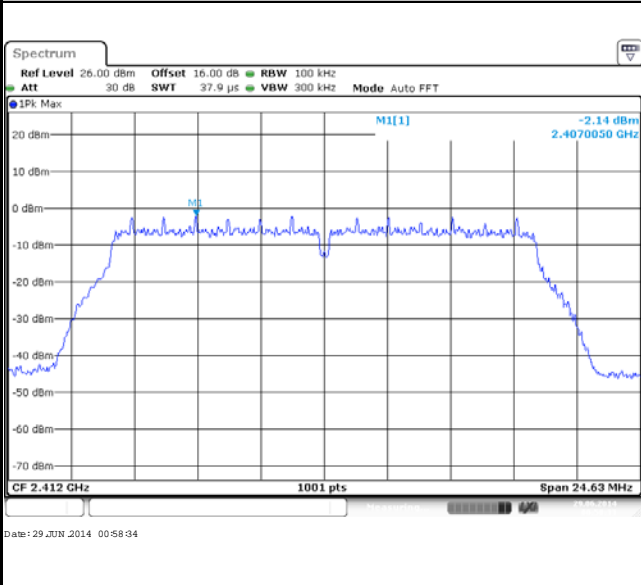

Spurious Emission 30MHz~3GHz

Spurious Emission 2GHz~25GHz

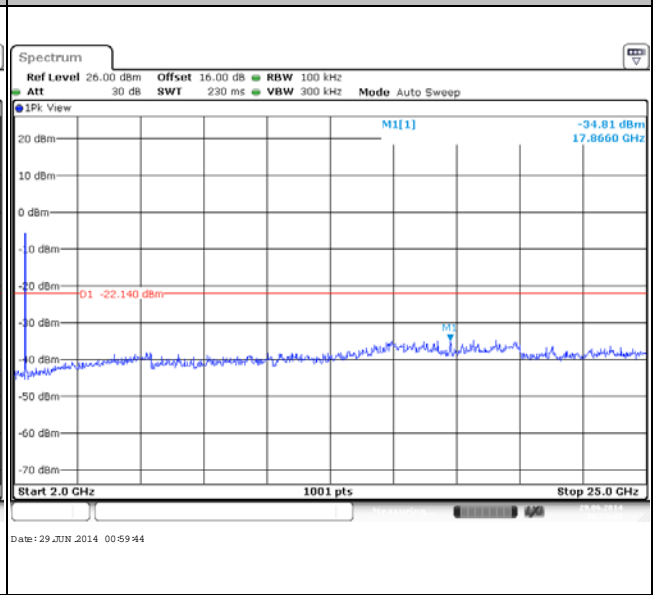
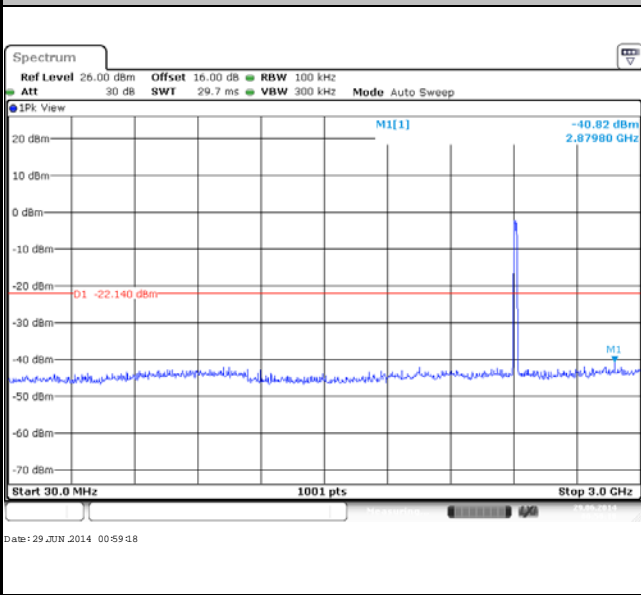



Test Mode :	802.11g	Temperature :	23~24°C
Test Band :	2.4GHz Mid	Relative Humidity :	47~48%
Test Channel :	06	Test Engineer :	Adonis Li

WLAN 802.11g Channel 06

100kHz PSD reference Level

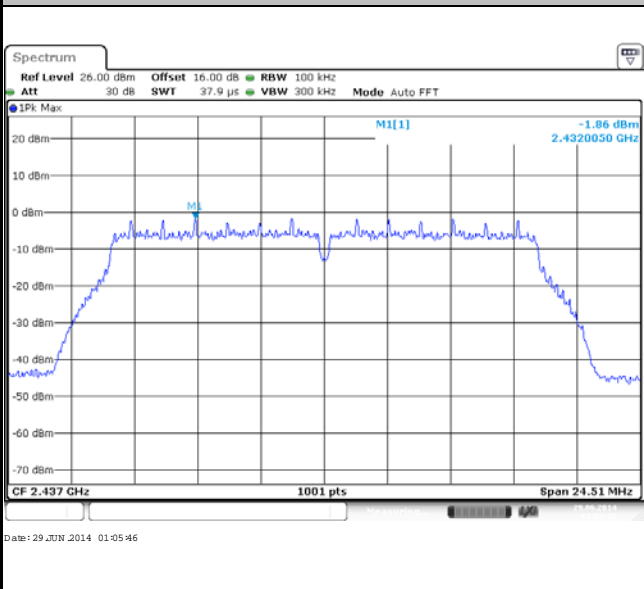

Spurious Emission 30MHz~3GHz

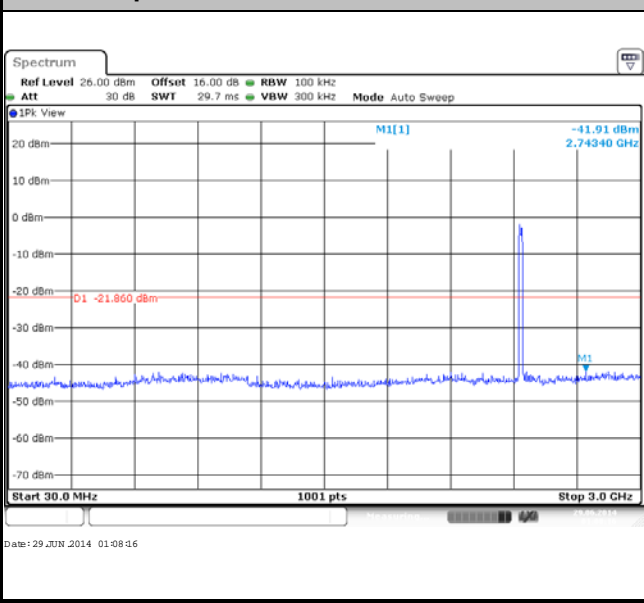

Spurious Emission 2GHz~25GHz

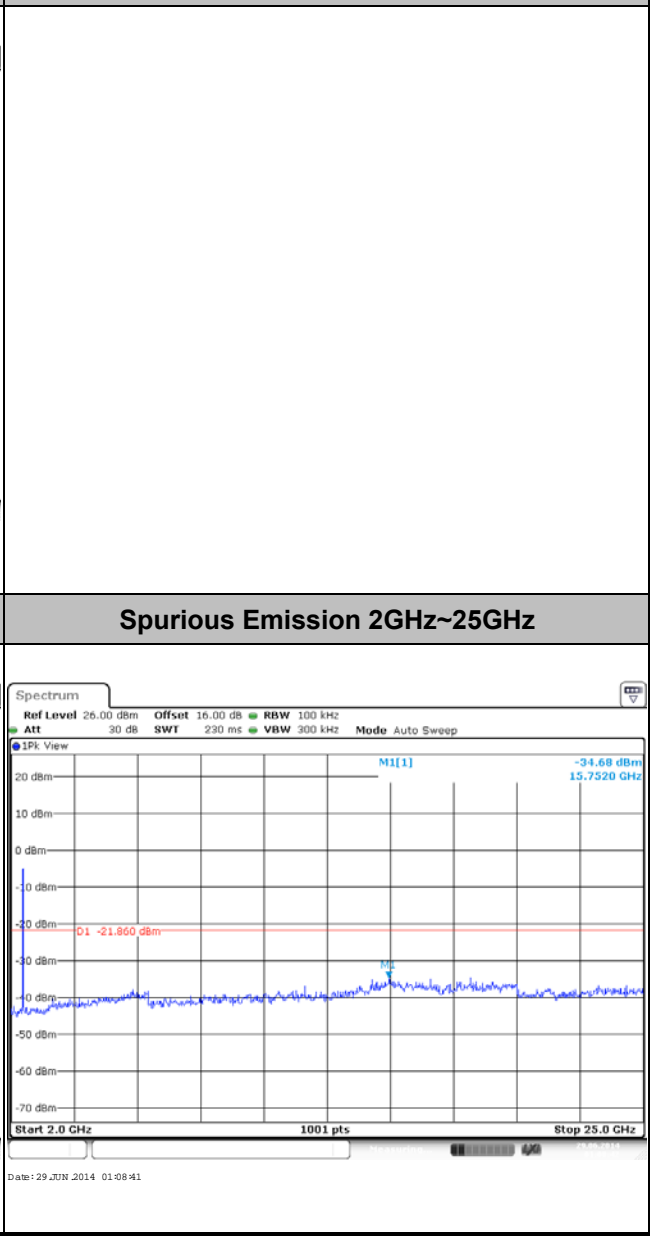



Test Mode :	802.11g	Temperature :	23~24°C
Test Band :	2.4GHz High	Relative Humidity :	47~48%
Test Channel :	11	Test Engineer :	Adonis Li

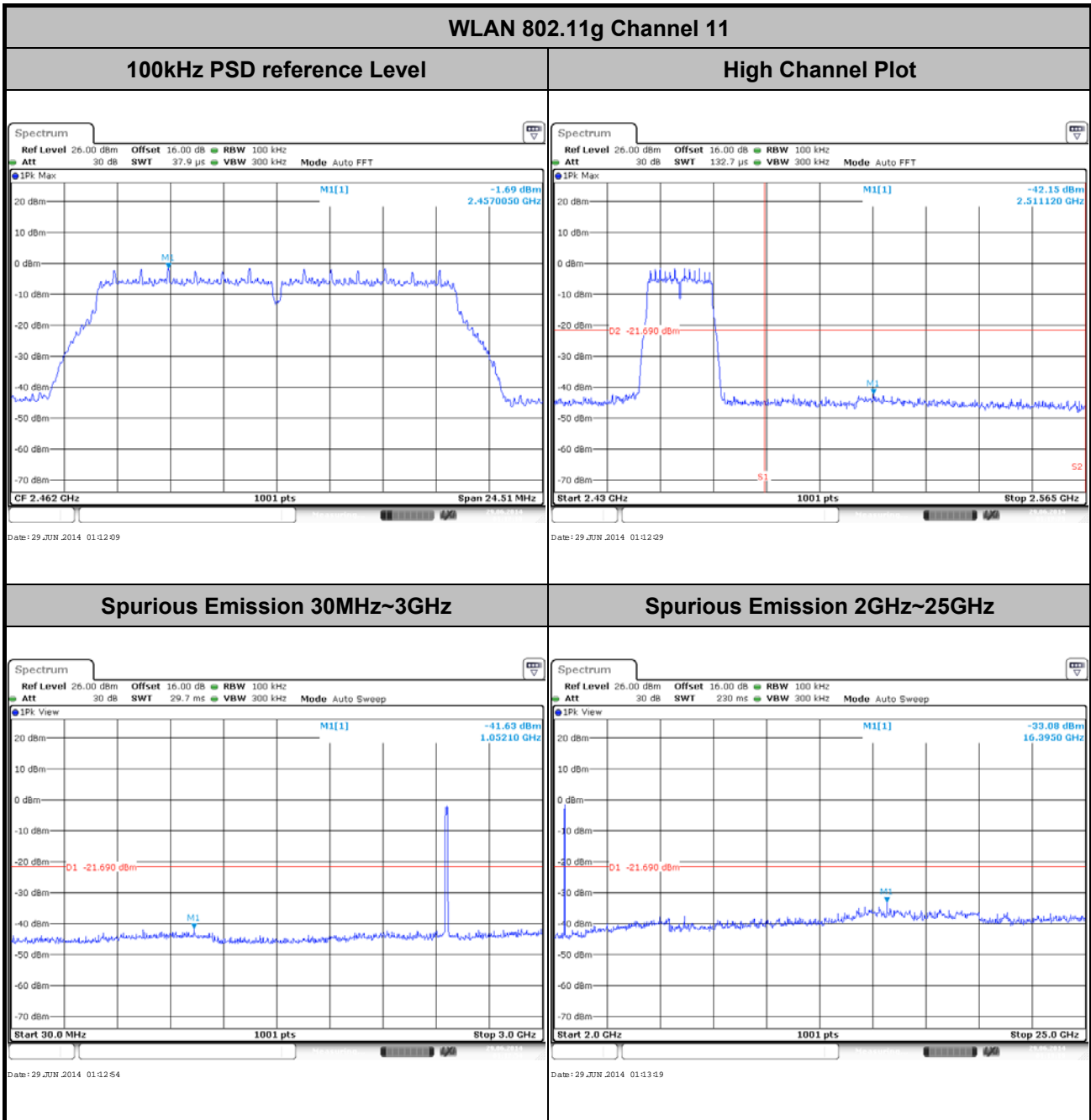



Test Mode :	802.11n HT20	Temperature :	23~24°C
Test Band :	2.4GHz Low	Relative Humidity :	47~48%
Test Channel :	01	Test Engineer :	Adonis Li

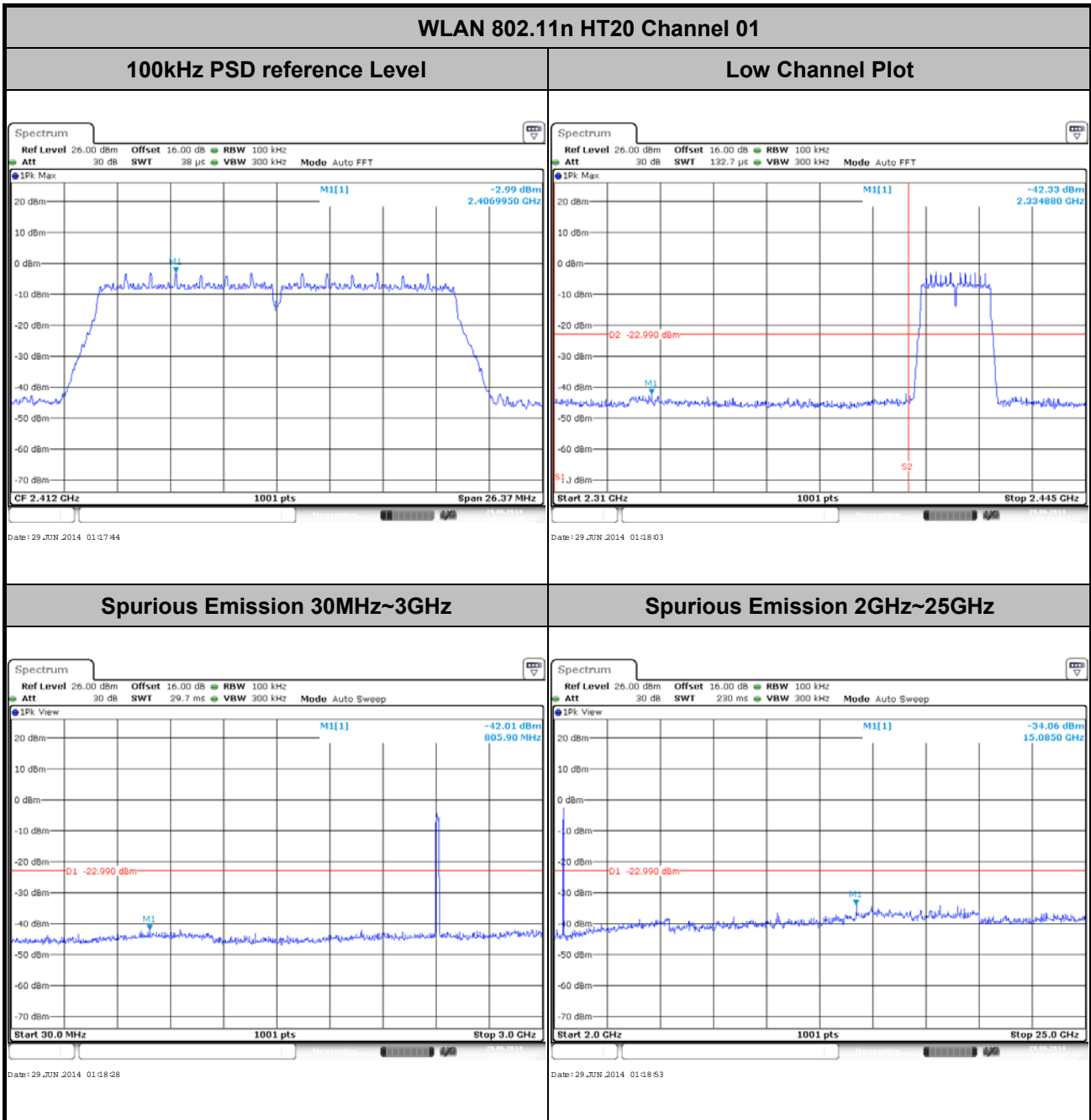



Test Mode :	802.11n HT20	Temperature :	23~24°C
Test Band :	2.4GHz Mid	Relative Humidity :	47~48%
Test Channel :	06	Test Engineer :	Adonis Li

WLAN 802.11n HT20 Channel 06

100kHz PSD reference Level

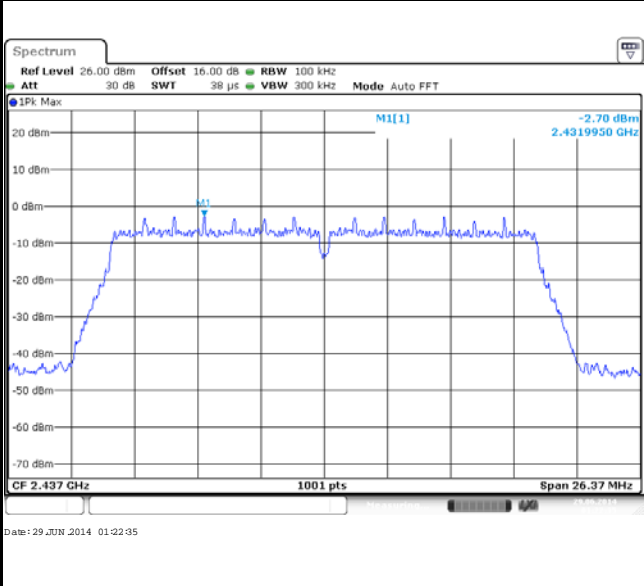

Spurious Emission 30MHz~3GHz

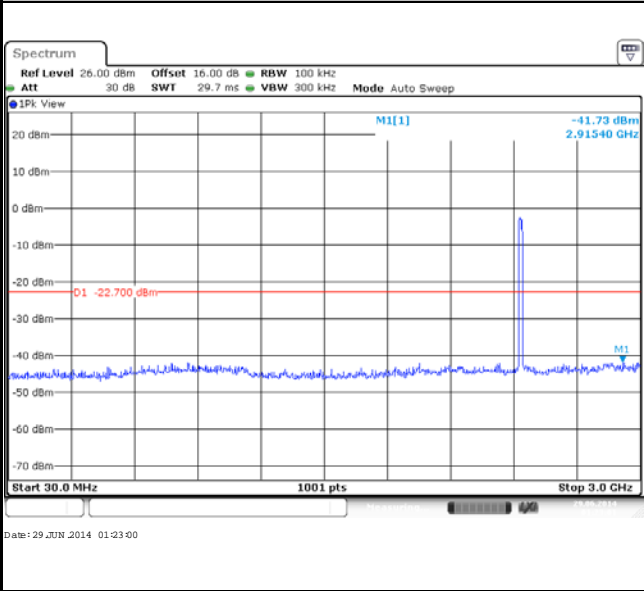

Spurious Emission 2GHz~25GHz

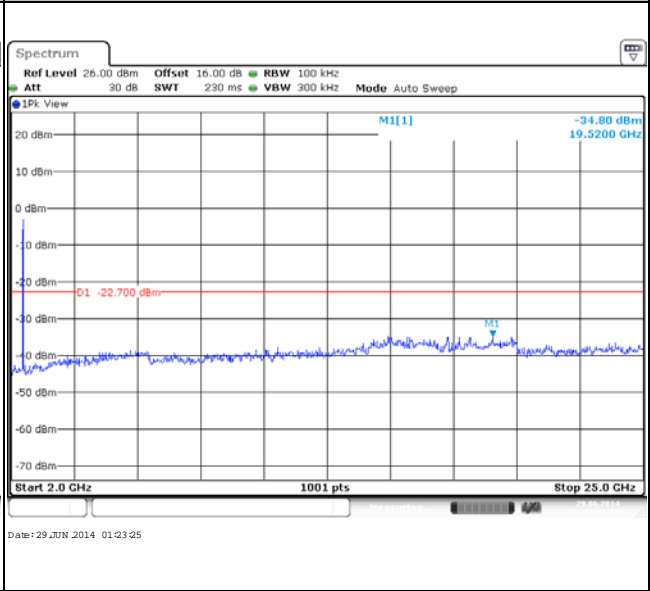



Test Mode :	802.11n HT20	Temperature :	23~24°C
Test Band :	2.4GHz High	Relative Humidity :	47~48%
Test Channel :	11	Test Engineer :	Adonis Li

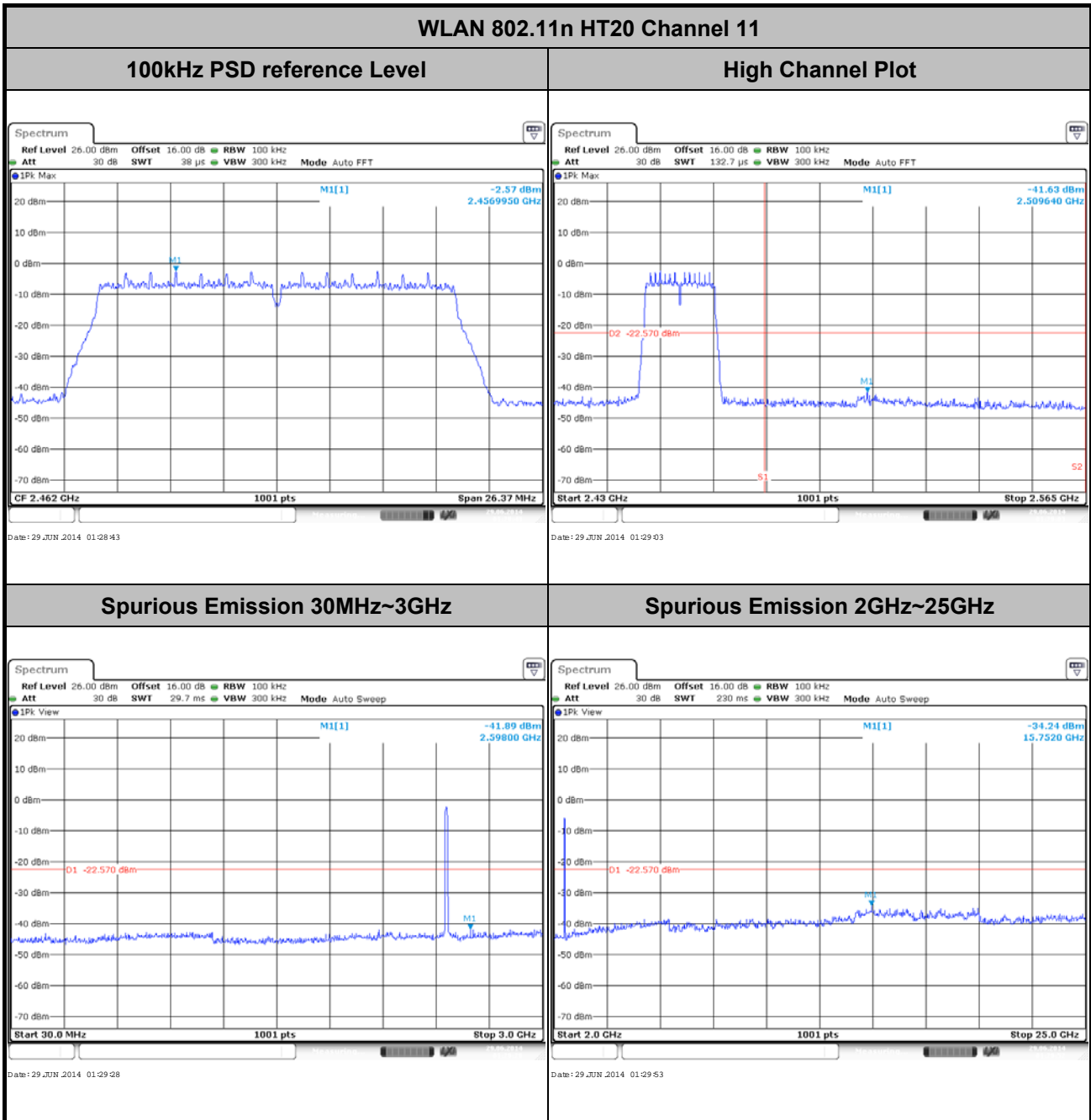



Test Mode :	802.11n HT40	Temperature :	23~24°C
Test Band :	2.4GHz Low	Relative Humidity :	47~48%
Test Channel :	03	Test Engineer :	Adonis Li

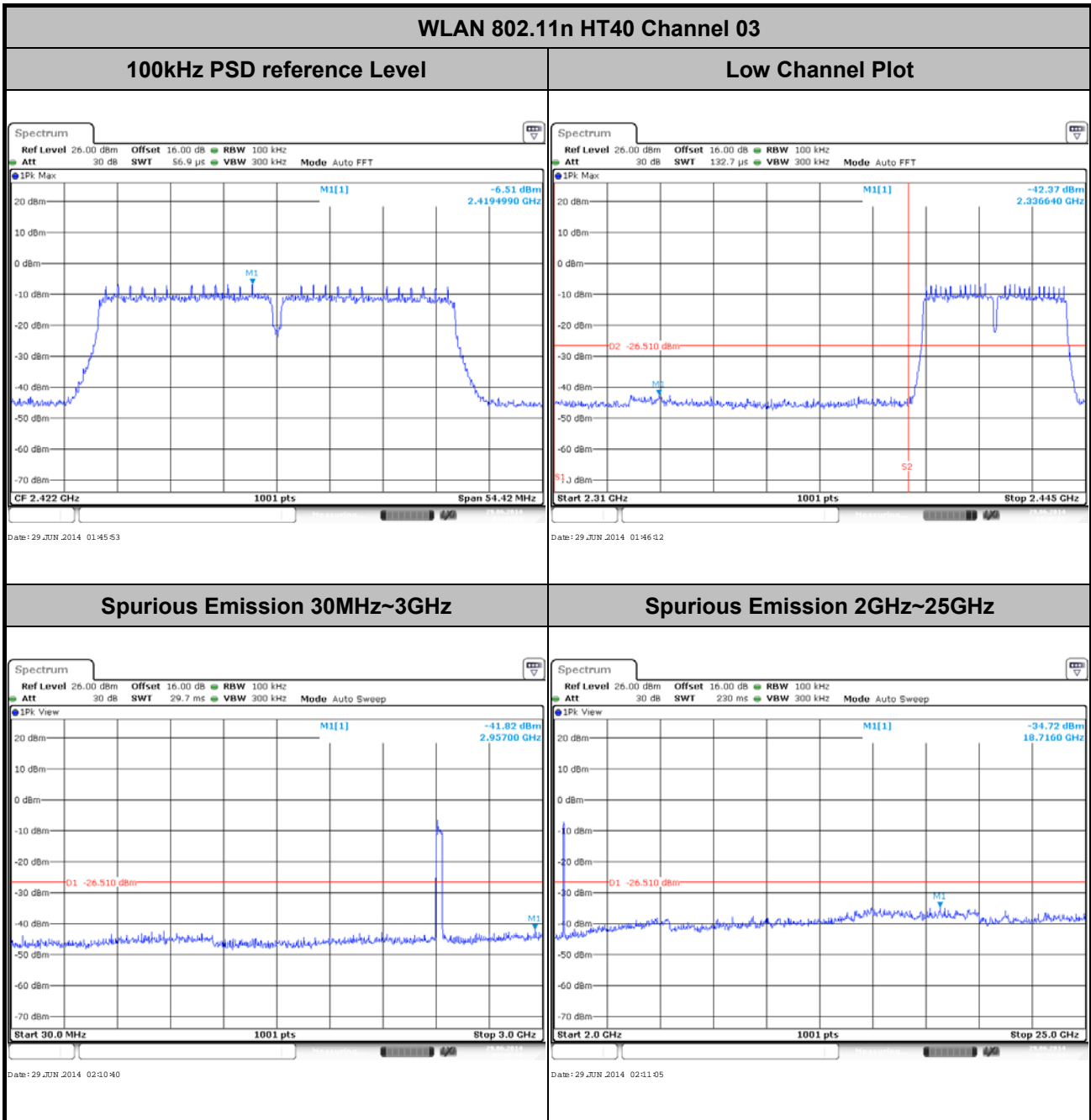



Test Mode :	802.11n HT40	Temperature :	23~24°C
Test Band :	2.4GHz Mid	Relative Humidity :	47~48%
Test Channel :	06	Test Engineer :	Adonis Li

WLAN 802.11n HT40 Channel 06

100kHz PSD reference Level

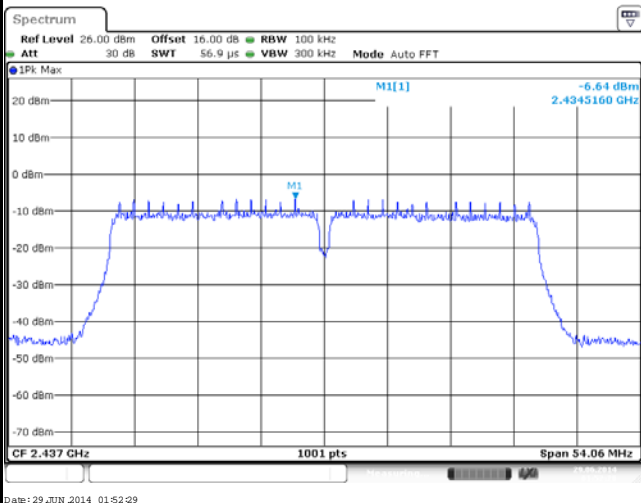

Date: 29 JUN 2014 01:52:29

Spurious Emission 30MHz~3GHz

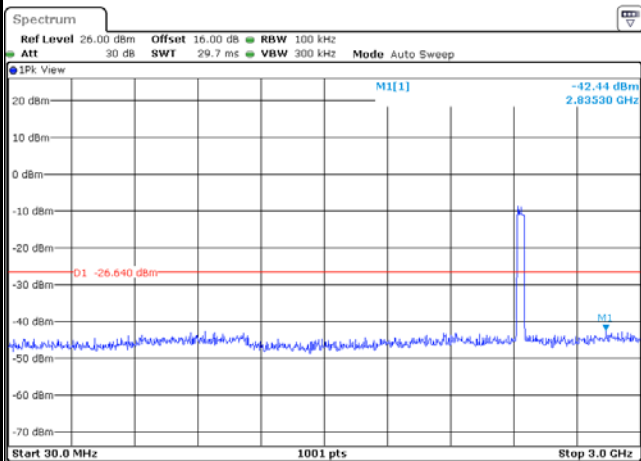

Date: 29 JUN 2014 02:03:27

Spurious Emission 2GHz~25GHz

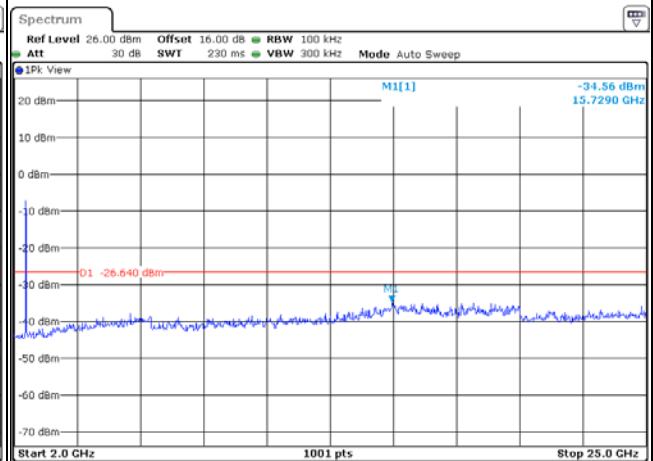

Date: 29 JUN 2014 02:03:53



Test Mode :	802.11n HT40	Temperature :	23~24°C
Test Band :	2.4GHz High	Relative Humidity :	47~48%
Test Channel :	09	Test Engineer :	Adonis Li

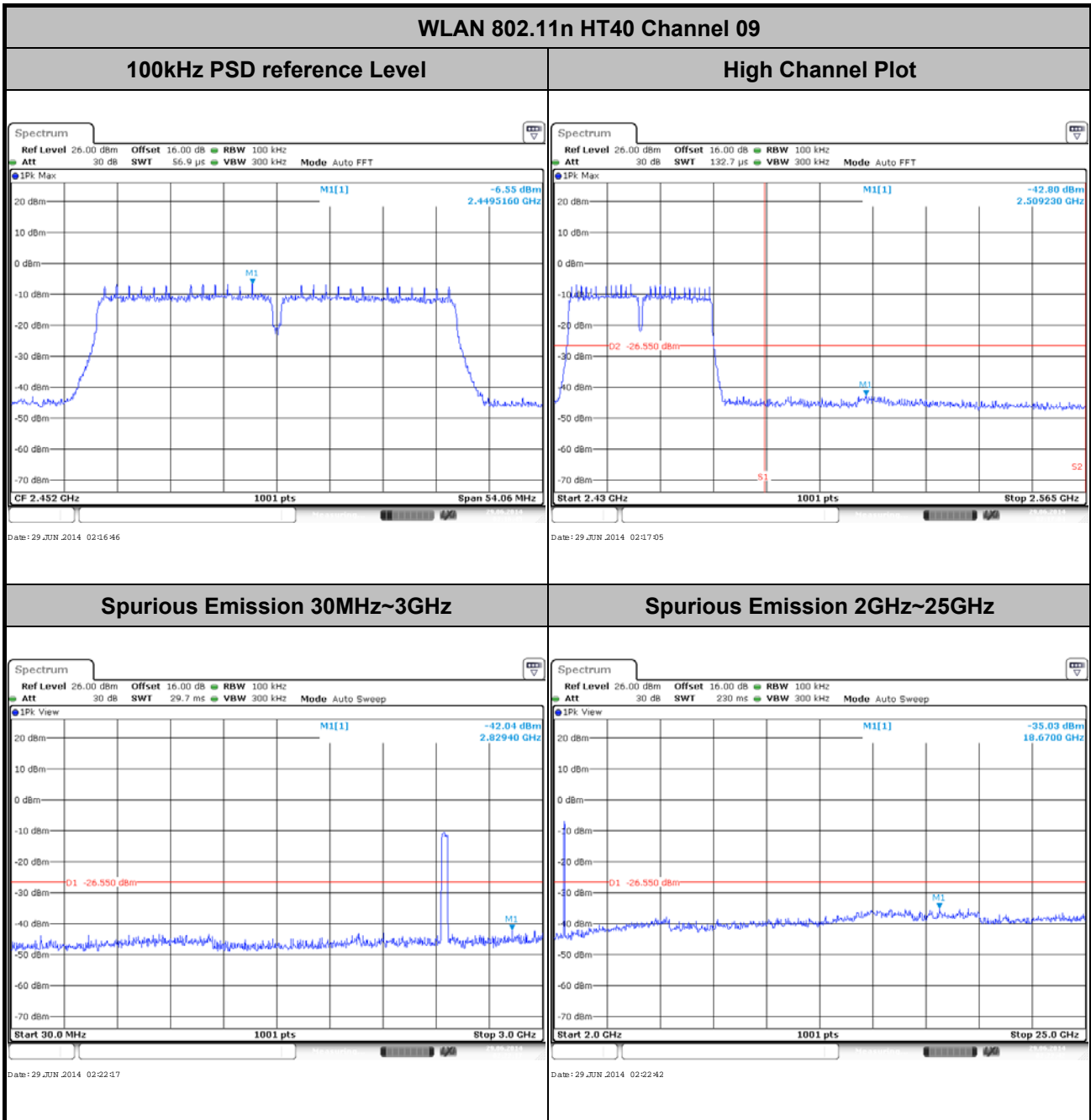



3.5 Radiated Band Edges and Spurious Emission Measurement

3.5.1 Limit of Radiated band edge and Spurious Emission Measurement

In any 100 kHz bandwidth outside the intentional radiator frequency band, all harmonics/spurious must be at least 20 dB below the highest emission level within the authorized band. If the output power of this device was measured by spectrum analyzer, the attenuation under this paragraph shall be 30 dB instead of 20 dB. In addition, radiated emissions which fall in the restricted bands must also comply with the FCC section 15.209 limits as below.

Frequency (MHz)	Field Strength (microvolts/meter)	Measurement Distance (meters)
0.009 – 0.490	2400/F(kHz)	300
0.490 – 1.705	24000/F(kHz)	30
1.705 – 30.0	30	30
30 – 88	100	3
88 – 216	150	3
216 - 960	200	3
Above 960	500	3

3.5.2 Measuring Instruments

The measuring equipment is listed in the section 4 of this test report.



3.5.3 Test Procedures

1. The testing follows FCC KDB Publication No. 558074 D01 DTS Meas. Guidance v03r02.
2. The EUT was arranged to its worst case and then tune the antenna tower (from 1 m to 4 m) and turntable (from 0 degree to 360 degrees) to find the maximum reading. A pre-amp and a high pass filter are used for the test in order to get better signal level.
3. The EUT was placed on a turntable with 0.8 meter above ground.
4. The EUT was set 3 meters from the interference receiving antenna, which was mounted on the top of a variable height antenna tower.
5. Corrected Reading: Antenna Factor + Cable Loss + Read Level - Preamp Factor = Level
6. For measurement below 1GHz, If the emission level of the EUT measured by the peak detector is 3 dB lower than the applicable limit, the peak emission level will be reported. Otherwise, the emission measurement will be repeated using the quasi-peak detector and reported.
7. Use the following spectrum analyzer settings:
 - (1) Span shall wide enough to fully capture the emission being measured;
 - (2) Set RBW=100 kHz for f < 1 GHz; VBW ≥ RBW; Sweep = auto; Detector function = peak; Trace = max hold;
 - (3) Set RBW = 1 MHz, VBW= 3MHz for f ≥ 1 GHz for peak measurement.
 For average measurement:
 - VBW = 10 Hz, when duty cycle is no less than 98 percent.
 - VBW ≥ 1/T, when duty cycle is less than 98 percent where T is the minimum transmission duration over which the transmitter is on and is transmitting at its maximum power control level for the tested mode of operation.

Band	Duty Cycle(%)	T(ms)	1/T(kHz)	VBW Setting
802.11b	97.97	8.38	0.12	300Hz
802.11g	88.89	1.39	0.72	1kHz
2.4GHz 802.11n HT20	88.87	1.31	0.76	1kHz
2.4GHz 802.11n HT40	79.12	0.65	1.54	3kHz

3.5.4 Test Setup

For radiated emissions below 30MHz

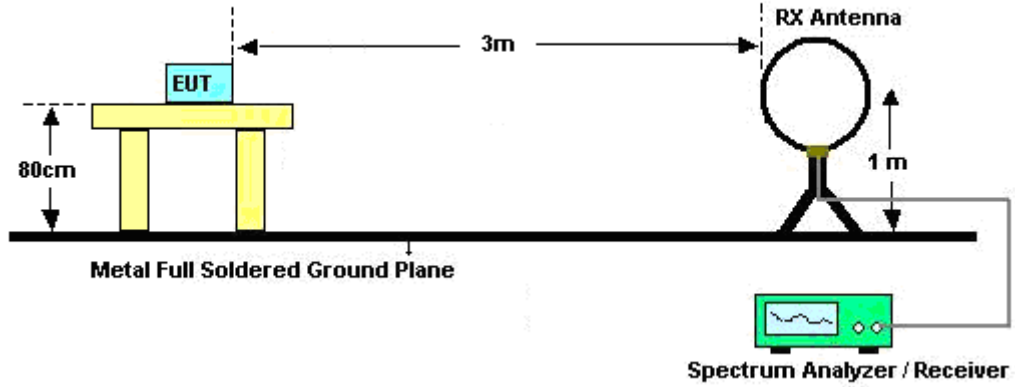

For radiated emissions from 30MHz to 1GHz

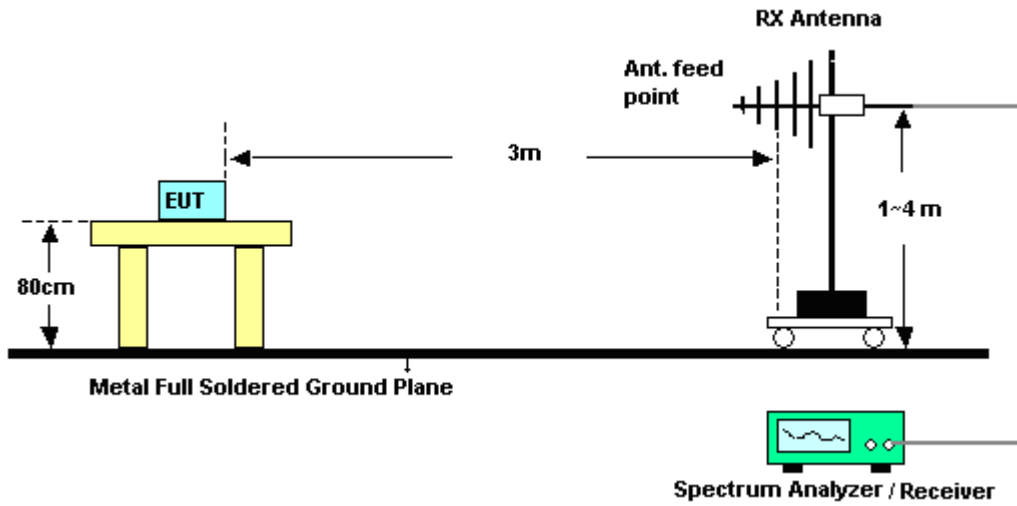

For radiated emissions above 1GHz

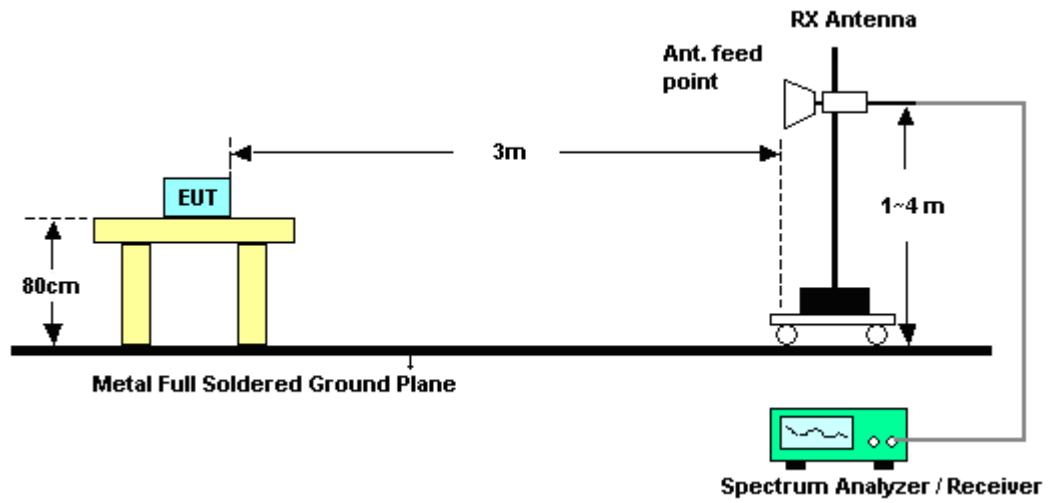

3.5.5 Test Results of Radiated Spurious Emissions (9kHz ~ 30MHz)

The low frequency, which started from 9 kHz to 30MHz, was pre-scanned and the result which was 20dB lower than the limit line per 15.31(o) was not reported.



3.5.6 Test Result of Radiated Spurious at Band Edges

Test Mode :	802.11b	Temperature :	22~23°C
Test Band :	Low	Relative Humidity :	42~43%
Test Channel :	01	Test Engineer :	Star Wei

ANTENNA POLARITY : HORIZONTAL										
Frequency (MHz)	Level (dBμV/m)	Over Limit (dB)	Limit Line (dBμV/m)	Read Level (dBμV)	Antenna Factor (dB)	Cable Loss (dB)	Preamp Factor (dB)	Ant Pos (cm)	Table Pos (deg)	Remark
2371.56	54.81	-19.19	74	56.95	31.93	2.62	36.69	182	222	Peak
2378.85	39.36	-14.64	54	41.48	31.93	2.64	36.69	182	222	Average

ANTENNA POLARITY : VERTICAL										
Frequency (MHz)	Level (dBμV/m)	Over Limit (dB)	Limit Line (dBμV/m)	Read Level (dBμV)	Antenna Factor (dB)	Cable Loss (dB)	Preamp Factor (dB)	Ant Pos (cm)	Table Pos (deg)	Remark
2388.21	51.17	-22.83	74	53.25	31.96	2.64	36.68	183	217	Peak
2382.99	36.41	-17.59	54	38.53	31.93	2.64	36.69	183	217	Average

Test Mode :	802.11b	Temperature :	22~23°C
Test Band :	High	Relative Humidity :	42~43%
Test Channel :	11	Test Engineer :	Star Wei

ANTENNA POLARITY : HORIZONTAL										
Frequency (MHz)	Level (dBμV/m)	Over Limit (dB)	Limit Line (dBμV/m)	Read Level (dBμV)	Antenna Factor (dB)	Cable Loss (dB)	Preamp Factor (dB)	Ant Pos (cm)	Table Pos (deg)	Remark
2487.13	54.00	-20.00	74	55.89	32.08	2.68	36.65	175	222	Peak
2486.29	38.49	-15.51	54	40.38	32.08	2.68	36.65	175	222	Average

ANTENNA POLARITY : VERTICAL										
Frequency (MHz)	Level (dBμV/m)	Over Limit (dB)	Limit Line (dBμV/m)	Read Level (dBμV)	Antenna Factor (dB)	Cable Loss (dB)	Preamp Factor (dB)	Ant Pos (cm)	Table Pos (deg)	Remark
2490.31	54.00	-20.00	74	55.87	32.10	2.68	36.65	100	260	Peak
2483.53	40.49	-13.51	54	42.38	32.08	2.68	36.65	100	260	Average



Test Mode :	802.11g	Temperature :	22~23°C
Test Band :	Low	Relative Humidity :	42~43%
Test Channel :	01	Test Engineer :	Star Wei

ANTENNA POLARITY : HORIZONTAL										
Frequency (MHz)	Level (dBμV/m)	Over Limit (dB)	Limit Line (dBμV/m)	Read Level (dBμV)	Antenna Factor (dB)	Cable Loss (dB)	Preamp Factor (dB)	Ant Pos (cm)	Table Pos (deg)	Remark
2389.83	64.93	-9.07	74	67.01	31.96	2.64	36.68	112	313	Peak
2390	47.19	-6.81	54	49.27	31.96	2.64	36.68	112	313	Average

ANTENNA POLARITY : VERTICAL										
Frequency (MHz)	Level (dBμV/m)	Over Limit (dB)	Limit Line (dBμV/m)	Read Level (dBμV)	Antenna Factor (dB)	Cable Loss (dB)	Preamp Factor (dB)	Ant Pos (cm)	Table Pos (deg)	Remark
2390	69.33	-4.67	74	71.41	31.96	2.64	36.68	100	258	Peak
2390	49.55	-4.45	54	51.63	31.96	2.64	36.68	100	258	Average

Test Mode :	802.11g	Temperature :	22~23°C
Test Band :	High	Relative Humidity :	42~43%
Test Channel :	11	Test Engineer :	Star Wei

ANTENNA POLARITY : HORIZONTAL										
Frequency (MHz)	Level (dBμV/m)	Over Limit (dB)	Limit Line (dBμV/m)	Read Level (dBμV)	Antenna Factor (dB)	Cable Loss (dB)	Preamp Factor (dB)	Ant Pos (cm)	Table Pos (deg)	Remark
2484.52	60.75	-13.25	74	62.64	32.08	2.68	36.65	114	317	Peak
2483.68	43.16	-10.84	54	45.05	32.08	2.68	36.65	114	317	Average

ANTENNA POLARITY : VERTICAL										
Frequency (MHz)	Level (dBμV/m)	Over Limit (dB)	Limit Line (dBμV/m)	Read Level (dBμV)	Antenna Factor (dB)	Cable Loss (dB)	Preamp Factor (dB)	Ant Pos (cm)	Table Pos (deg)	Remark
2483.5	69.89	-4.11	74	71.78	32.08	2.68	36.65	100	260	Peak
2483.5	46.83	-7.17	54	48.72	32.08	2.68	36.65	100	260	Average



Test Mode :	802.11n HT20	Temperature :	22~23°C
Test Band :	Low	Relative Humidity :	42~43%
Test Channel :	01	Test Engineer :	Star Wei

ANTENNA POLARITY : HORIZONTAL										
Frequency (MHz)	Level (dBμV/m)	Over Limit (dB)	Limit Line (dBμV/m)	Read Level (dBμV)	Antenna Factor (dB)	Cable Loss (dB)	Preamp Factor (dB)	Ant Pos (cm)	Table Pos (deg)	Remark
2389.47	57.12	-16.88	74	59.2	31.96	2.64	36.68	136	11	Peak
2390	41.41	-12.59	54	43.49	31.96	2.64	36.68	136	11	Average

ANTENNA POLARITY : VERTICAL										
Frequency (MHz)	Level (dBμV/m)	Over Limit (dB)	Limit Line (dBμV/m)	Read Level (dBμV)	Antenna Factor (dB)	Cable Loss (dB)	Preamp Factor (dB)	Ant Pos (cm)	Table Pos (deg)	Remark
2389.47	69.23	-4.77	74	71.31	31.96	2.64	36.68	100	237	Peak
2389.65	46.44	-7.56	54	48.52	31.96	2.64	36.68	100	237	Average

Test Mode :	802.11n HT20	Temperature :	22~23°C
Test Band :	High	Relative Humidity :	42~43%
Test Channel :	11	Test Engineer :	Star Wei

ANTENNA POLARITY : HORIZONTAL										
Frequency (MHz)	Level (dBμV/m)	Over Limit (dB)	Limit Line (dBμV/m)	Read Level (dBμV)	Antenna Factor (dB)	Cable Loss (dB)	Preamp Factor (dB)	Ant Pos (cm)	Table Pos (deg)	Remark
2484.19	57.55	-16.45	74	59.44	32.08	2.68	36.65	114	222	Peak
2483.65	41.98	-12.02	54	43.87	32.08	2.68	36.65	114	222	Average

ANTENNA POLARITY : VERTICAL										
Frequency (MHz)	Level (dBμV/m)	Over Limit (dB)	Limit Line (dBμV/m)	Read Level (dBμV)	Antenna Factor (dB)	Cable Loss (dB)	Preamp Factor (dB)	Ant Pos (cm)	Table Pos (deg)	Remark
2483.5	63.93	-10.07	74	65.82	32.08	2.68	36.65	100	263	Peak
2483.83	42.53	-11.47	54	44.42	32.08	2.68	36.65	100	263	Average



Test Mode :	802.11n HT40	Temperature :	22~23°C
Test Band :	Low	Relative Humidity :	42~43%
Test Channel :	03	Test Engineer :	Star Wei

ANTENNA POLARITY : HORIZONTAL										
Frequency (MHz)	Level (dBμV/m)	Over Limit (dB)	Limit Line (dBμV/m)	Read Level (dBμV)	Antenna Factor (dB)	Cable Loss (dB)	Preamp Factor (dB)	Ant Pos (cm)	Table Pos (deg)	Remark
2389.2	58.05	-15.95	74	60.13	31.96	2.64	36.68	111	236	Peak
2385.06	42.65	-11.35	54	44.77	31.93	2.64	36.69	111	236	Average
2484.22	50.36	-23.64	74	52.25	32.08	2.68	36.65	111	236	Peak
2485.75	38.11	-15.89	54	40	32.08	2.68	36.65	111	236	Average

ANTENNA POLARITY : VERTICAL										
Frequency (MHz)	Level (dBμV/m)	Over Limit (dB)	Limit Line (dBμV/m)	Read Level (dBμV)	Antenna Factor (dB)	Cable Loss (dB)	Preamp Factor (dB)	Ant Pos (cm)	Table Pos (deg)	Remark
2388.75	70.4	-3.60	74	72.48	31.96	2.64	36.68	100	250	Peak
2389.74	49.58	-4.42	54	51.66	31.96	2.64	36.68	100	250	Average
2487.13	52.54	-21.46	74	54.43	32.08	2.68	36.65	100	226	Peak
2487.37	39.69	-14.31	54	41.58	32.08	2.68	36.65	100	226	Average



Test Mode :	802.11n HT40	Temperature :	22~23°C
Test Band :	High	Relative Humidity :	42~43%
Test Channel :	09	Test Engineer :	Star Wei

ANTENNA POLARITY : HORIZONTAL										
Frequency (MHz)	Level (dBμV/m)	Over Limit (dB)	Limit Line (dBμV/m)	Read Level (dBμV)	Antenna Factor (dB)	Cable Loss (dB)	Preamp Factor (dB)	Ant Pos (cm)	Table Pos (deg)	Remark
2389.47	53.89	-20.11	74	55.97	31.96	2.64	36.68	111	313	Peak
2390	42.31	-11.69	54	44.39	31.96	2.64	36.68	111	313	Average
2484.82	66.98	-7.02	74	68.87	32.08	2.68	36.65	111	313	Peak
2483.8	44.07	-9.93	54	45.96	32.08	2.68	36.65	111	313	Average

ANTENNA POLARITY : VERTICAL										
Frequency (MHz)	Level (dBμV/m)	Over Limit (dB)	Limit Line (dBμV/m)	Read Level (dBμV)	Antenna Factor (dB)	Cable Loss (dB)	Preamp Factor (dB)	Ant Pos (cm)	Table Pos (deg)	Remark
2389.02	54.49	-19.51	74	56.57	31.96	2.64	36.68	100	266	Peak
2387.13	42.74	-11.26	54	44.82	31.96	2.64	36.68	100	266	Average
2484.67	66.39	-7.61	74	68.28	32.08	2.68	36.65	100	266	Peak
2483.71	42.44	-11.56	54	44.33	32.08	2.68	36.65	100	266	Average



3.5.7 Test Result of Radiated Spurious Emission (30MHz ~ 10th Harmonic)

Note: Pre-scanned all test modes and only choose the worst case mode recorded in the test report for radiated spurious emission below 1GHz.

Test Mode :	802.11b	Temperature :	22~23°C
Test Channel :	01	Relative Humidity :	42~43%
Test Engineer :	Star Wei	Polarization :	Horizontal
Remark :	1. 2412 MHz is fundamental signal which can be ignored. 2. Average measurement was not performed if peak level went lower than the average limit.		

Frequency (MHz)	Level (dBμV/m)	Over Limit (dB)	Limit Line (dBμV/m)	Read Level (dBμV)	Antenna Factor (dB)	Cable Loss (dB)	Preamp Factor (dB)	Ant Pos (cm)	Table Pos (deg)	Remark
2412	106.14	-	-	108.17	31.98	2.66	36.67	182	222	Peak
2412	101.47	-	-	103.5	31.98	2.66	36.67	182	222	Average
4824	50.05	-23.95	74	47.44	34.07	3.78	35.24	100	28	Peak

Test Mode :	802.11b	Temperature :	22~23°C
Test Channel :	01	Relative Humidity :	42~43%
Test Engineer :	Star Wei	Polarization :	Vertical
Remark :	1. 2412 MHz is fundamental signal which can be ignored. 2. Average measurement was not performed if peak level went lower than the average limit.		

Frequency (MHz)	Level (dBμV/m)	Over Limit (dB)	Limit Line (dBμV/m)	Read Level (dBμV)	Antenna Factor (dB)	Cable Loss (dB)	Preamp Factor (dB)	Ant Pos (cm)	Table Pos (deg)	Remark
2412	106.22	-	-	108.25	31.98	2.66	36.67	183	217	Peak
2412	101.56	-	-	103.59	31.98	2.66	36.67	183	217	Average
4824	50.22	-23.78	74	47.61	34.07	3.78	35.24	100	196	Peak



Test Mode :	802.11b	Temperature :	22~23°C
Test Channel :	06	Relative Humidity :	42~43%
Test Engineer :	Star Wei	Polarization :	Horizontal
Remark :	1. 2437 MHz is fundamental signal which can be ignored. 2. Average measurement was not performed if peak level went lower than the average limit.		

Frequency (MHz)	Level (dBμV/m)	Over Limit (dB)	Limit Line (dBμV/m)	Read Level (dBμV)	Antenna Factor (dB)	Cable Loss (dB)	Preamp Factor (dB)	Ant Pos (cm)	Table Pos (deg)	Remark
2437	103.75	-	-	105.73	32.03	2.66	36.67	163	356	Peak
2437	99.15	-	-	101.13	32.03	2.66	36.67	163	356	Average
4874	49.27	-24.73	74	46.64	34.02	3.78	35.17	100	158	Peak
7312	50.70	-23.30	74	44.90	35.72	4.73	34.65	100	25	Peak

Test Mode :	802.11b	Temperature :	22~23°C
Test Channel :	06	Relative Humidity :	42~43%
Test Engineer :	Star Wei	Polarization :	Vertical
Remark :	1. 2437 MHz is fundamental signal which can be ignored. 2. Average measurement was not performed if peak level went lower than the average limit.		

Frequency (MHz)	Level (dBμV/m)	Over Limit (dB)	Limit Line (dBμV/m)	Read Level (dBμV)	Antenna Factor (dB)	Cable Loss (dB)	Preamp Factor (dB)	Ant Pos (cm)	Table Pos (deg)	Remark
2437	106.48	-	-	108.46	32.03	2.66	36.67	100	256	Peak
2437	102.11	-	-	104.09	32.03	2.66	36.67	100	256	Average
4874	50.41	-23.59	74	47.78	34.02	3.78	35.17	100	41	Peak
7312	50.49	-23.51	74	44.69	35.72	4.73	34.65	100	82	Peak



Test Mode :	802.11b	Temperature :	22~23°C
Test Channel :	11	Relative Humidity :	42~43%
Test Engineer :	Star Wei	Polarization :	Horizontal
Remark :	1. 2462 MHz is fundamental signal which can be ignored. 2. Average measurement was not performed if peak level went lower than the average limit.		

Frequency (MHz)	Level (dBμV/m)	Over Limit (dB)	Limit Line (dBμV/m)	Read Level (dBμV)	Antenna Factor (dB)	Cable Loss (dB)	Preamp Factor (dB)	Ant Pos (cm)	Table Pos (deg)	Remark
2462	105.33	-	-	107.27	32.05	2.67	36.66	175	222	Peak
2462	100.71	-	-	102.65	32.05	2.67	36.66	175	222	Average
4924	49.71	-24.29	74	47.05	33.97	3.78	35.09	100	185	Peak
7386	50.60	-23.40	74	44.77	35.76	4.77	34.7	100	48	Peak

Test Mode :	802.11b	Temperature :	22~23°C
Test Channel :	11	Relative Humidity :	42~43%
Test Engineer :	Star Wei	Polarization :	Vertical
Remark :	1. 2462 MHz is fundamental signal which can be ignored. 2. Average measurement was not performed if peak level went lower than the average limit.		

Frequency (MHz)	Level (dBμV/m)	Over Limit (dB)	Limit Line (dBμV/m)	Read Level (dBμV)	Antenna Factor (dB)	Cable Loss (dB)	Preamp Factor (dB)	Ant Pos (cm)	Table Pos (deg)	Remark
2462	107.24	-	-	109.18	32.05	2.67	36.66	100	260	Peak
2462	102.22	-	-	104.16	32.05	2.67	36.66	100	260	Average
4924	50.27	-23.73	74	47.61	33.97	3.78	35.09	100	25	Peak
7386	50.58	-23.42	74	44.75	35.76	4.77	34.7	100	91	Peak



Test Mode :	802.11g	Temperature :	22~23°C
Test Channel :	01	Relative Humidity :	42~43%
Test Engineer :	Star Wei	Polarization :	Horizontal
Remark :	1. 2412 MHz is fundamental signal which can be ignored. 2. Average measurement was not performed if peak level went lower than the average limit.		

Frequency (MHz)	Level (dBμV/m)	Over Limit (dB)	Limit Line (dBμV/m)	Read Level (dBμV)	Antenna Factor (dB)	Cable Loss (dB)	Preamp Factor (dB)	Ant Pos (cm)	Table Pos (deg)	Remark
2412	105.97	-	-	108.00	31.98	2.66	36.67	112	313	Peak
2412	94.99	-	-	97.02	31.98	2.66	36.67	112	313	Average
4824	49.08	-24.92	74	46.47	34.07	3.78	35.24	100	144	Peak

Test Mode :	802.11g	Temperature :	22~23°C
Test Channel :	01	Relative Humidity :	42~43%
Test Engineer :	Star Wei	Polarization :	Vertical
Remark :	1. 2412 MHz is fundamental signal which can be ignored. 2. Average measurement was not performed if peak level went lower than the average limit.		

Frequency (MHz)	Level (dBμV/m)	Over Limit (dB)	Limit Line (dBμV/m)	Read Level (dBμV)	Antenna Factor (dB)	Cable Loss (dB)	Preamp Factor (dB)	Ant Pos (cm)	Table Pos (deg)	Remark
2412	107.26	-	-	109.29	31.98	2.66	36.67	100	258	Peak
2412	95.63	-	-	97.66	31.98	2.66	36.67	100	258	Average
4824	49.67	-24.33	74	47.06	34.07	3.78	35.24	100	52	Peak



Test Mode :	802.11g	Temperature :	22~23°C
Test Channel :	06	Relative Humidity :	42~43%
Test Engineer :	Star Wei	Polarization :	Horizontal
Remark :	1. 2437 MHz is fundamental signal which can be ignored. 2. Average measurement was not performed if peak level went lower than the average limit.		

Frequency (MHz)	Level (dBμV/m)	Over Limit (dB)	Limit Line (dBμV/m)	Read Level (dBμV)	Antenna Factor (dB)	Cable Loss (dB)	Preamp Factor (dB)	Ant Pos (cm)	Table Pos (deg)	Remark
2437	103.69	-	-	105.67	32.03	2.66	36.67	174	225	Peak
2437	92.32	-	-	94.3	32.03	2.66	36.67	174	225	Average
4874	48.93	-25.07	74	46.3	34.02	3.78	35.17	100	145	Peak
7312	48.57	-25.43	74	42.77	35.72	4.73	34.65	100	302	Peak

Test Mode :	802.11g	Temperature :	22~23°C
Test Channel :	06	Relative Humidity :	42~43%
Test Engineer :	Star Wei	Polarization :	Vertical
Remark :	1. 2437 MHz is fundamental signal which can be ignored. 2. Average measurement was not performed if peak level went lower than the average limit.		

Frequency (MHz)	Level (dBμV/m)	Over Limit (dB)	Limit Line (dBμV/m)	Read Level (dBμV)	Antenna Factor (dB)	Cable Loss (dB)	Preamp Factor (dB)	Ant Pos (cm)	Table Pos (deg)	Remark
2437	106.73	-	-	108.71	32.03	2.66	36.67	100	273	Peak
2437	94.83	-	-	96.81	32.03	2.66	36.67	100	273	Average
4874	49.00	-25.00	74	46.37	34.02	3.78	35.17	100	20	Peak
7312	48.44	-25.56	74	42.64	35.72	4.73	34.65	100	109	Peak



Test Mode :	802.11g	Temperature :	22~23°C
Test Channel :	11	Relative Humidity :	42~43%
Test Engineer :	Star Wei	Polarization :	Horizontal
Remark :	1. 2462 MHz is fundamental signal which can be ignored. 2. Average measurement was not performed if peak level went lower than the average limit.		

Frequency (MHz)	Level (dBμV/m)	Over Limit (dB)	Limit Line (dBμV/m)	Read Level (dBμV)	Antenna Factor (dB)	Cable Loss (dB)	Preamp Factor (dB)	Ant Pos (cm)	Table Pos (deg)	Remark
2462	104.57	-	-	106.51	32.05	2.67	36.66	114	317	Peak
2462	93.44	-	-	95.38	32.05	2.67	36.66	114	317	Average
4924	48.79	-25.21	74	46.13	33.97	3.78	35.09	100	261	Peak
7386	50.07	-23.93	74	44.24	35.76	4.77	34.70	100	50	Peak

Test Mode :	802.11g	Temperature :	22~23°C
Test Channel :	11	Relative Humidity :	42~43%
Test Engineer :	Star Wei	Polarization :	Vertical
Remark :	1. 2462 MHz is fundamental signal which can be ignored. 2. Average measurement was not performed if peak level went lower than the average limit.		

Frequency (MHz)	Level (dBμV/m)	Over Limit (dB)	Limit Line (dBμV/m)	Read Level (dBμV)	Antenna Factor (dB)	Cable Loss (dB)	Preamp Factor (dB)	Ant Pos (cm)	Table Pos (deg)	Remark
2462	107.02	-	-	108.96	32.05	2.67	36.66	100	260	Peak
2462	95.97	-	-	97.91	32.05	2.67	36.66	100	260	Average
4924	50.07	-23.93	74	47.41	33.97	3.78	35.09	100	205	Peak
7386	48.95	-25.05	74	43.12	35.76	4.77	34.70	100	105	Peak



Test Mode :	2.4GHz 802.11n HT20	Temperature :	22~23°C
Test Channel :	01	Relative Humidity :	42~43%
Test Engineer :	Star Wei	Polarization :	Horizontal
Remark :	1. 2412 MHz is fundamental signal which can be ignored. 2. Average measurement was not performed if peak level went lower than the average limit.		

Frequency (MHz)	Level (dBμV/m)	Over Limit (dB)	Limit Line (dBμV/m)	Read Level (dBμV)	Antenna Factor (dB)	Cable Loss (dB)	Preamp Factor (dB)	Ant Pos (cm)	Table Pos (deg)	Remark
2412	100.39	-	-	102.42	31.98	2.66	36.67	136	11	Peak
2412	88.82	-	-	90.85	31.98	2.66	36.67	136	11	Average
4824	49.67	-24.33	74	47.06	34.07	3.78	35.24	100	105	Peak

Test Mode :	2.4GHz 802.11n HT20	Temperature :	22~23°C
Test Channel :	01	Relative Humidity :	42~43%
Test Engineer :	Star Wei	Polarization :	Vertical
Remark :	1. 2412 MHz is fundamental signal which can be ignored. 2. Average measurement was not performed if peak level went lower than the average limit.		

Frequency (MHz)	Level (dBμV/m)	Over Limit (dB)	Limit Line (dBμV/m)	Read Level (dBμV)	Antenna Factor (dB)	Cable Loss (dB)	Preamp Factor (dB)	Ant Pos (cm)	Table Pos (deg)	Remark
2412	104.61	-	-	106.64	31.98	2.66	36.67	100	237	Peak
2412	93.04	-	-	95.07	31.98	2.66	36.67	100	237	Average
4824	49.14	-24.86	74	46.53	34.07	3.78	35.24	100	94	Peak



Test Mode :	2.4GHz 802.11n HT20	Temperature :	22~23°C
Test Channel :	06	Relative Humidity :	42~43%
Test Engineer :	Star Wei	Polarization :	Horizontal
Remark :	1. 2437 MHz is fundamental signal which can be ignored. 2. Average measurement was not performed if peak level went lower than the average limit.		

Frequency (MHz)	Level (dBμV/m)	Over Limit (dB)	Limit Line (dBμV/m)	Read Level (dBμV)	Antenna Factor (dB)	Cable Loss (dB)	Preamp Factor (dB)	Ant Pos (cm)	Table Pos (deg)	Remark
2437	100.54	-	-	102.52	32.03	2.66	36.67	200	233	Peak
2437	88.74	-	-	90.72	32.03	2.66	36.67	200	233	Average
4874	49.02	-24.98	74	46.39	34.02	3.78	35.17	100	101	Peak
7312	50.21	-23.79	74	44.41	35.72	4.73	34.65	100	158	Peak

Test Mode :	2.4GHz 802.11n HT20	Temperature :	22~23°C
Test Channel :	06	Relative Humidity :	42~43%
Test Engineer :	Star Wei	Polarization :	Vertical
Remark :	1. 2437 MHz is fundamental signal which can be ignored. 2. Average measurement was not performed if peak level went lower than the average limit.		

Frequency (MHz)	Level (dBμV/m)	Over Limit (dB)	Limit Line (dBμV/m)	Read Level (dBμV)	Antenna Factor (dB)	Cable Loss (dB)	Preamp Factor (dB)	Ant Pos (cm)	Table Pos (deg)	Remark
2437	104.4	-	-	106.38	32.03	2.66	36.67	100	262	Peak
2437	93.32	-	-	95.3	32.03	2.66	36.67	100	262	Average
4874	48.45	-25.55	74	45.82	34.02	3.78	35.17	100	194	Peak
7312	50.27	-23.73	74	44.47	35.72	4.73	34.65	100	81	Peak



Test Mode :	2.4GHz 802.11n HT20	Temperature :	22~23°C
Test Channel :	11	Relative Humidity :	42~43%
Test Engineer :	Star Wei	Polarization :	Horizontal
Remark :	1. 2462 MHz is fundamental signal which can be ignored. 2. Average measurement was not performed if peak level went lower than the average limit.		

Frequency (MHz)	Level (dBμV/m)	Over Limit (dB)	Limit Line (dBμV/m)	Read Level (dBμV)	Antenna Factor (dB)	Cable Loss (dB)	Preamp Factor (dB)	Ant Pos (cm)	Table Pos (deg)	Remark
2462	102.52	-	-	104.46	32.05	2.67	36.66	114	222	Peak
2462	91.80	-	-	93.74	32.05	2.67	36.66	114	222	Average
4924	49.87	-24.13	74	47.21	33.97	3.78	35.09	100	192	Peak
7386	50.65	-23.35	74	44.82	35.76	4.77	34.7	100	196	Peak

Test Mode :	2.4GHz 802.11n HT20	Temperature :	22~23°C
Test Channel :	11	Relative Humidity :	42~43%
Test Engineer :	Star Wei	Polarization :	Vertical
Remark :	1. 2462 MHz is fundamental signal which can be ignored. 2. Average measurement was not performed if peak level went lower than the average limit.		

Frequency (MHz)	Level (dBμV/m)	Over Limit (dB)	Limit Line (dBμV/m)	Read Level (dBμV)	Antenna Factor (dB)	Cable Loss (dB)	Preamp Factor (dB)	Ant Pos (cm)	Table Pos (deg)	Remark
2462	104.51	-	-	106.45	32.05	2.67	36.66	100	263	Peak
2462	93.39	-	-	95.33	32.05	2.67	36.66	100	263	Average
4924	49.12	-24.88	74	46.46	33.97	3.78	35.09	100	42	Peak
7386	50.89	-23.11	74	45.06	35.76	4.77	34.70	100	62	Peak



Test Mode :	2.4GHz 802.11n HT40	Temperature :	22~23°C
Test Channel :	03	Relative Humidity :	42~43%
Test Engineer :	Star Wei	Polarization :	Horizontal
Remark :	1. 2422 MHz is fundamental signal which can be ignored. 2. Average measurement was not performed if peak level went lower than the average limit.		

Frequency (MHz)	Level (dBμV/m)	Over Limit (dB)	Limit Line (dBμV/m)	Read Level (dBμV)	Antenna Factor (dB)	Cable Loss (dB)	Preamp Factor (dB)	Ant Pos (cm)	Table Pos (deg)	Remark
33.88	27.00	-13.00	40	43.69	15.75	0.19	32.63	100	201	Peak
101.78	27.25	-16.25	43.5	48.55	10.90	0.43	32.63	-	-	Peak
150.28	25.59	-17.91	43.5	47.23	10.10	0.82	32.56	-	-	Peak
320.03	22.72	-23.28	46	40.59	13.70	0.84	32.41	-	-	Peak
442.25	19.77	-26.23	46	34.39	16.32	1.2	32.14	-	-	Peak
728.4	23.60	-22.40	46	34.38	19.82	1.41	32.01	-	-	Peak
2422	96.97	-	-	98.98	32.00	2.66	36.67	198	236	Peak
2422	86.09	-	-	88.1	32.00	2.66	36.67	198	236	Average
4844	48.28	-25.72	74	45.65	34.06	3.78	35.21	100	154	Peak
7266	48.98	-25.02	74	43.19	35.71	4.72	34.64	100	20	Peak



Test Mode :	2.4GHz 802.11n HT40	Temperature :	22~23°C
Test Channel :	03	Relative Humidity :	42~43%
Test Engineer :	Star Wei	Polarization :	Vertical
Remark :	1. 2422 MHz is fundamental signal which can be ignored. 2. Average measurement was not performed if peak level went lower than the average limit.		

Frequency (MHz)	Level (dBμV/m)	Over Limit (dB)	Limit Line (dBμV/m)	Read Level (dBμV)	Antenna Factor (dB)	Cable Loss (dB)	Preamp Factor (dB)	Ant Pos (cm)	Table Pos (deg)	Remark
31.94	35.27	-4.73	40	50.93	16.80	0.19	32.65	100	26	Peak
145.43	28.31	-15.19	43.5	49.75	10.45	0.67	32.56	-	-	Peak
298.69	25.51	-20.49	46	44.11	12.98	0.81	32.39	-	-	Peak
349.13	22.31	-23.69	46	39.26	14.51	0.90	32.36	-	-	Peak
598.42	22.19	-23.81	46	34.39	18.64	1.18	32.02	-	-	Peak
769.14	21.63	-24.37	46	32.27	19.8	1.49	31.93	-	-	Peak
2422	101.03	-	-	103.04	32.00	2.66	36.67	100	253	Peak
2422	90.91	-	-	92.92	32.00	2.66	36.67	100	253	Average
4844	50.01	-23.99	74	47.38	34.06	3.78	35.21	100	102	Peak
7266	50.32	-23.68	74	44.53	35.71	4.72	34.64	100	91	Peak



Test Mode :	2.4GHz 802.11n HT40	Temperature :	22~23°C
Test Channel :	06	Relative Humidity :	42~43%
Test Engineer :	Star Wei	Polarization :	Horizontal
Remark :	1. 2437 MHz is fundamental signal which can be ignored. 2. Average measurement was not performed if peak level went lower than the average limit.		

Frequency (MHz)	Level (dBμV/m)	Over Limit (dB)	Limit Line (dBμV/m)	Read Level (dBμV)	Antenna Factor (dB)	Cable Loss (dB)	Preamp Factor (dB)	Ant Pos (cm)	Table Pos (deg)	Remark
2437	98.36	-	-	100.34	32.03	2.66	36.67	177	222	Peak
2437	87.96	-	-	89.94	32.03	2.66	36.67	177	222	Average
4874	49.90	-24.10	74	47.27	34.02	3.78	35.17	100	175	Peak
7312	50.67	-23.33	74	44.87	35.72	4.73	34.65	100	58	Peak

Test Mode :	2.4GHz 802.11n HT40	Temperature :	22~23°C
Test Channel :	06	Relative Humidity :	42~43%
Test Engineer :	Star Wei	Polarization :	Vertical
Remark :	1. 2437 MHz is fundamental signal which can be ignored. 2. Average measurement was not performed if peak level went lower than the average limit.		

Frequency (MHz)	Level (dBμV/m)	Over Limit (dB)	Limit Line (dBμV/m)	Read Level (dBμV)	Antenna Factor (dB)	Cable Loss (dB)	Preamp Factor (dB)	Ant Pos (cm)	Table Pos (deg)	Remark
2437	99.94	-	-	101.92	32.03	2.66	36.67	100	270	Peak
2437	89.63	-	-	91.61	32.03	2.66	36.67	100	270	Average
4874	49.29	-24.71	74	46.66	34.02	3.78	35.17	100	52	Peak
7312	50.00	-24.00	74	44.20	35.72	4.73	34.65	100	41	Peak



Test Mode :	2.4GHz 802.11n HT40	Temperature :	22~23°C
Test Channel :	09	Relative Humidity :	42~43%
Test Engineer :	Star Wei	Polarization :	Horizontal
Remark :	1. 2452 MHz is fundamental signal which can be ignored. 2. Average measurement was not performed if peak level went lower than the average limit.		

Frequency (MHz)	Level (dBμV/m)	Over Limit (dB)	Limit Line (dBμV/m)	Read Level (dBμV)	Antenna Factor (dB)	Cable Loss (dB)	Preamp Factor (dB)	Ant Pos (cm)	Table Pos (deg)	Remark
2452	102.95	-	-	104.92	32.03	2.67	36.67	111	313	Peak
2452	91.47	-	-	93.44	32.03	2.67	36.67	111	313	Average
4904	49.03	-24.97	74	46.38	33.99	3.78	35.12	100	306	Peak
7356	50.62	-23.38	74	44.8	35.74	4.76	34.68	100	51	Peak

Test Mode :	2.4GHz 802.11n HT40	Temperature :	22~23°C
Test Channel :	09	Relative Humidity :	42~43%
Test Engineer :	Star Wei	Polarization :	Vertical
Remark :	1. 2452 MHz is fundamental signal which can be ignored. 2. Average measurement was not performed if peak level went lower than the average limit.		

Frequency (MHz)	Level (dBμV/m)	Over Limit (dB)	Limit Line (dBμV/m)	Read Level (dBμV)	Antenna Factor (dB)	Cable Loss (dB)	Preamp Factor (dB)	Ant Pos (cm)	Table Pos (deg)	Remark
2452	101.55	-	-	103.52	32.03	2.67	36.67	100	266	Peak
2452	90.51	-	-	92.48	32.03	2.67	36.67	100	266	Average
4904	50.43	-23.57	74	47.78	33.99	3.78	35.12	100	201	Peak
7356	50.15	-23.85	74	44.33	35.74	4.76	34.68	100	195	Peak



3.6 AC Conducted Emission Measurement

3.6.1 Limit of AC Conducted Emission

For equipment that is designed to be connected to the public utility (AC) power line, the radio frequency voltage that is conducted back onto the AC power line on any frequency or frequencies within the band 150 kHz to 30 MHz shall not exceed the limits in the following table.

Frequency of Emission (MHz)	Conducted Limit (dB μ V)	
	Quasi-Peak	Average
0.15-0.5	66 to 56*	56 to 46*
0.5-5	56	46
5-30	60	50

*Decreases with the logarithm of the frequency.

3.6.2 Measuring Instruments

The measuring equipment is listed in the section 4 of this test report.

3.6.3 Test Procedures

1. The EUT was placed 0.4 meter from the conducting wall of the shielding room, and it was kept at least 80 centimeters from any other grounded conducting surface.
2. Connect EUT to the power mains through a line impedance stabilization network (LISN).
3. All the support units are connecting to the other LISN.
4. The LISN provides 50 ohm coupling impedance for the measuring instrument.
5. The FCC states that a 50 ohm, 50 microhenry LISN should be used.
6. Both sides of AC line were checked for maximum conducted interference.
7. The frequency range from 150 kHz to 30 MHz was searched.
8. Set the test-receiver system to Peak Detect Function and specified bandwidth with Maximum Hold Mode.

3.6.4 Test Setup

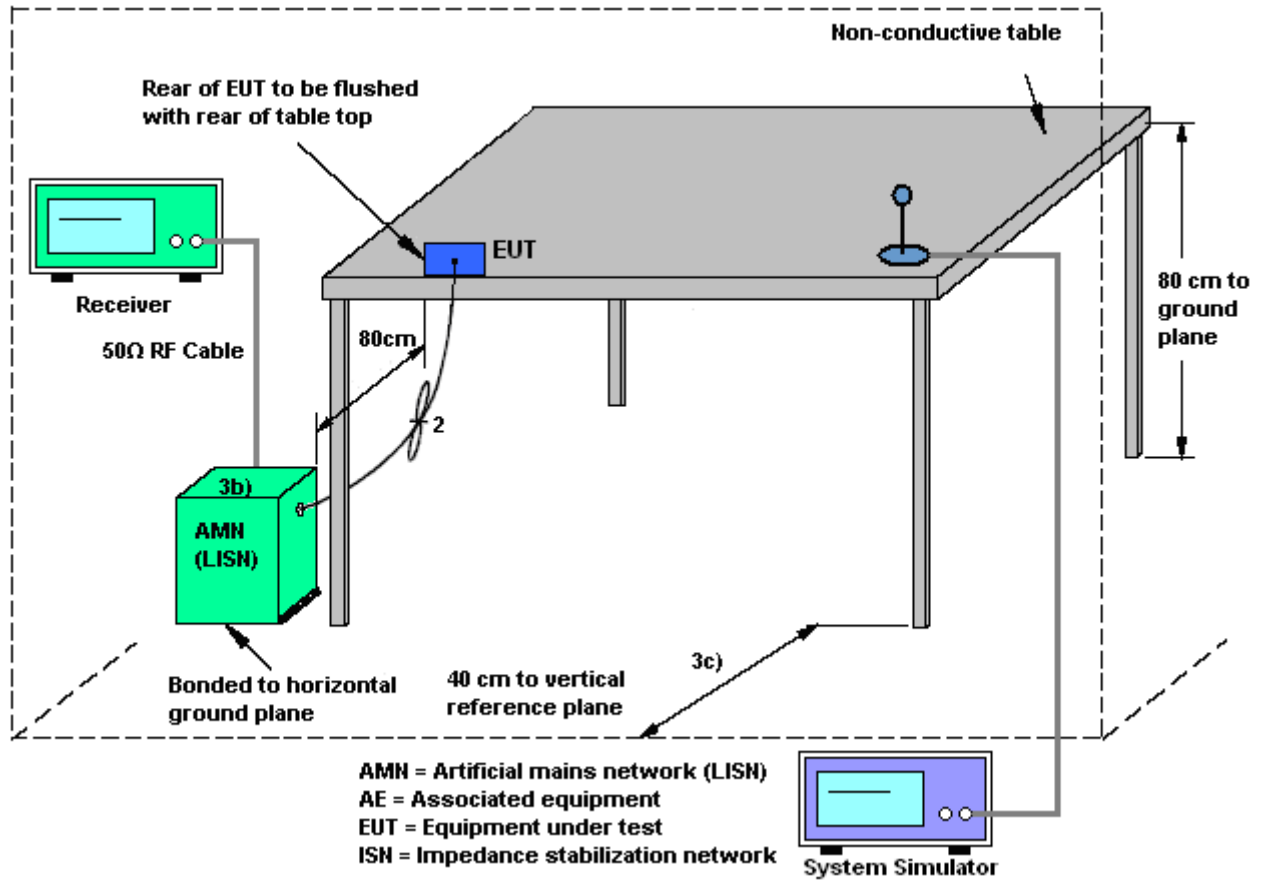



3.6.5 Test Result of AC Conducted Emission

Test Mode :	Mode 1	Temperature :	22~24°C
Test Engineer :	Eligah Wang	Relative Humidity :	37~39%
Test Voltage :	120Vac / 60Hz	Phase :	Line
Function Type :	GSM850 Idle + Bluetooth Link + WLAN Link + USB Cable (Charging from Adapter) + Earphone		

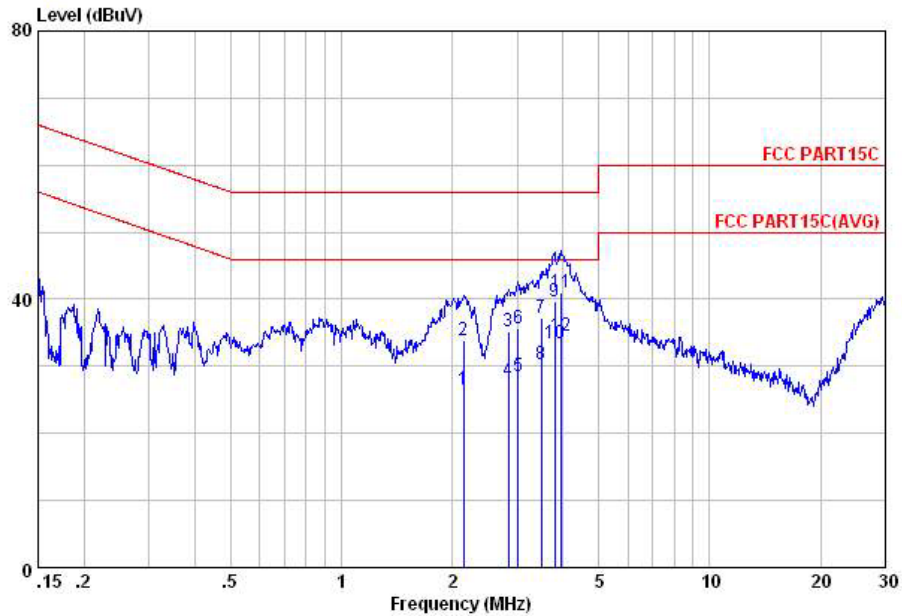

Site : C001-KS
 Condition: FCC PART15C LISN-L20130306 LINE

	Freq	Level	Over	Limit	Read	LISN	Cable	Remark
	MHz	dBuV	Limit	Line	Level	Factor	Loss	
		dBuV	dB	dBuV	dBuV	dB	dB	
1	2.14	26.60	-19.40	46.00	16.31	0.10	10.19	Average
2	2.14	33.90	-22.10	56.00	23.61	0.10	10.19	QP
3	2.84	35.14	-20.86	56.00	24.79	0.13	10.22	QP
4	2.84	27.94	-18.06	46.00	17.59	0.13	10.22	Average
5	3.03	28.46	-17.54	46.00	18.10	0.14	10.22	Average
6	3.03	35.66	-20.34	56.00	25.30	0.14	10.22	QP
7	3.49	37.30	-18.70	56.00	26.90	0.17	10.23	QP
8	3.49	30.20	-15.80	46.00	19.80	0.17	10.23	Average
9	3.80	39.72	-16.28	56.00	29.30	0.18	10.24	QP
10	3.80	33.32	-12.68	46.00	22.90	0.18	10.24	Average
11	3.94	41.02	-14.98	56.00	30.60	0.18	10.24	QP
12	3.94	34.52	-11.48	46.00	24.10	0.18	10.24	Average



Test Mode :	Mode 1	Temperature :	22~24°C
Test Engineer :	Eligah Wang	Relative Humidity :	37~39%
Test Voltage :	120Vac / 60Hz	Phase :	Neutral
Function Type :	GSM850 Idle + Bluetooth Link + WLAN Link + USB Cable (Charging from Adapter) + Earphone		

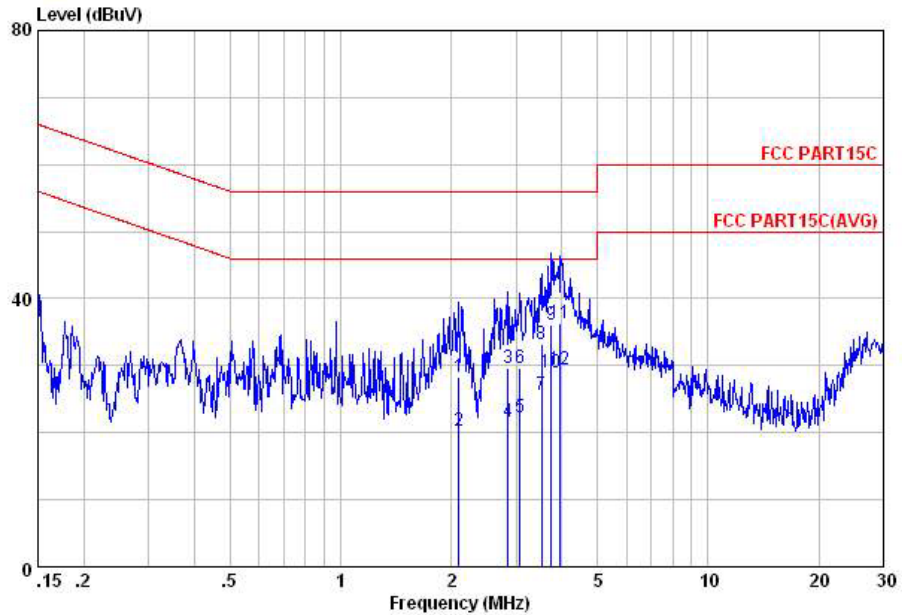

Site : C001-KS
Condition: FCC PART15C LISN-M20130306 NEUTRAL

	Freq	Level	Over	Limit	Read	LISN	Cable	Remark
	MHz	dBuV	Limit	Line	Level	Factor	Loss	
			dB	dBuV	dBuV	dB	dB	
1	2.10	28.19	-27.81	56.00	17.90	0.10	10.19	QP
2	2.10	20.19	-25.81	46.00	9.90	0.10	10.19	Average
3	2.85	29.65	-26.35	56.00	19.30	0.13	10.22	QP
4	2.85	21.65	-24.35	46.00	11.30	0.13	10.22	Average
5	3.07	22.27	-23.73	46.00	11.91	0.14	10.22	Average
6	3.07	29.67	-26.33	56.00	19.31	0.14	10.22	QP
7	3.53	25.70	-20.30	46.00	15.30	0.17	10.23	Average
8	3.53	33.30	-22.70	56.00	22.90	0.17	10.23	QP
9	3.74	36.01	-19.99	56.00	25.59	0.18	10.24	QP
10	3.74	29.01	-16.99	46.00	18.59	0.18	10.24	Average
11	3.96	36.32	-19.68	56.00	25.90	0.18	10.24	QP
12	3.96	29.32	-16.68	46.00	18.90	0.18	10.24	Average



3.7 Antenna Requirements

3.7.1 Standard Applicable

If directional gain of transmitting antennas is greater than 6dBi, the power shall be reduced by the same level in dB comparing to gain minus 6dBi. For the fixed point-to-point operation, the power shall be reduced by one dB for every 3 dB that the directional gain of the antenna exceeds 6 dBi. The use of a permanently attached antenna or of an antenna that uses a unique coupling to the intentional radiator shall be considered sufficient to comply with the FCC rule.

3.7.2 Antenna Anti-Replacement Construction

An embedded-in antenna design is used.

3.7.3 Antenna Gain

The antenna peak gain of EUT is less than 6 dBi. Therefore, it is not necessary to reduce maximum peak output power limit.



4 List of Measuring Equipment

Instrument	Manufacturer	Model No.	Serial No.	Characteristics	Calibration Date	Test Date	Due Date	Remark
Spectrum Analyzer	R&S	FSV30	101338	9kHz~30GHz	May 04, 2014	Jun. 27, 2014~ Jun. 29, 2014	May 03, 2015	Conducted (TH01-KS)
Pulse Power Sensor	Anritsu	MA2411B	0917070	30MHz~40GHz	Feb. 27, 2014	Jun. 27, 2014~ Jun. 29, 2014	Feb. 26, 2015	Conducted (TH01-KS)
Power Meter	Anritsu	ML2495A	1005002	50MHz Bandwidth	Feb. 27, 2014	Jun. 27, 2014~ Jun. 29, 2014	Feb. 26, 2015	Conducted (TH01-KS)
EMI Test Receiver	R&S	ESCI	100534	9kHz~3GHz	Nov. 05, 2013	Jul. 02, 2014	Nov. 04, 2014	Radiation (03CH01-KS)
Spectrum Analyzer	R&S	FSP30	101399	9kHz~30GHz	May 04, 2014	Jul. 02, 2014	May 03, 2015	Radiation (03CH01-KS)
Loop Antenna	R&S	HFH2-Z2	100321	9kHz~30MHz	Oct. 09, 2013	Jul. 02, 2014	Oct. 08, 2014	Radiation (03CH01-KS)
Bilog Antenna	SCHAFFNER	CBL6112D	23182	25MHz~2GHz	Jan. 08, 2014	Jul. 02, 2014	Jan. 07, 2015	Radiation (03CH01-KS)
Double Ridge Horn Antenna	ETS-Lindgren	3117	75959	1GHz~18GHz	Jan. 08, 2014	Jul. 02, 2014	Jan. 07, 2015	Radiation (03CH01-KS)
SHF-EHF Horn	Schwarzbeck	BBHA 9170	BBHA1702 49	15GHz~40GHz	Mar. 10, 2014	Jul. 02, 2014	Mar. 09, 2015	Radiation (03CH01-KS)
Amplifier	com-power	PA-103A	161073	1MHz~1GHz	May 04, 2014	Jul. 02, 2014	May 03, 2015	Radiation (03CH01-KS)
Amplifier	Agilent	8449B	3008A023 71	1GHz~26.5GHz	Dec. 10, 2013	Jul. 02, 2014	Dec. 09, 2014	Radiation (03CH01-KS)
AC Power Source	Chroma	61601	F1040900 04	N/A	NCR	Jul. 02, 2014	NCR	Radiation (03CH01-KS)
Turn Table	MF	MF7802	N/A	0~360 degree	NCR	Jul. 02, 2014	NCR	Radiation (03CH01-KS)
Antenna Mast	MF	MF7802	N/A	1 m~4 m	NCR	Jul. 02, 2014	NCR	Radiation (03CH01-KS)
EMI Receiver	R&S	ESCI7	100768	9kHz~7GHz;	May 04, 2014	Jul. 02, 2014	May 03, 2015	Conduction (CO01-KS)
AC LISN	MessTec	AN3016	060103	9kHz~30MHz	Dec. 10, 2013	Jul. 02, 2014	Dec. 09, 2014	Conduction (CO01-KS)
AC LISN (for auxiliary equipment)	MessTec	AN3016	060105	9kHz~30MHz	Dec. 10, 2013	Jul. 02, 2014	Dec. 09, 2014	Conduction (CO01-KS)
AC Power Source	Chroma	61602	ABP00000 0811	AC 0V~300V, 45Hz~1000Hz	Nov. 12, 2013	Jul. 02, 2014	Nov. 11, 2014	Conduction (CO01-KS)



5 Uncertainty of Evaluation

Uncertainty of Conducted Emission Measurement (150kHz ~ 30MHz)

Measuring Uncertainty for a Level of Confidence of 95% ($U = 2Uc(y)$)	2.3
---	-----

Uncertainty of Radiated Emission Measurement (30 MHz ~ 1000 MHz)

Measuring Uncertainty for a Level of Confidence of 95% ($U = 2Uc(y)$)	2.5
---	-----