

# FCC RF Test Report

APPLICANT : Acer Incorporated  
EQUIPMENT : Smart HandHeld  
BRAND NAME : Acer  
MODEL NAME : Z160  
MARKETING NAME : Liquid Z4  
FCC ID : HLZDMZ160  
STANDARD : FCC Part 15 Subpart C §15.247  
CLASSIFICATION : (DTS) Digital Transmission System

The product was received on Feb. 18, 2014 and testing was completed on Mar. 20, 2014. We, SPORTON INTERNATIONAL (KUNSHAN) INC., would like to declare that the tested sample has been evaluated in accordance with the procedures and shown to be compliant with the applicable technical standards.

The test results in this report apply exclusively to the tested model / sample. Without written approval of SPORTON INTERNATIONAL (KUNSHAN) INC., the test report shall not be reproduced except in full.



Reviewed by: Joseph Lin / Supervisor

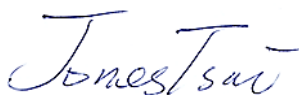

Approved by: Jones Tsai / Manager



**SPORTON INTERNATIONAL (KUNSHAN) INC.**  
**No. 3-2, PingXiang Road, Kunshan, Jiangsu Province, P.R.C.**



## TABLE OF CONTENTS

<b>1</b>	<b>GENERAL DESCRIPTION.....</b>	<b>5</b>
1.1	Applicant.....	5
1.2	Manufacturer.....	5
1.3	Feature of Equipment Under Test.....	5
1.4	Product Specification of Equipment Under Test.....	5
1.5	Modification of EUT.....	6
1.6	Testing Site.....	6
1.7	Applied Standards.....	6
<b>2</b>	<b>TEST CONFIGURATION OF EQUIPMENT UNDER TEST.....</b>	<b>7</b>
2.1	Descriptions of Test Mode.....	7
2.2	Test Mode.....	8
2.3	Connection Diagram of Test System.....	9
2.4	Support Unit used in test configuration and system.....	10
2.5	EUT Operation Test Setup.....	10
2.6	Measurement Results Explanation Example.....	10
<b>3</b>	<b>TEST RESULT.....</b>	<b>11</b>
3.1	6dB and 99% Bandwidth Measurement.....	11
3.2	Peak Output Power Measurement.....	16
3.3	Power Spectral Density Measurement.....	18
3.4	Conducted Band Edges and Spurious Emission Measurement.....	24
3.5	Radiated Band Edges and Spurious Emission Measurement.....	32
3.6	AC Conducted Emission Measurement.....	41
3.7	Antenna Requirements.....	45
<b>4</b>	<b>LIST OF MEASURING EQUIPMENT.....</b>	<b>46</b>
<b>5</b>	<b>UNCERTAINTY OF EVALUATION.....</b>	<b>47</b>
<b>APPENDIX A. SETUP PHOTOGRAPHS</b>		



## REVISION HISTORY

REPORT NO.	VERSION	DESCRIPTION	ISSUED DATE
FR421813B	Rev. 01	Initial issue of report	Apr. 01, 2014

**SUMMARY OF TEST RESULT**

Report Section	FCC Rule	IC Rule	Description	Limit	Result	Remark
3.1	15.247(a)(2)	RSS-210 A8.2(a)	6dB Bandwidth	$\geq 0.5\text{MHz}$	Pass	-
3.1	-	RSS-Gen 4.6.1	99% Bandwidth	-	Pass	-
3.2	15.247(b)(1)	RSS-210 A8.1(b)	Peak Output Power	$\leq 30\text{dBm}$	Pass	-
3.3	15.247(e)	RSS-210 A8.2(b)	Power Spectral Density	$\leq 8\text{dBm}$	Pass	-
3.4	15.247(d)	RSS-210 A8.5	Conducted Band Edges and Spurious Emission	$\leq 20\text{dBc}$	Pass	-
3.5	15.247(d)	RSS-210 A8.5	Radiated Band Edges and Spurious Emission	15.209(a) & 15.247(d)	Pass	Under limit 4.95 dB at 94.990 MHz
3.6	15.207	RSS-Gen 7.2.4	AC Conducted Emission	15.207(a)	Pass	Under limit 17.91 dB at 1.950 MHz
3.7	15.203 & 15.247(b)	RSS-210 A8.4	Antenna Requirement	N/A	Pass	-

# 1 General Description

## 1.1 Applicant

**Acer Incorporated**

8F., No. 88, Sec. 1, Xintai 5th Rd., Xizhi Dist., New Taipei City 22181, Taiwan (R.O.C)

## 1.2 Manufacturer

**Shanghai Sunrise Simcom Limited**

No. 888, Shengli Rd., Qingpu, Shanghai, P.R.China 201700

## 1.3 Feature of Equipment Under Test

Product Feature	
<b>Equipment</b>	Smart HandHeld
<b>Brand Name</b>	Acer
<b>Model Name</b>	Z160
<b>Marketing Name</b>	Liquid Z4
<b>FCC ID</b>	HLZDMZ160
<b>EUT supports Radios application</b>	GSM/GPRS/EGPRS/WCDMA/HSPA/HSPA+(Downlink Only) WLAN2.4GHz 802.11b/g/n HT20/HT40/ Bluetooth v3.0 + EDR/Bluetooth v4.0 LE
<b>EUT Stage</b>	Identical Prototype

**Remark:** The above EUT's information was declared by manufacturer. Please refer to the specifications or user's manual for more detailed description.

## 1.4 Product Specification of Equipment Under Test

Product Specification subjective to this standard	
<b>Tx/Rx Frequency Range</b>	2402 MHz ~ 2480 MHz
<b>Number of Channels</b>	40
<b>Carrier Frequency of Each Channel</b>	40 Channel(37 hopping + 3 advertising channel)
<b>Maximum Output Power to Antenna</b>	1.08 dBm (0.0013 W)
<b>99% Occupied Bandwidth</b>	1.02MHz
<b>Antenna Type</b>	PIFA Antenna with gain -0.40 dBi
<b>Type of Modulation</b>	GFSK



### 1.5 Modification of EUT

No modifications are made to the EUT during all test items.

### 1.6 Testing Site

<b>Test Site</b>	SPORTON INTERNATIONAL (KUNSHAN) INC.			
<b>Test Site Location</b>	No. 3-2, PingXiang Road, Kunshan, Jiangsu Province, P.R.C. TEL: +86-0512-5790-0158 FAX: +86-0512-5790-0958			
<b>Test Site No.</b>	<b>Sporton Site No.</b>			<b>FCC/IC Registration No.</b>
	TH01-KS	03CH01-KS	CO01-KS	149928/4086E-1

**Note:** The test site complies with ANSI C63.4 2003 requirement.

### 1.7 Applied Standards

According to the specifications of the manufacturer, the EUT must comply with the requirements of the following standards:

- ♦ FCC Part 15 Subpart C §15.247
- ♦ FCC KDB Publication No. 558074 D01 DTS Meas. Guidance v03r01
- ♦ ANSI C63.4-2003
- ♦ IC RSS-210 Issue 8
- ♦ IC RSS-Gen Issue 3
- ♦ NOTICE 2012-DRS0126

**Remark:**

1. All test items were verified and recorded according to the standards and without any deviation during the test.
2. This EUT has also been tested and complied with the requirements of FCC Part 15, Subpart B, recorded in a separate test report.

## 2 Test Configuration of Equipment Under Test

### 2.1 Descriptions of Test Mode

The RF output power was recorded in the following table:

Channel	Frequency	Bluetooth v4.0 LE RF Output Power	
		Data Rate / Modulation	
		GFSK	
		1Mbps	
Ch00	2402MHz	0.73 dBm	
Ch19	2440MHz	1.08 dBm	
Ch39	2480MHz	1.00 dBm	

- a. The EUT has been associated with peripherals and configuration operated in a manner tended to maximize its emission characteristics in a typical application. Frequency range investigated: conduction (150 kHz to 30 MHz), radiation (9 kHz to the 10th harmonic of the highest fundamental frequency or to 40 GHz, whichever is lower). Pre-scanned tests, X, Y, Z in three orthogonal panels to determine the final configuration (Z plane as worst plane) from all possible combinations.
- b. AC power line Conducted Emission was tested under maximum output power.

## 2.2 Test Mode

The following summary table is showing all test modes to demonstrate in compliance with the standard.

Summary table of Test Cases	
Test Item	Data Rate / Modulation
	Bluetooth v4.0 LE / GFSK
<b>Conducted TCs</b>	Mode 1: Bluetooth Tx CH00_2402 MHz_1Mbps Mode 2: Bluetooth Tx CH19_2440 MHz_1Mbps Mode 3: Bluetooth Tx CH39_2480 MHz_1Mbps
<b>Radiated TCs</b>	Mode 1: Bluetooth Tx CH00_2402 MHz_1Mbps Mode 2: Bluetooth Tx CH19_2440 MHz_1Mbps Mode 3: Bluetooth Tx CH39_2480 MHz_1Mbps
<b>AC Conducted Emission</b>	Mode 1: GSM850 Idle + Bluetooth Link + WLAN Link + Earphone + USB Cable (Charging from Adapter)
<b>Remark:</b> For radiated test cases, the tests were performed with adapter, earphone and USB cable.	



## 2.3 Connection Diagram of Test System

### <Bluetooth v4.0 LE Tx Mode>

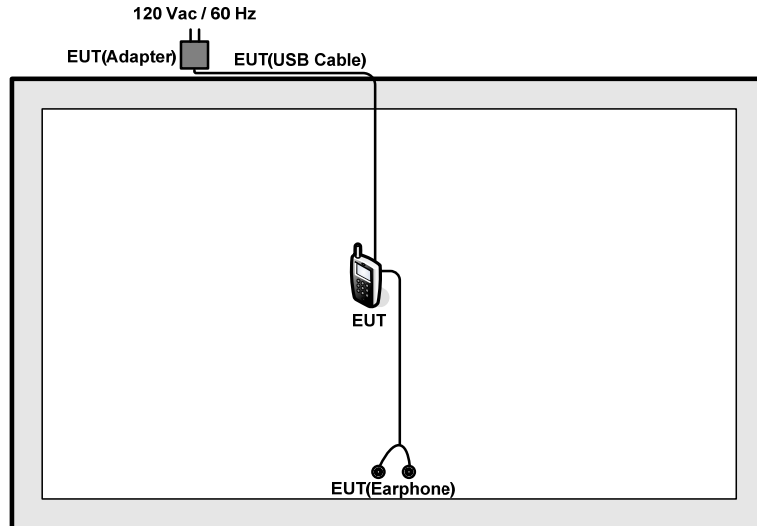

### <AC Conducted Emission Mode>

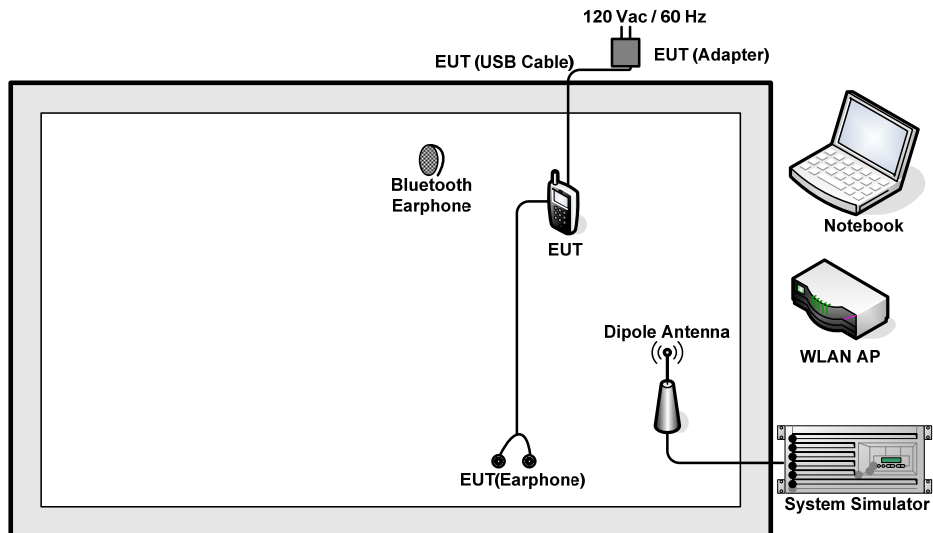

## 2.4 Support Unit used in test configuration and system

Item	Equipment	Trade Name	Model Name	FCC ID	Data Cable	Power Cord
1.	System Simulator	R&S	CMU 200	N/A	N/A	Unshielded, 1.8 m
2.	WLAN AP	D-Link	DIR-855	KA2DIR855A2	N/A	Unshielded, 1.8 m
3.	Notebook	DELL	P08S	FCC DoC	N/A	AC I/P: Unshielded, 1.8 m DC O/P: Shielded, 1.8 m
4.	DC Power Supply	TOPWORD	3303DR	N/A	N/A	Unshielded, 1.8 m
5.	Bluetooth Earphone	Nokia	BH-106	QTLBH-106	N/A	N/A

## 2.5 EUT Operation Test Setup

For Bluetooth v4.0 LE function, the engineering test program was provided and enabled to make EUT continuous transmit/receive.

For AC power line conducted emissions, the EUT was set to connect with the WLAN AP under large package sizes transmission.

## 2.6 Measurement Results Explanation Example

For all conducted test items:

The offset level is set in the spectrum analyzer to compensate the RF cable loss and attenuator factor between EUT conducted output port and spectrum analyzer. With the offset compensation, the spectrum analyzer reading level is exactly the EUT RF output level.

Example:

The spectrum analyzer offset is derived from RF cable loss and attenuator factor.

*Offset = RF cable loss + attenuator factor.*

Following shows an offset computation example with cable loss 6dB and 10dB attenuator.

$$\begin{aligned}
 \text{Offset (dB)} &= \text{RF cable loss (dB)} + \text{attenuator factor (dB)} \\
 &= 6 + 10 = 16 \text{ (dB)}
 \end{aligned}$$

### 3 Test Result

#### 3.1 6dB and 99% Bandwidth Measurement

##### 3.1.1 Limit of 6dB and 99% Bandwidth

The minimum 6 dB bandwidth shall be at least 500 kHz.

##### 3.1.2 Measuring Instruments

The section 4.0 of List of Measuring Equipment of this test report is used for test.

##### 3.1.3 Test Procedures

1. The testing follows FCC KDB Publication No. 558074 D01 DTS Meas. Guidance v03r01.
2. The RF output of EUT was connected to the spectrum analyzer by RF cable and attenuator. The path loss was compensated to the results for each measurement.
3. Set to the maximum power setting and enable the EUT transmit continuously.
4. Make the measurement with the spectrum analyzer's resolution bandwidth (RBW) = 100 kHz. Set the Video bandwidth (VBW) = 300 kHz. In order to make an accurate measurement. The 6 dB bandwidth must be greater than 500 kHz.
5. For 99% Bandwidth Measurement, the spectrum analyzer's resolution bandwidth (RBW) is set 30kHz and set the Video bandwidth (VBW) = 100kHz.
6. Measure and record the results in the test report.

##### 3.1.4 Test Setup

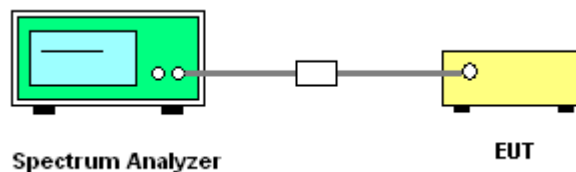



3.1.5 Test Result of 6dB Bandwidth

Test Mode :	Bluetooth v4.0 LE	Temperature :	23~24°C
Test Engineer :	Adonis Li	Relative Humidity :	47~48%

Channel	Frequency (MHz)	6dB Bandwidth (MHz)	6dB Bandwidth Min. Limit (MHz)	Pass/Fail
00	2402	0.672	0.5	Pass
19	2440	0.672	0.5	Pass
39	2480	0.672	0.5	Pass

6 dB Bandwidth Plot on Channel 00

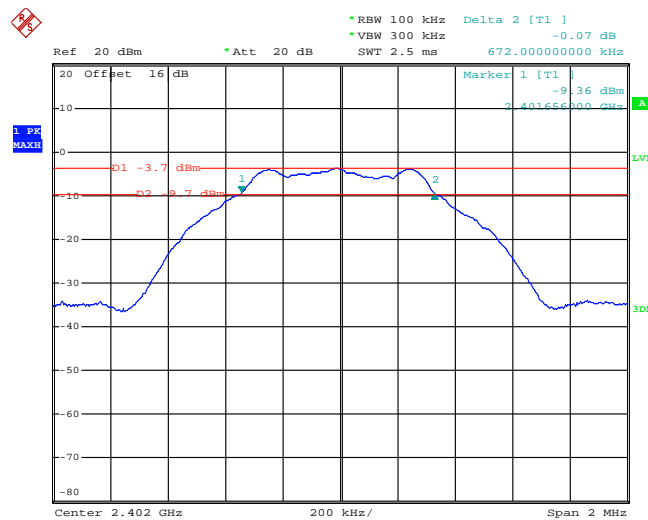

Date: 5.MAR.2014 23:21:12



### 6 dB Bandwidth Plot on Channel 19

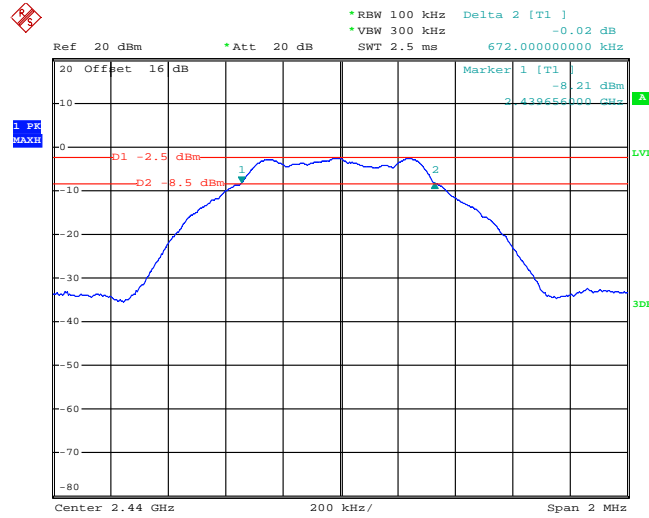

Date: 5.MAR.2014 23:22:22

### 6 dB Bandwidth Plot on Channel 39

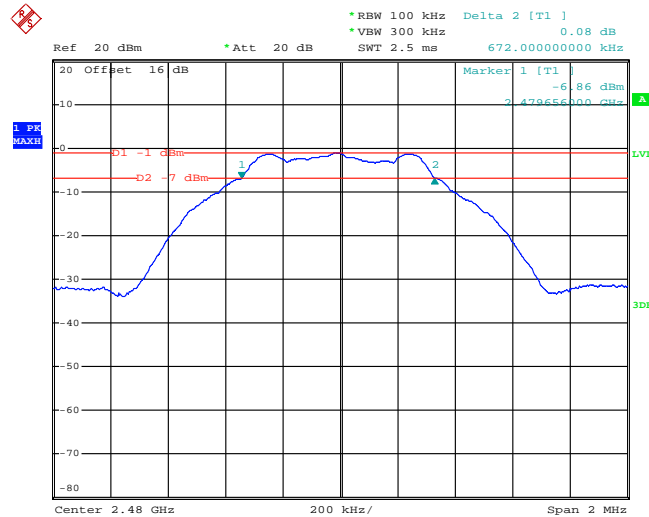

Date: 5.MAR.2014 23:23:20



3.1.6 Test Result of 99% Occupied Bandwidth

Test Mode :	Bluetooth v4.0 LE	Temperature :	23~24°C
Test Engineer :	Adonis Li	Relative Humidity :	47~48%

Channel	Frequency (MHz)	99% Occupied Bandwidth (MHz)
00	2402	1.020
19	2440	1.020
39	2480	1.020

99% Bandwidth Plot on Channel 00

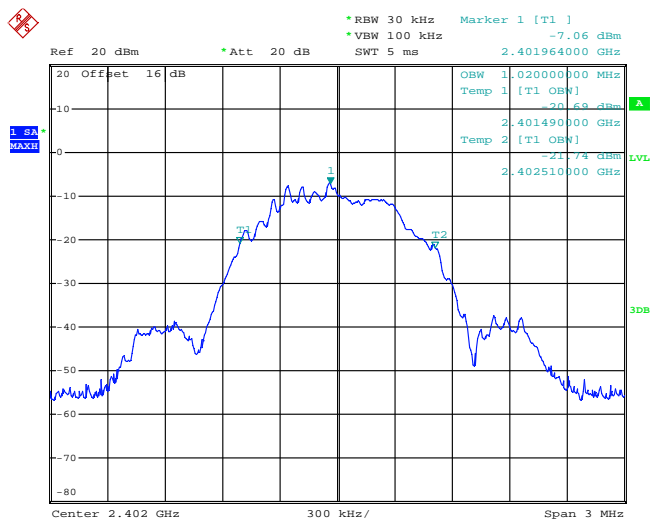

Date: 5.MAR.2014 23:36:17



99% Occupied Bandwidth Plot on Channel 19

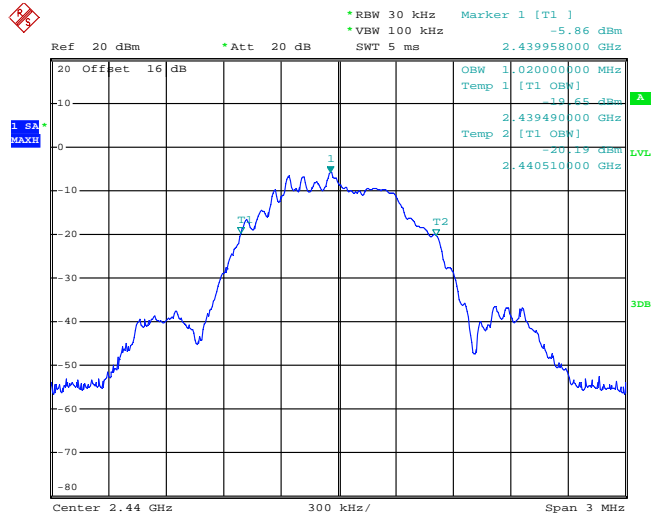

Date: 5.MAR.2014 23:36:40

99% Occupied Bandwidth Plot on Channel 39

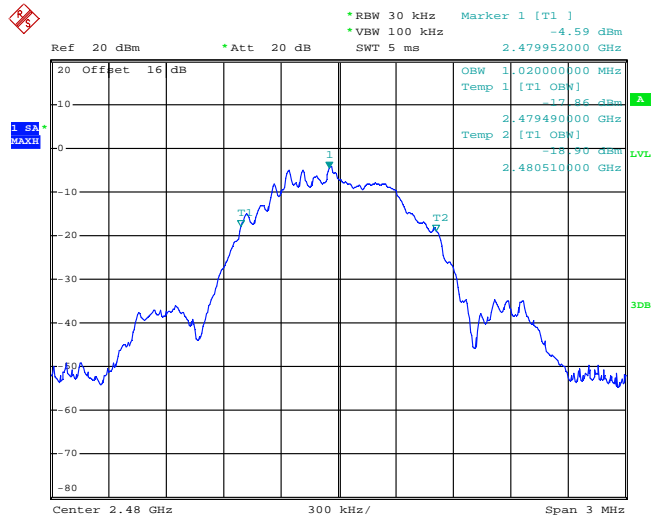

Date: 5.MAR.2014 23:37:05

Note: The occupied channel bandwidth is maintained within the band of operation for all of the modulations.

## 3.2 Peak Output Power Measurement

### 3.2.1 Limit of Peak Output Power

For systems using digital modulation in the 2400-2483.5MHz, the limit for peak output power is 30dBm. If transmitting antenna of directional gain greater than 6dBi is used, the peak output power from the intentional radiator shall be reduced below the above stated value by the amount in dB that the directional gain of the antenna exceeds 6 dBi. In case of point-to-point operation, the limit has to be reduced by 1dB for every 3dB that the directional gain of the antenna exceeds 6dBi.

### 3.2.2 Measuring Instruments

The section 4.0 of List of Measuring Equipment of this test report is used for test.

### 3.2.3 Test Procedures

1. The testing follows the Measurement Procedure of FCC KDB No. 558074 DTS D01 Meas. Guidance v03r01.
2. The RF output of EUT was connected to the power meter by RF cable and attenuator. The path loss was compensated to the results for each measurement.
3. Set to the maximum power setting and enable the EUT transmit continuously.
4. Measure the conducted output power and record the results in the test report.

### 3.2.4 Test Setup

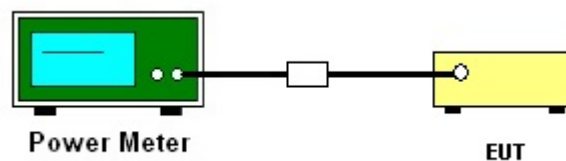





3.2.5 Test Result of Peak Output Power

Test Mode :	Bluetooth v4.0 LE	Temperature :	23~24°C
Test Engineer :	Adonis Li	Relative Humidity :	47~48%

Channel	Frequency (MHz)	RF Power (dBm)		
		GFSK	Max. Limits (dBm)	Pass/Fail
		1 Mbps		
00	2402	0.73	30.00	Pass
19	2440	1.08	30.00	Pass
39	2480	1.00	30.00	Pass

### 3.3 Power Spectral Density Measurement

#### 3.3.1 Limit of Power Spectral Density

The peak power spectral density shall not be greater than 8dBm in any 3kHz band at any time interval of continuous transmission.

#### 3.3.2 Measuring Instruments

The section 4.0 of List of Measuring Equipment of this test report is used for test.

#### 3.3.3 Test Procedures

1. The testing follows Measurement Procedure 10.2 Method PKPSD of FCC KDB Publication No. 558074 D01 DTS Meas. Guidance v03r01
2. The RF output of EUT was connected to the spectrum analyzer by RF cable and attenuator. The path loss was compensated to the results for each measurement.
3. Set to the maximum power setting and enable the EUT transmit continuously.
4. Make the measurement with the spectrum analyzer's resolution bandwidth (RBW) = 3 kHz. Video bandwidth VBW = 10 kHz In order to make an accurate measurement, set the span to 1.5 times DTS Channel Bandwidth. (6dB BW)
5. Detector = peak, Sweep time = auto couple, Trace mode = max hold, Allow trace to fully stabilize. Use the peak marker function to determine the maximum power level.
6. Measure and record the results in the test report.
7. The Measured power density (dBm)/ 100kHz is a reference level and used as 20dBc down limit line for Conducted Band Edges and Conducted Spurious Emission.

#### 3.3.4 Test Setup

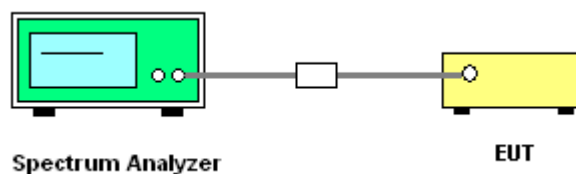

**3.3.5 Test Result of Power Spectral Density**

<b>Test Mode :</b>	Bluetooth v4.0 LE	<b>Temperature :</b>	23~24°C
<b>Test Engineer :</b>	Adonis Li	<b>Relative Humidity :</b>	47~48%

Channel	Frequency (MHz)	Power Density		Max. Limits (dBm/3kHz)	Pass/Fail
		PSD/100kHz (dBm)	PSD/3kHz (dBm)		
00	2402	-3.54	-18.22	8	Pass
19	2440	-2.36	-17.07	8	Pass
39	2480	-0.92	-15.65	8	Pass

**Note:**

1. Measured power density (dBm) has offset with cable loss.
2. The Measured power density (dBm)/ 100kHz is reference level and used as 20dBc down for Conducted Band Edges and Conducted Spurious Emission limit line.



### 3.3.6 Test Result of Power Spectral Density Plots (100kHz)

PSD 100kHz Plot on Channel 00

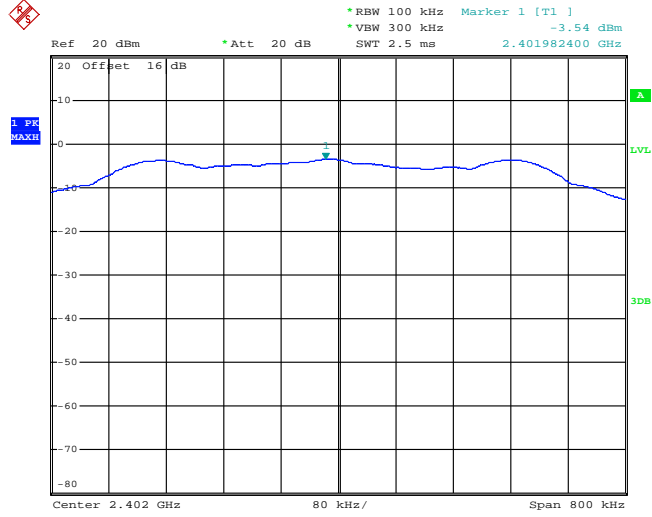

Date: 5.MAR.2014 23:26:13



PSD 100kHz Plot on Channel 19

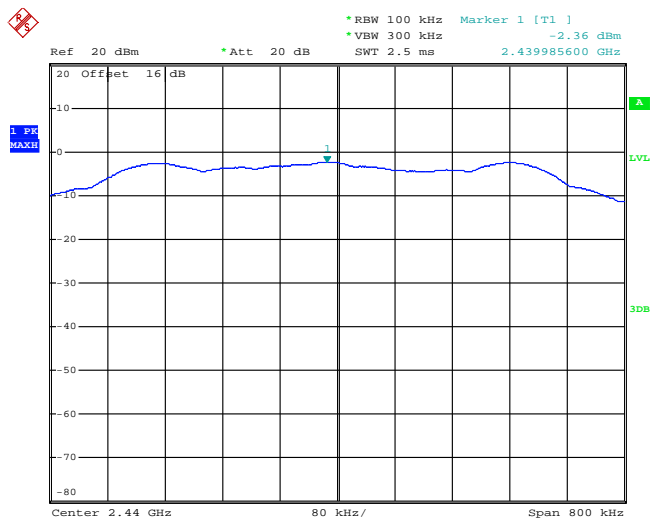

Date: 5.MAR.2014 23:26:49

PSD 100kHz Plot on Channel 39

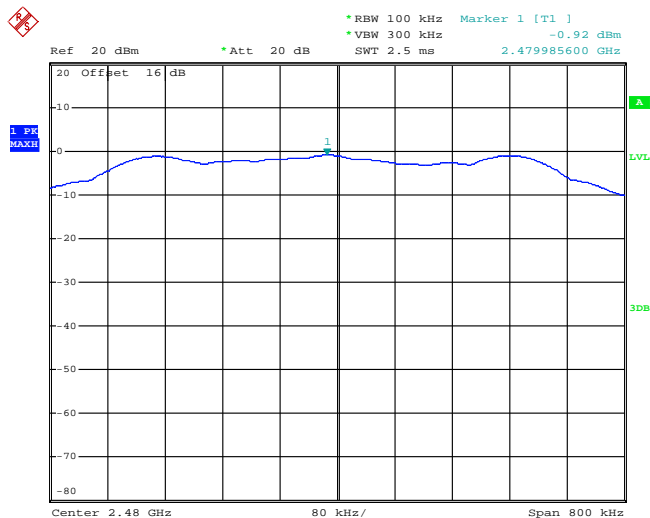

Date: 5.MAR.2014 23:27:18



### 3.3.7 Test Result of Power Spectral Density Plots (3kHz)

PSD 3kHz Plot on Channel 00

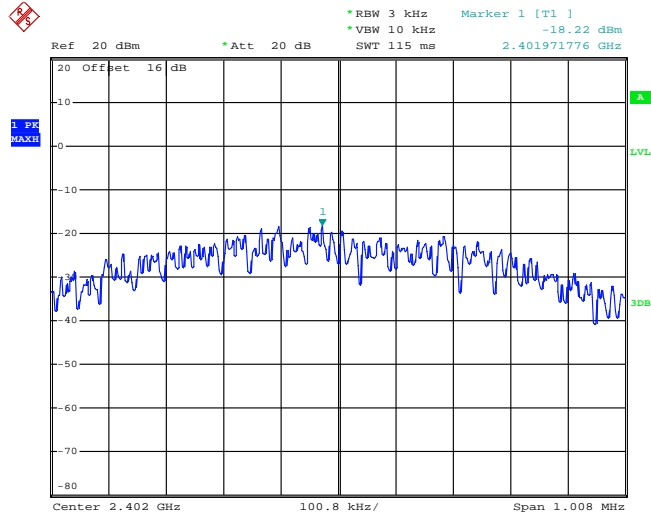

Date: 5.MAR.2014 23:25:31



PSD 3kHz Plot on Channel 19

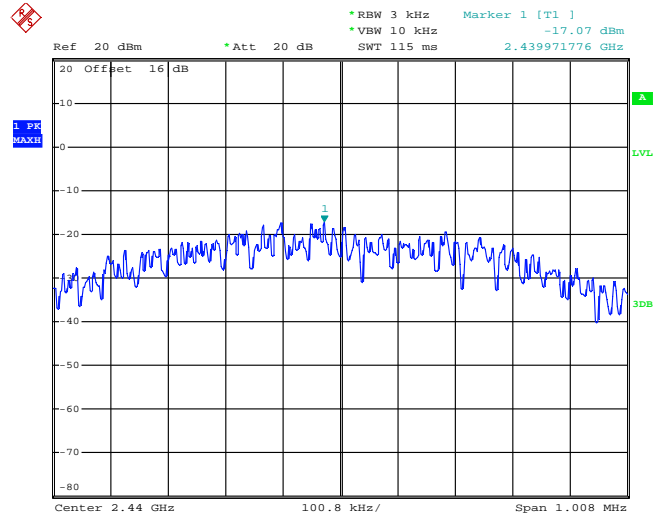

Date: 5.MAR.2014 23:25:09

PSD 3kHz Plot on Channel 39

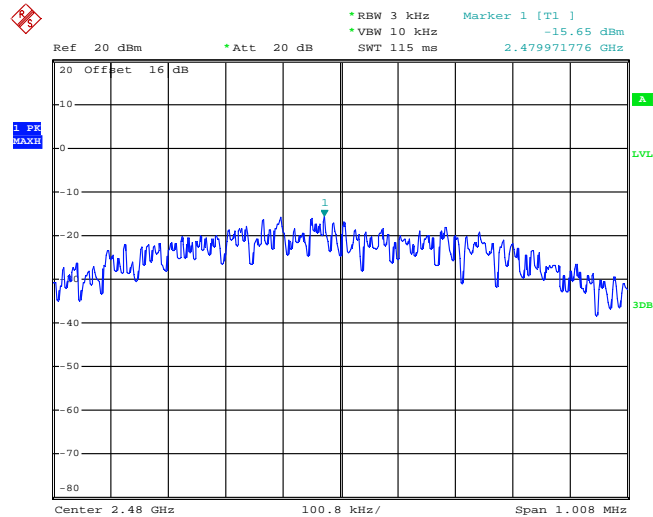

Date: 5.MAR.2014 23:24:44

### 3.4 Conducted Band Edges and Spurious Emission Measurement

#### 3.4.1 Limit of Conducted Band Edges and Spurious Emission

All harmonics/spurious must be at least 20 dB down from the highest emission level within the authorized band.

#### 3.4.2 Measuring Instruments

The section 4.0 of List of Measuring Equipment of this test report is used for test.

#### 3.4.3 Test Procedure

1. The testing follows FCC KDB Publication No. 558074 D01 DTS Meas. Guidance v03r01.
2. The RF output of EUT was connected to the spectrum analyzer by RF cable and attenuator. The path loss was compensated to the results for each measurement.
3. Set to the maximum power setting and enable the EUT transmit continuously.
4. Set RBW = 100 kHz, VBW=300 kHz, Peak Detector. Unwanted Emissions measured in any 100 kHz bandwidth outside of the authorized frequency band shall be attenuated by at least 20 dB relative to the maximum in-band peak PSD level in 100 kHz when maximum peak conducted output power procedure is used. If the transmitter complies with the conducted power limits based on the use of RMS averaging over a time interval, the attenuation required under this paragraph shall be 30 dB instead of 20 dB per 15.247(d).
5. Measure and record the results in the test report.
6. The RF fundamental frequency should be excluded against the limit line in the operating frequency band.

#### 3.4.4 Test Setup

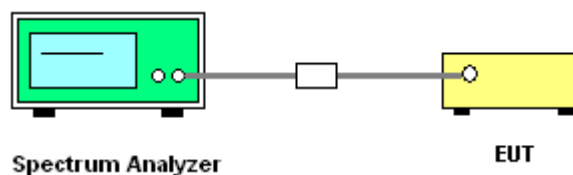



### 3.4.5 Test Result of Conducted Band Edges

Test Mode :	Bluetooth v4.0 LE	Temperature :	23~24°C
Test Channel :	00 and 39	Relative Humidity :	47~48%
		Test Engineer :	Adonis Li

Low Band Edge Plot on Channel 00

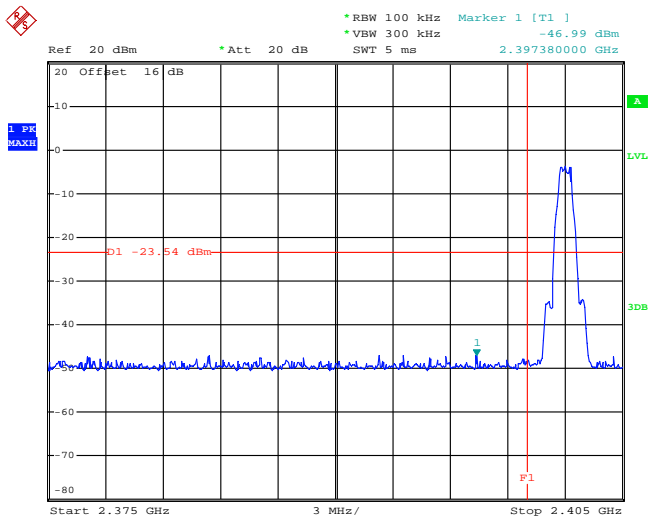

Date: 5.MAR.2014 23:29:45

High Band Edge Plot on Channel 39

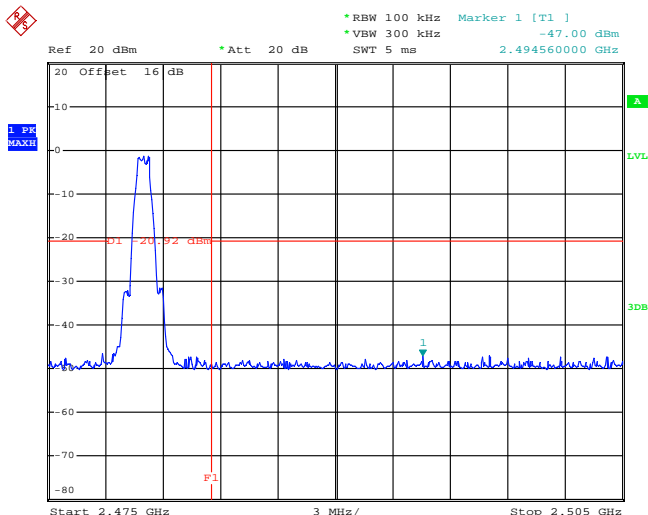

Date: 5.MAR.2014 23:28:57



### 3.4.6 Test Result of Conducted Spurious Emission

Test Mode :	Bluetooth v4.0 LE	Temperature :	23~24°C
Test Channel :	00	Relative Humidity :	47~48%
		Test Engineer :	Adonis Li

Conducted Spurious Emission Plot on Bluetooth LE 1Mbps  
GFSK Channel 00

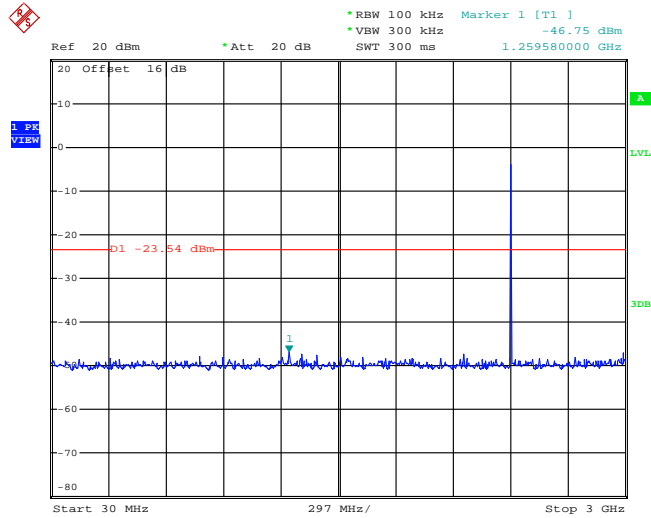

Date: 5.MAR.2014 23:30:54



Conducted Spurious Emission Plot on Bluetooth LE 1Mbps  
GFSK Channel 00

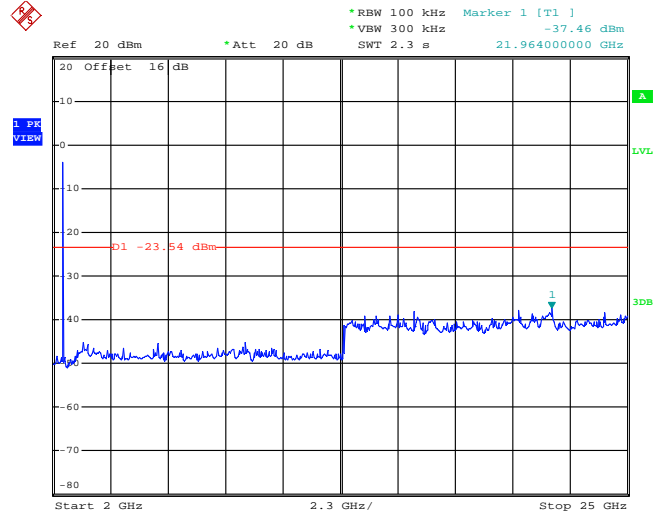

Date: 5.MAR.2014 23:31:25



Test Mode :	Bluetooth v4.0 LE	Temperature :	23~24°C
Test Channel :	19	Relative Humidity :	47~48%
		Test Engineer :	Adonis Li

Conducted Spurious Emission Plot on Bluetooth LE 1Mbps  
GFSK Channel 19

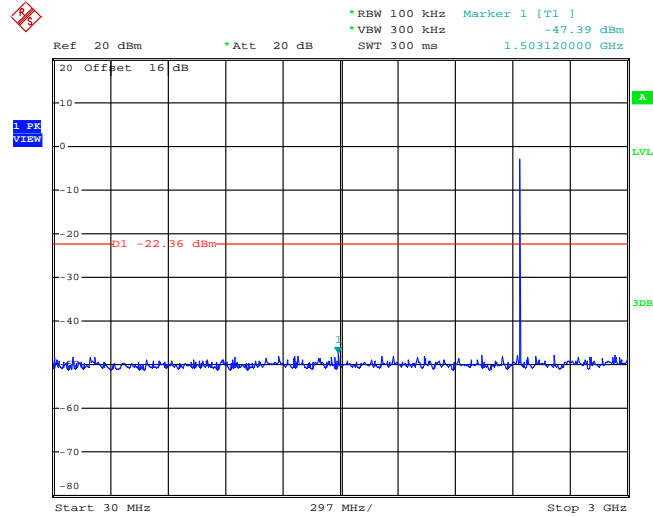

Date: 5.MAR.2014 23:32:10



Conducted Spurious Emission Plot on Bluetooth LE 1Mbps  
GFSK Channel 19

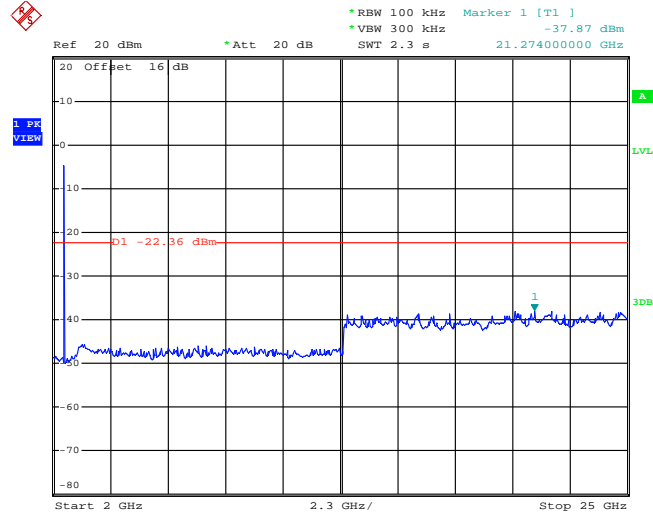

Date: 5.MAR.2014 23:32:57



Test Mode :	Bluetooth v4.0 LE	Temperature :	23~24°C
Test Channel :	39	Relative Humidity :	47~48%
		Test Engineer :	Adonis Li

Conducted Spurious Emission Plot on Bluetooth LE 1Mbps  
GFSK Channel 39

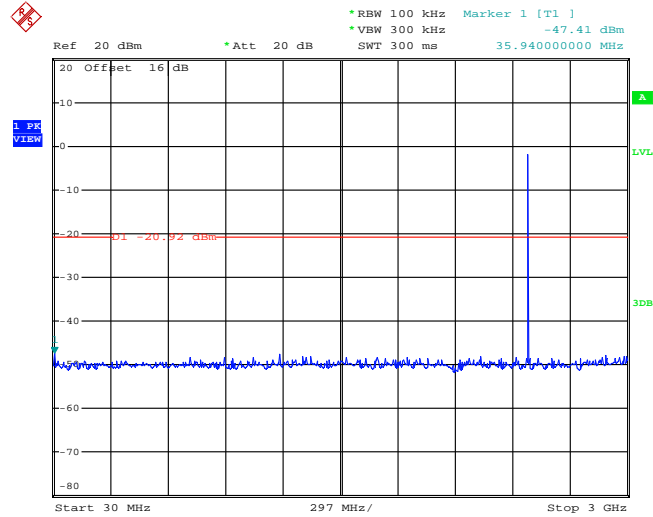

Date: 5.MAR.2014 23:33:56



Conducted Spurious Emission Plot on Bluetooth LE 1Mbps  
GFSK Channel 39

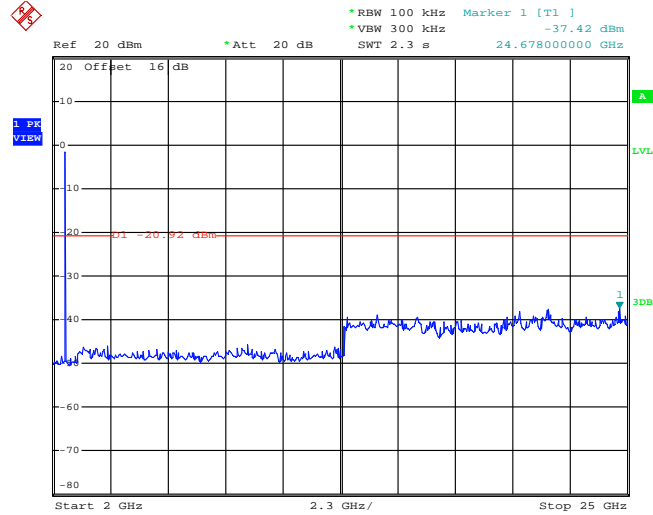

Date: 5.MAR.2014 23:34:22

### 3.5 Radiated Band Edges and Spurious Emission Measurement

#### 3.5.1 Limit of Radiated Band Edges and Spurious Emission

In any 100 kHz bandwidth outside the intentional radiator frequency band, all harmonics/spurious must be at least 20 dB below the highest emission level within the authorized band. If the output power of this device was measured by spectrum analyzer, the attenuation under this paragraph shall be 30 dB instead of 20 dB. In addition, radiated emissions which fall in the restricted bands must also comply with the FCC section 15.209 limits as below.

Frequency (MHz)	Field Strength (microvolts/meter)	Measurement Distance (meters)
0.009 – 0.490	2400/F(kHz)	300
0.490 – 1.705	24000/F(kHz)	30
1.705 – 30.0	30	30
30 – 88	100	3
88 – 216	150	3
216 - 960	200	3
Above 960	500	3

#### 3.5.2 Measuring Instruments

The section 4.0 of List of Measuring Equipment of this test report is used for test.



**3.5.3 Test Procedures**

1. The testing follows FCC KDB Publication No. 558074 D01 DTS Meas. Guidance v03r01.
2. The EUT was arranged to its worst case and then tune the antenna tower (from 1 m to 4 m) and turntable (from 0 degree to 360 degrees) to find the maximum reading. A pre-amp and a high pass filter are used for the test in order to get better signal level.
3. The EUT was placed on a turntable with 0.8 meter above ground.
4. The EUT was set 3 meters from the interference receiving antenna, which was mounted on the top of a variable height antenna tower.
5. Corrected Reading: Antenna Factor + Cable Loss + Read Level - Preamp Factor = Level
6. For measurement below 1GHz, If the emission level of the EUT measured by the peak detector is 3 dB lower than the applicable limit, the peak emission level will be reported. Otherwise, the emission measurement will be repeated using the quasi-peak detector and reported.
7. Use the following spectrum analyzer settings:
  - (1) Span shall wide enough to fully capture the emission being measured;
  - (2) Set RBW=100 kHz for  $f < 1$  GHz;  $VBW \geq RBW$ ; Sweep = auto; Detector function = peak; Trace = max hold;
  - (3) Set RBW = 1 MHz, VBW= 3MHz for  $f \geq 1$  GHz for peak measurement.  
 For average measurement:
    - $VBW = 10$  Hz, when duty cycle is no less than 98 percent.
    - $VBW \geq 1/T$ , when duty cycle is less than 98 percent where T is the minimum transmission duration over which the transmitter is on and is transmitting at its maximum power control level for the tested mode of operation.

Band	Duty Cycle(%)	T(ms)	1/T(kHz)	VBW Setting
Bluetooth v4.0 LE	60.51	0.38	2.63	3kHz

### 3.5.4 Test Setup

For radiated emissions below 30MHz

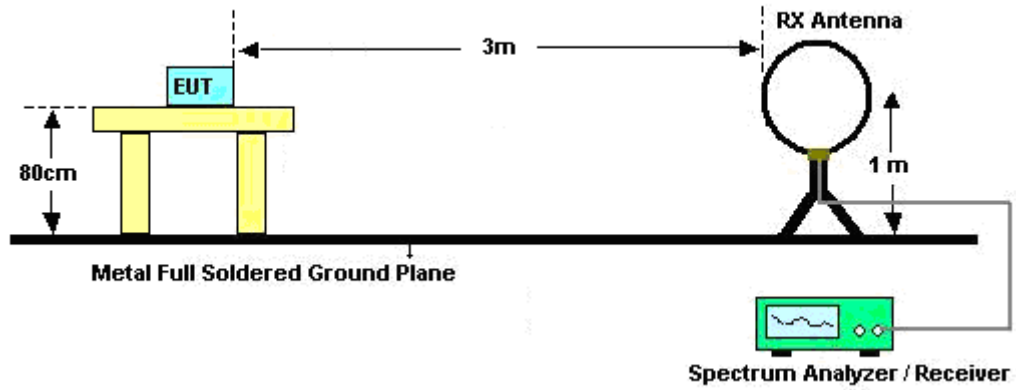

For radiated emissions from 30MHz to 1GHz

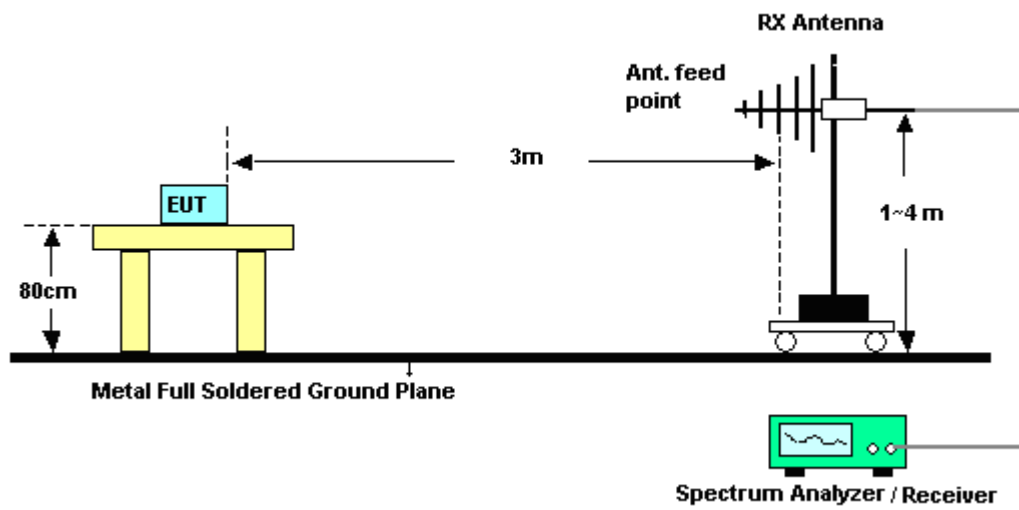

For radiated emissions above 1GHz

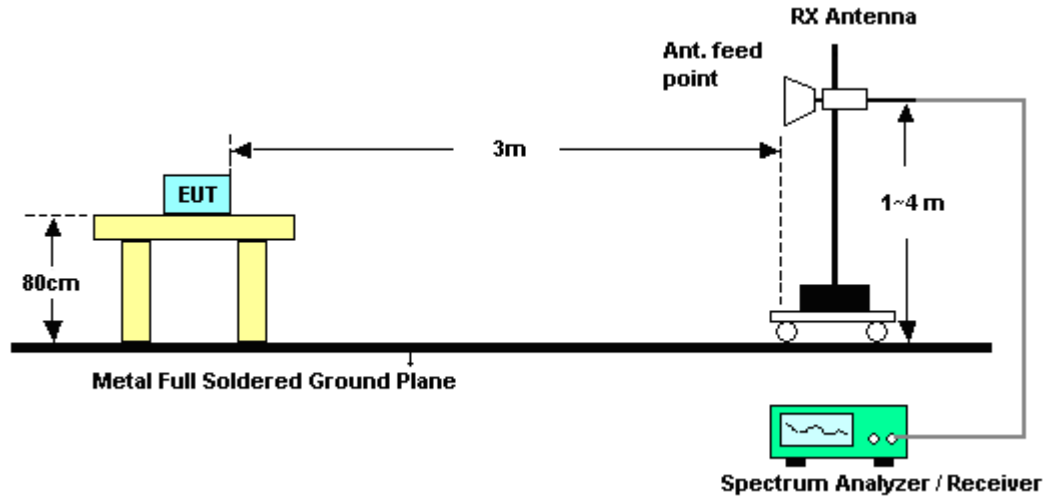

### 3.5.5 Test Results of Radiated Spurious Emissions (9 kHz ~ 30 MHz)

The low frequency, which started from 9 kHz to 30MHz, was pre-scanned and the result which was 20dB lower than the limit line per 15.31(o) was not reported.



3.5.6 Test Result of Radiated Spurious at Band Edges

Test Mode :	Mode 1	Temperature :	22~23°C
Test Channel :	00	Relative Humidity :	40~41%
		Test Engineer :	Jun Liu

ANTENNA POLARITY : HORIZONTAL										
Frequency ( MHz )	Level (dBμV /m )	Over Limit ( dB )	Limit Line (dBμV /m )	Read Level (dBμV)	Antenna Factor ( dB )	Cable Loss ( dB )	Preamp Factor ( dB )	Ant Pos ( cm )	Table Pos ( deg )	Remark
2320.08	47.37	-26.63	74	44.3	32.76	3.54	33.23	169	160	Peak
2380.92	35.63	-18.37	54	32.48	32.83	3.58	33.26	169	160	Average

ANTENNA POLARITY : VERTICAL										
Frequency ( MHz )	Level (dBμV /m )	Over Limit ( dB )	Limit Line (dBμV /m )	Read Level (dBμV)	Antenna Factor ( dB )	Cable Loss ( dB )	Preamp Factor ( dB )	Ant Pos ( cm )	Table Pos ( deg )	Remark
2359.86	48.04	-25.96	74	44.91	32.81	3.57	33.25	100	67	Peak
2353.02	36.01	-17.99	54	32.88	32.81	3.57	33.25	100	67	Average

Test Mode :	Mode 3	Temperature :	22~23°C
Test Channel :	39	Relative Humidity :	40~41%
		Test Engineer :	Jun Liu

ANTENNA POLARITY : HORIZONTAL										
Frequency ( MHz )	Level (dBμV /m )	Over Limit ( dB )	Limit Line (dBμV /m )	Read Level (dBμV)	Antenna Factor ( dB )	Cable Loss ( dB )	Preamp Factor ( dB )	Ant Pos ( cm )	Table Pos ( deg )	Remark
2483.5	59.5	-14.50	74	56.13	33.01	3.65	33.29	196	51	Peak
2483.5	40.63	-13.37	54	37.26	33.01	3.65	33.29	196	51	Average

ANTENNA POLARITY : VERTICAL										
Frequency ( MHz )	Level (dBμV /m )	Over Limit ( dB )	Limit Line (dBμV /m )	Read Level (dBμV)	Antenna Factor ( dB )	Cable Loss ( dB )	Preamp Factor ( dB )	Ant Pos ( cm )	Table Pos ( deg )	Remark
2483.5	56.28	-17.72	74	52.91	33.01	3.65	33.29	155	114	Peak
2483.5	37.44	-16.56	54	34.07	33.01	3.65	33.29	155	114	Average

Note: In order to reduce the noise floor, 6dB EMI filter is used for the radiated band edge measurement.

### 3.5.7 Test Result of Radiated Spurious Emission (30MHz ~ 10<sup>th</sup> Harmonic)

**Note:** Pre-scanned all test modes and only choose the worst case mode recorded in the test report for radiated spurious emission below 1GHz.

<b>Test Mode :</b>	Mode 1	<b>Temperature :</b>	22~23°C
<b>Test Channel :</b>	00	<b>Relative Humidity :</b>	40~41%
<b>Test Engineer :</b>	Jun Liu	<b>Polarization :</b>	Horizontal
<b>Remark :</b>	1. 2402 MHz is fundamental signal which can be ignored. 2. Average measurement was not performed if peak level went lower than the average limit.		

Frequency ( MHz )	Level ( dBμV/m )	Over Limit ( dB )	Limit Line ( dBμV/m )	Read Level ( dBμV )	Antenna Factor ( dB )	Cable Loss ( dB )	Preamp Factor ( dB )	Ant Pos ( cm )	Table Pos ( deg )	Remark
2402	96.69	-	-	93.5	32.86	3.59	33.26	169	160	Peak
2402	95.98	-	-	92.79	32.86	3.59	33.26	169	160	Average
4804	47.79	-26.21	74	41.18	35.17	5.24	33.8	100	154	Peak

**Note:** Other harmonics are lower than background noise.

<b>Test Mode :</b>	Mode 1	<b>Temperature :</b>	22~23°C
<b>Test Channel :</b>	00	<b>Relative Humidity :</b>	40~41%
<b>Test Engineer :</b>	Jun Liu	<b>Polarization :</b>	Vertical
<b>Remark :</b>	1. 2402 MHz is fundamental signal which can be ignored. 2. Average measurement was not performed if peak level went lower than the average limit.		

Frequency ( MHz )	Level ( dBμV/m )	Over Limit ( dB )	Limit Line ( dBμV/m )	Read Level ( dBμV )	Antenna Factor ( dB )	Cable Loss ( dB )	Preamp Factor ( dB )	Ant Pos ( cm )	Table Pos ( deg )	Remark
2402	94.7	-	-	91.51	32.86	3.59	33.26	100	67	Peak
2402	93.79	-	-	90.6	32.86	3.59	33.26	100	67	Average
4804	48.45	-25.55	74	41.84	35.17	5.24	33.8	100	28	Peak

**Note:** Other harmonics are lower than background noise.



<b>Test Mode :</b>	Mode 2	<b>Temperature :</b>	22~23°C
<b>Test Channel :</b>	19	<b>Relative Humidity :</b>	40~41%
<b>Test Engineer :</b>	Jun Liu	<b>Polarization :</b>	Horizontal
<b>Remark :</b>	1. 2440 MHz is fundamental signal which can be ignored. 2. Average measurement was not performed if peak level went lower than the average limit.		

Frequency ( MHz )	Level ( dBμV/m )	Over Limit ( dB )	Limit Line (dBμV/m )	Read Level (dBμV)	Antenna Factor ( dB )	Cable Loss ( dB )	Preamp Factor ( dB )	Ant Pos ( cm )	Table Pos ( deg )	Remark
2440	97.33	-	-	94.03	32.95	3.63	33.28	108	158	Peak
2440	96.58	-	-	93.28	32.95	3.63	33.28	108	158	Average
4880	47.29	-26.71	74	40.63	35.18	5.28	33.8	100	85	Peak
7320	48.47	-25.53	74	39.76	36.21	6.63	34.13	100	169	Peak

**Note:** Other harmonics are lower than background noise.

<b>Test Mode :</b>	Mode 2	<b>Temperature :</b>	22~23°C
<b>Test Channel :</b>	19	<b>Relative Humidity :</b>	40~41%
<b>Test Engineer :</b>	Jun Liu	<b>Polarization :</b>	Vertical
<b>Remark :</b>	1. 2440 MHz is fundamental signal which can be ignored. 2. Average measurement was not performed if peak level went lower than the average limit.		

Frequency ( MHz )	Level ( dBμV/m )	Over Limit ( dB )	Limit Line (dBμV/m )	Read Level (dBμV)	Antenna Factor ( dB )	Cable Loss ( dB )	Preamp Factor ( dB )	Ant Pos ( cm )	Table Pos ( deg )	Remark
2440	95.46	-	-	92.16	32.95	3.63	33.28	162	102	Peak
2440	94.7	-	-	91.4	32.95	3.63	33.28	162	102	Average
4880	46.88	-27.12	74	40.22	35.18	5.28	33.8	110	22	Peak
7320	49.55	-24.45	74	40.84	36.21	6.63	34.13	100	87	Peak

**Note:** Other harmonics are lower than background noise.



<b>Test Mode :</b>	Mode 3	<b>Temperature :</b>	22~23°C
<b>Test Channel :</b>	39	<b>Relative Humidity :</b>	40~41%
<b>Test Engineer :</b>	Jun Liu	<b>Polarization :</b>	Horizontal
<b>Remark :</b>	1. 2480 MHz is fundamental signal which can be ignored. 2. Average measurement was not performed if peak level went lower than the average limit.		

Frequency ( MHz )	Level ( dBμV/m )	Over Limit ( dB )	Limit Line (dBμV/m )	Read Level (dBμV)	Antenna Factor ( dB )	Cable Loss ( dB )	Preamp Factor ( dB )	Ant Pos ( cm )	Table Pos ( deg )	Remark
30	21.25	-18.75	40	36.34	18	0.48	33.57	-	-	Peak
108.57	23.95	-19.55	43.5	44.91	11.68	0.97	33.61	-	-	Peak
160.95	24.49	-19.01	43.5	47.35	9.56	1.16	33.58	-	-	Peak
233.7	21.53	-24.47	46	42.42	11.17	1.41	33.47	-	-	Peak
436.43	20.71	-25.29	46	35.77	16.23	1.94	33.23	-	-	Peak
941.8	35.18	-10.82	46	44.11	20.7	2.81	32.44	120	0	Peak
2480	97.49	-	-	94.12	33.01	3.65	33.29	196	51	Peak
2480	96.73	-	-	93.36	33.01	3.65	33.29	196	51	Average
4960	46.93	-27.07	74	40.2	35.2	5.33	33.8	100	61	Peak
7440	49.87	-24.13	74	41.03	36.27	6.75	34.18	100	46	Peak

**Note:** Other harmonics are lower than background noise.



<b>Test Mode :</b>	Mode 3	<b>Temperature :</b>	22~23°C
<b>Test Channel :</b>	39	<b>Relative Humidity :</b>	40~41%
<b>Test Engineer :</b>	Jun Liu	<b>Polarization :</b>	Vertical
<b>Remark :</b>	1. 2480 MHz is fundamental signal which can be ignored. 2. Average measurement was not performed if peak level went lower than the average limit.		

Frequency ( MHz )	Level ( dBμV/m )	Over Limit ( dB )	Limit Line (dBμV/m )	Read Level (dBμV)	Antenna Factor ( dB )	Cable Loss ( dB )	Preamp Factor ( dB )	Ant Pos ( cm )	Table Pos ( deg )	Remark
43.58	30.14	-9.86	40	53.11	10.03	0.62	33.62	-	-	Peak
53.28	28.49	-11.51	40	54.59	6.8	0.68	33.58	-	-	Peak
94.99	38.55	-4.95	43.5	61.47	9.8	0.9	33.62	100	300	Peak
128.94	21.94	-21.56	43.5	42.78	11.71	1.04	33.59	-	-	Peak
436.43	20.91	-25.09	46	35.97	16.23	1.94	33.23	-	-	Peak
941.8	36.6	-9.40	46	45.53	20.7	2.81	32.44	-	-	Peak
2480	94.28	-	-	90.91	33.01	3.65	33.29	155	114	Peak
2480	93.07	-	-	89.7	33.01	3.65	33.29	155	114	Average
4960	46.74	-27.26	74	40.01	35.2	5.33	33.8	110	69	Peak
7440	49.87	-24.13	74	41.03	36.27	6.75	34.18	100	58	Peak

**Note:** Other harmonics are lower than background noise.



### 3.6 AC Conducted Emission Measurement

#### 3.6.1 Limit of AC Conducted Emission

For equipment that is designed to be connected to the public utility (AC) power line, the radio frequency voltage that is conducted back onto the AC power line on any frequency or frequencies within the band 150 kHz to 30 MHz shall not exceed the limits in the following table.

Frequency of emission (MHz)	Conducted limit (dB $\mu$ V)	
	Quasi-peak	Average
0.15-0.5	66 to 56*	56 to 46*
0.5-5	56	46
5-30	60	50

\*Decreases with the logarithm of the frequency.

#### 3.6.2 Measuring Instruments

The section 4.0 of List of Measuring Equipment of this test report is used for test.

#### 3.6.3 Test Procedures

1. The EUT was placed 0.4 meter from the conducting wall of the shielding room was kept at least 80 centimeters from any other grounded conducting surface.
2. Connect EUT to the power mains through a line impedance stabilization network (LISN).
3. All the support units are connecting to the other LISN.
4. The LISN provides 50 ohm coupling impedance for the measuring instrument.
5. The FCC states that a 50 ohm, 50 microhenry LISN should be used.
6. Both sides of AC line were checked for maximum conducted interference.
7. The frequency range from 150 kHz to 30 MHz was searched.
8. Set the test-receiver system to Peak Detect Function and specified bandwidth with Maximum Hold Mode.

### 3.6.4 Test Setup

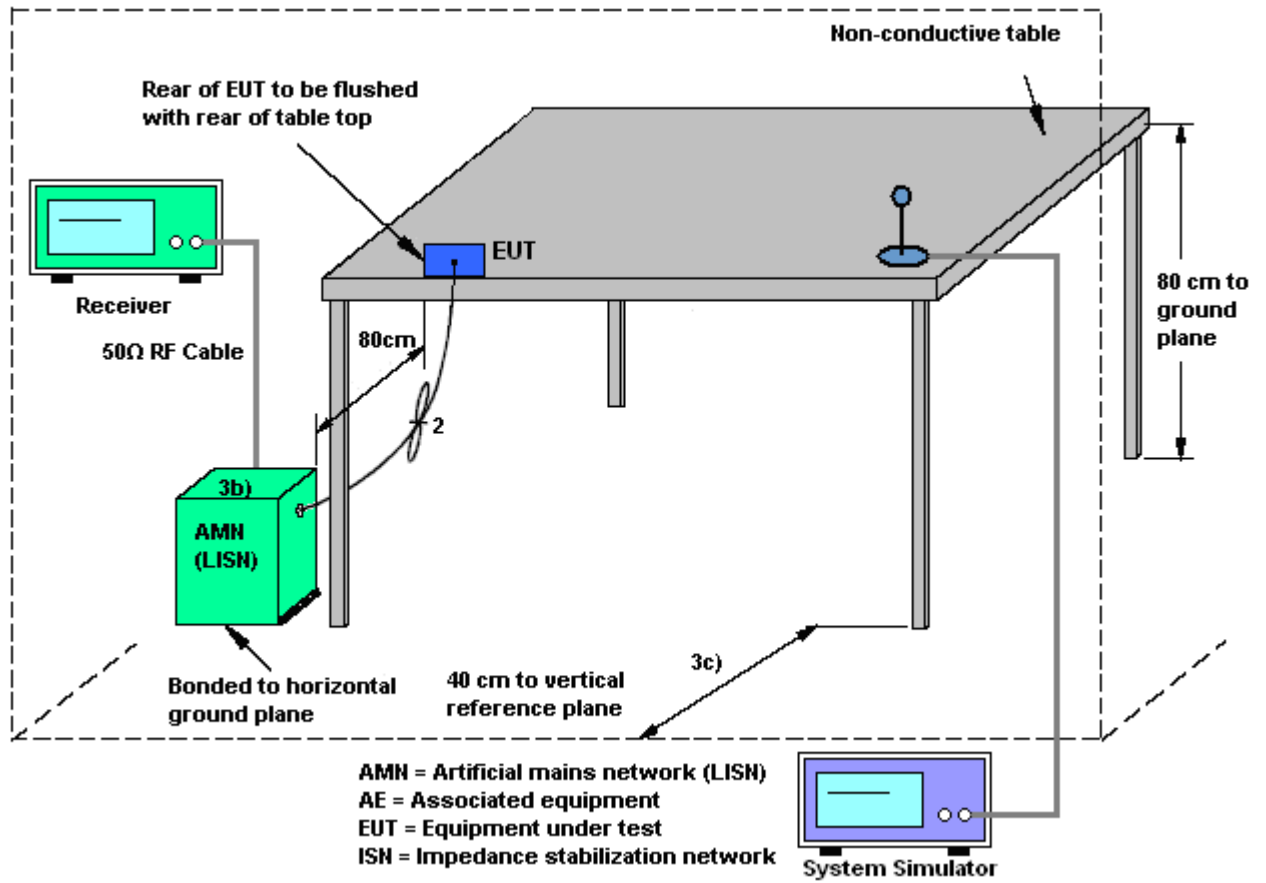



3.6.5 Test Result of AC Conducted Emission

Test Mode :	Mode 1	Temperature :	19~21°C
Test Engineer :	Eligah Wang	Relative Humidity :	37~39%
Test Voltage :	120Vac / 60Hz	Phase :	Line
Function Type :	GSM850 Idle + Bluetooth Link + WLAN Link + Earphone + USB Cable (Charging from Adapter)		

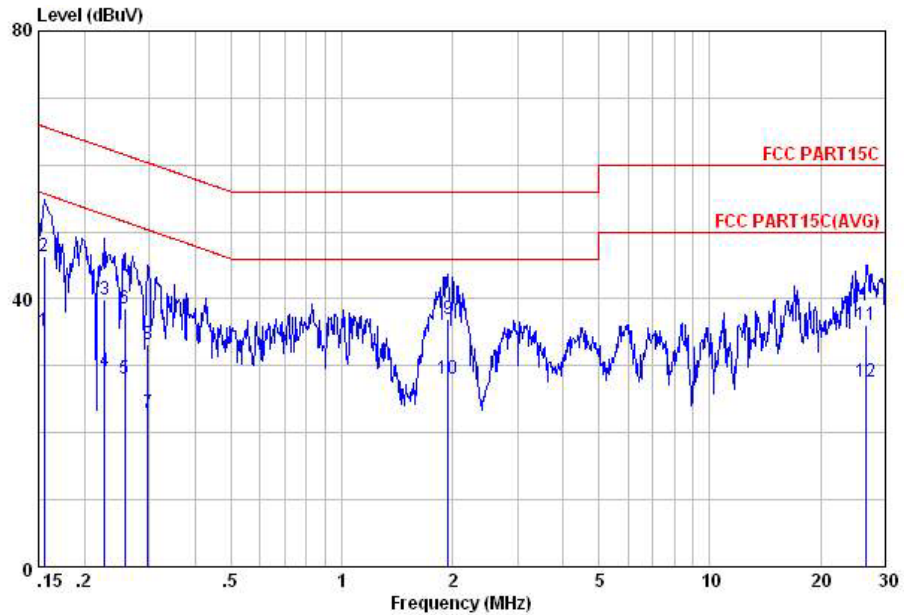

Site : C001-KS  
 Condition: FCC PART15C LISN-L20130306 LINE

	Freq	Level	Over	Limit	Read	LISN	Cable	Remark
	MHz	dBuV	Limit	Line	Level	Factor	Loss	
			dB	dBuV	dBuV	dB	dB	
1	0.16	35.25	-20.44	55.69	22.70	1.86	10.69	Average
2	0.16	46.35	-19.34	65.69	33.80	1.86	10.69	QP
3	0.23	39.78	-22.79	62.57	28.30	0.94	10.54	QP
4	0.23	29.28	-23.29	52.57	17.80	0.94	10.54	Average
5	0.26	28.15	-23.36	51.51	16.80	0.86	10.49	Average
6	0.26	38.65	-22.86	61.51	27.30	0.86	10.49	QP
7	0.30	22.90	-27.42	50.32	11.79	0.71	10.40	Average
8	0.30	33.30	-27.02	60.32	22.19	0.71	10.40	QP
9	1.95	37.09	-18.91	56.00	26.80	0.10	10.19	QP
10	1.95	28.09	-17.91	46.00	17.80	0.10	10.19	Average
11	26.56	36.05	-23.95	60.00	25.40	0.10	10.55	QP
12	26.56	27.55	-22.45	50.00	16.90	0.10	10.55	Average



Test Mode :	Mode 1	Temperature :	19~21°C
Test Engineer :	Eligah Wang	Relative Humidity :	37~39%
Test Voltage :	120Vac / 60Hz	Phase :	Neutral
Function Type :	GSM850 Idle + Bluetooth Link + WLAN Link + Earphone + USB Cable (Charging from Adapter)		

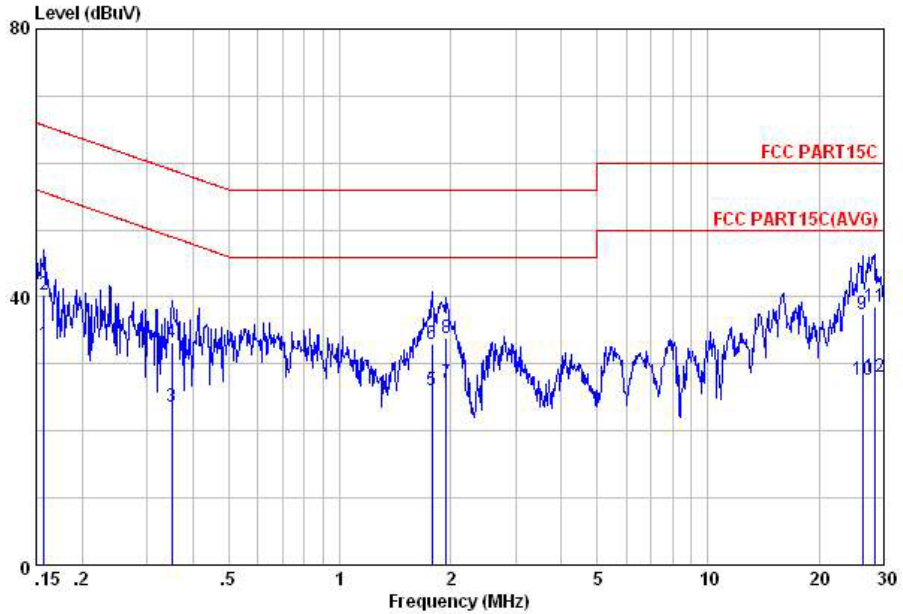

Site : C001-KS  
 Condition: FCC PART15C LISN-N20130306 NEUTRAL

	Freq	Level	Over	Limit	Read	LISN	Cable	Remark
	MHz	dBuV	Limit	Line	Level	Factor	Loss	
			dB	dBuV	dBuV	dB	dB	
1	0.16	32.87	-22.73	55.60	20.40	1.79	10.68	Average
2	0.16	40.27	-25.33	65.60	27.80	1.79	10.68	QP
3	0.35	23.63	-25.33	48.96	12.80	0.51	10.32	Average
4	0.35	33.23	-25.73	58.96	22.40	0.51	10.32	QP
5	1.78	26.09	-19.91	46.00	15.80	0.10	10.19	Average
6	1.78	33.09	-22.91	56.00	22.80	0.10	10.19	QP
7	1.95	27.09	-18.91	46.00	16.80	0.10	10.19	Average
8	1.95	33.89	-22.11	56.00	23.60	0.10	10.19	QP
9	26.28	37.52	-22.48	60.00	26.79	0.18	10.55	QP
10	26.28	27.52	-22.48	50.00	16.79	0.18	10.55	Average
11	28.30	38.57	-21.43	60.00	27.90	0.13	10.54	QP
12	28.30	27.97	-22.03	50.00	17.30	0.13	10.54	Average



## **3.7 Antenna Requirements**

### **3.7.1 Standard Applicable**

If directional gain of transmitting antennas is greater than 6dBi, the power shall be reduced by the same level in dB comparing to gain minus 6dBi. The use of a permanently attached antenna or of an antenna that uses a unique coupling to the intentional radiator shall be considered sufficient to comply with the FCC rule.

### **3.7.2 Antenna Anti-Replacement Construction**

An embedded-in antenna design is used.

### **3.7.3 Antenna Gain**

The antenna peak gain of EUT is less than 6 dBi. Therefore, it is not necessary to reduce maximum peak output power limit.



## 4 List of Measuring Equipment

Instrument	Manufacturer	Model No.	Serial No.	Characteristics	Calibration Date	Test Date	Due Date	Remark
Spectrum Analyzer	R&S	FSP40	100319	9kHz~40GHz	Dec. 28, 2013	Mar. 05, 2014	Dec. 27, 2014	Conducted (TH01-KS)
Pulse Power Sensor	Anritsu	MA2411B	0917070	30MHz~40GHz	Feb. 27, 2014	Mar. 05, 2014	Feb. 26, 2015	Conducted (TH01-KS)
Power Meter	Anritsu	ML2495A	1005002	50MHz Bandwidth	Feb. 27, 2014	Mar. 05, 2014	Feb. 26, 2015	Conducted (TH01-KS)
EMI Test Receiver	R&S	ESCI	100534	9kHz~3GHz	Nov. 05, 2013	Mar. 06, 2014	Nov. 04, 2014	Radiation (03CH01-KS)
Spectrum Analyzer	R&S	FSP30	101399	9kHz~30GHz	May 23, 2013	Mar. 06, 2014	May 22, 2014	Radiation (03CH01-KS)
Loop Antenna	R&S	HFH2-Z2	100321	9kHz~30MHz	Oct. 09, 2013	Mar. 06, 2014	Oct. 08, 2014	Radiation (03CH01-KS)
Bilog Antenna	SCHAFFNER	CBL6112D	23182	25MHz~2GHz	Jan. 08, 2014	Mar. 06, 2014	Jan. 07, 2015	Radiation (03CH01-KS)
Double Ridge Horn Antenna	EMCO	3117	00075959	1GHz~18GHz	Jan. 08, 2014	Mar. 06, 2014	Jan. 07, 2015	Radiation (03CH01-KS)
SHF-EHF Horn	Schwarzbeck	BBHA 9170	BBHA1702 49	15GHz~40GHz	Nov. 22, 2013	Mar. 06, 2014	Nov. 21, 2014	Radiation (03CH01-KS)
Active Horn Antenna	com-power	AHA-118	701030	1GHz~18GHz	Nov. 18, 2013	Mar. 06, 2014	Nov. 17, 2014	Radiation (03CH01-KS)
Amplifier	com-power	PA-103A	161069	1MHz~1GHz	May 23, 2013	Mar. 06, 2014	May 22, 2014	Radiation (03CH01-KS)
Amplifier	Agilent	8449B	3008A023 71	1GHz~26.5GHz	Dec. 10, 2013	Mar. 06, 2014	Dec. 09, 2014	Radiation (03CH01-KS)
Turn Table	MF	MF7802	N/A	0~360 degree	NCR	Mar. 06, 2014	NCR	Radiation (03CH01-KS)
Antenna Mast	MF	MF7802	N/A	1 m~4 m	NCR	Mar. 06, 2014	NCR	Radiation (03CH01-KS)
EMI Receiver	R&S	ESCI7	100768	9kHz~7GHz	May 23, 2013	Mar. 20, 2014	May 22, 2014	Conduction (CO01-KS)
AC LISN	MessTec	AN3016	060103	9kHz~30MHz	Dec. 10, 2013	Mar. 20, 2014	Dec. 09, 2014	Conduction (CO01-KS)
AC LISN (for auxiliary equipment)	MessTec	AN3016	060105	9kHz~30MHz	Dec. 10, 2013	Mar. 20, 2014	Dec. 09, 2014	Conduction (CO01-KS)
AC Power Source	Chroma	61602	ABP00000 0811	AC 0V~300V, 45Hz~1000Hz	May 25, 2013	Mar. 20, 2014	May 24, 2014	Conduction (CO01-KS)



## 5 Uncertainty of Evaluation

### Uncertainty of Conducted Emission Measurement (150 kHz ~ 30 MHz)

Measuring Uncertainty for a Level of Confidence of 95% ( $U = 2Uc(y)$ )	2.26
---	------

### Uncertainty of Radiated Emission Measurement (30 MHz ~ 1000 MHz)

Measuring Uncertainty for a Level of Confidence of 95% ( $U = 2Uc(y)$ )	2.54
---	------