

FCC RF Test Report

APPLICANT : Acer Incorporated
EQUIPMENT : Smart HandHeld
BRAND NAME : Acer
MODEL NAME : Z160
MARKETING NAME : Liquid Z4
FCC ID : HLZDMZ160
STANDARD : FCC Part 15 Subpart C §15.247
CLASSIFICATION : (DTS) Digital Transmission System

The product was received on Feb. 18, 2014 and testing was completed on Mar. 20, 2014. We, SPORTON INTERNATIONAL (KUNSAHN) INC., would like to declare that the tested sample has been evaluated in accordance with the procedures and shown to be compliant with the applicable technical standards.

The test results in this report apply exclusively to the tested model / sample. Without written approval of SPORTON INTERNATIONAL (KUNSAHN) INC., the test report shall not be reproduced except in full.



Reviewed by: Joseph Lin / Supervisor

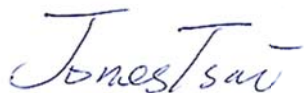

Approved by: Jones Tsai / Manager



SPORTON INTERNATIONAL (KUNSHAN) INC.
No. 3-2, PingXiang Road, Kunshan, Jiangsu Province, P.R.C.



TABLE OF CONTENTS

REVISION HISTORY..... 3

SUMMARY OF TEST RESULT 4

1 GENERAL DESCRIPTION 5

 1.1 Applicant 5

 1.2 Manufacturer 5

 1.3 Feature of Equipment Under Test 5

 1.4 Product Specification of Equipment Under Test 5

 1.5 Modification of EUT 6

 1.6 Testing Site 6

 1.7 Applied Standards 6

2 TEST CONFIGURATION OF EQUIPMENT UNDER TEST 7

 2.1 Carrier Frequency Channel 7

 2.2 Pre-Scanned RF Power 8

 2.3 Test Mode 9

 2.4 Connection Diagram of Test System 10

 2.5 Support Unit used in test configuration and system 11

 2.6 EUT Operation Test Setup 11

 2.7 Measurement Results Explanation Example 12

3 TEST RESULT 13

 3.1 6dB and 99% Bandwidth Measurement 13

 3.2 Output Power Measurement 15

 3.3 Power Spectral Density Measurement 18

 3.4 Conducted Band Edges and Spurious Emission Measurement 21

 3.5 Radiated Band Edges and Spurious Emission Measurement 34

 3.6 AC Conducted Emission Measurement 56

 3.7 Antenna Requirements 60

4 LIST OF MEASURING EQUIPMENT 61

5 UNCERTAINTY OF EVALUATION 62

APPENDIX A. SETUP PHOTOGRAPHS



REVISION HISTORY

REPORT NO.	VERSION	DESCRIPTION	ISSUED DATE
FR421813C	Rev. 01	Initial issue of report	Apr. 01, 2014

SUMMARY OF TEST RESULT

Report Section	FCC Rule	IC Rule	Description	Limit	Result	Remark
3.1	15.247(a)(2)	RSS-210 A8.2(a)	6dB Bandwidth	$\geq 0.5\text{MHz}$	Pass	-
3.1	-	RSS-Gen 4.6.1	99% Bandwidth	-	Pass	-
3.2	15.247(b)	RSS-210 A8.4	Power Output Measurement	$\leq 30\text{dBm}$	Pass	-
3.3	15.247(e)	RSS-210 A8.2(b)	Power Spectral Density	$\leq 8\text{dBm}/3\text{kHz}$	Pass	-
3.4	15.247(d)	RSS-210 A8.5	Conducted Band Edges	$\leq 20\text{dBc}$	Pass	-
			Conducted Spurious Emission		Pass	-
3.5	15.247(d)	RSS-210 A8.5	Radiated Band Edges and Radiated Spurious Emission	15.209(a) & 15.247(d)	Pass	Under limit 3.18 dB at 2389.650 MHz
3.6	15.207	RSS-Gen 7.2.4	AC Conducted Emission	15.207(a)	Pass	Under limit 17.91 dB at 1.950 MHz
3.7	15.203 & 15.247(b)	RSS-210 A8.4	Antenna Requirement	N/A	Pass	-

1 General Description

1.1 Applicant

Acer Incorporated

8F., No. 88, Sec. 1, Xintai 5th Rd., Xizhi Dist., New Taipei City 22181, Taiwan (R.O.C)

1.2 Manufacturer

Shanghai Sunrise Simcom Limited

No. 888, Shengli Rd., Qingpu, Shanghai, P.R.China 201700

1.3 Feature of Equipment Under Test

Product Feature	
Equipment	Smart HandHeld
Brand Name	Acer
Model Name	Z160
Marketing Name	Liquid Z4
FCC ID	HLZDMZ160
EUT supports Radios application	GSM/GPRS/EGPRS/WCDMA/HSPA/HSPA+(Downlink Only) WLAN2.4GHz 802.11b/g/n HT20/HT40/ Bluetooth v3.0 + EDR/Bluetooth v4.0 LE
EUT Stage	Identical Prototype

Remark: The above EUT's information was declared by manufacturer. Please refer to the specifications or user's manual for more detailed description.

1.4 Product Specification of Equipment Under Test

Product Specification subjective to this standard	
Tx/Rx Channel Frequency Range	2412 MHz ~ 2462 MHz
Maximum (Peak) Output Power to Antenna	802.11b : 16.49 dBm (0.0446 W) 802.11g : 21.43 dBm (0.1390 W) 802.11n HT20 : 19.21 dBm (0.0834 W) 802.11n HT40 : 15.63 dBm (0.0366 W)
99% Occupied Bandwidth	802.11b : 12.40MHz 802.11g : 17.65MHz 802.11n HT20 : 18.45MHz 802.11n HT40 : 36.50MHz
Antenna Type	PIFA Antenna with gain -0.40 dBi
Type of Modulation	802.11b : DSSS (DBPSK / DQPSK / CCK) 802.11g/n : OFDM (BPSK / QPSK / 16QAM / 64QAM)

1.5 Modification of EUT

No modifications are made to the EUT during all test items.

1.6 Testing Site

Test Site	SPORTON INTERNATIONAL (KUNSHAN) INC.			
Test Site Location	No. 3-2, PingXiang Road, Kunshan, Jiangsu Province, P.R.C. TEL: +86-0512-5790-0158 FAX: +86-0512-5790-0958			
Test Site No.	Sporton Site No.			FCC Registration No.
	TH01-KS	03CH01-KS	CO01-KS	149928/4086E-1

Note: The test site complies with ANSI C63.4 2003 requirement.

1.7 Applied Standards

According to the specifications of the manufacturer, the EUT must comply with the requirements of the following standards:

- ♦ FCC Part 15 Subpart C §15.247
- ♦ FCC KDB Publication No. 558074 D01 DTS Meas. Guidance v03r01
- ♦ ANSI C63.4-2003
- ♦ IC RSS-210 Issue 8
- ♦ IC RSS-Gen Issue 3
- ♦ NOTICE 2012-DRS0126

Remark:

1. All test items were verified and recorded according to the standards and without any deviation during the test.
2. This EUT has also been tested and complied with the requirements of FCC Part 15, Subpart B, recorded in a separate test report.

2 Test Configuration of Equipment Under Test

The EUT has been associated with peripherals and configuration operated in a manner tended to maximize its emission characteristics in a typical application. Frequency range investigated: conducted emission (150 kHz to 30 MHz) and radiated emission (9 kHz to the 10th harmonic of the highest fundamental frequency or to 40 GHz, whichever is lower). For radiated measurement, pre-scanned in three orthogonal panels, X, Y, Z. The worst cases (Z plane) were recorded in this report.

The final configuration from all the combinations and the worst-case data rates were investigated by measuring the maximum power across all the data rates and modulation modes under section 2.2.

Based on the worst configuration found above, the RF power setting is set individually to meet FCC compliance limit for the final conducted and radiated tests shown in section 2.3.

2.1 Carrier Frequency Channel

Frequency Band	Channel	Freq. (MHz)	Channel	Freq. (MHz)
2400-2483.5 MHz	1	2412	7	2442
	2	2417	8	2447
	3	2422	9	2452
	4	2427	10	2457
	5	2432	11	2462
	6	2437	-	-

2.2 Pre-Scanned RF Power

Preliminary tests were performed in different data rate and data rate associated with the highest power were chosen for full test shown in the following tables.

Channel	Frequency	2.4GHz 802.11b RF Power (dBm)			
		DSSS Data Rate			
		1 Mbps	2 Mbps	5.5 Mbps	11 Mbps
CH 01	2412 MHz	16.05	16.10	16.08	16.12
CH 06	2437 MHz	16.49	16.42	16.45	16.39
CH 11	2462 MHz	16.08	16.12	16.14	16.09

Channel	Frequency	2.4GHz 802.11g RF Power (dBm)							
		OFDM Data Rate							
		6 Mbps	9 Mbps	12 Mbps	18 Mbps	24 Mbps	36 Mbps	48 Mbps	54 Mbps
CH 01	2412 MHz	20.57	20.62	20.69	20.41	20.40	20.16	20.21	20.26
CH 06	2437 MHz	21.43	20.85	20.88	20.32	19.98	20.94	20.40	20.41
CH 11	2462 MHz	19.23	19.13	19.23	19.26	19.39	19.08	19.05	18.97

Channel	Frequency	2.4GHz 802.11n HT20 RF Power (dBm)							
		OFDM Data Rate							
		MCS0	MCS1	MCS2	MCS3	MCS4	MCS5	MCS6	MCS7
CH 01	2412 MHz	18.84	18.93	18.86	18.79	18.54	18.99	18.87	18.73
CH 06	2437 MHz	18.99	19.08	19.11	19.17	18.98	18.67	18.56	18.43
CH 11	2462 MHz	19.21	18.79	18.61	18.89	18.74	18.70	19.19	18.89

Channel	Frequency	2.4GHz 802.11n HT40 RF Power (dBm)							
		OFDM Data Rate							
		MCS0	MCS1	MCS2	MCS3	MCS4	MCS5	MCS6	MCS7
CH 03	2422 MHz	15.58	14.28	14.32	14.42	14.41	13.87	14.04	14.24
CH 06	2437 MHz	15.63	14.25	14.56	13.41	13.38	14.02	13.96	14.29
CH 09	2452 MHz	15.23	15.14	14.68	14.51	14.47	14.33	14.15	14.08

2.3 Test Mode

Final results of test modes, data rates and test channels are shown as following table.

Test Cases				
	Test Items	Mode	Data Rate	Test Channel
Conducted TCs	6dB and 99% BW Power Spectral Density	802.11b	1 Mbps	1/6/11
		802.11g	6 Mbps	1/6/11
		802.11n HT20	MCS0	1/6/11
		802.11n HT40	MCS0	3/6/9
	Output Power	802.11b	1 Mbps	1/6/11
		802.11g	6 Mbps	1/6/11
		802.11n HT20	MCS0	1/6/11
		802.11n HT40	MCS0	3/6/9
	Conducted Band Edge	802.11b	1 Mbps	1/11
		802.11g	6 Mbps	1/11
		802.11n HT20	MCS0	1/11
		802.11n HT40	MCS0	3/9
	Conducted Spurious Emission	802.11b	1 Mbps	1/6/11
		802.11g	6 Mbps	1/6/11
		802.11n HT20	MCS0	1/6/11
		802.11n HT40	MCS0	3/6/9
Radiated TCs	Radiated Band Edge	802.11b	1 Mbps	1/11
		802.11g	6 Mbps	1/11
		802.11n HT20	MCS0	1/11
		802.11n HT40	MCS0	3/9
	Radiated Spurious Emission	802.11b	1 Mbps	1/6/11
		802.11g	6 Mbps	1/6/11
		802.11n HT20	MCS0	1/6/11
		802.11n HT40	MCS0	3/6/9
AC Conducted Emission	Mode 1 : GSM850 Idle + Bluetooth Link + WLAN Link + USB Cable (Charging from Adapter) + Earphone			
Remark: For radiated test cases, the tests were performed with adapter, earphone and USB cable.				

2.4 Connection Diagram of Test System

<WLAN Tx Mode>

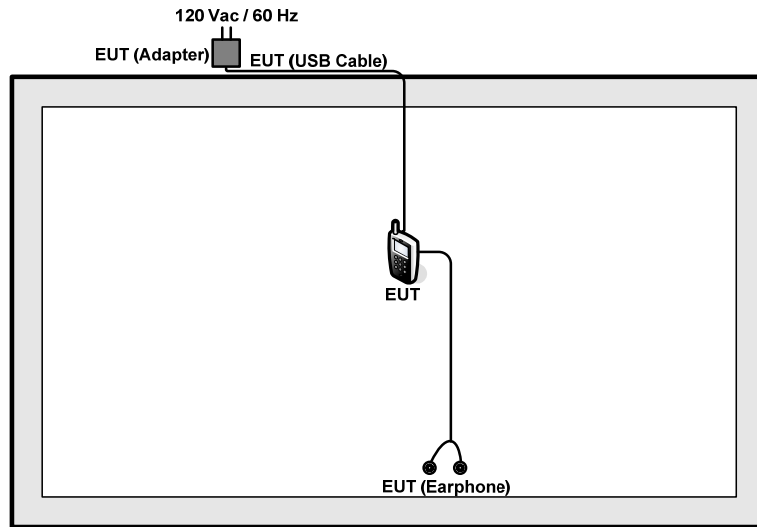

<AC Conducted Emission Mode>

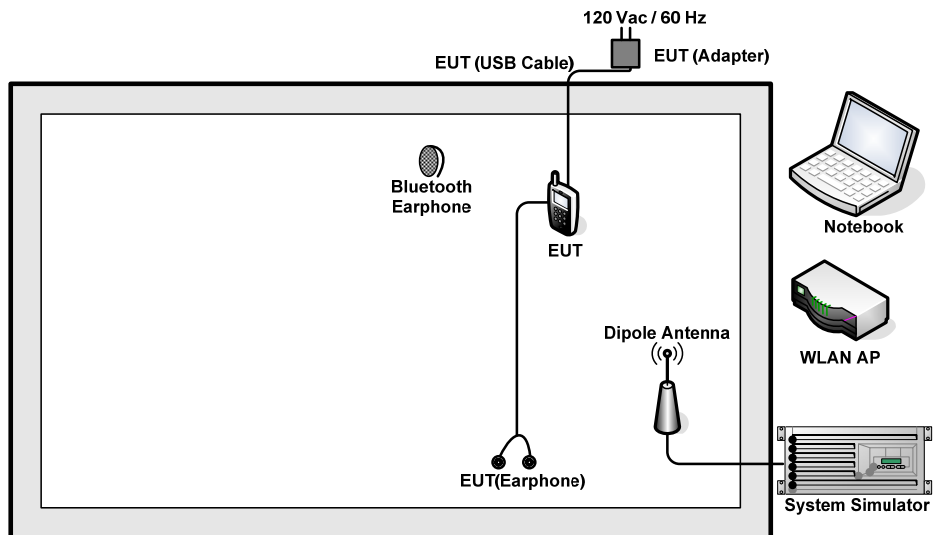

2.5 Support Unit used in test configuration and system

Item	Equipment	Trade Name	Model Name	FCC ID	Data Cable	Power Cord
1.	System Simulator	R&S	CMU 200	N/A	N/A	Unshielded, 1.8 m
2.	DC Power Supply	GWINSTEK	GPS-3030D	FCC DoC	N/A	Unshielded, 1.8 m
3.	WLAN AP	D-Link	DIR-855	KA2DIR855A2	N/A	Unshielded, 1.8 m
4.	Notebook	DELL	P08S	QDS-BRCM1030	N/A	AC I/P: Unshielded, 0.9 m DC O/P: Shielded, 1.8 m
5.	Bluetooth Earphone	Nokia	BH-106	QTLBH-106	N/A	N/A

2.6 EUT Operation Test Setup

For WLAN RF test items, the engineering test program was provided and enabled to make EUT continuous transmit/receive.

For AC power line conducted emissions, the EUT was set to connect with the WLAN AP under large package sizes transmission.



2.7 Measurement Results Explanation Example

For all conducted test items:

The offset level is set in the spectrum analyzer to compensate the RF cable loss and attenuator factor between EUT conducted output port and spectrum analyzer. With the offset compensation, the spectrum analyzer reading level is exactly the EUT RF output level.

Example:

The spectrum analyzer offset is derived from RF cable loss and attenuator factor.

Offset = RF cable loss + attenuator factor.

Following shows an offset computation example with cable loss 6.0 dB and 10dB attenuator.

$$\begin{aligned} \text{Offset (dB)} &= \text{RF cable loss (dB)} + \text{attenuator factor (dB)} \\ &= 6.0 + 10 = 16.0 \text{ (dB)} \end{aligned}$$

3 Test Result

3.1 6dB and 99% Bandwidth Measurement

3.1.1 Limit of 6dB and 99% Bandwidth

The minimum 6 dB bandwidth shall be at least 500 kHz.

3.1.2 Measuring Instruments

The measuring equipment is listed in the section 4 of this test report.

3.1.3 Test Procedures

1. The testing follows FCC KDB Publication No. 558074 DTS D01 Meas. Guidance v03r01.
2. The RF output of EUT was connected to the spectrum analyzer by RF cable and attenuator. The path loss was compensated to the results for each measurement.
3. Set to the maximum power setting and enable the EUT transmit continuously.
4. Make the measurement with the spectrum analyzer's resolution bandwidth (RBW) = 100 kHz. Set the Video bandwidth (VBW) = 300 kHz. In order to make an accurate measurement. The 6 dB bandwidth must be greater than 500 kHz.
5. For 99% Bandwidth Measurement, the spectrum analyzer's resolution bandwidth (RBW) = 1MHz and set the Video bandwidth (VBW) = 3MHz.
6. Measure and record the results in the test report.

3.1.4 Test Setup

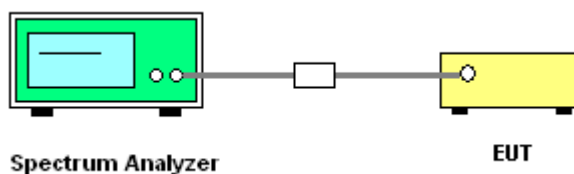



3.1.5 Test Result of 6dB and 99% Occupied Bandwidth

Test Band :	2.4GHz	Temperature :	23~24°C
Test Engineer :	Adonis Li	Relative Humidity :	47~48%

Mod.	Data Rate	N _{TX}	Channel	Freq. (MHz)	99% Bandwidth (MHz)	6dB Bandwidth (MHz)	6dB Bandwidth Min. Limit (MHz)	Pass/Fail
11b	1Mbps	1	1	2412	12.40	9.04	0.50	Pass
11b	1Mbps	1	6	2437	12.40	9.06	0.50	Pass
11b	1Mbps	1	11	2462	12.35	9.06	0.50	Pass
11g	6Mbps	1	1	2412	17.65	16.32	0.50	Pass
11g	6Mbps	1	6	2437	17.65	16.32	0.50	Pass
11g	6Mbps	1	11	2462	17.65	16.32	0.50	Pass
HT20	MCS0	1	1	2412	18.40	17.60	0.50	Pass
HT20	MCS0	1	6	2437	18.45	17.58	0.50	Pass
HT20	MCS0	1	11	2462	18.40	17.58	0.50	Pass
HT40	MCS0	1	3	2422	36.50	36.28	0.50	Pass
HT40	MCS0	1	6	2437	36.50	36.08	0.50	Pass
HT40	MCS0	1	9	2452	36.50	36.00	0.50	Pass

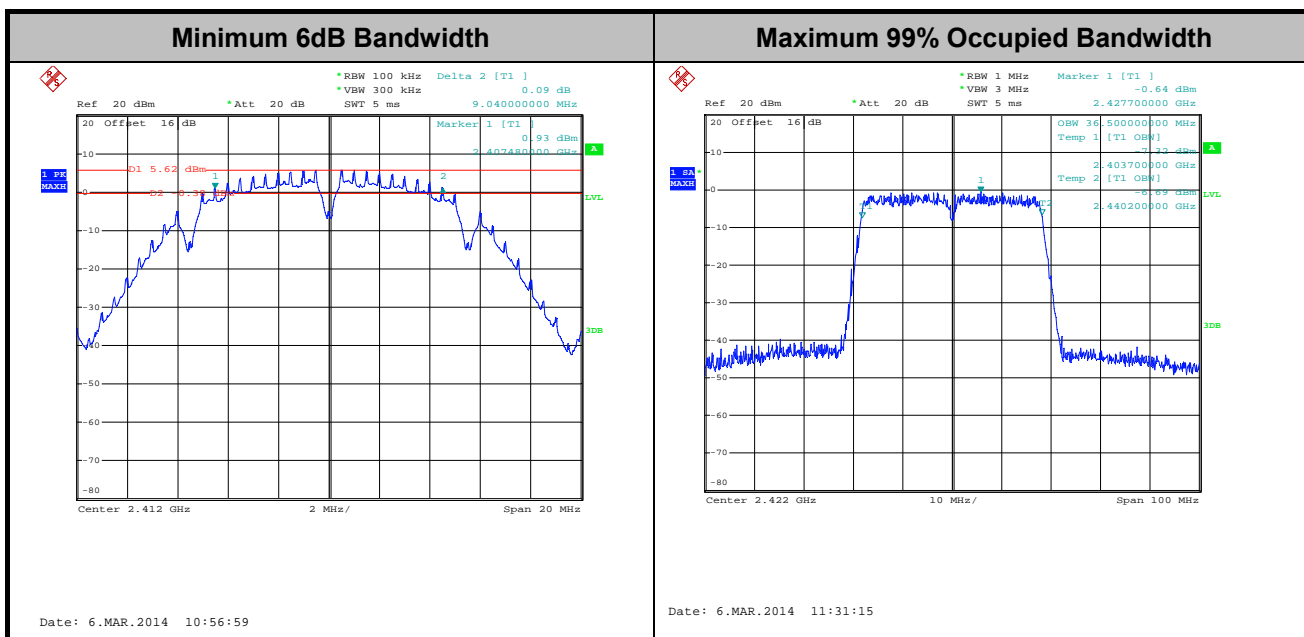

Note: The occupied channel bandwidth is maintained within the band of operation for all of the modulations.

3.2 Output Power Measurement

3.2.1 Limit of Output Power

For systems using digital modulation in the 2400-2483.5MHz, the limit for peak output power is 30dBm. If transmitting Antenna of directional gain greater than 6dBi are used the peak output power from the intentional radiator shall be reduced below the above stated value by the amount in dB that the directional gain of the Antenna exceeds 6 dBi. In case of point-to-point operation, the limit has to be reduced by 1dB for every 3dB that the directional gain of the Antenna exceeds 6dBi.

3.2.2 Measuring Instruments

The measuring equipment is listed in the section 4 of this test report.

3.2.3 Test Procedures

1. The testing follows the Measurement Procedure of FCC KDB No. 558074 DTS D01 Meas. Guidance v03r01.
2. The RF output of EUT was connected to the power meter by RF cable and attenuator. The path loss was compensated to the results for each measurement.
3. Set to the maximum power setting and enable the EUT transmit continuously.
4. Measure the conducted output power and record the results in the test report.

3.2.4 Test Setup

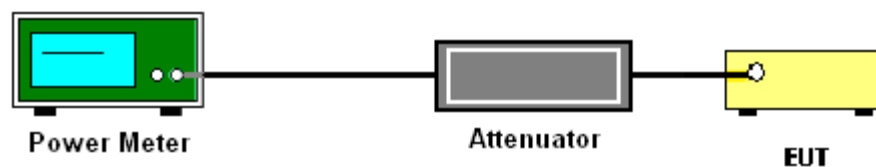



3.2.5 Test Result of Peak Output Power

Test Mode :	2.4GHz	Temperature :	23~24°C
Test Engineer :	Adonis Li	Relative Humidity :	47~48%

Mod.	Data Rate	N _{TX}	Channel	Freq. (MHz)	RF Output Power (dBm)	Power Limit (dBm)	DG (dBi)	Pass/Fail
11b	1Mbps	1	1	2412	16.05	30.00	-0.40	Pass
11b	1Mbps	1	6	2437	16.49	30.00	-0.40	Pass
11b	1Mbps	1	11	2462	16.08	30.00	-0.40	Pass
11g	6Mbps	1	1	2412	20.57	30.00	-0.40	Pass
11g	6Mbps	1	6	2437	21.43	30.00	-0.40	Pass
11g	6Mbps	1	11	2462	19.23	30.00	-0.40	Pass
HT20	MCS0	1	1	2412	18.84	30.00	-0.40	Pass
HT20	MCS0	1	6	2437	18.99	30.00	-0.40	Pass
HT20	MCS0	1	11	2462	19.21	30.00	-0.40	Pass
HT40	MCS0	1	3	2422	15.58	30.00	-0.40	Pass
HT40	MCS0	1	6	2437	15.63	30.00	-0.40	Pass
HT40	MCS0	1	9	2452	15.23	30.00	-0.40	Pass

Note: Measured power (dBm) has offset with cable loss.



3.2.6 Test Result of Average output Power (Reporting Only)

Test Mode :	2.4GHz	Temperature :	23~24°C
Test Engineer :	Adonis Li	Relative Humidity :	47~48%

Mod.	Data Rate	N _{TX}	Channel	Freq. (MHz)	Duty Factor (dB)	Average Output Power (dBm)	Power Limit (dBm)	DG (dBi)	Pass/Fail
11b	1Mbps	1	1	2412	0.09	13.18	30	-0.40	Pass
11b	1Mbps	1	6	2437	0.09	13.45	30	-0.40	Pass
11b	1Mbps	1	11	2462	0.09	13.13	30	-0.40	Pass
11g	6Mbps	1	1	2412	0.50	10.52	30	-0.40	Pass
11g	6Mbps	1	6	2437	0.50	11.23	30	-0.40	Pass
11g	6Mbps	1	11	2462	0.50	9.92	30	-0.40	Pass
HT20	MCS0	1	1	2412	0.53	9.16	30	-0.40	Pass
HT20	MCS0	1	6	2437	0.53	9.47	30	-0.40	Pass
HT20	MCS0	1	11	2462	0.53	9.61	30	-0.40	Pass
HT40	MCS0	1	3	2422	1.04	4.36	30	-0.40	Pass
HT40	MCS0	1	6	2437	1.04	4.69	30	-0.40	Pass
HT40	MCS0	1	9	2452	1.04	4.22	30	-0.40	Pass

Note: Measured power (dBm) has offset with cable loss and duty factor.

3.3 Power Spectral Density Measurement

3.3.1 Limit of Power Spectral Density

The peak power spectral density shall not be greater than 8dBm in any 3kHz band at any time interval of continuous transmission.

3.3.2 Measuring Instruments

The measuring equipment is listed in the section 4 of this test report.

3.3.3 Test Procedures

1. The testing follows Measurement Procedure 10.2 Method PKPSD of FCC KDB Publication No. 558074 D01 DTS Meas. Guidance v03r01
2. The RF output of EUT was connected to the spectrum analyzer by RF cable and attenuator. The path loss was compensated to the results for each measurement.
3. Set to the maximum power setting and enable the EUT transmit continuously.
4. Make the measurement with the spectrum analyzer's resolution bandwidth (RBW) = 3 kHz. Video bandwidth VBW = 10 kHz In order to make an accurate measurement, set the span to 1.5 times DTS Channel Bandwidth. (6dB BW)
5. Detector = peak, Sweep time = auto couple, Trace mode = max hold, Allow trace to fully stabilize. Use the peak marker function to determine the maximum power level.
6. Measure and record the results in the test report.

3.3.4 Test Setup

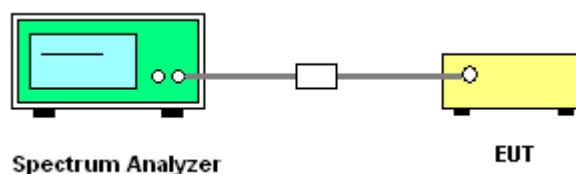



3.3.5 Test Result of Power Spectral Density

Test Mode :	2.4GHz	Temperature :	23~24°C
Test Engineer :	Adonis Li	Relative Humidity :	47~48%

Mod.	Data Rate	N _{TX}	Channel	Freq. (MHz)	Peak Power Density (dBm/3kHz)	Max. Limits (dBm/3kHz)	DG (dBi)	Pass/Fail
11b	1Mbps	1	1	2412	-8.25	8.00	-0.40	Pass
11b	1Mbps	1	6	2437	-8.22	8.00	-0.40	Pass
11b	1Mbps	1	11	2462	-8.13	8.00	-0.40	Pass
11g	6Mbps	1	1	2412	-12.27	8.00	-0.40	Pass
11g	6Mbps	1	6	2437	-13.68	8.00	-0.40	Pass
11g	6Mbps	1	11	2462	-12.66	8.00	-0.40	Pass
HT20	MCS0	1	1	2412	-16.32	8.00	-0.40	Pass
HT20	MCS0	1	6	2437	-15.10	8.00	-0.40	Pass
HT20	MCS0	1	11	2462	-14.47	8.00	-0.40	Pass
HT40	MCS0	1	3	2422	-22.05	8.00	-0.40	Pass
HT40	MCS0	1	6	2437	-23.44	8.00	-0.40	Pass
HT40	MCS0	1	9	2452	-23.44	8.00	-0.40	Pass

Note: Measured power density (dBm) has offset with cable loss.

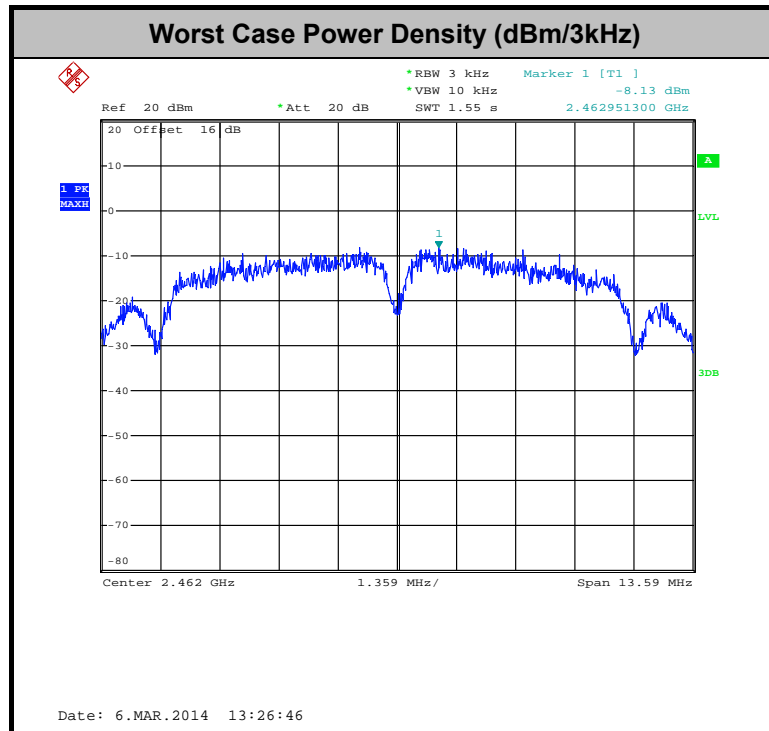

3.4 Conducted Band Edges and Spurious Emission Measurement

3.4.1 Limit of Conducted Band Edges and Spurious Emission Measurement

In any 100 kHz bandwidth outside of the authorized frequency band, the emissions which fall in the non-restricted bands shall be attenuated at least 20 dB / 30dB relative to the maximum PSD level in 100 kHz by RF conducted measurement and radiated emissions which fall in the restricted bands, as defined in Section 15.205(a), must also comply with the radiated emission limits specified in Section 15.209(a).

3.4.2 Measuring Instruments

The measuring equipment is listed in the section 4 of this test report.

3.4.3 Test Procedures

1. The testing follows FCC KDB Publication No. 558074 D01 DTS Meas. Guidance v03r01.
2. The RF output of EUT was connected to the spectrum analyzer by RF cable and attenuator. The path loss was compensated to the results for each measurement.
3. Set to the maximum power setting and enable the EUT transmit continuously.
4. Set RBW = 100 kHz, VBW=300 kHz, Peak Detector. Unwanted Emissions measured in any 100 kHz bandwidth outside of the authorized frequency band shall be attenuated by at least 20 dB relative to the maximum in-band peak PSD level in 100 kHz when maximum peak conducted output power procedure is used. If the transmitter complies with the conducted power limits based on the use of RMS averaging over a time interval, the attenuation required under this paragraph shall be 30 dB instead of 20 dB per 15.247(d).
5. Measure and record the results in the test report.
6. The RF fundamental frequency should be excluded against the limit line in the operating frequency band.

3.4.4 Test Setup

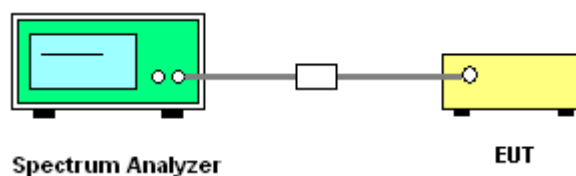



3.4.5 Test Result of Conducted Band Edges and Spurious Emission

Test Mode :	802.11b	Temperature :	23~24°C
Test Band :	2.4GHz Low	Relative Humidity :	47~48%
Test Channel :	01	Test Engineer :	Adonis Li

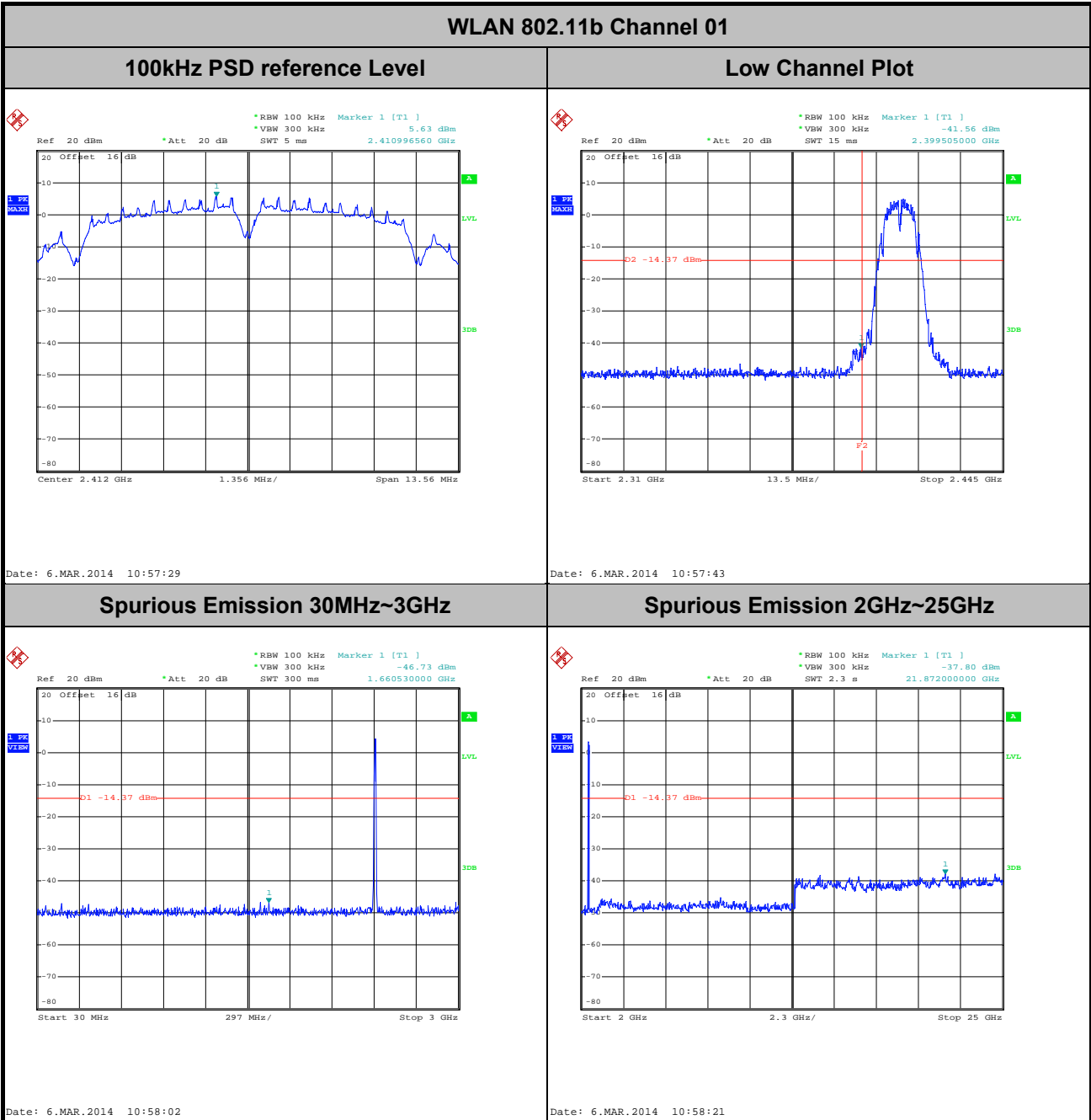



Test Mode :	802.11b	Temperature :	23~24°C
Test Band :	2.4GHz Mid	Relative Humidity :	47~48%
Test Channel :	06	Test Engineer :	Adonis Li

WLAN 802.11b Channel 06

100kHz PSD reference Level

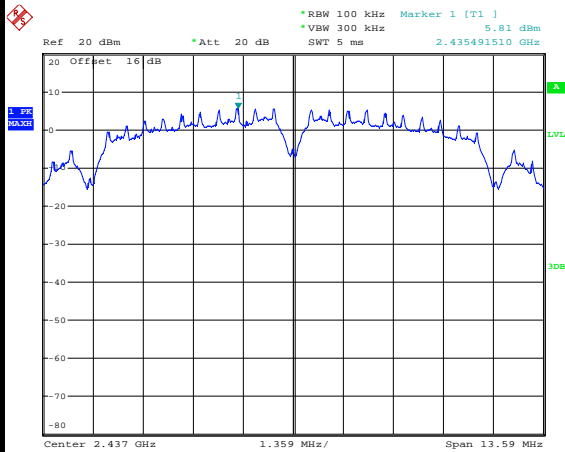

Date: 6.MAR.2014 11:01:09

Spurious Emission 30MHz~3GHz

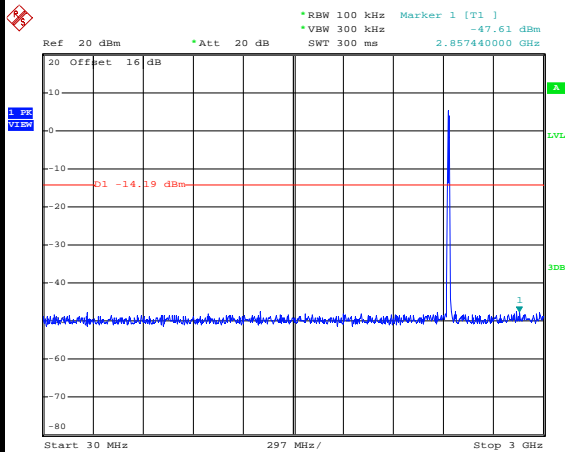

Date: 6.MAR.2014 11:01:29

Spurious Emission 2GHz~25GHz

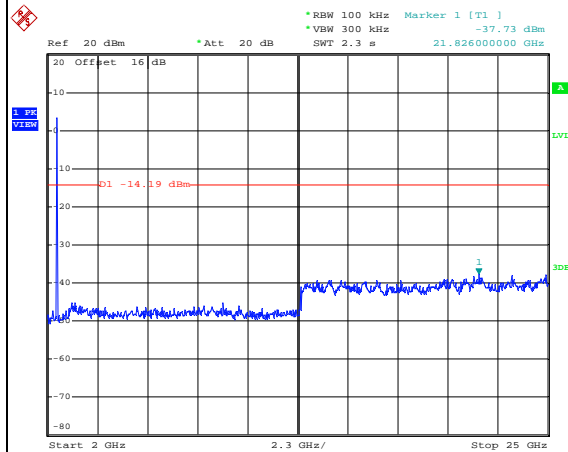

Date: 6.MAR.2014 11:01:48



Test Mode :	802.11b	Temperature :	23~24°C
Test Band :	2.4GHz High	Relative Humidity :	47~48%
Test Channel :	11	Test Engineer :	Adonis Li

WLAN 802.11b Channel 11

100kHz PSD reference Level

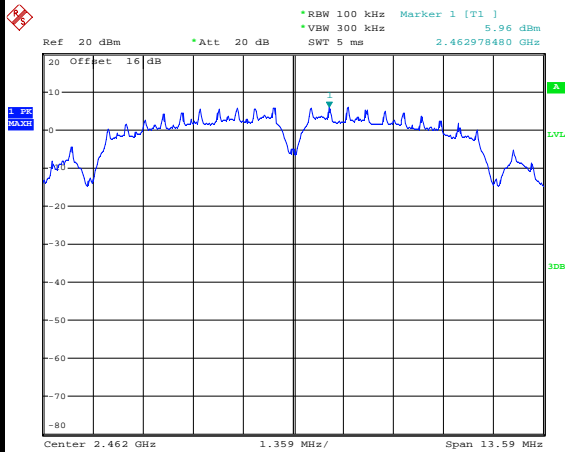

Date: 6.MAR.2014 13:26:55

High Channel Plot

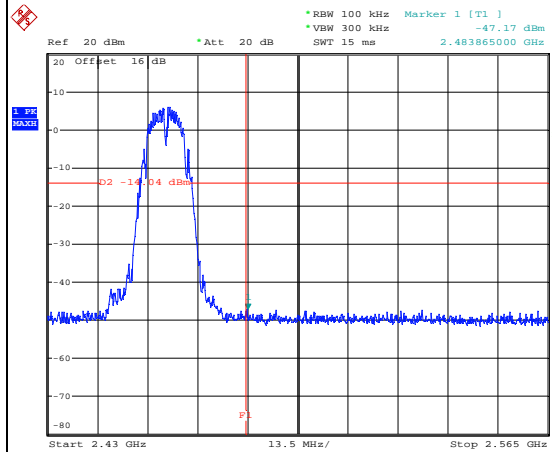

Date: 6.MAR.2014 13:27:09

Spurious Emission 30MHz~3GHz

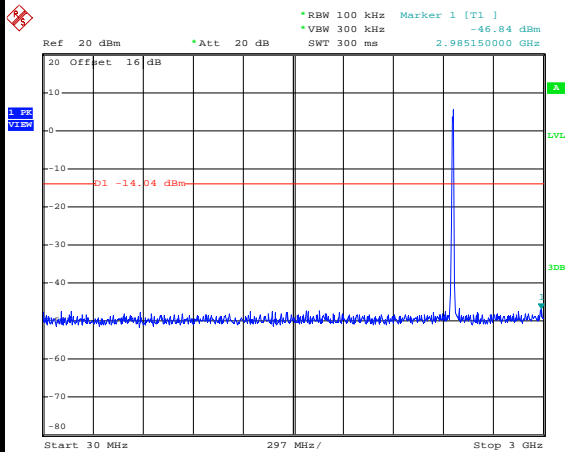

Date: 6.MAR.2014 13:27:29

Spurious Emission 2GHz~25GHz

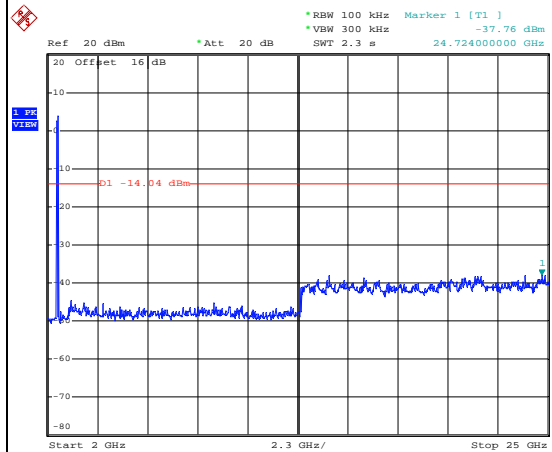

Date: 6.MAR.2014 13:27:47



Test Mode :	802.11g	Temperature :	23~24°C
Test Band :	2.4GHz Low	Relative Humidity :	47~48%
Test Channel :	01	Test Engineer :	Adonis Li

WLAN 802.11g Channel 01

100kHz PSD reference Level

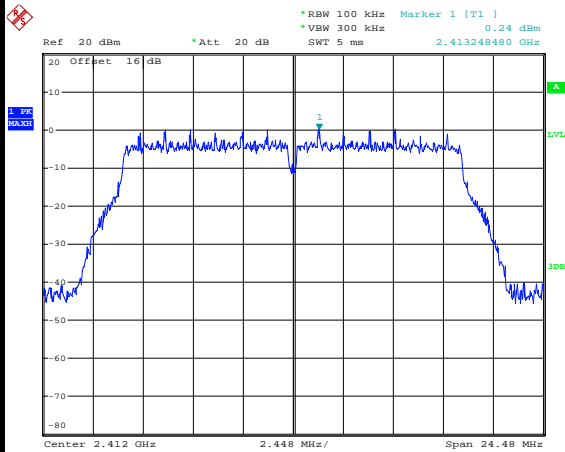

Date: 6.MAR.2014 11:08:07

Low Channel Plot

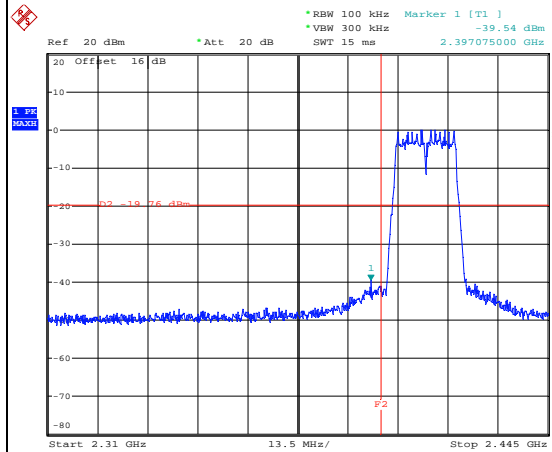

Date: 6.MAR.2014 11:08:21

Spurious Emission 30MHz~3GHz

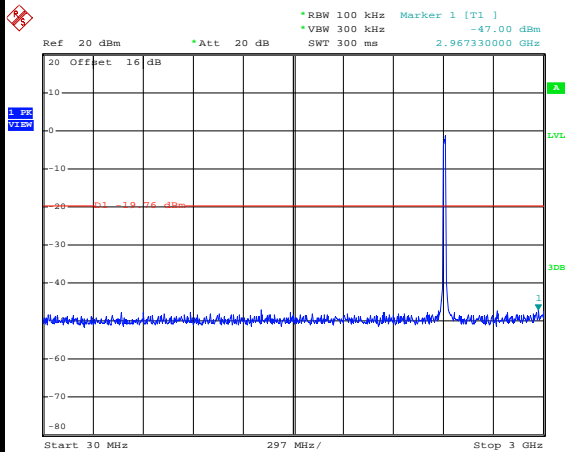

Date: 6.MAR.2014 11:08:40

Spurious Emission 2GHz~25GHz

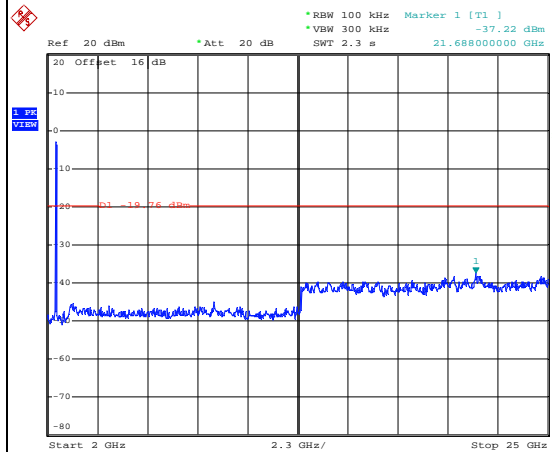

Date: 6.MAR.2014 11:08:59



Test Mode :	802.11g	Temperature :	23~24°C
Test Band :	2.4GHz Mid	Relative Humidity :	47~48%
Test Channel :	06	Test Engineer :	Adonis Li

WLAN 802.11g Channel 06

100kHz PSD reference Level

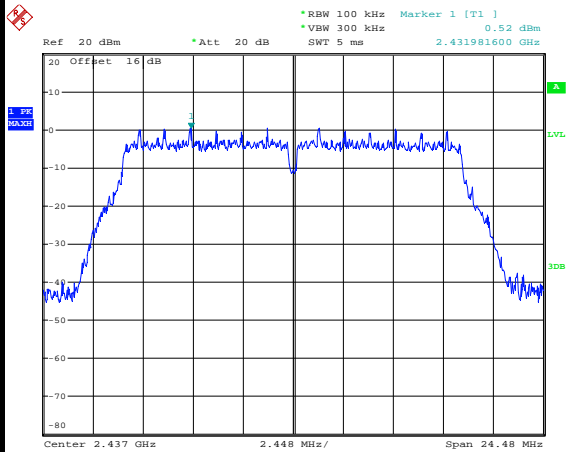

Date: 6.MAR.2014 11:11:28

Spurious Emission 30MHz~3GHz

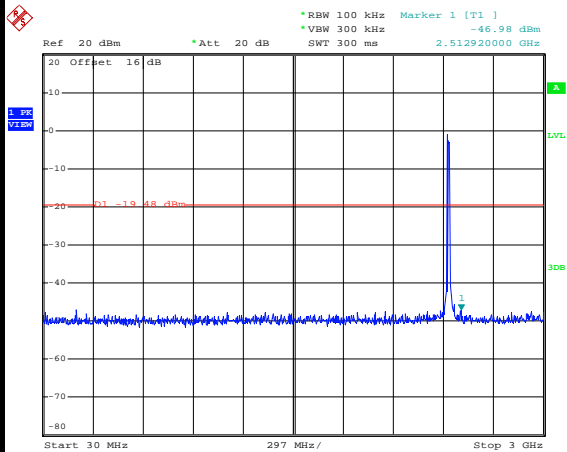

Date: 6.MAR.2014 11:11:47

Spurious Emission 2GHz~25GHz

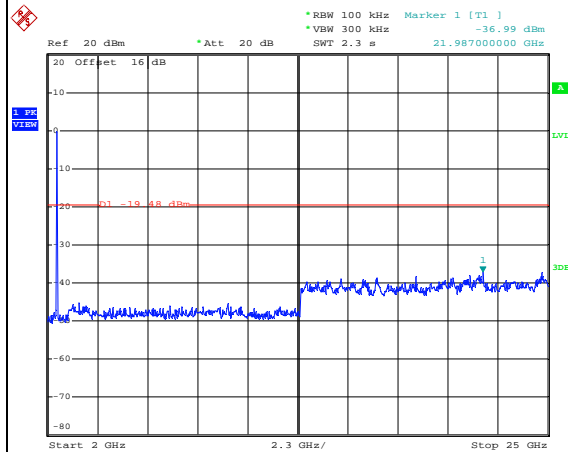

Date: 6.MAR.2014 11:12:06



Test Mode :	802.11g	Temperature :	23~24°C
Test Band :	2.4GHz High	Relative Humidity :	47~48%
Test Channel :	11	Test Engineer :	Adonis Li

WLAN 802.11g Channel 11

100kHz PSD reference Level

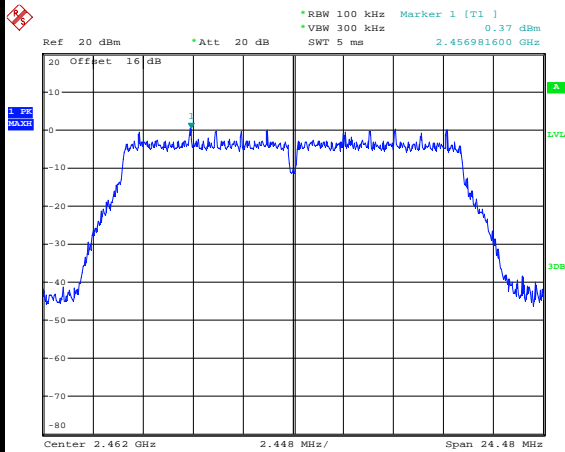

Date: 6.MAR.2014 11:14:17

High Channel Plot

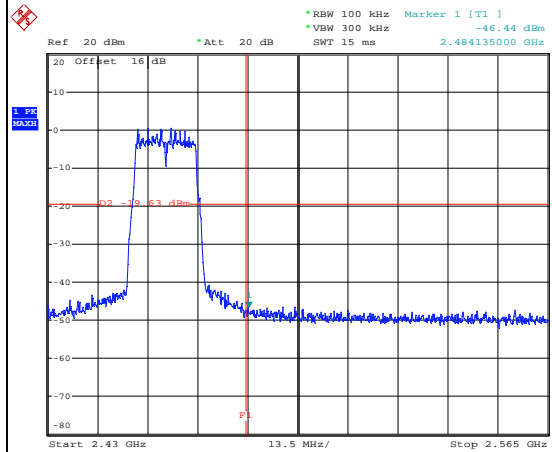

Date: 6.MAR.2014 11:14:31

Spurious Emission 30MHz~3GHz

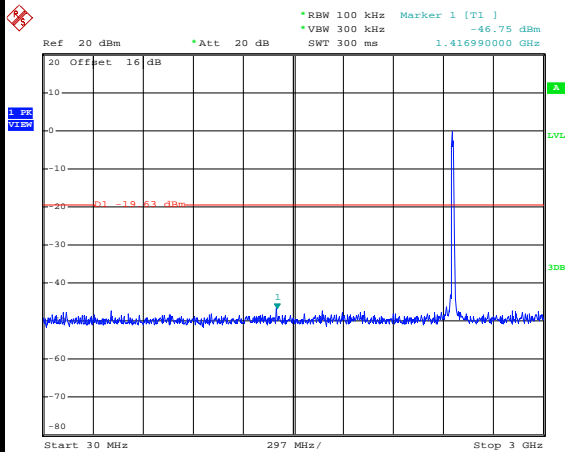

Date: 6.MAR.2014 11:14:50

Spurious Emission 2GHz~25GHz

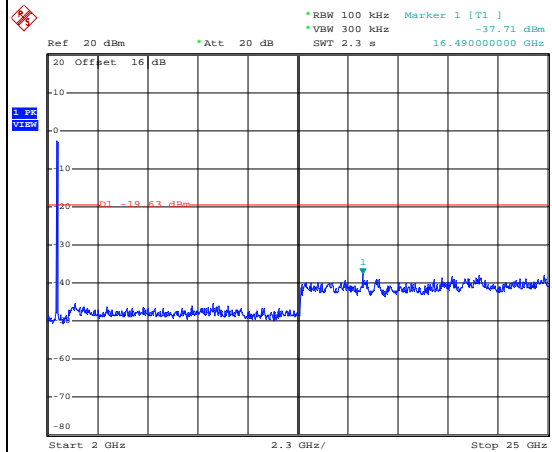

Date: 6.MAR.2014 11:15:09



Test Mode :	802.11n HT20	Temperature :	23~24°C
Test Band :	2.4GHz Low	Relative Humidity :	47~48%
Test Channel :	01	Test Engineer :	Adonis Li

WLAN 802.11n HT20 Channel 01

100kHz PSD reference Level

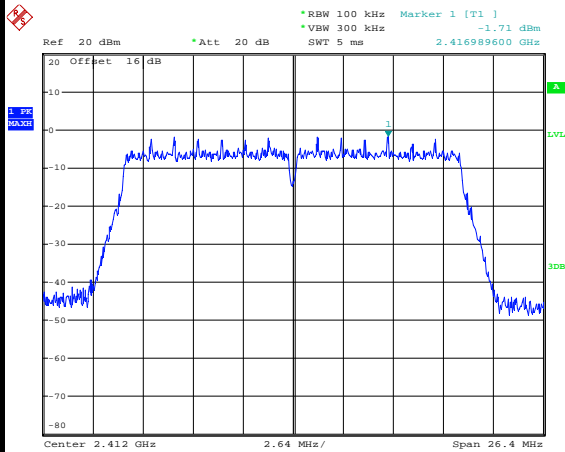

Date: 6.MAR.2014 11:17:31

Low Channel Plot

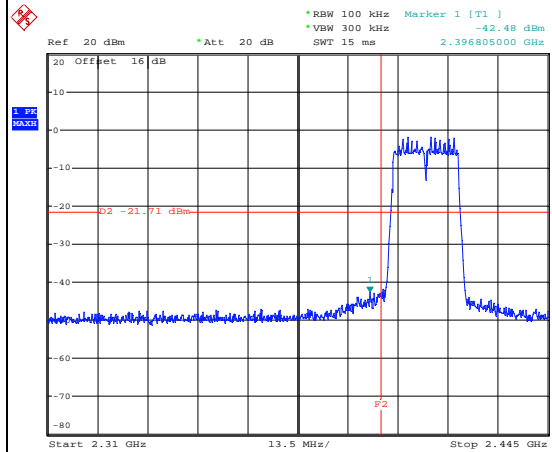

Date: 6.MAR.2014 11:17:44

Spurious Emission 30MHz~3GHz

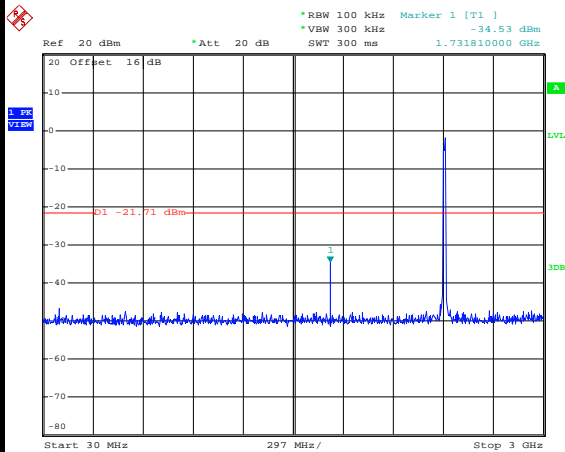

Date: 6.MAR.2014 11:18:04

Spurious Emission 2GHz~25GHz

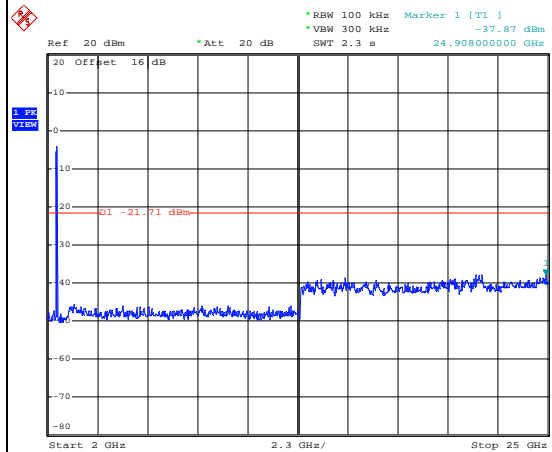

Date: 6.MAR.2014 11:18:22



Test Mode :	802.11n HT20	Temperature :	23~24°C
Test Band :	2.4GHz Mid	Relative Humidity :	47~48%
Test Channel :	06	Test Engineer :	Adonis Li

WLAN 802.11n HT20 Channel 06

100kHz PSD reference Level

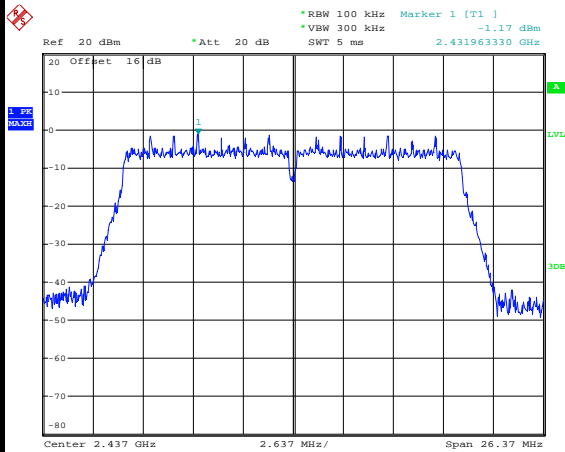

Date: 6.MAR.2014 11:23:12

Spurious Emission 30MHz~3GHz

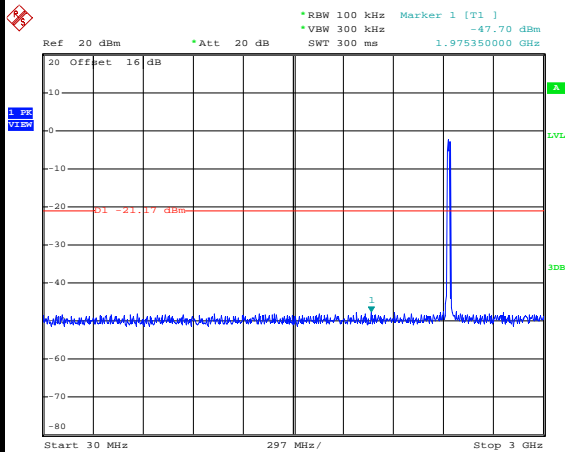

Date: 6.MAR.2014 11:23:32

Spurious Emission 2GHz~25GHz

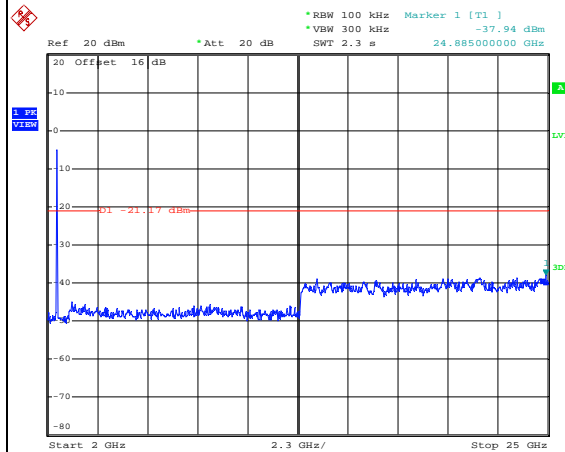

Date: 6.MAR.2014 11:23:51



Test Mode :	802.11n HT20	Temperature :	23~24°C
Test Band :	2.4GHz High	Relative Humidity :	47~48%
Test Channel :	11	Test Engineer :	Adonis Li

WLAN 802.11n HT20 Channel 11

100kHz PSD reference Level

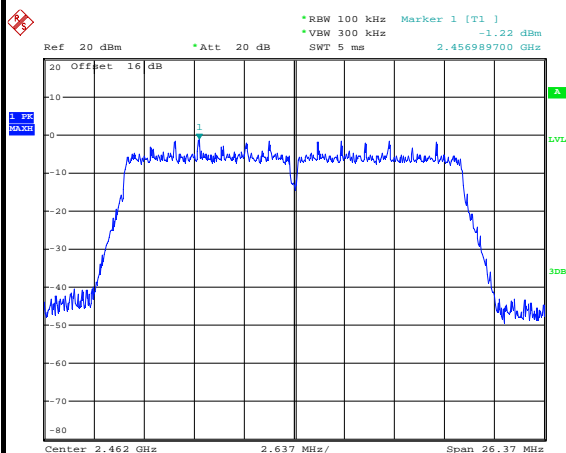

Date: 6.MAR.2014 11:26:17

High Channel Plot

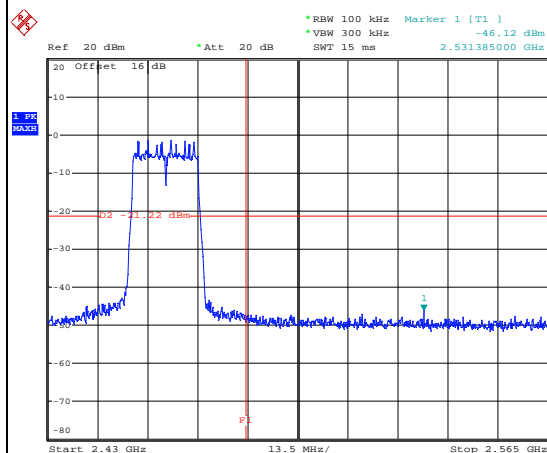

Date: 6.MAR.2014 11:26:31

Spurious Emission 30MHz~3GHz

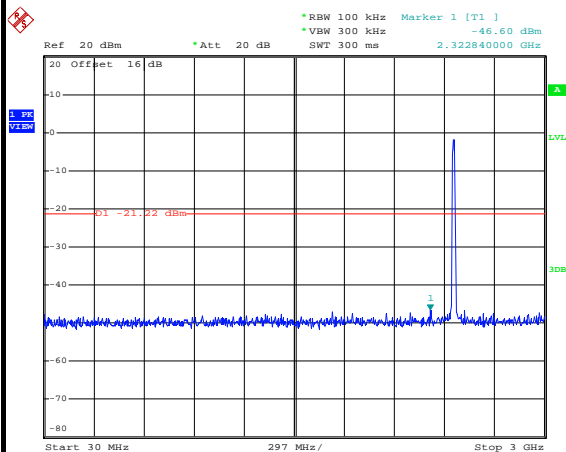

Date: 6.MAR.2014 11:26:50

Spurious Emission 2GHz~25GHz

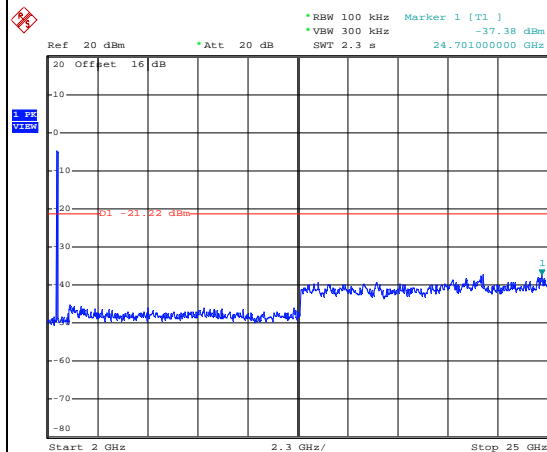

Date: 6.MAR.2014 11:27:09



Test Mode :	802.11n HT40	Temperature :	23~24°C
Test Band :	2.4GHz Low	Relative Humidity :	47~48%
Test Channel :	03	Test Engineer :	Adonis Li

WLAN 802.11n HT40 Channel 03

100kHz PSD reference Level

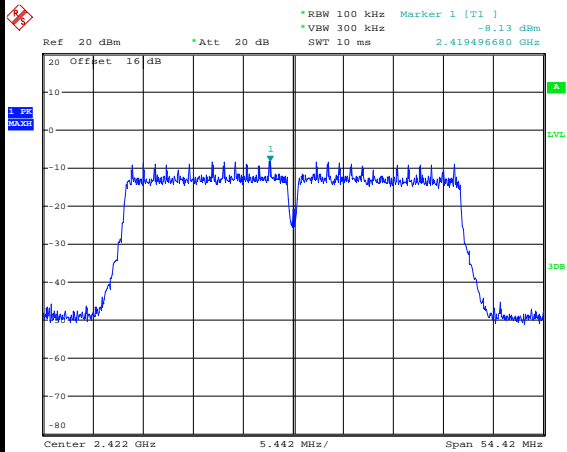

Date: 6.MAR.2014 11:30:13

Low Channel Plot

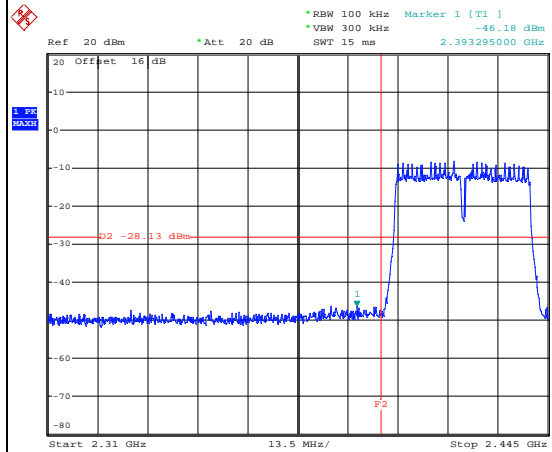

Date: 6.MAR.2014 11:30:27

Spurious Emission 30MHz~3GHz

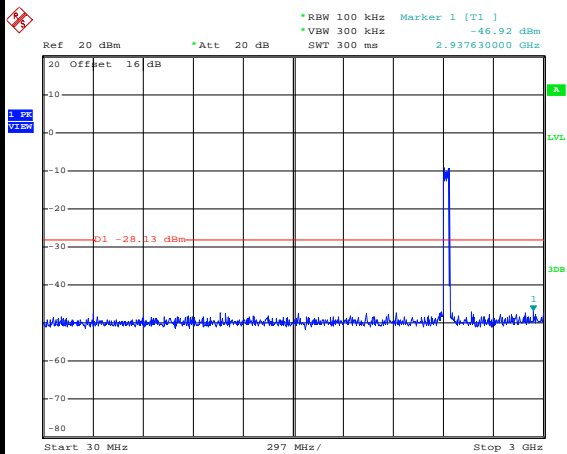

Date: 6.MAR.2014 11:34:23

Spurious Emission 2GHz~25GHz

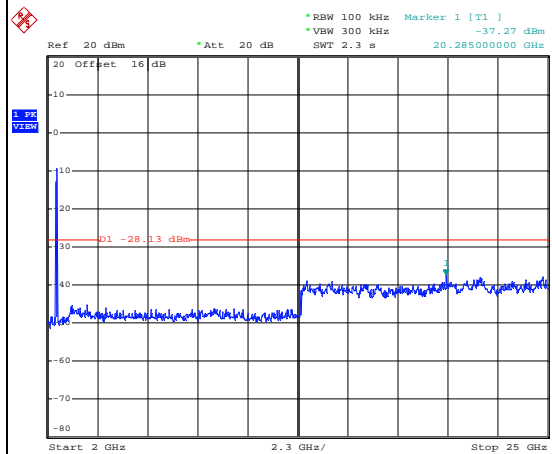

Date: 6.MAR.2014 11:33:24



Test Mode :	802.11n HT40	Temperature :	23~24°C
Test Band :	2.4GHz Mid	Relative Humidity :	47~48%
Test Channel :	06	Test Engineer :	Adonis Li

WLAN 802.11n HT40 Channel 06

100kHz PSD reference Level

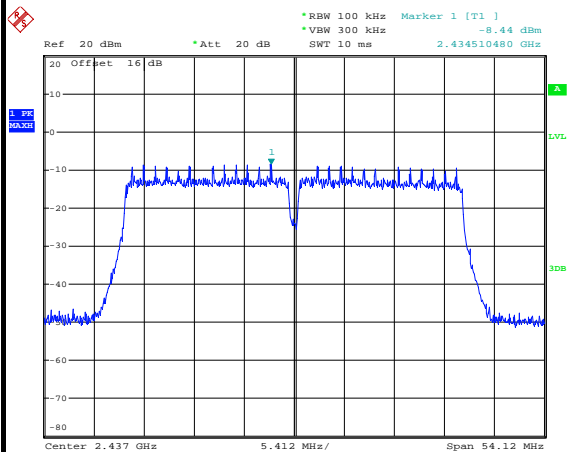

Date: 6.MAR.2014 11:37:10

Spurious Emission 30MHz~3GHz

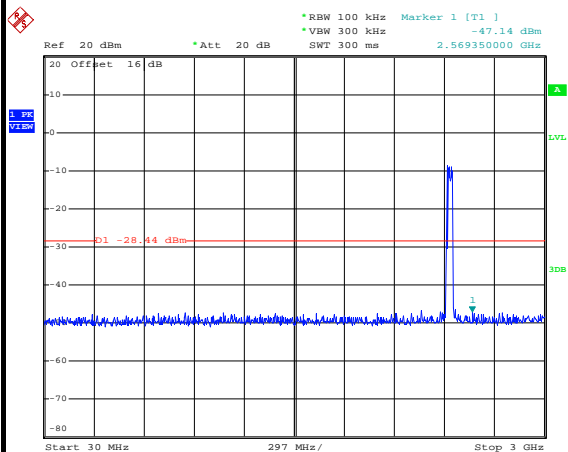

Date: 6.MAR.2014 11:40:26

Spurious Emission 2GHz~25GHz

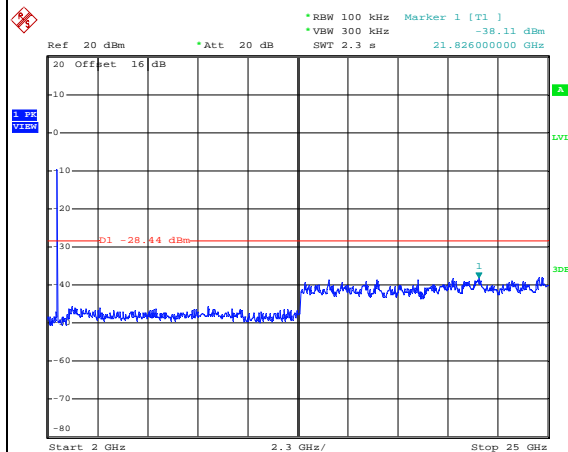

Date: 6.MAR.2014 11:37:48



Test Mode :	802.11n HT40	Temperature :	23~24°C
Test Band :	2.4GHz High	Relative Humidity :	47~48%
Test Channel :	09	Test Engineer :	Adonis Li

WLAN 802.11n HT40 Channel 09

100kHz PSD reference Level

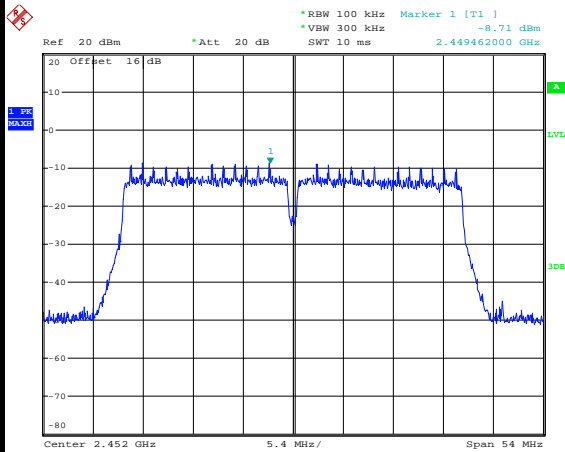

Date: 6.MAR.2014 11:43:38

High Channel Plot

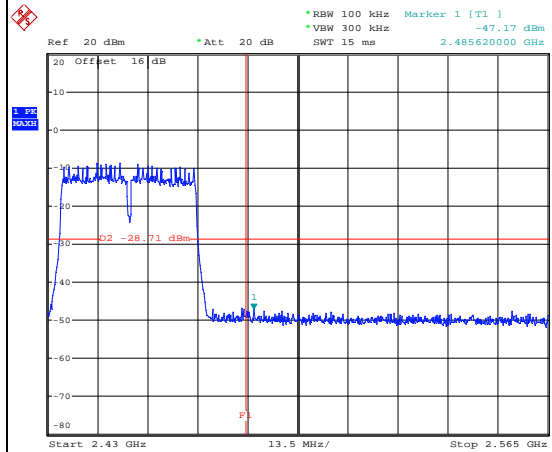

Date: 6.MAR.2014 11:43:51

Spurious Emission 30MHz~3GHz

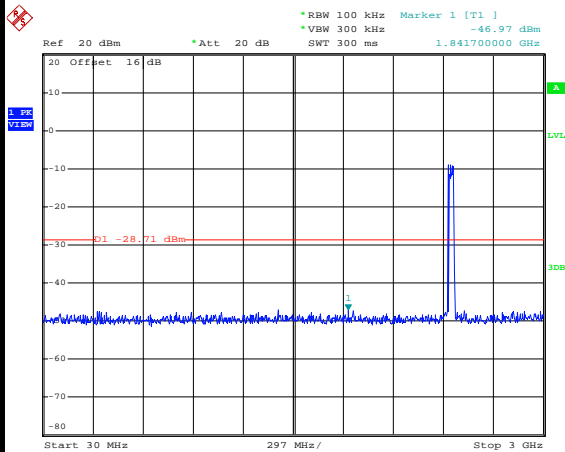

Date: 6.MAR.2014 11:47:36

Spurious Emission 2GHz~25GHz

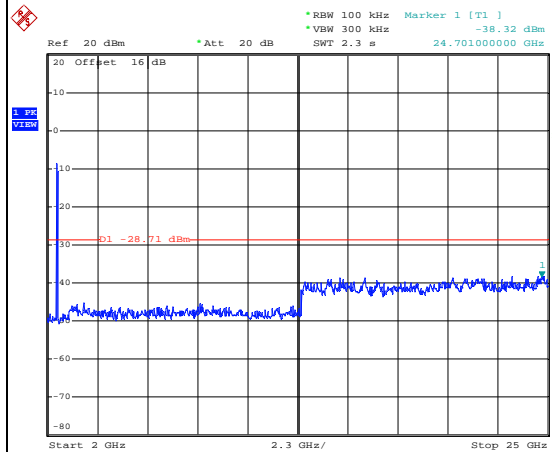

Date: 6.MAR.2014 11:44:29



3.5 Radiated Band Edges and Spurious Emission Measurement

3.5.1 Limit of Radiated band edge and Spurious Emission Measurement

In any 100 kHz bandwidth outside the intentional radiator frequency band, all harmonics/spurious must be at least 20 dB below the highest emission level within the authorized band. If the output power of this device was measured by spectrum analyzer, the attenuation under this paragraph shall be 30 dB instead of 20 dB. In addition, radiated emissions which fall in the restricted bands must also comply with the FCC section 15.209 limits as below.

Frequency (MHz)	Field Strength (microvolts/meter)	Measurement Distance (meters)
0.009 – 0.490	2400/F(kHz)	300
0.490 – 1.705	24000/F(kHz)	30
1.705 – 30.0	30	30
30 – 88	100	3
88 – 216	150	3
216 - 960	200	3
Above 960	500	3

3.5.2 Measuring Instruments

The measuring equipment is listed in the section 4 of this test report.

3.5.3 Test Procedures

1. The testing follows FCC KDB Publication No. 558074 D01 DTS Meas. Guidance v03r01.
2. The EUT was arranged to its worst case and then tune the antenna tower (from 1 m to 4 m) and turntable (from 0 degree to 360 degrees) to find the maximum reading. A pre-amp and a high pass filter are used for the test in order to get better signal level.
3. The EUT was placed on a turntable with 0.8 meter above ground.
4. The EUT was set 3 meters from the interference receiving antenna, which was mounted on the top of a variable height antenna tower.
5. Corrected Reading: Antenna Factor + Cable Loss + Read Level - Preamp Factor = Level
6. For measurement below 1GHz, If the emission level of the EUT measured by the peak detector is 3 dB lower than the applicable limit, the peak emission level will be reported. Otherwise, the emission measurement will be repeated using the quasi-peak detector and reported.
7. Use the following spectrum analyzer settings:
 - (1) Span shall wide enough to fully capture the emission being measured;
 - (2) Set RBW=100 kHz for $f < 1$ GHz; $VBW \geq RBW$; Sweep = auto; Detector function = peak; Trace = max hold;
 - (3) Set RBW = 1 MHz, VBW= 3MHz for $f \geq 1$ GHz for peak measurement.
 For average measurement:
 - $VBW = 10$ Hz, when duty cycle is no less than 98 percent.
 - $VBW \geq 1/T$, when duty cycle is less than 98 percent where T is the minimum transmission duration over which the transmitter is on and is transmitting at its maximum power control level for the tested mode of operation.

Band	Duty Cycle (%)	T(ms)	1/T(kHz)	VBW Setting
802.11b	98.00	-	-	10Hz
802.11g	89.09	1.388	0.720	1kHz
2.4GHz 802.11n HT20	88.45	1.302	0.768	1kHz
2.4GHz 802.11n HT40	78.64	0.648	1.543	3kHz

3.5.4 Test Setup

For radiated emissions below 30MHz

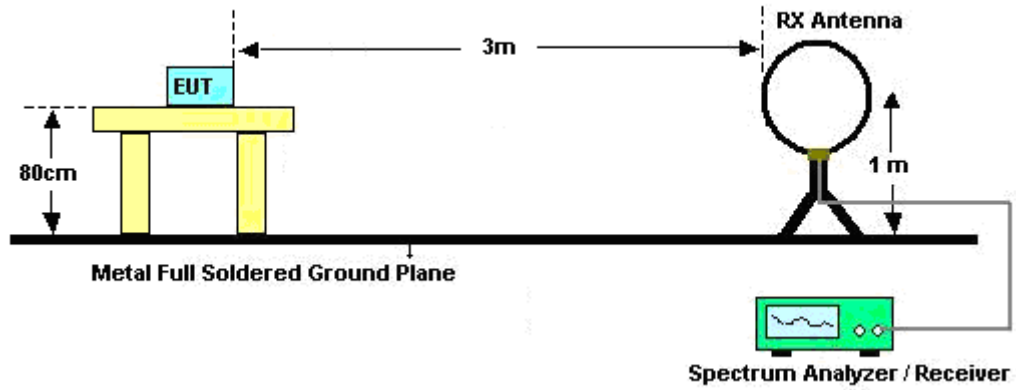

For radiated emissions from 30MHz to 1GHz

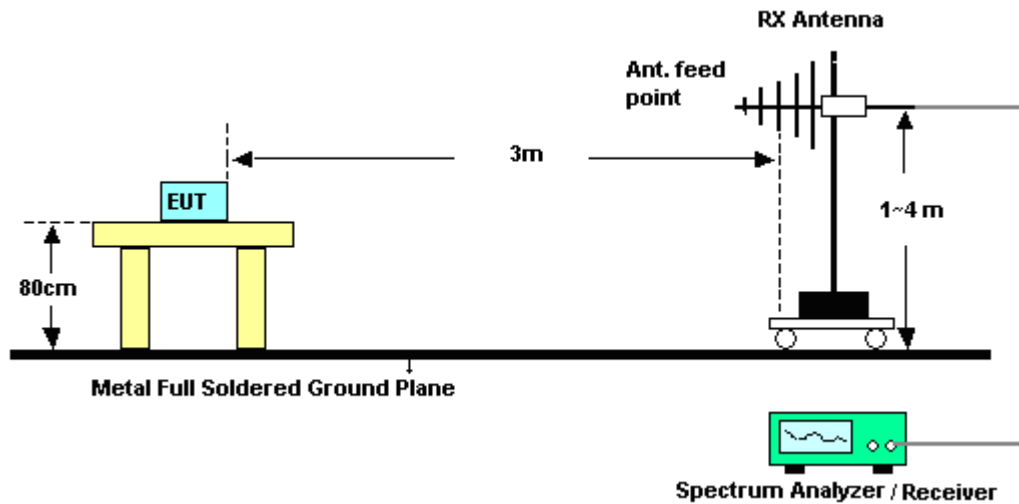

For radiated emissions above 1GHz

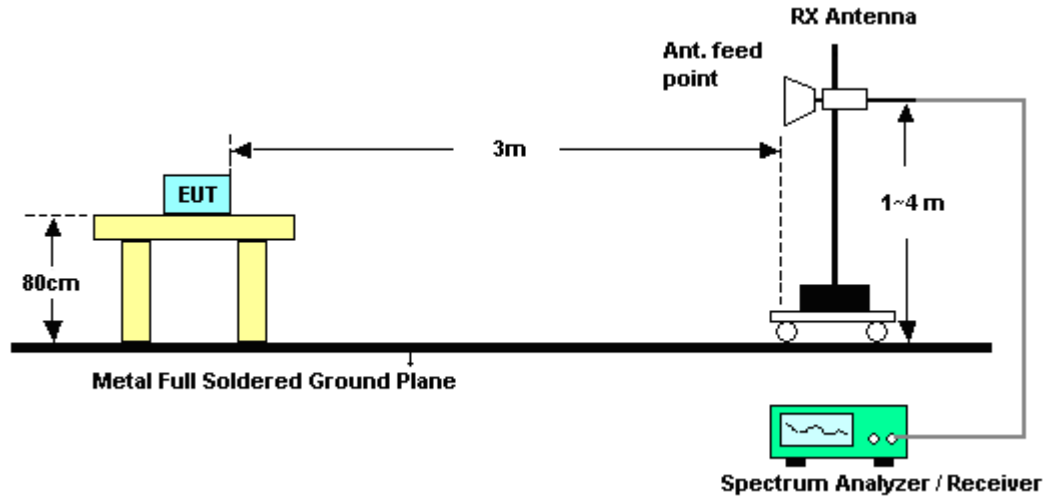

3.5.5 Test Results of Radiated Spurious Emissions (9kHz ~ 30MHz)

The low frequency, which started from 9 kHz to 30MHz, was pre-scanned and the result which was 20dB lower than the limit line per 15.31(o) was not reported.



3.5.6 Test Result of Radiated Spurious at Band Edges

Test Mode :	802.11b	Temperature :	22~23°C
Test Band :	Low	Relative Humidity :	40~41%
Test Channel :	01	Test Engineer :	Jun Liu

ANTENNA POLARITY : HORIZONTAL										
Frequency (MHz)	Level (dBμV/m)	Over Limit (dB)	Limit Line (dBμV/m)	Read Level (dBμV)	Antenna Factor (dB)	Cable Loss (dB)	Preamp Factor (dB)	Ant Pos (cm)	Table Pos (deg)	Remark
2386.95	55.06	-18.94	74	51.87	32.86	3.59	33.26	197	155	Peak
2386.32	38.9	-15.1	54	35.71	32.86	3.59	33.26	197	155	Average

ANTENNA POLARITY : VERTICAL										
Frequency (MHz)	Level (dBμV/m)	Over Limit (dB)	Limit Line (dBμV/m)	Read Level (dBμV)	Antenna Factor (dB)	Cable Loss (dB)	Preamp Factor (dB)	Ant Pos (cm)	Table Pos (deg)	Remark
2373.36	53.09	-20.91	74	49.94	32.83	3.58	33.26	100	82	Peak
2386.23	37.86	-16.14	54	34.67	32.86	3.59	33.26	100	82	Average

Test Mode :	802.11b	Temperature :	22~23°C
Test Band :	High	Relative Humidity :	40~41%
Test Channel :	11	Test Engineer :	Jun Liu

ANTENNA POLARITY : HORIZONTAL										
Frequency (MHz)	Level (dBμV/m)	Over Limit (dB)	Limit Line (dBμV/m)	Read Level (dBμV)	Antenna Factor (dB)	Cable Loss (dB)	Preamp Factor (dB)	Ant Pos (cm)	Table Pos (deg)	Remark
2492.83	54.99	-19.01	74	51.58	33.05	3.66	33.3	100	152	Peak
2494.96	39.16	-14.84	54	35.75	33.05	3.66	33.3	100	152	Average

ANTENNA POLARITY : VERTICAL										
Frequency (MHz)	Level (dBμV/m)	Over Limit (dB)	Limit Line (dBμV/m)	Read Level (dBμV)	Antenna Factor (dB)	Cable Loss (dB)	Preamp Factor (dB)	Ant Pos (cm)	Table Pos (deg)	Remark
2489.08	50.74	-23.26	74	47.33	33.05	3.66	33.3	200	135	Peak
2486.65	36.84	-17.16	54	33.47	33.01	3.65	33.29	200	135	Average



Test Mode :	802.11g	Temperature :	22~23°C
Test Band :	Low	Relative Humidity :	40~41%
Test Channel :	01	Test Engineer :	Jun Liu

ANTENNA POLARITY : HORIZONTAL										
Frequency (MHz)	Level (dBμV/m)	Over Limit (dB)	Limit Line (dBμV/m)	Read Level (dBμV)	Antenna Factor (dB)	Cable Loss (dB)	Preamp Factor (dB)	Ant Pos (cm)	Table Pos (deg)	Remark
2389.38	69.89	-4.11	74	66.7	32.86	3.59	33.26	200	153	Peak
2389.92	49.71	-4.29	54	46.52	32.86	3.59	33.26	200	153	Average

ANTENNA POLARITY : VERTICAL										
Frequency (MHz)	Level (dBμV/m)	Over Limit (dB)	Limit Line (dBμV/m)	Read Level (dBμV)	Antenna Factor (dB)	Cable Loss (dB)	Preamp Factor (dB)	Ant Pos (cm)	Table Pos (deg)	Remark
2388.3	64.49	-9.51	74	61.3	32.86	3.59	33.26	100	48	Peak
2389.83	45.32	-8.68	54	42.13	32.86	3.59	33.26	100	48	Average

Test Mode :	802.11g	Temperature :	22~23°C
Test Band :	High	Relative Humidity :	40~41%
Test Channel :	11	Test Engineer :	Jun Liu

ANTENNA POLARITY : HORIZONTAL										
Frequency (MHz)	Level (dBμV/m)	Over Limit (dB)	Limit Line (dBμV/m)	Read Level (dBμV)	Antenna Factor (dB)	Cable Loss (dB)	Preamp Factor (dB)	Ant Pos (cm)	Table Pos (deg)	Remark
2483.8	69.35	-4.65	74	65.98	33.01	3.65	33.29	100	155	Peak
2483.62	45.23	-8.77	54	41.86	33.01	3.65	33.29	100	155	Average

ANTENNA POLARITY : VERTICAL										
Frequency (MHz)	Level (dBμV/m)	Over Limit (dB)	Limit Line (dBμV/m)	Read Level (dBμV)	Antenna Factor (dB)	Cable Loss (dB)	Preamp Factor (dB)	Ant Pos (cm)	Table Pos (deg)	Remark
2483.59	65.38	-8.62	74	62.01	33.01	3.65	33.29	100	116	Peak
2483.5	42.36	-11.64	54	38.99	33.01	3.65	33.29	100	116	Average



Test Mode :	802.11n HT20	Temperature :	22~23°C
Test Band :	Low	Relative Humidity :	40~41%
Test Channel :	01	Test Engineer :	Jun Liu

ANTENNA POLARITY : HORIZONTAL										
Frequency (MHz)	Level (dBμV/m)	Over Limit (dB)	Limit Line (dBμV/m)	Read Level (dBμV)	Antenna Factor (dB)	Cable Loss (dB)	Preamp Factor (dB)	Ant Pos (cm)	Table Pos (deg)	Remark
2389.56	69.09	-4.91	74	65.9	32.86	3.59	33.26	106	158	Peak
2390	49.41	-4.59	54	46.22	32.86	3.59	33.26	106	158	Average

ANTENNA POLARITY : VERTICAL										
Frequency (MHz)	Level (dBμV/m)	Over Limit (dB)	Limit Line (dBμV/m)	Read Level (dBμV)	Antenna Factor (dB)	Cable Loss (dB)	Preamp Factor (dB)	Ant Pos (cm)	Table Pos (deg)	Remark
2389.65	70.82	-3.18	74	67.63	32.86	3.59	33.26	100	130	Peak
2390	47.27	-6.73	54	44.08	32.86	3.59	33.26	100	130	Average

Test Mode :	802.11n HT20	Temperature :	22~23°C
Test Band :	High	Relative Humidity :	40~41%
Test Channel :	11	Test Engineer :	Jun Liu

ANTENNA POLARITY : HORIZONTAL										
Frequency (MHz)	Level (dBμV/m)	Over Limit (dB)	Limit Line (dBμV/m)	Read Level (dBμV)	Antenna Factor (dB)	Cable Loss (dB)	Preamp Factor (dB)	Ant Pos (cm)	Table Pos (deg)	Remark
2483.59	67.72	-6.28	74	64.35	33.01	3.65	33.29	185	156	Peak
2483.59	44.74	-9.26	54	41.37	33.01	3.65	33.29	185	156	Average

ANTENNA POLARITY : VERTICAL										
Frequency (MHz)	Level (dBμV/m)	Over Limit (dB)	Limit Line (dBμV/m)	Read Level (dBμV)	Antenna Factor (dB)	Cable Loss (dB)	Preamp Factor (dB)	Ant Pos (cm)	Table Pos (deg)	Remark
2484.28	67.52	-6.48	74	64.15	33.01	3.65	33.29	100	118	Peak
2483.5	43.67	-10.33	54	40.3	33.01	3.65	33.29	100	118	Average



Test Mode :	802.11n HT40	Temperature :	22~23°C
Test Band :	Low	Relative Humidity :	40~41%
Test Channel :	03	Test Engineer :	Jun Liu

ANTENNA POLARITY : HORIZONTAL										
Frequency (MHz)	Level (dBμV/m)	Over Limit (dB)	Limit Line (dBμV/m)	Read Level (dBμV)	Antenna Factor (dB)	Cable Loss (dB)	Preamp Factor (dB)	Ant Pos (cm)	Table Pos (deg)	Remark
2388.03	69.04	-4.96	74	65.85	32.86	3.59	33.26	198	161	Peak
2389.74	50.32	-3.68	54	47.13	32.86	3.59	33.26	198	161	Average
2488.93	48.45	-25.55	74	45.04	33.05	3.66	33.3	198	161	Peak
2484.01	36.64	-17.36	54	33.27	33.01	3.65	33.29	198	161	Average

ANTENNA POLARITY : VERTICAL										
Frequency (MHz)	Level (dBμV/m)	Over Limit (dB)	Limit Line (dBμV/m)	Read Level (dBμV)	Antenna Factor (dB)	Cable Loss (dB)	Preamp Factor (dB)	Ant Pos (cm)	Table Pos (deg)	Remark
2388.39	64.59	-9.41	74	61.4	32.86	3.59	33.26	100	88	Peak
2386.41	46.19	-7.81	54	43	32.86	3.59	33.26	100	88	Average
2491.75	48.59	-25.41	74	45.18	33.05	3.66	33.3	100	88	Peak
2488.69	36.15	-17.85	54	32.74	33.05	3.66	33.3	100	88	Average



Test Mode :	802.11n HT40	Temperature :	22~23°C
Test Band :	High	Relative Humidity :	40~41%
Test Channel :	09	Test Engineer :	Jun Liu

ANTENNA POLARITY : HORIZONTAL										
Frequency (MHz)	Level (dBμV/m)	Over Limit (dB)	Limit Line (dBμV/m)	Read Level (dBμV)	Antenna Factor (dB)	Cable Loss (dB)	Preamp Factor (dB)	Ant Pos (cm)	Table Pos (deg)	Remark
2382.09	48.66	-25.34	74	45.51	32.83	3.58	33.26	100	154	Peak
2378.67	35.97	-18.03	54	32.82	32.83	3.58	33.26	100	154	Average
2488.54	55.7	-18.3	74	52.29	33.05	3.66	33.3	191	156	Peak
2484.04	39.39	-14.61	54	36.02	33.01	3.65	33.29	191	156	Average

ANTENNA POLARITY : VERTICAL										
Frequency (MHz)	Level (dBμV/m)	Over Limit (dB)	Limit Line (dBμV/m)	Read Level (dBμV)	Antenna Factor (dB)	Cable Loss (dB)	Preamp Factor (dB)	Ant Pos (cm)	Table Pos (deg)	Remark
2384.07	49.79	-24.21	74	46.64	32.83	3.58	33.26	100	94	Peak
2383.62	37.41	-16.59	54	34.26	32.83	3.58	33.26	100	94	Average
2487.49	52.46	-21.54	74	49.09	33.01	3.65	33.29	100	112	Peak
2484.43	37.57	-16.43	54	34.2	33.01	3.65	33.29	100	112	Average



3.5.7 Test Result of Radiated Spurious Emission (30MHz ~ 10th Harmonic)

Note: Pre-scanned all test modes and only choose the worst case mode recorded in the test report for radiated spurious emission below 1GHz.

Test Mode :	802.11b	Temperature :	22~23°C
Test Channel :	01	Relative Humidity :	40~41%
Test Engineer :	Jun Liu	Polarization :	Horizontal
Remark :	1. 2412 MHz is fundamental signal which can be ignored. 2. Average measurement was not performed if peak level went lower than the average limit.		

Frequency (MHz)	Level (dBμV/m)	Over Limit (dB)	Limit Line (dBμV/m)	Read Level (dBμV)	Antenna Factor (dB)	Cable Loss (dB)	Preamp Factor (dB)	Ant Pos (cm)	Table Pos (deg)	Remark
2412	107.35	-	-	104.12	32.89	3.61	33.27	196	157	Peak
2412	101.34	-	-	98.11	32.89	3.61	33.27	196	157	Average
4824	48.33	-25.67	74	41.71	35.17	5.25	33.8	100	220	Peak

Test Mode :	802.11b	Temperature :	22~23°C
Test Channel :	01	Relative Humidity :	40~41%
Test Engineer :	Jun Liu	Polarization :	Vertical
Remark :	1. 2412 MHz is fundamental signal which can be ignored. 2. Average measurement was not performed if peak level went lower than the average limit.		

Frequency (MHz)	Level (dBμV/m)	Over Limit (dB)	Limit Line (dBμV/m)	Read Level (dBμV)	Antenna Factor (dB)	Cable Loss (dB)	Preamp Factor (dB)	Ant Pos (cm)	Table Pos (deg)	Remark
2412	103.46	-	-	100.23	32.89	3.61	33.27	100	68	Peak
2412	97.31	-	-	94.08	32.89	3.61	33.27	100	68	Average
4824	45.91	-28.09	74	39.29	35.17	5.25	33.8	121	178	Peak



Test Mode :	802.11b	Temperature :	22~23°C
Test Channel :	06	Relative Humidity :	40~41%
Test Engineer :	Jun Liu	Polarization :	Horizontal
Remark :	1. 2437 MHz is fundamental signal which can be ignored. 2. Average measurement was not performed if peak level went lower than the average limit.		

Frequency (MHz)	Level (dBμV/m)	Over Limit (dB)	Limit Line (dBμV/m)	Read Level (dBμV)	Antenna Factor (dB)	Cable Loss (dB)	Preamp Factor (dB)	Ant Pos (cm)	Table Pos (deg)	Remark
2437	108.47	-	-	105.17	32.95	3.63	33.28	200	157	Peak
2437	102.26	-	-	98.96	32.95	3.63	33.28	200	157	Average
4874	46.76	-27.24	74	40.1	35.18	5.28	33.8	100	56	Peak
7312	48.44	-25.56	74	39.76	36.2	6.61	34.13	100	45	Peak

Test Mode :	802.11b	Temperature :	22~23°C
Test Channel :	06	Relative Humidity :	40~41%
Test Engineer :	Jun Liu	Polarization :	Vertical
Remark :	1. 2437 MHz is fundamental signal which can be ignored. 2. Average measurement was not performed if peak level went lower than the average limit.		

Frequency (MHz)	Level (dBμV/m)	Over Limit (dB)	Limit Line (dBμV/m)	Read Level (dBμV)	Antenna Factor (dB)	Cable Loss (dB)	Preamp Factor (dB)	Ant Pos (cm)	Table Pos (deg)	Remark
2437	105.2	-	-	101.9	32.95	3.63	33.28	167	104	Peak
2437	99.04	-	-	95.74	32.95	3.63	33.28	167	104	Average
4874	46.76	-27.24	74	40.1	35.18	5.28	33.8	100	261	Peak
7312	49.07	-24.93	74	40.39	36.2	6.61	34.13	100	122	Peak



Test Mode :	802.11b	Temperature :	22~23°C
Test Channel :	11	Relative Humidity :	40~41%
Test Engineer :	Jun Liu	Polarization :	Horizontal
Remark :	1. 2462 MHz is fundamental signal which can be ignored. 2. Average measurement was not performed if peak level went lower than the average limit.		

Frequency (MHz)	Level (dBμV/m)	Over Limit (dB)	Limit Line (dBμV/m)	Read Level (dBμV)	Antenna Factor (dB)	Cable Loss (dB)	Preamp Factor (dB)	Ant Pos (cm)	Table Pos (deg)	Remark
2462	109.45	-	-	106.12	32.98	3.64	33.29	103	157	Peak
2462	103.22	-	-	99.89	32.98	3.64	33.29	103	157	Average
4924	45.96	-28.04	74	39.26	35.19	5.31	33.8	100	22	Peak
7386	48.99	-25.01	74	40.21	36.24	6.7	34.16	100	41	Peak

Test Mode :	802.11b	Temperature :	22~23°C
Test Channel :	11	Relative Humidity :	40~41%
Test Engineer :	Jun Liu	Polarization :	Vertical
Remark :	1. 2462 MHz is fundamental signal which can be ignored. 2. Average measurement was not performed if peak level went lower than the average limit.		

Frequency (MHz)	Level (dBμV/m)	Over Limit (dB)	Limit Line (dBμV/m)	Read Level (dBμV)	Antenna Factor (dB)	Cable Loss (dB)	Preamp Factor (dB)	Ant Pos (cm)	Table Pos (deg)	Remark
2462	104.07	-	-	100.74	32.98	3.64	33.29	100	67	Peak
2462	97.87	-	-	94.54	32.98	3.64	33.29	100	67	Average
4924	46.6	-27.4	74	39.9	35.19	5.31	33.8	100	261	Peak
7386	48.56	-25.44	74	39.78	36.24	6.7	34.16	100	151	Peak



Test Mode :	802.11g	Temperature :	22~23°C
Test Channel :	01	Relative Humidity :	40~41%
Test Engineer :	Jun Liu	Polarization :	Horizontal
Remark :	1. 2412 MHz is fundamental signal which can be ignored. 2. Average measurement was not performed if peak level went lower than the average limit.		

Frequency (MHz)	Level (dBμV/m)	Over Limit (dB)	Limit Line (dBμV/m)	Read Level (dBμV)	Antenna Factor (dB)	Cable Loss (dB)	Preamp Factor (dB)	Ant Pos (cm)	Table Pos (deg)	Remark
2412	105.65	-	-	102.42	32.89	3.61	33.27	162	51	Peak
2412	94.54	-	-	91.31	32.89	3.61	33.27	162	51	Average
4824	46.15	-27.85	74	39.53	35.17	5.25	33.8	100	56	Peak

Test Mode :	802.11g	Temperature :	22~23°C
Test Channel :	01	Relative Humidity :	40~41%
Test Engineer :	Jun Liu	Polarization :	Vertical
Remark :	1. 2412 MHz is fundamental signal which can be ignored. 2. Average measurement was not performed if peak level went lower than the average limit.		

Frequency (MHz)	Level (dBμV/m)	Over Limit (dB)	Limit Line (dBμV/m)	Read Level (dBμV)	Antenna Factor (dB)	Cable Loss (dB)	Preamp Factor (dB)	Ant Pos (cm)	Table Pos (deg)	Remark
2412	103.85	-	-	100.62	32.89	3.61	33.27	100	48	Peak
2412	92.36	-	-	89.13	32.89	3.61	33.27	100	48	Average
4824	48.1	-25.9	74	41.48	35.17	5.25	33.8	100	126	Peak



Test Mode :	802.11g	Temperature :	22~23°C
Test Channel :	06	Relative Humidity :	40~41%
Test Engineer :	Jun Liu	Polarization :	Horizontal
Remark :	1. 2437 MHz is fundamental signal which can be ignored. 2. Average measurement was not performed if peak level went lower than the average limit.		

Frequency (MHz)	Level (dBμV/m)	Over Limit (dB)	Limit Line (dBμV/m)	Read Level (dBμV)	Antenna Factor (dB)	Cable Loss (dB)	Preamp Factor (dB)	Ant Pos (cm)	Table Pos (deg)	Remark
2437	107.4	-	-	104.1	32.95	3.63	33.28	160	158	Peak
2437	96.11	-	-	92.81	32.95	3.63	33.28	160	158	Average
4874	47.04	-26.96	74	40.38	35.18	5.28	33.8	100	119	Peak
7312	49.04	-24.96	74	40.36	36.2	6.61	34.13	100	48	Peak

Test Mode :	802.11g	Temperature :	22~23°C
Test Channel :	06	Relative Humidity :	40~41%
Test Engineer :	Jun Liu	Polarization :	Vertical
Remark :	1. 2437 MHz is fundamental signal which can be ignored. 2. Average measurement was not performed if peak level went lower than the average limit.		

Frequency (MHz)	Level (dBμV/m)	Over Limit (dB)	Limit Line (dBμV/m)	Read Level (dBμV)	Antenna Factor (dB)	Cable Loss (dB)	Preamp Factor (dB)	Ant Pos (cm)	Table Pos (deg)	Remark
2437	105.54	-	-	102.24	32.95	3.63	33.28	100	119	Peak
2437	94.42	-	-	91.12	32.95	3.63	33.28	100	119	Average
4874	47.82	-26.18	74	41.16	35.18	5.28	33.8	100	14	Peak
7312	50.06	-23.94	74	41.38	36.2	6.61	34.13	100	61	Peak



Test Mode :	802.11g	Temperature :	22~23°C
Test Channel :	11	Relative Humidity :	40~41%
Test Engineer :	Jun Liu	Polarization :	Horizontal
Remark :	1. 2462 MHz is fundamental signal which can be ignored. 2. Average measurement was not performed if peak level went lower than the average limit.		

Frequency (MHz)	Level (dBμV/m)	Over Limit (dB)	Limit Line (dBμV/m)	Read Level (dBμV)	Antenna Factor (dB)	Cable Loss (dB)	Preamp Factor (dB)	Ant Pos (cm)	Table Pos (deg)	Remark
2462	106.24	-	-	102.91	32.98	3.64	33.29	100	57	Peak
2462	94.79	-	-	91.46	32.98	3.64	33.29	100	57	Average
4924	47.73	-26.27	74	41.03	35.19	5.31	33.8	120	69	Peak
7386	48.86	-25.14	74	40.08	36.24	6.7	34.16	100	88	Peak

Test Mode :	802.11g	Temperature :	22~23°C
Test Channel :	11	Relative Humidity :	40~41%
Test Engineer :	Jun Liu	Polarization :	Vertical
Remark :	1. 2462 MHz is fundamental signal which can be ignored. 2. Average measurement was not performed if peak level went lower than the average limit.		

Frequency (MHz)	Level (dBμV/m)	Over Limit (dB)	Limit Line (dBμV/m)	Read Level (dBμV)	Antenna Factor (dB)	Cable Loss (dB)	Preamp Factor (dB)	Ant Pos (cm)	Table Pos (deg)	Remark
2462	104.35	-	-	101.02	32.98	3.64	33.29	192	98	Peak
2462	93.09	-	-	89.76	32.98	3.64	33.29	192	98	Average
4924	47.3	-26.7	74	40.6	35.19	5.31	33.8	110	54	Peak
7386	49.65	-24.35	74	40.87	36.24	6.7	34.16	100	91	Peak



Test Mode :	2.4GHz 802.11n HT20	Temperature :	22~23°C
Test Channel :	01	Relative Humidity :	40~41%
Test Engineer :	Jun Liu	Polarization :	Horizontal
Remark :	1. 2412 MHz is fundamental signal which can be ignored. 2. Average measurement was not performed if peak level went lower than the average limit.		

Frequency (MHz)	Level (dBμV/m)	Over Limit (dB)	Limit Line (dBμV/m)	Read Level (dBμV)	Antenna Factor (dB)	Cable Loss (dB)	Preamp Factor (dB)	Ant Pos (cm)	Table Pos (deg)	Remark
77.53	27.8	-12.2	40	54.39	6.2	0.81	33.6	-	-	Peak
104.69	28.35	-15.15	43.5	49.86	11.15	0.95	33.61	-	-	Peak
156.1	34.38	-9.12	43.5	57.06	9.76	1.14	33.58	200	130	Peak
224.97	31.74	-14.26	46	53.36	10.5	1.38	33.5	-	-	Peak
308.39	28.44	-17.56	46	46.99	13.2	1.62	33.37	-	-	Peak
941.8	35.64	-10.36	46	44.57	20.7	2.81	32.44	-	-	Peak
2412	104.36	-	-	101.13	32.89	3.61	33.27	106	59	Peak
2412	93.39	-	-	90.16	32.89	3.61	33.27	106	59	Average
4824	47.43	-26.57	74	40.81	35.17	5.25	33.8	100	91	Peak



Test Mode :	2.4GHz 802.11n HT20	Temperature :	22~23°C
Test Channel :	01	Relative Humidity :	40~41%
Test Engineer :	Jun Liu	Polarization :	Vertical
Remark :	1. 2412 MHz is fundamental signal which can be ignored. 2. Average measurement was not performed if peak level went lower than the average limit.		

Frequency (MHz)	Level (dBμV/m)	Over Limit (dB)	Limit Line (dBμV/m)	Read Level (dBμV)	Antenna Factor (dB)	Cable Loss (dB)	Preamp Factor (dB)	Ant Pos (cm)	Table Pos (deg)	Remark
43.58	27.96	-12.04	40	50.93	10.03	0.62	33.62	-	-	Peak
75.59	29	-11	40	55.86	5.93	0.81	33.6	-	-	Peak
159.01	25.51	-17.99	43.5	48.3	9.64	1.15	33.58	-	-	Peak
223.03	23.69	-22.31	46	45.5	10.33	1.37	33.51	-	-	Peak
393.75	22.38	-23.62	46	38	15.87	1.82	33.31	-	-	Peak
941.8	36.18	-9.82	46	45.11	20.7	2.81	32.44	100	200	Peak
2412	102.51	-	-	99.28	32.89	3.61	33.27	100	83	Peak
2412	91.42	-	-	88.19	32.89	3.61	33.27	100	83	Average
4824	47.15	-26.85	74	40.53	35.17	5.25	33.8	110	52	Peak



Test Mode :	2.4GHz 802.11n HT20	Temperature :	22~23°C
Test Channel :	06	Relative Humidity :	40~41%
Test Engineer :	Jun Liu	Polarization :	Horizontal
Remark :	1. 2437 MHz is fundamental signal which can be ignored. 2. Average measurement was not performed if peak level went lower than the average limit.		

Frequency (MHz)	Level (dBμV/m)	Over Limit (dB)	Limit Line (dBμV/m)	Read Level (dBμV)	Antenna Factor (dB)	Cable Loss (dB)	Preamp Factor (dB)	Ant Pos (cm)	Table Pos (deg)	Remark
2437	106.04	-	-	102.74	32.95	3.63	33.28	103	58	Peak
2437	94.82	-	-	91.52	32.95	3.63	33.28	103	58	Average
4874	47.07	-26.93	74	40.41	35.18	5.28	33.8	100	51	Peak
7312	49.53	-24.47	74	40.85	36.2	6.61	34.13	106	91	Peak

Test Mode :	2.4GHz 802.11n HT20	Temperature :	22~23°C
Test Channel :	06	Relative Humidity :	40~41%
Test Engineer :	Jun Liu	Polarization :	Vertical
Remark :	1. 2437 MHz is fundamental signal which can be ignored. 2. Average measurement was not performed if peak level went lower than the average limit.		

Frequency (MHz)	Level (dBμV/m)	Over Limit (dB)	Limit Line (dBμV/m)	Read Level (dBμV)	Antenna Factor (dB)	Cable Loss (dB)	Preamp Factor (dB)	Ant Pos (cm)	Table Pos (deg)	Remark
2437	103.8	-	-	100.5	32.95	3.63	33.28	200	101	Peak
2437	92.69	-	-	89.39	32.95	3.63	33.28	200	101	Average
4874	47.63	-26.37	74	40.97	35.18	5.28	33.8	100	59	Peak
7312	48.52	-25.48	74	39.84	36.2	6.61	34.13	100	78	Peak



Test Mode :	2.4GHz 802.11n HT20	Temperature :	22~23°C
Test Channel :	11	Relative Humidity :	40~41%
Test Engineer :	Jun Liu	Polarization :	Horizontal
Remark :	1. 2462 MHz is fundamental signal which can be ignored. 2. Average measurement was not performed if peak level went lower than the average limit.		

Frequency (MHz)	Level (dBμV/m)	Over Limit (dB)	Limit Line (dBμV/m)	Read Level (dBμV)	Antenna Factor (dB)	Cable Loss (dB)	Preamp Factor (dB)	Ant Pos (cm)	Table Pos (deg)	Remark
2462	104.35	-	-	101.02	32.98	3.64	33.29	191	155	Peak
2462	93.99	-	-	90.66	32.98	3.64	33.29	191	155	Average
4924	48.08	-25.92	74	41.38	35.19	5.31	33.8	100	162	Peak
7386	49.84	-24.16	74	41.06	36.24	6.7	34.16	100	201	Peak

Test Mode :	2.4GHz 802.11n HT20	Temperature :	22~23°C
Test Channel :	11	Relative Humidity :	40~41%
Test Engineer :	Jun Liu	Polarization :	Vertical
Remark :	1. 2462 MHz is fundamental signal which can be ignored. 2. Average measurement was not performed if peak level went lower than the average limit.		

Frequency (MHz)	Level (dBμV/m)	Over Limit (dB)	Limit Line (dBμV/m)	Read Level (dBμV)	Antenna Factor (dB)	Cable Loss (dB)	Preamp Factor (dB)	Ant Pos (cm)	Table Pos (deg)	Remark
2462	103.62	-	-	100.29	32.98	3.64	33.29	100	83	Peak
2462	91.94	-	-	88.61	32.98	3.64	33.29	100	83	Average
4924	47.41	-26.59	74	40.71	35.19	5.31	33.8	100	18	Peak
7386	50	-24	74	41.22	36.24	6.7	34.16	102	321	Peak



Test Mode :	2.4GHz 802.11n HT40	Temperature :	22~23°C
Test Channel :	03	Relative Humidity :	40~41%
Test Engineer :	Jun Liu	Polarization :	Horizontal
Remark :	1. 2422 MHz is fundamental signal which can be ignored. 2. Average measurement was not performed if peak level went lower than the average limit.		

Frequency (MHz)	Level (dBμV/m)	Over Limit (dB)	Limit Line (dBμV/m)	Read Level (dBμV)	Antenna Factor (dB)	Cable Loss (dB)	Preamp Factor (dB)	Ant Pos (cm)	Table Pos (deg)	Remark
2422	100.32	-	-	97.06	32.92	3.62	33.28	198	161	Peak
2422	89.82	-	-	86.56	32.92	3.62	33.28	198	161	Average
4844	47.7	-26.3	74	41.06	35.18	5.26	33.8	100	256	Peak
7266	48.5	-25.5	74	39.86	36.19	6.56	34.11	108	59	Peak

Test Mode :	2.4GHz 802.11n HT40	Temperature :	22~23°C
Test Channel :	03	Relative Humidity :	40~41%
Test Engineer :	Jun Liu	Polarization :	Vertical
Remark :	1. 2422 MHz is fundamental signal which can be ignored. 2. Average measurement was not performed if peak level went lower than the average limit.		

Frequency (MHz)	Level (dBμV/m)	Over Limit (dB)	Limit Line (dBμV/m)	Read Level (dBμV)	Antenna Factor (dB)	Cable Loss (dB)	Preamp Factor (dB)	Ant Pos (cm)	Table Pos (deg)	Remark
2422	97.17	-	-	93.91	32.92	3.62	33.28	100	88	Peak
2422	86.34	-	-	83.08	32.92	3.62	33.28	100	88	Average
4844	46.59	-27.41	74	39.95	35.18	5.26	33.8	110	15	Peak
7266	49.07	-24.93	74	40.43	36.19	6.56	34.11	151	85	Peak



Test Mode :	2.4GHz 802.11n HT40	Temperature :	22~23°C
Test Channel :	06	Relative Humidity :	40~41%
Test Engineer :	Jun Liu	Polarization :	Horizontal
Remark :	1. 2437 MHz is fundamental signal which can be ignored. 2. Average measurement was not performed if peak level went lower than the average limit.		

Frequency (MHz)	Level (dBμV/m)	Over Limit (dB)	Limit Line (dBμV/m)	Read Level (dBμV)	Antenna Factor (dB)	Cable Loss (dB)	Preamp Factor (dB)	Ant Pos (cm)	Table Pos (deg)	Remark
2437	100.3	-	-	97	32.95	3.63	33.28	200	159	Peak
2437	89.55	-	-	86.25	32.95	3.63	33.28	200	159	Average
4874	46.17	-27.83	74	39.51	35.18	5.28	33.8	105	47	Peak
7312	47.92	-26.08	74	39.24	36.2	6.61	34.13	110	47	Peak

Test Mode :	2.4GHz 802.11n HT40	Temperature :	22~23°C
Test Channel :	06	Relative Humidity :	40~41%
Test Engineer :	Jun Liu	Polarization :	Vertical
Remark :	1. 2437 MHz is fundamental signal which can be ignored. 2. Average measurement was not performed if peak level went lower than the average limit.		

Frequency (MHz)	Level (dBμV/m)	Over Limit (dB)	Limit Line (dBμV/m)	Read Level (dBμV)	Antenna Factor (dB)	Cable Loss (dB)	Preamp Factor (dB)	Ant Pos (cm)	Table Pos (deg)	Remark
2437	96.23	-	-	92.93	32.95	3.63	33.28	100	68	Peak
2437	84.86	-	-	81.56	32.95	3.63	33.28	100	68	Average
4874	46.86	-27.14	74	40.2	35.18	5.28	33.8	100	62	Peak
7312	48.67	-25.33	74	39.99	36.2	6.61	34.13	100	91	Peak



Test Mode :	2.4GHz 802.11n HT40	Temperature :	22~23°C
Test Channel :	09	Relative Humidity :	40~41%
Test Engineer :	Jun Liu	Polarization :	Horizontal
Remark :	1. 2452 MHz is fundamental signal which can be ignored. 2. Average measurement was not performed if peak level went lower than the average limit.		

Frequency (MHz)	Level (dBμV/m)	Over Limit (dB)	Limit Line (dBμV/m)	Read Level (dBμV)	Antenna Factor (dB)	Cable Loss (dB)	Preamp Factor (dB)	Ant Pos (cm)	Table Pos (deg)	Remark
2452	98.8	-	-	95.5	32.95	3.63	33.28	195	160	Peak
2452	88.7	-	-	85.4	32.95	3.63	33.28	195	160	Average
4904	46.26	-27.74	74	39.57	35.19	5.3	33.8	115	158	Peak
7356	48.83	-25.17	74	40.1	36.22	6.66	34.15	100	73	Peak

Test Mode :	2.4GHz 802.11n HT40	Temperature :	22~23°C
Test Channel :	09	Relative Humidity :	40~41%
Test Engineer :	Jun Liu	Polarization :	Vertical
Remark :	1. 2452 MHz is fundamental signal which can be ignored. 2. Average measurement was not performed if peak level went lower than the average limit.		

Frequency (MHz)	Level (dBμV/m)	Over Limit (dB)	Limit Line (dBμV/m)	Read Level (dBμV)	Antenna Factor (dB)	Cable Loss (dB)	Preamp Factor (dB)	Ant Pos (cm)	Table Pos (deg)	Remark
2452	94.69	-	-	91.39	32.95	3.63	33.28	100	77	Peak
2452	83.97	-	-	80.67	32.95	3.63	33.28	100	77	Average
4904	47.69	-26.31	74	41	35.19	5.3	33.8	100	61	Peak
7356	48.45	-25.55	74	39.72	36.22	6.66	34.15	100	99	Peak

3.6 AC Conducted Emission Measurement

3.6.1 Limit of AC Conducted Emission

For equipment that is designed to be connected to the public utility (AC) power line, the radio frequency voltage that is conducted back onto the AC power line on any frequency or frequencies within the band 150 kHz to 30 MHz shall not exceed the limits in the following table.

Frequency of Emission (MHz)	Conducted Limit (dB μ V)	
	Quasi-Peak	Average
0.15-0.5	66 to 56*	56 to 46*
0.5-5	56	46
5-30	60	50

*Decreases with the logarithm of the frequency.

3.6.2 Measuring Instruments

The measuring equipment is listed in the section 4 of this test report.

3.6.3 Test Procedures

1. The EUT was placed 0.4 meter from the conducting wall of the shielding room, and it was kept at least 80 centimeters from any other grounded conducting surface.
2. Connect EUT to the power mains through a line impedance stabilization network (LISN).
3. All the support units are connecting to the other LISN.
4. The LISN provides 50 ohm coupling impedance for the measuring instrument.
5. The FCC states that a 50 ohm, 50 microhenry LISN should be used.
6. Both sides of AC line were checked for maximum conducted interference.
7. The frequency range from 150 kHz to 30 MHz was searched.
8. Set the test-receiver system to Peak Detect Function and specified bandwidth with Maximum Hold Mode.

3.6.4 Test Setup

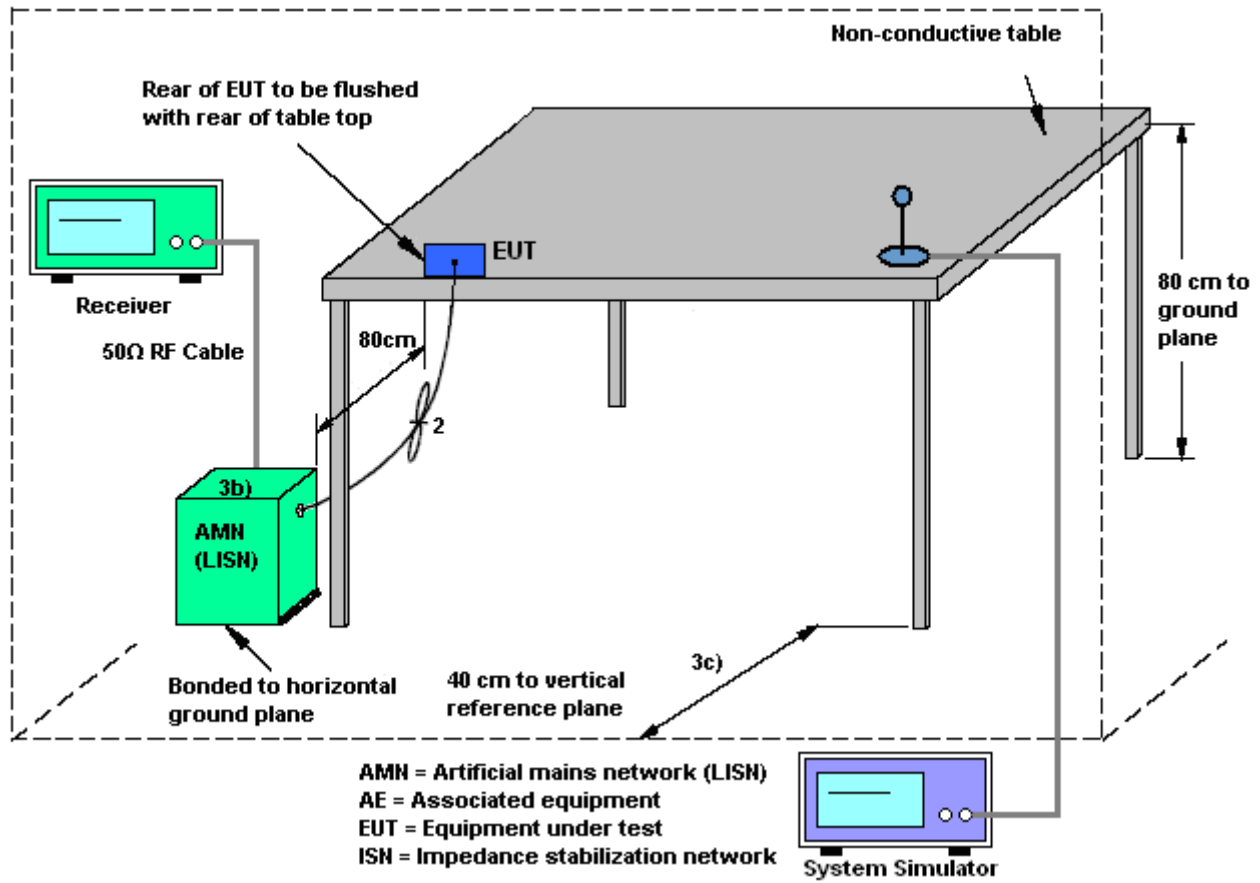

3.6.5 Test Result of AC Conducted Emission

Test Mode :	Mode 1	Temperature :	19~21°C
Test Engineer :	Eliagh Wang	Relative Humidity :	37~39%
Test Voltage :	120Vac / 60Hz	Phase :	Line
Function Type :	GSM850 Idle + Bluetooth Link + WLAN Link + USB Cable (Charging from Adapter) + Earphone		

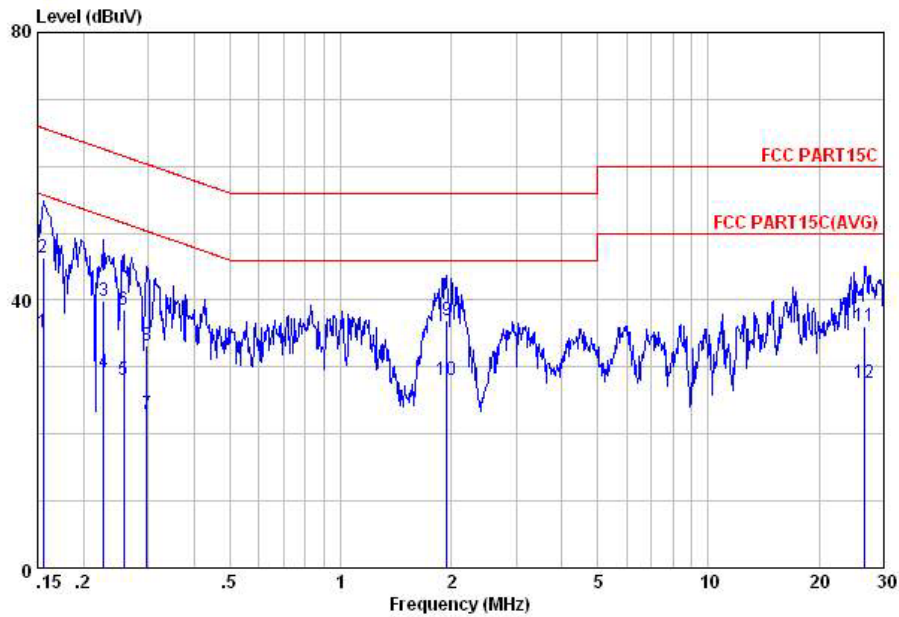

Site : C001-KS
 Condition: FCC PART15C LISN-L20130306 LINE

	Freq	Level	Over	Limit	Read	LISN	Cable	Remark
	MHz	dBuV	Limit	Line	Level	Factor	Loss	
			dB	dBuV	dBuV	dB	dB	
1	0.16	35.25	-20.44	55.69	22.70	1.86	10.69	Average
2	0.16	46.35	-19.34	65.69	33.80	1.86	10.69	QP
3	0.23	39.78	-22.79	62.57	28.30	0.94	10.54	QP
4	0.23	29.28	-23.29	52.57	17.80	0.94	10.54	Average
5	0.26	28.15	-23.36	51.51	16.80	0.86	10.49	Average
6	0.26	38.65	-22.86	61.51	27.30	0.86	10.49	QP
7	0.30	22.90	-27.42	50.32	11.79	0.71	10.40	Average
8	0.30	33.30	-27.02	60.32	22.19	0.71	10.40	QP
9	1.95	37.09	-18.91	56.00	26.80	0.10	10.19	QP
10	1.95	28.09	-17.91	46.00	17.80	0.10	10.19	Average
11	26.56	36.05	-23.95	60.00	25.40	0.10	10.55	QP
12	26.56	27.55	-22.45	50.00	16.90	0.10	10.55	Average



Test Mode :	Mode 1	Temperature :	19~21°C
Test Engineer :	Eliagh Wang	Relative Humidity :	37~39%
Test Voltage :	120Vac / 60Hz	Phase :	Neutral
Function Type :	GSM850 Idle + Bluetooth Link + WLAN Link + USB Cable (Charging from Adapter) + Earphone		

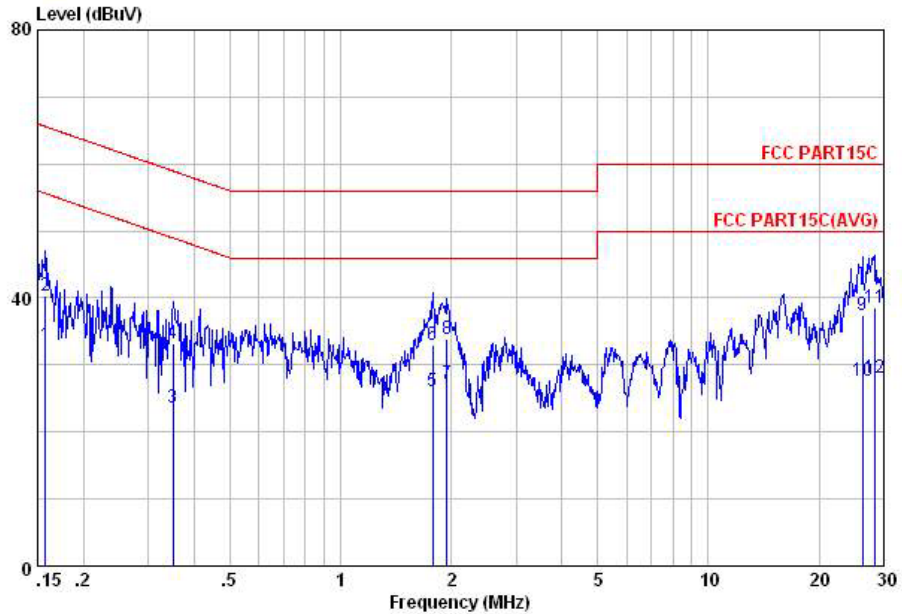

Site : C001-KS
Condition: FCC PART15C LISN-N20130306 NEUTRAL

	Freq	Level	Over	Limit	Read	LISN	Cable	Remark
	MHz	dBuV	Limit	Line	Level	Factor	Loss	
			dB	dBuV	dBuV	dB	dB	
1	0.16	32.87	-22.73	55.60	20.40	1.79	10.68	Average
2	0.16	40.27	-25.33	65.60	27.80	1.79	10.68	QP
3	0.35	23.63	-25.33	48.96	12.80	0.51	10.32	Average
4	0.35	33.23	-25.73	58.96	22.40	0.51	10.32	QP
5	1.78	26.09	-19.91	46.00	15.80	0.10	10.19	Average
6	1.78	33.09	-22.91	56.00	22.80	0.10	10.19	QP
7	1.95	27.09	-18.91	46.00	16.80	0.10	10.19	Average
8	1.95	33.89	-22.11	56.00	23.60	0.10	10.19	QP
9	26.28	37.52	-22.48	60.00	26.79	0.18	10.55	QP
10	26.28	27.52	-22.48	50.00	16.79	0.18	10.55	Average
11	28.30	38.57	-21.43	60.00	27.90	0.13	10.54	QP
12	28.30	27.97	-22.03	50.00	17.30	0.13	10.54	Average



3.7 Antenna Requirements

3.7.1 Standard Applicable

If directional gain of transmitting antennas is greater than 6dBi, the power shall be reduced by the same level in dB comparing to gain minus 6dBi. For the fixed point-to-point operation, the power shall be reduced by one dB for every 3 dB that the directional gain of the antenna exceeds 6 dBi. The use of a permanently attached antenna or of an antenna that uses a unique coupling to the intentional radiator shall be considered sufficient to comply with the FCC rule.

3.7.2 Antenna Anti-Replacement Construction

An embedded-in antenna design is used.

3.7.3 Antenna Gain

The antenna peak gain of EUT is less than 6 dBi. Therefore, it is not necessary to reduce maximum peak output power limit.



4 List of Measuring Equipment

Instrument	Manufacturer	Model No.	Serial No.	Characteristics	Calibration Date	Test Date	Due Date	Remark
Spectrum Analyzer	R&S	FSP40	100319	9kHz~40GHz	Dec. 28, 2013	Mar. 06, 2014	Dec. 27, 2014	Conducted (TH01-KS)
Pulse Power Sensor	Anritsu	MA2411B	0917070	30MHz~40GHz	Feb. 27, 2014	Mar. 06, 2014	Feb. 26, 2015	Conducted (TH01-KS)
Power Meter	Anritsu	ML2495A	1005002	50MHz Bandwidth	Feb. 27, 2014	Mar. 06, 2014	Feb. 26, 2015	Conducted (TH01-KS)
EMI Test Receiver	R&S	ESCI	100534	9kHz~3GHz	Nov. 05, 2013	Mar. 13, 2014	Nov. 04, 2014	Radiation (03CH01-KS)
Spectrum Analyzer	R&S	FSP30	101399	9kHz~30GHz	May 23, 2013	Mar. 13, 2014	May 22, 2014	Radiation (03CH01-KS)
Loop Antenna	R&S	HFH2-Z2	100321	9kHz~30MHz	Oct. 09, 2013	Mar. 13, 2014	Oct. 08, 2014	Radiation (03CH01-KS)
Bilog Antenna	SCHAFFNER	CBL6112D	23182	25MHz~2GHz	Jan. 08, 2014	Mar. 13, 2014	Jan. 07, 2015	Radiation (03CH01-KS)
Double Ridge Horn Antenna	EMCO	3117	00075959	1GHz~18GHz	Jan. 08, 2014	Mar. 13, 2014	Jan. 07, 2015	Radiation (03CH01-KS)
SHF-EHF Horn	Schwarzbeck	BBHA 9170	BBHA170249	15GHz~40GHz	Nov. 22, 2013	Mar. 13, 2014	Nov. 21, 2014	Radiation (03CH01-KS)
Active Horn Antenna	com-power	AHA-118	701030	1GHz~18GHz	Nov. 18, 2013	Mar. 13, 2014	Nov. 17, 2014	Radiation (03CH01-KS)
Amplifier	com-power	PA-103A	161069	1MHz~1GHz	May 23, 2013	Mar. 13, 2014	May 22, 2014	Radiation (03CH01-KS)
Amplifier	Agilent	8449B	3008A02371	1GHz~26.5GHz	Dec. 10, 2013	Mar. 13, 2014	Dec. 09, 2014	Radiation (03CH01-KS)
Turn Table	MF	MF7802	N/A	0~360 degree	NCR	Mar. 13, 2014	NCR	Radiation (03CH01-KS)
Antenna Mast	MF	MF7802	N/A	1 m~4 m	NCR	Mar. 13, 2014	NCR	Radiation (03CH01-KS)
EMI Receiver	R&S	ESCI7	100768	9kHz~7GHz	May 23, 2013	Mar. 20, 2014	May 22, 2014	Conduction (CO01-KS)
AC LISN	MessTec	AN3016	060103	9kHz~30MHz	Dec. 10, 2013	Mar. 20, 2014	Dec. 09, 2014	Conduction (CO01-KS)
AC LISN (for auxiliary equipment)	MessTec	AN3016	060105	9kHz~30MHz	Dec. 10, 2013	Mar. 20, 2014	Dec. 09, 2014	Conduction (CO01-KS)
AC Power Source	Chroma	61602	ABP0000008 11	AC 0V~300V, 45Hz~1000Hz	May 25, 2013	Mar. 20, 2014	May 24, 2014	Conduction (CO01-KS)



5 Uncertainty of Evaluation

Uncertainty of Conducted Emission Measurement (150kHz ~ 30MHz)

Measuring Uncertainty for a Level of Confidence of 95% ($U = 2Uc(y)$)	2.26
---	------

Uncertainty of Radiated Emission Measurement (30 MHz ~ 1000 MHz)

Measuring Uncertainty for a Level of Confidence of 95% ($U = 2Uc(y)$)	2.54
---	------