

FCC SAR Test Report

APPLICANT : Acer Incorporated
EQUIPMENT : Smart HandHeld
BRAND NAME : Acer
MODEL NAME : Z150
MARKETING NAME : Liquid Z5
FCC ID : HLZDMZ150
STANDARD : FCC 47 CFR Part 2 (2.1093)
ANSI/IEEE C95.1-1992
IEEE 1528-2003

The product was completely tested on Nov. 22, 2013. We, SPORTON INTERNATIONAL INC., would like to declare that the tested sample has been evaluated in accordance with the procedures and shown the compliance with the applicable technical standards.

The test results in this report apply exclusively to the tested model / sample. Without written approval of SPORTON INTERNATIONAL INC., the test report shall not be reproduced except in full.

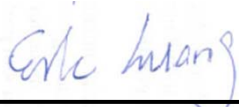

Reviewed by: Eric Huang / Deputy Manager



Approved by: Jones Tsai / Manager



SPORTON INTERNATIONAL INC.

No. 52, Hwa Ya 1st Rd., Hwa Ya Technology Park, Kwei-Shan Hsiang, Tao Yuan Hsien, Taiwan, R.O.C.



Table of Contents

1. Statement of Compliance4
2. Administration Data5
2.1 Testing Laboratory5
2.2 Applicant5
2.3 Manufacturer5
2.4 Application Details5
3. General Information6
3.1 Description of Equipment Under Test (EUT)6
3.2 Maximum RF output power among production units7
3.3 Applied Standard8
3.4 Device Category and SAR Limits8
3.5 Test Conditions8
4. Specific Absorption Rate (SAR)9
4.1 Introduction9
4.2 SAR Definition9
5. SAR Measurement System10
5.1 E-Field Probe11
5.2 Data Acquisition Electronics (DAE)11
5.3 Robot12
5.4 Measurement Server12
5.5 Phantom13
5.6 Device Holder13
5.7 Data Storage and Evaluation14
5.8 Test Equipment List16
6. Tissue Simulating Liquids17
7. System Verification Procedures18
7.1 Purpose of System Performance check18
7.2 System Setup18
7.3 SAR System Verification Results19
8. EUT Testing Position20
8.1 Define two imaginary lines on the handset20
8.2 Cheek Position21
8.3 Tilted Position21
8.4 Body Worn Position22
9. Measurement Procedures23
9.1 Spatial Peak SAR Evaluation23
9.2 Power Reference Measurement24
9.3 Area & Zoom Scan Procedures24
9.4 Volume Scan Procedures25
9.5 SAR Averaged Methods25
9.6 Power Drift Monitoring25
10. Conducted RF Output Power (Unit: dBm)26
11. Antenna Location33
12. SAR Test Results35
12.1 Head SAR35
12.2 Hotspot SAR37
12.3 Body Worn SAR38
12.4 Highest SAR Plot39
13. Simultaneous Transmission Analysis44
13.1 Head Exposure Conditions45
13.2 Hotspot Exposure Conditions46
13.3 Body-Worn Exposure Conditions48
14. Uncertainty Assessment49
15. References51
Appendix A. Plots of System Performance Check
Appendix B. Plots of SAR Measurement
Appendix C. DASy Calibration Certificate
Appendix D. Test Setup Photos



Revision History

REPORT NO.	VERSION	DESCRIPTION	ISSUED DATE
FA3N1490	Rev. 01	Initial issue of report	Dec. 12, 2013



1. Statement of Compliance

The maximum results of Specific Absorption Rate (SAR) found during testing for **Acer Incorporated, DUT: Smart HandHeld, Brand Name: Acer, Model Name: Z150, Marketing Name: Liquid Z5** are as follows.

<Highest SAR Summary>

Exposure Position	Frequency Band	Reported 1g-SAR (W/kg)	Equipment Class	Highest Reported 1g-SAR (W/kg)
Head	GSM850	0.29	PCE	0.29
	GSM1900	0.14		
	WCDMA Band V	0.24		
	WCDMA Band II	0.26		
	WLAN 2.4GHz Band	0.32	DTS	0.32
Hotspot (Separation 1cm)	GSM850	0.70	PCE	0.70
	GSM1900	0.50		
	WCDMA Band V	0.30		
	WCDMA Band II	0.54		
	WLAN 2.4GHz Band	0.11	DTS	0.11
Body-worn (Separation 1cm)	GSM850	0.70	PCE	0.70
	GSM1900	0.47		
	WCDMA Band V	0.30		
	WCDMA Band II	0.48		
	WLAN 2.4GHz Band	0.11	DTS	0.11

<Highest Simultaneous transmission SAR>

Exposure Position	Frequency Band	Equipment Class	Highest Reported Simultaneous Transmission 1g-SAR (W/kg)
Hotspot (Separation 1cm)	GSM850	PCE	0.81
	WLAN 2.4GHz Band	DTS	
Hotspot (Separation 1cm)	GSM850	PCE	0.82
	Bluetooth	DSS	

This device is in compliance with Specific Absorption Rate (SAR) for general population/uncontrolled exposure limits (1.6 W/kg) specified in FCC 47 CFR part 2 (2.1093) and ANSI/IEEE C95.1-1992, and had been tested in accordance with the measurement methods and procedures specified in IEEE 1528-2003.



2. Administration Data

2.1 Testing Laboratory

Test Site	SPORTON INTERNATIONAL INC.
Test Site Location	No. 52, Hwa Ya 1 st Rd., Hwa Ya Technology Park, Kwei-Shan Hsiang, Tao Yuan Hsien, Taiwan, R.O.C. TEL: +886-3-327-3456 FAX: +886-3-328-4978

2.2 Applicant

Company Name	Acer Incorporated
Address	8F., No. 88, Sec. 1, Xintai 5th Rd., Xizhi Dist., New Taipei City 22181, Taiwan (R.O.C)

2.3 Manufacturer

Company Name	Shanghai Sunrise Simcom Limited
Address	No. 888, Shengli Rd., Qingpu, Shanghai, P.R.China 201700

2.4 Application Details

Date of Start during the Test	Nov. 21, 2013
Date of End during the Test	Nov. 22, 2013



3. General Information

3.1 Description of Equipment Under Test (EUT)

Product Feature & Specification	
EUT	Smart HandHeld
Brand Name	Acer
Model Name	Z150
Marketing Name	Liquid Z5
FCC ID	HLZDMZ150
IMEI Code	For SIM1 : 355864050000561 For SIM2 : 355864050000801
Wireless Technology and Frequency Range	GSM850: 824.2 MHz ~ 848.8 MHz GSM1900: 1850.2 MHz ~ 1909.8 MHz WCDMA Band V: 826.4 MHz ~ 846.6 MHz WCDMA Band II: 1852.4 MHz ~ 1907.6 MHz WLAN 2.4GHz Band: 2412 MHz ~ 2462 MHz Bluetooth: 2402 MHz ~ 2480 MHz
Mode	<ul style="list-style-type: none">• GSM/GPRS/EGPRS• RMC/AMR 12.2Kbps Rel 99• HSDPA Rel 7, Cat14• HSUPA Rel 6, Cat6• HSPA+ Rel 7, Cat 14 (Downlink Only)• 802.11b/g/n HT20/HT40• Bluetooth 3.0 · Bluetooth 4.0
Antenna Type	WWAN: Monopole Antenna WLAN: PIFA Antenna Bluetooth: PIFA Antenna
Transfer Mode Category	Class B – EUT cannot support Packet Switched and Circuit Switched Network simultaneously but can automatically switch between Packet and Circuit Switched Network.
EUT Stage	Identical Prototype
Remark:	<ol style="list-style-type: none">1. The above EUT's information was declared by manufacturer. Please refer to the specifications or user's manual for more detailed description.2. This device supports GPRS/EGPRS mode up to class12 and does not support DTM operation.



3.2 Maximum RF output power among production units

Burst Average Power (dBm)		
Mode / Band	GSM850	GSM1900
GSM (GMSK, 1 Tx slot)	33	29.5
GPRS (GMSK, 1 Tx slot)	33	29.5
GPRS (GMSK, 2 Tx slots)	32	29
GPRS (GMSK, 3 Tx slots)	30	27
GPRS (GMSK, 4 Tx slots)	29	26
EDGE (8PSK, 1 Tx slot)	28	26.5
EDGE (8PSK, 2 Tx slots)	27	25.5
EDGE (8PSK, 3 Tx slots)	24	23
EDGE (8PSK, 4 Tx slots)	23	21.5

Maximum Target Power for Production Unit		
Mode / Band	WCDMA Band V	WCDMA Band II
AMR	22.5	23
RMC 12.2K	22.5	23
HSDPA Subtest-1	22	22
HSDPA Subtest-2	22	22
HSDPA Subtest-3	21	21
HSDPA Subtest-4	21	21
HSUPA Subtest-1	20	20
HSUPA Subtest-2	20	20
HSUPA Subtest-3	21	21
HSUPA Subtest-4	19.5	20
HSUPA Subtest-5	21	21

Average Power (dBm)				
Mode / Band	IEEE 802.11b/g/n			
	11b	11g	11n-HT20	11n-HT40
WLAN 2.4GHz Band	12	9.5	8	4

Average Power (dBm)				
Mode / Band	1Mbps (GFSK)	2Mbps ($\pi/4$ -DQPSK)	3Mbps (8-DPSK)	BT4.0-LE (GFSK)
Bluetooth	7.5	5.5	5.5	-1



3.3 Applied Standard

The Specific Absorption Rate (SAR) testing specification, method, and procedure for this device is in accordance with the following standards:

- FCC 47 CFR Part 2 (2.1093)
- ANSI/IEEE C95.1-1992
- IEEE 1528-2003
- FCC KDB 865664 D01 SAR Measurement 100 MHz to 6 GHz v01r01
- FCC KDB 865664 D02 SAR Reporting v01r01
- FCC KDB 447498 D01 General RF Exposure Guidance v05r01
- FCC KDB 648474 D04 SAR Handsets Multi Xmitter and Ant v01r01
- FCC KDB 248227 D01 SAR meas for 802 11abg v01r02
- FCC KDB 941225 D01 SAR test for 3G devices v02
- FCC KDB 941225 D03 SAR Test Reduction GSM GPRS EDGE v01
- FCC KDB 941225 D06 Hot Spot SAR v01r01

3.4 Device Category and SAR Limits

This device belongs to portable device category because its radiating structure is allowed to be used within 20 centimeters of the body of the user. Limit for General Population/Uncontrolled exposure should be applied for this device, it is 1.6 W/kg as averaged over any 1 gram of tissue.

3.5 Test Conditions

3.5.1 Ambient Condition

Ambient Temperature	20 to 24 °C
Humidity	< 60 %

3.5.2 Test Configuration

For WWAN SAR testing, the device was controlled by using a base station emulator. Communication between the device and the emulator was established by air link. The distance between the EUT and the antenna of the emulator is larger than 50 cm and the output power radiated from the emulator antenna is at least 30 dB smaller than the output power of EUT.

During WLAN SAR testing EUT is configured with the WLAN continuous TX tool, and the transmission duty factor was monitored on the spectrum analyzer with zero-span setting

For WLAN SAR testing, WLAN engineering testing software installed on the EUT can provide continuous transmitting RF signal.

4. Specific Absorption Rate (SAR)

4.1 Introduction

SAR is related to the rate at which energy is absorbed per unit mass in an object exposed to a radio field. The SAR distribution in a biological body is complicated and is usually carried out by experimental techniques or numerical modeling. The standard recommends limits for two tiers of groups, occupational/controlled and general population/uncontrolled, based on a person's awareness and ability to exercise control over his or her exposure. In general, occupational/controlled exposure limits are higher than the limits for general population/uncontrolled.

4.2 SAR Definition

The SAR definition is the time derivative (rate) of the incremental energy (dW) absorbed by (dissipated in) an incremental mass (dm) contained in a volume element (dv) of a given density (ρ). The equation description is as below:

$$\text{SAR} = \frac{d}{dt} \left(\frac{dW}{dm} \right) = \frac{d}{dt} \left(\frac{dW}{\rho dv} \right)$$

SAR is expressed in units of Watts per kilogram (W/kg)

SAR measurement can be either related to the temperature elevation in tissue by

$$\text{SAR} = c \left(\frac{\delta T}{\delta t} \right)$$

Where: C is the specific heat capacity, δT is the temperature rise and δt is the exposure duration, or related to the electrical field in the tissue by

$$\text{SAR} = \frac{\sigma |E|^2}{\rho}$$

Where: σ is the conductivity of the tissue, ρ is the mass density of the tissue and E is the RMS electrical field strength.

However for evaluating SAR of low power transmitter, electrical field measurement is typically applied.

5. SAR Measurement System

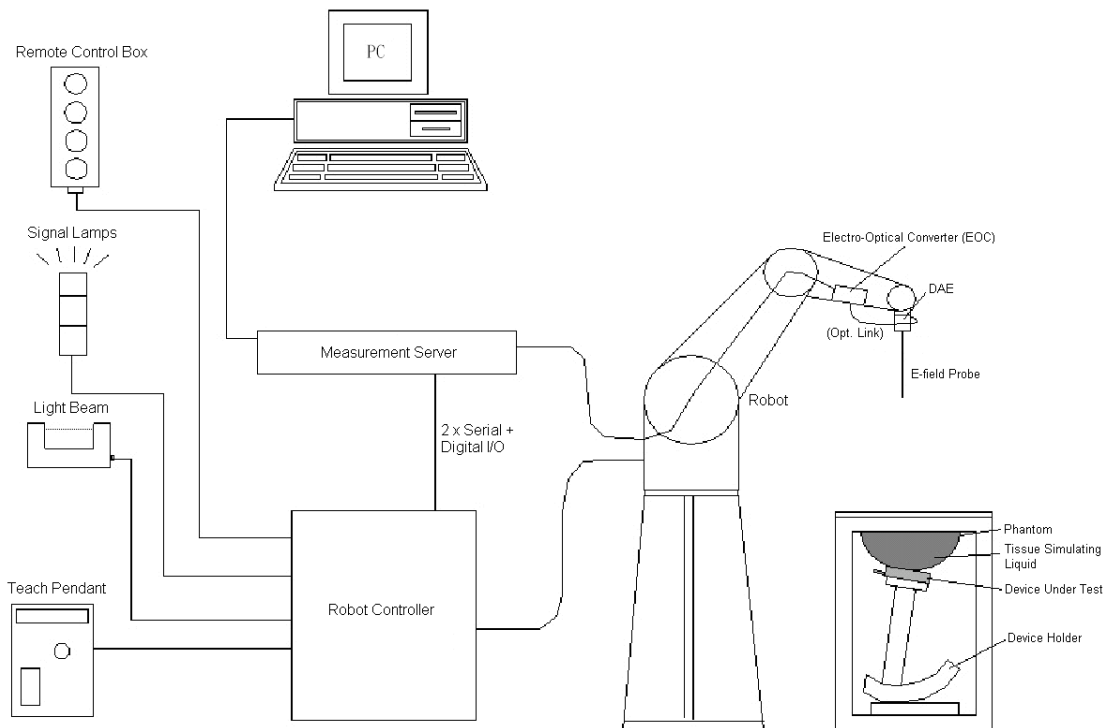

Fig 5.1 SPEAG DASY System Configurations

The DASY system for performance compliance tests is illustrated above graphically. This system consists of the following items:

- A standard high precision 6-axis robot with controller, a teach pendant and software
- A data acquisition electronic (DAE) attached to the robot arm extension
- A dosimetric probe equipped with an optical surface detector system
- The electro-optical converter (EOC) performs the conversion between optical and electrical signals
- A measurement server performs the time critical tasks such as signal filtering, control of the robot operation and fast movement interrupts.
- A probe alignment unit which improves the accuracy of the probe positioning
- A computer operating Windows XP
- DASY software
- Remote control with teach pendant and additional circuitry for robot safety such as warning lamps, etc.
- The SAM twin phantom
- A device holder
- Tissue simulating liquid
- Dipole for evaluating the proper functioning of the system

Component details are described in in the following sub-sections.

5.1 E-Field Probe

The SAR measurement is conducted with the dosimetric probe (manufactured by SPEAG). The probe is specially designed and calibrated for use in liquid with high permittivity. The dosimetric probe has special calibration in liquid at different frequency. This probe has a built in optical surface detection system to prevent from collision with phantom.

5.1.1 E-Field Probe Specification

<EX3DV4 Probe>

Construction	Symmetrical design with triangular core Built-in shielding against static charges PEEK enclosure material (resistant to organic solvents, e.g., DGBE)
Frequency	10 MHz to 6 GHz; Linearity: ± 0.2 dB
Directivity	± 0.3 dB in HSL (rotation around probe axis) ± 0.5 dB in tissue material (rotation normal to probe axis)
Dynamic Range	10 μ W/g to 100 mW/g; Linearity: ± 0.2 dB (noise: typically $< 1 \mu$ W/g)
Dimensions	Overall length: 330 mm (Tip: 20 mm) Tip diameter: 2.5 mm (Body: 12 mm) Typical distance from probe tip to dipole centers: 1 mm

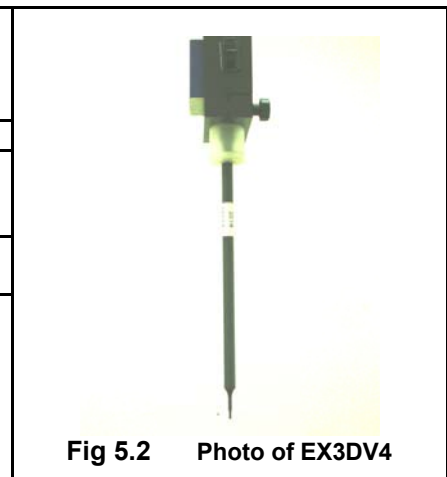

Fig 5.2 Photo of EX3DV4

5.1.2 E-Field Probe Calibration

Each probe needs to be calibrated according to a dosimetric assessment procedure with accuracy better than $\pm 10\%$. The spherical isotropy shall be evaluated and within ± 0.25 dB. The sensitivity parameters (NormX, NormY, and NormZ), the diode compression parameter (DCP) and the conversion factor (ConvF) of the probe are tested. The calibration data can be referred to appendix C of this report.

5.2 Data Acquisition Electronics (DAE)

The data acquisition electronics (DAE) consists of a highly sensitive electrometer-grade preamplifier with auto-zeroing, a channel and gain-switching multiplexer, a fast 16 bit AD-converter and a command decoder and control logic unit. Transmission to the measurement server is accomplished through an optical downlink for data and status information as well as an optical uplink for commands and the clock. The input impedance of the DAE is 200 MOhm; the inputs are symmetrical and floating. Common mode rejection is above 80 dB.



Fig 5.3 Photo of DAE

5.3 Robot

The SPEAG DASY system uses the high precision robots (DASY5: TX90XL) type from Stäubli SA (France). For the 6-axis controller system, the robot controller version (DASY5: CS8c) from Stäubli is used. The Stäubli robot series have many features that are important for our application:

- High precision (repeatability ± 0.035 mm)
- High reliability (industrial design)
- Jerk-free straight movements
- Low ELF interference (the closed metallic construction shields against motor control fields)



Fig 5.4 Photo of DASY5

5.4 Measurement Server

The measurement server is based on a PC/104 CPU board with CPU (DASY5: 400 MHz, Intel Celeron), chipdisk (DASY5: 128 MB), RAM (DASY5: 128 MB). The necessary circuits for communication with the DAE electronic box, as well as the 16 bit AD converter system for optical detection and digital I/O interface are contained on the DASY I/O board, which is directly connected to the PC/104 bus of the CPU board.

The measurement server performs all the real-time data evaluation for field measurements and surface detection, controls robot movements and handles safety operations.



Fig 5.5 Photo of Server for DASY5

5.5 Phantom

<SAM Twin Phantom>

Shell Thickness	2 ± 0.2 mm; Center ear point: 6 ± 0.2 mm
Filling Volume	Approx. 25 liters
Dimensions	Length: 1000 mm; Width: 500 mm; Height: adjustable feet
Measurement Areas	Left Hand, Right Hand, Flat Phantom

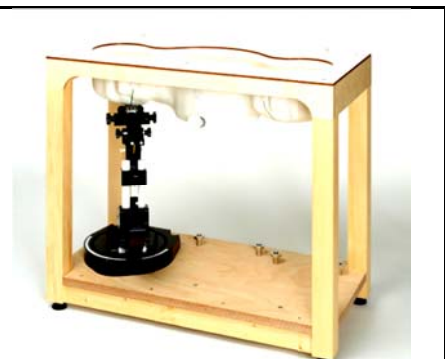

Fig 5.6 Photo of SAM Phantom

The bottom plate contains three pair of bolts for locking the device holder. The device holder positions are adjusted to the standard measurement positions in the three sections. A white cover is provided to tap the phantom during off-periods to prevent water evaporation and changes in the liquid parameters. On the phantom top, three reference markers are provided to identify the phantom position with respect to the robot.

5.6 Device Holder

<Device Holder for SAM Twin Phantom>

The SAR in the phantom is approximately inversely proportional to the square of the distance between the source and the liquid surface. For a source at 5 mm distance, a positioning uncertainty of ± 0.5 mm would produce a SAR uncertainty of ± 20 %. Accurate device positioning is therefore crucial for accurate and repeatable measurements. The positions in which the devices must be measured are defined by the standards.

The DASY device holder is designed to cope with different positions given in the standard. It has two scales for the device rotation (with respect to the body axis) and the device inclination (with respect to the line between the ear reference points). The rotation center for both scales is the ear reference point (ERP). Thus the device needs no repositioning when changing the angles.

The DASY device holder is constructed of low-loss POM material having the following dielectric parameters: relative permittivity $\epsilon = 3$ and loss tangent $\delta = 0.02$. The amount of dielectric material has been reduced in the closest vicinity of the device, since measurements have suggested that the influence of the clamp on the test results could thus be lowered.



Fig 5.7 Device Holder



5.7 Data Storage and Evaluation

5.7.1 Data Storage

The DASY software stores the assessed data from the data acquisition electronics as raw data (in microvolt readings from the probe sensors), together with all the necessary software parameters for the data evaluation (probe calibration data, liquid parameters and device frequency and modulation data) in measurement files. The post-processing software evaluates the desired unit and format for output each time the data is visualized or exported. This allows verification of the complete software setup even after the measurement and allows correction of erroneous parameter settings. For example, if a measurement has been performed with an incorrect crest factor parameter in the device setup, the parameter can be corrected afterwards and the data can be reevaluated.

The measured data can be visualized or exported in different units or formats, depending on the selected probe type (e.g., [V/m], [A/m], [mW/g]). Some of these units are not available in certain situations or give meaningless results, e.g., a SAR-output in a non-lose media, will always be zero. Raw data can also be exported to perform the evaluation with other software packages.

5.7.2 Data Evaluation

The DASY post-processing software (SEMCAD) automatically executes the following procedures to calculate the field units from the microvolt readings at the probe connector. The parameters used in the evaluation are stored in the configuration modules of the software :

Probe parameters :	- Sensitivity	Norm _i , a ₁₀ , a ₁₁ , a ₁₂
	- Conversion factor	ConvF _i
	- Diode compression point	dcp _i
Device parameters :	- Frequency	f
	- Crest factor	cf
Media parameters :	- Conductivity	σ
	- Density	ρ

These parameters must be set correctly in the software. They can be found in the component documents or they can be imported into the software from the configuration files issued for the DASY components. In the direct measuring mode of the multi-meter option, the parameters of the actual system setup are used. In the scan visualization and export modes, the parameters stored in the corresponding document files are used.

The first step of the evaluation is a linearization of the filtered input signal to account for the compression characteristics of the detector diode. The compensation depends on the input signal, the diode type and the DC-transmission factor from the diode to the evaluation electronics. If the exciting field is pulsed, the crest factor of the signal must be known to correctly compensate for peak power.

The formula for each channel can be given as :

$$V_i = U_i + U_i^2 \cdot \frac{cf}{dcp_i}$$

with V_i = compensated signal of channel i, (i = x, y, z)
 U_i = input signal of channel i, (i = x, y, z)
 cf = crest factor of exciting field (DASY parameter)
 dcp_i = diode compression point (DASY parameter)

From the compensated input signals, the primary field data for each channel can be evaluated :

$$\text{E-field Probes : } E_i = \sqrt{\frac{V_i}{\text{Norm}_i \cdot \text{ConvF}}}$$

$$\text{H-field Probes : } H_i = \sqrt{V_i \cdot \frac{a_{i0} + a_{i1}f + a_{i2}f^2}{f}}$$

with V_i = compensated signal of channel i, (i = x, y, z)
 Norm_i = sensor sensitivity of channel i, (i = x, y, z), $\mu\text{V}/(\text{V/m})^2$ for E-field Probes
 ConvF = sensitivity enhancement in solution
 a_{ij} = sensor sensitivity factors for H-field probes
 f = carrier frequency [GHz]
 E_i = electric field strength of channel i in V/m
 H_i = magnetic field strength of channel i in A/m

The RSS value of the field components gives the total field strength (Hermitian magnitude) :

$$E_{\text{tot}} = \sqrt{E_x^2 + E_y^2 + E_z^2}$$

The primary field data are used to calculate the derived field units.

$$\text{SAR} = E_{\text{tot}}^2 \cdot \frac{\sigma}{\rho \cdot 1000}$$

with SAR = local specific absorption rate in mW/g
 E_{tot} = total field strength in V/m
 σ = conductivity in [mho/m] or [Siemens/m]
 ρ = equivalent tissue density in g/cm^3

Note that the density is set to 1, to account for actual head tissue density rather than the density of the tissue simulating liquid.



5.8 Test Equipment List

Manufacturer	Name of Equipment	Type/Model	Serial Number	Calibration	
				Last Cal.	Due Date
SPEAG	835MHz System Validation Kit	D835V2	499	Mar. 18, 2013	Mar. 17, 2014
SPEAG	1900MHz System Validation Kit	D1900V2	5d041	Mar. 20, 2013	Mar. 19, 2014
SPEAG	2450MHz System Validation Kit	D2450V2	840	Mar. 26, 2013	Mar. 25, 2014
SPEAG	Data Acquisition Electronics	DAE4	1210	Jun. 19, 2013	Jun. 18, 2014
SPEAG	Dosimetric E-Field Probe	EX3DV4	3857	Jun. 20, 2013	Jun. 19, 2014
SPEAG	SAM Twin Phantom	QD 000 P40 CB	TP-1477	NCR	NCR
SPEAG	SAM Twin Phantom	QD 000 P40 CB	TP-1479	NCR	NCR
SPEAG	Phone Positioner	N/A	N/A	NCR	NCR
Agilent	Wireless Communication Test Set	E5515C	MY52102706	May 04, 2013	May 03, 2014
Agilent	ENA Series Network Analyzer	E5071C	MY46111157	Apr. 22, 2013	Apr. 21, 2014
Agilent	Dielectric Probe Kit	85070E	MY44300475	NCR	NCR
R&S	Signal Generator	SMR40	100455	Jan. 18, 2013	Jan. 17, 2014
Anritsu	Power Sensor	MA2411B	0917070	Feb. 28, 2013	Feb. 27, 2014
Anritsu	Power Meter	ML2495A	1005002	Feb. 28, 2013	Feb. 27, 2014
Agilent	Dual Directional Coupler	778D	50422	Note 2	
Woken	Attenuator 1	WK0602-XX	N/A	Note 2	
PE	Attenuator 2	PE7005-10	N/A	Note 2	
PE	Attenuator 3	PE7005-3	N/A	Note 2	
AR	Power Amplifier	5S1G4M2	328767	Note 3	
R&S	Spectrum Analyzer	FSP30	101399	May 23, 2013	May 22, 2014

Table 5.1 Test Equipment List

Note:

1. The calibration certificate of DASY can be referred to appendix C of this report.
2. The Insertion Loss calibration of Dual Directional Coupler and Attenuator were characterized via the network analyzer and compensated during system check.
3. In system check we need to monitor the level on the power meter, and adjust the power amplifier level to have precise power level to the dipole; the measured SAR will be normalized to 1W input power according to the ratio of 1W to the input power to the dipole. For system check, the calibration of the power amplifier is deemed not critically required for correct measurement; the power meter is critical and we do have calibration for it
4. Attenuator 1 insertion loss is calibrated by the network Analyzer, which the calibration is valid, before system check.

6. Tissue Simulating Liquids

For the measurement of the field distribution inside the SAM phantom with DASY, the phantom must be filled with around 25 liters of homogeneous body tissue simulating liquid. For head SAR testing, the liquid height from the ear reference point (ERP) of the phantom to the liquid top surface is larger than 15 cm, which is shown in Fig. 6.1. For body SAR testing, the liquid height from the center of the flat phantom to the liquid top surface is larger than 15 cm, which is shown in Fig. 6.2.



Fig 6.1 Photo of Liquid Height for Head SAR



Fig 6.2 Photo of Liquid Height for Body SAR

The following table gives the recipes for tissue simulating liquid.

Frequency (MHz)	Water (%)	Sugar (%)	Cellulose (%)	Salt (%)	Preventol (%)	DGBE (%)	Conductivity (σ)	Permittivity (ϵ_r)
For Head								
835	40.3	57.9	0.2	1.4	0.2	0	0.90	41.5
1800, 1900, 2000	55.2	0	0	0.3	0	44.5	1.40	40.0
2450	55.0	0	0	0	0	45.0	1.80	39.2
For Body								
835	50.8	48.2	0	0.9	0.1	0	0.97	55.2
1800, 1900, 2000	70.2	0	0	0.4	0	29.4	1.52	53.3
2450	68.6	0	0	0	0	31.4	1.95	52.7

Table 6.1 Recipes of Tissue Simulating Liquid

The dielectric parameters of the liquids were verified prior to the SAR evaluation using an SPEAG 85070E Dielectric Probe Kit and an Agilent Network Analyzer.

The following table shows the measuring results for simulating liquid.

Frequency (MHz)	Liquid Type	Liquid Temp. ($^{\circ}\text{C}$)	Conductivity (σ)	Permittivity (ϵ_r)	Conductivity Target (σ)	Permittivity Target (ϵ_r)	Delta (σ) (%)	Delta (ϵ_r) (%)	Limit (%)	Date
835	Head	22.6	0.905	42.233	0.90	41.50	0.56	1.77	± 5	Nov. 22, 2013
1900	Head	22.7	1.425	38.890	1.40	40.00	1.79	-2.78	± 5	Nov. 21, 2013
2450	Head	22.8	1.817	39.195	1.80	39.20	0.94	-0.01	± 5	Nov. 22, 2013
835	Body	22.5	0.983	54.851	0.97	55.20	1.34	-0.63	± 5	Nov. 22, 2013
1900	Body	22.9	1.555	53.533	1.52	53.30	2.30	0.44	± 5	Nov. 21, 2013
2450	Body	22.7	1.940	51.413	1.95	52.70	-0.51	-2.44	± 5	Nov. 21, 2013

Table 6.2 Measuring Results for Simulating Liquid

7. System Verification Procedures

Each DASY system is equipped with one or more system validation kits. These units, together with the predefined measurement procedures within the DASY software, enable the user to conduct the system performance check and system validation. System validation kit includes a dipole, tripod holder to fix it underneath the flat phantom and a corresponding distance holder.

7.1 Purpose of System Performance check

The system performance check verifies that the system operates within its specifications. System and operator errors can be detected and corrected. It is recommended that the system performance check be performed prior to any usage of the system in order to guarantee reproducible results. The system performance check uses normal SAR measurements in a simplified setup with a well characterized source. This setup was selected to give a high sensitivity to all parameters that might fail or vary over time. The system check does not intend to replace the calibration of the components, but indicates situations where the system uncertainty is exceeded due to drift or failure.

7.2 System Setup

In the simplified setup for system evaluation, the EUT is replaced by a calibrated dipole and the power source is replaced by a continuous wave that comes from a signal generator. The calibrated dipole must be placed beneath the flat phantom section of the SAM twin phantom with the correct distance holder. The distance holder should touch the phantom surface with a light pressure at the reference marking and be oriented parallel to the long side of the phantom. The equipment setup is shown below:

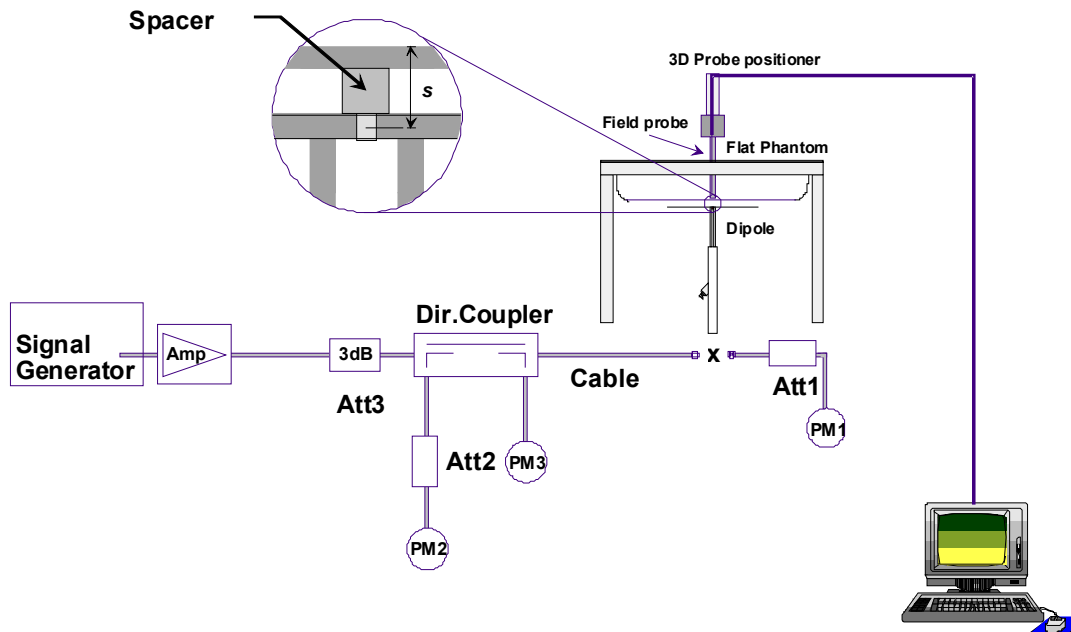

Fig 7.1 System Setup for System Evaluation

1. Signal Generator
2. Amplifier
3. Directional Coupler
4. Power Meter
5. Calibrated Dipole



Fig 7.2 Photo of Dipole Setup

7.3 SAR System Verification Results

Comparing to the original SAR value provided by SPEAG, the verification data should be within its specification of 10 %. Table 7.1 shows the target SAR and measured SAR after normalized to 1W input power. The table below indicates the system performance check can meet the variation criterion and the plots can be referred to Appendix A of this report.

Date	Frequency (MHz)	Liquid Type	Power fed onto reference dipole (mW)	Targeted SAR (W/kg)	Measured SAR (W/kg)	Normalized SAR (W/kg)	Deviation (%)
Nov. 22, 2013	835	Head	250	9.57	2.42	9.68	1.15
Nov. 21, 2013	1900	Head	250	40.6	9.91	39.64	-2.36
Nov. 22, 2013	2450	Head	250	53.60	13.10	52.40	-2.24
Nov. 22, 2013	835	Body	250	9.63	2.25	9.00	-6.54
Nov. 21, 2013	1900	Body	250	40.80	10.30	41.20	0.98
Nov. 21, 2013	2450	Body	250	50.40	12.60	50.40	0.00

Table 7.1 Target and Measurement SAR after Normalized

8. EUT Testing Position

8.1 Define two imaginary lines on the handset

- The vertical centerline passes through two points on the front side of the handset - the midpoint of the width w_t of the handset at the level of the acoustic output, and the midpoint of the width w_b of the bottom of the handset.
- The horizontal line is perpendicular to the vertical centerline and passes through the center of the acoustic output. The horizontal line is also tangential to the face of the handset at point A.
- The two lines intersect at point A. Note that for many handsets, point A coincides with the center of the acoustic output; however, the acoustic output may be located elsewhere on the horizontal line. Also note that the vertical centerline is not necessarily parallel to the front face of the handset, especially for clamshell handsets, handsets with flip covers, and other irregularly shaped handsets.

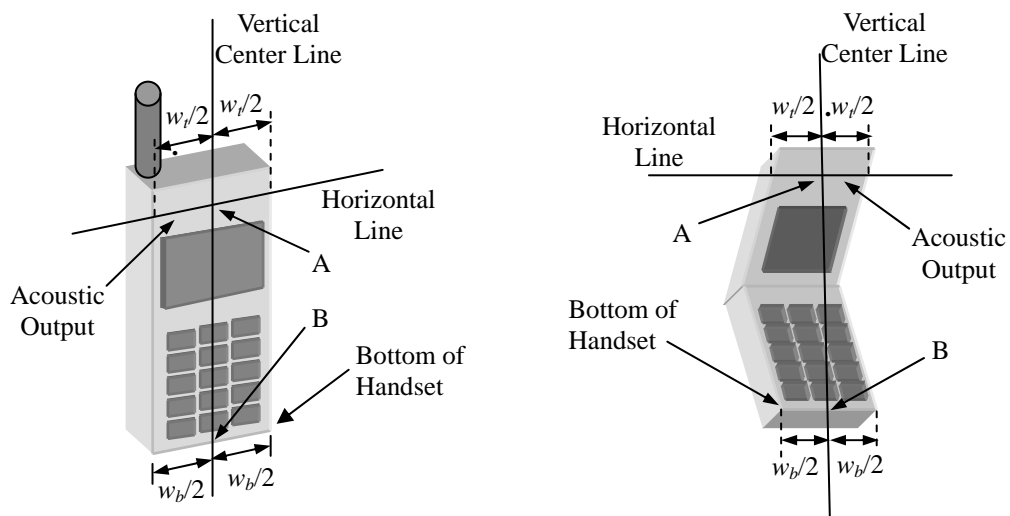

Fig 8.1 Illustration for Handset Vertical and Horizontal Reference Lines

8.2 Cheek Position

- (a) To position the device with the vertical center line of the body of the device and the horizontal line crossing the center piece in a plane parallel to the sagittal plane of the phantom. While maintaining the device in this plane, align the vertical center line with the reference plane containing the three ear and mouth reference point (M: Mouth, RE: Right Ear, and LE: Left Ear) and align the center of the ear piece with the line RE-LE.
- (b) To move the device towards the phantom with the ear piece aligned with the line LE-RE until the phone touched the ear. While maintaining the device in the reference plane and maintaining the phone contact with the ear, move the bottom of the phone until any point on the front side is in contact with the cheek of the phantom or until contact with the ear is lost (see Fig. 8.2).

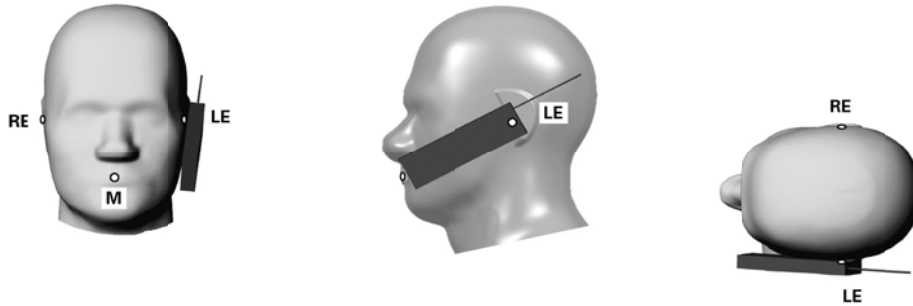

Fig 8.2 Illustration for Cheek Position

8.3 Tilted Position

- (a) To position the device in the “cheek” position described above.
- (b) While maintaining the device the reference plane described above and pivoting against the ear, moves it outward away from the mouth by an angle of 15 degrees or until contact with the ear is lost (see Fig. 8.3).

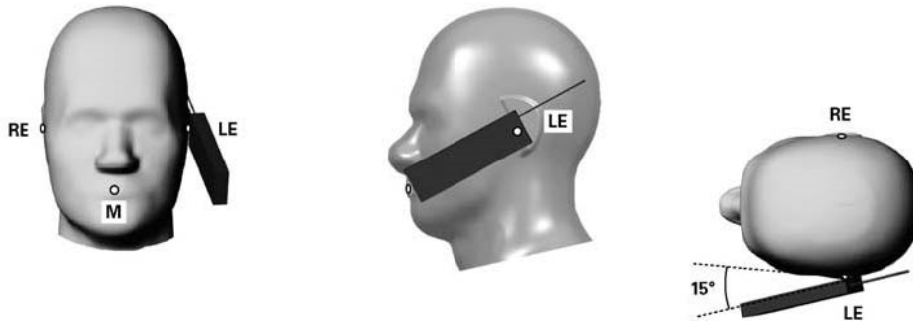

Fig 8.3 Illustration for Tilted Position

8.4 Body Worn Position

- (a) To position the device parallel to the phantom surface with either keypad up or down.
- (b) To adjust the device parallel to the flat phantom.
- (c) To adjust the distance between the device surface and the flat phantom to 1 cm.

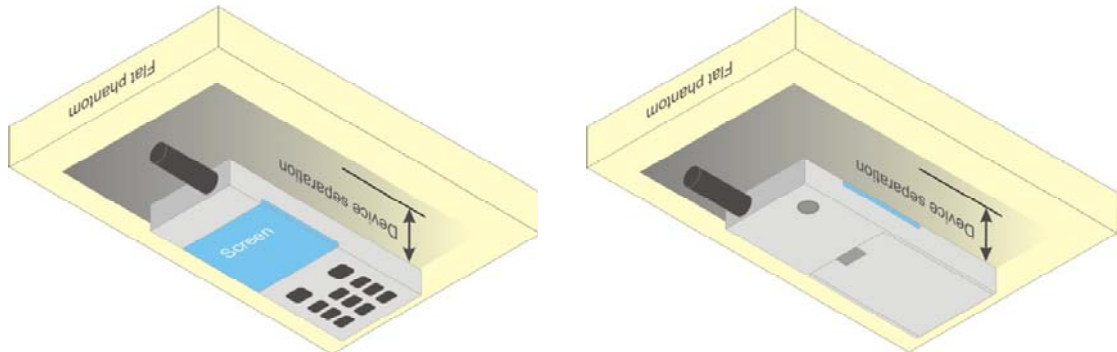

Fig 8.4 Illustration for Body Worn Position

8.5 Hotspot Position

- (a) To position the device parallel to the phantom surface with all sides and either keypad up or down.
- (b) To adjust the device parallel to the flat phantom.
- (c) To adjust the distance between the device and the flat phantom to 1 cm.

<EUT Setup Photos>

Please refer to Appendix D for the test setup photos.

9. Measurement Procedures

The measurement procedures are as follows:

<Conducted power measurement>

- (a) For WWAN power measurement, use base station simulator to configure EUT WWAN transmission in conducted connection with RF cable, at maximum power in each supported wireless interface and frequency band.
- (b) Read the WWAN RF power level from the base station simulator.
- (c) For WLAN/BT power measurement, use engineering software to configure EUT WLAN/BT continuously transmission, at maximum RF power in each supported wireless interface and frequency band
- (d) Connect EUT RF port through RF cable to the power meter, and measure WLAN/BT output power

<SAR measurement>

- (a) Use base station simulator to configure EUT WWAN transmission in radiated connection, and engineering software to configure EUT WLAN/BT continuously transmission, at maximum RF power, in the highest power channel.
- (b) Place the EUT in the positions as Appendix D demonstrates.
- (c) Set scan area, grid size and other setting on the DASY software.
- (d) Measure SAR results for the highest power channel on each testing position.
- (e) Find out the largest SAR result on these testing positions of each band
- (f) Measure SAR results for other channels in worst SAR testing position if the reported SAR of highest power channel is larger than 0.8 W/kg

According to the test standard, the recommended procedure for assessing the peak spatial-average SAR value consists of the following steps:

- (a) Power reference measurement
- (b) Area scan
- (c) Zoom scan
- (d) Power drift measurement

9.1 Spatial Peak SAR Evaluation

The procedure for spatial peak SAR evaluation has been implemented according to the test standard. It can be conducted for 1g and 10g, as well as for user-specific masses. The DASY software includes all numerical procedures necessary to evaluate the spatial peak SAR value.

The base for the evaluation is a "cube" measurement. The measured volume must include the 1g and 10g cubes with the highest averaged SAR values. For that purpose, the center of the measured volume is aligned to the interpolated peak SAR value of a previously performed area scan.

The entire evaluation of the spatial peak values is performed within the post-processing engine (SEMCAD). The system always gives the maximum values for the 1g and 10g cubes. The algorithm to find the cube with highest averaged SAR is divided into the following stages:

- (a) Extraction of the measured data (grid and values) from the Zoom Scan
- (b) Calculation of the SAR value at every measurement point based on all stored data (A/D values and measurement parameters)
- (c) Generation of a high-resolution mesh within the measured volume
- (d) Interpolation of all measured values from the measurement grid to the high-resolution grid
- (e) Extrapolation of the entire 3-D field distribution to the phantom surface over the distance from sensor to surface
- (f) Calculation of the averaged SAR within masses of 1g and 10g

9.2 Power Reference Measurement

The Power Reference Measurement and Power Drift Measurements are for monitoring the power drift of the device under test in the batch process. The minimum distance of probe sensors to surface determines the closest measurement point to phantom surface. This distance cannot be smaller than the distance of sensor calibration points to probe tip as defined in the probe properties.

9.3 Area & Zoom Scan Procedures

First Area Scan is used to locate the approximate location(s) of the local peak SAR value(s). The measurement grid within an Area Scan is defined by the grid extent, grid step size and grid offset. Next, in order to determine the EM field distribution in a three-dimensional spatial extension, Zoom Scan is required. The Zoom Scan is performed around the highest E-field value to determine the averaged SAR-distribution over 10 g. Area scan and zoom scan resolution setting follows KDB 865664 D01v01r01 quoted below.

When the 1-g SAR of the highest peak is within 2 dB of the SAR limit, additional zoom scans are required for other peaks within 2 dB of the highest peak that have not been included in any zoom scan to ensure there is no increase in SAR.

		≤ 3 GHz	> 3 GHz	
Maximum distance from closest measurement point (geometric center of probe sensors) to phantom surface		5 ± 1 mm	$\frac{1}{2} \delta \ln(2) \pm 0.5$ mm	
Maximum probe angle from probe axis to phantom surface normal at the measurement location		$30^\circ \pm 1^\circ$	$20^\circ \pm 1^\circ$	
Maximum area scan spatial resolution: $\Delta x_{Area}, \Delta y_{Area}$		≤ 2 GHz: ≤ 15 mm 2 – 3 GHz: ≤ 12 mm	3 – 4 GHz: ≤ 12 mm 4 – 6 GHz: ≤ 10 mm	
		When the x or y dimension of the test device, in the measurement plane orientation, is smaller than the above, the measurement resolution must be \leq the corresponding x or y dimension of the test device with at least one measurement point on the test device.		
Maximum zoom scan spatial resolution: $\Delta x_{Zoom}, \Delta y_{Zoom}$		≤ 2 GHz: ≤ 8 mm 2 – 3 GHz: ≤ 5 mm*	3 – 4 GHz: ≤ 5 mm* 4 – 6 GHz: ≤ 4 mm*	
Maximum zoom scan spatial resolution, normal to phantom surface	uniform grid: $\Delta z_{Zoom}(n)$	≤ 5 mm	3 – 4 GHz: ≤ 4 mm 4 – 5 GHz: ≤ 3 mm 5 – 6 GHz: ≤ 2 mm	
	graded grid	$\Delta z_{Zoom}(1)$: between 1 st two points closest to phantom surface	≤ 4 mm	3 – 4 GHz: ≤ 3 mm 4 – 5 GHz: ≤ 2.5 mm 5 – 6 GHz: ≤ 2 mm
		$\Delta z_{Zoom}(n>1)$: between subsequent points	$\leq 1.5 \cdot \Delta z_{Zoom}(n-1)$	
Minimum zoom scan volume	x, y, z	≥ 30 mm	3 – 4 GHz: ≥ 28 mm 4 – 5 GHz: ≥ 25 mm 5 – 6 GHz: ≥ 22 mm	
<p>Note: δ is the penetration depth of a plane-wave at normal incidence to the tissue medium; see draft standard IEEE P1528-2011 for details.</p> <p>* When zoom scan is required and the <i>reported</i> SAR from the area scan based 1-g SAR estimation procedures of KDB 447498 is ≤ 1.4 W/kg, ≤ 8 mm, ≤ 7 mm and ≤ 5 mm zoom scan resolution may be applied, respectively, for 2 GHz to 3 GHz, 3 GHz to 4 GHz and 4 GHz to 6 GHz.</p>				



9.4 Volume Scan Procedures

The volume scan is used for assess overlapping SAR distributions for antennas transmitting in different frequency bands. It is equivalent to an oversized zoom scan used in standalone measurements. The measurement volume will be used to enclose all the simultaneous transmitting antennas. For antennas transmitting simultaneously in different frequency bands, the volume scan is measured separately in each frequency band. In order to sum correctly to compute the 1g aggregate SAR, the EUT remain in the same test position for all measurements and all volume scan use the same spatial resolution and grid spacing. When all volume scan were completed, the software, SEMCAD postprocessor can combine and subsequently superpose these measurement data to calculating the multiband SAR.

9.5 SAR Averaged Methods

In DASYS, the interpolation and extrapolation are both based on the modified Quadratic Shepard's method. The interpolation scheme combines a least-square fitted function method and a weighted average method which are the two basic types of computational interpolation and approximation.

Extrapolation routines are used to obtain SAR values between the lowest measurement points and the inner phantom surface. The extrapolation distance is determined by the surface detection distance and the probe sensor offset. The uncertainty increases with the extrapolation distance. To keep the uncertainty within 1% for the 1 g and 10 g cubes, the extrapolation distance should not be larger than 5 mm.

9.6 Power Drift Monitoring

All SAR testing is under the EUT install full charged battery and transmit maximum output power. In DASYS measurement software, the power reference measurement and power drift measurement procedures are used for monitoring the power drift of EUT during SAR test. Both these procedures measure the field at a specified reference position before and after the SAR testing. The software will calculate the field difference in dB. If the power drifts more than 5%, the SAR will be retested.



10. Conducted RF Output Power (Unit: dBm)

<GSM Conducted Power>

Note:

1. Per KDB 447498 D01v05r01, the maximum output power channel is used for SAR testing and for further SAR test reduction.
2. The EUT do not support DTM function.
3. For head SAR testing, the EUT was set in GSM Voice for GSM850 and GSM1900.
4. For hotspot SAR testing, the EUT was set in GPRS 4 Tx slots for GSM850 and GSM1900.
5. For body worn SAR testing, the EUT was set in GPRS 4 Tx slots and GSM Voice for GSM850 and GSM1900.

<SIM1>

Band: GSM850	Burst Average Power (dBm)			Frame-Average Power (dBm)		
Channel	128	189	251	128	189	251
Frequency (MHz)	824.2	836.4	848.8	824.2	836.4	848.8
GSM (GMSK, 1 Tx slot)	32.37	32.30	32.27	23.37	23.30	23.27
GPRS (GMSK, 1 Tx slot)	32.36	32.31	32.26	23.36	23.31	23.26
GPRS (GMSK, 2 Tx slots)	31.61	31.56	31.49	25.61	25.56	25.49
GPRS (GMSK, 3 Tx slots)	29.83	29.78	29.70	25.57	25.52	25.44
GPRS (GMSK, 4 Tx slots)	28.70	28.67	28.58	25.70	25.67	25.58
EDGE (8PSK, 1 Tx slot)	27.27	27.08	26.79	18.27	18.08	17.79
EDGE (8PSK, 2 Tx slots)	26.17	26.00	25.65	20.17	20.00	19.65
EDGE (8PSK, 3 Tx slots)	23.89	23.70	23.25	19.63	19.44	18.99
EDGE (8PSK, 4 Tx slots)	22.48	22.29	21.98	19.48	19.29	18.98
Band: GSM1900	Burst Average Power (dBm)			Frame-Average Power (dBm)		
Channel	512	661	810	512	661	810
Frequency (MHz)	1850.2	1880.0	1909.8	1850.2	1880.0	1909.8
GSM (GMSK, 1 Tx slot)	29.19	29.05	29.09	20.19	20.05	20.09
GPRS (GMSK, 1 Tx slot)	29.17	29.04	29.08	20.17	20.04	20.08
GPRS (GMSK, 2 Tx slots)	28.43	28.35	28.38	22.43	22.35	22.38
GPRS (GMSK, 3 Tx slots)	26.65	26.57	26.59	22.39	22.31	22.33
GPRS (GMSK, 4 Tx slots)	25.49	25.42	25.45	22.49	22.42	22.45
EDGE (8PSK, 1 Tx slot)	25.85	26.08	26.24	16.85	17.08	17.24
EDGE (8PSK, 2 Tx slots)	24.67	24.90	25.04	18.67	18.90	19.04
EDGE (8PSK, 3 Tx slots)	22.22	22.40	22.50	17.96	18.14	18.24
EDGE (8PSK, 4 Tx slots)	20.80	20.90	21.13	17.80	17.90	18.13

Remark: The frame-averaged power is linearly scaled the maximum burst averaged power over 8 time slots.

The calculated method are shown as below:

Frame-averaged power = Maximum burst averaged power (1 Tx Slot) - 9 dB

Frame-averaged power = Maximum burst averaged power (2 Tx Slots) - 6 dB

Frame-averaged power = Maximum burst averaged power (3 Tx Slots) - 4.26 dB

Frame-averaged power = Maximum burst averaged power (4 Tx Slots) - 3 dB



<SIM2>

Band: GSM850	Burst Average Power (dBm)			Frame-Average Power (dBm)		
Channel	128	189	251	128	189	251
Frequency (MHz)	824.2	836.4	848.8	824.2	836.4	848.8
GSM (GMSK, 1 Tx slot)	32.39	32.31	32.26	23.39	23.31	23.26
GPRS (GMSK, 1 Tx slot)	32.38	32.32	32.25	23.38	23.32	23.25
GPRS (GMSK, 2 Tx slots)	31.62	31.57	31.50	25.62	25.57	25.50
GPRS (GMSK, 3 Tx slots)	29.84	29.79	29.70	25.58	25.53	25.44
GPRS (GMSK, 4 Tx slots)	28.72	28.68	28.60	25.72	25.68	25.60
EDGE (8PSK, 1 Tx slot)	27.29	27.10	26.78	18.29	18.10	17.78
EDGE (8PSK, 2 Tx slots)	26.18	26.01	25.67	20.18	20.01	19.67
EDGE (8PSK, 3 Tx slots)	23.91	23.73	23.28	19.65	19.47	19.02
EDGE (8PSK, 4 Tx slots)	22.50	22.31	22.00	19.50	19.31	19.00
Band: GSM1900	Burst Average Power (dBm)			Frame-Average Power (dBm)		
Channel	512	661	810	512	661	810
Frequency (MHz)	1850.2	1880.0	1909.8	1850.2	1880.0	1909.8
GSM (GMSK, 1 Tx slot)	29.21	29.07	29.11	20.21	20.07	20.11
GPRS (GMSK, 1 Tx slot)	29.20	29.06	29.10	20.20	20.06	20.10
GPRS (GMSK, 2 Tx slots)	28.45	28.35	28.40	22.45	22.35	22.40
GPRS (GMSK, 3 Tx slots)	26.65	26.59	26.61	22.39	22.33	22.35
GPRS (GMSK, 4 Tx slots)	25.50	25.44	25.47	22.50	22.44	22.47
EDGE (8PSK, 1 Tx slot)	25.86	26.10	26.26	16.86	17.10	17.26
EDGE (8PSK, 2 Tx slots)	24.70	24.93	25.05	18.70	18.93	19.05
EDGE (8PSK, 3 Tx slots)	22.23	22.42	22.51	17.97	18.16	18.25
EDGE (8PSK, 4 Tx slots)	20.82	20.91	21.15	17.82	17.91	18.15

Remark: The frame-averaged power is linearly scaled the maximum burst averaged power over 8 time slots.
The calculated method are shown as below:
Frame-averaged power = Maximum burst averaged power (1 Tx Slot) - 9 dB
Frame-averaged power = Maximum burst averaged power (2 Tx Slots) - 6 dB
Frame-averaged power = Maximum burst averaged power (3 Tx Slots) - 4.26 dB
Frame-averaged power = Maximum burst averaged power (4 Tx Slots) - 3 dB

<WCDMA Conducted Power>

The following tests were conducted according to the test requirements outlines in 3GPP TS 34.121 specification.

A summary of these settings are illustrated below:

HSDPA Setup Configuration:

- a. The EUT was connected to Base Station Agilent E5515C referred to the Setup Configuration.
- b. The RF path losses were compensated into the measurements.
- c. A call was established between EUT and Base Station with following setting:
 - i. Set Gain Factors (β_c and β_d) and parameters were set according to each
 - ii. Specific sub-test in the following table, C10.1.4, quoted from the TS 34.121
 - iii. Set RMC 12.2Kbps + HSDPA mode.
 - iv. Set Cell Power = -86 dBm
 - v. Set HS-DSCH Configuration Type to FRC (H-set 1, QPSK)
 - vi. Select HSDPA Uplink Parameters
 - vii. Set Delta ACK, Delta NACK and Delta CQI = 8
 - viii. Set Ack-Nack Repetition Factor to 3
 - ix. Set CQI Feedback Cycle (k) to 4 ms
 - x. Set CQI Repetition Factor to 2
 - xi. Power Ctrl Mode = All Up bits
- d. The transmitted maximum output power was recorded.

Table C.10.1.4: β values for transmitter characteristics tests with HS-DPCCH

Sub-test	β_c	β_d	β_d (SF)	β_c/β_d	β_{HS} (Note 1, Note 2)	CM (dB) (Note 3)	MPR (dB) (Note 3)
1	2/15	15/15	64	2/15	4/15	0.0	0.0
2	12/15 (Note 4)	15/15 (Note 4)	64	12/15 (Note 4)	24/15	1.0	0.0
3	15/15	8/15	64	15/8	30/15	1.5	0.5
4	15/15	4/15	64	15/4	30/15	1.5	0.5

Note 1: $\Delta_{ACK}, \Delta_{NACK}$ and $\Delta_{CQI} = 30/15$ with $\beta_{HS} = 30/15 * \beta_c$.

Note 2: For the HS-DPCCH power mask requirement test in clause 5.2C, 5.7A, and the Error Vector Magnitude (EVM) with HS-DPCCH test in clause 5.13.1A, and HSDPA EVM with phase discontinuity in clause 5.13.1AA, Δ_{ACK} and $\Delta_{NACK} = 30/15$ with $\beta_{HS} = 30/15 * \beta_c$, and $\Delta_{CQI} = 24/15$ with $\beta_{HS} = 24/15 * \beta_c$.

Note 3: CM = 1 for $\beta_c/\beta_d = 12/15$, $\beta_{HS}/\beta_c = 24/15$. For all other combinations of DPDCH, DPCCH and HS-DPCCH the MPR is based on the relative CM difference. This is applicable for only UEs that support HSDPA in release 6 and later releases.

Note 4: For subtest 2 the β_c/β_d ratio of 12/15 for the TFC during the measurement period (TF1, TF0) is achieved by setting the signalled gain factors for the reference TFC (TF1, TF1) to $\beta_c = 11/15$ and $\beta_d = 15/15$.

Setup Configuration

HSUPA Setup Configuration:

- a. The EUT was connected to Base Station Agilent E5515C referred to the Setup Configuration.
- b. The RF path losses were compensated into the measurements.
- c. A call was established between EUT and Base Station with following setting * :
 - i. Call Configs = 5.2B, 5.9B, 5.10B, and 5.13.2B with QPSK
 - ii. Set the Gain Factors (β_c and β_d) and parameters (AG Index) were set according to each specific sub-test in the following table, C11.1.3, quoted from the TS 34.121
 - iii. Set Cell Power = -86 dBm
 - iv. Set Channel Type = 12.2k + HSPA
 - v. Set UE Target Power
 - vi. Power Ctrl Mode= Alternating bits
 - vii. Set and observe the E-TFCl
 - viii. Confirm that E-TFCl is equal to the target E-TFCl of 75 for sub-test 1, and other subtest's E-TFCl
- d. The transmitted maximum output power was recorded.

Table C.11.1.3: β values for transmitter characteristics tests with HS-DPCCH and E-DCH

Sub-test	β_c	β_d	β_d (SF)	β_c/β_d	β_{HS} (Note 1)	β_{ec}	β_{ed} (Note 5) (Note 6)	β_{ed} (SF)	β_{ed} (Codes)	CM (dB) (Note 2)	MPR (dB) (Note 2)	AG Index (Note 6)	E-TFCl
1	11/15 (Note 3)	15/15 (Note 3)	64	11/15 (Note 3)	22/15	209/225	1309/225	4	1	1.0	0.0	20	75
2	6/15	15/15	64	6/15	12/15	12/15	94/75	4	1	3.0	2.0	12	67
3	15/15	9/15	64	15/9	30/15	30/15	$\beta_{ed1}: 47/15$ $\beta_{ed2}: 47/15$	4	2	2.0	1.0	15	92
4	2/15	15/15	64	2/15	4/15	2/15	56/75	4	1	3.0	2.0	17	71
5	15/15 (Note 4)	15/15 (Note 4)	64	15/15 (Note 4)	30/15	24/15	134/15	4	1	1.0	0.0	21	81

Note 1: $\Delta_{ACK}, \Delta_{NACK}$ and $\Delta_{CQI} = 30/15$ with $\beta_{hs} = 30/15 * \beta_c$.

Note 2: CM = 1 for $\beta_c/\beta_d = 12/15, \beta_{hs}/\beta_c = 24/15$. For all other combinations of DPDCH, DPCCH, HS- DPCCH, E-DPDCH and E-DPCCH the MPR is based on the relative CM difference.

Note 3: For subtest 1 the β_c/β_d ratio of 11/15 for the TFC during the measurement period (TF1, TF0) is achieved by setting the signalled gain factors for the reference TFC (TF1, TF1) to $\beta_c = 10/15$ and $\beta_d = 15/15$.

Note 4: For subtest 5 the β_c/β_d ratio of 15/15 for the TFC during the measurement period (TF1, TF0) is achieved by setting the signalled gain factors for the reference TFC (TF1, TF1) to $\beta_c = 14/15$ and $\beta_d = 15/15$.

Note 5: In case of testing by UE using E-DPDCH Physical Layer category 1, Sub-test 3 is omitted according to TS25.306 Table 5.1g.

Note 6: β_{ed} can not be set directly, it is set by Absolute Grant Value.

Setup Configuration



<WCDMA Conducted Power>

Note:

1. Applying the subtest setup in Table C10.1.4 and Table C.11.1.3 of 3GPP TS 34.121-1 V9.1.0 to Rel. 6 HSPA.
2. Per KDB 941225 D01v02, RMC 12.2kbps setting is used to evaluate SAR. If AMR 12.2kbps power is < 0.25dB higher than RMC 12.2kbps, SAR tests with AMR 12.2kbps can be excluded.
3. By design, AMR, HSDPA/HSUPA RF power will not be larger than RMC 12.2kbps, detailed information is included in Tune-up Procure exhibit.
4. It is expected by the manufacturer that MPR for some HSDPA/HSUPA subtests may differ from the specification of 3GPP, according to the chipset implementation in this model. The implementation and expected deviation are detailed in tune-up procedure exhibit.

<SIM1>

Band		WCDMA Band V			WCDMA Band II		
Tx Channel		4132	4182	4233	9262	9400	9538
Rx Channel		4357	4407	4458	9662	9800	9938
Frequency (MHz)		826.4	836.4	846.6	1852.4	1880	1907.6
3GPP Rel 99	AMR	22.18	22.23	21.94	22.78	22.45	21.96
3GPP Rel 99	RMC 12.2Kbps	22.21	22.25	21.96	22.80	22.48	22.00
3GPP Rel 6	HSDPA Subtest-1	21.40	21.10	21.09	21.07	20.90	20.72
3GPP Rel 6	HSDPA Subtest-2	21.38	21.08	21.06	21.05	20.90	20.71
3GPP Rel 6	HSDPA Subtest-3	20.94	20.63	20.63	20.60	20.44	20.26
3GPP Rel 6	HSDPA Subtest-4	20.92	20.62	20.60	20.58	20.41	20.23
3GPP Rel 6	HSUPA Subtest-1	19.50	19.40	19.21	19.60	19.45	19.19
3GPP Rel 6	HSUPA Subtest-2	19.48	19.38	19.20	18.97	19.44	19.18
3GPP Rel 6	HSUPA Subtest-3	20.47	20.41	20.22	20.10	20.45	20.15
3GPP Rel 6	HSUPA Subtest-4	19.08	18.90	18.70	19.50	18.90	18.67
3GPP Rel 6	HSUPA Subtest-5	19.92	20.90	20.68	20.05	20.13	20.63
3GPP MPR specification	MPR result	WCDMA Band V			WCDMA Band II		
0	HSDPA Subtest-1	0.00	0.00	0.00	0.00	0.00	0.00
0	HSDPA Subtest-2	0.02	0.02	0.03	0.02	0.00	0.01
≤ 0.5	HSDPA Subtest-3	0.46	0.47	0.46	0.47	0.46	0.46
≤ 0.5	HSDPA Subtest-4	0.48	0.48	0.49	0.49	0.49	0.49
≤ 0	HSUPA Subtest-1	0.42	1.50	1.47	0.45	0.68	1.44
≤ 2	HSUPA Subtest-2	0.44	1.52	1.48	1.08	0.69	1.45
≤ 1	HSUPA Subtest-3	-0.55	0.49	0.46	-0.05	-0.32	0.48
≤ 2	HSUPA Subtest-4	0.84	2.00	1.98	0.55	1.23	1.96
≤ 0	HSUPA Subtest-5	0.00	0.00	0.00	0.00	0.00	0.00



<SIM2>

Band		WCDMA Band V			WCDMA Band II		
Tx Channel		4132	4182	4233	9262	9400	9538
Rx Channel		4357	4407	4458	9662	9800	9938
Frequency (MHz)		826.4	836.4	846.6	1852.4	1880	1907.6
3GPP Rel 99	AMR	22.20	22.24	21.95	22.80	22.46	21.97
3GPP Rel 99	RMC 12.2Kbps	22.23	22.26	21.98	22.82	22.50	22.01
3GPP Rel 6	HSDPA Subtest-1	21.41	21.12	21.11	21.08	20.91	20.73
3GPP Rel 6	HSDPA Subtest-2	21.40	21.11	21.10	21.09	20.90	20.73
3GPP Rel 6	HSDPA Subtest-3	20.96	20.65	20.65	20.63	20.45	20.28
3GPP Rel 6	HSDPA Subtest-4	20.95	20.64	20.62	20.62	20.42	20.24
3GPP Rel 6	HSUPA Subtest-1	19.53	19.42	19.24	19.62	19.46	19.19
3GPP Rel 6	HSUPA Subtest-2	19.53	19.42	19.22	18.96	19.46	19.19
3GPP Rel 6	HSUPA Subtest-3	20.49	20.40	20.23	20.11	20.48	20.16
3GPP Rel 6	HSUPA Subtest-4	19.09	18.91	18.71	19.52	18.90	18.69
3GPP Rel 6	HSUPA Subtest-5	19.93	20.89	20.70	20.08	20.14	20.64
3GPP MPR specification	MPR result	WCDMA Band V			WCDMA Band II		
0	HSDPA Subtest-1	0.00	0.00	0.00	0.00	0.00	0.00
0	HSDPA Subtest-2	0.01	0.01	0.01	-0.01	0.01	0.00
≤0.5	HSDPA Subtest-3	0.45	0.47	0.46	0.45	0.46	0.45
≤0.5	HSDPA Subtest-4	0.46	0.48	0.49	0.46	0.49	0.49
≤0	HSUPA Subtest-1	0.40	1.47	1.46	0.46	0.68	1.45
≤2	HSUPA Subtest-2	0.40	1.47	1.48	1.12	0.68	1.45
≤1	HSUPA Subtest-3	-0.56	0.49	0.47	-0.03	-0.34	0.48
≤2	HSUPA Subtest-4	0.84	1.98	1.99	0.56	1.24	1.95
≤0	HSUPA Subtest-5	0.00	0.00	0.00	0.00	0.00	0.00



<WLAN 2.4GHz Conducted Power>

802.11b Average Power (dBm)					
Channel	Frequency (MHz)	Data Rate (bps)			
		1M bps	2M bps	5.5M bps	11M bps
CH 01	2412	11.30	11.28	11.38	11.34
CH 06	2437	11.35	11.35	11.40	11.48
CH 11	2462	11.59	11.35	11.53	11.51

802.11g Average Power (dBm)									
Channel	Frequency (MHz)	Data Rate (bps)							
		6M bps	9M bps	12M bps	18M bps	24M bps	36M bps	48M bps	54M bps
CH 01	2412	9.12	8.92	8.81	8.73	8.87	8.90	8.88	8.91
CH 06	2437	9.18	8.98	9.14	9.09	9.06	9.07	9.16	9.17
CH 11	2462	9.28	9.22	8.87	8.95	9.06	9.27	9.18	8.82

WLAN 2.4GHz Band 802.11n-HT20 Average Power (dBm)									
Channel	Frequency (MHz)	MCS Index							
		MCS0	MCS1	MCS2	MCS3	MCS4	MCS5	MCS6	MCS7
CH 01	2412	7.52	7.10	7.22	7.28	7.65	7.45	7.34	7.14
CH 06	2437	7.05	7.05	7.33	7.32	7.33	7.34	7.47	7.24
CH 11	2462	7.66	7.31	7.58	7.58	7.59	7.55	7.59	7.42

WLAN 2.4GHz Band 802.11n-HT40 Average Power (dBm)									
Channel	Frequency (MHz)	MCS Index							
		MCS0	MCS1	MCS2	MCS3	MCS4	MCS5	MCS6	MCS7
CH 03	2422	3.62	3.39	3.46	3.42	3.55	3.31	3.57	3.61
CH 06	2437	2.95	3.09	2.96	3.08	3.38	3.33	3.43	3.50
CH 09	2452	2.79	2.70	2.63	2.74	2.87	2.81	3.10	2.95

Note:

1. Per KDB 248227 D01 v01r02, choose the highest output power channel to test SAR and determine further SAR exclusion
2. For each frequency band, testing at higher data rates and higher order modulations is not required when the maximum average output power for each of these configurations is less than 1/4dB higher than those measured at the lowest data rate
3. Apply the test exclusion rule in KDB 248227 D01 v01r02 11g, 11n-HT20 and 11n-HT40 output power is less than 1/4dB higher than 11b mode, thus the SAR can be excluded.

<Bluetooth Conducted Power>

Bluetooth average power (dBm)				
Mode	1Mbps (GFSK)	2Mbps (π/4-DQPSK)	3Mbps (8-DPSK)	BT4.0-LE (GFSK)
Tune Up Limit	7.5	5.5	5.5	-1

Note:

1. Per KDB 447498 D01v05r01, the 1-g and 10-g SAR test exclusion thresholds for 100 MHz to 6 GHz at test separation distances ≤ 50 mm are determined by:

$$[(\text{max. power of channel, including tune-up tolerance, mW}) / (\text{min. test separation distance, mm})] \cdot [\sqrt{f(\text{GHz})}] \leq 3.0$$
 for 1-g SAR and ≤ 7.5 for 10-g extremity SAR
 - f(GHz) is the RF channel transmit frequency in GHz
 - Power and distance are rounded to the nearest mW and mm before calculation
 - The result is rounded to one decimal place for comparison
 - If the distance of the antenna to the user is < 5mm, 5mm is used to determine SAR exclusion threshold

Bluetooth Max Power (dBm)	mW	Test Distance (mm)	Frequency (GHz)	exclusion thresholds
7.5	5.62	0	2.48	1.77
		10	2.48	0.89

2. Per KDB 447498 D01v05r01 exclusion thresholds is 1.77 < 3, RF exposure evaluation is not required.

11. Antenna Location

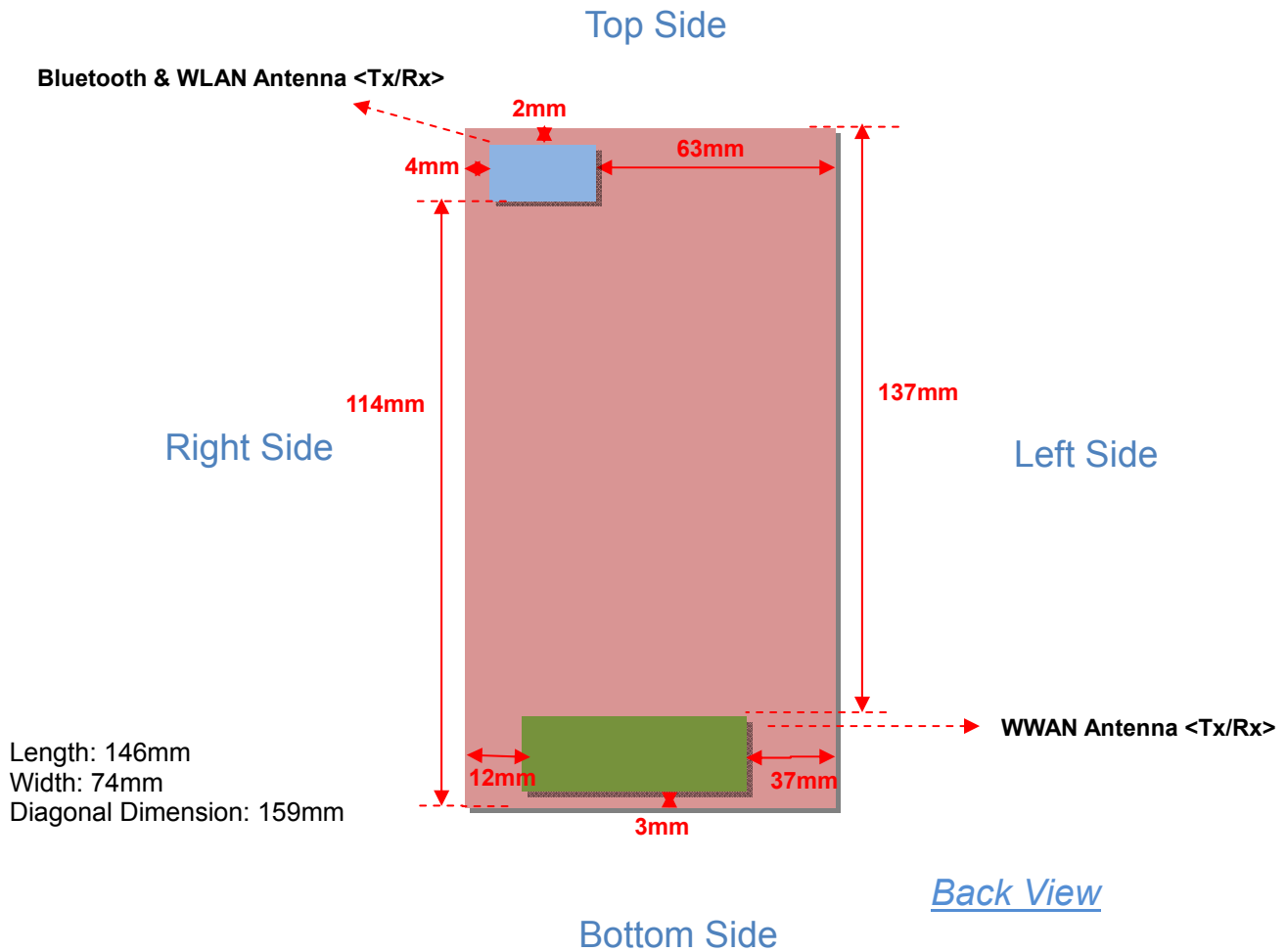

Antennas	Wireless Interface
WWAN Antenna <Tx / Rx>	GSM850 GSM1900 WCDMA Band V WCDMA Band II
Bluetooth & WLAN Antenna <Tx / Rx>	WLAN 2.4GHz Band Bluetooth



Distance of the Antenna to the EUT surface/edge						
Antennas	Back	Front	Top Side	Bottom Side	Right Side	Left Side
WWAN	≤ 25mm	≤ 25mm	137mm	≤ 25mm	≤ 25mm	37mm
Bluetooth & WLAN	≤ 25mm	≤ 25mm	≤ 25mm	114mm	≤ 25mm	63mm

Positions for SAR tests; Hotspot mode						
Antennas	Back	Front	Top Side	Bottom Side	Right Side	Left Side
WWAN	Yes	Yes	No	Yes	Yes	No
Bluetooth & WLAN	Yes	Yes	Yes	No	Yes	No

Note:

1. Head/Body-worn/Hotspot mode SAR assessments are required.
2. Referring to KDB 941225 D06 v01r01, when the overall device length and width are ≥ 9cm*5cm, the test distance is 10 mm. SAR must be measured for all sides and surfaces with a transmitting antenna located within 25mm from that surface or edge
3. Per KDB 447498 D01v05r01, for handsets the *test separation distance* is determined by the smallest distance between the outer surface of the device and the user; which is 0mm for head SAR, 10mm for hotspot SAR, 10mm for body-worn SAR.



12. SAR Test Results

Note:

1. Per KDB 447498 D01v05r01, the reported SAR is the measured SAR value adjusted for maximum tune-up tolerance.
 - a. Tune-up scaling Factor = tune-up limit power (mW) / EUT RF power (mW), where tune-up limit is the maximum rated power among all production units.
 - b. Reported SAR(W/kg)= Measured SAR(W/kg)*Tune-up Scaling Factor.
2. Per KDB 447498 D01v05r01, for each exposure position, if the highest output channel reported SAR ≤0.8W/kg, other channels SAR testing is not necessary.
3. For Hotspot SAR testing, per KDB 941225 D06v01r01, for EUT dimension ≥ 9cm*5cm, the test distance is 1cm. SAR must be measured for all surfaces and sides with a transmitting antenna located within 2.5cm from that surface or edge.
4. Body-worn exposure conditions are intended to voice call and GPRS operations, therefore GSM voice call and GPRS modes are selected to be tested.
5. Per KDB 648474 D04v01, when the reported SAR for a body-worn accessory measured without a headset connected to the handset is ≤ 1.2 W/kg, SAR testing with a headset connected to the handset is not required.
6. Per KDB 941225 D02v02r02, RMC 12.2kbps setting is used to evaluate SAR. If HSDPA/HSUPA output power is < 0.25dB higher than RMC, or reported SAR with RMC 12.2kbps setting is ≤ 1.2W/kg, HSDPA/HSUPA SAR evaluation can be excluded.

12.1 Head SAR

<GSM SAR>

Plot No.	Band	Mode	Test Position	Ch.	Freq. (MHz)	Average Power (dBm)	Tune-Up Limit (dBm)	Scaling Factor	Power Drift (dB)	Measured 1g SAR (W/kg)	Reported 1g SAR (W/kg)
1	GSM850	GSM	Right Cheek	128	824.2	32.39	33	1.151	-0.02	0.230	0.265
2	GSM850	GSM	Right Tilted	128	824.2	32.39	33	1.151	-0.08	0.137	0.158
3	GSM850	GSM	Left Cheek	128	824.2	32.39	33	1.151	0.08	0.255	0.293
4	GSM850	GSM	Left Tilted	128	824.2	32.39	33	1.151	0.14	0.135	0.155
7	GSM1900	GSM	Right Cheek	512	1850.2	29.21	29.5	1.069	-0.06	0.127	0.136
8	GSM1900	GSM	Right Tilted	512	1850.2	29.21	29.5	1.069	0.03	0.044	0.047
9	GSM1900	GSM	Left Cheek	512	1850.2	29.21	29.5	1.069	-0.02	0.062	0.066
10	GSM1900	GSM	Left Tilted	512	1850.2	29.21	29.5	1.069	-0.12	0.045	0.048

<WCDMA SAR>

Plot No.	Band	Mode	Test Position	Ch.	Freq. (MHz)	Average Power (dBm)	Tune-Up Limit (dBm)	Scaling Factor	Power Drift (dB)	Measured 1g SAR (W/kg)	Reported 1g SAR (W/kg)
13	WCDMA Band V	RMC12.2K	Right Cheek	4182	836.4	22.26	22.5	1.057	0.07	0.198	0.209
14	WCDMA Band V	RMC12.2K	Right Tilted	4182	836.4	22.26	22.5	1.057	-0.0068	0.100	0.106
15	WCDMA Band V	RMC12.2K	Left Cheek	4182	836.4	22.26	22.5	1.057	0.06	0.224	0.237
16	WCDMA Band V	RMC12.2K	Left Tilted	4182	836.4	22.26	22.5	1.057	0.04	0.110	0.116
19	WCDMA Band II	RMC 12.2K	Right Cheek	9262	1852.4	22.82	23	1.042	-0.06	0.251	0.262
20	WCDMA Band II	RMC 12.2K	Right Tilted	9262	1852.4	22.82	23	1.042	-0.07	0.083	0.087
21	WCDMA Band II	RMC 12.2K	Left Cheek	9262	1852.4	22.82	23	1.042	-0.03	0.122	0.127
22	WCDMA Band II	RMC 12.2K	Left Tilted	9262	1852.4	22.82	23	1.042	0.02	0.087	0.091



<WLAN2.4GHz SAR>

Plot No.	Band	Mode	Test Position	Ch.	Freq. (MHz)	Average Power (dBm)	Tune-Up Limit (dBm)	Scaling Factor	Power Drift (dB)	Measured 1g SAR (W/kg)	Reported 1g SAR (W/kg)
25	WLAN 2.4GHz	802.11b	Right Cheek	11	2462	11.59	12	1.099	-0.05	0.175	0.192
26	WLAN 2.4GHz	802.11b	Right Tilted	11	2462	11.59	12	1.099	0.02	0.167	0.184
27	WLAN 2.4GHz	802.11b	Left Cheek	11	2462	11.59	12	1.099	0.13	0.290	0.319
28	WLAN 2.4GHz	802.11b	Left Tilted	11	2462	11.59	12	1.099	0.15	0.179	0.197

12.2 Hotspot SAR

<GSM SAR>

Plot No.	Band	Mode	Test Position	Gap (cm)	Ch.	Freq. (MHz)	Average Power (dBm)	Tune-Up Limit (dBm)	Scaling Factor	Power Drift (dB)	Measured 1g SAR (W/kg)	Reported 1g SAR (W/kg)
31	GSM850	GPRS (4 Tx slots)	Front	1	128	824.2	28.72	29	1.067	0.02	0.616	0.657
32	GSM850	GPRS (4 Tx slots)	Back	1	128	824.2	28.72	29	1.067	-0.03	0.655	0.699
34	GSM850	GPRS (4 Tx slots)	Right Side	1	128	824.2	28.72	29	1.067	-0.0037	0.521	0.556
35	GSM850	GPRS (4 Tx slots)	Bottom Side	1	128	824.2	28.72	29	1.067	-0.12	0.081	0.086
39	GSM1900	GPRS (4 Tx slots)	Front	1	512	1850.2	25.5	26	1.122	0.09	0.422	0.473
40	GSM1900	GPRS (4 Tx slots)	Back	1	512	1850.2	25.5	26	1.122	0.08	0.296	0.332
42	GSM1900	GPRS (4 Tx slots)	Right Side	1	512	1850.2	25.5	26	1.122	0.09	0.219	0.246
43	GSM1900	GPRS (4 Tx slots)	Bottom Side	1	512	1850.2	25.5	26	1.122	-0.02	0.446	0.500

<WCDMA SAR>

Plot No.	Band	Mode	Test Position	Gap (cm)	Ch.	Freq. (MHz)	Average Power (dBm)	Tune-Up Limit (dBm)	Scaling Factor	Power Drift (dB)	Measured 1g SAR (W/kg)	Reported 1g SAR (W/kg)
47	WCDMA Band V	RMC 12.2K	Front	1	4182	836.4	22.26	22.5	1.057	0.0061	0.269	0.284
48	WCDMA Band V	RMC 12.2K	Back	1	4182	836.4	22.26	22.5	1.057	-0.0046	0.287	0.303
50	WCDMA Band V	RMC 12.2K	Right Side	1	4182	836.4	22.26	22.5	1.057	-0.03	0.196	0.207
51	WCDMA Band V	RMC 12.2K	Bottom Side	1	4182	836.4	22.26	22.5	1.057	-0.02	0.043	0.045
54	WCDMA Band II	RMC12.2K	Front	1	9262	1852.4	22.82	23	1.042	-0.07	0.457	0.476
55	WCDMA Band II	RMC12.2K	Back	1	9262	1852.4	22.82	23	1.042	0.06	0.326	0.340
57	WCDMA Band II	RMC12.2K	Right Side	1	9262	1852.4	22.82	23	1.042	0.07	0.258	0.269
58	WCDMA Band II	RMC12.2K	Bottom Side	1	9262	1852.4	22.82	23	1.042	-0.11	0.521	0.543

<WLAN2.4GHz SAR>

Plot No.	Band	Mode	Test Position	Gap (cm)	Ch.	Freq. (MHz)	Average Power (dBm)	Tune-Up Limit (dBm)	Scaling Factor	Power Drift (dB)	Measured 1g SAR (W/kg)	Reported 1g SAR (W/kg)
61	WLAN 2.4GHz	802.11b	Front	1	11	2462	11.59	12	1.099	0.04	0.069	0.076
62	WLAN 2.4GHz	802.11b	Back	1	11	2462	11.59	12	1.099	-0.05	0.097	0.107
63	WLAN 2.4GHz	802.11b	Right Side	1	11	2462	11.59	12	1.099	-0.06	0.041	0.045
64	WLAN 2.4GHz	802.11b	Top Side	1	11	2462	11.59	12	1.099	0.04	0.023	0.025



12.3 Body Worn SAR

<GSM SAR>

Plot No.	Band	Mode	Test Position	Gap (cm)	Ch.	Freq. (MHz)	Average Power (dBm)	Tune-Up Limit (dBm)	Scaling Factor	Power Drift (dB)	Measured 1g SAR (W/kg)	Reported 1g SAR (W/kg)
31	GSM850	GPRS (4 Tx slots)	Front	1	128	824.2	28.72	29	1.067	0.02	0.616	0.657
32	GSM850	GPRS (4 Tx slots)	Back	1	128	824.2	28.72	29	1.067	-0.03	0.655	0.699
36	GSM850	GSM Voice	Back	1	128	824.2	32.39	33	1.151	0.05	0.391	0.450
39	GSM1900	GPRS (4 Tx slots)	Front	1	512	1850.2	25.5	26	1.122	0.09	0.422	0.473
40	GSM1900	GPRS (4 Tx slots)	Back	1	512	1850.2	25.5	26	1.122	0.08	0.296	0.332
44	GSM1900	GSM Voice	Front	1	512	1850.2	29.21	29.5	1.069	-0.01	0.240	0.257

<WCDMA SAR>

Plot No.	Band	Mode	Test Position	Gap (cm)	Ch.	Freq. (MHz)	Average Power (dBm)	Tune-Up Limit (dBm)	Scaling Factor	Power Drift (dB)	Measured 1g SAR (W/kg)	Reported 1g SAR (W/kg)
47	WCDMA Band V	RMC 12.2K	Front	1	4182	836.4	22.26	22.5	1.057	0.0061	0.269	0.284
48	WCDMA Band V	RMC 12.2K	Back	1	4182	836.4	22.26	22.5	1.057	-0.0046	0.287	0.303
54	WCDMA Band II	RMC12.2K	Front	1	9262	1852.4	22.82	23	1.042	-0.07	0.457	0.476
55	WCDMA Band II	RMC12.2K	Back	1	9262	1852.4	22.82	23	1.042	0.06	0.326	0.340

<WLAN2.4GHz SAR>

Plot No.	Band	Mode	Test Position	Gap (cm)	Ch.	Freq. (MHz)	Average Power (dBm)	Tune-Up Limit (dBm)	Scaling Factor	Power Drift (dB)	Measured 1g SAR (W/kg)	Reported 1g SAR (W/kg)
61	WLAN 2.4GHz	802.11b	Front	1	11	2462	11.59	12	1.099	0.04	0.069	0.076
62	WLAN 2.4GHz	802.11b	Back	1	11	2462	11.59	12	1.099	-0.05	0.097	0.107

12.4 Highest SAR Plot

Test Laboratory: Sporton International Inc. SAR/HAC Testing Lab

Date: 2013.11.22

#32_GSM850_GPRS (4 Tx slots)_Back 1cm_Ch128

Communication System: GPRS/EDGE (4 Tx slots); Frequency: 824.2 MHz; Duty Cycle: 1:2.08
 Medium: MSL_850_131122 Medium parameters used: $f = 824.2 \text{ MHz}$; $\sigma = 0.972 \text{ mho/m}$; $\epsilon_r = 54.953$; $\rho = 1000 \text{ kg/m}^3$
 Ambient Temperature : 23.4 °C; Liquid Temperature : 22.5 °C

DASY5 Configuration:

- Probe: EX3DV4 - SN3857; ConvF(9.48, 9.48, 9.48); Calibrated: 2013.06.20
- Sensor-Surface: 2mm (Mechanical Surface Detection)
- Electronics: DAE4 Sn1210; Calibrated: 2013.06.19
- Phantom: SAM1; Type: SAM; Serial: TP-1479
- Measurement SW: DASY52, Version 52.8 (5); SEMCAD X Version 14.4.5 (3634)

Ch128/Area Scan (71x121x1): Measurement grid: dx=15mm, dy=15mm
 Maximum value of SAR (interpolated) = 0.756 mW/g

Ch128/Zoom Scan (5x5x7)/Cube 0: Measurement grid: dx=8mm, dy=8mm, dz=5mm
 Reference Value = 26.565 V/m; Power Drift = -0.03 dB
 Peak SAR (extrapolated) = 0.826 W/kg
SAR(1 g) = 0.655 mW/g; SAR(10 g) = 0.504 mW/g
 Maximum value of SAR (measured) = 0.750 mW/g

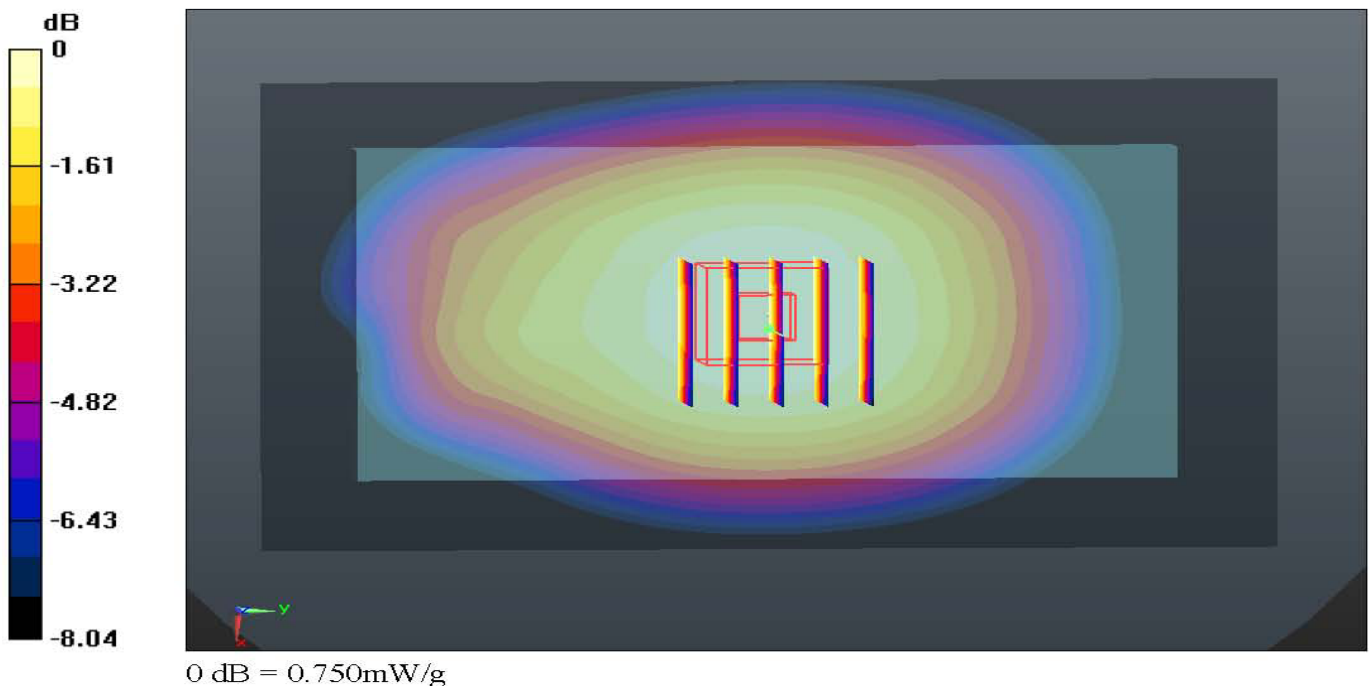

Test Laboratory: Sporton International Inc. SAR/HAC Testing Lab

Date: 2013.11.21

#43_GSM1900_GPRS (4 Tx slots)_Bottom Side 1cm_Ch512

Communication System: GPRS/EDGE (4 Tx slots); Frequency: 1850.2 MHz; Duty Cycle: 1:2.08
 Medium: MSL_1900_131121 Medium parameters used: $f = 1850.2 \text{ MHz}$; $\sigma = 1.495 \text{ mho/m}$; $\epsilon_r = 53.647$; $\rho = 1000 \text{ kg/m}^3$
 Ambient Temperature : 23.4 °C; Liquid Temperature : 22.9 °C

DASY5 Configuration:

- Probe: EX3DV4 - SN3857; ConvF(7.52, 7.52, 7.52); Calibrated: 2013.06.20
- Sensor-Surface: 2mm (Mechanical Surface Detection)
- Electronics: DAE4 Sn1210; Calibrated: 2013.06.19
- Phantom: SAM2; Type: SAM; Serial: TP-1477
- Measurement SW: DASY52, Version 52.8 (5); SEMCAD X Version 14.4.5 (3634)

Ch512/Area Scan (31x71x1): Measurement grid: dx=15mm, dy=15mm
 Maximum value of SAR (interpolated) = 0.679 mW/g

Ch512/Zoom Scan (5x5x7)/Cube 0: Measurement grid: dx=8mm, dy=8mm, dz=5mm
 Reference Value = 18.300 V/m; Power Drift = -0.02 dB
 Peak SAR (extrapolated) = 0.791 W/kg
SAR(1 g) = 0.446 mW/g; SAR(10 g) = 0.225 mW/g
 Maximum value of SAR (measured) = 0.640 mW/g

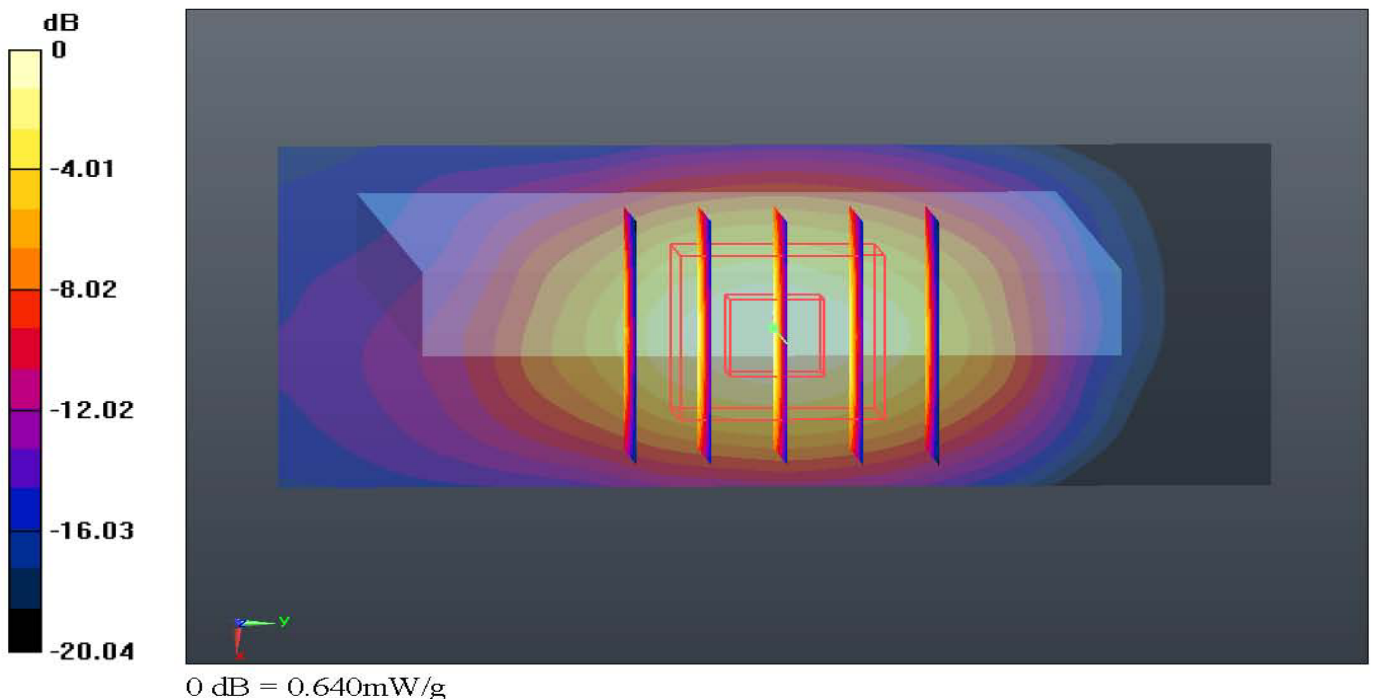

Test Laboratory: Sporton International Inc. SAR/HAC Testing Lab

Date: 2013.11.22

#48_WCDMA Band V_RMC12.2K_Back 1cm_Ch4182

Communication System: UMTS; Frequency: 836.4 MHz; Duty Cycle: 1:1
 Medium: MSL_850_131122 Medium parameters used: $f = 836.4$ MHz; $\sigma = 0.984$ mho/m; $\epsilon_r = 54.837$; $\rho = 1000$ kg/m³
 Ambient Temperature : 23.4 °C; Liquid Temperature : 22.5 °C

DASY5 Configuration:

- Probe: EX3DV4 - SN3857; ConvF(9.48, 9.48, 9.48); Calibrated: 2013.06.20
- Sensor-Surface: 2mm (Mechanical Surface Detection)
- Electronics: DAE4 Sn1210; Calibrated: 2013.06.19
- Phantom: SAM1; Type: SAM; Serial: TP-1479
- Measurement SW: DASY52, Version 52.8 (5); SEMCAD X Version 14.4.5 (3634)

Ch4182/Area Scan (71x121x1): Measurement grid: dx=15mm, dy=15mm
 Maximum value of SAR (interpolated) = 0.331 mW/g

Ch4182/Zoom Scan (5x5x7)/Cube 0: Measurement grid: dx=8mm, dy=8mm, dz=5mm
 Reference Value = 17.446 V/m; Power Drift = -0.0046 dB
 Peak SAR (extrapolated) = 0.362 W/kg
SAR(1 g) = 0.287 mW/g; SAR(10 g) = 0.221 mW/g
 Maximum value of SAR (measured) = 0.329 mW/g

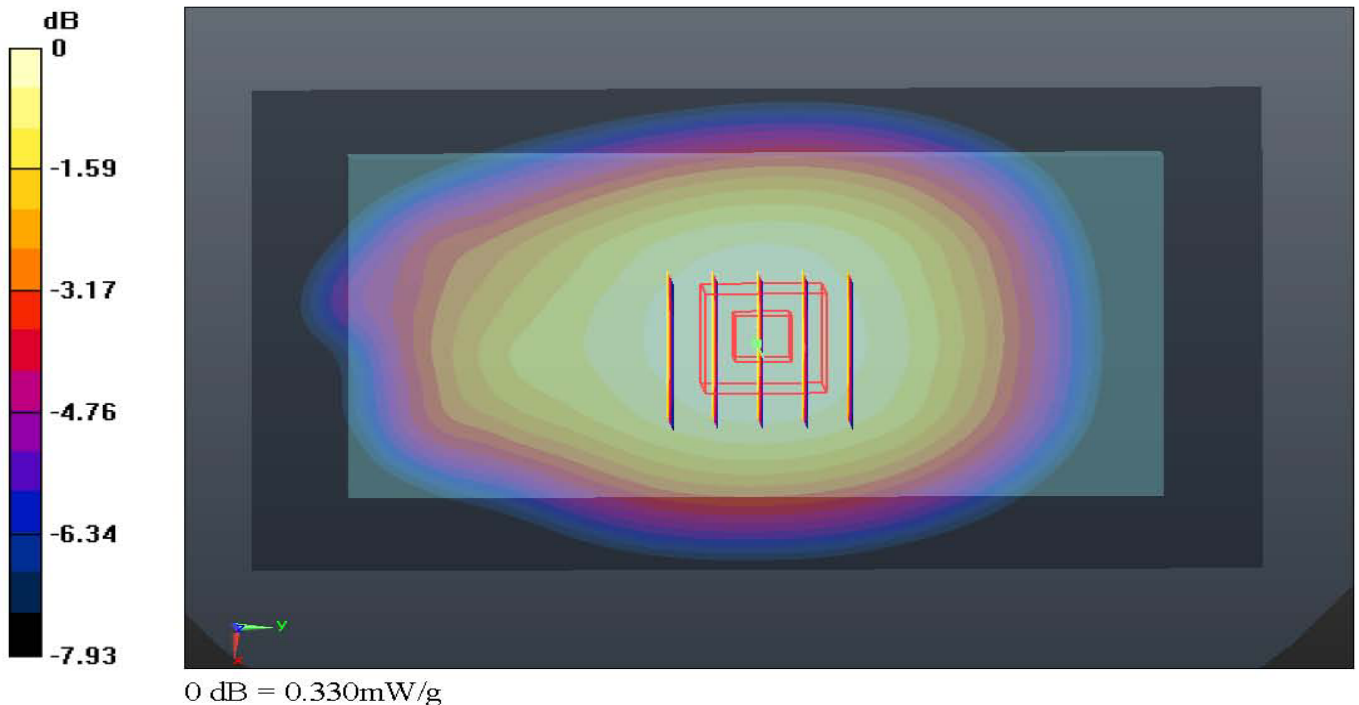

Test Laboratory: Sporton International Inc. SAR/HAC Testing Lab

Date: 2013.11.21

#58_WCDMA Band II_RMC12.2K_Bottom Side 1cm_Ch9262

Communication System: UMTS; Frequency: 1852.4 MHz; Duty Cycle: 1:1
 Medium: MSL_1900_131121 Medium parameters used: $f = 1852.4 \text{ MHz}$; $\sigma = 1.498 \text{ mho/m}$; $\epsilon_r = 53.64$; $\rho = 1000 \text{ kg/m}^3$
 Ambient Temperature : 23.4 °C; Liquid Temperature : 22.9 °C

DASY5 Configuration:

- Probe: EX3DV4 - SN3857; ConvF(7.52, 7.52, 7.52); Calibrated: 2013.06.20
- Sensor-Surface: 2mm (Mechanical Surface Detection)
- Electronics: DAE4 Sn1210; Calibrated: 2013.06.19
- Phantom: SAM2; Type: SAM; Serial: TP-1477
- Measurement SW: DASY52, Version 52.8 (5); SEMCAD X Version 14.4.5 (3634)

Ch9262/Area Scan (31x71x1): Measurement grid: dx=15mm, dy=15mm
 Maximum value of SAR (interpolated) = 0.825 mW/g

Ch9262/Zoom Scan (5x5x7)/Cube 0: Measurement grid: dx=8mm, dy=8mm, dz=5mm
 Reference Value = 19.649 V/m; Power Drift = -0.11 dB
 Peak SAR (extrapolated) = 0.927 W/kg
SAR(1 g) = 0.521 mW/g; SAR(10 g) = 0.263 mW/g
 Maximum value of SAR (measured) = 0.747 mW/g

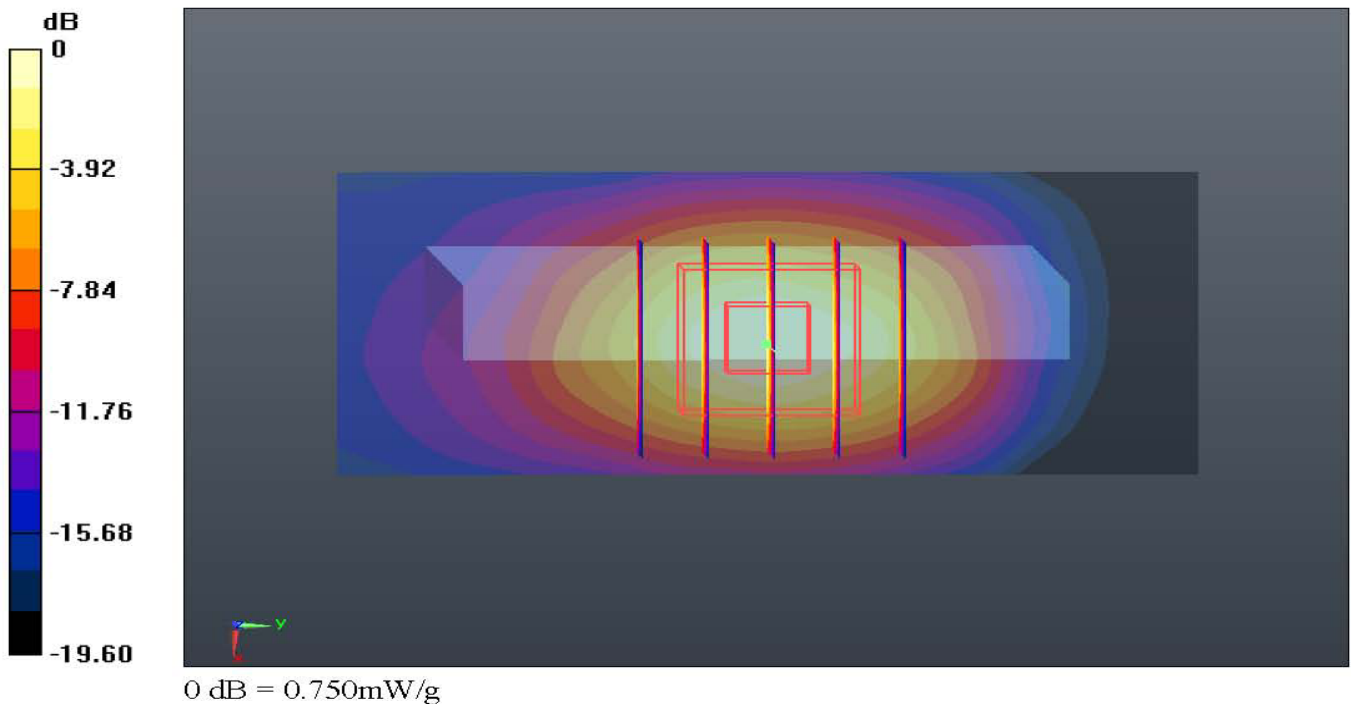

Test Laboratory: Sporton International Inc. SAR/HAC Testing Lab

Date: 2013.11.22

#27_WLAN 2.4GHz_802.11b_1M_Left Cheek_Ch11

Communication System: WIFI; Frequency: 2462 MHz; Duty Cycle: 1:1
Medium: HSL_2450_131122 Medium parameters used: $f = 2462$ MHz; $\sigma = 1.831$ mho/m; $\epsilon_r = 39.149$; $\rho = 1000$ kg/m³
Ambient Temperature : 23.2 °C; Liquid Temperature : 22.8 °C

DASY5 Configuration:

- Probe: EX3DV4 - SN3857; ConvF(7.05, 7.05, 7.05); Calibrated: 2013.06.20
- Sensor-Surface: 2mm (Mechanical Surface Detection)
- Electronics: DAE4 Sn1210; Calibrated: 2013.06.19
- Phantom: SAM1; Type: SAM; Serial: TP-1479
- Measurement SW: DASY52, Version 52.8 (5); SEMCAD X Version 14.4.5 (3634)

Ch11/Area Scan (91x151x1): Measurement grid: dx=12mm, dy=12mm
Maximum value of SAR (interpolated) = 0.467 mW/g

Ch11/Zoom Scan (7x7x7)/Cube 0: Measurement grid: dx=5mm, dy=5mm, dz=5mm
Reference Value = 6.533 V/m; Power Drift = 0.13 dB
Peak SAR (extrapolated) = 0.664 W/kg
SAR(1 g) = 0.290 mW/g; SAR(10 g) = 0.119 mW/g
Maximum value of SAR (measured) = 0.451 mW/g

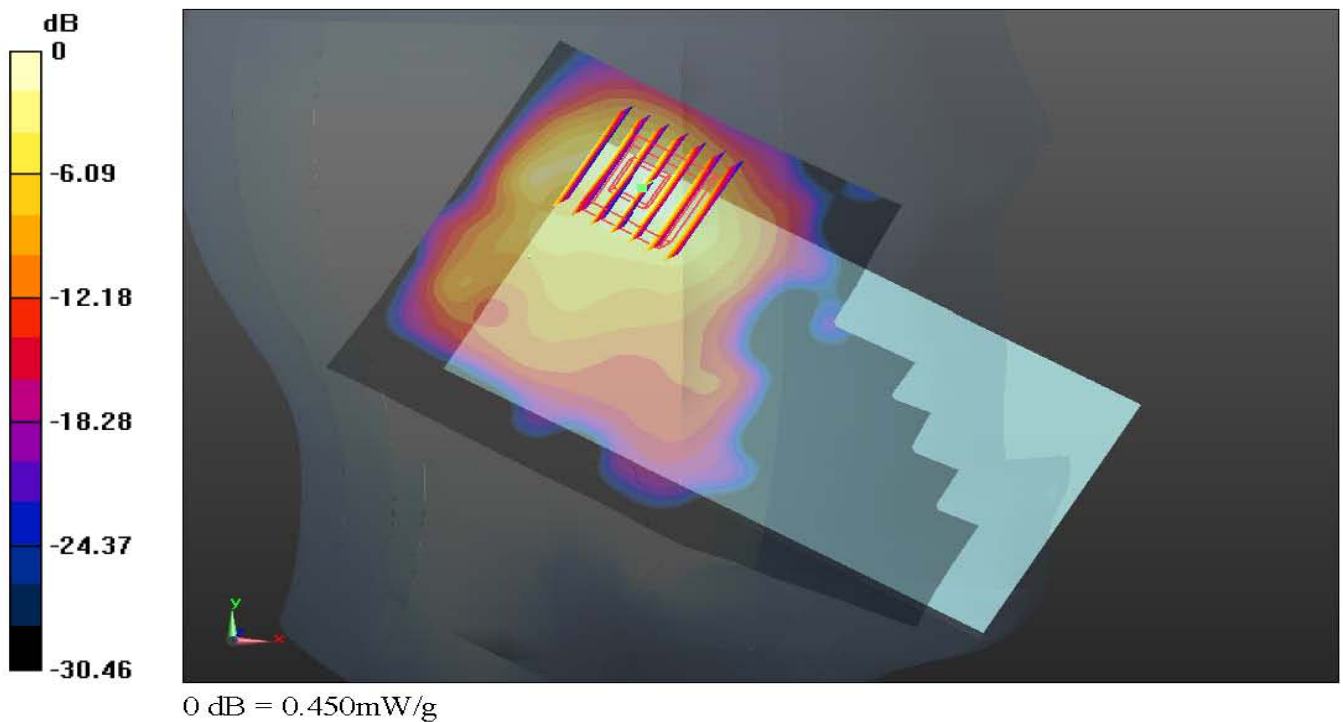



13. Simultaneous Transmission Analysis

NO.	Simultaneous Transmission Configurations	Phone			Note
		Head	Body-worn	Hotspot	
1.	GSM(Voice) + WLAN2.4GHz(data)	Yes	Yes		
2.	WCDMA(Voice) + WLAN2.4GHz(data)	Yes	Yes		
3.	GSM(Voice) + Bluetooth(data)	Yes	Yes		
4.	WCDMA((Voice) + Bluetooth(data)	Yes	Yes		
5.	GPRS/EDGE(Data) + WLAN2.4GHz(data)		Yes	Yes	2.4GHz Hotspot
6.	WCDMA(Data) + WLAN2.4GHz(data)	Yes	Yes	Yes	2.4GHz Hotspot
7.	GPRS/EDGE(Data) + Bluetooth(data)		Yes	Yes	Bluetooth Tethering
8.	WCDMA(Data) + Bluetooth(data)	Yes	Yes	Yes	Bluetooth Tethering

Note:

1. WLAN 2.4GHz and Bluetooth share the same antenna, and cannot transmit simultaneously.
2. EUT will choose either GSM or WCDMA according to the network signal condition; therefore, they will not transmit simultaneously.
3. The device does not have limitation to operate VOIP in GPRS/EDGE wireless interface; considering the data rate of GPRS/EDGE to support VOIP quality and realistic operation, SAR testing was not performed evaluation VOIP operation in GPRS/EDGE mode.
4. The reported SAR summation is calculated based on the same configuration and test position.
5. Per KDB 447498 D01v05r01, simultaneous transmission SAR is compliant if,
 - i) Scalar SAR summation < 1.6W/kg.
 - ii) $SPLSR = (SAR_1 + SAR_2)^{1.5} / (min. \text{ separation distance, mm})$, and the peak separation distance is determined from the square root of $[(x_1-x_2)^2 + (y_1-y_2)^2 + (z_1-z_2)^2]$, where (x_1, y_1, z_1) and (x_2, y_2, z_2) are the coordinates of the extrapolated peak SAR locations in the zoom scan
If $SPLSR \leq 0.04$, simultaneously transmission SAR measurement is not necessary
 - iii) Simultaneously transmission SAR measurement, and the reported multi-band SAR < 1.6W/kg
6. For simultaneous transmission analysis, Bluetooth SAR is estimated per KDB 447498 D01v05r01 based on the formula below.
 - i) $(max. \text{ power of channel, including tune-up tolerance, mW}) / (min. \text{ test separation distance, mm}) \cdot [\sqrt{f(\text{GHz})} / x] \text{ W/kg}$ for test separation distances $\leq 50 \text{ mm}$; where $x = 7.5$ for 1-g SAR, and $x = 18.75$ for 10-g SAR.
 - ii) When the minimum test separation distance is < 5mm, the distance is used 5mm to determine SAR test exclusion.
 - iii) 0.4 W/kg for 1-g SAR and 1.0 W/kg for 10-g SAR, when the test separation distances is > 50 mm.
If the test separation distance (antenna-user) is < 5mm, 5mm is used for excluded SAR calculation

Bluetooth				
Tune-up Maximum power (dBm)	Exposure Position	Head	Hotspot	Body-worn
	7.5	Test separation (mm)	0	10
Estimated SAR (W/kg)		0.236	0.118	0.118



13.1 Head Exposure Conditions

<WWAN-PCE + WLAN 2.4GHz-DTS>

Position	WWAN-PCE			WLAN 2.4GHz -DTS		Summed SAR (W/kg)	SPLSR ≤ 0.04	Case No
	WWAN Band	Plot No	Max. WWAN SAR (W/kg)	Plot No	Max. WLAN SAR (W/kg)			
Right Cheek	GSM850	1	0.265	25	0.192	0.46		
	GSM1900	7	0.136	25	0.192	0.33		
	WCDMA Band V	13	0.209	25	0.192	0.40		
	WCDMA Band II	19	0.262	25	0.192	0.45		
Right Tilted	GSM850	2	0.158	26	0.184	0.34		
	GSM1900	8	0.047	26	0.184	0.23		
	WCDMA Band V	14	0.106	26	0.184	0.29		
	WCDMA Band II	20	0.087	26	0.184	0.27		
Left Cheek	GSM850	3	0.293	27	0.319	0.61		
	GSM1900	9	0.066	27	0.319	0.39		
	WCDMA Band V	15	0.237	27	0.319	0.56		
	WCDMA Band II	21	0.127	27	0.319	0.45		
Left Tilted	GSM850	4	0.155	28	0.197	0.35		
	GSM1900	10	0.048	28	0.197	0.25		
	WCDMA Band V	16	0.116	28	0.197	0.31		
	WCDMA Band II	22	0.091	28	0.197	0.29		

<WWAN-PCE + Bluetooth-DSS>

Position	WWAN-PCE			Bluetooth-DSS	Summed SAR (W/kg)	SPLSR ≤ 0.04	Case No
	WWAN Band	Plot No	Max. WWAN SAR (W/kg)	Estimated SAR (W/kg)			
Right Cheek	GSM850	1	0.265	0.236	0.50		
	GSM1900	7	0.136	0.236	0.37		
	WCDMA Band V	13	0.209	0.236	0.45		
	WCDMA Band II	19	0.262	0.236	0.50		
Right Tilted	GSM850	2	0.158	0.236	0.39		
	GSM1900	8	0.047	0.236	0.28		
	WCDMA Band V	14	0.106	0.236	0.34		
	WCDMA Band II	20	0.087	0.236	0.32		
Left Cheek	GSM850	3	0.293	0.236	0.53		
	GSM1900	9	0.066	0.236	0.30		
	WCDMA Band V	15	0.237	0.236	0.47		
	WCDMA Band II	21	0.127	0.236	0.36		
Left Tilted	GSM850	4	0.155	0.236	0.39		
	GSM1900	10	0.048	0.236	0.28		
	WCDMA Band V	16	0.116	0.236	0.35		
	WCDMA Band II	22	0.091	0.236	0.33		



13.2 Hotspot Exposure Conditions

<WWAN-PCE + WLAN 2.4GHz-DTS>

Position	WWAN-PCE			WLAN 2.4GHz -DTS		Summed SAR (W/kg)	SPLSR ≤ 0.04	Case No
	WWAN Band	Plot No	Max. WWAN SAR (W/kg)	Plot No	Max. WLAN SAR (W/kg)			
Front	GSM850	31	0.657	61	0.076	0.73		
	GSM1900	39	0.473	61	0.076	0.55		
	WCDMA Band V	47	0.284	61	0.076	0.36		
	WCDMA Band II	54	0.476	61	0.076	0.55		
Back	GSM850	32	0.699	62	0.107	0.81		
	GSM1900	40	0.332	62	0.107	0.44		
	WCDMA Band V	48	0.303	62	0.107	0.41		
	WCDMA Band II	55	0.340	62	0.107	0.45		
Right Side	GSM850	34	0.556	63	0.045	0.60		
	GSM1900	42	0.246	63	0.045	0.29		
	WCDMA Band V	50	0.207	63	0.045	0.25		
	WCDMA Band II	57	0.269	63	0.045	0.31		
Top Side	GSM850			64	0.025	0.03		
	GSM1900			64	0.025	0.03		
	WCDMA Band V			64	0.025	0.03		
	WCDMA Band II			64	0.025	0.03		
Bottom Side	GSM850	35	0.086			0.09		
	GSM1900	43	0.500			0.50		
	WCDMA Band V	51	0.045			0.05		
	WCDMA Band II	58	0.543			0.54		



<WWAN-PCE + Bluetooth-DSS>

Position	WWAN-PCE			Bluetooth-DSS	Summed SAR (W/kg)	SPLSR ≤ 0.04	Case No
	WWAN Band	Plot No	Max. WWAN SAR (W/kg)	Estimated SAR (W/kg)			
Front	GSM850	31	0.657	0.118	0.78		
	GSM1900	39	0.473	0.118	0.59		
	WCDMA Band V	47	0.284	0.118	0.40		
	WCDMA Band II	54	0.476	0.118	0.59		
Back	GSM850	32	0.699	0.118	0.82		
	GSM1900	40	0.332	0.118	0.45		
	WCDMA Band V	48	0.303	0.118	0.42		
	WCDMA Band II	55	0.340	0.118	0.46		
Right Side	GSM850	34	0.556	0.118	0.67		
	GSM1900	42	0.246	0.118	0.36		
	WCDMA Band V	50	0.207	0.118	0.33		
	WCDMA Band II	57	0.269	0.118	0.39		
Top Side	GSM850			0.118	0.12		
	GSM1900			0.118	0.12		
	WCDMA Band V			0.118	0.12		
	WCDMA Band II			0.118	0.12		
Bottom Side	GSM850	35	0.086		0.09		
	GSM1900	43	0.500		0.50		
	WCDMA Band V	51	0.045		0.05		
	WCDMA Band II	58	0.543		0.54		



13.3 Body-Worn Exposure Conditions

<WWAN-PCE + WLAN 2.4GHz-DTS>

Position	WWAN-PCE			WLAN 2.4GHz -DTS		Summed SAR (W/kg)	SPLSR ≤ 0.04	Case No
	WWAN Band	Plot No	Max. WWAN SAR (W/kg)	Plot No	Max. WLAN SAR (W/kg)			
Front	GSM850	31	0.657	61	0.076	0.73		
	GSM1900	39	0.473	61	0.076	0.55		
	WCDMA Band V	47	0.284	61	0.076	0.36		
	WCDMA Band II	54	0.476	61	0.076	0.55		
Back	GSM850	32	0.699	62	0.107	0.81		
	GSM1900	40	0.332	62	0.107	0.44		
	WCDMA Band V	48	0.303	62	0.107	0.41		
	WCDMA Band II	55	0.340	62	0.107	0.45		

<WWAN-PCE + Bluetooth-DSS>

Position	WWAN-PCE			Bluetooth-DSS	Summed SAR (W/kg)	SPLSR ≤ 0.04	Case No
	WWAN Band	Plot No	Max. WWAN SAR (W/kg)	Estimated SAR (W/kg)			
Front	GSM850	31	0.657	0.118	0.78		
	GSM1900	39	0.473	0.118	0.59		
	WCDMA Band V	47	0.284	0.118	0.40		
	WCDMA Band II	54	0.476	0.118	0.59		
Back	GSM850	32	0.699	0.118	0.82		
	GSM1900	40	0.332	0.118	0.45		
	WCDMA Band V	48	0.303	0.118	0.42		
	WCDMA Band II	55	0.340	0.118	0.46		

Test Engineer : Fulu Hu

14. Uncertainty Assessment

The component of uncertainty may generally be categorized according to the methods used to evaluate them. The evaluation of uncertainty by the statistical analysis of a series of observations is termed a Type A evaluation of uncertainty. The evaluation of uncertainty by means other than the statistical analysis of a series of observations is termed a Type B evaluation of uncertainty. Each component of uncertainty, however evaluated, is represented by an estimated standard deviation, termed standard uncertainty, which is determined by the positive square root of the estimated variance.

A Type A evaluation of standard uncertainty may be based on any valid statistical method for treating data. This includes calculating the standard deviation of the mean of a series of independent observations; using the method of least squares to fit a curve to the data in order to estimate the parameter of the curve and their standard deviations; or carrying out an analysis of variance in order to identify and quantify random effects in certain kinds of measurement.

A type B evaluation of standard uncertainty is typically based on scientific judgment using all of the relevant information available. These may include previous measurement data, experience, and knowledge of the behavior and properties of relevant materials and instruments, manufacture’s specification, data provided in calibration reports and uncertainties assigned to reference data taken from handbooks. Broadly speaking, the uncertainty is either obtained from an outdoor source or obtained from an assumed distribution, such as the normal distribution, rectangular or triangular distributions indicated in Table 14.1

Uncertainty Distributions	Normal	Rectangular	Triangular	U-Shape
Multi-plying Factor ^(a)	1/k ^(b)	1/√3	1/√6	1/√2

(a) standard uncertainty is determined as the product of the multiplying factor and the estimated range of variations in the measured quantity

(b) κ is the coverage factor

Table 14.1. Standard Uncertainty for Assumed Distribution

The combined standard uncertainty of the measurement result represents the estimated standard deviation of the result. It is obtained by combining the individual standard uncertainties of both Type A and Type B evaluation using the usual “root-sum-squares” (RSS) methods of combining standard deviations by taking the positive square root of the estimated variances.

Expanded uncertainty is a measure of uncertainty that defines an interval about the measurement result within which the measured value is confidently believed to lie. It is obtained by multiplying the combined standard uncertainty by a coverage factor. Typically, the coverage factor ranges from 2 to 3. Using a coverage factor allows the true value of a measured quantity to be specified with a defined probability within the specified uncertainty range. For purpose of this document, a coverage factor two is used, which corresponds to confidence interval of about 95 %. The DASY uncertainty Budget is shown in the following tables.



Error Description	Uncertainty Value (±%)	Probability Distribution	Divisor	Ci (1g)	Ci (10g)	Standard Uncertainty (1g)	Standard Uncertainty (10g)
Measurement System							
Probe Calibration	6.0	Normal	1	1	1	± 6.0 %	± 6.0 %
Axial Isotropy	4.7	Rectangular	√3	0.7	0.7	± 1.9 %	± 1.9 %
Hemispherical Isotropy	9.6	Rectangular	√3	0.7	0.7	± 3.9 %	± 3.9 %
Boundary Effects	1.0	Rectangular	√3	1	1	± 0.6 %	± 0.6 %
Linearity	4.7	Rectangular	√3	1	1	± 2.7 %	± 2.7 %
System Detection Limits	1.0	Rectangular	√3	1	1	± 0.6 %	± 0.6 %
Readout Electronics	0.3	Normal	1	1	1	± 0.3 %	± 0.3 %
Response Time	0.8	Rectangular	√3	1	1	± 0.5 %	± 0.5 %
Integration Time	2.6	Rectangular	√3	1	1	± 1.5 %	± 1.5 %
RF Ambient Noise	3.0	Rectangular	√3	1	1	± 1.7 %	± 1.7 %
RF Ambient Reflections	3.0	Rectangular	√3	1	1	± 1.7 %	± 1.7 %
Probe Positioner	0.4	Rectangular	√3	1	1	± 0.2 %	± 0.2 %
Probe Positioning	2.9	Rectangular	√3	1	1	± 1.7 %	± 1.7 %
Max. SAR Eval.	1.0	Rectangular	√3	1	1	± 0.6 %	± 0.6 %
Test Sample Related							
Device Positioning	2.9	Normal	1	1	1	± 2.9 %	± 2.9 %
Device Holder	3.6	Normal	1	1	1	± 3.6 %	± 3.6 %
Power Drift	5.0	Rectangular	√3	1	1	± 2.9 %	± 2.9 %
Phantom and Setup							
Phantom Uncertainty	4.0	Rectangular	√3	1	1	± 2.3 %	± 2.3 %
Liquid Conductivity (Target)	5.0	Rectangular	√3	0.64	0.43	± 1.8 %	± 1.2 %
Liquid Conductivity (Meas.)	2.5	Normal	1	0.64	0.43	± 1.6 %	± 1.1 %
Liquid Permittivity (Target)	5.0	Rectangular	√3	0.6	0.49	± 1.7 %	± 1.4 %
Liquid Permittivity (Meas.)	2.5	Normal	1	0.6	0.49	± 1.5 %	± 1.2 %
Combined Standard Uncertainty						± 11.0 %	± 10.8 %
Coverage Factor for 95 %						K=2	
Expanded Uncertainty						± 22.0 %	± 21.5 %

Table 14.2. Uncertainty Budget for frequency range 300 MHz to 3 GHz



15. References

- [1] FCC 47 CFR Part 2 "Frequency Allocations and Radio Treaty Matters; General Rules and Regulations"
- [2] ANSI/IEEE Std. C95.1-1992, "IEEE Standard for Safety Levels with Respect to Human Exposure to Radio Frequency Electromagnetic Fields, 3 kHz to 300 GHz", September 1992
- [3] IEEE Std. 1528-2003, "Recommended Practice for Determining the Peak Spatial-Average Specific Absorption Rate (SAR) in the Human Head from Wireless Communications Devices: Measurement Techniques", December 2003
- [4] SPEAG DASY System Handbook
- [5] FCC KDB 248227 D01 v01r02, "SAR Measurement Procedures for 802.11 a/b/g Transmitters", May 2007
- [6] FCC KDB 447498 D01 v05r01, "Mobile and Portable Device RF Exposure Procedures and Equipment Authorization Policies", May 2013
- [7] FCC KDB 648474 D04 v01r01, "SAR Evaluation Considerations for Wireless Handsets", May 2013
- [8] FCC KDB 941225 D03 v01, "Recommended SAR Test Reduction Procedures for GSM / GPRS / EDGE", December 2008
- [9] FCC KDB 941225 D01 v02, "SAR Measurement Procedures for 3G Devices – CDMA 2000 / Ev-Do / WCDMA / HSDPA / HSPA", October 2007
- [10] FCC KDB 941225 D06 v01r01, "SAR Evaluation Procedures for Portable Devices with Wireless Router Capabilities", May 2013
- [11] FCC KDB 865664 D01 v01r01, "SAR Measurement Requirements for 100 MHz to 6 GHz", May 2013.
- [12] FCC KDB 865664 D02 v01r01, "RF Exposure Compliance Reporting and Documentation Considerations", May 2013