

# FCC RF Test Report

**APPLICANT** : Acer Incorporated  
**EQUIPMENT** : Smart HandHeld  
**BRAND NAME** : Acer  
**MODEL NAME** : Z150  
**MARKETING NAME** : Liquid Z5  
**FCC ID** : HLZDMZ150  
**STANDARD** : FCC Part 15 Subpart C §15.247  
**CLASSIFICATION** : (DSS) Spread Spectrum Transmitter

The product was received on Nov. 14, 2013 and testing was completed on Nov. 25, 2013. We, SPORTON INTERNATIONAL (KUNSHAN) INC., would like to declare that the tested sample has been evaluated in accordance with the procedures and shown to be compliant with the applicable technical standards.

The test results in this report apply exclusively to the tested model / sample. Without written approval of SPORTON INTERNATIONAL (KUNSHAN) INC., the test report shall not be reproduced except in full.



Reviewed by: Joseph Lin / Supervisor

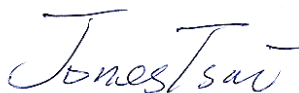

Approved by: Jones Tsai / Manager



**SPORTON INTERNATIONAL (KUNSHAN) INC.**  
**No. 3-2, PingXiang Road, Kunshan, Jiangsu Province, P.R.C.**



# TABLE OF CONTENTS

REVISION HISTORY..... 3

SUMMARY OF TEST RESULT ..... 4

**1 GENERAL DESCRIPTION..... 5**

    1.1 Applicant..... 5

    1.2 Manufacturer..... 5

    1.3 Feature of Equipment Under Test..... 5

    1.4 Product Specification of Equipment Under Test..... 5

    1.5 Modification of EUT ..... 6

    1.6 Testing Site..... 6

    1.7 Applied Standards ..... 6

**2 TEST CONFIGURATION OF EQUIPMENT UNDER TEST..... 7**

    2.1 Descriptions of Test Mode..... 7

    2.2 Test Mode..... 8

    2.3 Connection Diagram of Test System..... 9

    2.4 Support Unit used in test configuration and system..... 10

    2.5 EUT Operation Test Setup ..... 10

    2.6 Measurement Results Explanation Example..... 11

**3 TEST RESULT ..... 12**

    3.1 Number of Channel Measurement ..... 12

    3.2 Hopping Channel Separation Measurement ..... 14

    3.3 Dwell Time Measurement..... 21

    3.4 20dB Bandwidth Measurement ..... 23

    3.5 Peak Output Power Measurement ..... 30

    3.6 Conducted Band Edges Measurement ..... 32

    3.7 Conducted Spurious Emission Measurement ..... 39

    3.8 Radiated Band Edges and Spurious Emission Measurement ..... 49

    3.9 AC Conducted Emission Measurement..... 60

    3.10 Antenna Requirements..... 64

**4 LIST OF MEASURING EQUIPMENT..... 65**

**5 UNCERTAINTY OF EVALUATION..... 66**

**APPENDIX A. SETUP PHOTOGRAPHS**



### REVISION HISTORY

REPORT NO.	VERSION	DESCRIPTION	ISSUED DATE
FR3N1490A	Rev. 01	Initial issue of report	Dec. 12, 2013

## SUMMARY OF TEST RESULT

Report Section	FCC Rule	Description	Limit	Result	Remark
3.1	15.247(a)(1)	Number of Channels	≥ 15Chs	Pass	-
3.2	15.247(a)(1)	Hopping Channel Separation	≥ 2/3 of 20dB BW	Pass	-
3.3	15.247(a)(1)	Dwell Time of Each Channel	≤ 0.4sec in 31.6sec period	Pass	-
3.4	15.247(a)(1)	20dB Bandwidth	NA	Pass	-
3.5	15.247(b)(1)	Peak Output Power	≤ 125 mW	Pass	-
3.6	15.247(d)	Conducted Band Edges	≤ 20dBc	Pass	-
3.7	15.247(d)	Conducted Spurious Emission	≤ 20dBc	Pass	-
3.8	15.247(d)	Radiated Band Edges and Radiated Spurious Emission	15.209(a) & 15.247(d)	Pass	Under limit 9.94 dB at 2483.500 MHz
3.9	15.207	AC Conducted Emission	15.207(a)	Pass	Under limit 23.94 dB at 0.350 MHz
3.10	15.203 & 15.247(b)	Antenna Requirement	N/A	Pass	-

# 1 General Description

## 1.1 Applicant

**Acer Incorporated**

8F., No. 88, Sec. 1, Xintai 5th Rd., Xizhi Dist., New Taipei City 22181, Taiwan (R.O.C)

## 1.2 Manufacturer

**Shanghai Sunrise Simcom Limited**

No. 888, Shengli Rd., Qingpu, Shanghai, P.R.China 201700

## 1.3 Feature of Equipment Under Test

Product Feature	
<b>Equipment</b>	Smart HandHeld
<b>Brand Name</b>	Acer
<b>Model Name</b>	Z150
<b>Marketing Name</b>	Liquid Z5
<b>FCC ID</b>	HLZDMZ150
<b>EUT supports Radios application</b>	GSM/GPRS/EGPRS/WCDMA/HSPA /HSPA+ (Downlink Only) WLAN2.4GHz 802.11b/g/n HT20/HT40/ Bluetooth v3.0 + EDR/Bluetooth v 4.0
<b>EUT Stage</b>	Identical Prototype

**Remark:** The above EUT's information was declared by manufacturer. Please refer to the specifications or user's manual for more detailed description.

## 1.4 Product Specification of Equipment Under Test

Product Specification subjective to this standard	
<b>Tx/Rx Frequency Range</b>	2402 MHz ~ 2480 MHz
<b>Number of Channels</b>	79
<b>Carrier Frequency of Each Channel</b>	2402+n*1 MHz; n=0~78
<b>Maximum Output Power to Antenna</b>	Bluetooth BR(1Mbps) : 7.50 dBm (0.0056 W) Bluetooth EDR (2Mbps) : 7.34 dBm (0.0054 W) Bluetooth EDR (3Mbps) : 7.51 dBm (0.0056 W)
<b>Antenna Type</b>	PIFA Antenna with gain -0.58 dBi
<b>Type of Modulation</b>	Bluetooth BR (1Mbps) : GFSK Bluetooth EDR (2Mbps) : $\pi/4$ -DQPSK Bluetooth EDR (3Mbps) : 8-DPSK

### 1.5 Modification of EUT

No modifications are made to the EUT during all test items.

### 1.6 Testing Site

<b>Test Site</b>	SPORTON INTERNATIONAL (KUNSHAN) INC.			
<b>Test Site Location</b>	No. 3-2, PingXiang Road, Kunshan, Jiangsu Province, P.R.C. TEL: +86-0512-5790-0158 FAX: +86-0512-5790-0958			
<b>Test Site No.</b>	<b>Sporton Site No.</b>			<b>FCC Registration No.</b>
	TH01-KS	CO01-KS	03CH01-KS	149928

**Note:** The test site complies with ANSI C63.4 2003 requirement.

### 1.7 Applied Standards

According to the specifications of the manufacturer, the EUT must comply with the requirements of the following standards:

- ♦ FCC Part 15 Subpart C §15.247
- ♦ FCC Public Notice DA 00-705
- ♦ ANSI C63.4-2003

**Remark:**

1. All test items were verified and recorded according to the standards and without any deviation during the test.
2. This EUT has also been tested and complied with the requirements of FCC Part 15, Subpart B, recorded in a separate test report.

## 2 Test Configuration of Equipment Under Test

### 2.1 Descriptions of Test Mode

Preliminary tests were performed in different data rates and recorded the RF output power in the following table:

Channel	Frequency	Bluetooth RF Output Power		
		Data Rate / Modulation		
		GFSK	$\pi/4$ -DQPSK	8-DPSK
		1Mbps	2Mbps	3Mbps
Ch00	2402MHz	6.79 dBm	6.39 dBm	6.84 dBm
Ch39	2441MHz	7.44 dBm	7.12 dBm	7.45 dBm
Ch78	2480MHz	7.50 dBm	7.34 dBm	<b>7.51 dBm</b>

**Remark:**

1. All the test data for each data rate were verified, but only the worst case was reported.
  2. The data rate was set in 3Mbps for all the test items due to the highest RF output power.
- a. The EUT has been associated with peripherals and configuration operated in a manner tended to maximize its emission characteristics in a typical application. Frequency range investigated: conduction (150 kHz to 30 MHz), radiation (9 kHz to the 10th harmonic of the highest fundamental frequency or to 40 GHz, whichever is lower). Pre-scanned tests, X, Y, Z in three orthogonal panels, and different data rates were conducted to determine the final configuration (Y plane as worst plane) from all possible combinations, and the worst mode of radiated spurious emissions is Bluetooth 3Mbps mode, and recorded in this report.
  - b. AC power line Conducted Emission was tested under maximum output power.

## 2.2 Test Mode

The following summary table is showing all test modes to demonstrate in compliance with the standard.

Summary table of Test Cases			
Test Item	Data Rate / Modulation		
	Bluetooth BR 1Mbps GFSK	Bluetooth EDR 2Mbps $\pi/4$ -DQPSK	Bluetooth EDR 3Mbps 8-DPSK
<b>Conducted Test Cases</b>	Mode 1: CH00_2402 MHz Mode 2: CH39_2441 MHz Mode 3: CH78_2480 MHz	Mode 4: CH00_2402 MHz Mode 5: CH39_2441 MHz Mode 6: CH78_2480 MHz	Mode 7: CH00_2402 MHz Mode 8: CH39_2441 MHz Mode 9: CH78_2480 MHz
<b>Radiated Test Cases</b>	<b>Bluetooth EDR 3Mbps 8-DPSK</b>		
	Mode 1: CH00_2402 MHz Mode 2: CH39_2441 MHz Mode 3: CH78_2480 MHz		
<b>AC Conducted Emission</b>	Mode 1 :GSM850 Idle + Bluetooth Link + WLAN Link + Earphone + USB Cable (Charging from Adapter)		
<p><b>Remark:</b> For radiated test cases, the worst mode data rate 3Mbps was reported only, because this data rate has the highest RF output power at preliminary tests, and no other significantly frequencies found in conducted spurious emission.</p>			



## 2.3 Connection Diagram of Test System

### <Bluetooth Tx Mode>

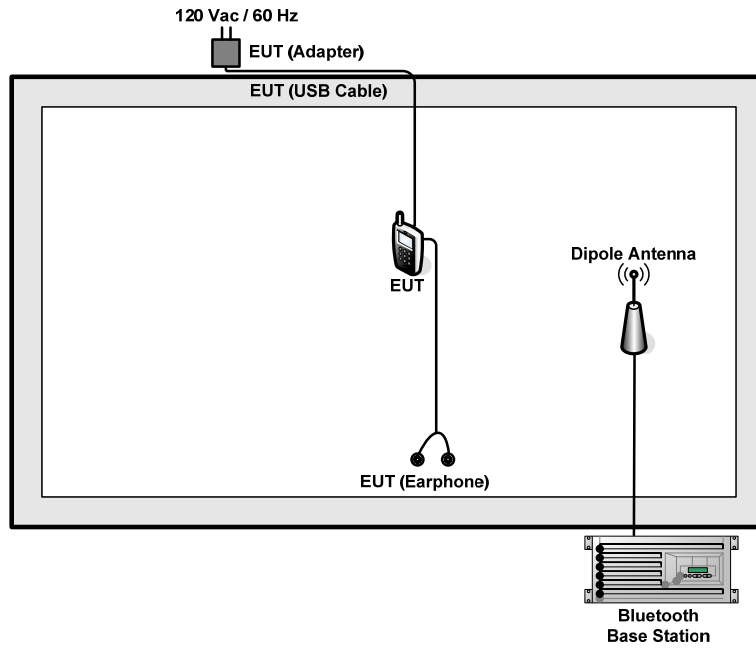

### <AC Conducted Emission Mode>

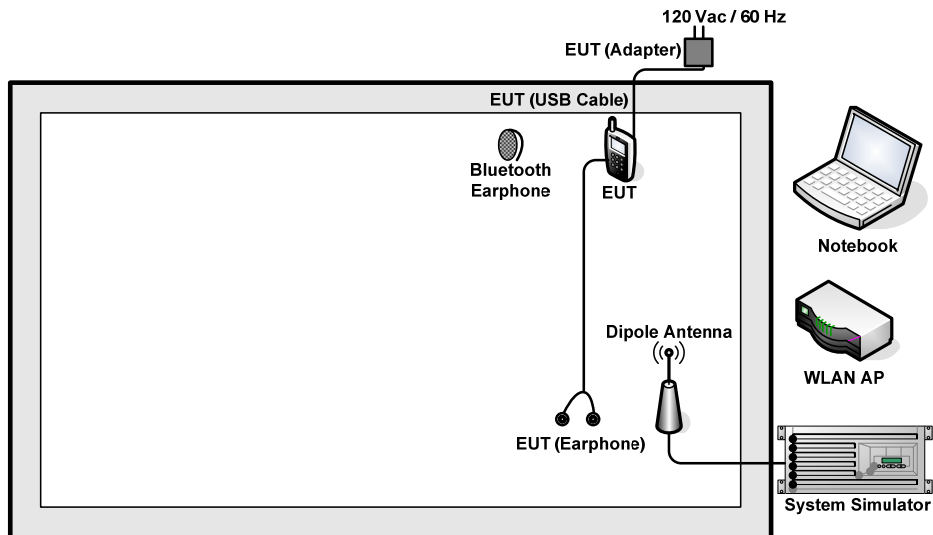

## 2.4 Support Unit used in test configuration and system

Item	Equipment	Trade Name	Model Name	FCC ID	Data Cable	Power Cord
1.	Bluetooth Base Station	R&S	CBT	FCC DoC	N/A	Unshielded, 1.8 m
2.	System Simulator	R&S	CMU 200	N/A	N/A	Unshielded, 1.8 m
3.	DC Power Supply	GWINSTEK	GPS-3030D	FCC DoC	N/A	Unshielded, 1.8 m
4.	WLAN AP	D-Link	DIR-855	KA2DIR855A2	N/A	Unshielded, 1.8 m
5.	Notebook	Lenovo	G480	FCC DoC	N/A	AC I/P: Unshielded, 0.9 m DC O/P: Shielded, 1.8 m
6.	Bluetooth Earphone	Lenovo	LBH301	FCC DoC	N/A	N/A

## 2.5 EUT Operation Test Setup

For Bluetooth function, the engineering test program was provided and enabled to make EUT connect with Bluetooth base station to continuous transmit/receive.

For AC power line conducted emissions, the EUT was set to connect with the WLAN AP under large package sizes transmission.



## 2.6 Measurement Results Explanation Example

For all conducted test items:

The offset level is set in the spectrum analyzer to compensate the RF cable loss and attenuator factor between EUT conducted output port and spectrum analyzer. With the offset compensation, the spectrum analyzer reading level is exactly the EUT RF output level.

Example:

The spectrum analyzer offset is derived from RF cable loss and attenuator factor.

*Offset = RF cable loss + attenuator factor.*

Following shows an offset computation example with cable loss 5.6 dB and 10dB attenuator.

$$\begin{aligned} \text{Offset(dB)} &= \text{RF cable loss(dB)} + \text{attenuator factor(dB)} \\ &= 5.6 + 10 = 15.6 \text{ (dB)} \end{aligned}$$

### 3 Test Result

#### 3.1 Number of Channel Measurement

##### 3.1.1 Limits of Number of Hopping Frequency

Frequency hopping systems in the 2400-2483.5 MHz band shall use at least 15 channels.

##### 3.1.2 Measuring Instruments

The measuring equipment is listed in the section 4 of this test report.

##### 3.1.3 Test Procedure

1. The testing follows FCC Public Notice DA 00-705 Measurement Guidelines.
2. The RF output of EUT was connected to the spectrum analyzer by RF cable and attenuator. The path loss was compensated to the results for each measurement.
3. Set to the maximum power setting and enable the EUT transmit continuously.
4. Enable the EUT hopping function.
5. Use the following spectrum analyzer settings: Span = the frequency band of operation; RBW  $\geq$  1% of the span; VBW  $\geq$  RBW; Sweep = auto; Detector function = peak; Trace = max hold.
6. The number of hopping frequency used is defined as the number of total channel.
7. Record the measurement data derived from spectrum analyzer.

##### 3.1.4 Test Setup

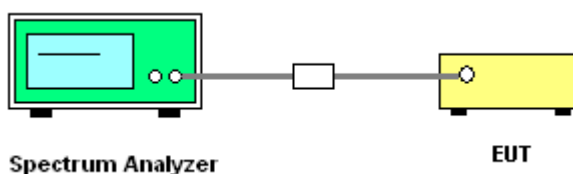

##### 3.1.5 Test Result of Number of Hopping Frequency

Test Mode :	3Mbps	Temperature :	23~24°C
Test Engineer :	Adonis Li	Relative Humidity :	47~48%
Number of Hopping (Channel)	Adaptive Frequency Hopping (Channel)	Limits (Channel)	Pass/Fail
79	20	> 15	Pass



Number of Hopping Channel Plot on Channel 00 - 78

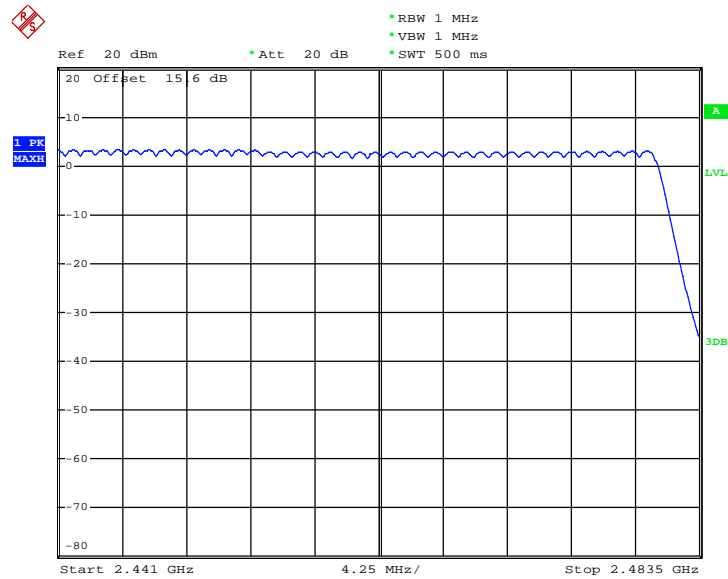
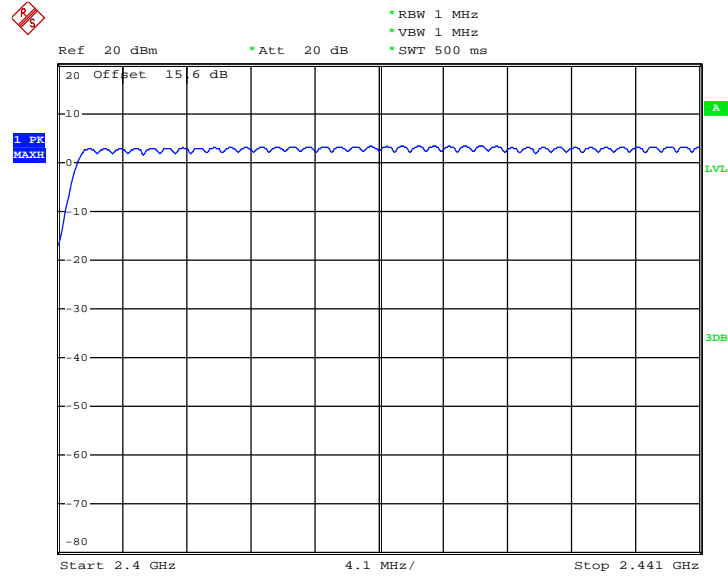

## 3.2 Hopping Channel Separation Measurement

### 3.2.1 Limit of Hopping Channel Separation

Frequency hopping systems operating in the 2400-2483.5 MHz band may have hopping channel carrier frequencies that are separated by 25 kHz or two-thirds of the 20 dB bandwidth of the hopping channel, whichever is greater.

### 3.2.2 Measuring Instruments

The measuring equipment is listed in the section 4 of this test report.

### 3.2.3 Test Procedures

1. The testing follows FCC Public Notice DA 00-705 Measurement Guidelines.
2. The RF output of EUT was connected to the spectrum analyzer by RF cable and attenuator. The path loss was compensated to the results for each measurement.
3. Set to the maximum power setting and enable the EUT transmit continuously.
4. Enable the EUT hopping function.
5. Use the following spectrum analyzer settings:  
Span = wide enough to capture the peaks of two adjacent channels;  $RBW \geq 1\%$  of the span;  
 $VBW \geq RBW$ ; Sweep = auto; Detector function = peak; Trace = max hold.
6. Measure and record the results in the test report.

### 3.2.4 Test Setup

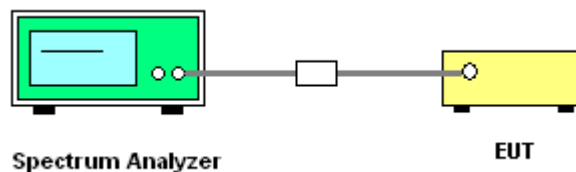



3.2.5 Test Result of Hopping Channel Separation

Test Mode :	1Mbps	Temperature :	23~24°C
Test Engineer :	Adonis Li	Relative Humidity :	47~48%

Channel	Frequency (MHz)	Frequency Separation (MHz)	(2/3 of 20dB BW) Limits (MHz)	Pass/Fail
00	2402	1.002	0.6507	Pass
39	2441	1.002	0.6400	Pass
78	2480	1.002	0.6427	Pass

Channel Separation Plot on Channel 00 - 01



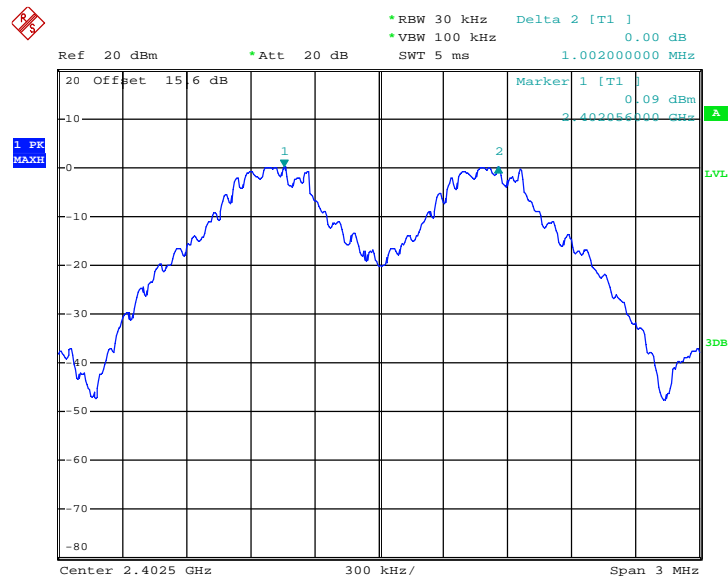

Channel Separation Plot on Channel 39 - 40

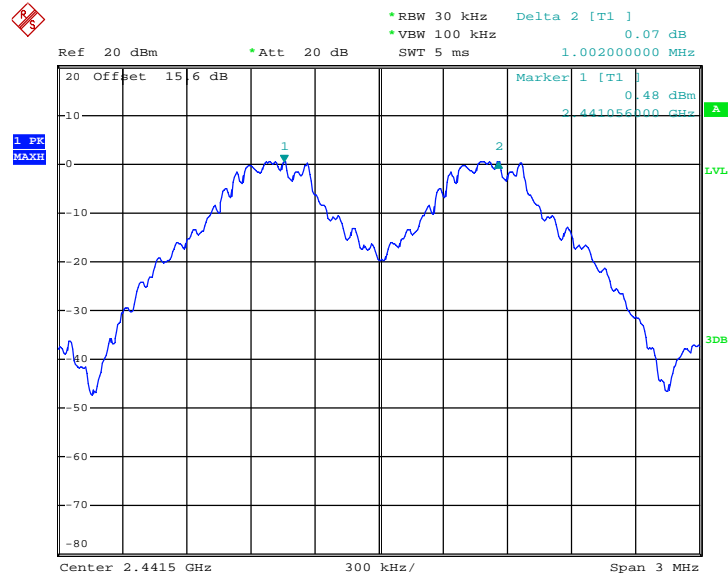

Channel Separation Plot on Channel 77 - 78

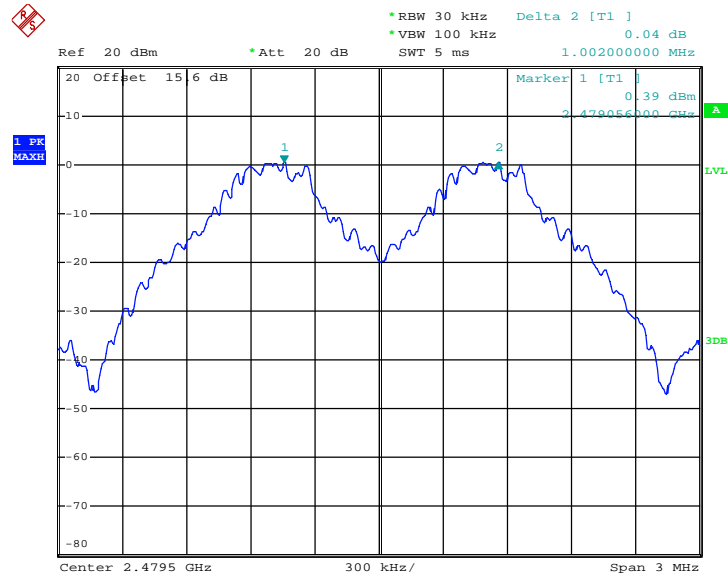





Test Mode :	2Mbps	Temperature :	23~24°C
Test Engineer :	Adonis Li	Relative Humidity :	47~48%

Channel	Frequency (MHz)	Frequency Separation (MHz)	(2/3 of 20dB BW) Limits (MHz)	Pass/Fail
00	2402	1.002	0.8360	Pass
39	2441	1.008	0.8440	Pass
78	2480	1.002	0.8440	Pass

Channel Separation Plot on Channel 00 - 01

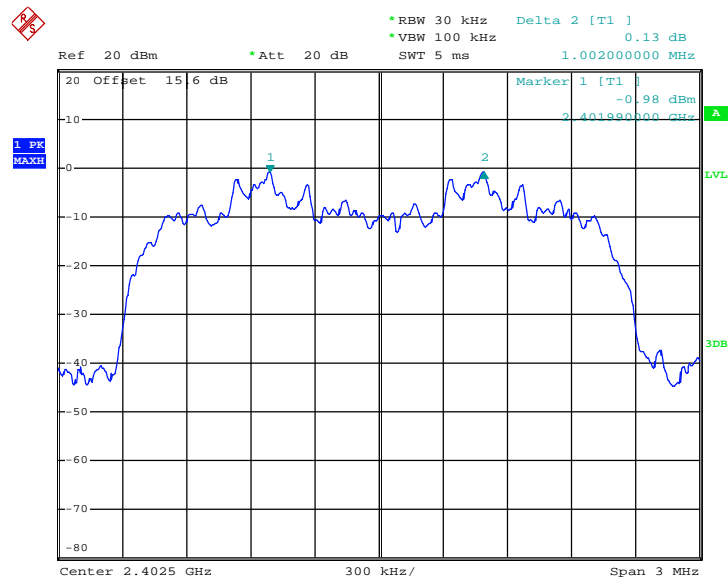



### Channel Separation Plot on Channel 39 - 40

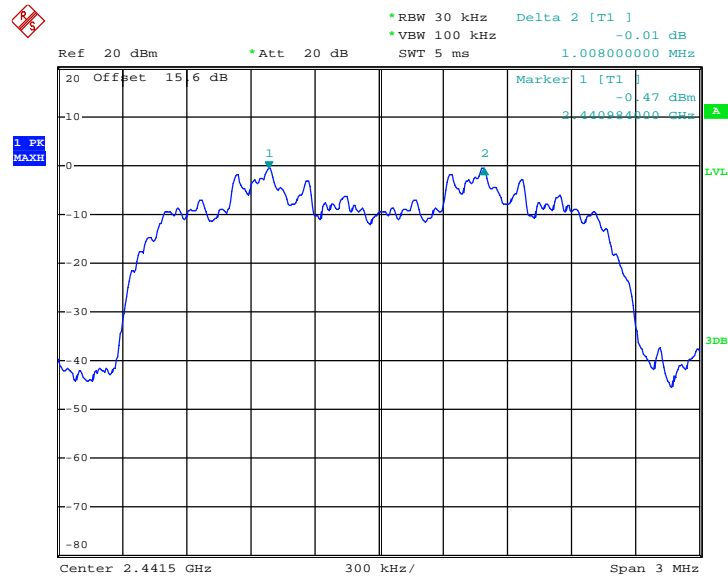

### Channel Separation Plot on Channel 77 - 78

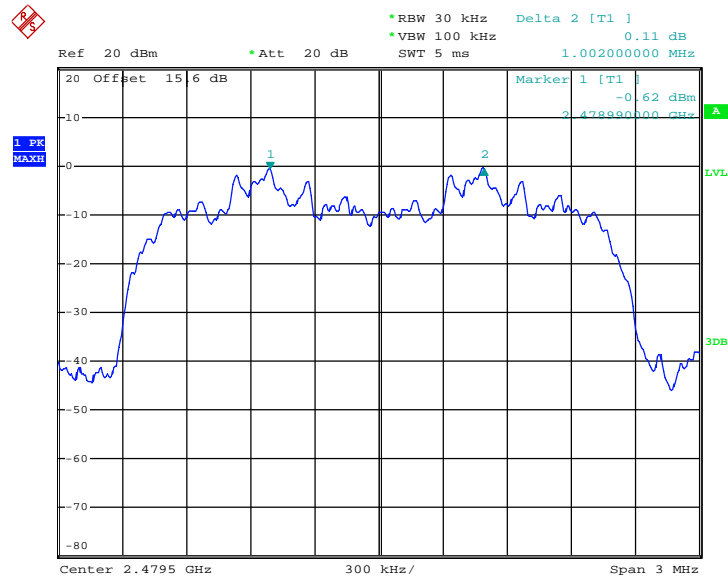



Test Mode :	3Mbps	Temperature :	23~24°C
Test Engineer :	Adonis Li	Relative Humidity :	47~48%

Channel	Frequency (MHz)	Frequency Separation (MHz)	(2/3 of 20dB BW) Limits (MHz)	Pass/Fail
00	2402	1.002	0.8240	Pass
39	2441	1.002	0.8360	Pass
78	2480	1.002	0.8360	Pass

Channel Separation Plot on Channel 00 - 01

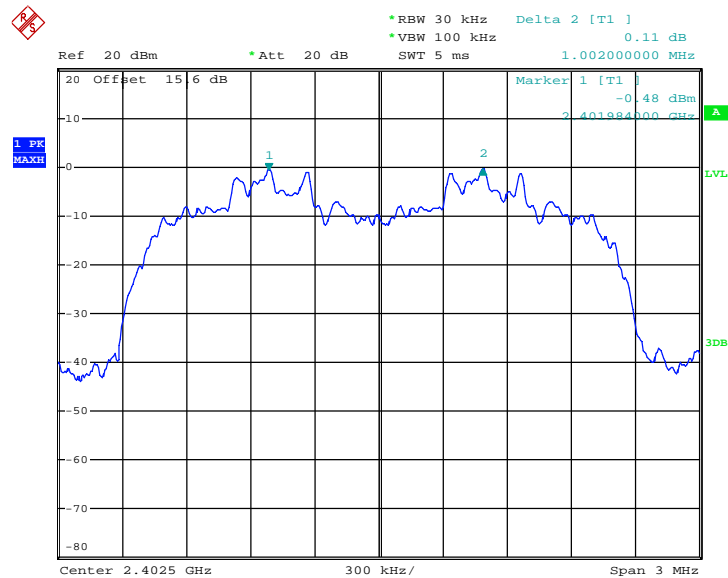



### Channel Separation Plot on Channel 39 - 40

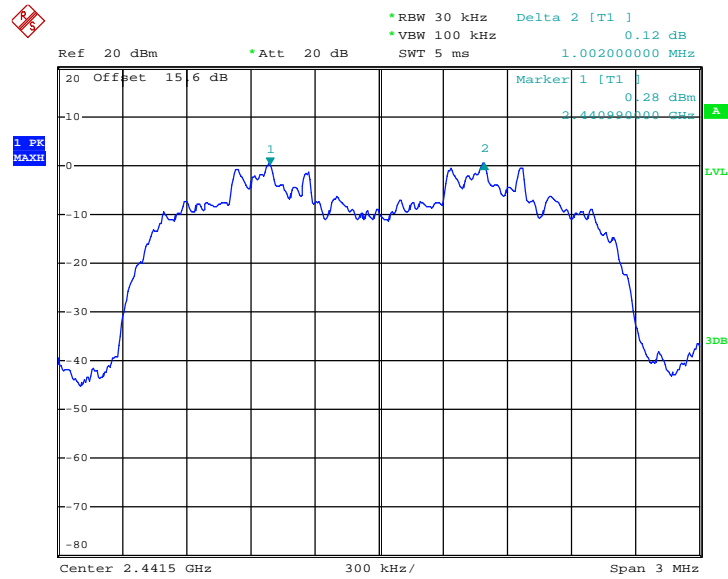

### Channel Separation Plot on Channel 77 - 78

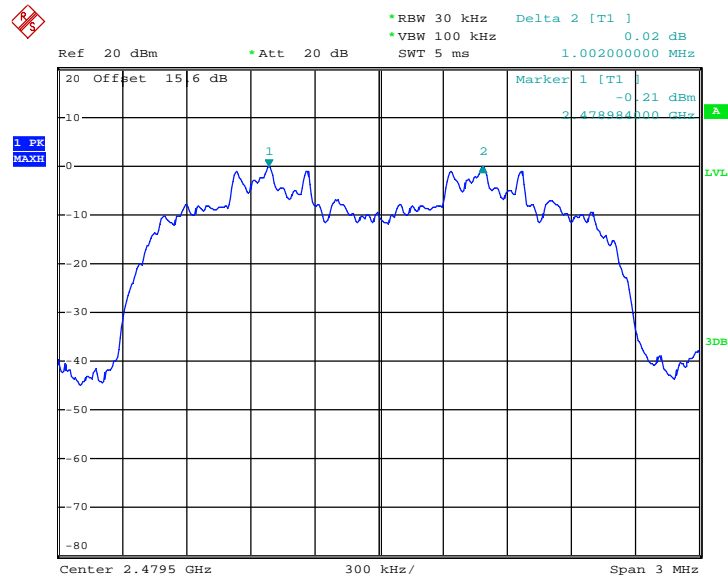

### 3.3 Dwell Time Measurement

#### 3.3.1 Limit of Dwell Time

The average time of occupancy on any channel shall not be greater than 0.4 seconds within a period of 0.4 seconds multiplied by the number of hopping channels employed.

#### 3.3.2 Measuring Instruments

The measuring equipment is listed in the section 4 of this test report.

#### 3.3.3 Test Procedures

1. The testing follows FCC Public Notice DA 00-705 Measurement Guidelines.
2. The RF output of EUT was connected to the spectrum analyzer by RF cable and attenuator. The path loss was compensated to the results for each measurement.
3. Set to the maximum power setting and enable the EUT transmit continuously.
4. Enable the EUT hopping function.
5. Use the following spectrum analyzer settings: Span = zero span, centered on a hopping channel; RBW = 1 MHz; VBW  $\geq$  RBW; Sweep = as necessary to capture the entire dwell time per hopping channel; Detector function = peak; Trace = max hold.
6. Measure and record the results in the test report.

#### 3.3.4 Test Setup

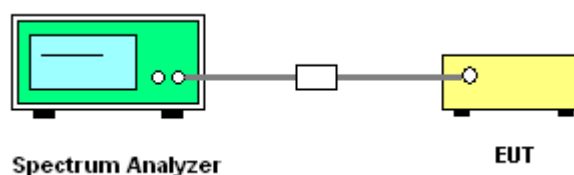

### 3.3.5 Test Result of Dwell Time

Test Mode :	3DH5	Temperature :	23~24°C
Test Engineer :	Adonis Li	Relative Humidity :	47~48%

Mode	Hopping Channel Number	Hops Over Occupancy Time(hops)	Package Transfer Time (msec)	Dwell Time (sec)	Limits (sec)	Pass/Fail
Normal	79	106.67	2.888	0.31	0.4	Pass
AFH	20	53.33	2.888	0.15	0.4	Pass

**Remark:**

- In normal mode, hopping rate is 1600 hops/s with 6 slots in 79 hopping channels.  
With channel hopping rate (1600 / 6 / 79) in Occupancy Time Limit (0.4 x 79) (s),  
Hops Over Occupancy Time comes to (1600 / 6 / 79) x (0.4 x 79) = 106.67 hops.
- In AFH mode, hopping rate is 800 hops/s with 6 slots in 20 hopping channels.  
With channel hopping rate (800 / 6 / 20) in Occupancy Time Limit (0.4 x 20) (s),  
Hops Over Occupancy Time comes to (800 / 6 / 20) x (0.4 x 20) = 53.33 hops.
- Dwell Time(s) = Hops Over Occupancy Time (hops) x Package Transfer Time

**Package Transfer Time Plot**

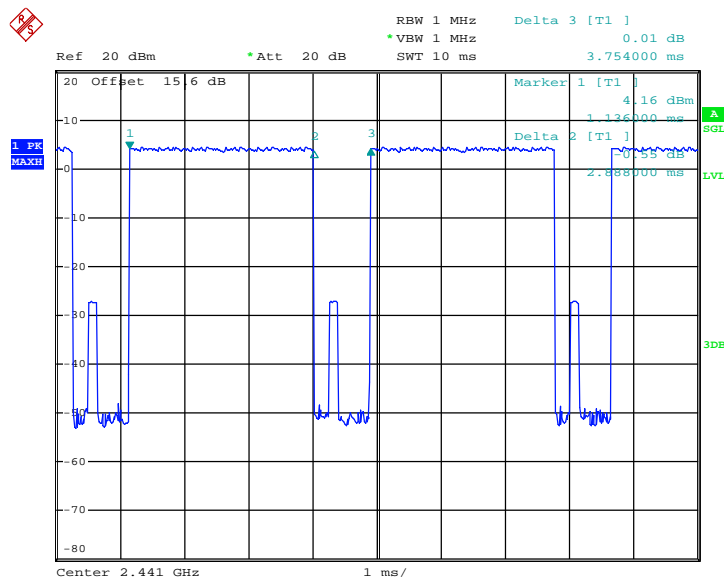

### 3.4 20dB Bandwidth Measurement

#### 3.4.1 Limit of 20dB Bandwidth

Reporting only

#### 3.4.2 Measuring Instruments

The measuring equipment is listed in the section 4 of this test report.

#### 3.4.3 Test Procedures

1. The testing follows FCC Public Notice DA 00-705 Measurement Guidelines.
2. The RF output of EUT was connected to the spectrum analyzer by RF cable and attenuator. The path loss was compensated to the results for each measurement.
3. Set to the maximum power setting and enable the EUT transmit continuously.
4. Use the following spectrum analyzer settings for 20dB Bandwidth measurement.  
Span = approximately 2 to 3 times the 20 dB bandwidth, centered on a hopping channel;  
RBW  $\geq$  1% of the 20 dB bandwidth; VBW  $\geq$  RBW; Sweep = auto; Detector function = peak;  
Trace = max hold.
5. Measure and record the results in the test report.

#### 3.4.4 Test Setup

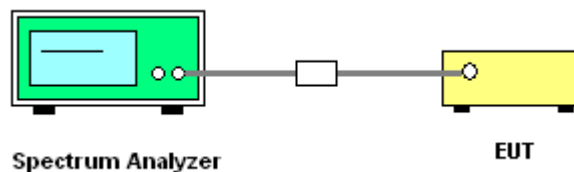

### 3.4.5 Test Result of 20dB Bandwidth

Test Mode :	1Mbps	Temperature :	23~24°C
Test Engineer :	Adonis Li	Relative Humidity :	47~48%

Channel	Frequency (MHz)	20dB Bandwidth (MHz)
00	2402	0.976
39	2441	0.960
78	2480	0.964

20 dB Bandwidth Plot on Channel 00

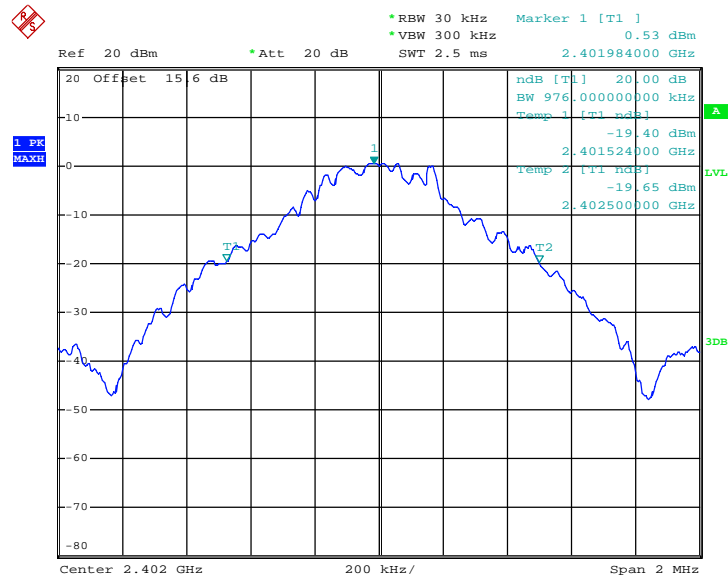





20 dB Bandwidth Plot on Channel 39

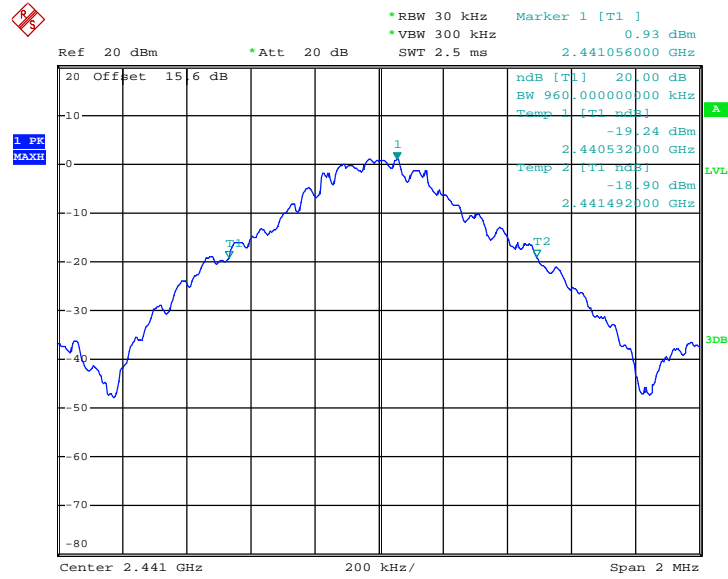

20 dB Bandwidth Plot on Channel 78

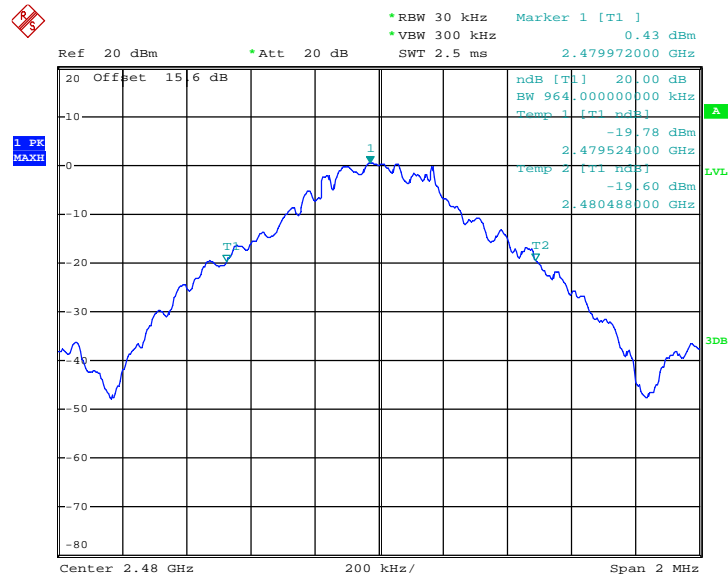



Test Mode :	2Mbps	Temperature :	23~24°C
Test Engineer :	Adonis Li	Relative Humidity :	47~48%

Channel	Frequency (MHz)	20dB Bandwidth (MHz)
00	2402	1.254
39	2441	1.266
78	2480	1.266

20 dB Bandwidth Plot on Channel 00

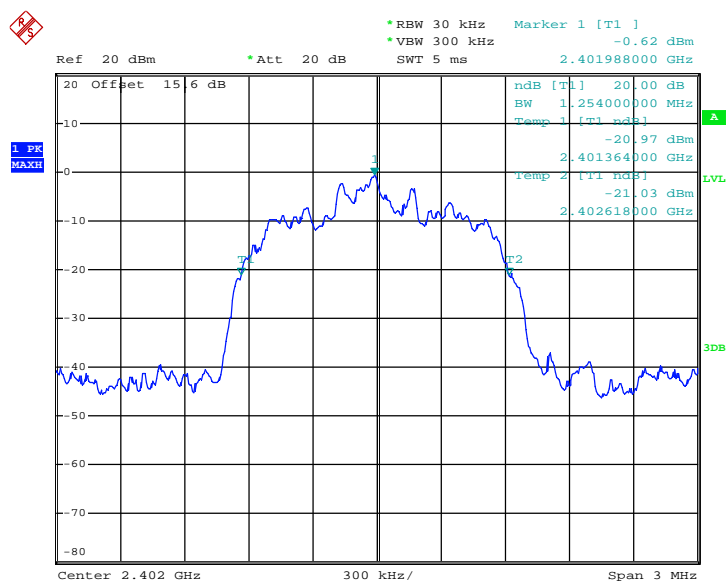



20 dB Bandwidth Plot on Channel 39

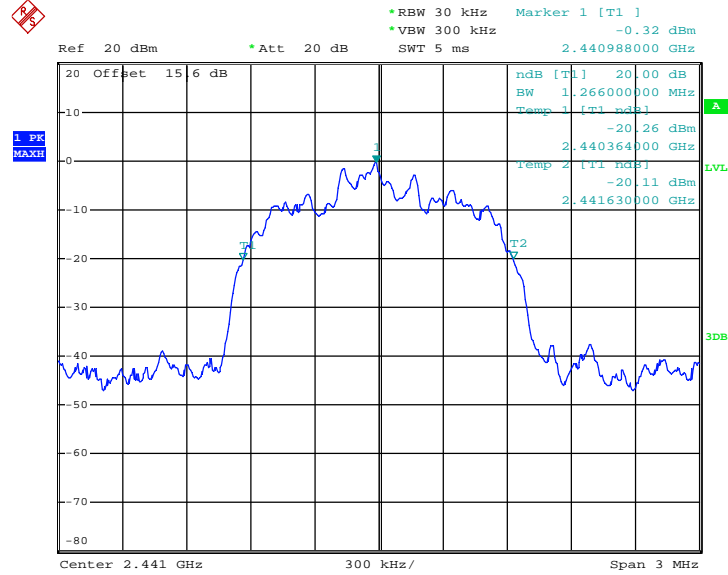

20 dB Bandwidth Plot on Channel 78

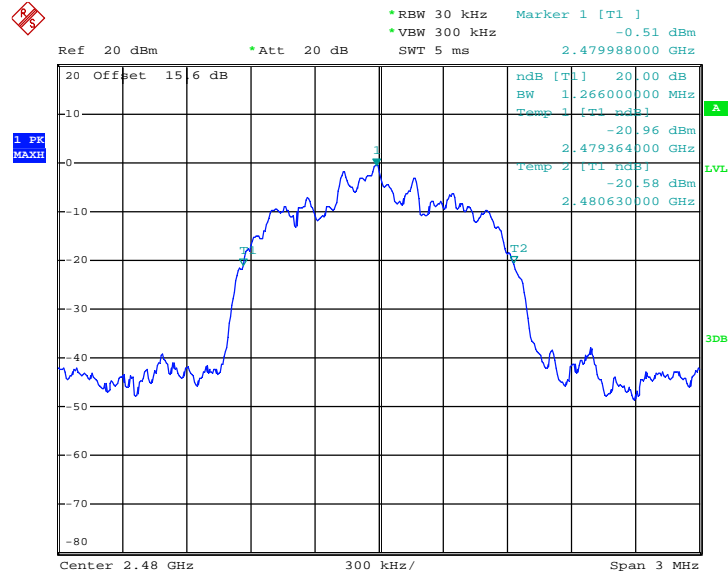



Test Mode :	3Mbps	Temperature :	23~24°C
Test Engineer :	Adonis Li	Relative Humidity :	47~48%

Channel	Frequency (MHz)	20dB Bandwidth (MHz)
00	2402	1.236
39	2441	1.254
78	2480	1.254

20 dB Bandwidth Plot on Channel 00

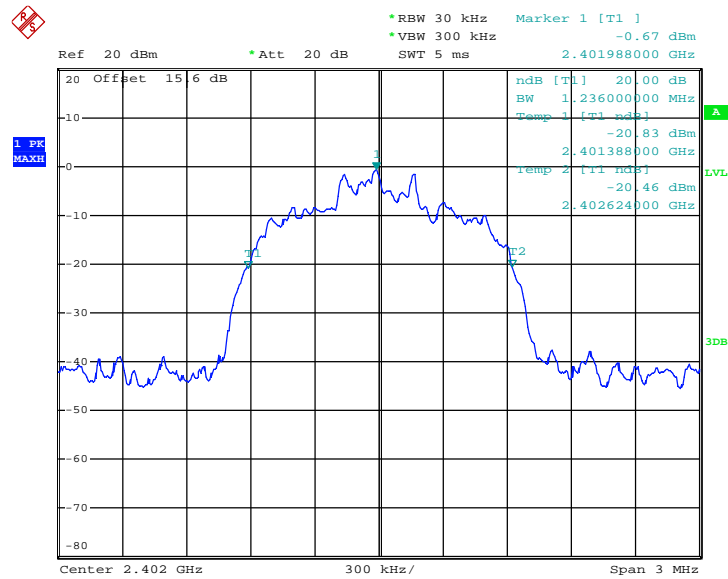



20 dB Bandwidth Plot on Channel 39

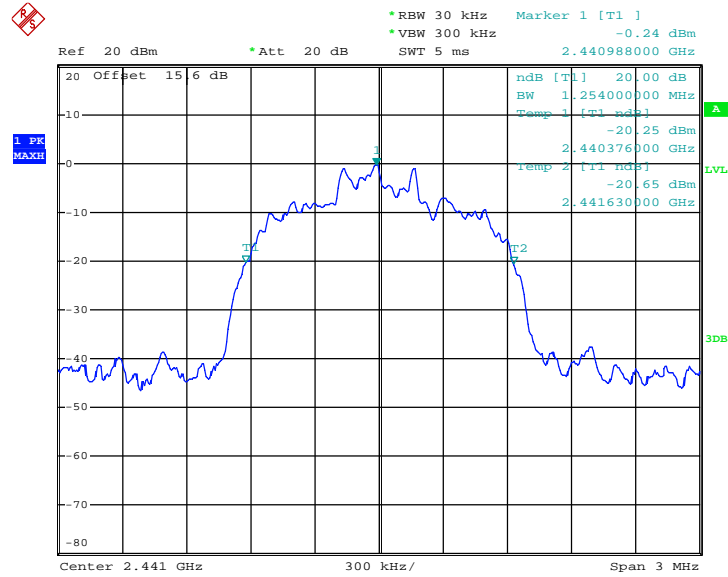

20 dB Bandwidth Plot on Channel 78

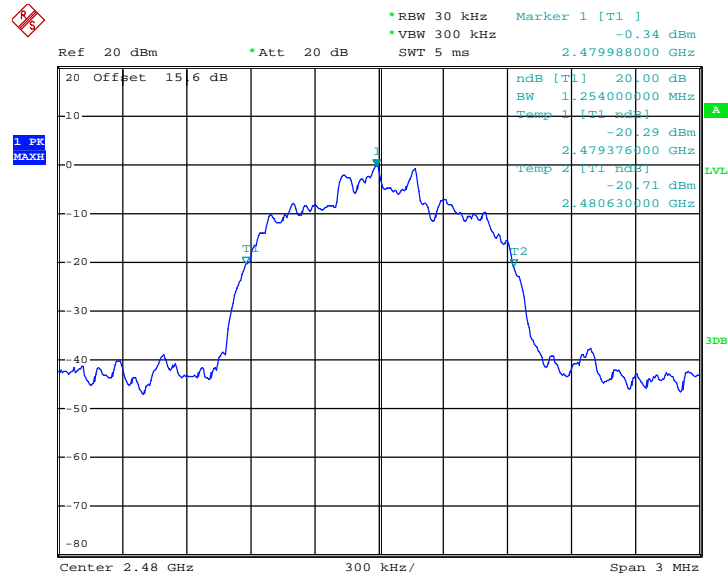

### 3.5 Peak Output Power Measurement

#### 3.5.1 Limit of Peak Output Power

Section 15.247 (b) The maximum peak conducted output power of the intentional radiator shall not exceed the following: (1) For frequency hopping systems operating in the 2400-2483.5 MHz band employing at least 75 non-overlapping hopping channels, and all frequency hopping systems in the 5725-5850 MHz band: 1 watt. For all other frequency hopping systems in the 2400-2483.5 MHz band 0.125 watts.

#### 3.5.2 Measuring Instruments

The measuring equipment is listed in the section 4 of this test report.

#### 3.5.3 Test Procedures

1. The testing follows FCC Public Notice DA 00-705 Measurement Guidelines.
2. The RF output of EUT was connected to the power meter by RF cable and attenuator. The path loss was compensated to the results for each measurement.
3. Set to the maximum power setting and enable the EUT transmit continuously.
4. Measure the conducted output power with cable loss and record the results in the test report.
5. Measure and record the results in the test report.

#### 3.5.4 Test Setup

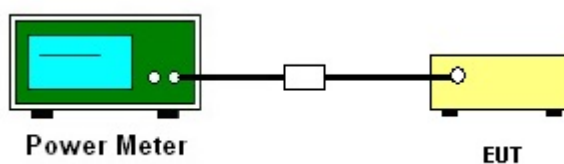

3.5.5 Test Result of Peak Output Power

Test Mode :	1Mbps	Temperature :	23~24°C
Test Engineer :	Adonis Li	Relative Humidity :	47~48%

Channel	Frequency (MHz)	RF Power (dBm)		
		GFSK	Max. Limits (dBm)	Pass/Fail
		1 Mbps		
00	2402	6.79	20.97	Pass
39	2441	7.44	20.97	Pass
78	2480	7.50	20.97	Pass

Test Mode :	2Mbps	Temperature :	23~24°C
Test Engineer :	Adonis Li	Relative Humidity :	47~48%

Channel	Frequency (MHz)	RF Power (dBm)		
		$\pi/4$ -DQPSK	Max. Limits (dBm)	Pass/Fail
		2 Mbps		
00	2402	6.39	20.97	Pass
39	2441	7.12	20.97	Pass
78	2480	7.34	20.97	Pass

Test Mode :	3Mbps	Temperature :	23~24°C
Test Engineer :	Adonis Li	Relative Humidity :	47~48%

Channel	Frequency (MHz)	RF Power (dBm)		
		8-DPSK	Max. Limits (dBm)	Pass/Fail
		3 Mbps		
00	2402	6.84	20.97	Pass
39	2441	7.45	20.97	Pass
78	2480	7.51	20.97	Pass

## 3.6 Conducted Band Edges Measurement

### 3.6.1 Limit of Band Edges

In any 100 kHz bandwidth outside the intentional radiation frequency band, the radio frequency power shall be at least 20 dB below the highest level of the radiated power. In addition, radiated emissions which fall in the restricted bands must also comply with the radiated emission limits.

### 3.6.2 Measuring Instruments

The measuring equipment is listed in the section 4 of this test report.

### 3.6.3 Test Procedures

1. The testing follows the guidelines in Band-edge Compliance of RF Conducted Emissions of FCC Public Notice DA 00-705 Measurement Guidelines.
2. Set to the maximum power setting and enable the EUT transmit continuously.
3. Set RBW = 100kHz ( $\geq 1\%$  span=10MHz ), VBW = 300kHz ( $\geq$  RBW). Band edge emissions must be at least 20 dB down from the highest emission level within the authorized band as measured with a 100kHz RBW. The attenuation shall be 30 dB instead of 20 dB when RMS conducted output power procedure is used.
4. Enable hopping function of the EUT and then repeat step 2. and 3.
5. Measure and record the results in the test report.

### 3.6.4 Test Setup

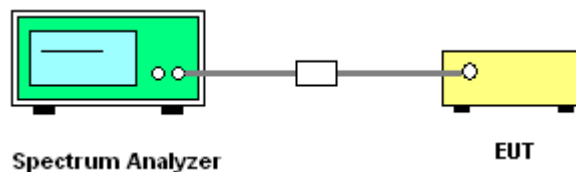



### 3.6.5 Test Result of Conducted Band Edges

Test Mode :	1Mbps	Temperature :	23~24°C
Test Channel :	00 and 78	Relative Humidity :	47~48%
		Test Engineer :	Adonis Li

Low Band Edge Plot on Channel 00

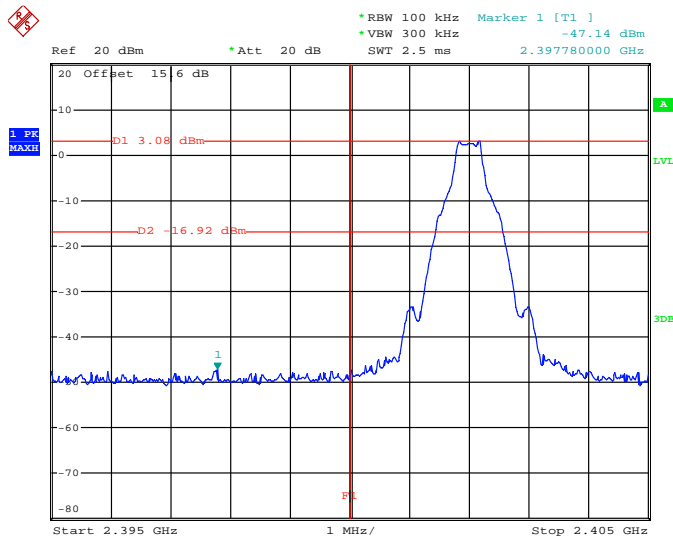

High Band Edge Plot on Channel 78

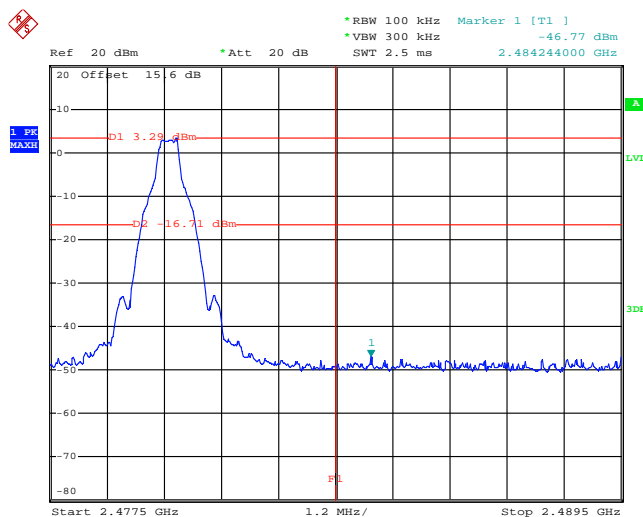



Test Mode :	2Mbps	Temperature :	23~24°C
Test Channel :	00 and 78	Relative Humidity :	47~48%
		Test Engineer :	Adonis Li

Low Band Edge Plot on Channel 00

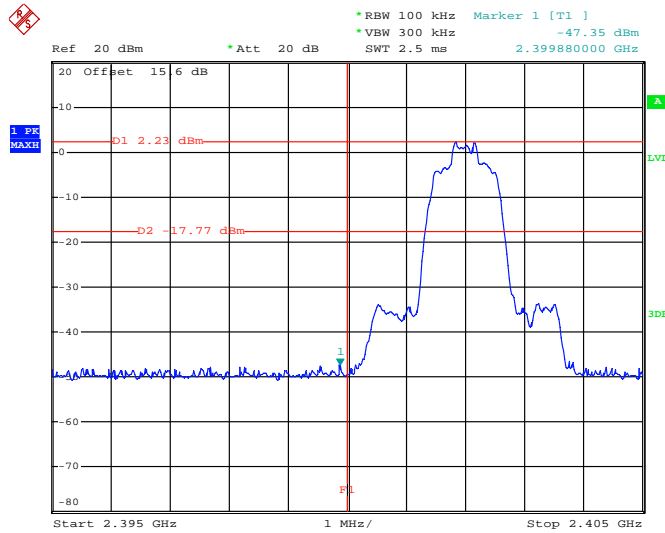

High Band Edge Plot on Channel 78

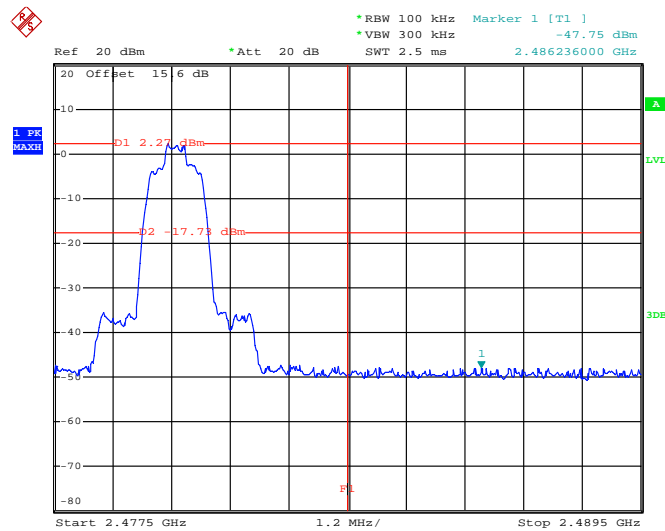



Test Mode :	3Mbps	Temperature :	23~24°C
Test Channel :	00 and 78	Relative Humidity :	47~48%
		Test Engineer :	Adonis Li

Low Band Edge Plot on Channel 00

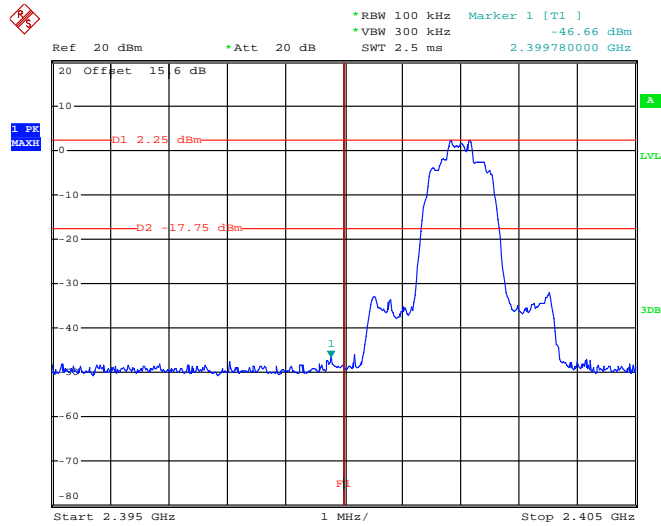

High Band Edge Plot on Channel 78

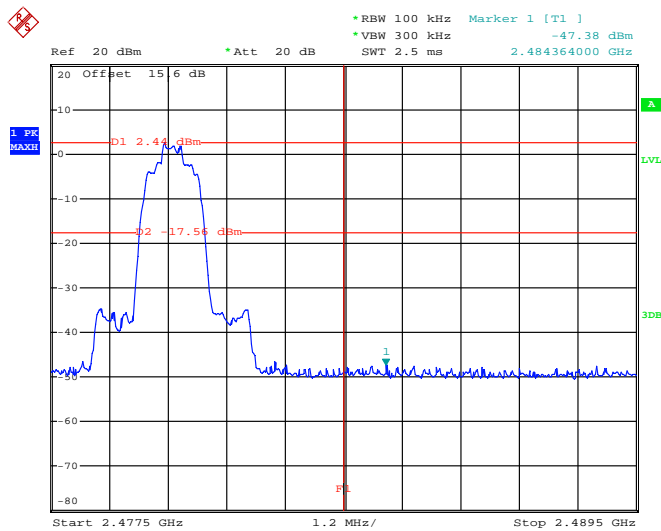

### 3.6.6 Test Result of Conducted Hopping Mode Band Edges

Test Mode :	1Mbps	Temperature :	23~24°C
Test Engineer :	Adonis Li	Relative Humidity :	47~48%

1Mbps Hopping Mode Low Band Edge Plot

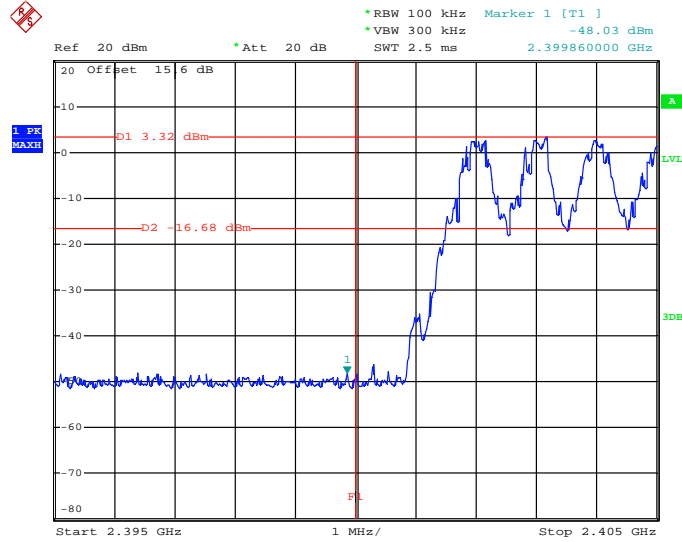

1Mbps Hopping Mode High Band Edge Plot

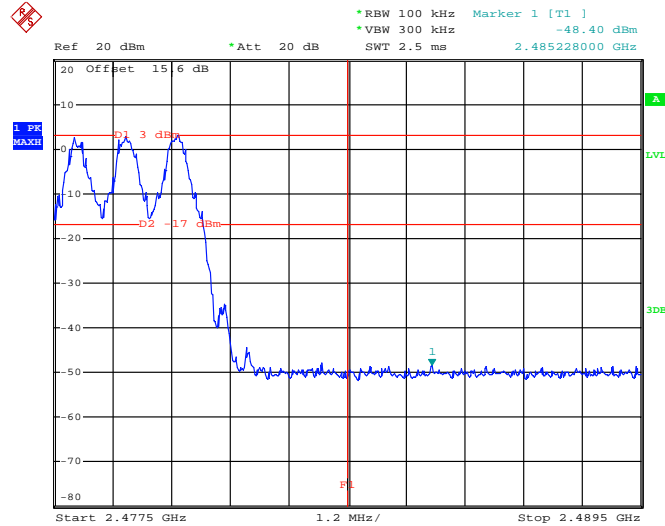

DATE: 03 JUN 2009 06:11:00



Test Mode :	2Mbps	Temperature :	23~24°C
Test Engineer :	Adonis Li	Relative Humidity :	47~48%

2Mbps Hopping Mode Low Band Edge Plot

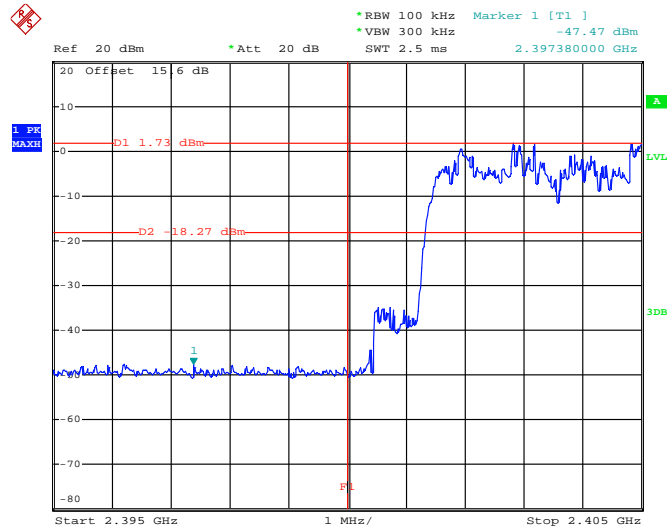

2Mbps Hopping Mode High Band Edge Plot

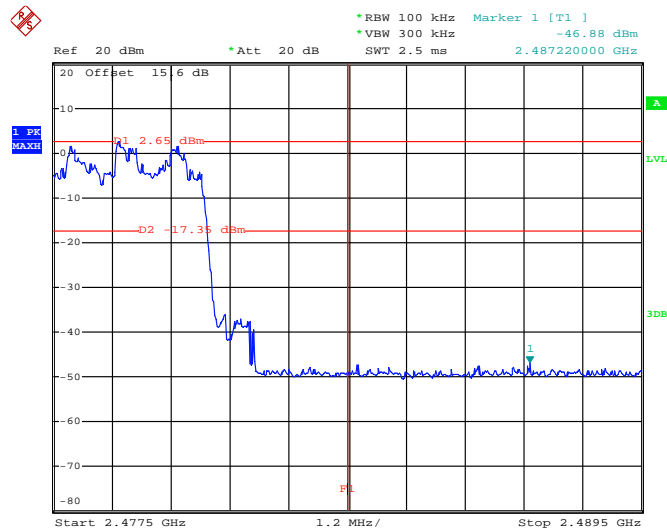



Test Mode :	3Mbps	Temperature :	23~24°C
Test Engineer :	Adonis Li	Relative Humidity :	47~48%

3Mbps Hopping Mode Low Band Edge Plot

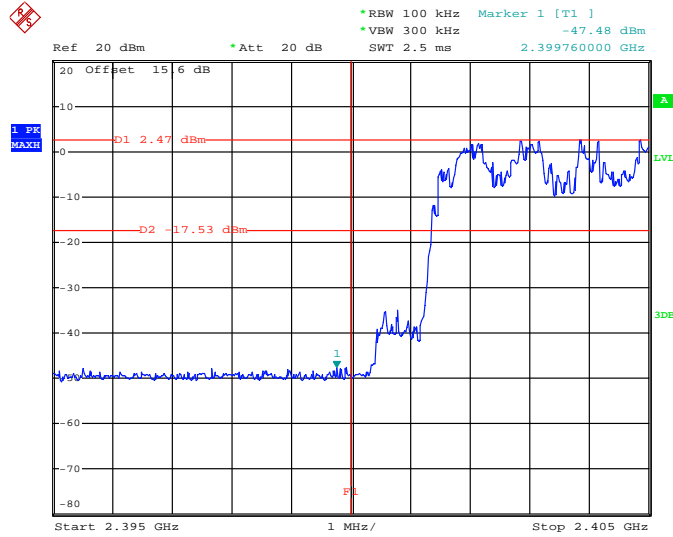

3Mbps Hopping Mode High Band Edge Plot

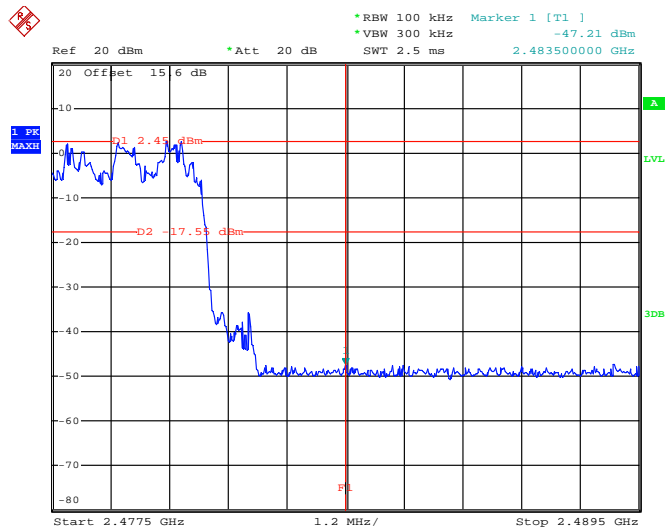

## 3.7 Conducted Spurious Emission Measurement

### 3.7.1 Limit of Spurious Emission Measurement

In any 100 kHz bandwidth outside the intentional radiation frequency band, the radio frequency power shall be at least 20 dB below the highest level of the radiated power. In addition, radiated emissions which fall in the restricted bands must also comply with the radiated emission limits.

### 3.7.2 Measuring Instruments

The measuring equipment is listed in the section 4 of this test report.

### 3.7.3 Test Procedure

1. The testing follows the guidelines in Spurious RF Conducted Emissions of FCC Public Notice DA 00-705 Measurement Guidelines
2. The RF output of EUT was connected to the spectrum analyzer by RF cable and attenuator. The path loss was compensated to the results for each measurement.
3. Set to the maximum power setting and enable the EUT transmit continuously.
4. Set RBW = 100 kHz, VBW = 300kHz, scan up through 10th harmonic. All harmonics / spurs must be at least 20 dB down from the highest emission level within the authorized band as measured with a 100 kHz RBW.
5. Measure and record the results in the test report.
6. The RF fundamental frequency should be excluded against the limit line in the operating frequency band.

### 3.7.4 Test Setup

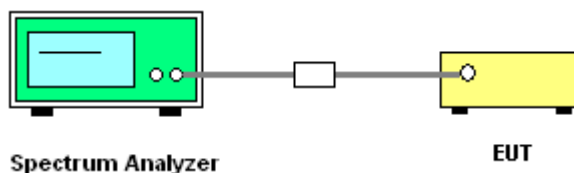

### 3.7.5 Test Result of Conducted Spurious Emission

Test Mode :	1Mbps	Temperature :	23~24°C
Test Channel :	00	Relative Humidity :	47~48%
		Test Engineer :	Adonis Li

1Mbps CSE Plot on Ch 00 between 30MHz ~ 3 GHz

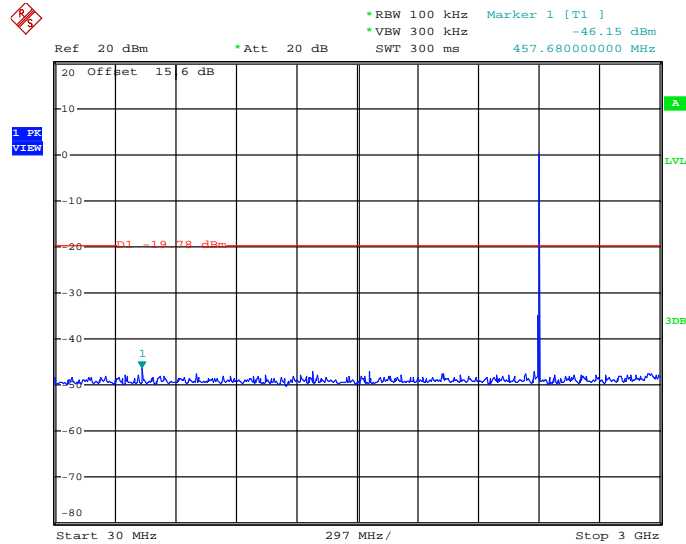

1Mbps CSE Plot on Ch 00 between 2 GHz ~ 25 GHz

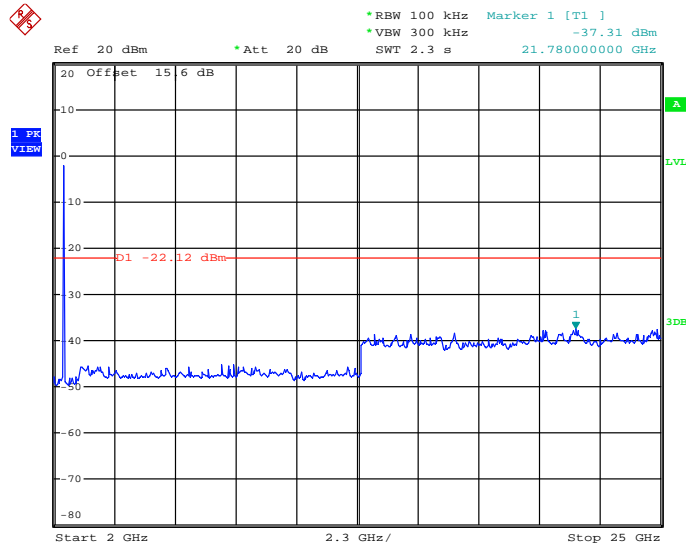





Test Mode :	1Mbps	Temperature :	23~24°C
Test Channel :	39	Relative Humidity :	47~48%
		Test Engineer :	Adonis Li

1Mbps CSE Plot on Ch 39 between 30MHz ~ 3 GHz

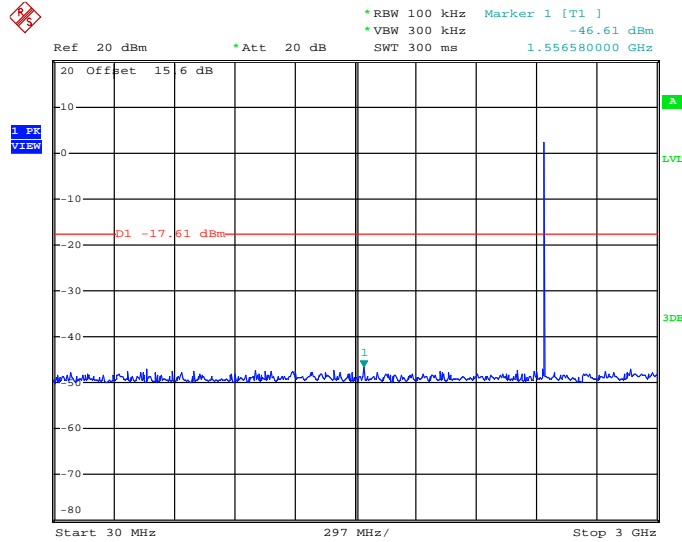

1Mbps CSE Plot on Ch 39 between 2 GHz ~ 25 GHz

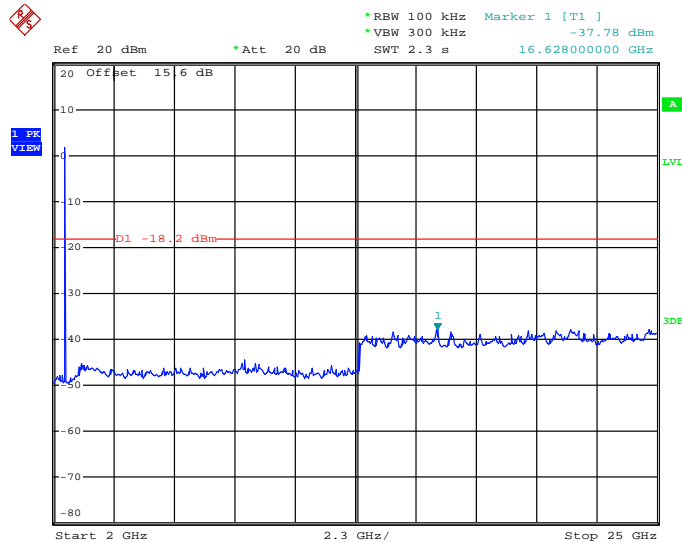



Test Mode :	1Mbps	Temperature :	23~24°C
Test Channel :	78	Relative Humidity :	47~48%
		Test Engineer :	Adonis Li

1Mbps CSE Plot on Ch 78 between 30MHz ~ 3 GHz

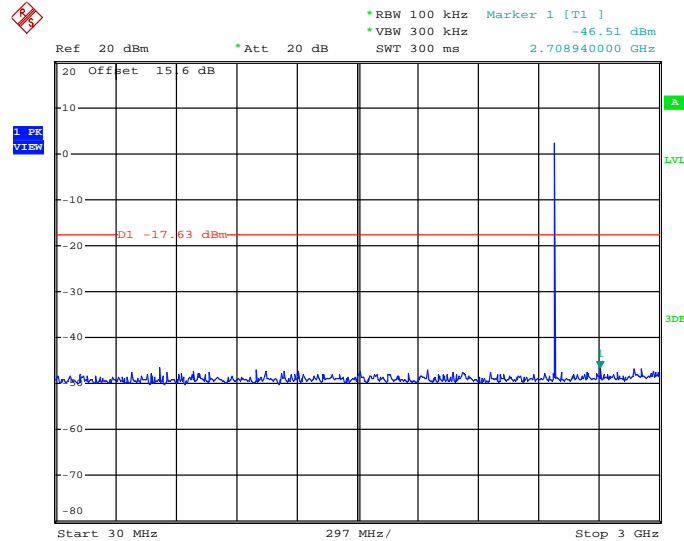

1Mbps CSE Plot on Ch 78 between 2 GHz ~ 25 GHz

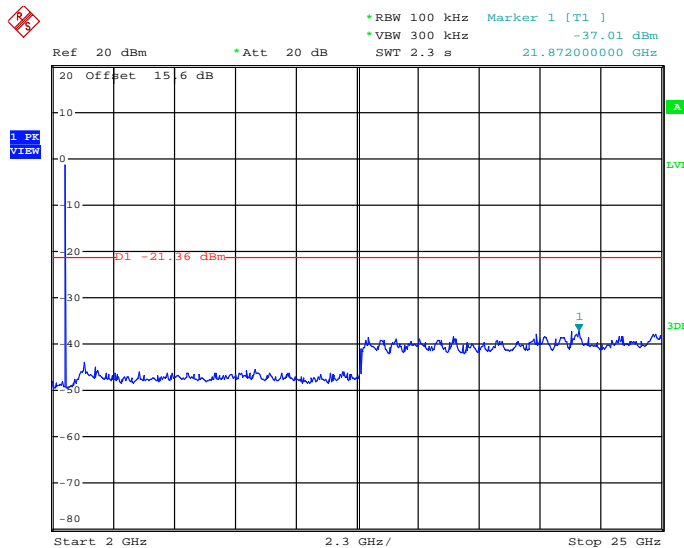



Test Mode :	2Mbps	Temperature :	23~24°C
Test Channel :	00	Relative Humidity :	47~48%
		Test Engineer :	Adonis Li

2Mbps CSE Plot on Ch 00 between 30MHz ~ 3 GHz

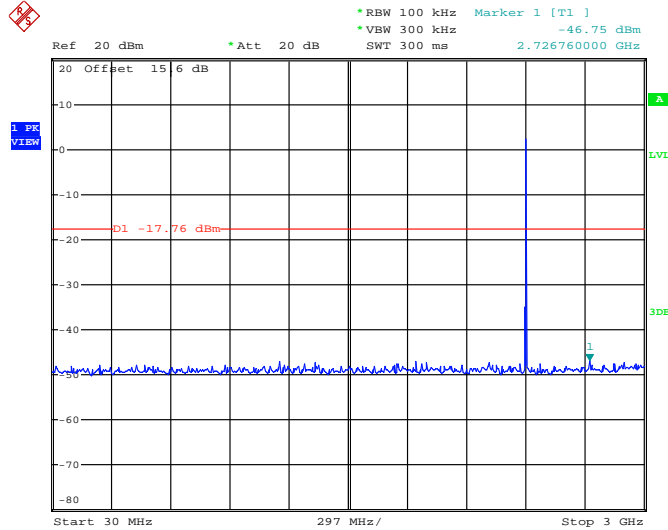

2Mbps CSE Plot on Ch 00 between 2 GHz ~ 25 GHz

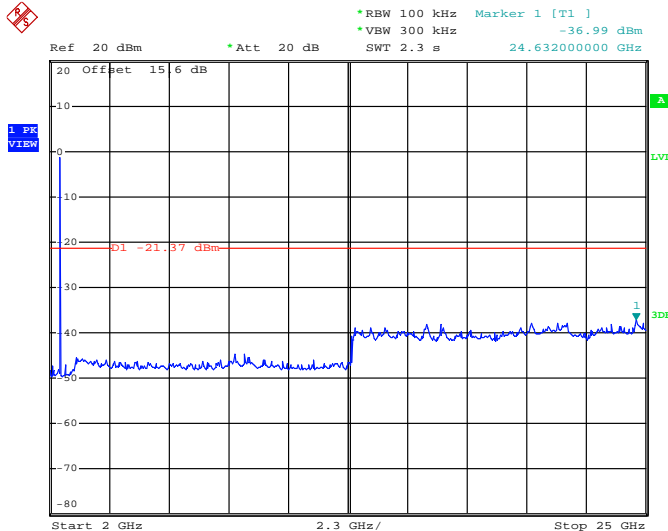



Test Mode :	2Mbps	Temperature :	23~24°C
Test Channel :	39	Relative Humidity :	47~48%
		Test Engineer :	Adonis Li

2Mbps CSE Plot on Ch 39 between 30MHz ~ 3 GHz

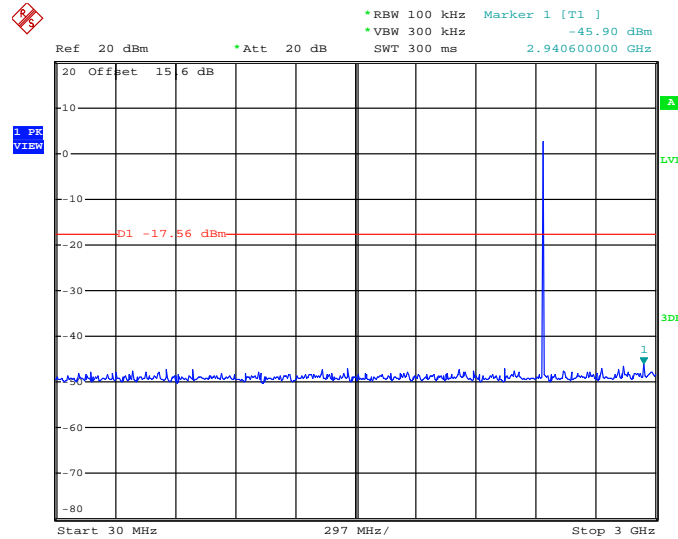

2Mbps CSE Plot on Ch 39 between 2 GHz ~ 25 GHz

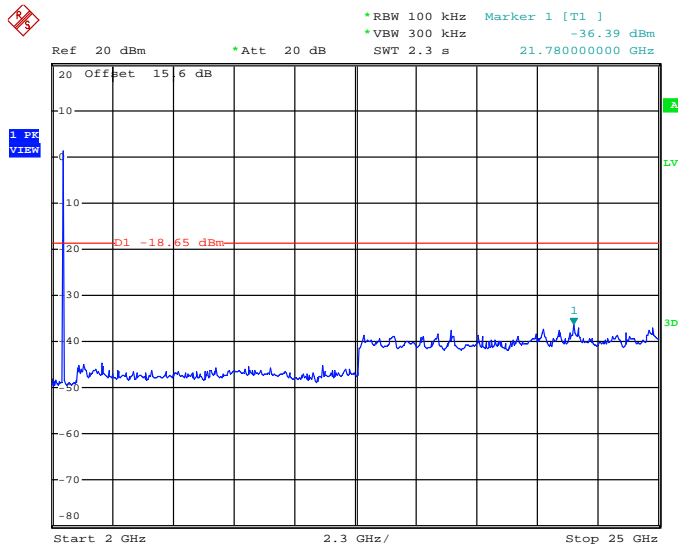



Test Mode :	2Mbps	Temperature :	23~24°C
Test Channel :	78	Relative Humidity :	47~48%
		Test Engineer :	Adonis Li

2Mbps CSE Plot on Ch 78 between 30MHz ~ 3 GHz

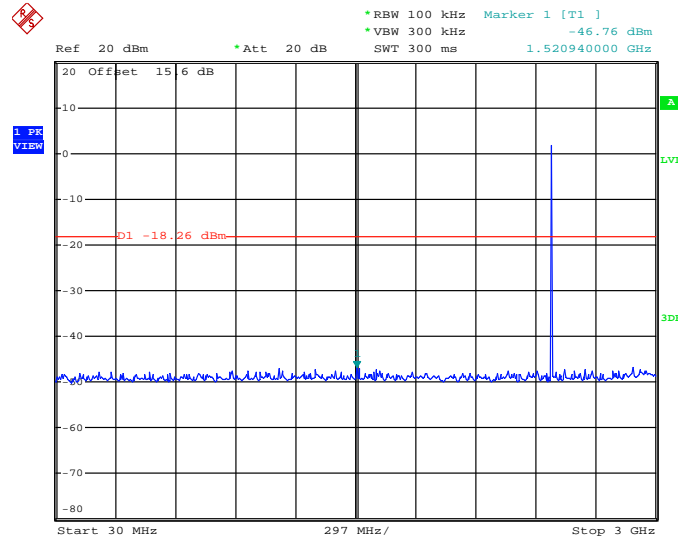

2Mbps CSE Plot on Ch 78 between 2 GHz ~ 25 GHz

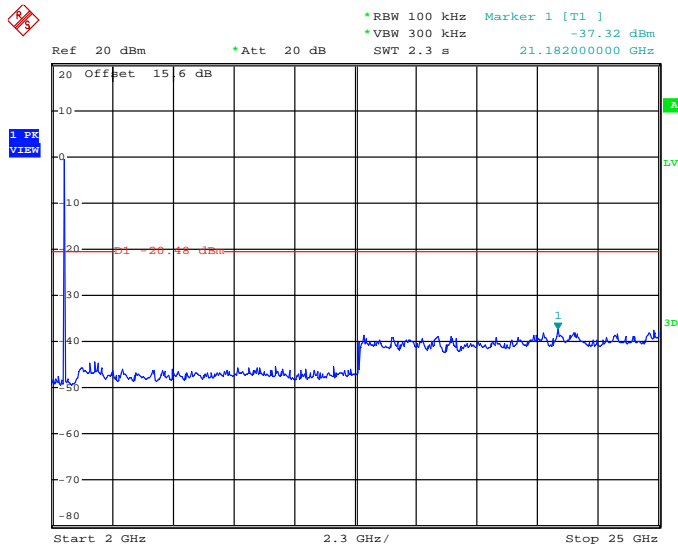



Test Mode :	3Mbps	Temperature :	23~24°C
Test Channel :	00	Relative Humidity :	47~48%
		Test Engineer :	Adonis Li

3Mbps CSE Plot on Ch 00 between 30MHz ~ 3 GHz

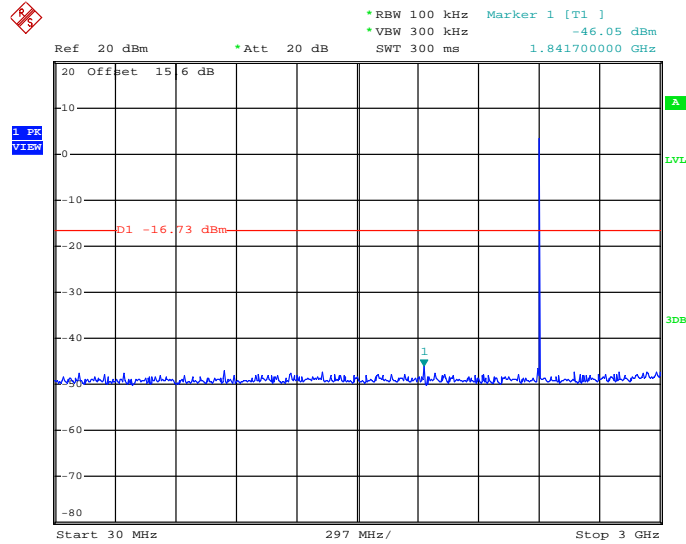

3Mbps CSE Plot on Ch 00 between 2 GHz ~ 25 GHz

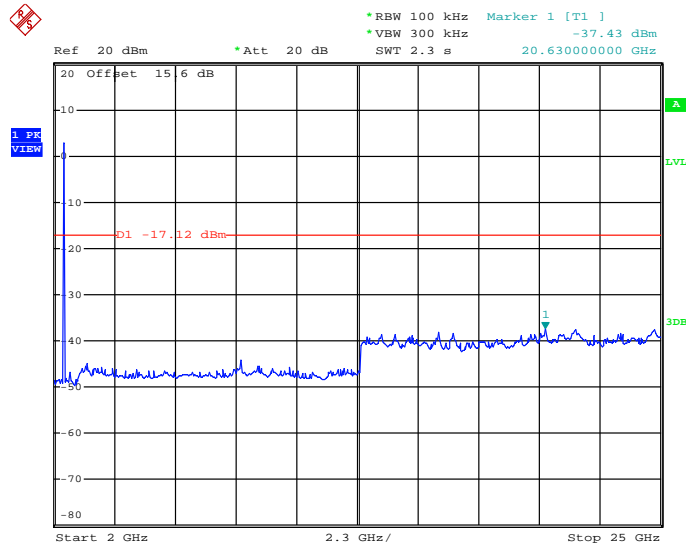



Test Mode :	3Mbps	Temperature :	23~24°C
Test Channel :	39	Relative Humidity :	47~48%
		Test Engineer :	Adonis Li

3Mbps CSE Plot on Ch 39 between 30MHz ~ 3 GHz

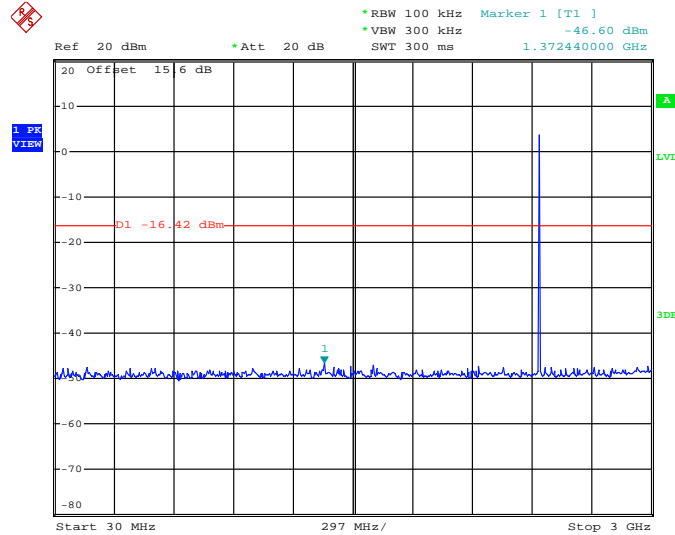

3Mbps CSE Plot on Ch 39 between 2 GHz ~ 25 GHz

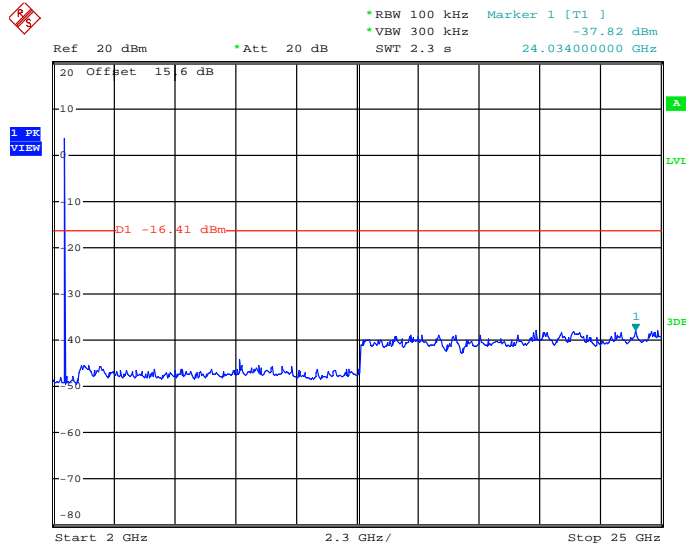



Test Mode :	3Mbps	Temperature :	23~24°C
Test Channel :	78	Relative Humidity :	47~48%
		Test Engineer :	Adonis Li

3Mbps CSE Plot on Ch 78 between 30MHz ~ 3 GHz

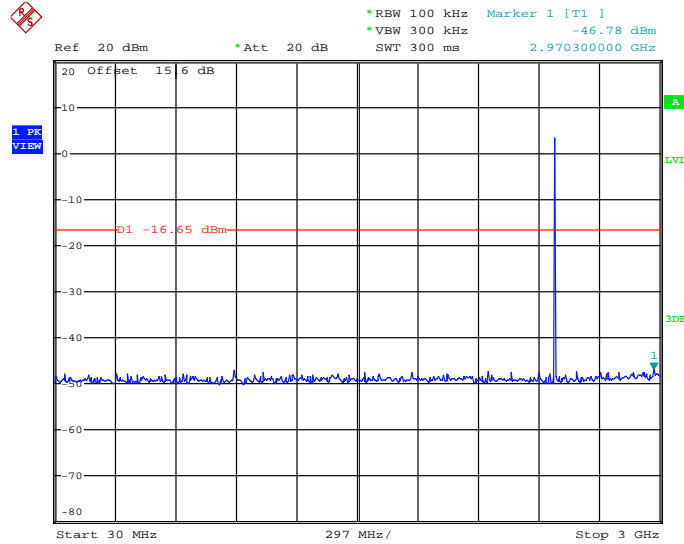

3Mbps CSE Plot on Ch 78 between 2 GHz ~ 25 GHz

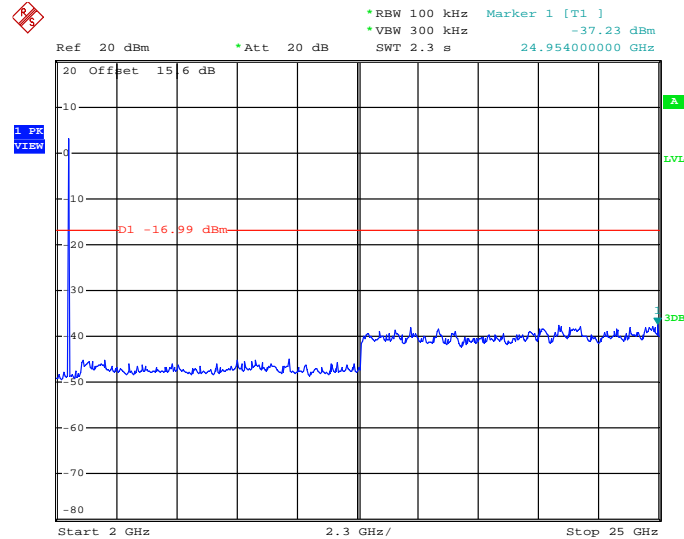



## 3.8 Radiated Band Edges and Spurious Emission Measurement

### 3.8.1 Limit of Radiated Band Edges and Spurious Emission

In any 100 kHz bandwidth outside the intentional radiator frequency band, all harmonics/spurious must be at least 20 dB below the highest emission level within the authorized band. In addition, radiated emissions which fall in the restricted bands must also comply with the FCC section 15.209 limits as below.

Frequency (MHz)	Field Strength (microvolts/meter)	Measurement Distance (meters)
0.009 – 0.490	2400/F(kHz)	300
0.490 – 1.705	24000/F(kHz)	30
1.705 – 30.0	30	30
30 – 88	100	3
88 – 216	150	3
216 - 960	200	3
Above 960	500	3

### 3.8.2 Measuring Instruments

The measuring equipment is listed in the section 4 of this test report.

### 3.8.3 Test Procedures

1. The testing follows the guidelines in Spurious Radiated Emissions of FCC Public Notice DA 00-705 Measurement Guidelines.
2. The EUT was placed on a turntable with 0.8 meter above ground.
3. The EUT was set 3 meters from the interference receiving antenna, which was mounted on the top of a variable height antenna tower.
4. For each suspected emission, the EUT was arranged to its worst case and then tune the Antenna tower (from 1 m to 4 m) and turntable (from 0 degree to 360 degrees) to find the maximum reading. A pre-amp and a high pass filter are used for the test in order to get better signal level to comply with the guidelines.
5. Set to the maximum power setting and enable the EUT transmit continuously.
6. Use the following spectrum analyzer settings:
  - (1) Span shall wide enough to fully capture the emission being measured;
  - (2) Set RBW=100 kHz for  $f < 1$  GHz, RBW=1MHz for  $f > 1$ GHz ; VBW  $\geq$  RBW; Sweep = auto; Detector function = peak; Trace = max hold for peak
  - (3) For average measurement: use duty cycle correction factor method per 15.35(c).  
Duty cycle = On time/100 milliseconds  
On time =  $N_1 * L_1 + N_2 * L_2 + \dots + N_{n-1} * L_{n-1} + N_n * L_n$   
Where  $N_1$  is number of type 1 pulses,  $L_1$  is length of type 1 pulses, etc.  
Average Emission Level = Peak Emission Level +  $20 * \log(\text{Duty cycle})$
7. Corrected Reading: Antenna Factor + Cable Loss + Read Level - Preamp Factor = Level

Note: The average levels were calculated from the peak level corrected with duty cycle correction factor (-24.82dB) derived from  $20 \log(\text{dwell time}/100\text{ms})$ . This correction is only for signals that hop with the fundamental signal, such as band-edge and harmonic. Other spurious signals that are independent of the hopping signal would not use this correction.

### 3.8.4 Test Setup

For radiated emissions below 30MHz

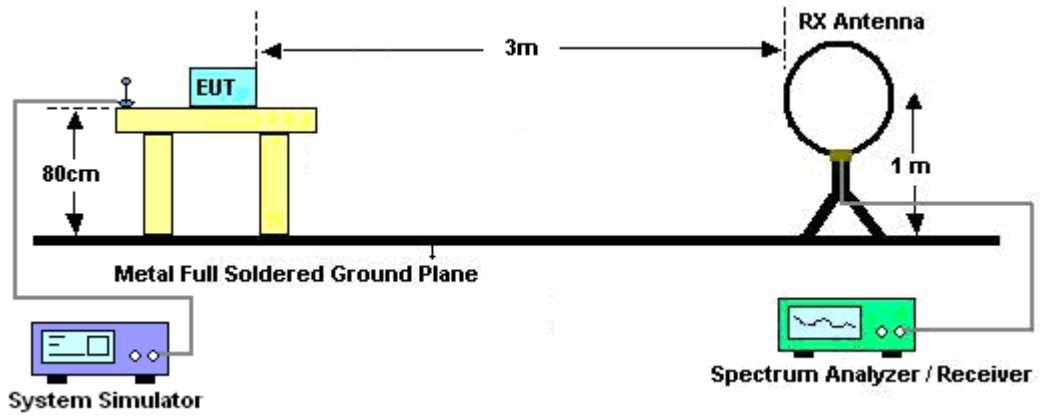

For radiated emissions from 30MHz to 1GHz

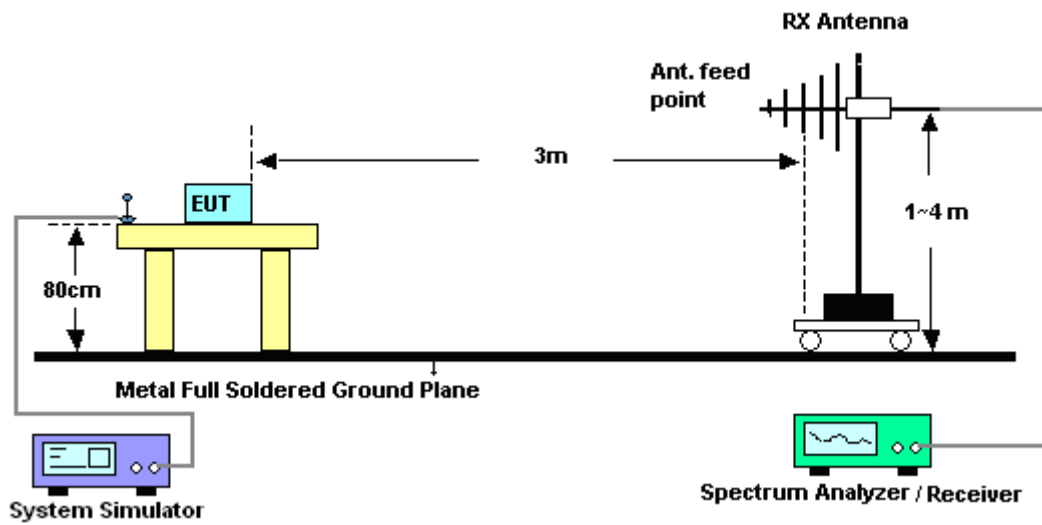

For radiated emissions above 1GHz

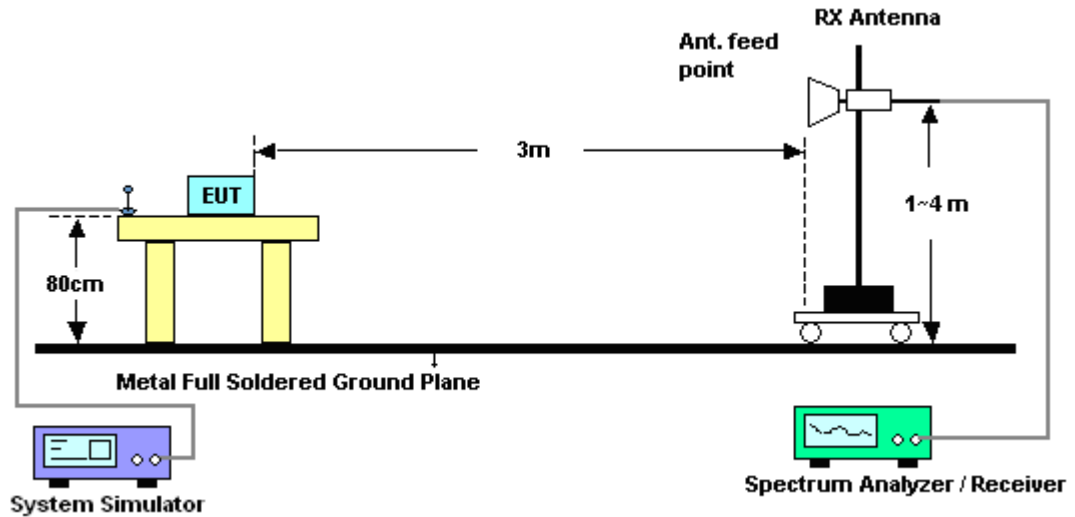

### 3.8.5 Test Results of Radiated Spurious Emissions (9 kHz ~ 30 MHz)

The low frequency, which started from 9 kHz to 30MHz, was pre-scanned and the result which was 20dB lower than the limit line per 15.31(o) was not reported.

### 3.8.6 Duty cycle correction factor for average measurement

#### 3DH5 on time (One Pulse) Plot on Channel 39

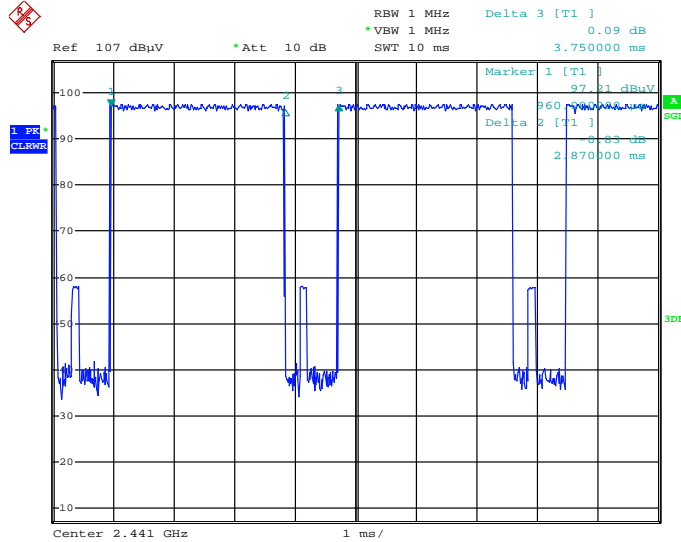

Date: 21.NOV.2013 13:37:45

#### 3DH5 on time (Count Pulses) Plot on Channel 39

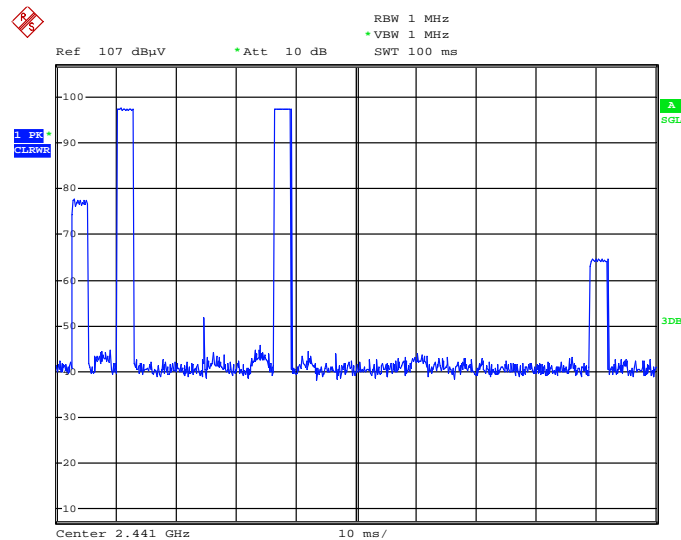

Date: 21.NOV.2013 13:39:47

**Note:**

1. Worst case Duty cycle = on time/100 milliseconds =  $2 * 2.87 / 100 = 5.74 \%$
2. Worst case Duty cycle correction factor =  $20 * \log(\text{Duty cycle}) = -24.82 \text{ dB}$
3. 3DH5 has the highest duty cycle worst case and is reported.

**Duty Cycle Correction Factor Consideration for AFH mode:**

Bluetooth normal hopping rate is 1600Hz and reduced to 800Hz in AFH mode; due to the reduced number of hopping frequencies, with the same packet configuration the dwell time in each channel frequency within 100msec period is longer in AFH mode than normal mode.

In AFH mode, the minimum hopping frequencies are 20, to get the longest dwell time DH5 packet is observed; the period to have DH5 packet completing one hopping sequence is

$$2.87 \text{ ms} \times 20 \text{ channels} = 57.4 \text{ ms}$$

There cannot be 2 complete hopping sequences within 100ms period, considering the random hopping behavior, maximum 2 hops can be possibly observed within the period.  $[100\text{ms} / 57.6\text{ms}] = 2$  hops

Thus, the maximum possible ON time:

$$2.87 \text{ ms} \times 2 = 5.74 \text{ ms}$$

Worst case Duty Cycle Correction factor, which is derived from the maximum possible ON time,

$$20 \times \log(5.74 \text{ ms}/100\text{ms}) = -24.82 \text{ dB}$$



3.8.7 Test Result of Radiated Spurious at Band Edges

Test Mode :	3Mbps	Temperature :	23~24°C
Test Channel :	00	Relative Humidity :	43~44%
		Test Engineer :	Stone Gu

ANTENNA POLARITY : HORIZONTAL										
Frequency ( MHz )	Level ( dBμV/m )	Over Limit ( dB )	Limit Line ( dBμV/m )	Read Level ( dBμV )	Antenna Factor ( dB )	Cable Loss ( dB )	Preamp Factor ( dB )	Ant Pos ( cm )	Table Pos ( deg )	Remark
2388.03	50.76	-23.24	74	45.41	32.86	3.17	30.68	100	203	Peak
2388.03	25.94	-28.06	54	-	-	-	-	-	-	Average

ANTENNA POLARITY : VERTICAL										
Frequency ( MHz )	Level ( dBμV/m )	Over Limit ( dB )	Limit Line ( dBμV/m )	Read Level ( dBμV )	Antenna Factor ( dB )	Cable Loss ( dB )	Preamp Factor ( dB )	Ant Pos ( cm )	Table Pos ( deg )	Remark
2378.94	49.94	-24.06	74	44.65	32.83	3.16	30.7	100	241	Peak
2378.94	25.12	-28.88	54	-	-	-	-	-	-	Average

Test Mode :	3Mbps	Temperature :	23~24°C
Test Channel :	78	Relative Humidity :	43~44%
		Test Engineer :	Stone Gu

ANTENNA POLARITY : HORIZONTAL										
Frequency ( MHz )	Level ( dBμV/m )	Over Limit ( dB )	Limit Line ( dBμV/m )	Read Level ( dBμV )	Antenna Factor ( dB )	Cable Loss ( dB )	Preamp Factor ( dB )	Ant Pos ( cm )	Table Pos ( deg )	Remark
2483.5	64.06	-9.94	74	58.43	33.01	3.22	30.6	100	59	Peak
2483.5	39.24	-14.76	54	-	-	-	-	-	-	Average

ANTENNA POLARITY : VERTICAL										
Frequency ( MHz )	Level ( dBμV/m )	Over Limit ( dB )	Limit Line ( dBμV/m )	Read Level ( dBμV )	Antenna Factor ( dB )	Cable Loss ( dB )	Preamp Factor ( dB )	Ant Pos ( cm )	Table Pos ( deg )	Remark
2483.5	61.96	-12.04	74	56.33	33.01	3.22	30.6	100	271	Peak
2483.5	37.14	-16.86	54	-	-	-	-	-	-	Average

### 3.8.8 Test Result of Radiated Spurious Emission (30MHz ~ 10<sup>th</sup> Harmonic)

**Note:** Pre-scanned all test modes and only choose the worst case mode recorded in the test report for radiated spurious emission below 1GHz.

<b>Test Mode :</b>	3Mbps	<b>Temperature :</b>	23~24°C
<b>Test Channel :</b>	00	<b>Relative Humidity :</b>	43~44%
<b>Test Engineer :</b>	Stone Gu	<b>Polarization :</b>	Horizontal
<b>Remark :</b>	1. 2402 MHz is fundamental signal which can be ignored. 2. Average measurement was not performed if peak level went lower than the average limit.		

Frequency ( MHz )	Level ( dBμV/m )	Over Limit ( dB )	Limit Line ( dBμV/m )	Read Level ( dBμV )	Antenna Factor ( dB )	Cable Loss ( dB )	Preamp Factor ( dB )	Ant Pos ( cm )	Table Pos ( deg )	Remark
2402	102.05	-	-	96.7	32.86	3.17	30.68	100	56	Peak
2402	77.23	-	-	-	-	-	-	100	56	Average
4804	47.5	-26.5	74	37.07	35.17	4.58	29.32	100	310	Peak

**Note:** Other harmonics are lower than background noise.

<b>Test Mode :</b>	3Mbps	<b>Temperature :</b>	23~24°C
<b>Test Channel :</b>	00	<b>Relative Humidity :</b>	43~44%
<b>Test Engineer :</b>	Stone Gu	<b>Polarization :</b>	Vertical
<b>Remark :</b>	1. 2402 MHz is fundamental signal which can be ignored. 2. Average measurement was not performed if peak level went lower than the average limit.		

Frequency ( MHz )	Level ( dBμV/m )	Over Limit ( dB )	Limit Line ( dBμV/m )	Read Level ( dBμV )	Antenna Factor ( dB )	Cable Loss ( dB )	Preamp Factor ( dB )	Ant Pos ( cm )	Table Pos ( deg )	Remark
2402	99.11	-	-	93.76	32.86	3.17	30.68	102	241	Peak
2402	74.29	-	-	-	-	-	-	102	241	Average
4804	48.67	-25.33	74	38.24	35.17	4.58	29.32	100	200	Peak

**Note:** Other harmonics are lower than background noise.





<b>Test Mode :</b>	3Mbps	<b>Temperature :</b>	23~24°C
<b>Test Channel :</b>	39	<b>Relative Humidity :</b>	43~44%
<b>Test Engineer :</b>	Stone Gu	<b>Polarization :</b>	Horizontal
<b>Remark :</b>	1. 2441 MHz is fundamental signal which can be ignored. 2. Average measurement was not performed if peak level went lower than the average limit.		

Frequency ( MHz )	Level ( dBμV/m )	Over Limit ( dB )	Limit Line ( dBμV/m )	Read Level (dBμV)	Antenna Factor ( dB )	Cable Loss ( dB )	Preamp Factor ( dB )	Ant Pos ( cm )	Table Pos ( deg )	Remark
2441	103.24	-	-	97.72	32.95	3.2	30.63	100	59	Peak
2441	78.42	-	-	-	-	-	-	100	59	Average
4882	48.78	-25.22	74	38.32	35.18	4.6	29.32	200	0	Peak
7324	48.09	-25.91	74	36.43	36.21	5.64	30.19	100	0	Peak

**Note:** Other harmonics are lower than background noise.

<b>Test Mode :</b>	3Mbps	<b>Temperature :</b>	23~24°C
<b>Test Channel :</b>	39	<b>Relative Humidity :</b>	43~44%
<b>Test Engineer :</b>	Stone Gu	<b>Polarization :</b>	Vertical
<b>Remark :</b>	1. 2441 MHz is fundamental signal which can be ignored. 2. Average measurement was not performed if peak level went lower than the average limit.		

Frequency ( MHz )	Level ( dBμV/m )	Over Limit ( dB )	Limit Line ( dBμV/m )	Read Level (dBμV)	Antenna Factor ( dB )	Cable Loss ( dB )	Preamp Factor ( dB )	Ant Pos ( cm )	Table Pos ( deg )	Remark
2441	100.38	-	-	94.86	32.95	3.2	30.63	100	280	Peak
2441	75.56	-	-	-	-	-	-	100	280	Average
4882	48.02	-25.98	74	37.56	35.18	4.6	29.32	100	208	Peak
7324	46.7	-27.3	74	35.04	36.21	5.64	30.19	200	49	Peak

**Note:** Other harmonics are lower than background noise.



<b>Test Mode :</b>	3Mbps	<b>Temperature :</b>	23~24°C
<b>Test Channel :</b>	78	<b>Relative Humidity :</b>	43~44%
<b>Test Engineer :</b>	Stone Gu	<b>Polarization :</b>	Horizontal
<b>Remark :</b>	1. 2480 MHz is fundamental signal which can be ignored. 2. Average measurement was not performed if peak level went lower than the average limit.		

Frequency ( MHz )	Level ( dBμV/m )	Over Limit ( dB )	Limit Line ( dBμV/m )	Read Level (dBμV)	Antenna Factor ( dB )	Cable Loss ( dB )	Preamp Factor ( dB )	Ant Pos ( cm )	Table Pos ( deg )	Remark
109.54	26.07	-17.43	43.5	46.9	11.8	0.98	33.61	-	-	Peak
166.77	29.31	-14.19	43.5	52.38	9.31	1.19	33.57	120	0	Peak
205.57	23.44	-20.06	43.5	46.41	9.25	1.33	33.55	-	-	Peak
469.41	23.31	-22.69	46	37.9	16.61	1.98	33.18	-	-	Peak
940.83	31.38	-14.62	46	40.32	20.69	2.81	32.44	-	-	Peak
960.23	31.57	-22.43	54	40.39	20.79	2.83	32.44	-	-	Peak
2480	103.68	-	-	98.05	33.01	3.22	30.6	100	59	Peak
2480	78.86	-	-	-	-	-	-	100	59	Average
4960	47.71	-26.29	74	37.2	35.2	4.62	29.31	100	0	Peak
7440	49.1	-24.9	74	37.4	36.27	5.67	30.24	100	260	Peak

**Note:** Other harmonics are lower than background noise.



<b>Test Mode :</b>	3Mbps	<b>Temperature :</b>	23~24°C
<b>Test Channel :</b>	78	<b>Relative Humidity :</b>	43~44%
<b>Test Engineer :</b>	Stone Gu	<b>Polarization :</b>	Vertical
<b>Remark :</b>	1. 2480 MHz is fundamental signal which can be ignored. 2. Average measurement was not performed if peak level went lower than the average limit.		

Frequency ( MHz )	Level ( dBμV/m )	Over Limit ( dB )	Limit Line ( dBμV/m )	Read Level (dBμV)	Antenna Factor ( dB )	Cable Loss ( dB )	Preamp Factor ( dB )	Ant Pos ( cm )	Table Pos ( deg )	Remark
32.91	25.24	-14.76	40	42.27	16.04	0.52	33.59	200	0	Peak
48.43	23.57	-16.43	40	48.39	8.12	0.65	33.59	-	-	Peak
100.81	25.1	-18.4	43.5	47.16	10.62	0.93	33.61	-	-	Peak
128.94	23.49	-20.01	43.5	44.33	11.71	1.04	33.59	-	-	Peak
225.94	23.6	-22.4	46	45.13	10.59	1.38	33.5	-	-	Peak
936.95	28.52	-17.48	46	37.49	20.67	2.8	32.44	-	-	Peak
2480	100.29	-	-	94.66	33.01	3.22	30.6	100	271	Peak
2480	75.47	-	-	-	-	-	-	100	271	Average
4960	48.27	-25.73	74	37.76	35.2	4.62	29.31	200	300	Peak
7440	47.9	-26.1	74	36.2	36.27	5.67	30.24	200	100	Peak

**Note:** Other harmonics are lower than background noise.

### 3.9 AC Conducted Emission Measurement

#### 3.9.1 Limit of AC Conducted Emission

For equipment that is designed to be connected to the public utility (AC) power line, the radio frequency voltage that is conducted back onto the AC power line on any frequency or frequencies within the band 150 kHz to 30 MHz shall not exceed the limits in the following table.

Frequency of emission (MHz)	Conducted limit (dB $\mu$ V)	
	Quasi-peak	Average
0.15-0.5	66 to 56*	56 to 46*
0.5-5	56	46
5-30	60	50

\*Decreases with the logarithm of the frequency.

#### 3.9.2 Measuring Instruments

The measuring equipment is listed in the section 4 of this test report.

#### 3.9.3 Test Procedures

1. The EUT was placed 0.4 meter from the conducting wall of the shielding room was kept at least 80 centimeters from any other grounded conducting surface.
2. Connect EUT to the power mains through a line impedance stabilization network (LISN).
3. All the support units are connecting to the other LISN.
4. The LISN provides 50 ohm coupling impedance for the measuring instrument.
5. The FCC states that a 50 ohm, 50 microhenry LISN should be used.
6. Both sides of AC line were checked for maximum conducted interference.
7. The frequency range from 150 kHz to 30 MHz was searched.
8. Set the test-receiver system to Peak Detect Function and specified bandwidth with Maximum Hold Mode.

### 3.9.4 Test Setup

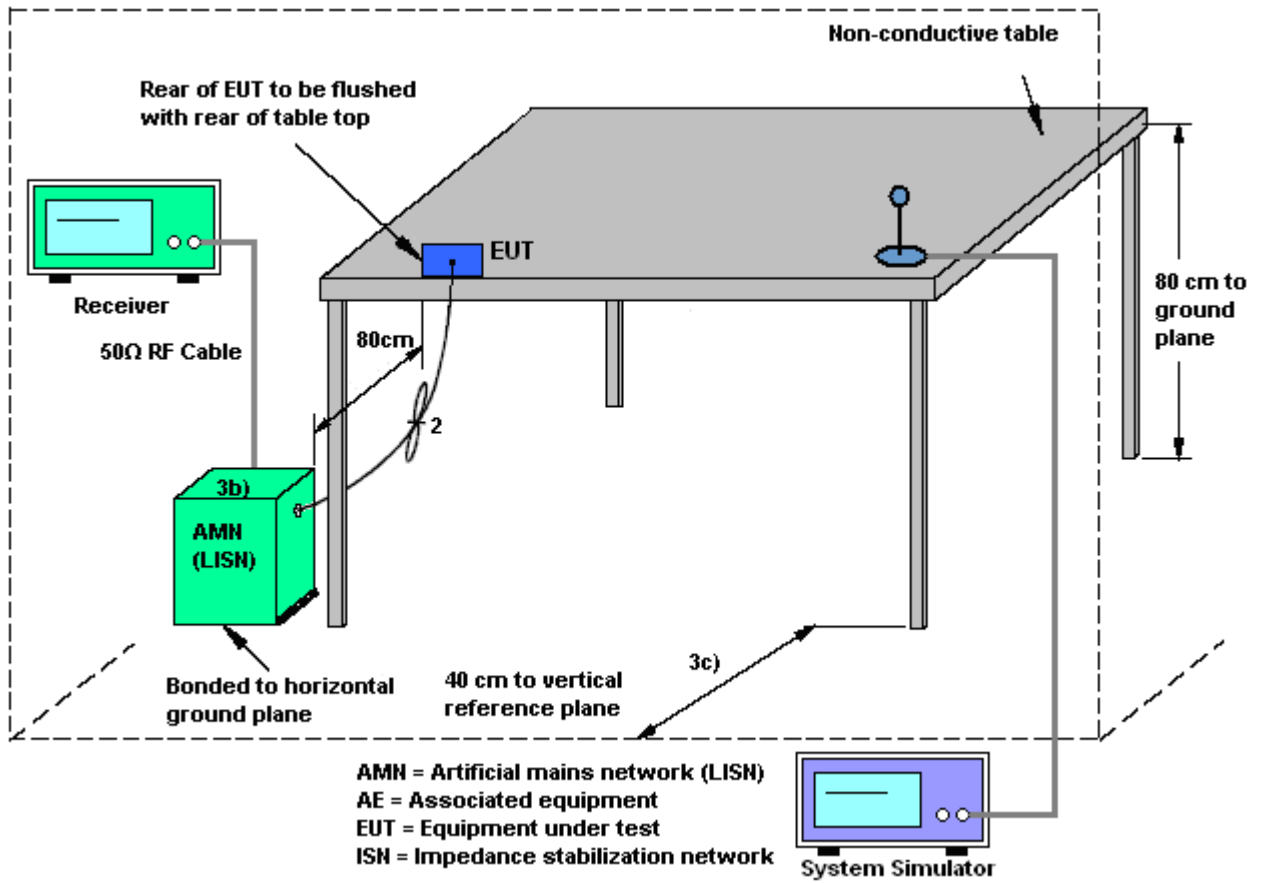



3.9.5 Test Result of AC Conducted Emission

Test Mode :	Mode 1	Temperature :	21~23°C
Test Engineer :	Hawey Tang	Relative Humidity :	51~53%
Test Voltage :	120Vac / 60Hz	Phase :	Line
Function Type :	GSM850 Idle + Bluetooth Link + WLAN Link + Earphone + USB Cable (Charging from Adapter)		

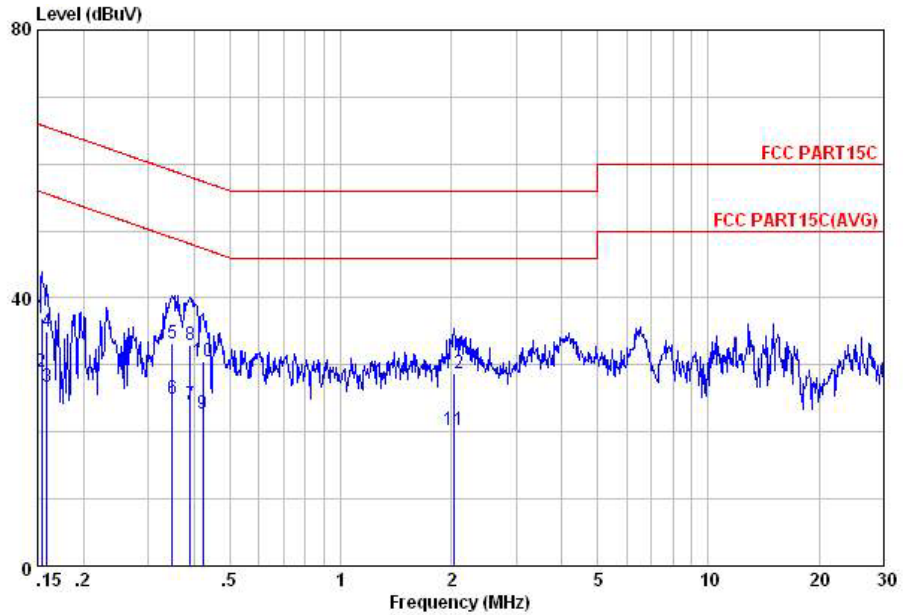

Site : C001-KS  
 Condition: FCC PART15C LISN-L20130306 LINE

mode : Mode 1

	Freq	Level	Over	Limit	Read	LISN	Cable	Remark
	MHz	dBuV	Limit	Line	Level	Factor	Loss	
			dB	dBuV	dBuV	dB	dB	
1	0.15	36.99	-28.79	65.78	24.40	1.89	10.70	QP
2	0.15	28.99	-26.79	55.78	16.40	1.89	10.70	Average
3	0.16	26.78	-28.74	55.52	14.30	1.80	10.68	Average
4	0.16	34.98	-30.54	65.52	22.50	1.80	10.68	QP
5	0.35	33.26	-25.74	59.00	22.50	0.44	10.32	QP
6	0.35	25.06	-23.94	49.00	14.30	0.44	10.32	Average
7	0.39	24.03	-24.05	48.08	13.40	0.34	10.29	Average
8	0.39	32.93	-25.15	58.08	22.30	0.34	10.29	QP
9	0.42	22.76	-24.66	47.42	12.20	0.28	10.28	Average
10	0.42	30.56	-26.86	57.42	20.00	0.28	10.28	QP
11	2.03	20.19	-25.81	46.00	9.90	0.10	10.19	Average
12	2.03	28.79	-27.21	56.00	18.50	0.10	10.19	QP



Test Mode :	Mode 1	Temperature :	21~23°C
Test Engineer :	Hawey Tang	Relative Humidity :	51~53%
Test Voltage :	120Vac / 60Hz	Phase :	Neutral
Function Type :	GSM850 Idle + Bluetooth Link + WLAN Link + Earphone + USB Cable (Charging from Adapter)		

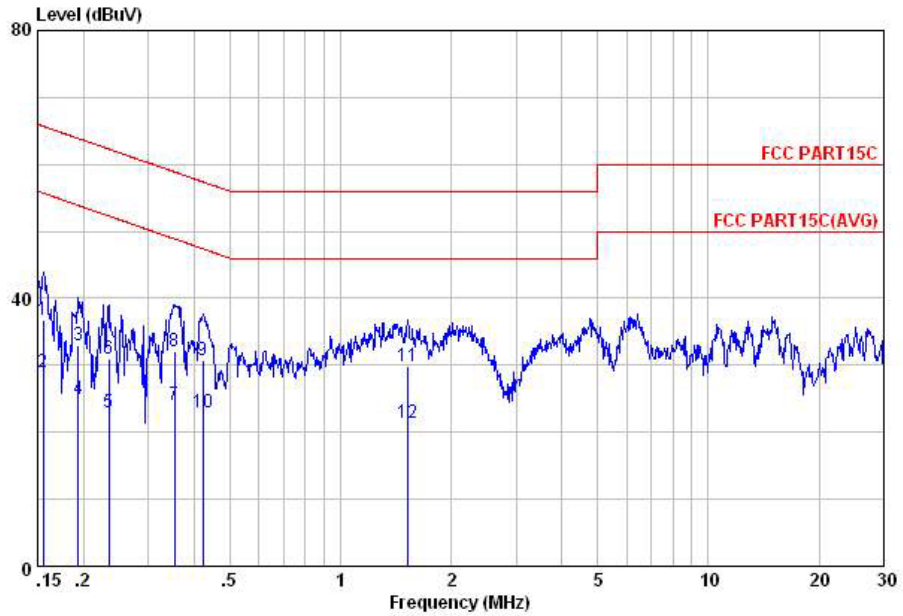

Site : C001-KS  
 Condition: FCC PART15C LISN-M20130306 NEUTRAL

mode : Mode 1

	Freq	Level	Over	Limit	Read	LISN	Cable	Remark
	MHz	dBuV	Limit	Line	Level	Factor	Loss	
			dB	dBuV	dBuV	dB	dB	
1	0.16	36.81	-28.88	65.69	24.30	1.82	10.69	QP
2	0.16	29.01	-26.68	55.69	16.50	1.82	10.69	Average
3	0.19	33.06	-30.83	63.89	21.40	1.07	10.59	QP
4	0.19	24.86	-29.03	53.89	13.20	1.07	10.59	Average
5	0.23	22.86	-29.44	52.30	11.40	0.93	10.53	Average
6	0.23	31.06	-31.24	62.30	19.60	0.93	10.53	QP
7	0.35	24.01	-24.86	48.87	13.19	0.50	10.32	Average
8	0.35	32.11	-26.76	58.87	21.29	0.50	10.32	QP
9	0.42	30.65	-26.77	57.42	20.00	0.37	10.28	QP
10	0.42	23.05	-24.37	47.42	12.40	0.37	10.28	Average
11	1.53	29.79	-26.21	56.00	19.50	0.10	10.19	QP
12	1.53	21.39	-24.61	46.00	11.10	0.10	10.19	Average



## **3.10 Antenna Requirements**

### **3.10.1 Standard Applicable**

If directional gain of transmitting antennas is greater than 6dBi, the power shall be reduced by the same level in dB comparing to gain minus 6dBi. The use of a permanently attached antenna or of an antenna that uses a unique coupling to the intentional radiator shall be considered sufficient to comply with the FCC rule.

### **3.10.2 Antenna Anti-Replacement Construction**

An embedded-in antenna design is used.

### **3.10.3 Antenna Gain**

The antenna peak gain of EUT is less than 6 dBi. Therefore, it is not necessary to reduce maximum peak output power limit.





## 4 List of Measuring Equipment

Instrument	Manufacturer	Model No.	Serial No.	Characteristics	Calibration Date	Test Date	Due Date	Remark
Spectrum Analyzer	R&S	FSP40	100319	9kHz~40GHz	Dec. 29, 2012	Nov. 25, 2013	Dec. 28, 2013	Conducted (TH01-KS)
Pulse Power Sensor	Anritsu	MA2411B	0917070	N/A	Feb. 28, 2013	Nov. 25, 2013	Feb. 27, 2014	Conducted (TH01-KS)
Power Meter	Anritsu	ML2495A	1005002	N/A	Feb. 28, 2013	Nov. 25, 2013	Feb. 27, 2014	Conducted (TH01-KS)
EMI Test Receiver	R&S	ESCI	100534	9kHz~3GHz	Nov. 07, 2013	Nov. 21, 2013	Nov. 06, 2014	Radiation (03CH01-KS)
Spectrum Analyzer	R&S	FSP30	101399	9kHz~30GHz	May 23, 2013	Nov. 21, 2013	May 22, 2014	Radiation (03CH01-KS)
Bilog Antenna	SCHAFFNER	CBL6112D	23182	25MHz~2GHz	Dec. 07, 2012	Nov. 21, 2013	Dec. 06, 2013	Radiation (03CH01-KS)
Loop Antenna	R&S	HFH2-Z2	100321	9kHz-30MHz	Oct. 21, 2013	Nov. 21, 2013	Oct. 20, 2014	Radiation (03CH01-KS)
Double Ridge Horn Antenna	EMCO	3117	75959	1GHz~18GHz	Dec. 07, 2012	Nov. 21, 2013	Dec. 06, 2013	Radiation (03CH01-KS)
Amplifier	com-power	PA-103A	161069	1MHz~1GHz	May 23, 2013	Nov. 21, 2013	May 22, 2014	Radiation (03CH01-KS)
Amplifier	Agilent	8449B	3008A02370	1GHz~26.5GHz	Dec. 29, 2012	Nov. 21, 2013	Dec. 28, 2013	Radiation (03CH01-KS)
Active Horn Antenna	com-power	AHA-118	701023	1GHz~18GHz	Nov. 06, 2013	Nov. 21, 2013	Nov. 05, 2014	Radiation (03CH01-KS)
SHF-EHF Horn	Schwarzbeck	BBHA 9170	BBHA170249	15GHz~40GHz	Nov. 23, 2012	Nov. 21, 2013	Nov. 22, 2013	Radiation (03CH01-KS)
Turn Table	MF	MF7802	N/A	0 ~ 360 degree	N/A	Nov. 21, 2013	N/A	Radiation (03CH01-KS)
Antenna Mast	MF	MF7802	N/A	1 m - 4 m	N/A	Nov. 21, 2013	N/A	Radiation (03CH01-KS)
EMI Receiver	R&S	ESCI7	100768	9kHz~7GHz	May 23, 2013	Nov. 25, 2013	May 22, 2014	Conduction (CO01-KS)
AC LISN	MessTec	AN3016	60103	9kHz~30MHz	Dec. 29, 2012	Nov. 25, 2013	Dec. 28, 2013	Conduction (CO01-KS)
AC LISN (for auxiliary equipment)	MessTec	AN3016	60105	9kHz~30MHz	Dec. 29, 2012	Nov. 25, 2013	Dec. 28, 2013	Conduction (CO01-KS)
AC Power Source	Chroma	61602	ABP0000008 11	N/A	Nov. 14, 2013	Nov. 25, 2013	Nov. 13, 2014	Conduction (CO01-KS)



## 5 Uncertainty of Evaluation

### Uncertainty of Conducted Emission Measurement (150 kHz ~ 30 MHz)

Measuring Uncertainty for a Level of Confidence of 95% ( $U = 2Uc(y)$ )	2.26
---	------

### Uncertainty of Radiated Emission Measurement (30 MHz ~ 1000 MHz)

Measuring Uncertainty for a Level of Confidence of 95% ( $U = 2Uc(y)$ )	2.54
---	------