



FCC RF Test Report

APPLICANT : Acer Incorporated
EQUIPMENT : Smart HandHeld
BRAND NAME : Acer
MODEL NAME : E320
FCC ID : HLZDME320
STANDARD : FCC Part 15 Subpart C §15.247
CLASSIFICATION : Digital Transmission System (DTS)

The product was received on Jul. 28, 2011 and completely tested on Aug. 12, 2011. We, SPORTON INTERNATIONAL INC., would like to declare that the tested sample has been evaluated in accordance with the procedures given in ANSI C63.4-2003 and shown the compliance with the applicable technical standards.

The test results in this report apply exclusively to the tested model / sample. Without written approval of SPORTON INTERNATIONAL INC., the test report shall not be reproduced except in full.

Reviewed by:

Jones Tsai / Manager



SPORTON INTERNATIONAL INC.

No. 52, Hwa Ya 1st Rd., Hwa Ya Technology Park, Kwei-Shan Hsiang, Tao Yuan Hsien, Taiwan, R.O.C.



TABLE OF CONTENTS

REVISION HISTORY 3

SUMMARY OF TEST RESULT 4

1 GENERAL DESCRIPTION 5

 1.1 Applicant 5

 1.2 Manufacturer 5

 1.3 Feature of Equipment Under Test 5

 1.4 Testing Site 6

 1.5 Applied Standards 6

 1.6 Ancillary Equipment List 6

2 TEST CONFIGURATION OF EQUIPMENT UNDER TEST 7

 2.1 RF Power 7

 2.2 Test Mode 9

 2.3 Connection Diagram of Test System 10

 2.4 RF Utility 11

3 TEST RESULT 12

 3.1 6dB and 99% Bandwidth Measurement 12

 3.2 Output Power Measurement 25

 3.3 Band Edges Measurement 27

 3.4 Spurious Emission Measurement 35

 3.5 Power Spectral Density Measurement 45

 3.6 AC Conducted Emission Measurement 52

 3.7 Radiated Emission Measurement 56

 3.8 Antenna Requirements 77

4 LIST OF MEASURING EQUIPMENT 78

5 UNCERTAINTY OF EVALUATION 79

APPENDIX A. PHOTOGRAPHS OF EUT

APPENDIX B. SETUP PHOTOGRAPHS



REVISION HISTORY

REPORT NO.	VERSION	DESCRIPTION	ISSUED DATE
FR172802-02B	Rev. 01	Initial issue of report	Aug. 29, 2011

SUMMARY OF TEST RESULT

Report Section	FCC Rule	IC Rule	Description	Limit	Result	Remark
3.1	15.247(a)(2)	A8.2(a)	6dB Bandwidth	$\geq 0.5\text{MHz}$	Pass	-
3.1	-	Gen 4.4.1	99% Bandwidth	-	Pass	-
3.2	15.247(b)	A8.4	Power Output	$\leq 30\text{dBm}$	Pass	-
3.3	15.247(d)	A8.5	Frequency Band Edges	$\leq 20\text{dBc}$	Pass	-
3.4	15.247(d)	A8.5	Spurious Emission	$< 20\text{ dBc}$	Pass	-
3.5	15.247(e)	A8.2(b)	Power Spectral Density	$\leq 8\text{dBm}$	Pass	-
3.6	15.207	Gen 7.2.2	AC Conducted Emission	15.207(a)	Pass	Under limit 17.1 dB at 0.28 MHz
3.7	15.247(d)	A8.5	Transmitter Radiated Emission	15.209(a) & 15.247(d)	Pass	Under limit 3.22 dB at 2483.66 MHz
3.8	15.203 & 15.247(b)	A8.4	Antenna Requirement	N/A	Pass	-



1 General Description

1.1 Applicant

Acer Incorporated

8F., No. 88, Sec. 1, Xintai 5th. Rd., Xizhi Dist., New Taipei City 22181, Taiwan (R.O.C)

1.2 Manufacturer

COMPAL COMMUNICATIONS(NANJING) CO., LTD.

No. 68-2, Suyuan Road, Nanjing Export Processing Zone (South Area), P.R China

1.3 Feature of Equipment Under Test

Product Feature & Specification	
Equipment	Smart HandHeld
Brand Name	Acer
Model Name	E320
FCC ID	HLZDME320
Tx/Rx Frequency Range	2400 MHz ~ 2483.5 MHz
Number of Channels	11
Carrier Frequency of Each Channel	2412+(n-1)*5 MHz; n=1~11
Channel Spacing	5 MHz
Maximum Output Power to Antenna	802.11b : 18.82 dBm (0.0762 W) 802.11g : 23.68 dBm (0.2333 W) 802.11n (BW 20MHz) : 22.88 dBm (0.1941 W)
Antenna Type	PIFA Antenna with gain 1.4 dBi
Type of Modulation	802.11b : DSSS (BPSK / QPSK / CCK) 802.11g/n : OFDM (BPSK / QPSK / 16QAM / 64QAM)
EUT Stage	Identical Prototype

Remark:

1. For other wireless features of this EUT, test report will be issued separately.
2. This test report recorded only product characteristics and test results of Digital Transmission System (DTS).
3. The above EUT's information was declared by manufacturer. Please refer to the specifications or user's manual for more detailed description.

1.4 Testing Site

Test Site	SPORTON INTERNATIONAL INC.		
Test Site Location	No. 52, Hwa Ya 1 st Rd., Hwa Ya Technology Park, Kwei-Shan Hsiang, Tao Yuan Hsien, Taiwan, R.O.C. TEL: +886-3-3273456 / FAX: +886-3-3284978		
Test Site No.	Sporton Site No.		FCC/IC Registration No.
	CO05-HY	03CH06-HY	722060/4086B-1

1.5 Applied Standards

According to the specifications of the manufacturer, the EUT must comply with the requirements of the following standards:

- ♦ FCC Part 15 Subpart C §15.247
- ♦ FCC KDB Publication No. 558074 (Measurement Guidelines of DTS)
- ♦ ANSI C63.4-2003
- ♦ IC RSS-210 Issue 8

Remark:

1. All test items were verified and recorded according to the standards and without any deviation during the test.
2. This EUT has also been tested and complied with the requirements of FCC Part 15, Subpart B (DoC), recorded in a separate test report.

1.6 Ancillary Equipment List

Item	Equipment	Trade Name	Model Name	FCC ID	Data Cable	Power Cord
1.	System Simulator	R&S	CMU 200	N/A	N/A	Unshielded, 1.8 m
2.	GPS Station	T&E	GS-50	N/A	N/A	Unshielded, 1.8 m
3.	WLAN AP	D-Link	DIR-628	KA2DIR628A2	N/A	Unshielded, 1.8 m
4.	Notebook	DELL	Vostro 1510	FCC DoC	N/A	AC I/P: Unshielded, 1.2 m DC O/P: Shielded, 1.8 m
5.	Bluetooth Earphone	Nokia	BH-102	PYAHS-107W	N/A	N/A

2 Test Configuration of Equipment Under Test

2.1 RF Power

Preliminary tests were performed in different data rate and recorded the RF power output in the following table:

<Peak Power>

Channel	Frequency	2.4GHz 802.11b RF Power (dBm)			
		DSSS Data Rate			
		1 Mbps	2 Mbps	5.5 Mbps	11 Mbps
CH 01	2412 MHz	18.82	18.8	18.81	18.76
CH 06	2437 MHz	18.34	-	-	-
CH 11	2462 MHz	17.97	-	-	-

Channel	Frequency	2.4GHz 802.11g RF Power (dBm)							
		OFDM Data Rate							
		6 Mbps	9 Mbps	12 Mbps	18 Mbps	24 Mbps	36 Mbps	48 Mbps	54 Mbps
CH 01	2412 MHz	23.19	-	-	-	-	-	-	-
CH 06	2437 MHz	23.68	23.53	23.48	23.51	23.47	23.67	23.56	23.65
CH 11	2462 MHz	22.72	-	-	-	-	-	-	-

Channel	Frequency	2.4GHz 802.11n (BW 20MHz) RF Power (dBm)							
		OFDM Data Rate							
		MCS=0	MCS=1	MCS=2	MCS=3	MCS=4	MCS=5	MCS=6	MCS=7
		6.5 Mbps	13 Mbps	19.5 Mbps	26 Mbps	39 Mbps	52 Mbps	58.5 Mbps	65 Mbps
CH 01	2412 MHz	22.78	-	-	-	-	-	-	-
CH 06	2437 MHz	22.88	22.65	22.53	22.36	22.48	22.06	22.49	22.26
CH 11	2462 MHz	21.77	-	-	-	-	-	-	-

<Average Power>

Channel	Frequency	2.4GHz 802.11b RF Power (dBm)			
		DSSS Data Rate			
		1 Mbps	2 Mbps	5.5 Mbps	11 Mbps
CH 01	2412 MHz	15.79	15.73	15.77	15.29
CH 06	2437 MHz	15.37	-	-	-
CH 11	2462 MHz	15.07	-	-	-

Channel	Frequency	2.4GHz 802.11g RF Power (dBm)							
		OFDM Data Rate							
		6 Mbps	9 Mbps	12 Mbps	18 Mbps	24 Mbps	36 Mbps	48 Mbps	54 Mbps
CH 01	2412 MHz	12.24	-	-	-	-	-	-	-
CH 06	2437 MHz	13.77	13.59	13.53	13.27	13.09	12.85	12.66	12.23
CH 11	2462 MHz	11.73	-	-	-	-	-	-	-

Channel	Frequency	2.4GHz 802.11n (BW 20MHz) RF Power (dBm)							
		OFDM Data Rate							
		MCS=0 6.5 Mbps	MCS=1 13 Mbps	MCS=2 19.5 Mbps	MCS=3 26 Mbps	MCS=4 39 Mbps	MCS=5 52 Mbps	MCS=6 58.5 Mbps	MCS=7 65 Mbps
CH 01	2412 MHz	11.58	-	-	-	-	-	-	-
CH 06	2437 MHz	11.68	11.52	11.44	11.24	10.94	10.68	10.51	10.24
CH 11	2462 MHz	10.74	-	-	-	-	-	-	-

Remark:

1. The data rates of WLAN 802.11b/g/n were set in 1Mbps for 802.11b, 6Mbps for 802.11g, and 6.5Mbps for 802.11n (BW 20MHz) for all the test cases due to the highest RF output power.
2. The EUT is programmed to transmit signals continuously for all testing.
3. Pre-scan has been conducted to determine the worst-case mode from all possible combinations between available modulations, data rates and antenna ports.

2.2 Test Mode

The EUT has been associated with peripherals pursuant to ANSI C63.4-2003 and configuration operated in a manner tended to maximize its emission characteristics in a typical application. Frequency range investigated: conducted emission (150 kHz to 30 MHz), radiated emission (30 MHz to the 10th harmonic of the highest fundamental frequency or to 40 GHz, whichever is lower).

Pre-scanned tests, X, Y, Z in three orthogonal panels, were conducted to determine the final configuration from all possible combinations, laptop / tablet modes.

The following tables are showing the test modes as the worst cases and recorded in this report.

Test Cases		
Test Item	802.11b (Modulation : DSSS)	802.11g/n (Modulation : OFDM)
Conducted TCs	Mode 1 : 802.11b CH01_2412 MHz Mode 2 : 802.11b CH06_2437 MHz Mode 3 : 802.11b CH11_2462 MHz	Mode 4: 802.11g_CH01_2412 MHz Mode 5: 802.11g_CH06_2437 MHz Mode 6: 802.11g_CH11_2462 MHz Mode 7: 802.11n (BW 20M)_CH01_2412 MHz Mode 8: 802.11n (BW 20M)_CH06_2437 MHz Mode 9: 802.11n (BW 20M)_CH11_2462 MHz
Radiated TCs	Mode 1 : 802.11b CH01_2412 MHz Mode 2 : 802.11b CH06_2437 MHz Mode 3 : 802.11b CH11_2462 MHz	Mode 4: 802.11g_CH01_2412 MHz Mode 5: 802.11g_CH06_2437 MHz Mode 6: 802.11g_CH11_2462 MHz Mode 7: 802.11n (BW 20M)_CH01_2412 MHz Mode 8: 802.11n (BW 20M)_CH06_2437 MHz Mode 9: 802.11n (BW 20M)_CH11_2462 MHz
AC Conducted Emission	Mode 1 : GSM850 Idle + Bluetooth Link + WLAN Link (2.4G) + GPS Rx + Earphone + Battery + USB Cable (Charging from Adapter)	

2.3 Connection Diagram of Test System

<WLAN Tx Mode>

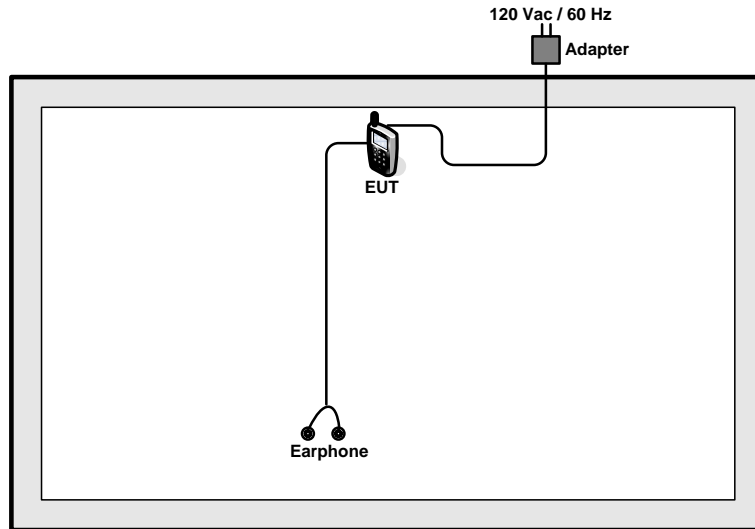

<AC Conducted Emission Mode>

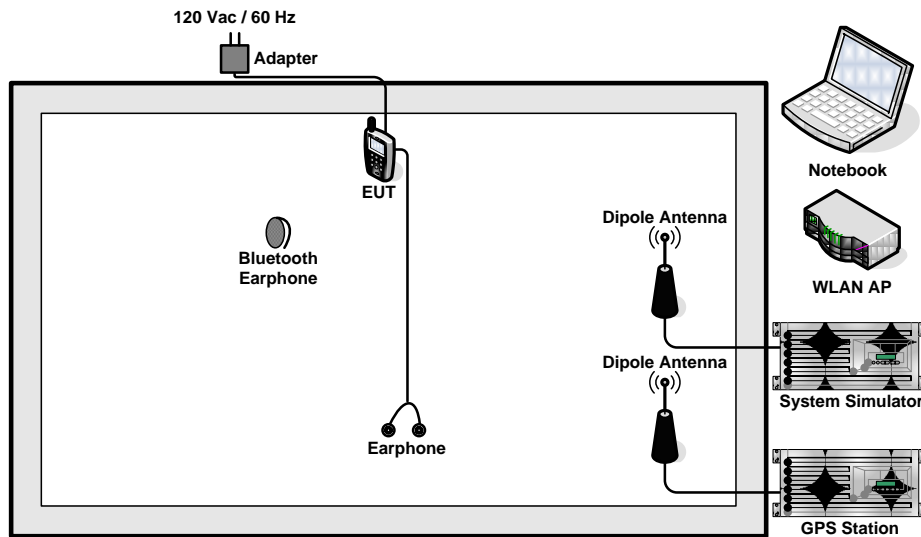



2.4 RF Utility

The programmed RF utility “ADB Command” is installed in EUT to provide channel selection, power level, data rate and the application type. RF Utility can send transmitting signal for all testing. The RF output power selection is for the setting of RF output power expected by the customer and is going to be fixed on the firmware of the final end product.

3 Test Result

3.1 6dB and 99% Bandwidth Measurement

3.1.1 Limit of 6dB Bandwidth

The minimum 6 dB bandwidth shall be at least 500 kHz.

3.1.2 Measuring Instruments

See list of measuring instruments of this test report.

3.1.3 Test Procedures

1. The testing follows FCC KDB Publication No. 558074 (Measurement Guidelines of DTS).
2. The RF output of EUT was connected to the spectrum analyzer by a low loss cable.
3. Make the measurement with the spectrum analyzer's resolution bandwidth (RBW) = 100 kHz.
In order to make an accurate measurement, set the span greater than RBW. The 6 dB bandwidth must be greater than 500 kHz.
4. The marker-delta reading at this point is the 6 dB bandwidth of the emission.

3.1.4 Test Setup

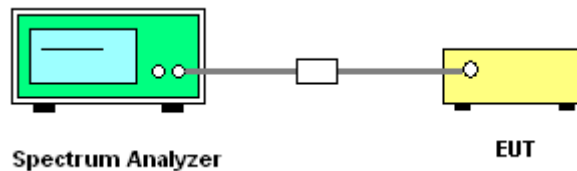



3.1.5 Test Result of 6dB Bandwidth

Test Mode :	Mode 1, 2, 3	Temperature :	24~26°C
Test Engineer :	Pinkston Tu	Relative Humidity :	50~52%

Channel	Frequency (MHz)	802.11b 6dB Bandwidth (MHz)	6dB Bandwidth Min. Limit (MHz)	Pass/Fail
01	2412	9.04	0.5	Pass
06	2437	9.04	0.5	Pass
11	2462	9.04	0.5	Pass

Mode 1 : 6 dB Bandwidth Plot on 802.11b Channel 01

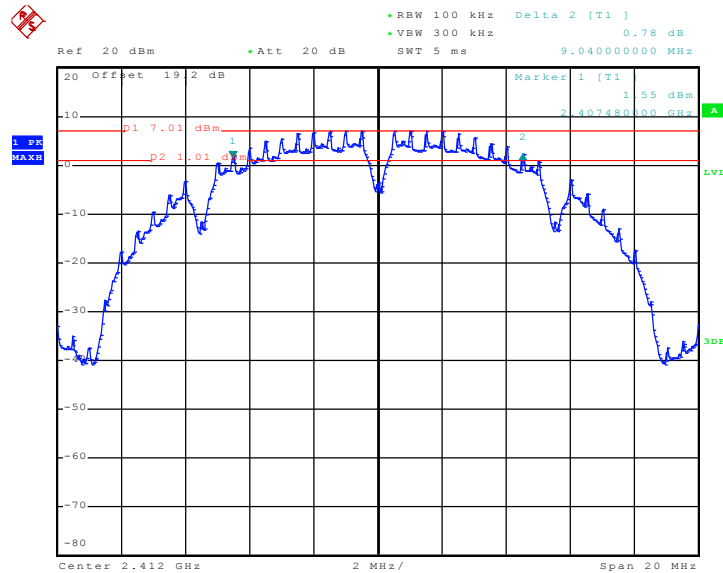

Date: 12.AUG.2011 14:46:26



Mode 2 : 6 dB Bandwidth Plot on 802.11b Channel 06

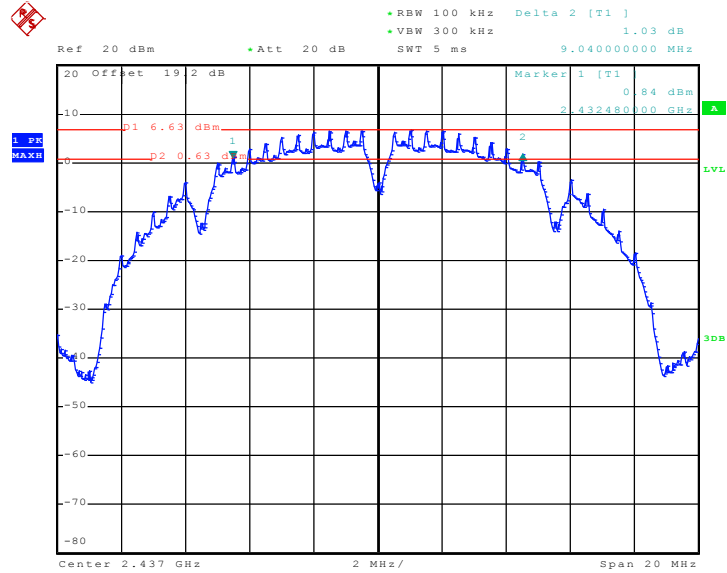

Date: 12.AUG.2011 15:35:11

Mode 3 : 6 dB Bandwidth Plot on 802.11b Channel 11

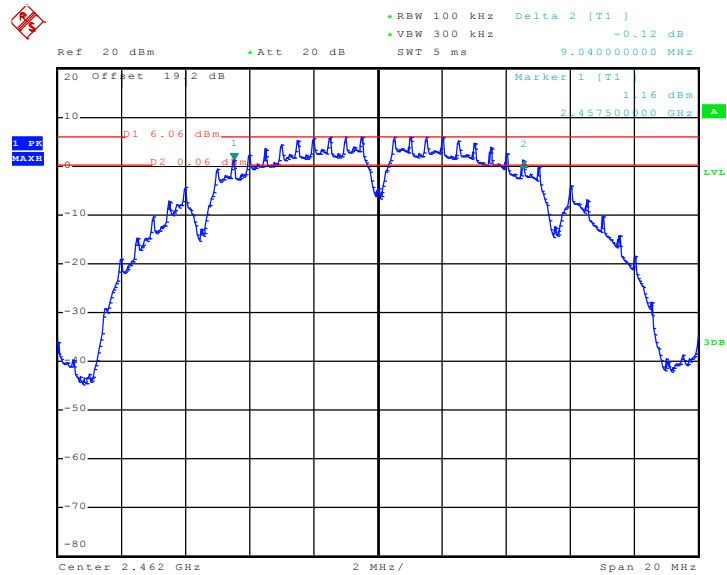

Date: 12.AUG.2011 15:39:38



Test Mode :	Mode 4, 5, 6	Temperature :	24~26°C
Test Engineer :	Pinkston Tu	Relative Humidity :	50~52%

Channel	Frequency (MHz)	802.11g 6dB Bandwidth (MHz)	6dB Bandwidth Min. Limit (MHz)	Pass/Fail
01	2412	15.12	0.5	Pass
06	2437	15.16	0.5	Pass
11	2462	15.14	0.5	Pass

Mode 4 : 6 dB Bandwidth Plot on 802.11g Channel 01

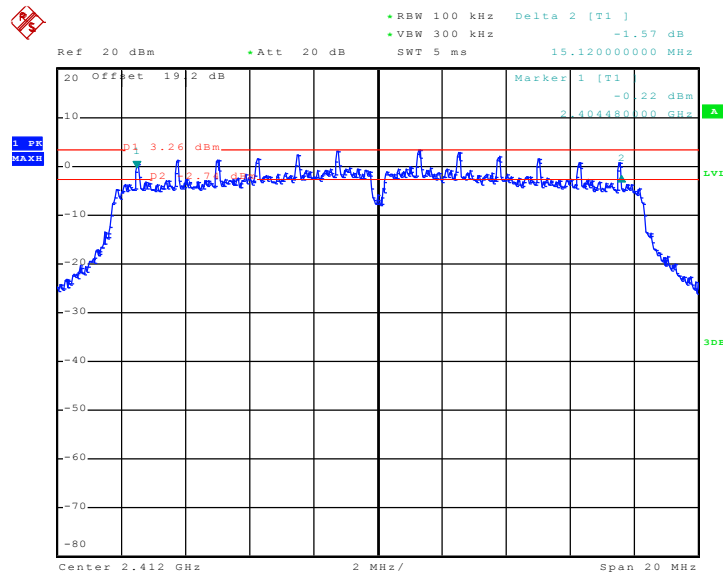

Date: 12.AUG.2011 15:56:55



Mode 5 : 6 dB Bandwidth Plot on 802.11g Channel 06

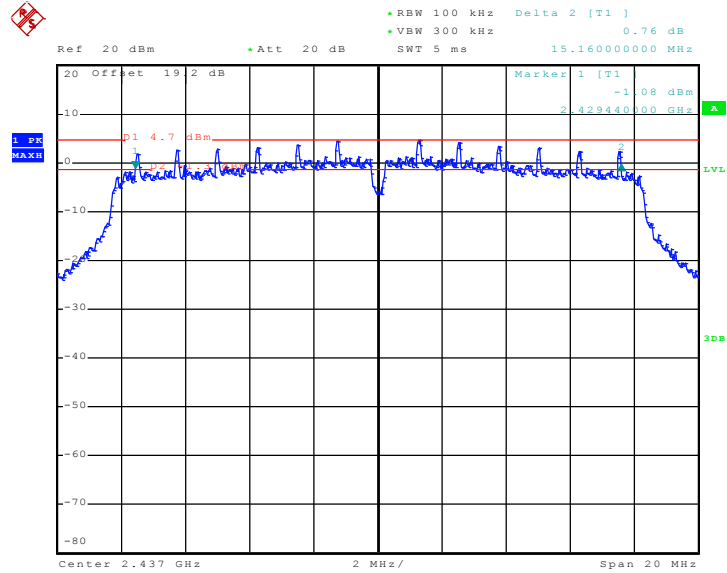

Date: 12.AUG.2011 16:13:52

Mode 6 : 6 dB Bandwidth Plot on 802.11g Channel 11

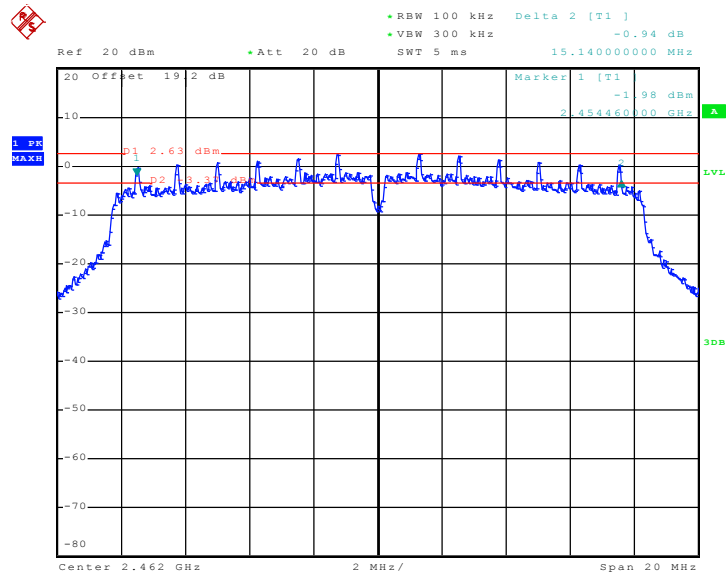

Date: 12.AUG.2011 16:28:33



Test Mode :	Mode 7, 8, 9	Temperature :	24~26°C
Test Engineer :	Pinkston Tu	Relative Humidity :	50~52%

Channel	Frequency (MHz)	802.11n (BW 20MHz) 6dB Bandwidth (MHz)	6dB Bandwidth Min. Limit (MHz)	Pass/Fail
01	2412	15.12	0.5	Pass
06	2437	15.12	0.5	Pass
11	2462	15.12	0.5	Pass

Mode 7 : 6 dB Bandwidth Plot on 802.11n(BW 20MHz) Channel 01

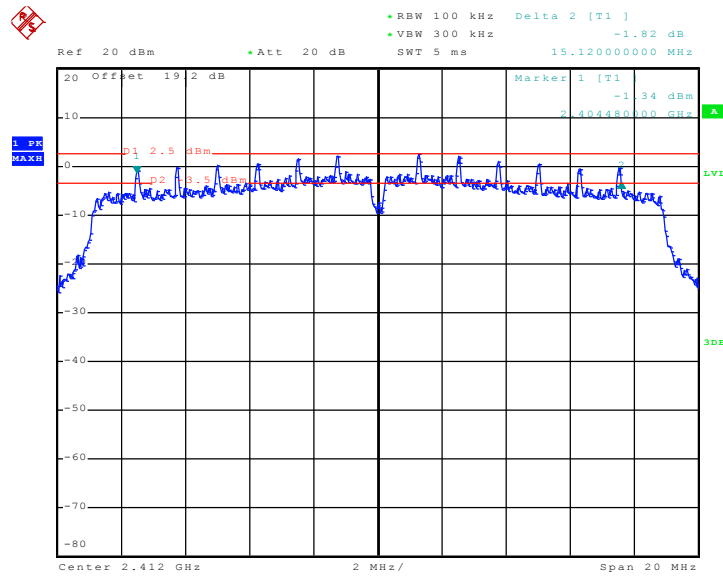

Date: 12.AUG.2011 16:45:46



Mode 8 : 6 dB Bandwidth Plot on 802.11n(BW 20MHz) Channel 06

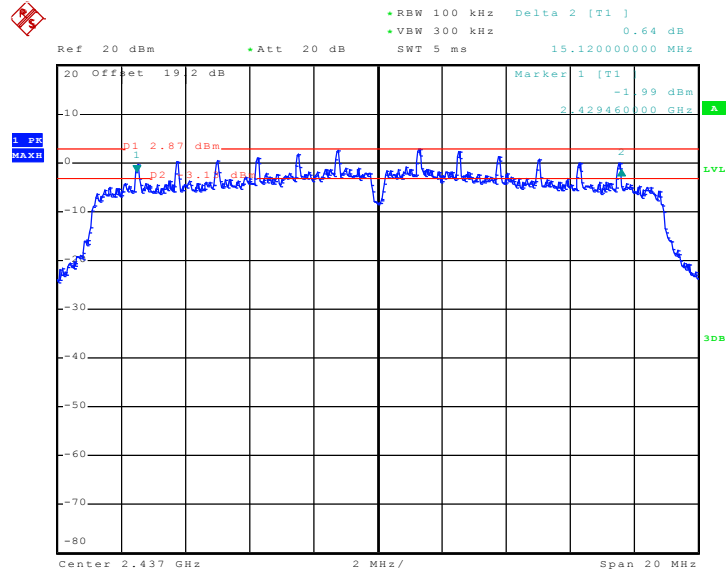

Date: 12.AUG.2011 17:08:14

Mode 9 : 6 dB Bandwidth Plot on 802.11n(BW 20MHz) Channel 11

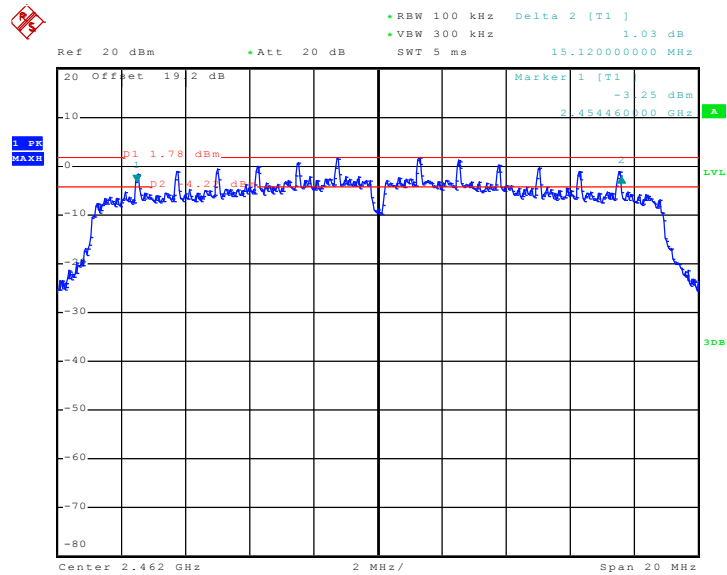

Date: 12.AUG.2011 17:22:04



3.1.6 Test Result of 99% Occupied Bandwidth

Test Mode :	Mode 1, 2, 3	Temperature :	24~26°C
Test Engineer :	Pinkston Tu	Relative Humidity :	50~52%

Channel	Frequency (MHz)	802.11b 99% Occupied Bandwidth (MHz)	Pass/Fail
01	2412	12.84	Pass
06	2437	12.76	Pass
11	2462	12.80	Pass

Mode 1 : 99% Occupied Bandwidth Plot on 802.11b Channel 01

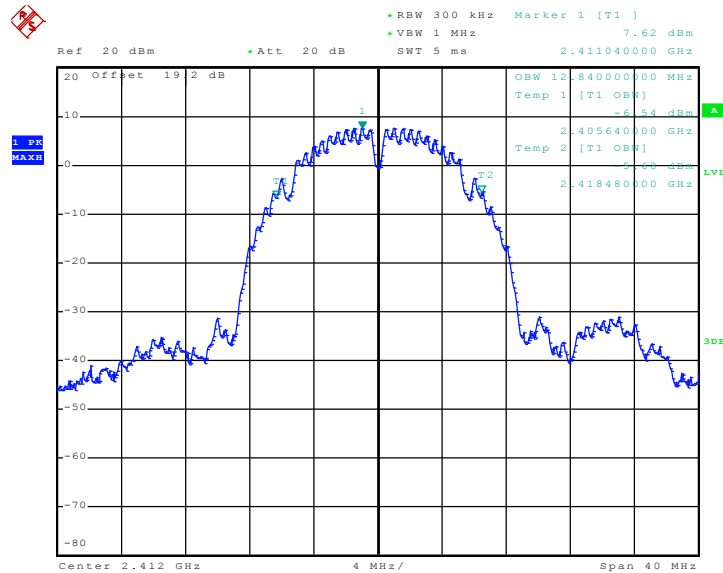

Date: 12.AUG.2011 14:48:06



Mode 2 : 99% Occupied Bandwidth Plot on 802.11b Channel 06

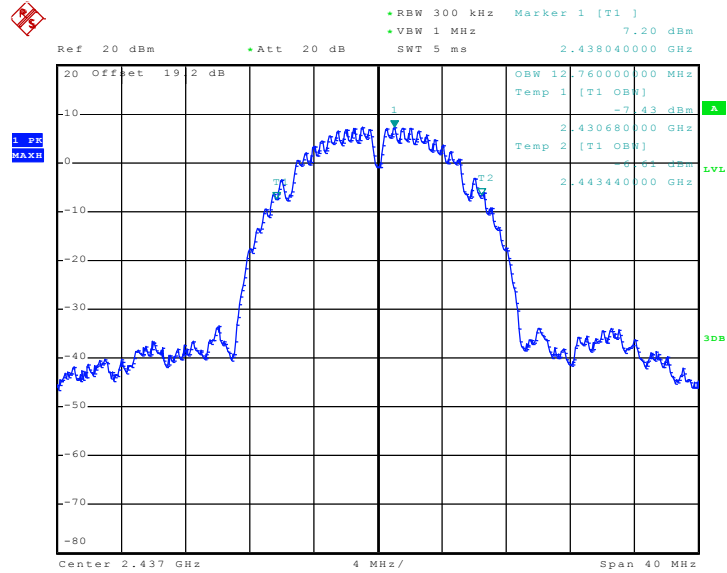

Date: 12.AUG.2011 15:35:38

Mode 3 : 99% Occupied Bandwidth Plot on 802.11b Channel 11

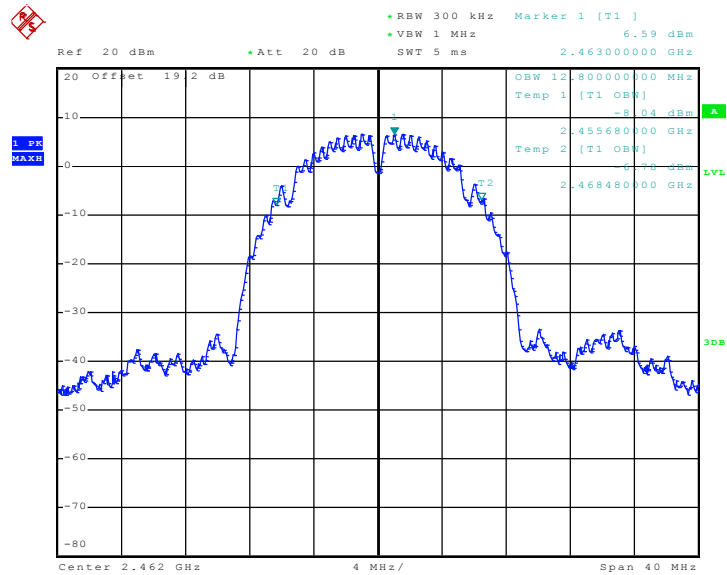

Date: 12.AUG.2011 15:40:53



Test Mode :	Mode 4, 5, 6	Temperature :	24~26°C
Test Engineer :	Pinkston Tu	Relative Humidity :	50~52%

Channel	Frequency (MHz)	802.11g 99% Occupied Bandwidth (MHz)	Pass/Fail
01	2412	16.88	Pass
06	2437	16.88	Pass
11	2462	16.84	Pass

Mode 4 : 99% Occupied Bandwidth Plot on 802.11g Channel 01

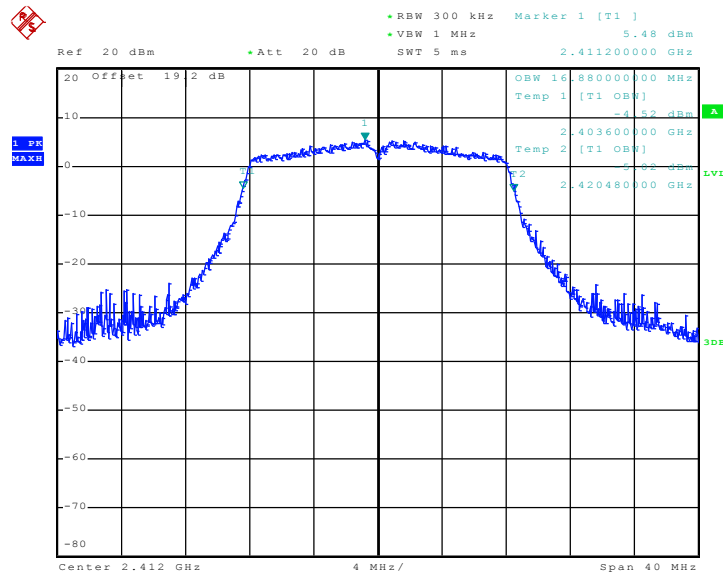

Date: 12.AUG.2011 15:58:34



Mode 5 : 99% Occupied Bandwidth Plot on 802.11g Channel 06

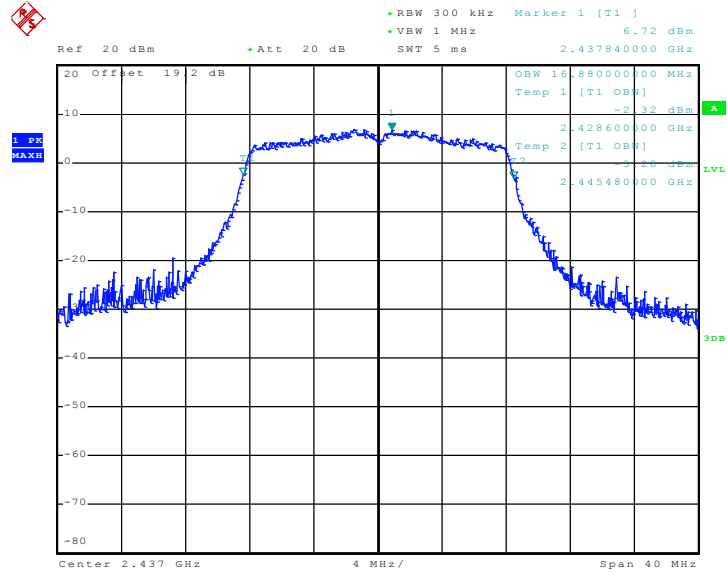

Date: 12.AUG.2011 16:14:24

Mode 6 : 99% Occupied Bandwidth Plot on 802.11g Channel 11

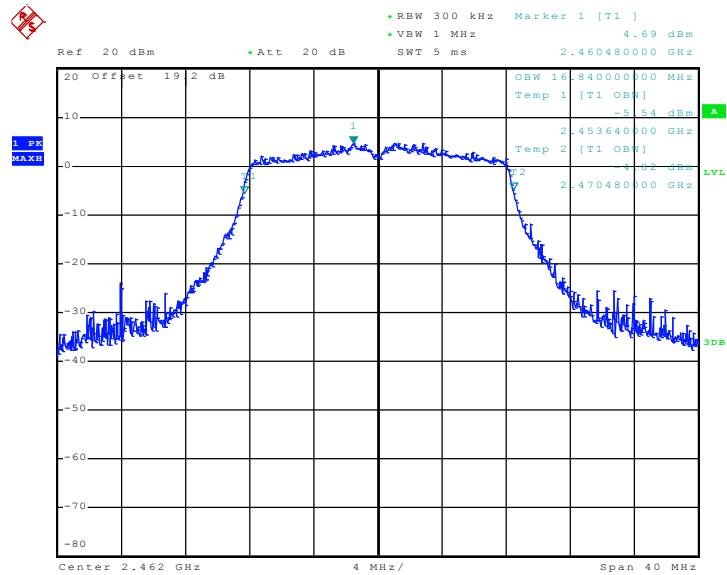

Date: 12.AUG.2011 16:29:49



Test Mode :	Mode 7, 8, 9	Temperature :	24~26°C
Test Engineer :	Pinkston Tu	Relative Humidity :	50~52%

Channel	Frequency (MHz)	802.11n (BW 20MHz) 99% Occupied Bandwidth (MHz)	Pass/Fail
01	2412	17.88	Pass
06	2437	17.96	Pass
11	2462	17.96	Pass

Mode 7 :

99% Occupied Bandwidth Plot on 802.11n(BW 20MHz) Channel 01

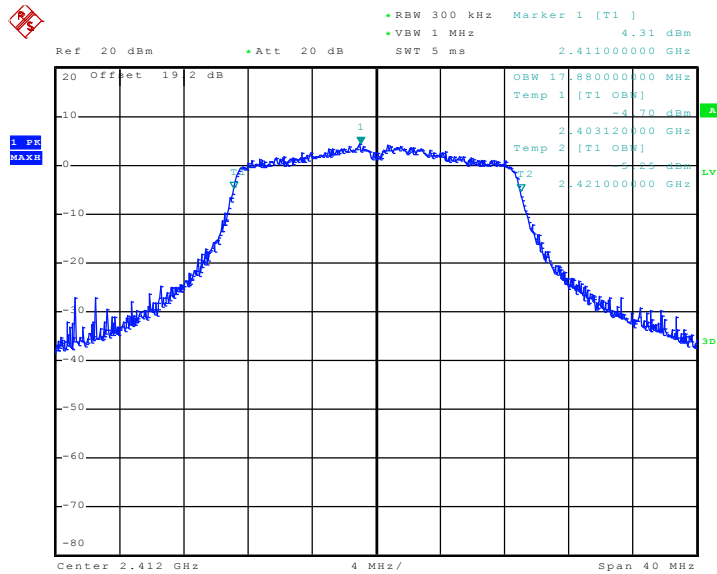

Date: 12.AUG.2011 16:47:25



Mode 8 :

99% Occupied Bandwidth Plot on 802.11n(BW 20MHz) Channel 06

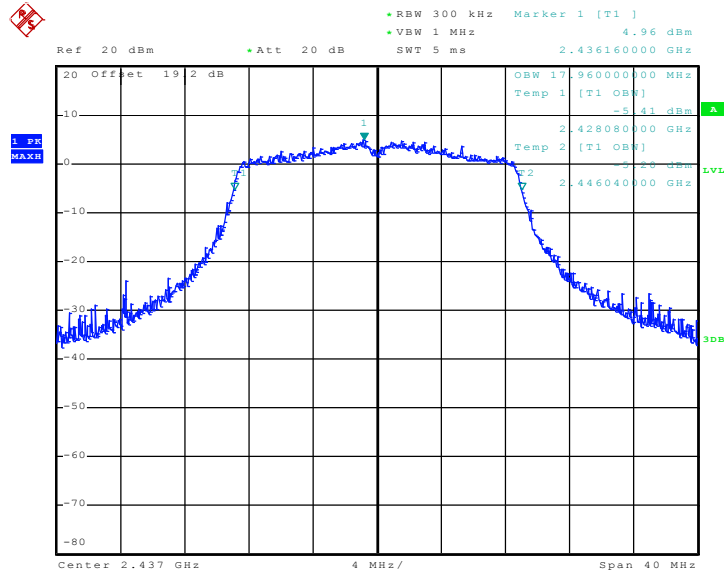

Date: 12.AUG.2011 17:08:41

Mode 9 :

99% Occupied Bandwidth Plot on 802.11n(BW 20MHz) Channel 11

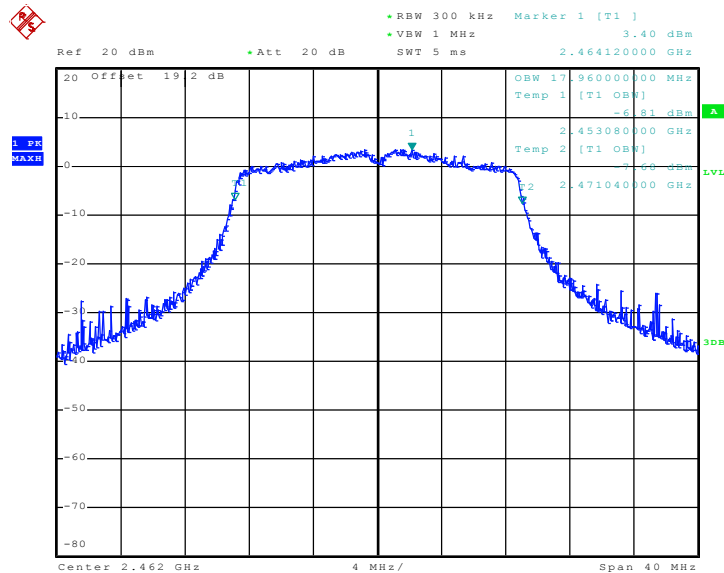

Date: 12.AUG.2011 17:23:19

3.2 Output Power Measurement

3.2.1 Limit of Output Power

For systems using digital modulation in the 2400-2483.5MHz, the limit for peak output power is 30dBm. If transmitting antenna of directional gain greater than 6dBi are used the peak output power from the intentional radiator shall be reduced below the above stated value by the amount in dB that the directional gain of the antenna exceeds 6 dBi. In case of point-to-point operation, the limit has to be reduced by 1dB for every 3dB that the directional gain of the antenna exceeds 6dBi.

3.2.2 Measuring Instruments

See list of measuring instruments of this test report.

3.2.3 Test Procedures

1. The testing follows FCC KDB Publication No. 558074 (Measurement Guidelines of DTS).
2. The RF output of EUT was connected to the power meter by a low loss cable.
3. Measure the power by power meter.

3.2.4 Test Setup

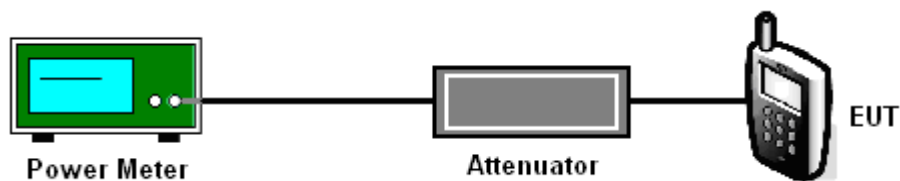



3.2.5 Test Result of Output Power

Test Mode :	Mode 1, 2, 3	Temperature :	24~26°C
Test Engineer :	Pinkston Tu	Relative Humidity :	50~52%

Channel	Frequency (MHz)	802.11b Measured Output Power (dBm)	Max. Limits (dBm)	Pass/Fail
01	2412	18.82	30	Pass
06	2437	18.34	30	Pass
11	2462	17.97	30	Pass

Test Mode :	Mode 4, 5, 6	Temperature :	24~26°C
Test Engineer :	Pinkston Tu	Relative Humidity :	50~52%

Channel	Frequency (MHz)	802.11g Measured Output Power (dBm)	Max. Limits (dBm)	Pass/Fail
01	2412	23.19	30	Pass
06	2437	23.68	30	Pass
11	2462	22.72	30	Pass

Test Mode :	Mode 7, 8, 9	Temperature :	24~26°C
Test Engineer :	Pinkston Tu	Relative Humidity :	50~52%

Channel	Frequency (MHz)	802.11n (BW 20MHz) Measured Output Power (dBm)	Max. Limits (dBm)	Pass/Fail
01	2412	22.78	30	Pass
06	2437	22.88	30	Pass
11	2462	21.77	30	Pass



3.3 Band Edges Measurement

3.3.1 Limit of Band Edges

In any 100 kHz bandwidth outside the intentional radiation frequency band, the radio frequency power shall be at least 20 dB below the highest level of the radiated power. If the output power of this device was measured by spectrum analyzer, the attenuation under this paragraph shall be 30 dB instead of 20 dB.

3.3.2 Measuring Instruments

See list of measuring instruments of this test report.

3.3.3 Test Procedures

1. The testing follows the guidelines in ANSI C63.4-2003 and FCC KDB Publication No. 558074 (Measurement Guidelines of DTS).
2. Conducted emission test: Set RBW = 100 kHz, Video bandwidth (VBW) \geq RBW. Band edge emissions must be at least 20 dB down from the highest emission level within the authorized band as measured with a 100 kHz RBW. Note: If the device complies with the use of power option 2 the attenuation under this paragraph shall be 30 dB instead of 20 dB.
3. Radiated emission test: Apply to band edge emissions that fall in the restricted bands listed in FCC Section 15.205. The maximum permitted average field strength is listed in FCC Section 15.209. A pre-amp is necessary for this measurement. For measurements above 1 GHz, set RBW = 1MHz, VBW = 10 Hz, Sweep=Auto. If the emission is pulsed, modify the unit for continuous operation; use the settings shown above, then correct the reading by subtracting the peak-average correction factor, derived from the appropriate duty cycle calculation as in FCC Section 15.35(b) and (c).

3.3.4 Test Setup

<Radiated Band Edges>

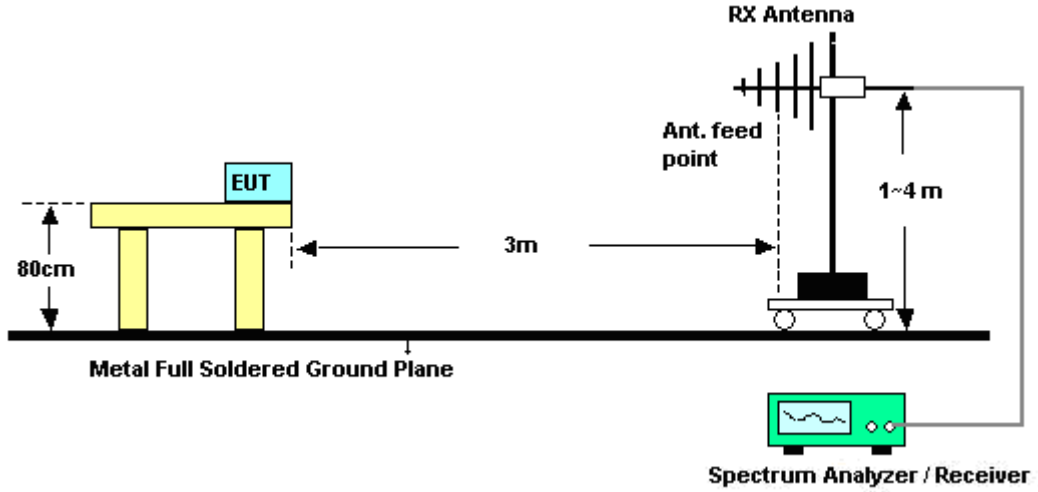

<Conducted Band Edges>

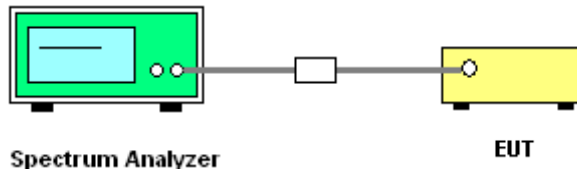



3.3.5 Test Result of Radiated Band Edges

Test Mode :	Mode 1	Temperature :	22~25°C
Test Band :	802.11b	Relative Humidity :	51~54%
Test Channel :	01	Test Engineer :	Wii Chang

ANTENNA POLARITY : HORIZONTAL										
Frequency (MHz)	Level (dBuV/m)	Over Limit (dB)	Limit Line (dBuV/m)	Read Level (dBuV)	Antenna Factor (dB)	Cable Loss (dB)	Preamp Factor (dB)	Ant Pos (cm)	Table Pos (deg)	Remark
2389.99	56.59	-17.41	74	53.68	31.9	5.4	34.39	100	359	Peak
2389.99	45.53	-8.47	54	42.62	31.9	5.4	34.39	100	359	Average

ANTENNA POLARITY : VERTICAL										
Frequency (MHz)	Level (dBuV/m)	Over Limit (dB)	Limit Line (dBuV/m)	Read Level (dBuV)	Antenna Factor (dB)	Cable Loss (dB)	Preamp Factor (dB)	Ant Pos (cm)	Table Pos (deg)	Remark
2387.33	51.56	-22.44	74	48.65	31.9	5.4	34.39	161	355	Peak
2387.33	42.5	-11.5	54	39.59	31.9	5.4	34.39	161	355	Average

Test Mode :	Mode 3	Temperature :	22~25°C
Test Band :	802.11b	Relative Humidity :	51~54%
Test Channel :	11	Test Engineer :	Wii Chang

ANTENNA POLARITY : HORIZONTAL										
Frequency (MHz)	Level (dBuV/m)	Over Limit (dB)	Limit Line (dBuV/m)	Read Level (dBuV)	Antenna Factor (dB)	Cable Loss (dB)	Preamp Factor (dB)	Ant Pos (cm)	Table Pos (deg)	Remark
2488.22	58.58	-15.42	74	55.43	32	5.52	34.37	100	340	Peak
2488.22	50.34	-3.66	54	47.19	32	5.52	34.37	100	340	Average

ANTENNA POLARITY : VERTICAL										
Frequency (MHz)	Level (dBuV/m)	Over Limit (dB)	Limit Line (dBuV/m)	Read Level (dBuV)	Antenna Factor (dB)	Cable Loss (dB)	Preamp Factor (dB)	Ant Pos (cm)	Table Pos (deg)	Remark
2483.5	53.19	-20.81	74	50.06	31.98	5.52	34.37	123	360	Peak
2483.5	45.54	-8.46	54	42.41	31.98	5.52	34.37	123	360	Average



Test Mode :	Mode 4	Temperature :	22~25°C
Test Band :	802.11g	Relative Humidity :	51~54%
Test Channel :	01	Test Engineer :	Wii Chang

ANTENNA POLARITY : HORIZONTAL										
Frequency (MHz)	Level (dBuV/m)	Over Limit (dB)	Limit Line (dBuV/m)	Read Level (dBuV)	Antenna Factor (dB)	Cable Loss (dB)	Preamp Factor (dB)	Ant Pos (cm)	Table Pos (deg)	Remark
2389.99	67.88	-6.12	74	64.97	31.9	5.4	34.39	100	330	Peak
2389.99	50.12	-3.88	54	47.21	31.9	5.4	34.39	100	330	Average

ANTENNA POLARITY : VERTICAL										
Frequency (MHz)	Level (dBuV/m)	Over Limit (dB)	Limit Line (dBuV/m)	Read Level (dBuV)	Antenna Factor (dB)	Cable Loss (dB)	Preamp Factor (dB)	Ant Pos (cm)	Table Pos (deg)	Remark
2389.61	62.2	-11.8	74	59.29	31.9	5.4	34.39	118	338	Peak
2389.61	43.4	-10.6	54	40.49	31.9	5.4	34.39	118	338	Average

Test Mode :	Mode 6	Temperature :	22~25°C
Test Band :	802.11g	Relative Humidity :	51~54%
Test Channel :	11	Test Engineer :	Wii Chang

ANTENNA POLARITY : HORIZONTAL										
Frequency (MHz)	Level (dBuV/m)	Over Limit (dB)	Limit Line (dBuV/m)	Read Level (dBuV)	Antenna Factor (dB)	Cable Loss (dB)	Preamp Factor (dB)	Ant Pos (cm)	Table Pos (deg)	Remark
2483.85	65.85	-8.15	74	62.72	31.98	5.52	34.37	100	340	Peak
2483.85	49.58	-4.42	54	46.45	31.98	5.52	34.37	100	340	Average

ANTENNA POLARITY : VERTICAL										
Frequency (MHz)	Level (dBuV/m)	Over Limit (dB)	Limit Line (dBuV/m)	Read Level (dBuV)	Antenna Factor (dB)	Cable Loss (dB)	Preamp Factor (dB)	Ant Pos (cm)	Table Pos (deg)	Remark
2483.5	61.4	-12.6	74	58.27	31.98	5.52	34.37	178	336	Peak
2483.5	42.12	-11.88	54	38.99	31.98	5.52	34.37	178	336	Average



Test Mode :	Mode 7	Temperature :	22~25°C
Test Band :	802.11n (BW 20MHz)	Relative Humidity :	51~54%
Test Channel :	01	Test Engineer :	Wii Chang

ANTENNA POLARITY : HORIZONTAL										
Frequency (MHz)	Level (dBuV/m)	Over Limit (dB)	Limit Line (dBuV/m)	Read Level (dBuV)	Antenna Factor (dB)	Cable Loss (dB)	Preamp Factor (dB)	Ant Pos (cm)	Table Pos (deg)	Remark
2389.42	68.13	-5.87	74	65.22	31.9	5.4	34.39	100	360	Peak
2389.42	49.44	-4.56	54	46.53	31.9	5.4	34.39	100	360	Average

ANTENNA POLARITY : VERTICAL										
Frequency (MHz)	Level (dBuV/m)	Over Limit (dB)	Limit Line (dBuV/m)	Read Level (dBuV)	Antenna Factor (dB)	Cable Loss (dB)	Preamp Factor (dB)	Ant Pos (cm)	Table Pos (deg)	Remark
2389.99	61.37	-12.63	74	58.46	31.9	5.4	34.39	100	322	Peak
2389.99	42.89	-11.11	54	39.98	31.9	5.4	34.39	100	322	Average

Test Mode :	Mode 9	Temperature :	22~25°C
Test Band :	802.11n (BW 20MHz)	Relative Humidity :	51~54%
Test Channel :	11	Test Engineer :	Wii Chang

ANTENNA POLARITY : HORIZONTAL										
Frequency (MHz)	Level (dBuV/m)	Over Limit (dB)	Limit Line (dBuV/m)	Read Level (dBuV)	Antenna Factor (dB)	Cable Loss (dB)	Preamp Factor (dB)	Ant Pos (cm)	Table Pos (deg)	Remark
2483.66	68.23	-5.77	74	65.1	31.98	5.52	34.37	100	340	Peak
2483.66	50.78	-3.22	54	47.65	31.98	5.52	34.37	100	340	Average

ANTENNA POLARITY : VERTICAL										
Frequency (MHz)	Level (dBuV/m)	Over Limit (dB)	Limit Line (dBuV/m)	Read Level (dBuV)	Antenna Factor (dB)	Cable Loss (dB)	Preamp Factor (dB)	Ant Pos (cm)	Table Pos (deg)	Remark
2484.61	57.29	-16.71	74	54.16	31.98	5.52	34.37	145	359	Peak
2484.61	40.01	-13.99	54	36.88	31.98	5.52	34.37	145	359	Average



3.3.6 Test Plots of Conducted Band Edges

Test Mode :	Mode 1 and 3	Temperature :	24~26°C
Test Band :	802.11b	Relative Humidity :	50~52%
Test Channel :	01 and 11	Test Engineer :	Pinkston Tu

Low Band Edge Plot on 802.11b Channel 01

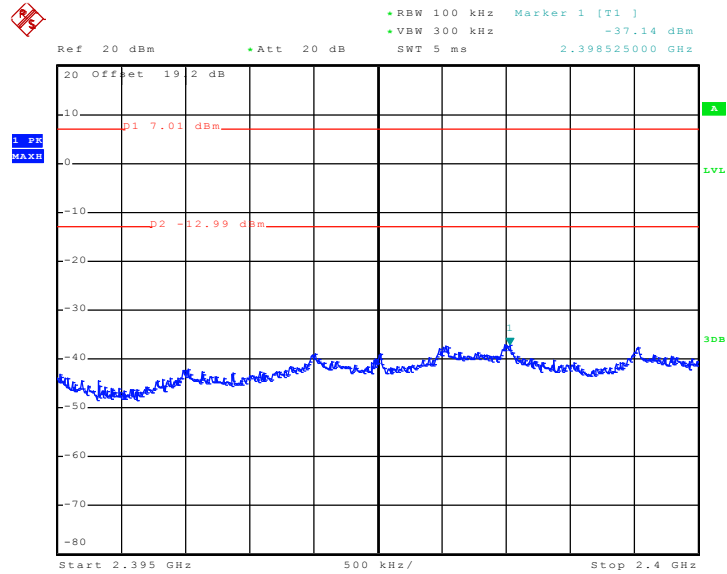

Date: 12.AUG.2011 14:47:39

High Band Edge Plot on 802.11b Channel 11

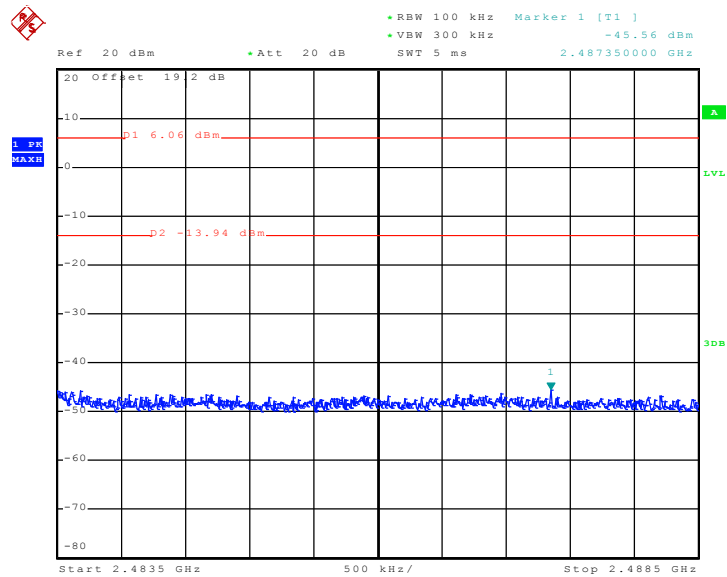

Date: 12.AUG.2011 15:40:26



Test Mode :	Mode 4 and 6	Temperature :	24~26°C
Test Band :	802.11g	Relative Humidity :	50~52%
Test Channel :	01 and 11	Test Engineer :	Pinkston Tu

Low Band Edge Plot on 802.11g Channel 01

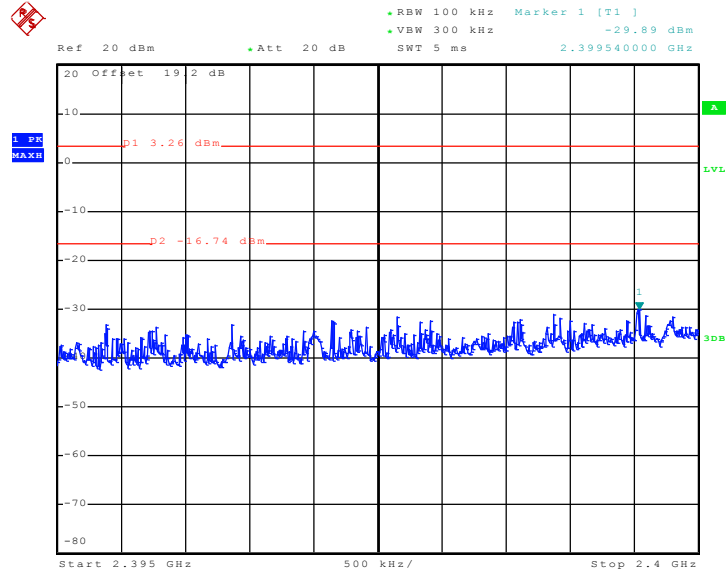

Date: 12.AUG.2011 15:58:07

High Band Edge Plot on 802.11g Channel 11

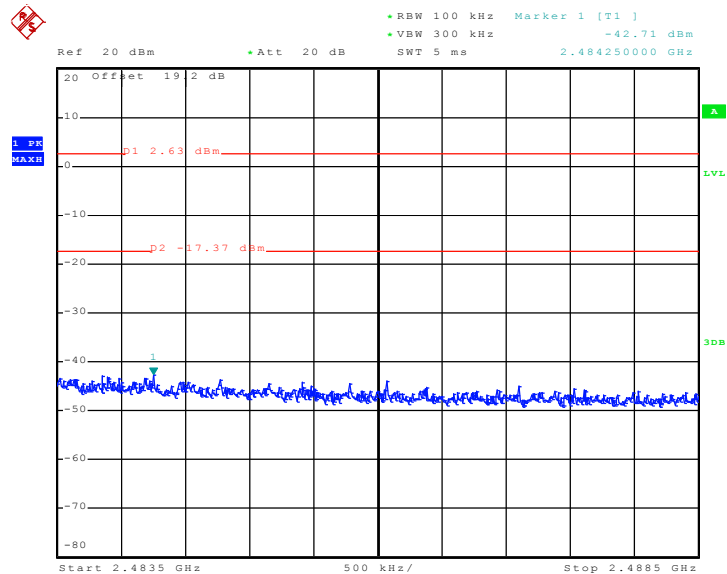

Date: 12.AUG.2011 16:29:21



Test Mode :	Mode 7 and 9	Temperature :	24~26°C
Test Band :	802.11n (BW 20MHz)	Relative Humidity :	50~52%
Test Channel :	01 and 11	Test Engineer :	Pinkston Tu

Low Band Edge Plot on 802.11n (BW 20MHz) Channel 01

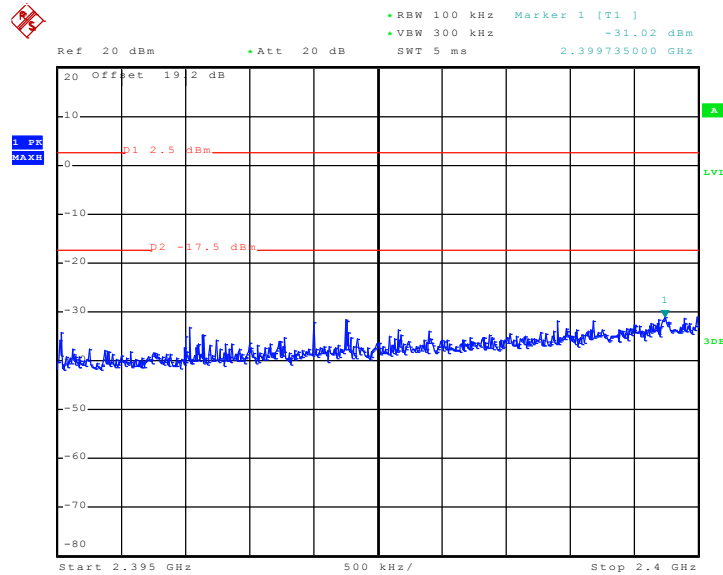

Date: 12.AUG.2011 16:46:58

High Band Edge Plot on 802.11n (BW 20MHz) Channel 11

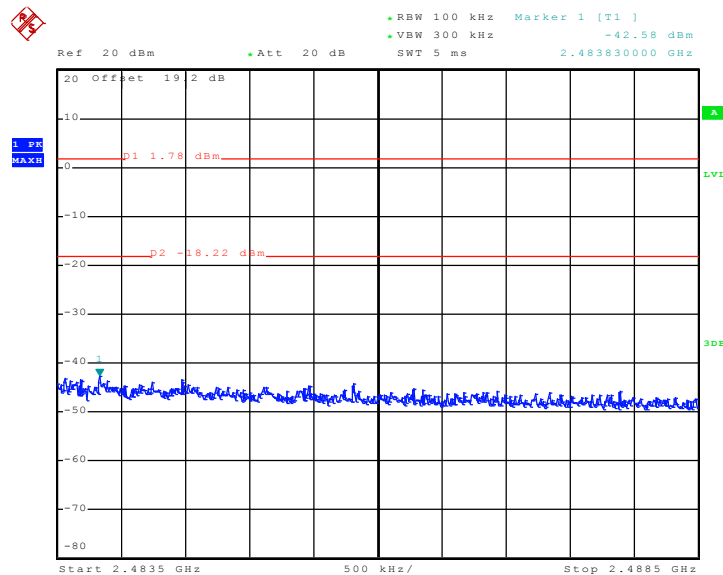

Date: 12.AUG.2011 17:22:52

3.4 Spurious Emission Measurement

3.4.1 Limit of Spurious Emission Measurement

All harmonics/spurious must be at least 20 dB down from the highest emission level within the authorized band.

3.4.2 Measuring Instruments

See list of measuring instruments of this test report.

3.4.3 Test Procedure

1. The transmitter output was connected to the spectrum analyzer via a low lose cable.
2. Set RBW = 100 kHz, Video bandwidth (VBW) \geq RBW, scan up through 10th harmonic. All harmonics/spurs must be at least 20 dB down from the highest emission level within the authorized band as measured with a 100 kHz RBW.

3.4.4 Test Setup

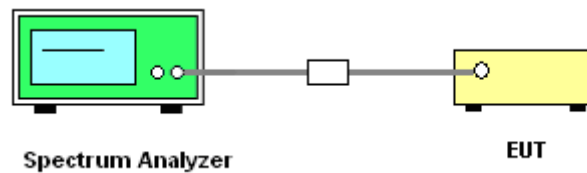

3.4.5 Test Plots of Spurious Emission

Test Mode :	Mode 1	Temperature :	24~26°C
Test Band :	802.11b	Relative Humidity :	50~52%
Test Channel :	01	Test Engineer :	Pinkston Tu

Conducted Spurious Emission Plot between 30MHz ~ 3 GHz

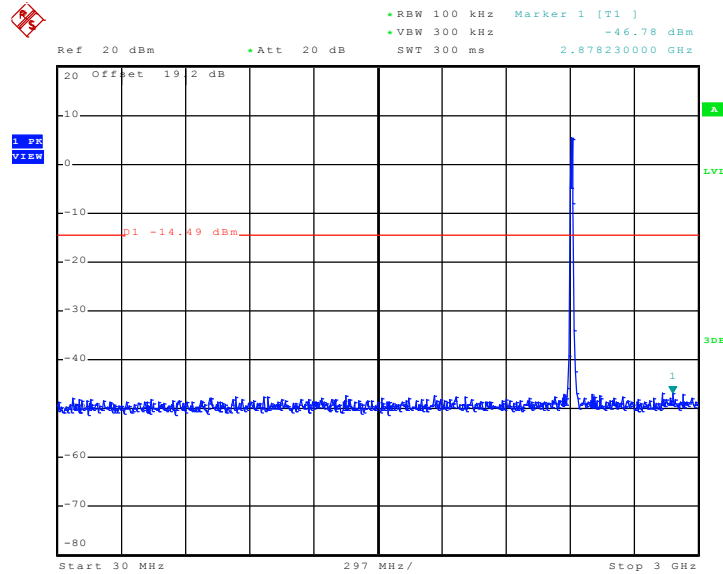

Date: 12.AUG.2011 14:57:08

Conducted Spurious Emission Plot between 3 GHz ~ 25 GHz

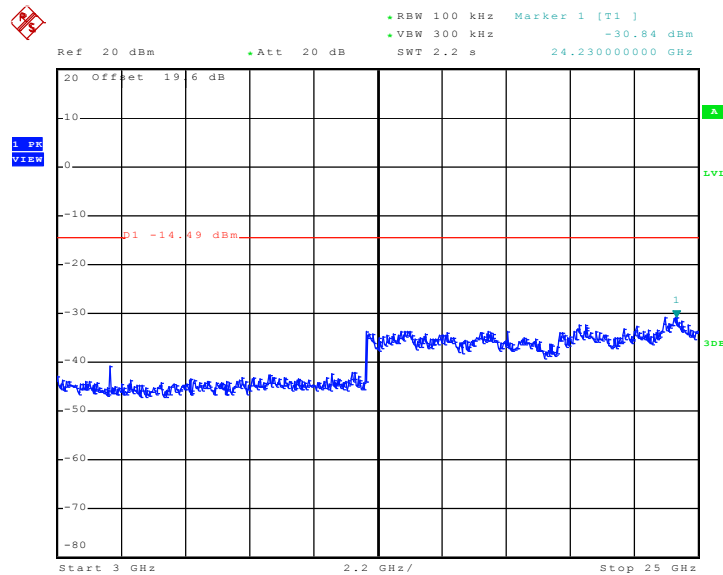

Date: 12.AUG.2011 14:57:27



Test Mode :	Mode 2	Temperature :	24~26°C
Test Band :	802.11b	Relative Humidity :	50~52%
Test Channel :	06	Test Engineer :	Pinkston Tu

Conducted Spurious Emission Plot between 30MHz ~ 3 GHz

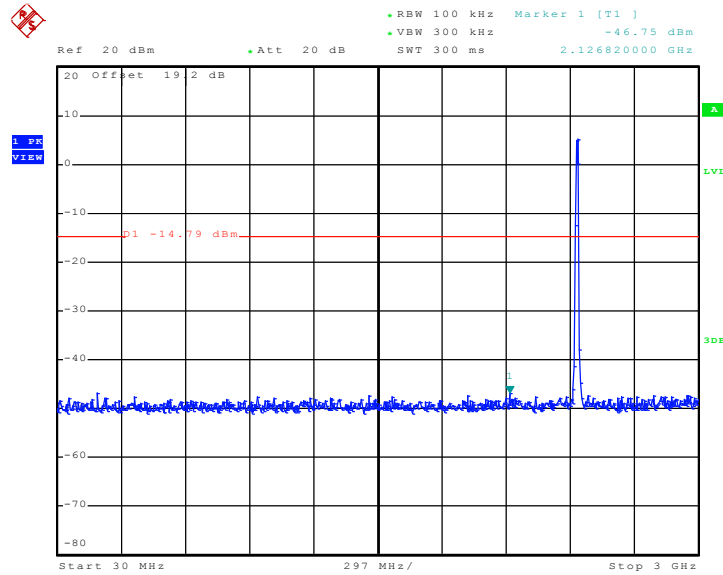

Date: 12.AUG.2011 15:31:51

Conducted Spurious Emission Plot between 3 GHz ~ 25 GHz

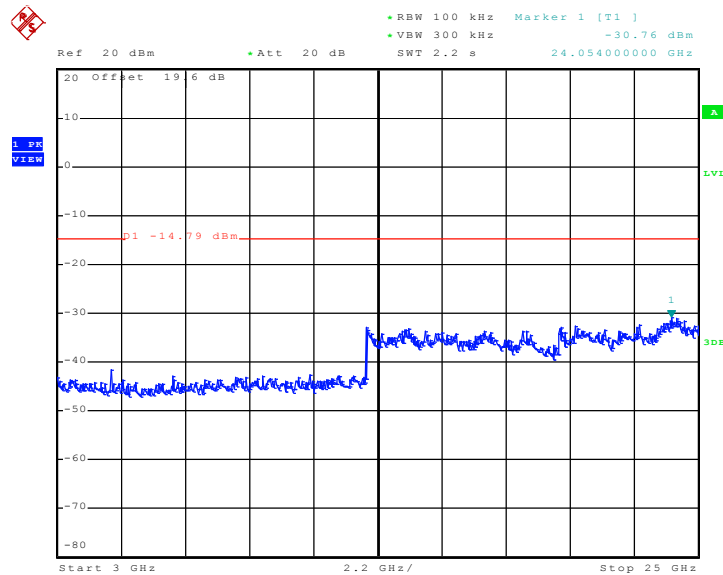

Date: 12.AUG.2011 15:32:09



Test Mode :	Mode 3	Temperature :	24~26°C
Test Band :	802.11b	Relative Humidity :	50~52%
Test Channel :	11	Test Engineer :	Pinkston Tu

Conducted Spurious Emission Plot between 30MHz ~ 3 GHz

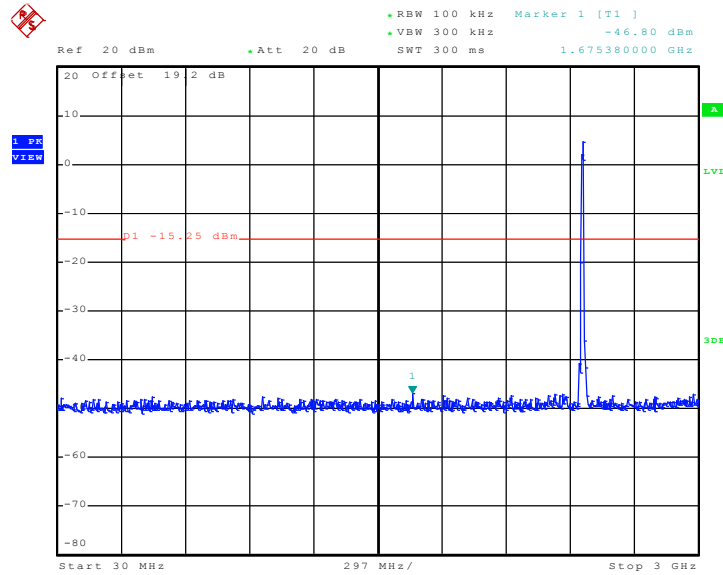

Date: 12.AUG.2011 15:49:53

Conducted Spurious Emission Plot between 3 GHz ~ 25 GHz

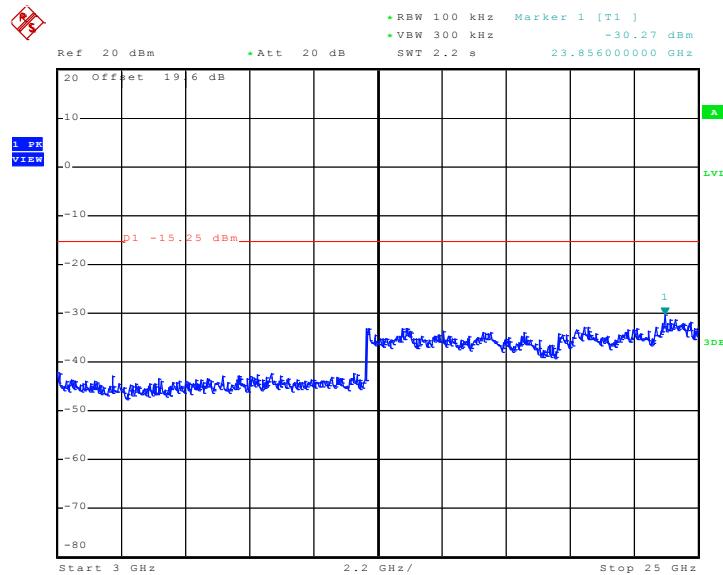

Date: 12.AUG.2011 15:50:11



Test Mode :	Mode 4	Temperature :	24~26°C
Test Band :	802.11g	Relative Humidity :	50~52%
Test Channel :	01	Test Engineer :	Pinkston Tu

Conducted Spurious Emission Plot between 30MHz ~ 3 GHz

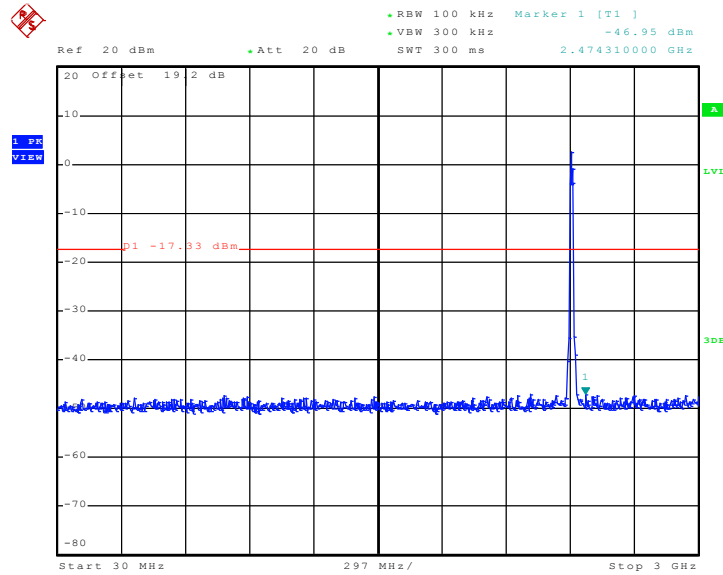

Date: 12.AUG.2011 16:07:46

Conducted Spurious Emission Plot between 3 GHz ~ 25 GHz

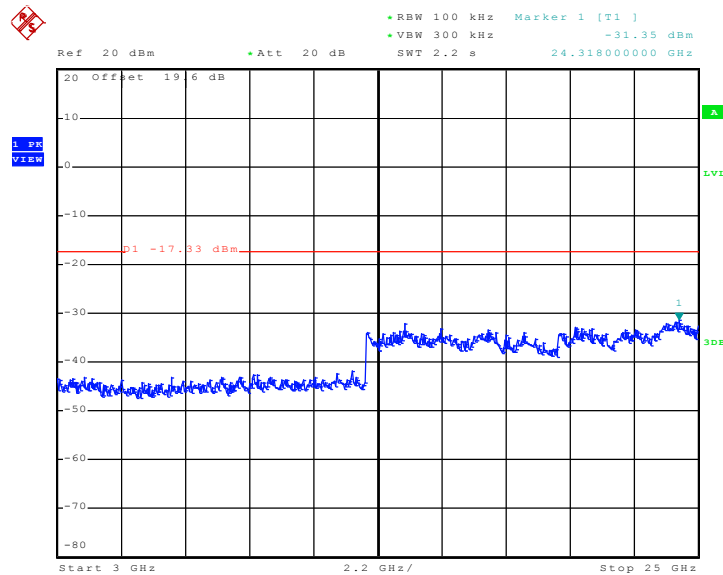

Date: 12.AUG.2011 16:08:04



Test Mode :	Mode 5	Temperature :	24~26
Test Band :	802.11g	Relative Humidity :	50~52
Test Channel :	06	Test Engineer :	Pinkston Tu

Conducted Spurious Emission Plot between 30MHz ~ 3 GHz

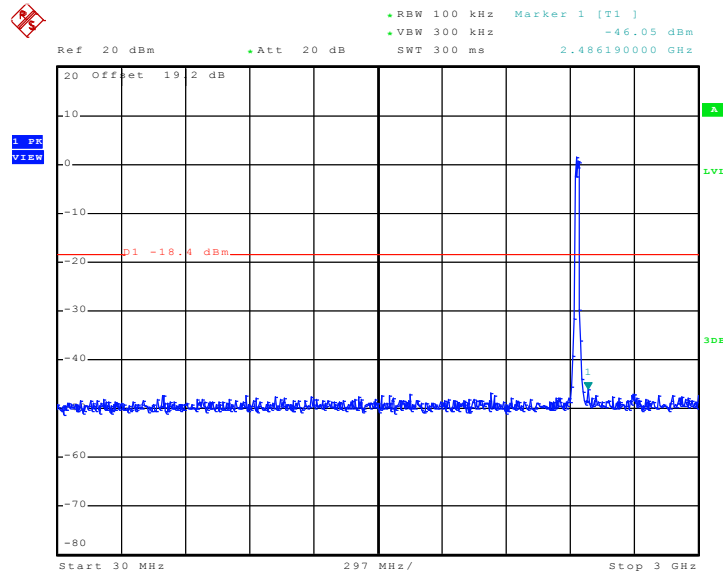

Date: 12.AUG.2011 16:24:10

Conducted Spurious Emission Plot between 3 GHz ~ 25 GHz

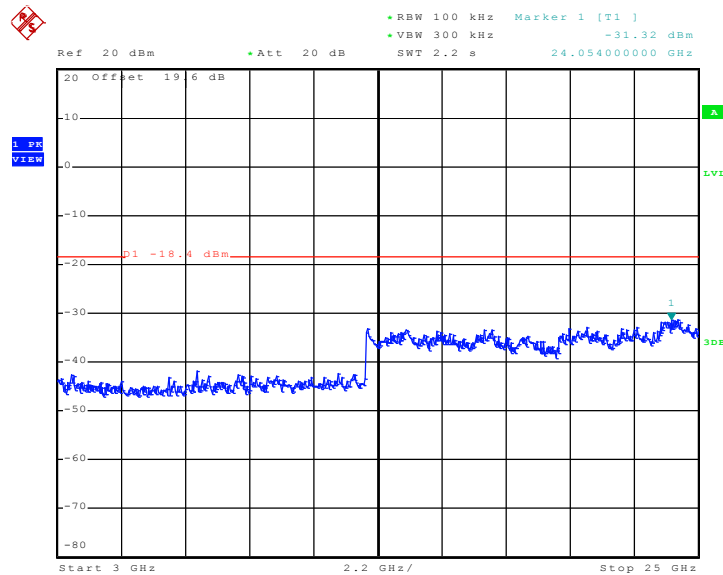

Date: 12.AUG.2011 16:24:28



Test Mode :	Mode 6	Temperature :	24~26°C
Test Band :	802.11g	Relative Humidity :	50~52%
Test Channel :	11	Test Engineer :	Pinkston Tu

Conducted Spurious Emission Plot between 30MHz ~ 3 GHz

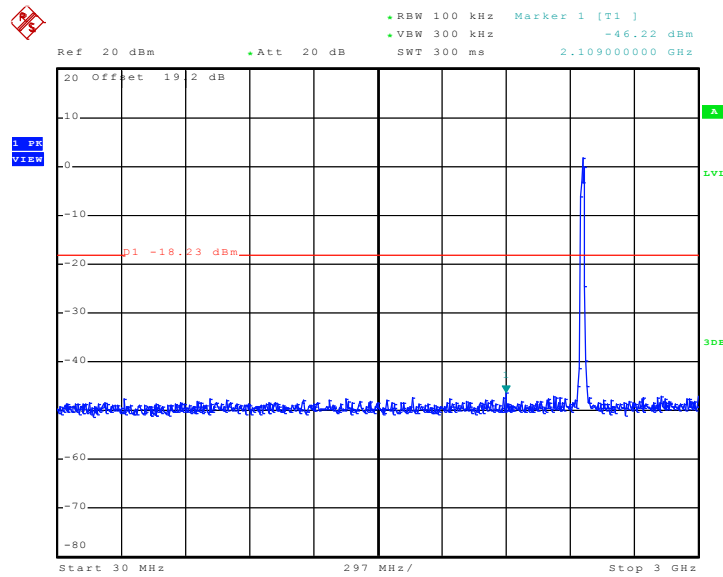

Date: 12.AUG.2011 16:38:48

Conducted Spurious Emission Plot between 3 GHz ~ 25 GHz

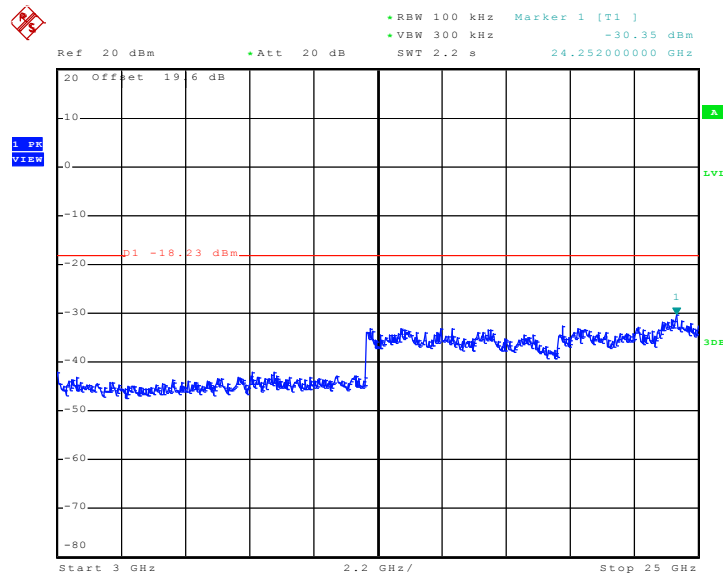

Date: 12.AUG.2011 16:39:06



Test Mode :	Mode 7	Temperature :	24~26°C
Test Band :	802.11n (BW 20MHz)	Relative Humidity :	50~52%
Test Channel :	01	Test Engineer :	Pinkston Tu

Conducted Spurious Emission Plot between 30MHz ~ 3 GHz

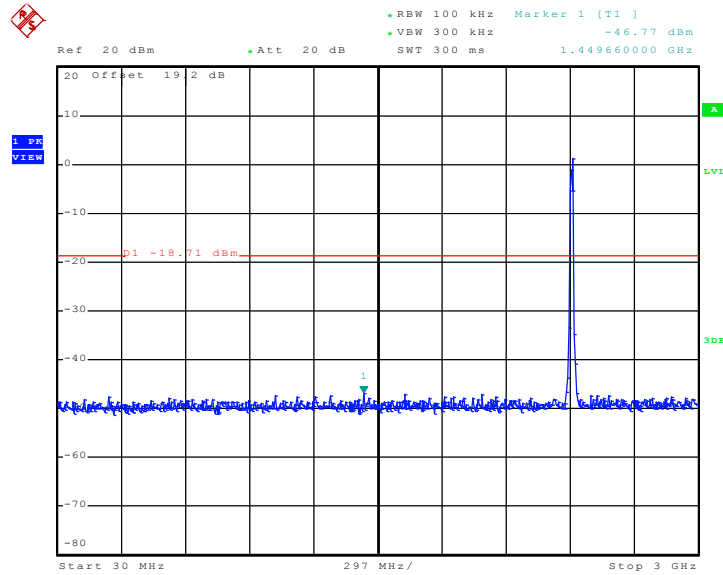

Date: 12.AUG.2011 16:56:37

Conducted Spurious Emission Plot between 3 GHz ~ 25 GHz

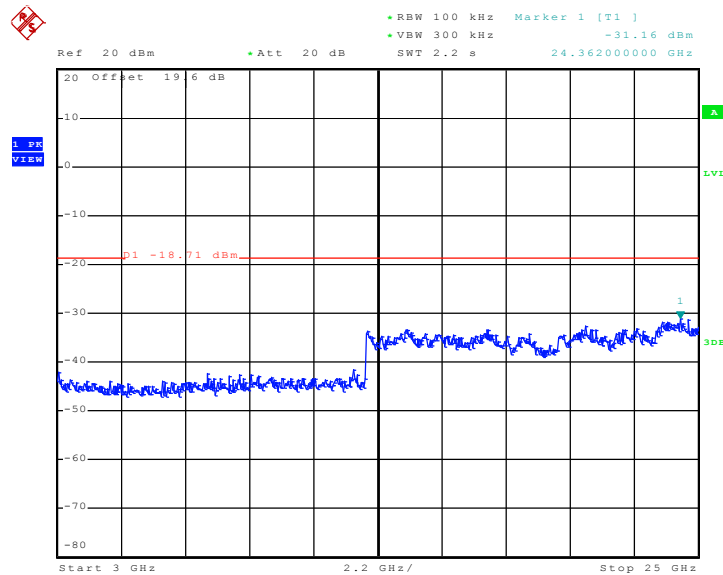

Date: 12.AUG.2011 16:56:54



Test Mode :	Mode 8	Temperature :	24~26°C
Test Band :	802.11n (BW 20MHz)	Relative Humidity :	50~52%
Test Channel :	06	Test Engineer :	Pinkston Tu

Conducted Spurious Emission Plot between 30MHz ~ 3 GHz

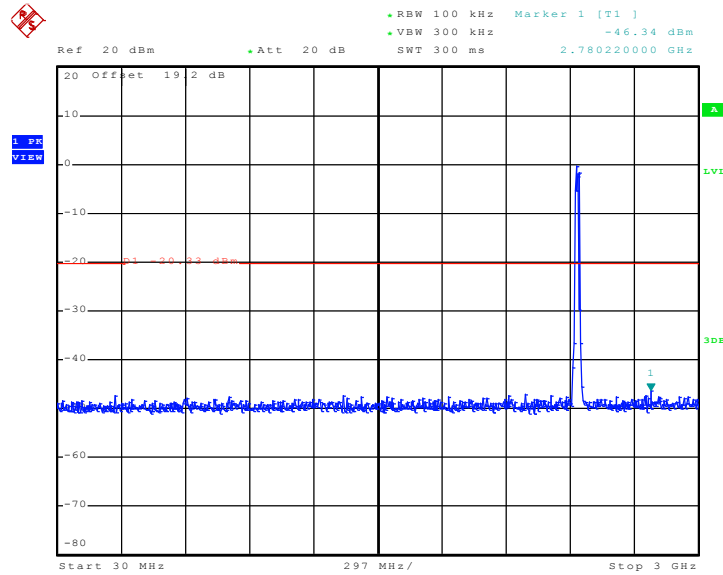

Date: 12.AUG.2011 17:09:04

Conducted Spurious Emission Plot between 3 GHz ~ 25 GHz

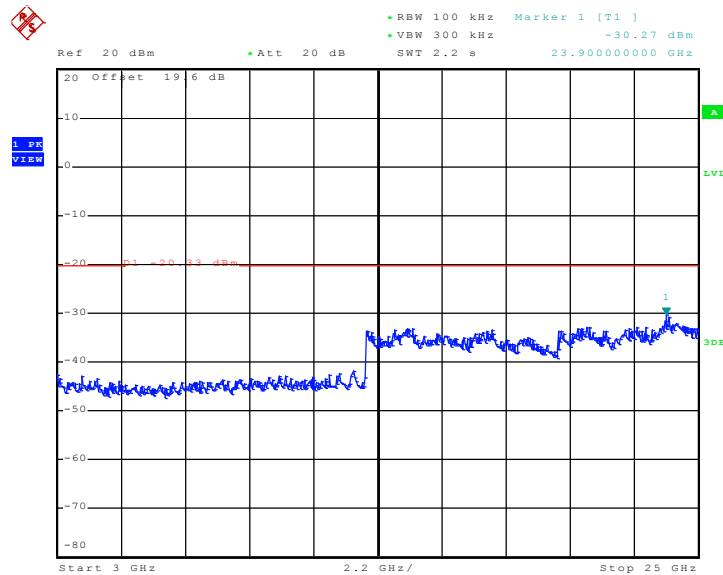

Date: 12.AUG.2011 17:09:22



Test Mode :	Mode 9	Temperature :	24~26°C
Test Band :	802.11n (BW 20MHz)	Relative Humidity :	50~52%
Test Channel :	11	Test Engineer :	Pinkston Tu

Conducted Spurious Emission Plot between 30MHz ~ 3 GHz

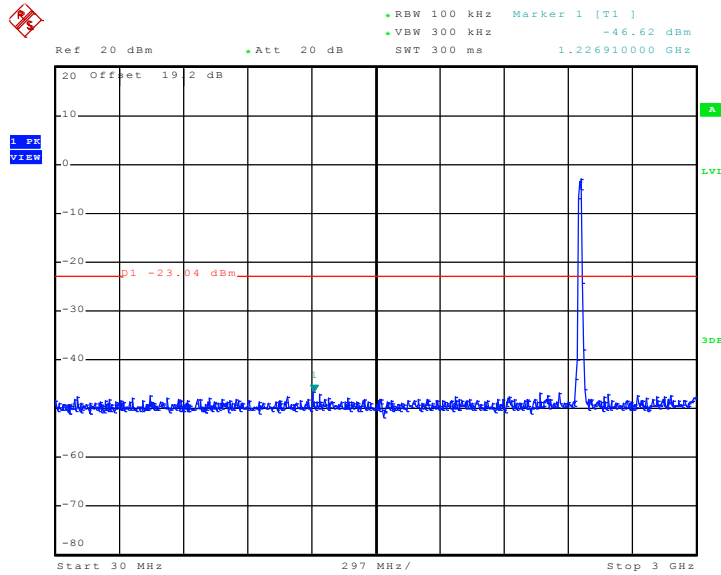

Date: 12.AUG.2011 17:32:24

Conducted Spurious Emission Plot between 3 GHz ~ 25 GHz

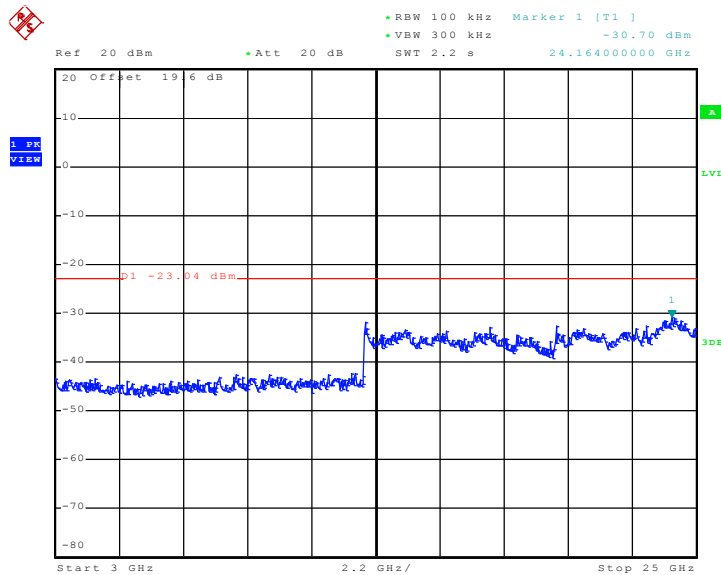

Date: 12.AUG.2011 17:32:43

3.5 Power Spectral Density Measurement

3.5.1 Limit of Power Spectral Density

The peak power spectral density shall not be greater than 8dBm in any 3kHz band at any time interval of continuous transmission.

3.5.2 Measuring Instruments

See list of measuring instruments of this test report.

3.5.3 Test Procedures

1. The test follows FCC KDB Publication No. 558074 (Measurement Guidelines of DTS).
2. The RF output of EUT was connected to the spectrum analyzer by a low loss cable.
3. Take the measured data from spectrum analyzer.

3.5.4 Test Setup

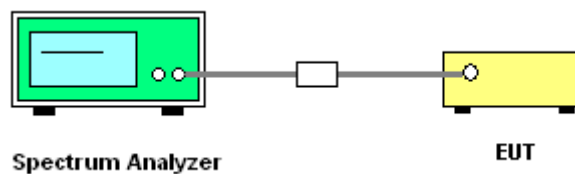



3.5.5 Test Result of Power Spectral Density

Test Mode :	Mode 1, 2, 3	Temperature :	24~26°C
Test Engineer :	Pinkston Tu	Relative Humidity :	50~52%

Channel	Frequency (MHz)	802.11b Measured PSD (dBm)	Max. Limits (dBm)	Pass/Fail
01	2412	-6.10	8	Pass
06	2437	-6.54	8	Pass
11	2462	-7.09	8	Pass

Mode 1 : PSD Plot on 802.11b Channel 01

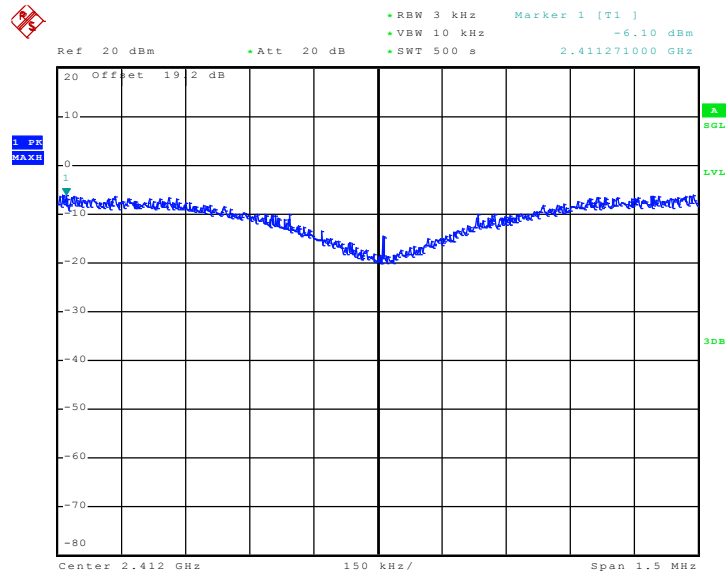

Date: 12.AUG.2011 14:56:46



Mode 2 : PSD Plot on 802.11b Channel 06

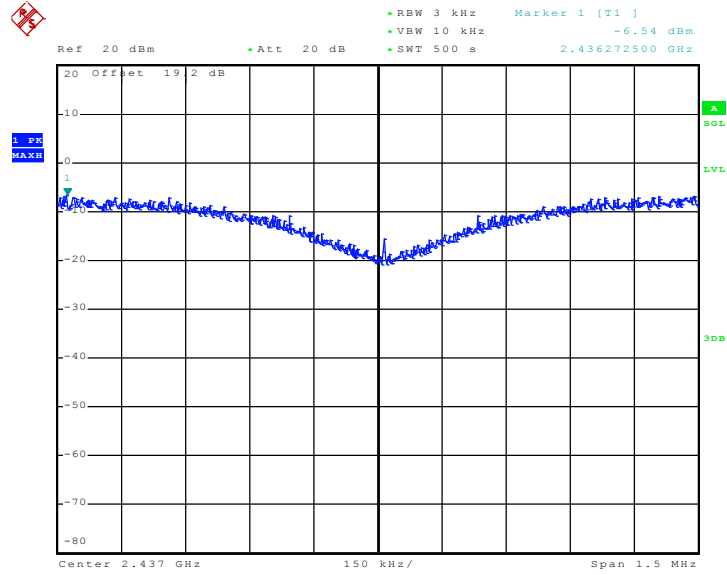

Date: 12.AUG.2011 15:29:36

Mode 3 : PSD Plot on 802.11b Channel 11

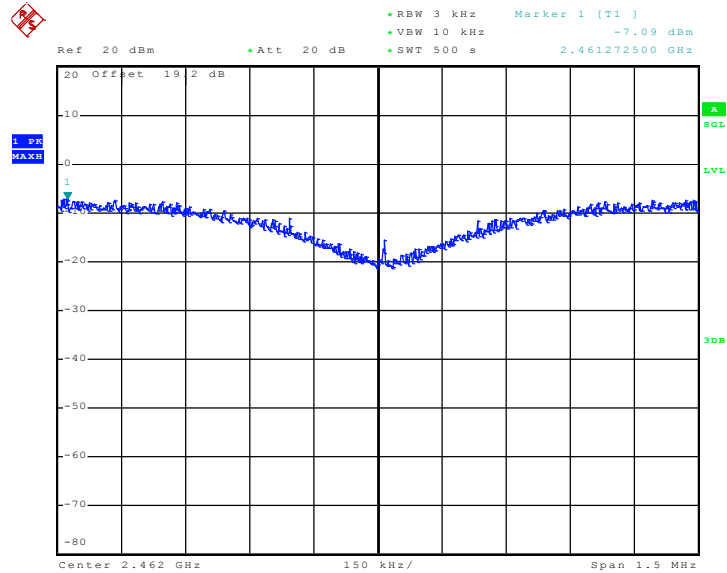

Date: 12.AUG.2011 15:49:31



Test Mode :	Mode 4, 5, 6	Temperature :	24~26°C
Test Engineer :	Pinkston Tu	Relative Humidity :	50~52%

Channel	Frequency (MHz)	802.11g Measured PSD (dBm)	Max. Limits (dBm)	Pass/Fail
01	2412	-11.32	8	Pass
06	2437	-10.02	8	Pass
11	2462	-12.08	8	Pass

Mode 4 : PSD Plot on 802.11g Channel 01

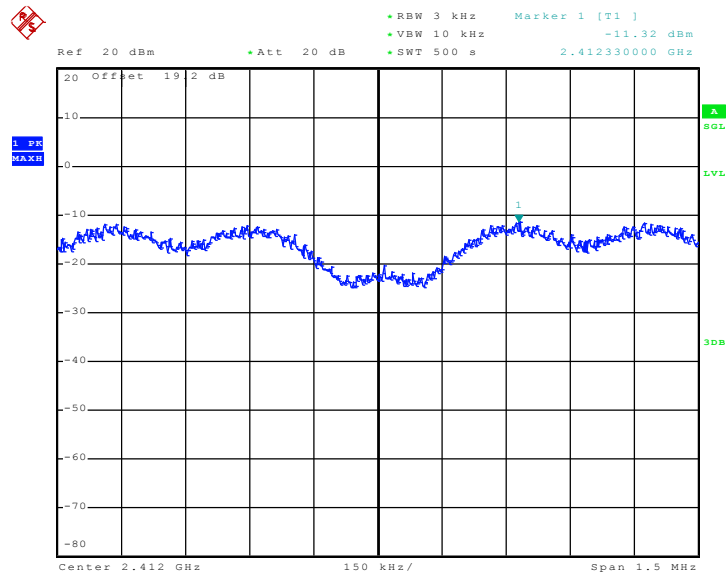

Date: 12.AUG.2011 16:07:24



Mode 5 : PSD Plot on 802.11g Channel 06

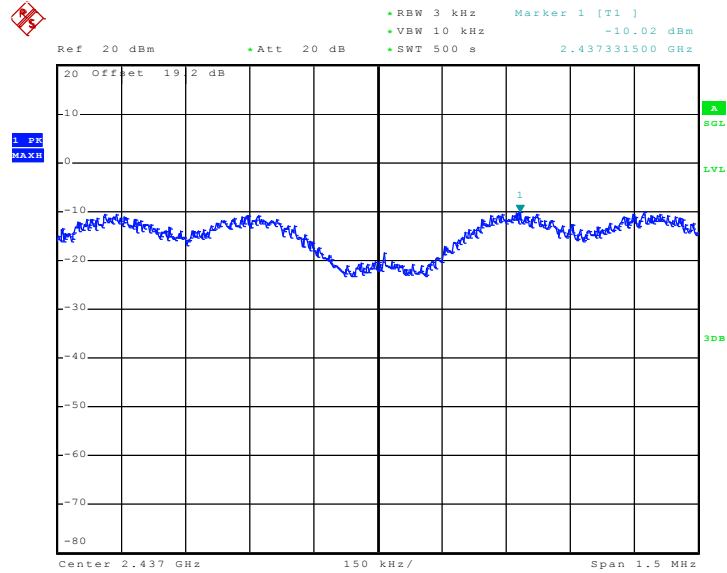

Date: 12.AUG.2011 16:22:58

Mode 6 : PSD Plot on 802.11g Channel 11

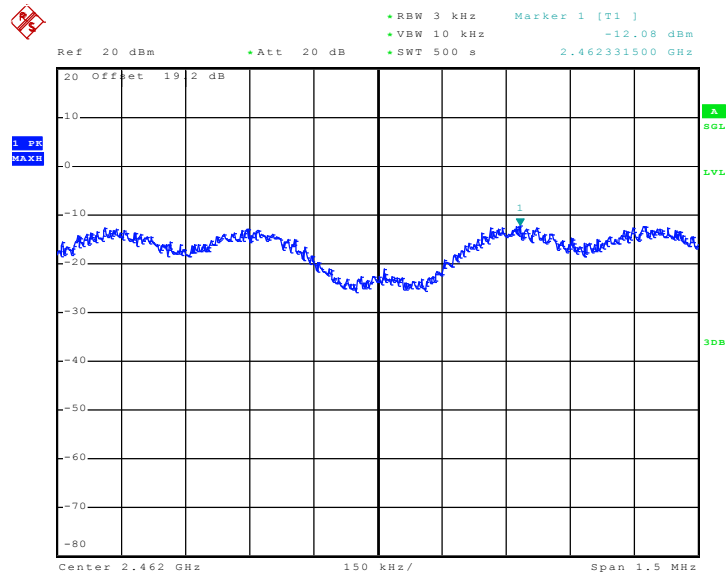

Date: 12.AUG.2011 16:38:26



Test Mode :	Mode 7, 8, 9	Temperature :	24~26°C
Test Engineer :	Pinkston Tu	Relative Humidity :	50~52%

Channel	Frequency (MHz)	802.11n (BW 20MHz) Measured PSD (dBm)	Max. Limits (dBm)	Pass/Fail
01	2412	-11.43	8	Pass
06	2437	-11.07	8	Pass
11	2462	-12.59	8	Pass

Mode 7 : PSD Plot on 802.11n (BW 20MHz) Channel 01

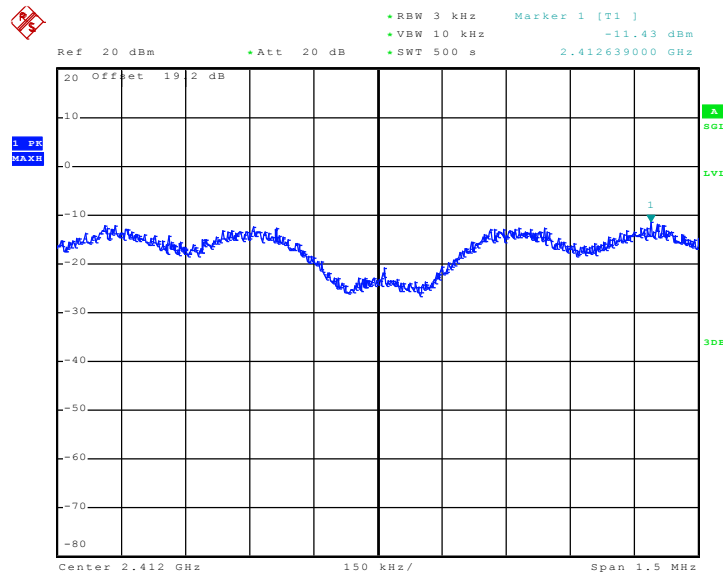

Date: 12.AUG.2011 16:56:14



Mode 8 : PSD Plot on 802.11n (BW 20MHz) Channel 06

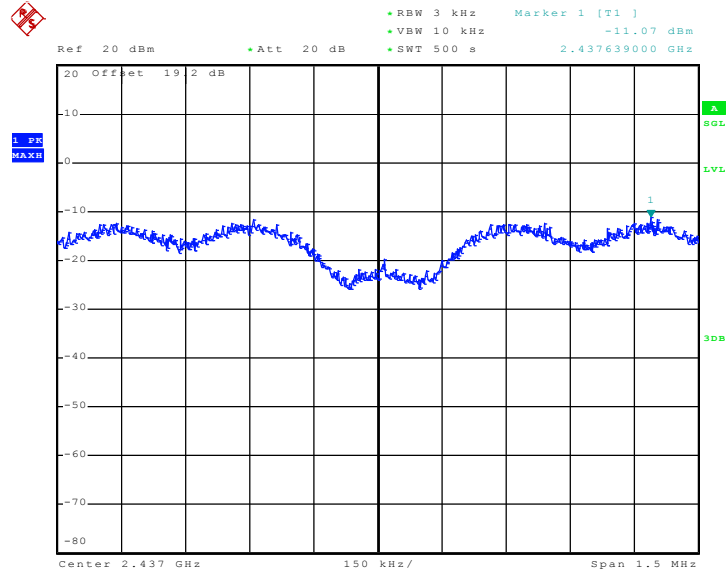

Date: 12.AUG.2011 17:19:02

Mode 9 : PSD Plot on 802.11n (BW 20MHz) Channel 11

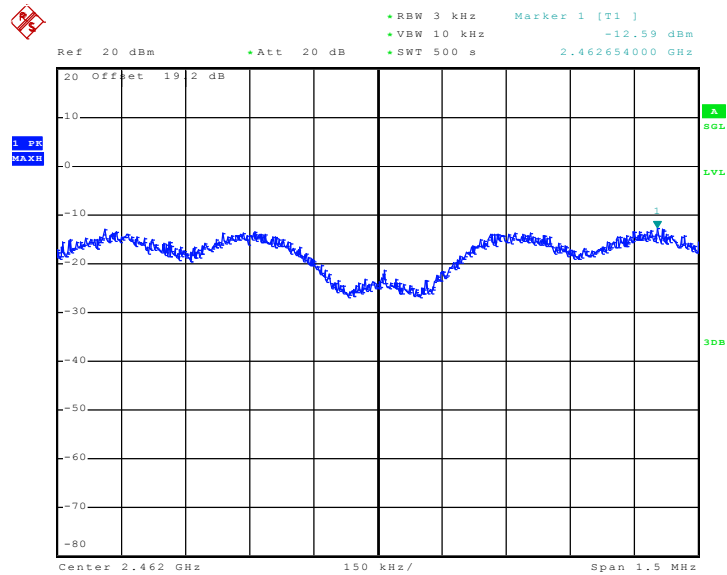

Date: 12.AUG.2011 17:32:02

3.6 AC Conducted Emission Measurement

3.6.1 Limit of AC Conducted Emission

For equipment that is designed to be connected to the public utility (AC) power line, the radio frequency voltage that is conducted back onto the AC power line on any frequency or frequencies within the band 150 kHz to 30 MHz shall not exceed the limits in the following table.

Frequency of Emission (MHz)	Conducted Limit (dBuV)	
	Quasi-Peak	Average
0.15-0.5	66 to 56*	56 to 46*
0.5-5	56	46
5-30	60	50

*Decreases with the logarithm of the frequency.

3.6.2 Measuring Instruments

See list of measuring instruments of this test report.

3.6.3 Test Procedures

1. The testing follows the guidelines in ANSI C63.4-2003.
2. The EUT was placed 0.4 meter from the conducting wall of the shielding room, and it was kept at least 80 centimeters from any other grounded conducting surface.
3. Connect EUT to the power mains through a line impedance stabilization network (LISN).
4. All the support units are connecting to the other LISN.
5. The LISN provides 50 ohm coupling impedance for the measuring instrument.
6. The FCC states that a 50 ohm, 50 microhenry LISN should be used.
7. Both sides of AC line were checked for maximum conducted interference.
8. The frequency range from 150 kHz to 30 MHz was searched.
9. Set the test-receiver system to Peak Detect Function and specified bandwidth with Maximum Hold Mode.

3.6.4 Test Setup



3.6.5 Test Result of AC Conducted Emission

Test Mode :	Mode 1	Temperature :	20~22°C
Test Engineer :	Hayden Wu	Relative Humidity :	40~42%
Test Voltage :	120Vac / 60Hz	Phase :	Line
Function Type :	GSM850 Idle + Bluetooth Link + WLAN Link (2.4G) + GPS Rx + Earphone + Battery + USB Cable (Charging from Adapter)		
Remark :	All emissions not reported here are more than 10 dB below the prescribed limit.		

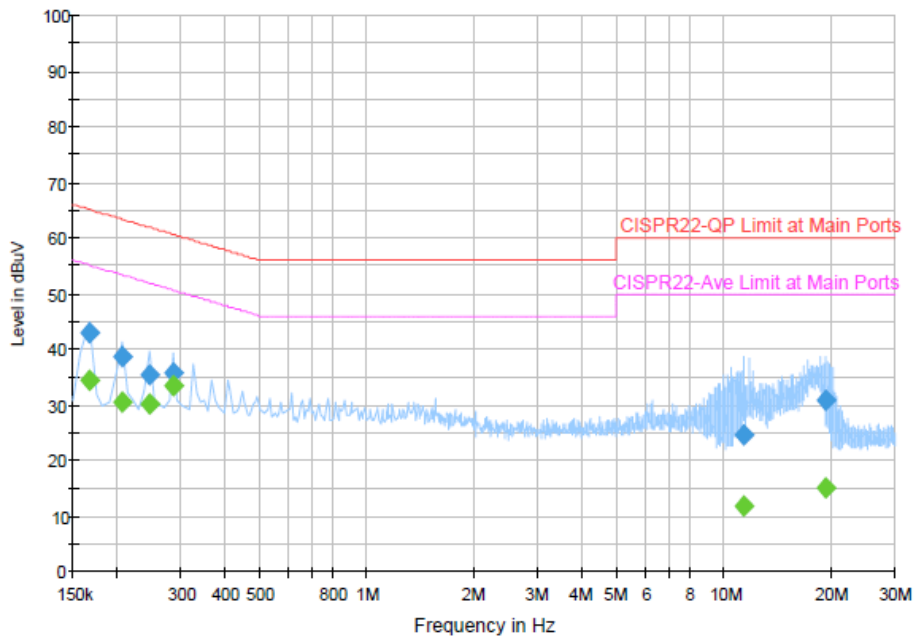

Final Result 1

Frequency (MHz)	QuasiPeak (dBμV)	Filter	Line	Corr. (dB)	Margin (dB)	Limit (dBμV)
0.166000	43.1	Off	L1	19.4	22.1	65.2
0.206000	38.6	Off	L1	19.4	24.8	63.4
0.246000	35.5	Off	L1	19.4	26.4	61.9
0.286000	35.6	Off	L1	19.4	25.0	60.6
11.318000	24.6	Off	L1	19.6	35.4	60.0
19.294000	30.8	Off	L1	19.7	29.2	60.0

Final Result 2

Frequency (MHz)	Average (dBμV)	Filter	Line	Corr. (dB)	Margin (dB)	Limit (dBμV)
0.166000	34.5	Off	L1	19.4	20.7	55.2
0.206000	30.6	Off	L1	19.4	22.8	53.4
0.246000	30.2	Off	L1	19.4	21.7	51.9
0.286000	33.5	Off	L1	19.4	17.1	50.6
11.318000	12.0	Off	L1	19.6	38.0	50.0
19.294000	15.2	Off	L1	19.7	34.8	50.0



Test Mode :	Mode 1	Temperature :	20~22°C
Test Engineer :	Hayden Wu	Relative Humidity :	40~42%
Test Voltage :	120Vac / 60Hz	Phase :	Neutral
Function Type :	GSM850 Idle + Bluetooth Link + WLAN Link (2.4G) + GPS Rx + Earphone + Battery + USB Cable (Charging from Adapter)		
Remark :	All emissions not reported here are more than 10 dB below the prescribed limit.		

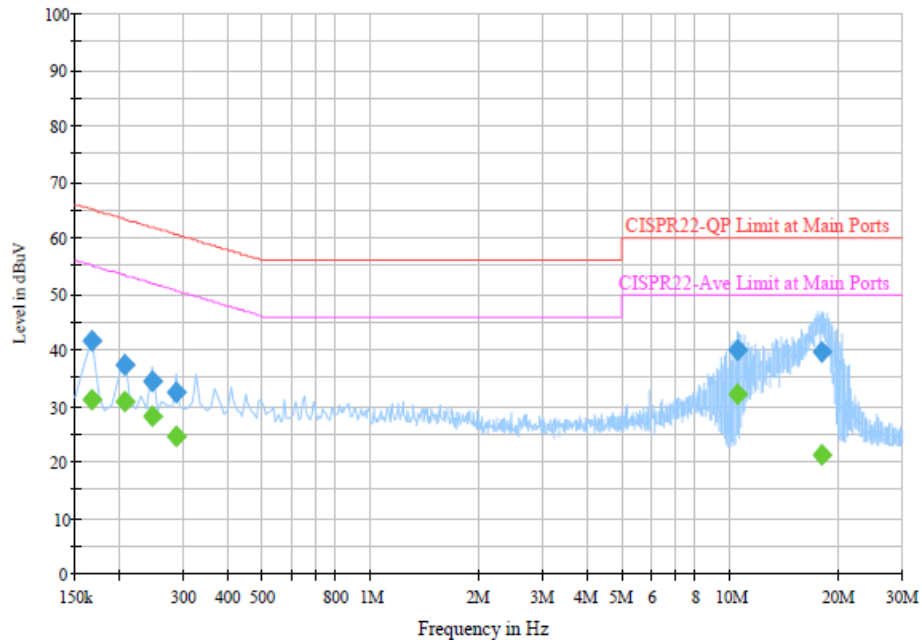

Final Result 1

Frequency (MHz)	QuasiPeak (dBμV)	Filter	Line	Corr. (dB)	Margin (dB)	Limit (dBμV)
0.166000	41.5	Off	N	19.4	23.7	65.2
0.206000	37.5	Off	N	19.4	25.9	63.4
0.246000	34.4	Off	N	19.4	27.5	61.9
0.286000	32.6	Off	N	19.4	28.0	60.6
10.446000	39.9	Off	N	19.6	20.1	60.0
17.950000	39.7	Off	N	19.7	20.3	60.0

Final Result 2

Frequency (MHz)	Average (dBμV)	Filter	Line	Corr. (dB)	Margin (dB)	Limit (dBμV)
0.166000	31.0	Off	N	19.4	24.2	55.2
0.206000	30.9	Off	N	19.4	22.5	53.4
0.246000	28.3	Off	N	19.4	23.6	51.9
0.286000	24.4	Off	N	19.4	26.2	50.6
10.446000	32.3	Off	N	19.6	17.7	50.0
17.950000	21.3	Off	N	19.7	28.7	50.0

3.7 Radiated Emission Measurement

3.7.1 Limit of Radiated Emission

In any 100 kHz bandwidth outside the intentional radiator frequency band, all harmonics/spurious must be at least 20 dB below the highest emission level within the authorized band. If the output power of this device was measured by spectrum analyzer, the attenuation under this paragraph shall be 30 dB instead of 20 dB. In addition, radiated emissions which fall in the restricted bands must also comply with the FCC section 15.209 limits as below.

Frequency (MHz)	Field Strength (microvolts/meter)	Measurement Distance (meters)
0.009 – 0.490	2400/F(kHz)	300
0.490 – 1.705	24000/F(kHz)	30
1.705 – 30.0	30	30
30 – 88	100	3
88 – 216	150	3
216 - 960	200	3
Above 960	500	3

3.7.2 Measuring Instruments

See list of measuring instruments of this test report.

3.7.3 Test Procedures

1. The testing follows the guidelines in FCC KDB Publication No. 558074 (Measurement Guidelines of DTS).
2. Use the following spectrum analyzer settings:
 - (1) Span = wide enough to fully capture the emission being measured; RBW = 1 MHz for $f \geq 1$ GHz, 100 kHz for $f < 1$ GHz; VBW \geq RBW; Sweep = auto; Detector function = peak; Trace = max hold.
 - (2) Above 18 GHz shall be extrapolated to the specified distance using an extrapolation factor of 20 dB/decade from 3m to 1m.
Distance extrapolation factor = $20 \log(\text{specific distance [3m]} / \text{test distance [1m]})$ (dB)
3. Follow the guidelines in ANSI C63.4-2003 with respect to maximizing the emission by rotating the EUT, measuring the emission for three EUT orthogonal planes, and adjusting the measurement antenna height and polarization. A pre-amp and a high pass filter are used for this test in order to get the good signal level.

3.7.4 Test Setup

For radiated emissions below 30MHz

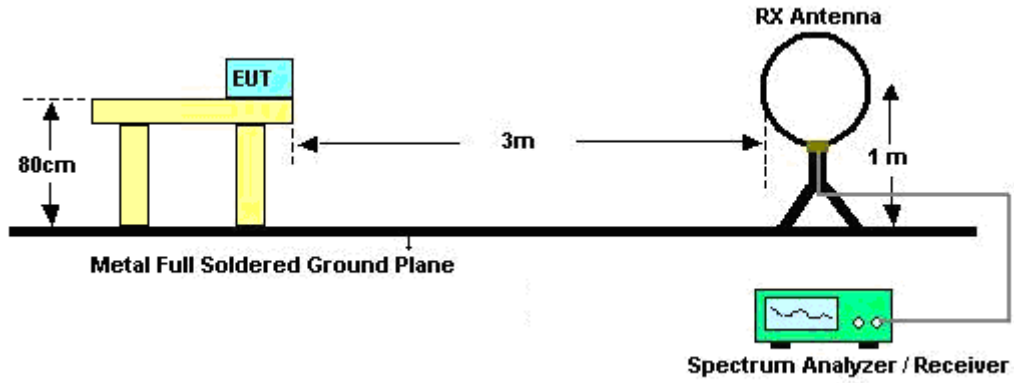

For radiated emissions from 30MHz to 1GHz

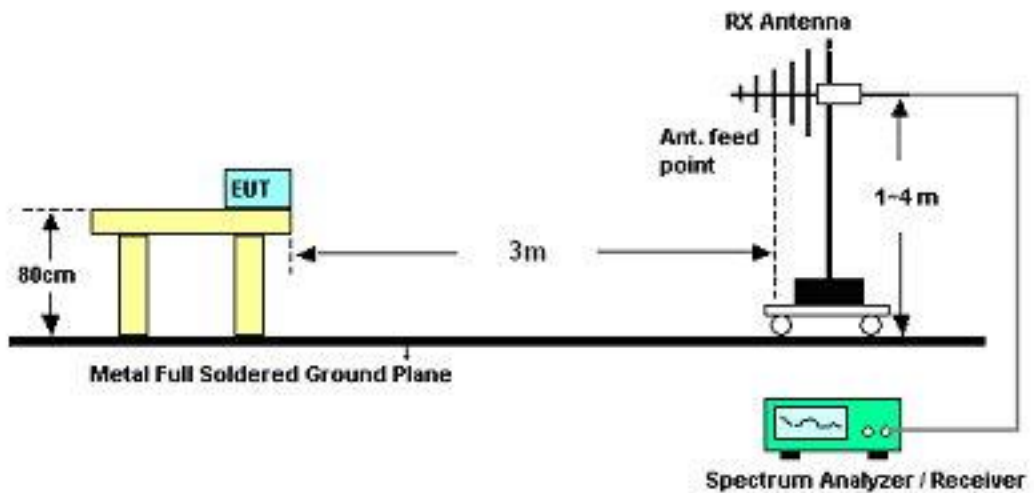

For radiated emissions above 1GHz

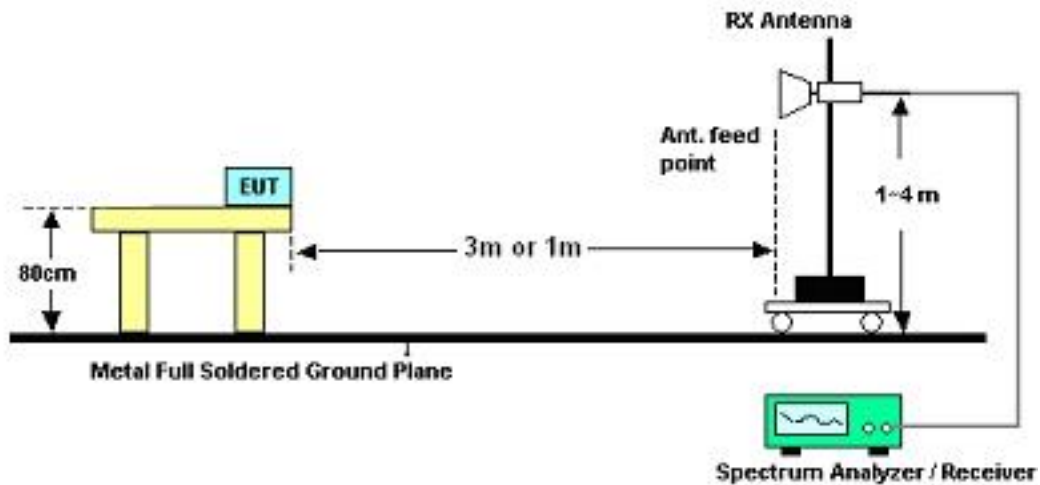

3.7.5 Test Results of Radiated Emissions (9 kHz ~ 30 MHz)

Test Engineer :	Wii Chang	Temperature :	22~25°C	
		Relative Humidity :	51~54%	
Frequency (MHz)	Level (dBuV)	Over Limit (dB)	Limit Line (dBuV)	Remark
-	-	-	-	See Note

Note:

The amplitude of spurious emissions that are attenuated by more than 20dB below the permissible value has no need to be reported.

Distance extrapolation factor = 40 log (specific distance / test distance) (dB);

Limit line = specific limits (dBuV) + distance extrapolation factor.



3.7.6 Test Result of Radiated Emission (30 MHz ~ 10th Harmonic)

Test Mode :	Mode 1	Temperature :	22~25°C
Test Channel :	01	Relative Humidity :	51~54%
Test Engineer :	Wii Chang	Polarization :	Horizontal
Remark :	2412 MHz is Fundamental Signals which can be ignored.		

Frequency (MHz)	Level (dBuV/m)	Over Limit (dB)	Limit Line (dBuV/m)	Read Level (dBuV)	Antenna Factor (dB)	Cable Loss (dB)	Preamp Factor (dB)	Ant Pos (cm)	Table Pos (deg)	Remark
106.14	21.44	-22.06	43.5	40.75	11.13	1.26	31.7	-	-	Peak
156.09	24.99	-18.51	43.5	44.86	10.33	1.47	31.67	100	31	Peak
254.64	25.89	-20.11	46	42.95	12.75	1.87	31.68	-	-	Peak
308.4	20.02	-25.98	46	35.91	13.66	2.09	31.64	-	-	Peak
397.3	20.07	-25.93	46	33.73	15.72	2.4	31.78	-	-	Peak
560.4	21.66	-24.34	46	32.09	18.64	2.86	31.93	-	-	Peak
2389.99	45.53	-8.47	54	42.62	31.9	5.4	34.39	100	359	Average
2389.99	56.59	-17.41	74	53.68	31.9	5.4	34.39	100	359	Peak
2412	109.05	-	-	106.1	31.91	5.43	34.39	100	359	Peak
2412	104.76	-	-	101.81	31.91	5.43	34.39	100	359	Average
2492	33.82	-20.18	54	30.67	32	5.52	34.37	100	359	Average
2492	45.88	-28.12	74	42.73	32	5.52	34.37	100	359	Peak
4824	48.24	-25.76	74	62.33	34.4	7.96	56.45	100	0	Peak



Test Mode :	Mode 1	Temperature :	22~25°C
Test Channel :	01	Relative Humidity :	51~54%
Test Engineer :	Wii Chang	Polarization :	Vertical
Remark :	1. 2412 MHz is Fundamental Signals which can be ignored. 2. 9648 MHz is not within a restricted band.		

Frequency (MHz)	Level (dBuV/m)	Over Limit (dB)	Limit Line (dBuV/m)	Read Level (dBuV)	Antenna Factor (dB)	Cable Loss (dB)	Preamp Factor (dB)	Ant Pos (cm)	Table Pos (deg)	Remark
43.23	23.51	-16.49	40	43.69	10.71	0.81	31.7	100	13	Peak
100.74	25.66	-17.84	43.5	45.35	10.76	1.23	31.68	-	-	Peak
160.14	23.93	-19.57	43.5	44.02	10.08	1.48	31.65	-	-	Peak
409.9	18.81	-27.19	46	32.21	15.98	2.43	31.81	-	-	Peak
575.8	21.81	-24.19	46	32.09	18.84	2.89	32.01	-	-	Peak
687.8	23.02	-22.98	46	32.45	19.36	3.21	32	-	-	Peak
2387.33	42.5	-11.5	54	39.59	31.9	5.4	34.39	161	355	Average
2387.33	51.56	-22.44	74	48.65	31.9	5.4	34.39	161	355	Peak
2412	105.67	-	-	102.72	31.91	5.43	34.39	161	355	Peak
2412	101.43	-	-	98.48	31.91	5.43	34.39	161	355	Average
2494	32.9	-21.1	54	29.75	32	5.52	34.37	161	355	Average
2494	44.42	-29.58	74	41.27	32	5.52	34.37	161	355	Peak
9648	50.19	-35.48	85.67	59.9	36.79	10.32	56.82	100	0	Peak



Test Mode :	Mode 2	Temperature :	22~25°C
Test Channel :	06	Relative Humidity :	51~54%
Test Engineer :	Wii Chang	Polarization :	Horizontal
Remark :	2437 MHz is Fundamental Signals which can be ignored.		

Frequency (MHz)	Level (dBuV/m)	Over Limit (dB)	Limit Line (dBuV/m)	Read Level (dBuV)	Antenna Factor (dB)	Cable Loss (dB)	Preamp Factor (dB)	Ant Pos (cm)	Table Pos (deg)	Remark
30	16.89	-23.11	40	29.98	17.91	0.72	31.72	-	-	Peak
137.73	25.13	-18.37	43.5	43.93	11.47	1.43	31.7	100	34	Peak
252.48	24.64	-21.36	46	41.74	12.7	1.86	31.66	-	-	Peak
313.3	20.54	-25.46	46	36.29	13.77	2.11	31.63	-	-	Peak
404.3	19.92	-26.08	46	33.44	15.86	2.42	31.8	-	-	Peak
665.4	22.67	-23.33	46	32.22	19.31	3.12	31.98	-	-	Peak
2358	54.26	-19.74	74	51.43	31.86	5.37	34.4	100	330	Peak
2358	47.89	-6.11	54	45.06	31.86	5.37	34.4	100	330	Average
2437	110.48	-	-	107.45	31.95	5.46	34.38	100	330	Peak
2437	106.25	-	-	103.22	31.95	5.46	34.38	100	330	Average
2484	48.32	-25.68	74	45.19	31.98	5.52	34.37	100	330	Peak
2484	35.69	-18.31	54	32.56	31.98	5.52	34.37	100	330	Average
4874	48.39	-25.61	74	62.51	34.37	8	56.49	100	0	Peak



Test Mode :	Mode 2	Temperature :	22~25°C
Test Channel :	06	Relative Humidity :	51~54%
Test Engineer :	Wii Chang	Polarization :	Vertical
Remark :	1. 2437 MHz is Fundamental Signals which can be ignored. 2. 9748 MHz is not within a restricted band.		

Frequency (MHz)	Level (dBuV/m)	Over Limit (dB)	Limit Line (dBuV/m)	Read Level (dBuV)	Antenna Factor (dB)	Cable Loss (dB)	Preamp Factor (dB)	Ant Pos (cm)	Table Pos (deg)	Remark
44.04	23.71	-16.29	40	43.89	10.71	0.81	31.7	100	66	Peak
101.28	24.42	-19.08	43.5	44.11	10.76	1.23	31.68	-	-	Peak
157.44	23.97	-19.53	43.5	43.89	10.27	1.47	31.66	-	-	Peak
332.9	17.57	-28.43	46	32.76	14.22	2.17	31.58	-	-	Peak
418.3	19.24	-26.76	46	32.49	16.14	2.44	31.83	-	-	Peak
647.9	22.45	-23.55	46	32.12	19.27	3.04	31.98	-	-	Peak
2358	48.74	-25.26	74	45.91	31.86	5.37	34.4	124	360	Peak
2358	41.14	-12.86	54	38.31	31.86	5.37	34.4	124	360	Average
2437	105.84	-	-	102.81	31.95	5.46	34.38	124	360	Peak
2437	101.49	-	-	98.46	31.95	5.46	34.38	124	360	Average
2492	45.14	-28.86	74	41.99	32	5.52	34.37	124	360	Peak
2492	33.38	-20.62	54	30.23	32	5.52	34.37	124	360	Average
4874	47.63	-26.37	74	61.75	34.37	8	56.49	100	0	Peak
9748	51.62	-34.22	85.84	61.2	36.91	10.35	56.84	100	0	Peak



Test Mode :	Mode 3	Temperature :	22~25°C
Test Channel :	11	Relative Humidity :	51~54%
Test Engineer :	Wii Chang	Polarization :	Horizontal
Remark :	2462 MHz is Fundamental Signals which can be ignored.		

Frequency (MHz)	Level (dBuV/m)	Over Limit (dB)	Limit Line (dBuV/m)	Read Level (dBuV)	Antenna Factor (dB)	Cable Loss (dB)	Preamp Factor (dB)	Ant Pos (cm)	Table Pos (deg)	Remark
30	16.36	-23.64	40	29.45	17.91	0.72	31.72	-	-	Peak
153.93	25.83	-17.67	43.5	45.59	10.45	1.47	31.68	100	67	Peak
257.34	24.68	-21.32	46	41.72	12.78	1.88	31.7	-	-	Peak
306.3	20.79	-25.21	46	36.74	13.62	2.08	31.65	-	-	Peak
514.9	20.41	-25.59	46	31.47	18.03	2.72	31.81	-	-	Peak
733.3	23.8	-22.2	46	32.71	19.85	3.32	32.08	-	-	Peak
2380	55.57	-18.43	74	52.68	31.88	5.4	34.39	100	340	Peak
2380	49.42	-4.58	54	46.53	31.88	5.4	34.39	100	340	Average
2462	110.35	-	-	107.27	31.97	5.49	34.38	100	340	Peak
2462	105.98	-	-	102.9	31.97	5.49	34.38	100	340	Average
2488.22	50.34	-3.66	54	47.19	32	5.52	34.37	100	340	Average
2488.22	58.58	-15.42	74	55.43	32	5.52	34.37	100	340	Peak
4924	50.18	-23.82	74	64.32	34.34	8.04	56.52	100	0	Peak



Test Mode :	Mode 3	Temperature :	22~25°C
Test Channel :	11	Relative Humidity :	51~54%
Test Engineer :	Wii Chang	Polarization :	Vertical
Remark :	1. 2462 MHz is Fundamental Signals which can be ignored. 2. 9848 MHz is not within a restricted band.		

Frequency (MHz)	Level (dBuV/m)	Over Limit (dB)	Limit Line (dBuV/m)	Read Level (dBuV)	Antenna Factor (dB)	Cable Loss (dB)	Preamp Factor (dB)	Ant Pos (cm)	Table Pos (deg)	Remark
43.23	23.41	-16.59	40	43.59	10.71	0.81	31.7	100	39	Peak
102.09	25.22	-18.28	43.5	44.84	10.84	1.23	31.69	-	-	Peak
157.98	25.53	-17.97	43.5	45.51	10.2	1.48	31.66	-	-	Peak
386.8	17.9	-28.1	46	31.83	15.47	2.36	31.76	-	-	Peak
516.3	20.5	-25.5	46	31.54	18.04	2.73	31.81	-	-	Peak
582.8	21.78	-24.22	46	31.98	18.94	2.9	32.04	-	-	Peak
2382	42.15	-11.85	54	39.26	31.88	5.4	34.39	123	360	Average
2382	49.87	-24.13	74	46.98	31.88	5.4	34.39	123	360	Peak
2462	101.58	-	-	98.5	31.97	5.49	34.38	123	360	Average
2462	106.14	-	-	103.06	31.97	5.49	34.38	123	360	Peak
2483.5	45.54	-8.46	54	42.41	31.98	5.52	34.37	123	360	Average
2483.5	53.19	-20.81	74	50.06	31.98	5.52	34.37	123	360	Peak
4924	48.06	-25.94	74	62.2	34.34	8.04	56.52	100	0	Peak
9848	52.61	-33.53	86.14	62.08	37.01	10.38	56.86	100	0	Peak



Test Mode :	Mode 4	Temperature :	22~25°C
Test Channel :	01	Relative Humidity :	51~54%
Test Engineer :	Wii Chang	Polarization :	Horizontal
Remark :	2412 MHz is Fundamental Signals which can be ignored.		

Frequency (MHz)	Level (dBuV/m)	Over Limit (dB)	Limit Line (dBuV/m)	Read Level (dBuV)	Antenna Factor (dB)	Cable Loss (dB)	Preamp Factor (dB)	Ant Pos (cm)	Table Pos (deg)	Remark
105.33	21.58	-21.92	43.5	40.88	11.13	1.26	31.69	-	-	Peak
153.39	24.22	-19.28	43.5	43.92	10.51	1.47	31.68	100	88	Peak
250.59	24.35	-21.65	46	41.48	12.67	1.85	31.65	-	-	Peak
306.3	21.45	-24.55	46	37.4	13.62	2.08	31.65	-	-	Peak
467.3	19.93	-26.07	46	32.04	17.15	2.56	31.82	-	-	Peak
582.8	22.16	-23.84	46	32.36	18.94	2.9	32.04	-	-	Peak
2389.99	50.12	-3.88	54	47.21	31.9	5.4	34.39	100	330	Average
2389.99	67.88	-6.12	74	64.97	31.9	5.4	34.39	100	330	Peak
2412	107.04	-	-	104.09	31.91	5.43	34.39	100	330	Peak
2412	95.02	-	-	92.07	31.91	5.43	34.39	100	330	Average
2486	37.15	-16.85	54	34.02	31.98	5.52	34.37	100	330	Average
2486	49.9	-24.1	74	46.77	31.98	5.52	34.37	100	330	Peak



Test Mode :	Mode 4	Temperature :	22~25°C
Test Channel :	01	Relative Humidity :	51~54%
Test Engineer :	Wii Chang	Polarization :	Vertical
Remark :	2412 MHz is Fundamental Signals which can be ignored.		

Frequency (MHz)	Level (dBuV/m)	Over Limit (dB)	Limit Line (dBuV/m)	Read Level (dBuV)	Antenna Factor (dB)	Cable Loss (dB)	Preamp Factor (dB)	Ant Pos (cm)	Table Pos (deg)	Remark
44.04	23.56	-16.44	40	43.74	10.71	0.81	31.7	100	22	Peak
99.39	24.59	-18.91	43.5	44.36	10.69	1.22	31.68	-	-	Peak
198.48	24.17	-19.33	43.5	44.82	9.35	1.65	31.65	-	-	Peak
330.8	18.23	-27.77	46	33.49	14.17	2.16	31.59	-	-	Peak
400.8	18.64	-27.36	46	32.24	15.78	2.41	31.79	-	-	Peak
542.9	21.3	-24.7	46	31.94	18.4	2.83	31.87	-	-	Peak
2389.61	43.4	-10.6	54	40.49	31.9	5.4	34.39	118	338	Average
2389.61	62.2	-11.8	74	59.29	31.9	5.4	34.39	118	338	Peak
2412	102.52	-	-	99.57	31.91	5.43	34.39	118	338	Peak
2412	90.87	-	-	87.92	31.91	5.43	34.39	118	338	Average
2484	35.71	-18.29	54	32.58	31.98	5.52	34.37	118	338	Average
2484	47.63	-26.37	74	44.5	31.98	5.52	34.37	118	338	Peak



Test Mode :	Mode 5	Temperature :	22~25°C
Test Channel :	06	Relative Humidity :	51~54%
Test Engineer :	Wii Chang	Polarization :	Horizontal
Remark :	1. 2437 MHz is Fundamental Signals which can be ignored. 2. 9748 MHz is not within a restricted band.		

Frequency (MHz)	Level (dBuV/m)	Over Limit (dB)	Limit Line (dBuV/m)	Read Level (dBuV)	Antenna Factor (dB)	Cable Loss (dB)	Preamp Factor (dB)	Ant Pos (cm)	Table Pos (deg)	Remark
104.79	21.21	-22.29	43.5	40.59	11.06	1.25	31.69	-	-	Peak
152.58	25.08	-18.42	43.5	44.73	10.58	1.46	31.69	100	64	Peak
251.13	23.91	-22.09	46	41.03	12.69	1.85	31.66	-	-	Peak
313.3	20.1	-25.9	46	35.85	13.77	2.11	31.63	-	-	Peak
392.4	19.02	-26.98	46	32.8	15.6	2.39	31.77	-	-	Peak
630.4	21.99	-24.01	46	31.78	19.24	3	32.03	-	-	Peak
2390	58.42	-15.58	74	55.51	31.9	5.4	34.39	100	342	Peak
2390	46.62	-7.38	54	43.71	31.9	5.4	34.39	100	342	Average
2437	111.05	-	-	108.04	31.93	5.46	34.38	100	342	Peak
2437	98.71	-	-	95.68	31.95	5.46	34.38	100	342	Average
2484	52.91	-21.09	74	49.78	31.98	5.52	34.37	100	342	Peak
2484	38.2	-15.8	54	35.07	31.98	5.52	34.37	100	342	Average
9748	51.13	-39.92	91.05	60.71	36.91	10.35	56.84	100	0	Peak



Test Mode :	Mode 5	Temperature :	22~25°C
Test Channel :	06	Relative Humidity :	51~54%
Test Engineer :	Wii Chang	Polarization :	Vertical
Remark :	1. 2437 MHz is Fundamental Signals which can be ignored. 2. 9748 MHz is not within a restricted band.		

Frequency (MHz)	Level (dBuV/m)	Over Limit (dB)	Limit Line (dBuV/m)	Read Level (dBuV)	Antenna Factor (dB)	Cable Loss (dB)	Preamp Factor (dB)	Ant Pos (cm)	Table Pos (deg)	Remark
41.88	23.33	-16.67	40	42.44	11.78	0.81	31.7	100	44	Peak
106.68	25.08	-18.42	43.5	44.32	11.2	1.26	31.7	-	-	Peak
167.43	24.32	-19.18	43.5	44.62	9.81	1.55	31.66	-	-	Peak
406.4	19.4	-26.6	46	32.88	15.9	2.42	31.8	-	-	Peak
588.4	22.16	-23.84	46	32.32	19.01	2.9	32.07	-	-	Peak
792.8	24.18	-21.82	46	32.15	20.66	3.36	31.99	-	-	Peak
2390	55.21	-18.79	74	52.3	31.9	5.4	34.39	119	277	Peak
2390	43.5	-10.5	54	40.59	31.9	5.4	34.39	119	277	Average
2437	109.38	-	-	106.37	31.93	5.46	34.38	119	277	Peak
2437	96.77	-	-	93.74	31.95	5.46	34.38	119	277	Average
2484	54.18	-19.82	74	51.05	31.98	5.52	34.37	119	277	Peak
2484	38.77	-15.23	54	35.64	31.98	5.52	34.37	119	277	Average
9748	51.5	-37.88	89.38	61.08	36.91	10.35	56.84	100	0	Peak



Test Mode :	Mode 6	Temperature :	22~25°C
Test Channel :	11	Relative Humidity :	51~54%
Test Engineer :	Wii Chang	Polarization :	Horizontal
Remark :	2462 MHz is Fundamental Signals which can be ignored.		

Frequency (MHz)	Level (dBuV/m)	Over Limit (dB)	Limit Line (dBuV/m)	Read Level (dBuV)	Antenna Factor (dB)	Cable Loss (dB)	Preamp Factor (dB)	Ant Pos (cm)	Table Pos (deg)	Remark
98.58	17.82	-25.68	43.5	37.76	10.53	1.21	31.68	-	-	Peak
150.69	25.55	-17.95	43.5	45.08	10.7	1.46	31.69	100	68	Peak
253.83	25.02	-20.98	46	42.1	12.73	1.87	31.68	-	-	Peak
316.8	20.59	-25.41	46	36.23	13.86	2.12	31.62	-	-	Peak
397.3	19.14	-26.86	46	32.8	15.72	2.4	31.78	-	-	Peak
582.8	22.93	-23.07	46	33.13	18.94	2.9	32.04	-	-	Peak
2380	44.68	-9.32	54	41.79	31.88	5.4	34.39	100	340	Average
2380	55.84	-18.16	74	52.95	31.88	5.4	34.39	100	340	Peak
2462	95.29	-	-	92.21	31.97	5.49	34.38	100	340	Average
2462	108.1	-	-	105.02	31.97	5.49	34.38	100	340	Peak
2483.85	49.58	-4.42	54	46.45	31.98	5.52	34.37	100	340	Average
2483.85	65.85	-8.15	74	62.72	31.98	5.52	34.37	100	340	Peak
4924	49.05	-24.95	74	63.19	34.34	8.04	56.52	100	0	Peak



Test Mode :	Mode 6	Temperature :	22~25°C
Test Channel :	11	Relative Humidity :	51~54%
Test Engineer :	Wii Chang	Polarization :	Vertical
Remark :	1. 2462 MHz is Fundamental Signals which can be ignored. 2. 9848 MHz is not within a restricted band.		

Frequency (MHz)	Level (dBuV/m)	Over Limit (dB)	Limit Line (dBuV/m)	Read Level (dBuV)	Antenna Factor (dB)	Cable Loss (dB)	Preamp Factor (dB)	Ant Pos (cm)	Table Pos (deg)	Remark
43.23	23.37	-16.63	40	43.55	10.71	0.81	31.7	-	-	Peak
102.63	26.9	-16.6	43.5	46.44	10.91	1.24	31.69	100	35	Peak
198.48	23.46	-20.04	43.5	44.11	9.35	1.65	31.65	-	-	Peak
402.9	18.55	-27.45	46	32.11	15.82	2.42	31.8	-	-	Peak
568.8	21.83	-24.17	46	32.19	18.74	2.88	31.98	-	-	Peak
728.4	23.09	-22.91	46	32.06	19.78	3.32	32.07	-	-	Peak
2380	33.84	-20.16	54	30.95	31.88	5.4	34.39	178	336	Average
2380	45.34	-28.66	74	42.45	31.88	5.4	34.39	178	336	Peak
2462	91.32	-	-	88.24	31.97	5.49	34.38	178	336	Average
2462	105.23	-	-	102.15	31.97	5.49	34.38	178	336	Peak
2483.5	42.12	-11.88	54	38.99	31.98	5.52	34.37	178	336	Average
2483.5	61.4	-12.6	74	58.27	31.98	5.52	34.37	178	336	Peak
9848	54.22	-31.01	85.23	63.69	37.01	10.38	56.86	100	0	Peak



Test Mode :	Mode 7	Temperature :	22~25°C
Test Channel :	01	Relative Humidity :	51~54%
Test Engineer :	Wii Chang	Polarization :	Horizontal
Remark :	2412 MHz is Fundamental Signals which can be ignored.		

Frequency (MHz)	Level (dBuV/m)	Over Limit (dB)	Limit Line (dBuV/m)	Read Level (dBuV)	Antenna Factor (dB)	Cable Loss (dB)	Preamp Factor (dB)	Ant Pos (cm)	Table Pos (deg)	Remark
30.54	16.09	-23.91	40	29.78	17.31	0.72	31.72	-	-	Peak
129.63	23.53	-19.97	43.5	42.07	11.77	1.39	31.7	100	69	Peak
252.48	24.68	-21.32	46	41.78	12.7	1.86	31.66	-	-	Peak
315.4	20.06	-25.94	46	35.75	13.82	2.11	31.62	-	-	Peak
479.9	20.12	-25.88	46	31.88	17.41	2.6	31.77	-	-	Peak
621.3	21.97	-24.03	46	31.83	19.22	2.98	32.06	-	-	Peak
2389.42	49.44	-4.56	54	46.53	31.9	5.4	34.39	100	360	Average
2389.42	68.13	-5.87	74	65.22	31.9	5.4	34.39	100	360	Peak
2412	107.81	-	-	104.86	31.91	5.43	34.39	100	360	Peak
2412	94.05	-	-	91.1	31.91	5.43	34.39	100	360	Average
2486	35.32	-18.68	54	32.19	31.98	5.52	34.37	100	360	Average
2486	46.39	-27.61	74	43.26	31.98	5.52	34.37	100	360	Peak



Test Mode :	Mode 7	Temperature :	22~25°C
Test Channel :	01	Relative Humidity :	51~54%
Test Engineer :	Wii Chang	Polarization :	Vertical
Remark :	2412 MHz is Fundamental Signals which can be ignored.		

Frequency (MHz)	Level (dBuV/m)	Over Limit (dB)	Limit Line (dBuV/m)	Read Level (dBuV)	Antenna Factor (dB)	Cable Loss (dB)	Preamp Factor (dB)	Ant Pos (cm)	Table Pos (deg)	Remark
41.88	23.63	-16.37	40	42.74	11.78	0.81	31.7	100	66	Peak
100.74	25.47	-18.03	43.5	45.16	10.76	1.23	31.68	-	-	Peak
158.79	25.44	-18.06	43.5	45.47	10.14	1.48	31.65	-	-	Peak
306.3	17.52	-28.48	46	33.47	13.62	2.08	31.65	-	-	Peak
435.8	18.36	-27.64	46	31.23	16.5	2.47	31.84	-	-	Peak
631.8	21.51	-24.49	46	31.3	19.24	3	32.03	-	-	Peak
2389.99	42.89	-11.11	54	39.98	31.9	5.4	34.39	100	322	Average
2389.99	61.37	-12.63	74	58.46	31.9	5.4	34.39	100	322	Peak
2412	102.26	-	-	99.31	31.91	5.43	34.39	100	322	Peak
2412	89.83	-	-	86.88	31.91	5.43	34.39	100	322	Average
2486	33.9	-20.1	54	30.77	31.98	5.52	34.37	100	322	Average
2486	45.85	-28.15	74	42.72	31.98	5.52	34.37	100	322	Peak



Test Mode :	Mode 8	Temperature :	22~25°C
Test Channel :	06	Relative Humidity :	51~54%
Test Engineer :	Wii Chang	Polarization :	Horizontal
Remark :	2437 MHz is Fundamental Signals which can be ignored.		

Frequency (MHz)	Level (dBuV/m)	Over Limit (dB)	Limit Line (dBuV/m)	Read Level (dBuV)	Antenna Factor (dB)	Cable Loss (dB)	Preamp Factor (dB)	Ant Pos (cm)	Table Pos (deg)	Remark
30	16.56	-23.44	40	29.65	17.91	0.72	31.72	-	-	Peak
150.69	25.46	-18.04	43.5	44.99	10.7	1.46	31.69	100	66	Peak
252.48	24.61	-21.39	46	41.71	12.7	1.86	31.66	-	-	Peak
316.8	20.07	-25.93	46	35.71	13.86	2.12	31.62	-	-	Peak
472.9	20.66	-25.34	46	32.61	17.27	2.58	31.8	-	-	Peak
749.4	23.19	-22.81	46	31.88	20.07	3.35	32.11	-	-	Peak
2356	55.74	-18.26	74	52.95	31.86	5.34	34.41	100	328	Peak
2356	44.92	-9.08	54	42.13	31.86	5.34	34.41	100	328	Average
2437	109.39	-	-	106.36	31.95	5.46	34.38	100	328	Peak
2437	97.07	-	-	94.04	31.95	5.46	34.38	100	328	Average
2484	53.98	-20.02	74	50.85	31.98	5.52	34.37	100	328	Peak
2484	38.77	-15.23	54	35.64	31.98	5.52	34.37	100	328	Average



Test Mode :	Mode 8	Temperature :	22~25°C
Test Channel :	06	Relative Humidity :	51~54%
Test Engineer :	Wii Chang	Polarization :	Vertical
Remark :	2437 MHz is Fundamental Signals which can be ignored.		

Frequency (MHz)	Level (dBuV/m)	Over Limit (dB)	Limit Line (dBuV/m)	Read Level (dBuV)	Antenna Factor (dB)	Cable Loss (dB)	Preamp Factor (dB)	Ant Pos (cm)	Table Pos (deg)	Remark
42.69	23.62	-16.38	40	43.26	11.25	0.81	31.7	100	67	Peak
104.79	25.62	-17.88	43.5	45	11.06	1.25	31.69	-	-	Peak
165.54	25.15	-18.35	43.5	45.4	9.88	1.53	31.66	-	-	Peak
327.3	17.7	-28.3	46	33.06	14.09	2.15	31.6	-	-	Peak
425.3	19.08	-26.92	46	32.15	16.3	2.46	31.83	-	-	Peak
645.8	22.81	-23.19	46	32.48	19.27	3.04	31.98	-	-	Peak
2356	49.53	-24.47	74	46.74	31.86	5.34	34.41	120	329	Peak
2356	38.29	-15.71	54	35.5	31.86	5.34	34.41	120	329	Average
2437	103.26	-	-	100.23	31.95	5.46	34.38	120	329	Peak
2437	90.82	-	-	87.79	31.95	5.46	34.38	120	329	Average
2484	47.82	-26.18	74	44.69	31.98	5.52	34.37	120	329	Peak
2484	35.22	-18.78	54	32.09	31.98	5.52	34.37	120	329	Average



Test Mode :	Mode 9	Temperature :	22~25°C
Test Channel :	11	Relative Humidity :	51~54%
Test Engineer :	Wii Chang	Polarization :	Horizontal
Remark :	2462 MHz is Fundamental Signals which can be ignored.		

Frequency (MHz)	Level (dBuV/m)	Over Limit (dB)	Limit Line (dBuV/m)	Read Level (dBuV)	Antenna Factor (dB)	Cable Loss (dB)	Preamp Factor (dB)	Ant Pos (cm)	Table Pos (deg)	Remark
30	17.06	-22.94	40	30.15	17.91	0.72	31.72	-	-	Peak
143.94	24.32	-19.18	43.5	43.42	11.15	1.45	31.7	100	54	Peak
255.18	24.93	-21.07	46	41.99	12.75	1.87	31.68	-	-	Peak
315.4	20.36	-25.64	46	36.05	13.82	2.11	31.62	-	-	Peak
614.3	22.77	-23.23	46	32.7	19.2	2.96	32.09	-	-	Peak
836.9	26.77	-19.23	46	34.12	21.09	3.49	31.93	-	-	Peak
2380	44.2	-9.8	54	41.31	31.88	5.4	34.39	100	340	Average
2380	54.78	-19.22	74	51.89	31.88	5.4	34.39	100	340	Peak
2462	95.61	-	-	92.53	31.97	5.49	34.38	100	340	Average
2462	108.61	-	-	105.53	31.97	5.49	34.38	100	340	Peak
2483.66	50.78	-3.22	54	47.65	31.98	5.52	34.37	100	340	Average
2483.66	68.23	-5.77	74	65.1	31.98	5.52	34.37	100	340	Peak



Test Mode :	Mode 9	Temperature :	22~25°C
Test Channel :	11	Relative Humidity :	51~54%
Test Engineer :	Wii Chang	Polarization :	Vertical
Remark :	2462 MHz is Fundamental Signals which can be ignored.		

Frequency (MHz)	Level (dBuV/m)	Over Limit (dB)	Limit Line (dBuV/m)	Read Level (dBuV)	Antenna Factor (dB)	Cable Loss (dB)	Preamp Factor (dB)	Ant Pos (cm)	Table Pos (deg)	Remark
43.23	23.62	-16.38	40	43.8	10.71	0.81	31.7	100	64	Peak
99.93	25.76	-17.74	43.5	45.53	10.69	1.22	31.68	-	-	Peak
166.08	24.47	-19.03	43.5	44.72	9.88	1.53	31.66	-	-	Peak
379.8	19.22	-26.78	46	33.32	15.31	2.34	31.75	-	-	Peak
574.4	22.27	-23.73	46	32.57	18.82	2.88	32	-	-	Peak
722.8	22.74	-23.26	46	31.79	19.7	3.31	32.06	-	-	Peak
2366	33.39	-20.61	54	30.56	31.86	5.37	34.4	145	359	Average
2366	45.12	-28.88	74	42.29	31.86	5.37	34.4	145	359	Peak
2462	88.58	-	-	85.5	31.97	5.49	34.38	145	359	Average
2462	101.32	-	-	98.24	31.97	5.49	34.38	145	359	Peak
2484.61	40.01	-13.99	54	36.88	31.98	5.52	34.37	145	359	Average
2484.61	57.29	-16.71	74	54.16	31.98	5.52	34.37	145	359	Peak



3.8 Antenna Requirements

3.8.1 Standard Applicable

If directional gain of transmitting antennas is greater than 6dBi, the power shall be reduced by the same level in dB comparing to gain minus 6dBi. For the fixed point-to-point operation, the power shall be reduced by one dB for every 3 dB that the directional gain of the antenna exceeds 6 dBi. The use of a permanently attached antenna or of an antenna that uses a unique coupling to the intentional radiator shall be considered sufficient to comply with the FCC rule.

3.8.2 Antenna Connected Construction

The antennas type used in this product is PIFA Antenna without connector and it is considered to meet antenna requirement.

3.8.3 Antenna Gain

The antenna peak gain of EUT is less than 6 dBi. Therefore, it is not necessary to reduce maximum peak output power limit.



4 List of Measuring Equipment

Instrument	Manufacturer	Model No.	Serial No.	Characteristics	Calibration Date	Due Date	Remark
System Simulator	R&S	CMU200	117995	N/A	Jul. 28, 2011	Jul. 27, 2012	Conducted (TH02-HY)
Spectrum Analyzer	R&S	FSP40	100055	9kHz~40GHz	Jun. 13, 2011	Jun. 12, 2012	Conducted (TH02-HY)
Power Meter	Anritsu	ML2495A	0932001	N/A	Sep. 13, 2010	Sep. 12, 2011	Conducted (TH02-HY)
Power Sensor	Anritsu	MA2411B	0846202	N/A	Sep. 14, 2010	Sep. 13, 2011	Conducted (TH02-HY)
Thermal Chamber	Ten Billion	TTH-D35P	TBN-930701	N/A	Jul. 27, 2011	Jul. 26, 2012	Conducted (TH02-HY)
EMI Test Receive	R&S	ESCI 7	100724	9kHz~7GHz	Aug. 19, 2010	Aug. 18, 2011	Conduction (CO05-HY)
Two-LISN	R&S	ENV216	11-100081	9KHz – 30MHz	Dec. 03, 2010	Dec. 02, 2011	Conduction (CO05-HY)
Two-LISN	R&S	ENV216	11-100080	9KHz – 30MHz	Dec. 01, 2010	Nov. 30, 2011	Conduction (CO05-HY)
AC Power Source	APC	APC-1000W	N/A	N/A	N/A	N/A	Conduction (CO05-HY)
System Simulator	R&S	CMU200	117591	N/A	Oct. 18, 2010	Oct. 17, 2011	Conduction (CO05-HY)
GPS Station	T&E	GS-50	N/A	N/A	N/A	N/A	Conduction (CO05-HY)
Spectrum Analyzer	R&S	FSP40	100057	9KHz-40GHz	Oct. 25, 2010	Oct. 24, 2011	Radiation (03CH06-HY)
EMI Test Receiver	R&S	ESVS10	834468/003	20MHz-1000MHz	May 10, 2011	May 09, 2012	Radiation (03CH06-HY)
Bilog Antenna	SCHAFFNER	CBL6112B	2885	30MHz -2GHz	Oct. 31, 2010	Oct. 31, 2011	Radiation (03CH06-HY)
Double Ridge Horn Antenna	EMCO	3117	00066583	1GHz~18GHz	Aug. 01, 2011	Jul. 31, 2012	Radiation (03CH06-HY)
Double Ridge Horn Antenna	Training Research	AH-0801	95119	8GHz~18GHz	Oct. 20, 2010	Oct. 19, 2011	Radiation (03CH06-HY)
SHF-EHF Horn Antenna	SCHWARZBECK	BBHA 9170	BBHA9170251	15GHz- 40GHz	Oct. 18, 2010	Oct. 17, 2011	Radiation (03CH06-HY)
Pre Amplifier	Agilent	8449B	3008A01917	1GHz- 26.5GHz	Apr. 14, 2011	Apr. 13, 2012	Radiation (03CH06-HY)
Amplifier	Agilent	310N	186713	9KHz~1GHz	Apr. 14, 2011	Apr. 13, 2012	Radiation (03CH06-HY)

5 Uncertainty of Evaluation

Uncertainty of Conducted Emission Measurement (150 kHz ~ 30 MHz)

Contribution	Uncertainty of X_i		$u(X_i)$
	dB	Probability Distribution	
Receiver Reading	0.10	Normal (k=2)	0.05
Cable Loss	0.10	Normal (k=2)	0.05
AMN Insertion Loss	2.50	Rectangular	0.63
Receiver Specification	1.50	Rectangular	0.43
Site Imperfection	1.39	Rectangular	0.80
Mismatch	+0.34 / -0.35	U-Shape	0.24
Combined Standard Uncertainty $U_c(y)$	1.13		
Measuring Uncertainty for a Level of Confidence of 95% ($U = 2U_c(y)$)	2.26		

Uncertainty of Radiated Emission Measurement (30 MHz ~ 1000 MHz)

Contribution	Uncertainty of X_i		$u(X_i)$
	dB	Probability Distribution	
Receiver Reading	0.41	Normal (k=2)	0.21
Antenna Factor Calibration	0.83	Normal (k=2)	0.42
Cable Loss Calibration	0.25	Normal (k=2)	0.13
Pre-Amplifier Gain Calibration	0.27	Normal (k=2)	0.14
RCV/SPA Specification	2.50	Rectangular	0.72
Antenna Factor Interpolation for Frequency	1.00	Rectangular	0.29
Site Imperfection	1.43	Rectangular	0.83
Mismatch	+0.39 / -0.41	U-Shape	0.28
Combined Standard Uncertainty $U_c(y)$	1.27		
Measuring Uncertainty for a Level of Confidence of 95% ($U = 2U_c(y)$)	2.54		



Uncertainty of Radiated Emission Measurement (1 GHz ~ 40 GHz)

Contribution	Uncertainty of X_i		$u(X_i)$	C_i	$C_i * u(X_i)$
	dB	Probability Distribution			
Receiver Reading	±0.10	Normal (k=2)	0.10	1	0.10
Antenna Factor Calibration	±1.70	Normal (k=2)	0.85	1	0.85
Cable Loss Calibration	±0.50	Normal (k=2)	0.25	1	0.25
Receiver Correction	±2.00	Rectangular	1.15	1	1.15
Antenna Factor Directional	±1.50	Rectangular	0.87	1	0.87
Site Imperfection	±2.80	Triangular	1.14	1	1.14
Mismatch Receiver VSWR $\Gamma_1 = 0.197$ Antenna VSWR $\Gamma_2 = 0.194$ Uncertainty = $20\text{Log}(1-\Gamma_1*\Gamma_2)$	+0.34 / -0.35	U-Shape	0.244	1	0.244
Combined Standard Uncertainty $U_c(y)$	2.36				
Measuring Uncertainty for a Level of Confidence of 95% ($U = 2U_c(y)$)	4.72				



Appendix A. Photographs of EUT

Please refer to Sporton report number EP172802-02 as below.