

# FCC RF Test Report

APPLICANT : Acer Incorporated  
EQUIPMENT : Smart HandHeld  
BRAND NAME : acer  
MODEL NAME : E310  
FCC ID : HLZDME310SCCE  
STANDARD : FCC 47 CFR Part 2, 22(H), 24(E)  
CLASSIFICATION : PCS Licensed Transmitter Held to Ear (PCE)  
Tx/Rx FREQUENCY RANGE : GSM850 : 824.2 ~ 848.8 MHz /  
869.2 ~ 893.8 MHz  
GSM1900 : 1850.2 ~ 1909.8 MHz /  
1930.2 ~ 1989.8 MHz  
MAX. ERP/EIRP POWER : GSM850 (GSM) : 0.58 W  
GSM850 (EDGE 8) : 0.19 W  
GSM1900 (GSM) : 0.94 W  
GSM1900 (EDGE 8) : 0.43 W  
EMISSION DESIGNATOR : GMSK : 248KGXW  
8PSK : 244KG7W

The product was received on Dec. 23, 2010 and completely tested on Dec. 30, 2010. We, SPORTON INTERNATIONAL INC., would like to declare that the tested sample has been evaluated in accordance with the procedures given in ANSI / TIA / EIA-603-C-2004 and shown compliance with the applicable technical standards.

The test results in this report apply exclusively to the tested model / sample. Without written approval of SPORTON INTERNATIONAL INC., the test report shall not be reproduced except in full.

Reviewed by:



Anderson Chiu / Deputy Manager



## SPORTON INTERNATIONAL INC.

No. 52, Hwa Ya 1<sup>st</sup> Rd., Hwa Ya Technology Park, Kwei-Shan Hsiang, Tao Yuan Hsien, Taiwan, R.O.C.



# TABLE OF CONTENTS

**REVISION HISTORY.....3**

**SUMMARY OF TEST RESULT .....4**

**1 GENERAL DESCRIPTION .....5**

    1.1 Applicant.....5

    1.2 Manufacturer .....5

    1.3 Feature of Equipment Under Test.....6

    1.4 Testing Site.....7

    1.5 Applied Standards .....7

    1.6 Ancillary Equipment List.....7

**2 TEST CONFIGURATION OF EQUIPMENT UNDER TEST .....8**

    2.1 Test Mode.....8

    2.2 Connection Diagram of Test System .....9

**3 TEST RESULT.....10**

    3.1 Conducted Output Power Measurement.....10

    3.2 Effective Radiated Power and Effective Isotropic Radiated Power Measurement .....12

    3.3 Occupied Bandwidth Measurement .....16

    3.4 Band Edge Measurement.....21

    3.5 Conducted Emission Measurement .....27

    3.6 Field Strength of Spurious Radiation Measurement .....38

    3.7 Frequency Stability Measurement.....48

**4 LIST OF MEASURING EQUIPMENT .....52**

**5 UNCERTAINTY OF EVALUATION.....53**

**APPENDIX A. PHOTOGRAPHS OF EUT**

**APPENDIX B. SETUP PHOTOGRAPHS**





### SUMMARY OF TEST RESULT

Report Section	FCC Rule	IC Rule	Description	Limit	Result	Remark
3.1	§2.1046	N/A	Conducted Output Power	N/A	PASS	-
3.2	§22.913(a)(2)	RSS-132(4.4) SRSP-503(5.1.3)	Effective Radiated Power	< 7 Watts	PASS	-
3.2	§24.232(c)	RSS-133 (6.4) SRSP-510(5.1.2)	Equivalent Isotropic Radiated Power	< 2 Watts	PASS	-
3.3	§2.1049 §22.917(a) §24.238(a)	N/A	Occupied Bandwidth	N/A	PASS	-
3.4	§2.1051 §22.917(a) §24.238(a)	RSS-132 (4.5.1) RSS-133 (6.5.1)	Band Edge Measurement	< 43+10log <sub>10</sub> (P[Watts])	PASS	-
3.5	§2.1051 §22.917(a) §24.238(a)	RSS-132 (4.5.1) RSS-133 (6.5.1)	Conducted Emission	< 43+10log <sub>10</sub> (P[Watts])	PASS	-
3.6	§2.1053 §22.917(a) §24.238(a)	RSS-132 (4.5.1) RSS-133 (6.5.1)	Field Strength of Spurious Radiation	< 43+10log <sub>10</sub> (P[Watts])	PASS	Under limit 17.51 dB at 13160 MHz
3.7	§2.1055 §22.355 §24.235	RSS-132(4.3) RSS-133(6.3)	Frequency Stability for Temperature & Voltage	< 2.5 ppm	PASS	-



# **1 General Description**

## **1.1 Applicant**

**Acer Incorporated**

8F., No. 88, Sec. 1, Hsin Tai Wu Rd., Hsichih Town, Taipei Hsien, Taiwan, R.O.C.

## **1.2 Manufacturer**

**Compal Communications(Nanjing)Co., Ltd.**

Nanjing Jiangning Export Processing Zone (South Area) No. 68-2 Suyuan Street

### 1.3 Feature of Equipment Under Test

Product Feature & Specification	
Equipment	Smart HandHeld
Brand Name	acer
Model Name	E310
FCC ID	HLZDME310SCCE
Tx Frequency	GSM850 : 824 MHz ~ 849 MHz GSM1900 : 1850 MHz ~ 1910 MHz
Rx Frequency	GSM850 : 869 MHz ~ 894 MHz GSM1900 : 1930 MHz ~ 1990 MHz
Maximum Output Power to Antenna	GSM850 : 32.95 dBm GSM1900 : 29.69 dBm
Maximum ERP/EIRP	GSM850 (GSM) : 0.58 W (27.65 dBm) GSM850 (EDGE 8) : 0.19 W (22.71 dBm) GSM1900 (GSM) : 0.94 W (29.72 dBm) GSM1900 (EDGE 8) : 0.43 W (26.34 dBm)
Antenna Type	Fixed Internal Antenna
HW Version	DVT2-1
SW Version	Android version: 2.2 Baseband version: E310_0.011.0K Build number: ACER_E310_0.011.0K_EMEA_GEN1
Type of Modulation	GSM / GPRS : GMSK EDGE : 8PSK
Type of Emission	GMSK : 248KGXW 8PSK : 244KG7W
EUT Stage	Identical Prototype

**Remark:**

1. For other wireless features of this EUT, the test report will be issued separately.
2. This test report recorded only product characteristics and test results of PCS Licensed Transmitter Held to Ear (PCE).
3. The above EUT's information was declared by manufacturer. Please refer to the specifications or user's manual for more detailed description.

## 1.4 Testing Site

<b>Test Site</b>	SPORTON INTERNATIONAL INC.		
<b>Test Site Location</b>	No. 52, Hwa Ya 1 <sup>st</sup> Rd., Hwa Ya Technology Park, Kwei-Shan Hsiang, Tao Yuan Hsien, Taiwan, R.O.C. TEL: +886-3-327-3456 FAX: +886-3-328-4978		
<b>Test Site No.</b>	<b>Sporton Site No.</b>		<b>FCC/IC Registration No.</b>
	TH02-HY	03CH07-HY	722060/4086B-1

## 1.5 Applied Standards

According to the specifications of the manufacturer, the EUT must comply with the requirements of the following standards:

- ♦ Preliminary Guidance for Receiving Applications for Certification of 3G Device. May 9, 2006.
- ♦ FCC 47 CFR Part 2, 22(H), 24(E)
- ♦ ANSI / TIA / EIA-603-C-2004
- ♦ IC RSS-132 Issue 2
- ♦ IC RSS-133 Issue 5

**Remark:**

1. All test items were verified and recorded according to the standards and without any deviation during the test.
2. This EUT has also been tested and complied with the requirements of FCC Part 15, Subpart B (DoC), recorded in a separate test report.

## 1.6 Ancillary Equipment List

Item	Equipment	Trade Name	Model No.	FCC ID	Data Cable	Power Cord
1.	System Simulator	R&S	CMU200	N/A	N/A	Unshielded, 1.8 m

## 2 Test Configuration of Equipment Under Test

### 2.1 Test Mode

During all testing, EUT is in link mode with base station emulator at maximum power level. The spurious emission measurements were carried out in semi-anechoic chamber with 3-meter test range, and EUT is rotated on three test planes to find out the worst emission.

Frequency range investigated for radiated emission is as follows:

1. 30 MHz to 9000 MHz for GSM850.
2. 30 MHz to 19000 MHz for GSM1900.

Test Modes		
Band	Radiated TCs	Conducted TCs
GSM 850	<ul style="list-style-type: none"> <li>■ GSM Link</li> <li>■ EDGE 8 Link</li> </ul>	<ul style="list-style-type: none"> <li>■ GSM Link</li> <li>■ EDGE 8 Link</li> </ul>
GSM 1900	<ul style="list-style-type: none"> <li>■ GSM Link</li> <li>■ EDGE 8 Link</li> </ul>	<ul style="list-style-type: none"> <li>■ GSM Link</li> <li>■ EDGE 8 Link</li> </ul>

**Note:**

1. The maximum power levels are GSM mode for GMSK link, EDGE multi-slot class 8 mode for 8PSK link, only these modes were used for all tests.
2. Because there are individual antennas for each WWAN, WLAN, and Bluetooth, the co-location test modes are not required.

The conducted power tables are as follows:

Conducted Power (*Unit: dBm)						
Band	GSM850			GSM1900		
Channel	128	189	251	512	661	810
Frequency	824.2	836.4	848.8	1850.2	1880.0	1909.8
GSM	32.86	32.92	32.95	29.68	29.69	29.54
GPRS 8	32.84	32.90	32.94	29.64	29.67	29.53
GPRS 10	31.30	32.36	31.39	28.10	28.14	28.08
GPRS 12	28.79	28.86	28.88	25.60	25.64	25.50
EGPRS 8	27.39	27.46	27.50	26.19	26.23	26.10
EGPRS 10	25.90	25.96	26.00	24.67	24.71	24.57
EGPRS 12	23.40	23.46	23.49	22.20	22.23	22.10



## 2.2 Connection Diagram of Test System

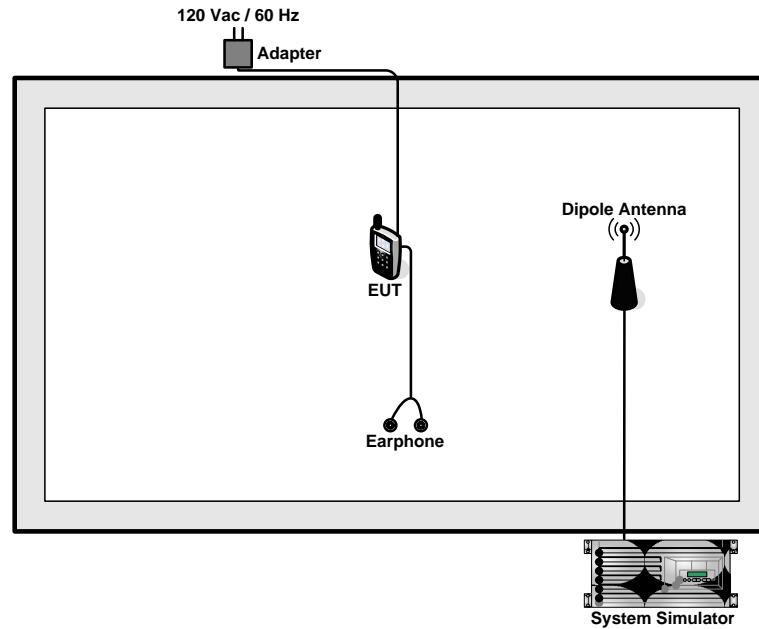

### 3 Test Result

#### 3.1 Conducted Output Power Measurement

##### 3.1.1 Description of the Conducted Output Power Measurement

A base station simulator was used to establish communication with the EUT. Its parameters were set to transmit the maximum power on the EUT. The measured power in the radio frequency on the transmitter output terminals shall be reported.

##### 3.1.2 Measuring Instruments

See list of measuring instruments of this test report.

##### 3.1.3 Test Procedures

1. The transmitter output port was connected to base station.
2. Set EUT at maximum power through base station.
3. Select lowest, middle, and highest channels for each band and different modulation.

##### 3.1.4 Test Setup

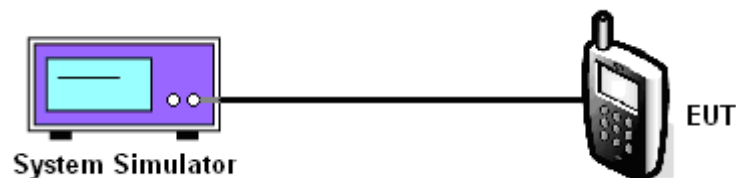



3.1.5 Test Result of Conducted Output Power

Cellular Band				
Modes	Channel	Frequency (MHz)	Conducted Power (dBm)	Conducted Power (Watts)
GSM850 (GSM)	128 (Low)	824.2	32.86	1.93
	189 (Mid)	836.4	32.92	1.96
	251 (High)	848.8	32.95	1.97
GSM850 (EDGE 8)	128 (Low)	824.2	27.39	0.55
	189 (Mid)	836.4	27.46	0.56
	251 (High)	848.8	27.50	0.56

PCS Band				
Modes	Channel	Frequency (MHz)	Conducted Power (dBm)	Conducted Power (Watts)
GSM1900 (GSM)	512 (Low)	1850.2	29.68	0.93
	661 (Mid)	1880.0	29.69	0.93
	810 (High)	1909.8	29.54	0.90
GSM1900 (EDGE 8)	512 (Low)	1850.2	26.19	0.42
	661 (Mid)	1880.0	26.23	0.42
	810 (High)	1909.8	26.10	0.41

## 3.2 Effective Radiated Power and Effective Isotropic Radiated Power Measurement

### 3.2.1 Description of the ERP/EIRP Measurement

ERP/EIRP is measured by substitution method according to ANSI / TIA / EIA-603-C-2004. The ERP of mobile transmitters must not exceed 7 Watts and the EIRP of mobile transmitters are limited to 2 Watts.

### 3.2.2 Measuring Instruments

See list of measuring instruments of this test report.

### 3.2.3 Test Procedures

1. The EUT was placed on a turntable with 1.0 meter height in a fully anechoic chamber.
2. The EUT was set at 1.2 meters from the receiving antenna, which was mounted on the antenna tower.
3. The table was rotated 360 degrees to determine the position of the highest radiated power.
4. The height of the receiving antenna is adjusted to look for the maximum ERP/EIRP.
5. Taking the record of maximum ERP/EIRP.
6. A dipole antenna was substituted in place of the EUT and was driven by a signal generator.
7. The conducted power at the terminal of the dipole antenna is measured.
8. Repeat step 3 to step 5 to get the maximum ERP/EIRP of the substitution antenna.
9.  $ERP/EIRP = P_s + E_t - E_s + G_s = P_s + R_t - R_s + G_s$   
Ps (dBm) : Input power to substitution antenna.  
Gs (dBi or dBd) : Substitution antenna Gain.  
 $E_t = R_t + AF$   
 $E_s = R_s + AF$   
AF (dB/m) : Receive antenna factor  
Rt : The highest received signal in spectrum analyzer for EUT.  
Rs : The highest received signal in spectrum analyzer for substitution antenna.

### 3.2.4 Test Setup

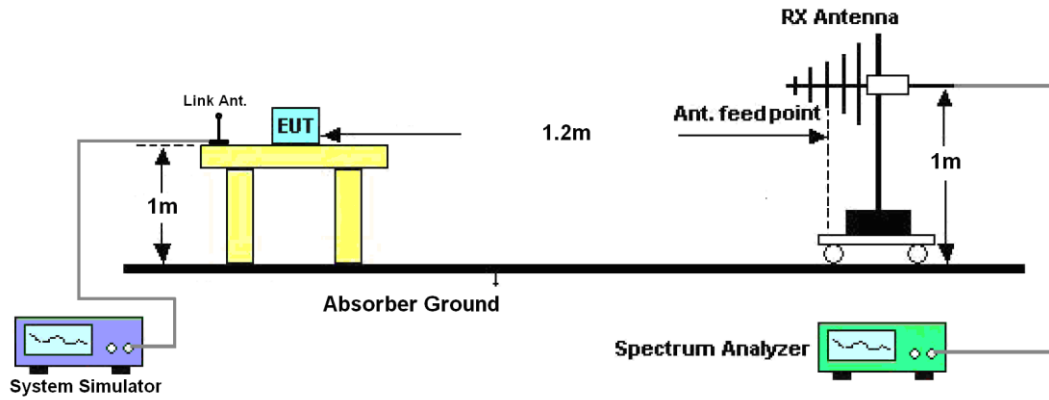



3.2.5 Test Result of ERP

GSM850 (GSM) Radiated Power ERP						
Horizontal Polarization						
Frequency (MHz)	Rt (dBm)	Rs (dBm)	Ps (dBm)	Gs (dBd)	ERP (dBm)	ERP (W)
824.20	-36.26	-48.12	0.00	-1.08	10.78	0.01
836.40	-35.30	-48.28	0.00	-0.93	12.05	0.02
848.80	-34.90	-48.35	0.00	-0.76	12.69	0.02
Vertical Polarization						
Frequency (MHz)	Rt (dBm)	Rs (dBm)	Ps (dBm)	Gs (dBd)	ERP (dBm)	ERP (W)
824.20	-21.00	-47.97	0.00	-1.08	25.89	0.39
836.40	-19.89	-48.01	0.00	-0.93	27.19	0.52
848.80	-19.64	-48.05	0.00	-0.76	27.65	0.58

GSM850 (EDGE 8) Radiated Power ERP						
Horizontal Polarization						
Frequency (MHz)	Rt (dBm)	Rs (dBm)	Ps (dBm)	Gs (dBd)	ERP (dBm)	ERP (W)
824.20	-40.65	-48.12	0.00	-1.08	6.39	0.00
836.40	-39.88	-48.28	0.00	-0.93	7.47	0.01
848.80	-39.80	-48.35	0.00	-0.76	7.79	0.01
Vertical Polarization						
Frequency (MHz)	Rt (dBm)	Rs (dBm)	Ps (dBm)	Gs (dBd)	ERP (dBm)	ERP (W)
824.20	-25.36	-47.97	0.00	-1.08	21.53	0.14
836.40	-24.69	-48.01	0.00	-0.93	22.39	0.17
848.80	-24.58	-48.05	0.00	-0.76	22.71	0.19



3.2.6 Test Result of EIRP

GSM1900 (GSM) Radiated Power EIRP						
Horizontal Polarization						
Frequency (MHz)	Rt (dBm)	Rs (dBm)	Ps (dBm)	Gs (dBi)	EIRP (dBm)	EIRP (W)
1850.20	-26.90	-51.88	0.00	1.96	26.94	0.49
1880.00	-27.65	-52.99	0.00	2.00	27.34	0.54
1909.80	-29.04	-54.28	0.00	1.98	27.22	0.53
Vertical Polarization						
Frequency (MHz)	Rt (dBm)	Rs (dBm)	Ps (dBm)	Gs (dBi)	EIRP (dBm)	EIRP (W)
1850.20	-24.98	-52.13	0.00	1.96	29.11	0.81
1880.00	-25.45	-53.17	0.00	2.00	29.72	0.94
1909.80	-26.45	-54.13	0.00	1.98	29.66	0.92

GSM1900 (EDGE 8) Radiated Power EIRP						
Horizontal Polarization						
Frequency (MHz)	Rt (dBm)	Rs (dBm)	Ps (dBm)	Gs (dBi)	EIRP (dBm)	EIRP (W)
1850.20	-30.26	-51.88	0.00	1.96	23.58	0.23
1880.00	-31.28	-52.99	0.00	2.00	23.71	0.23
1909.80	-32.46	-54.28	0.00	1.98	23.80	0.24
Vertical Polarization						
Frequency (MHz)	Rt (dBm)	Rs (dBm)	Ps (dBm)	Gs (dBi)	EIRP (dBm)	EIRP (W)
1850.20	-28.36	-52.13	0.00	1.96	25.73	0.37
1880.00	-28.83	-53.17	0.00	2.00	26.34	0.43
1909.80	-29.84	-54.13	0.00	1.98	26.27	0.42

### 3.3 Occupied Bandwidth Measurement

#### 3.3.1 Description of Occupied Bandwidth Measurement

The emission bandwidth is defined as the width of the signal between two points, located at the 2 sides of the carrier frequency, outside of which all emissions are attenuated at least 26 dB below the transmitter power.

#### 3.3.2 Measuring Instruments

See list of measuring instruments of this test report.

#### 3.3.3 Test Procedures

1. The EUT was connected to Spectrum Analyzer and Base Station via power divider.
2. The 99% and 26 dB occupied bandwidth (BW) of the middle channel for the highest RF powers were measured.

#### 3.3.4 Test Setup

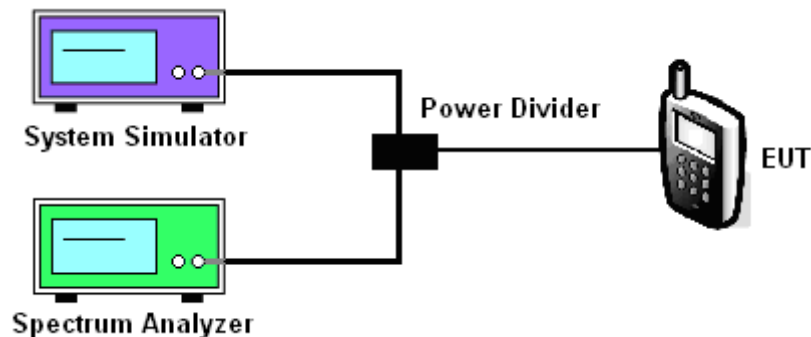





3.3.5 Test Result (Plots) of Occupied Bandwidth

Band :	GSM 850	Power Stage :	High
Test Mode :	GSM Link		

99% Occupied Bandwidth Plot on Channel 189

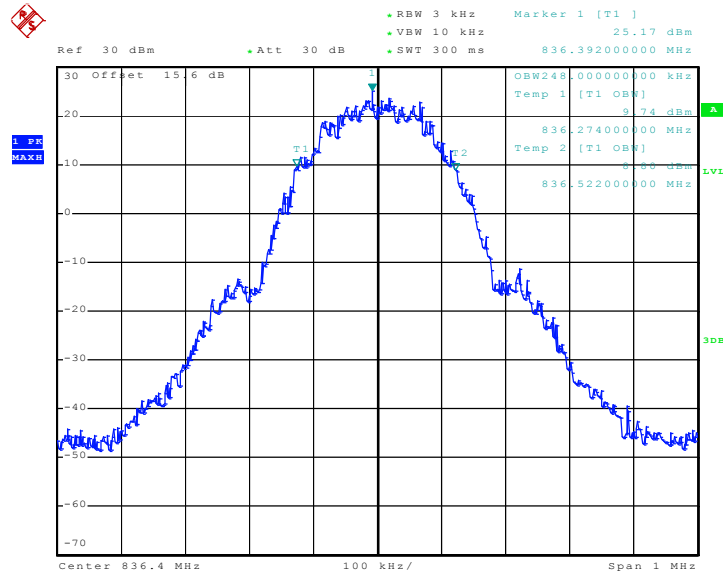

Date: 28.DEC.2010 09:55:37

26dB Bandwidth Plot on Channel 189

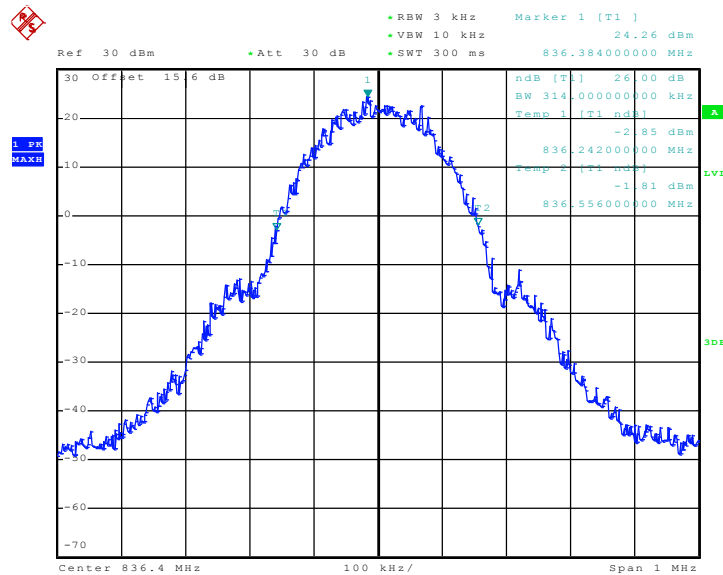

Date: 28.DEC.2010 09:54:18



<b>Band :</b>	GSM 850	<b>Power Stage :</b>	High
<b>Test Mode :</b>	EDGE 8 Link		

99% Occupied Bandwidth Plot on Channel 189

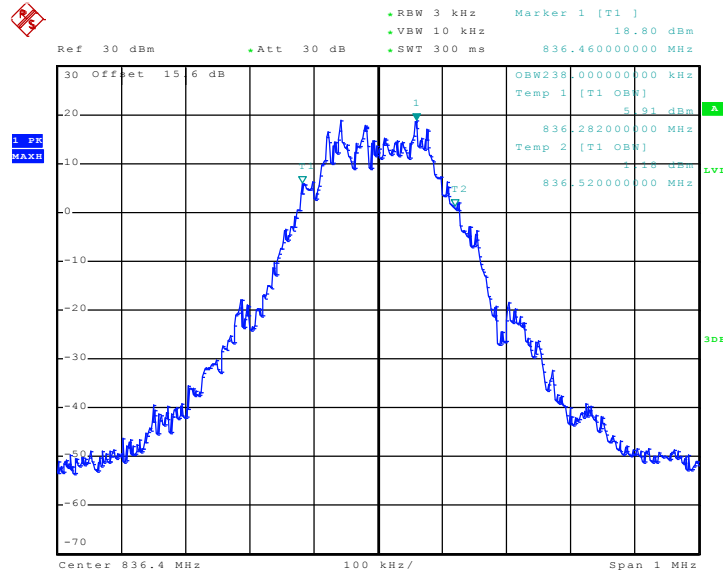

Date: 28.DEC.2010 10:40:47

26dB Bandwidth Plot on Channel 189

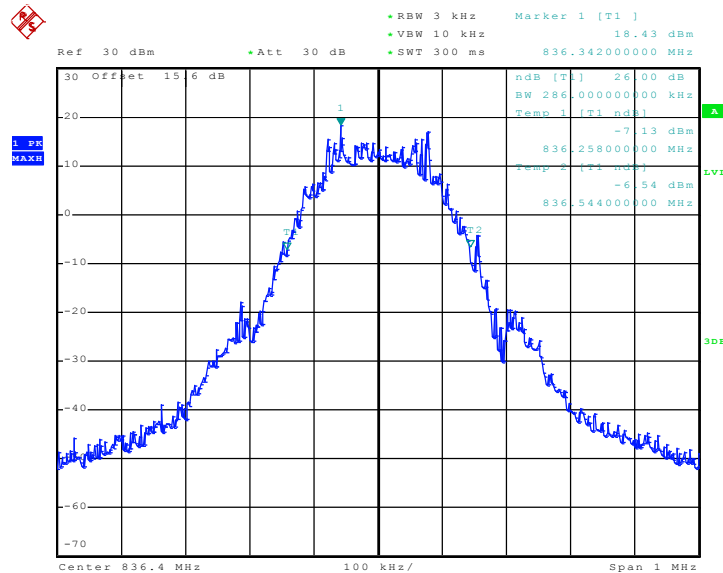

Date: 28.DEC.2010 10:39:28



<b>Band :</b>	GSM 1900	<b>Power Stage :</b>	High
<b>Test Mode :</b>	GSM Link		

**99% Occupied Bandwidth Plot on Channel 661**

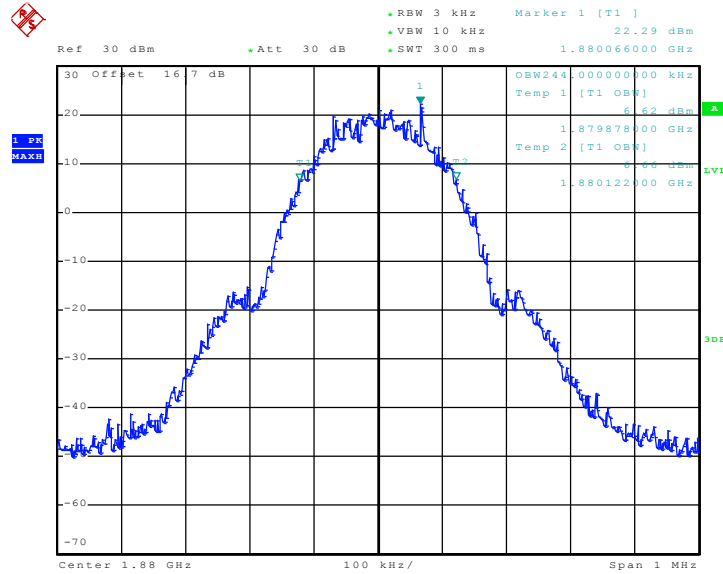

Date: 28.DEC.2010 11:32:24

**26dB Bandwidth Plot on Channel 661**

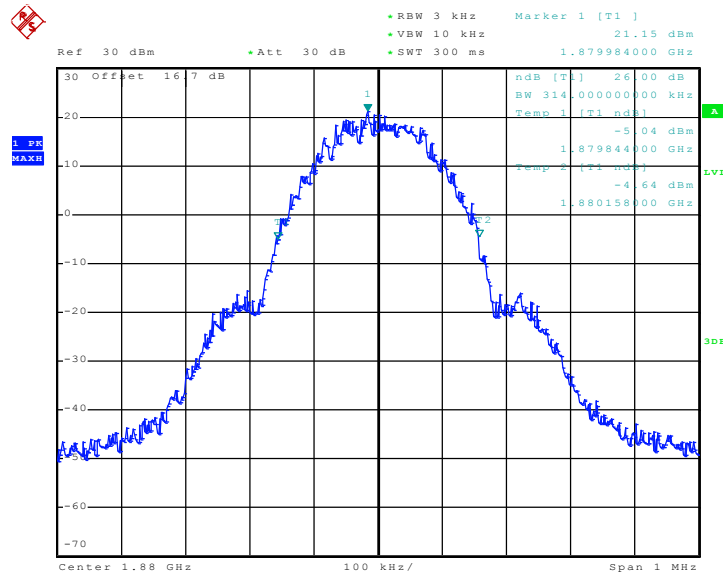

Date: 28.DEC.2010 11:31:01



Band :	GSM 1900	Power Stage :	High
Test Mode :	EDGE 8 Link		

99% Occupied Bandwidth Plot on Channel 661

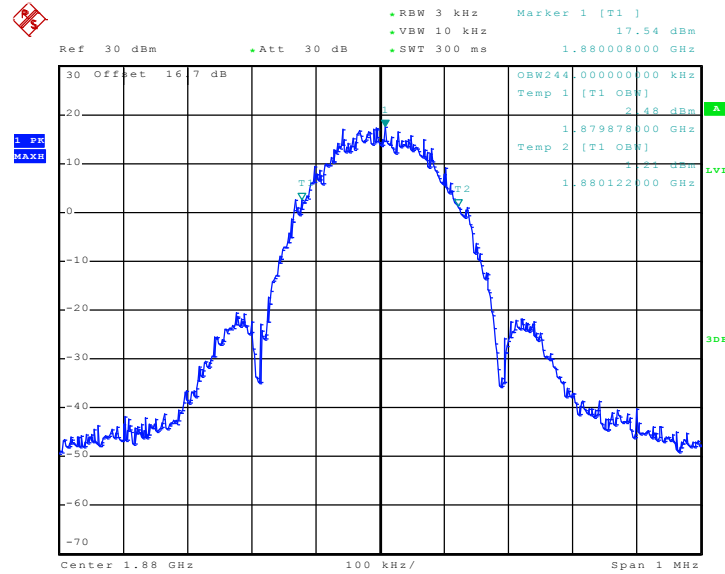

Date: 28.DEC.2010 12:40:01

26dB Bandwidth Plot on Channel 661

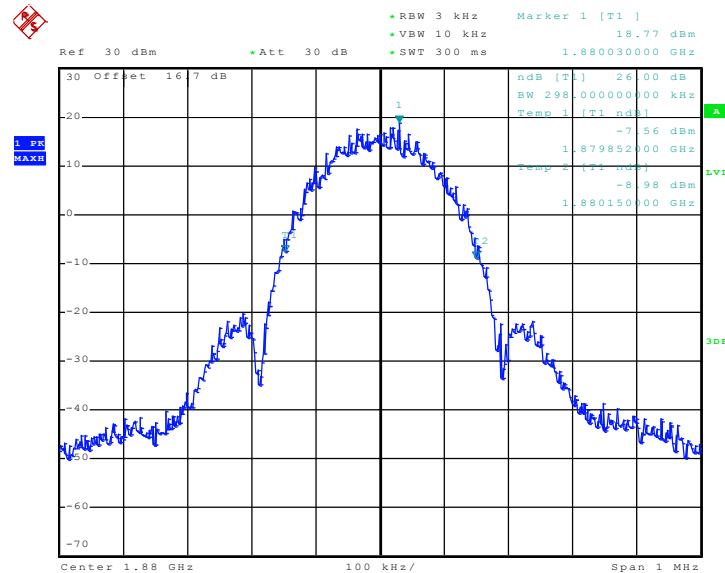

Date: 28.DEC.2010 12:38:38



## **3.4 Band Edge Measurement**

### **3.4.1 Description of Band Edge Measurement**

The power of any emission outside of the authorized operating frequency ranges must be lower than the transmitter power (P) by a factor of at least  $43 + 10 \log (P)$  dB.

### **3.4.2 Measuring Instruments**

See list of measuring instruments of this test report.

### **3.4.3 Test Procedures**

1. The EUT was connected to Spectrum Analyzer and Base Station via power divider.
2. The band edges of low and high channels for the highest RF powers were measured. Setting RBW as roughly BW/100.

### 3.4.4 Test Setup

<Conducted Band Edge >

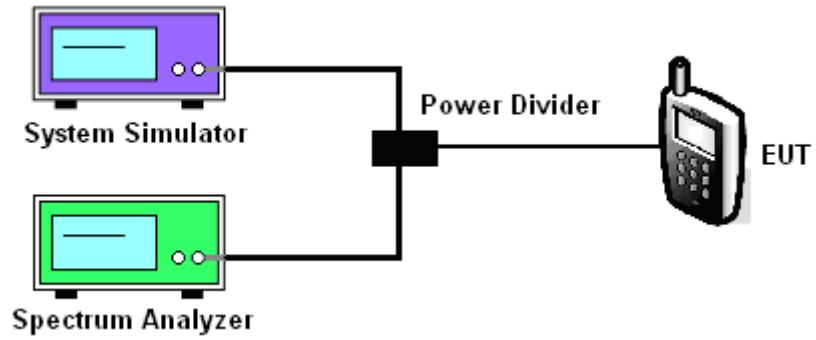



### 3.4.5 Test Result (Plots) of Conducted Band Edge

Band :	GSM850	Power Stage :	High
Test Mode :	GSM Link		

Lower Band Edge Plot on Channel 128

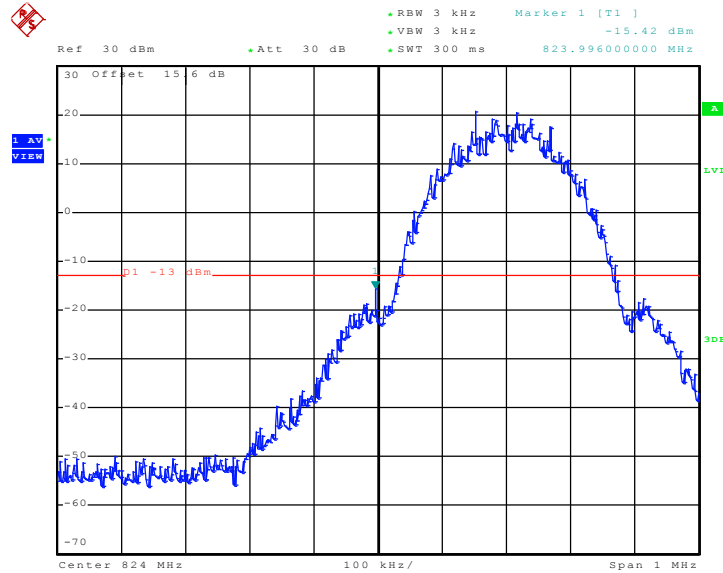

Date: 28.DEC.2010 09:57:29

Higher Band Edge Plot on Channel 251

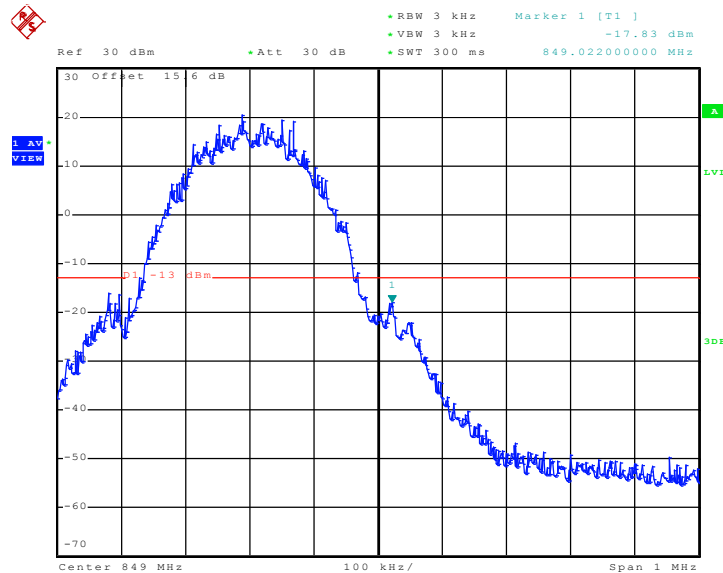

Date: 28.DEC.2010 09:57:56



Band :	GSM850	Power Stage :	High
Test Mode :	EDGE 8 Link		

Lower Band Edge Plot on Channel 128

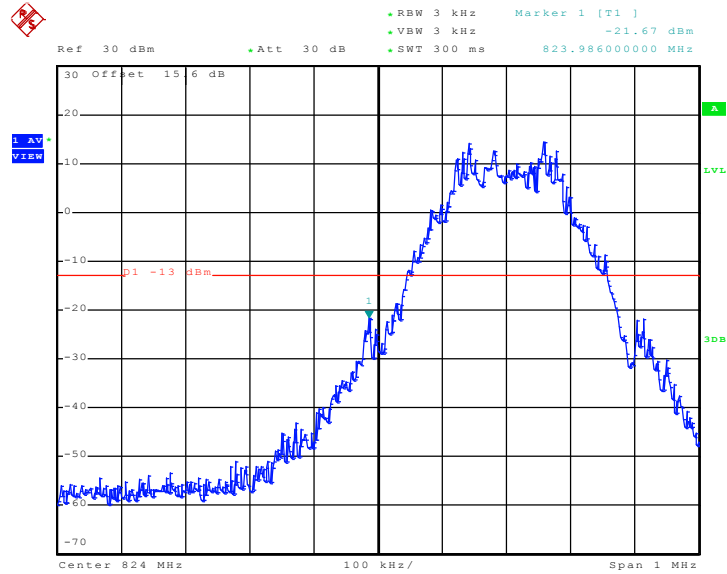

Date: 28.DEC.2010 10:42:39

Higher Band Edge Plot on Channel 251

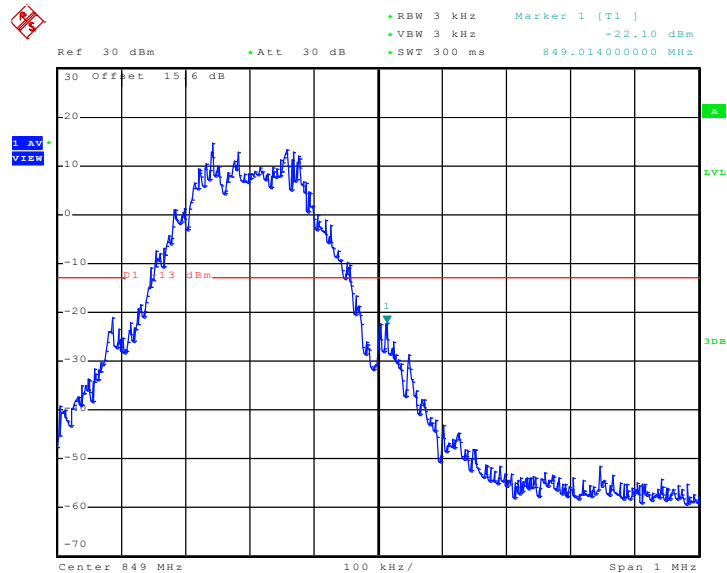

Date: 28.DEC.2010 10:43:06





Band :	GSM1900	Power Stage :	High
Test Mode :	GSM Link		

Lower Band Edge Plot on Channel 512

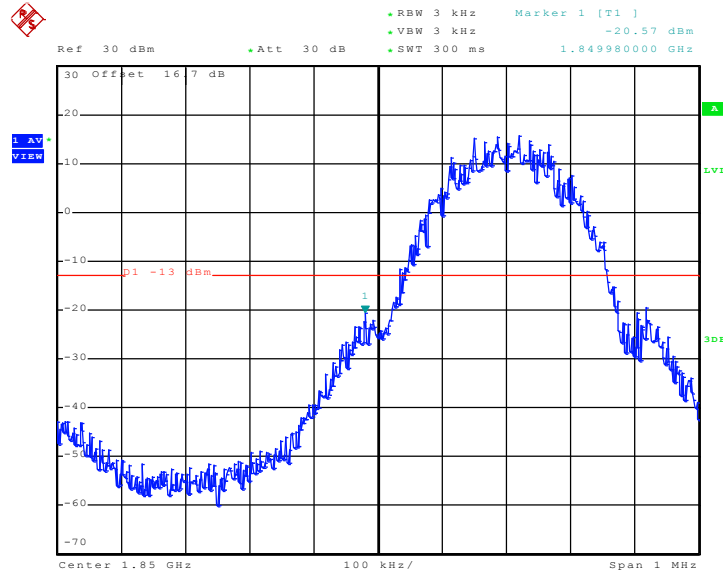

Date: 28.DEC.2010 11:34:25

Higher Band Edge Plot on Channel 810

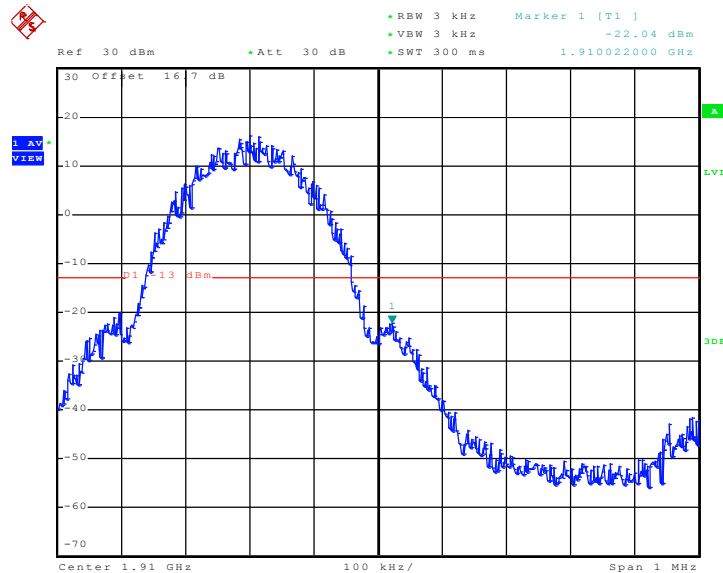

Date: 28.DEC.2010 11:34:53



Band :	GSM1900	Power Stage :	High
Test Mode :	EDGE 8 Link		

Lower Band Edge Plot on Channel 512

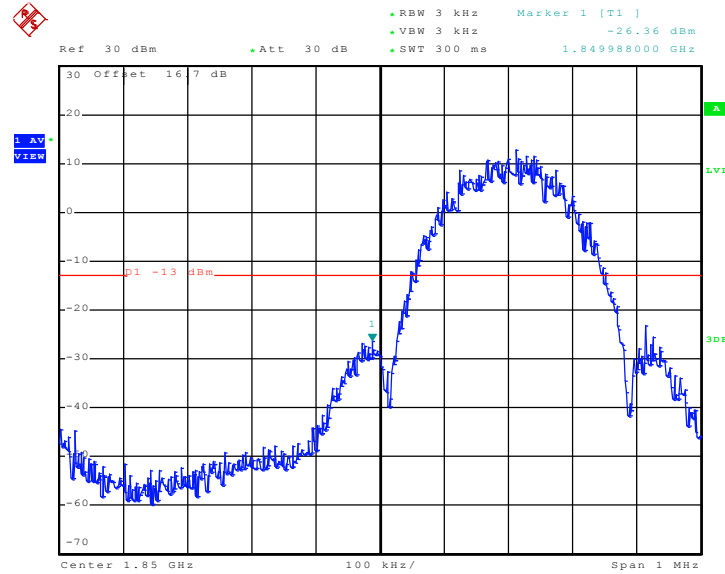

Date: 28.DEC.2010 13:45:50

Higher Band Edge Plot on Channel 810

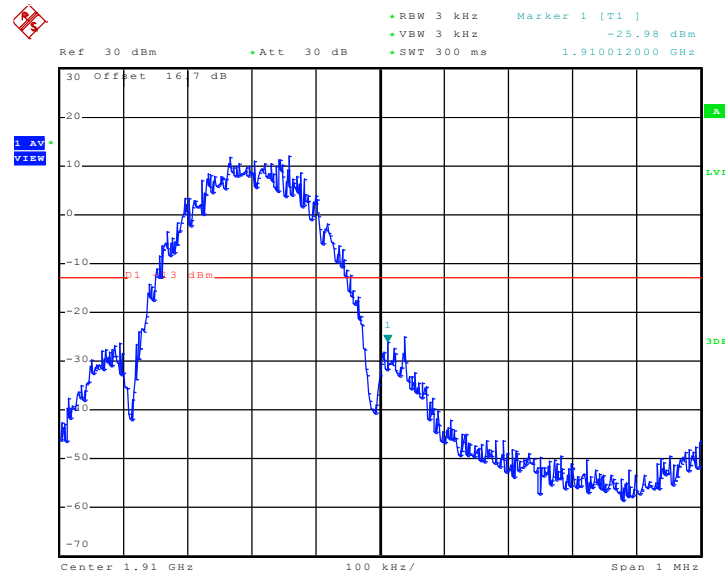

Date: 28.DEC.2010 13:52:13

## 3.5 Conducted Emission Measurement

### 3.5.1 Description of Conducted Emission Measurement

The power of any emission outside of the authorized operating frequency ranges must be lower than the transmitter power (P) by a factor of at least  $43 + 10 \log (P)$  dB.

It is measured by means of a calibrated spectrum analyzer and scanned from 30 MHz up to a frequency including its 10<sup>th</sup> harmonic.

### 3.5.2 Measuring Instruments

See list of measuring instruments of this test report.

### 3.5.3 Test Procedures

1. The EUT was connected to spectrum analyzer and base station via power divider.
2. The middle channel for the highest RF power within the transmitting frequency was measured.
3. The conducted spurious emission for the whole frequency range was taken.

### 3.5.4 Test Setup

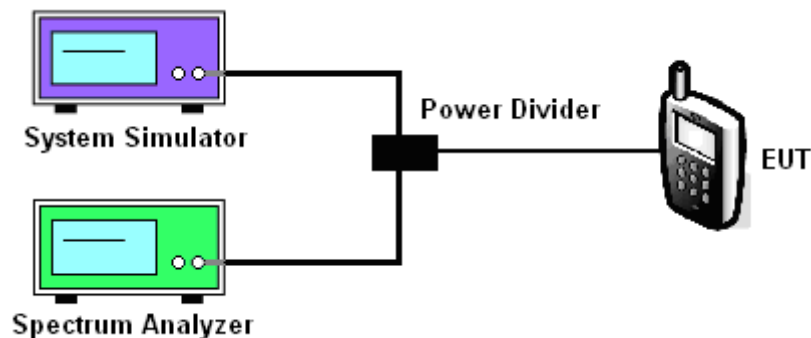





### Conducted Emission Plot between 3GHz ~ 7GHz

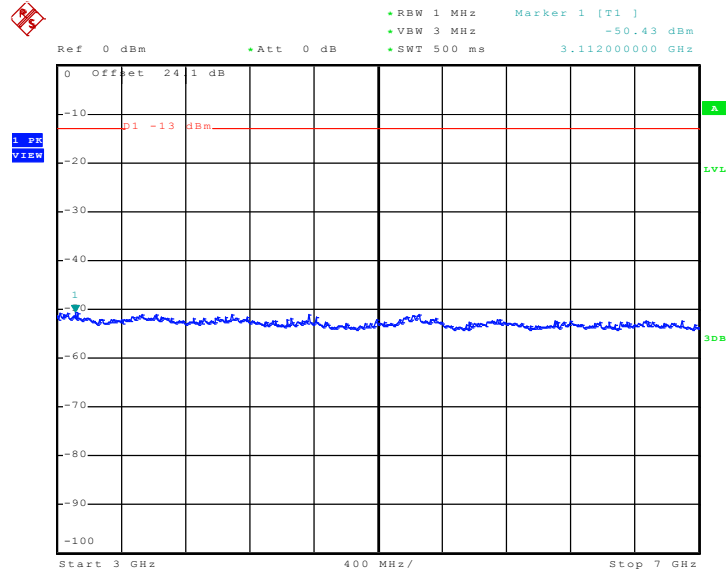

Date: 28.DEC.2010 10:30:21

### Conducted Emission Plot between 7GHz ~ 9GHz

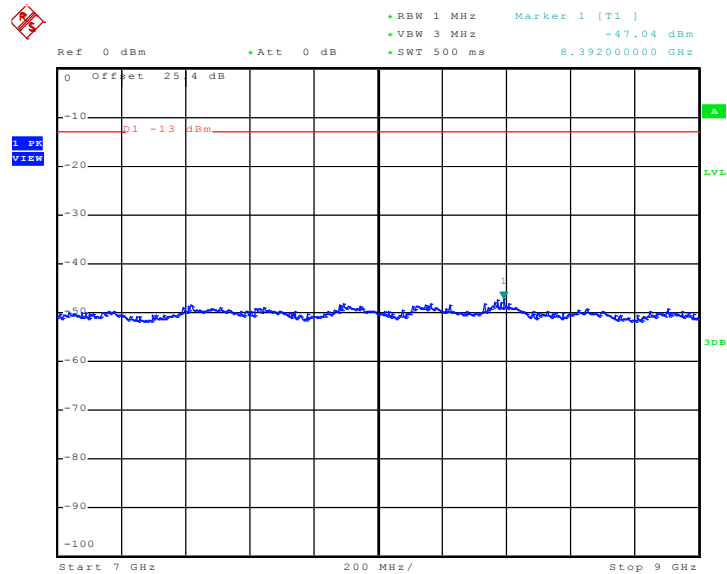

Date: 28.DEC.2010 10:18:19



Band :	GSM850	Channel :	CH189
Test Mode :	EDGE 8 Link		

Conducted Emission Plot between 30MHz ~ 1GHz

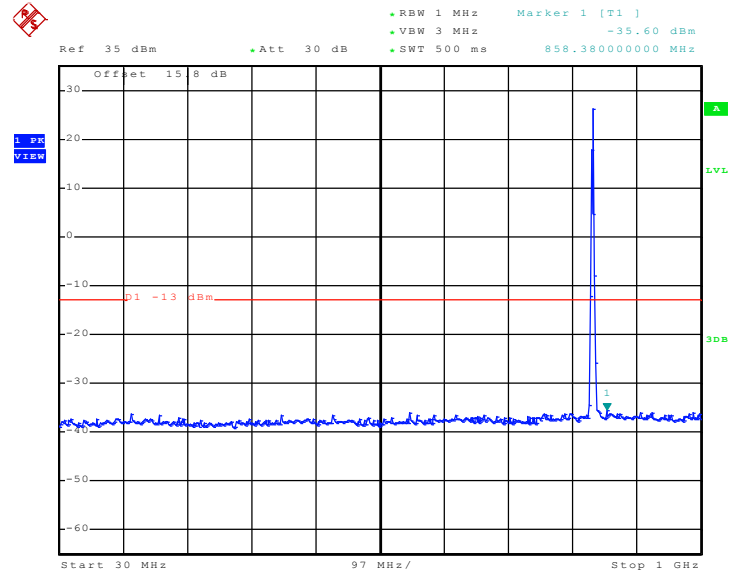

Date: 28.DEC.2010 11:15:45

Conducted Emission Plot between 1GHz ~ 3GHz

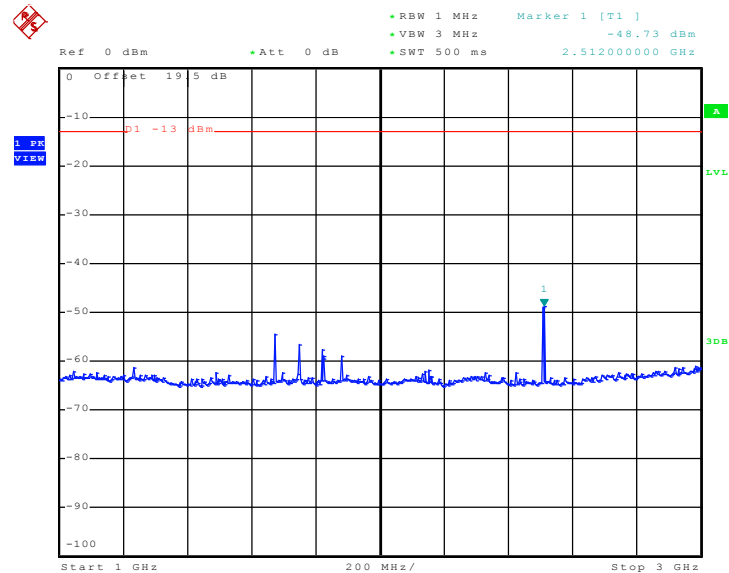

Date: 28.DEC.2010 11:19:16



### Conducted Emission Plot between 3GHz ~ 7GHz

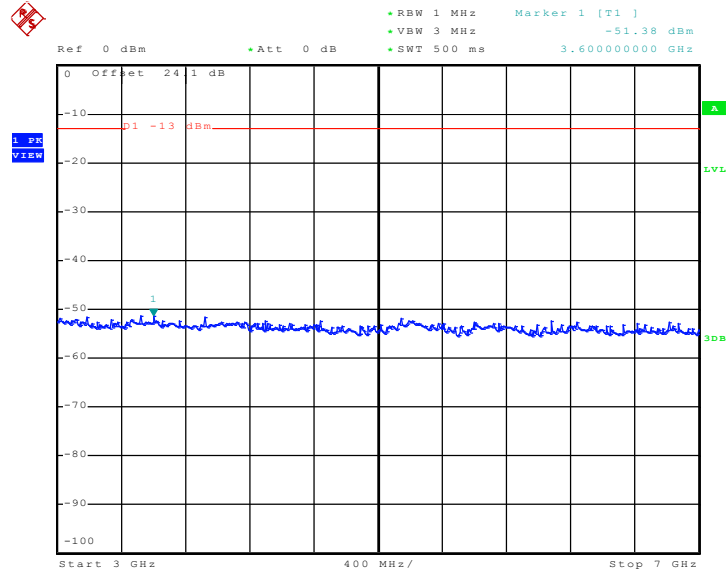

Date: 28.DEC.2010 11:21:45

### Conducted Emission Plot between 7GHz ~ 9GHz

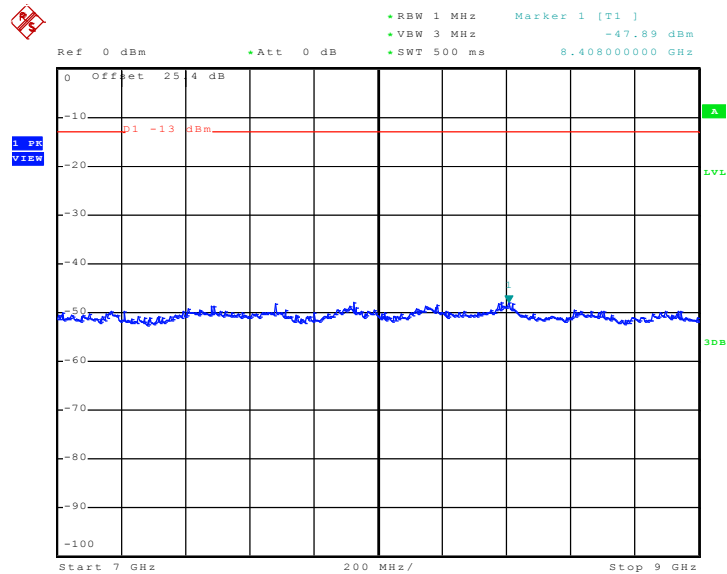

Date: 28.DEC.2010 11:23:08



Band :	GSM1900	Channel :	CH661
Test Mode :	GSM Link		

Conducted Emission Plot between 30MHz ~ 1GHz

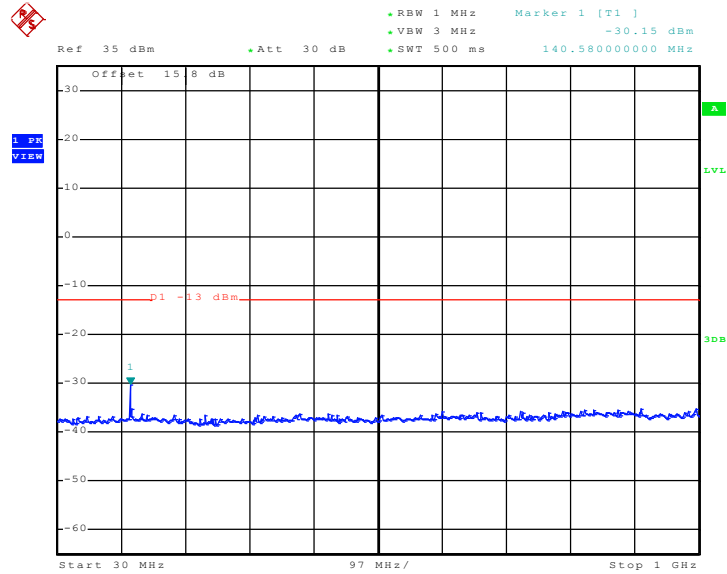

Date: 28.DEC.2010 12:30:23

Conducted Emission Plot between 1GHz ~ 3GHz

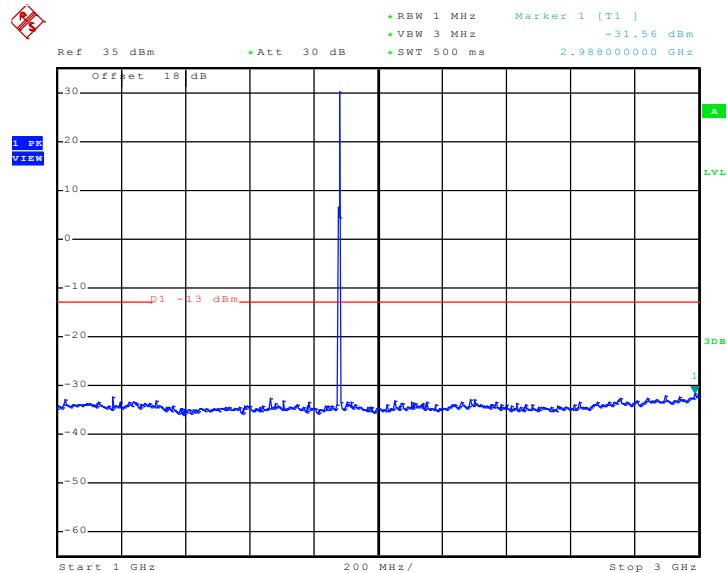

Date: 28.DEC.2010 12:31:48





### Conducted Emission Plot between 3GHz ~ 7GHz

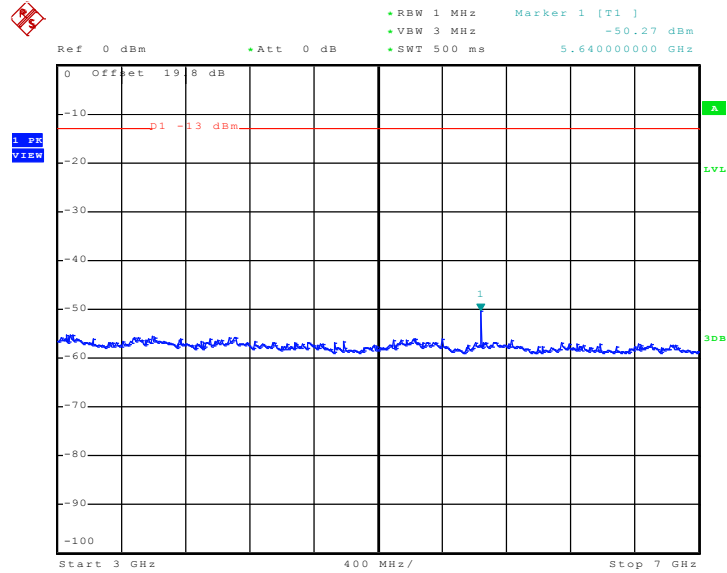

Date: 28.DEC.2010 12:33:22

### Conducted Emission Plot between 7GHz ~ 13.6GHz

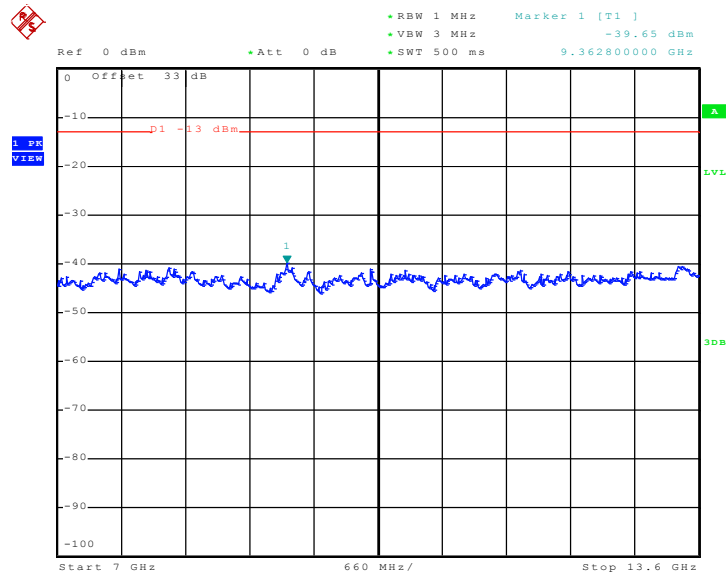

Date: 28.DEC.2010 12:01:42



Conducted Emission Plot between 13.6GHz ~ 19.1GHz

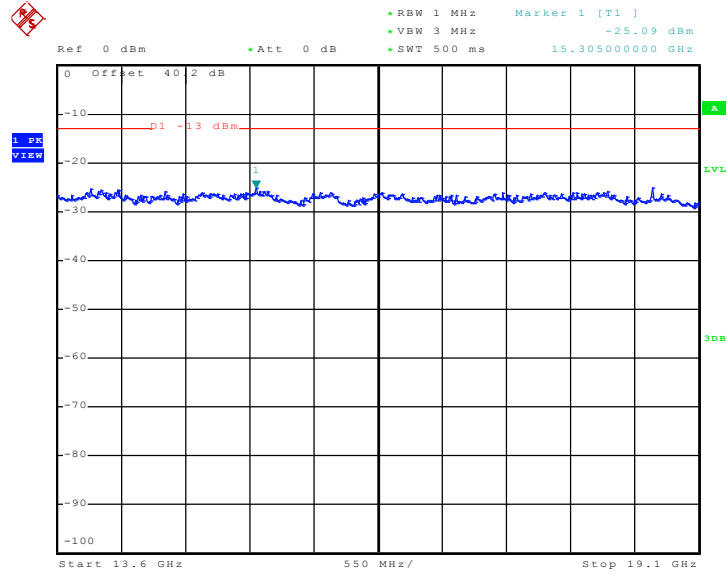

Date: 28.DEC.2010 12:01:56



Band :	GSM1900	Channel :	CH661
Test Mode :	EDGE 8 Link		

Conducted Emission Plot between 30MHz ~ 1GHz

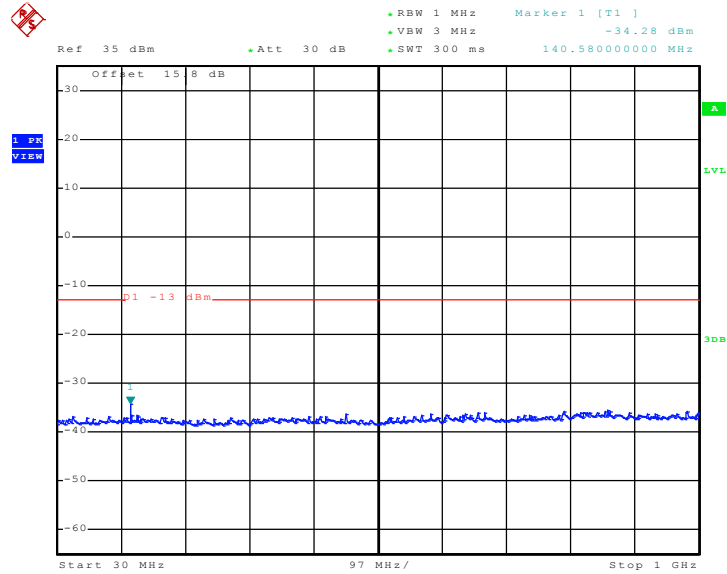

Date: 28.DEC.2010 12:51:26

Conducted Emission Plot between 1GHz ~ 3GHz

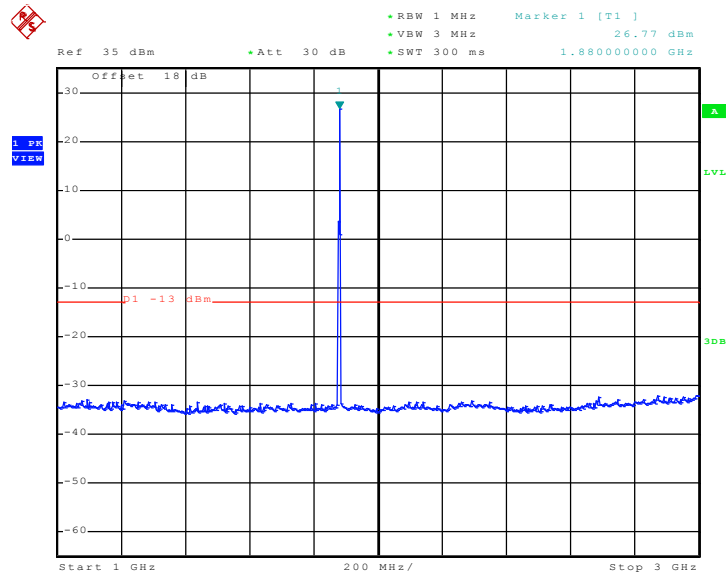

Date: 28.DEC.2010 12:52:35



### Conducted Emission Plot between 3GHz ~ 7GHz

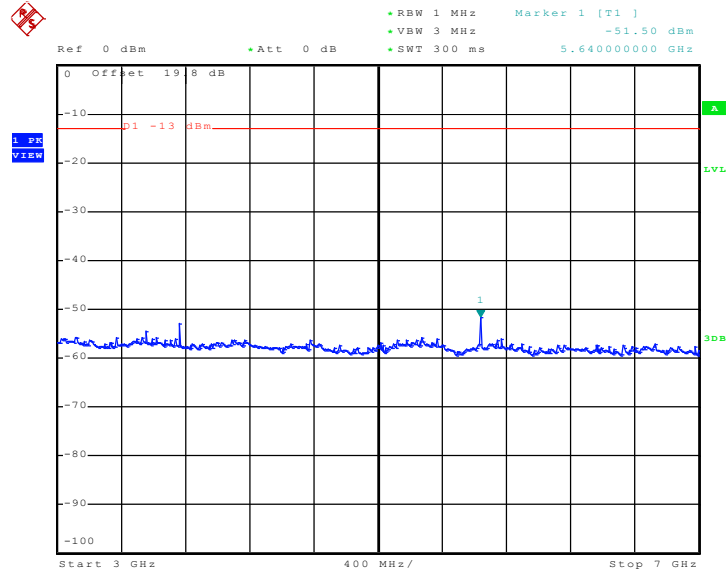

Date: 28.DEC.2010 12:53:37

### Conducted Emission Plot between 7GHz ~ 13.6GHz

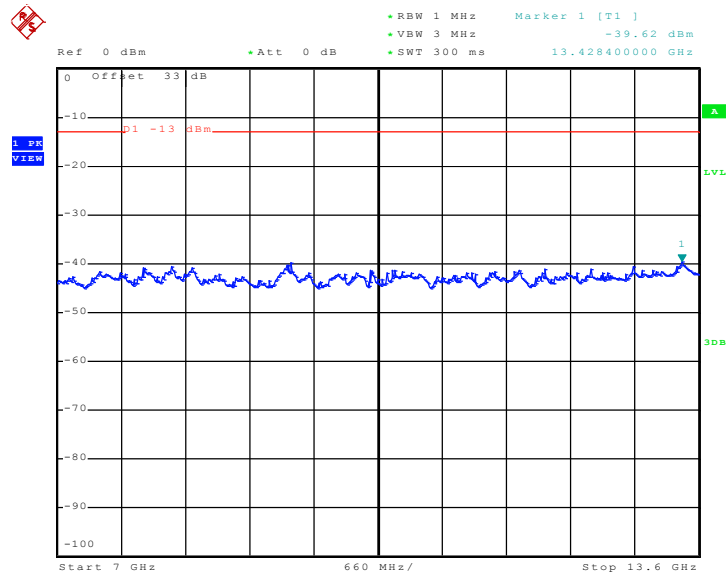

Date: 28.DEC.2010 12:54:52



Conducted Emission Plot between 13.6GHz ~ 19.1GHz

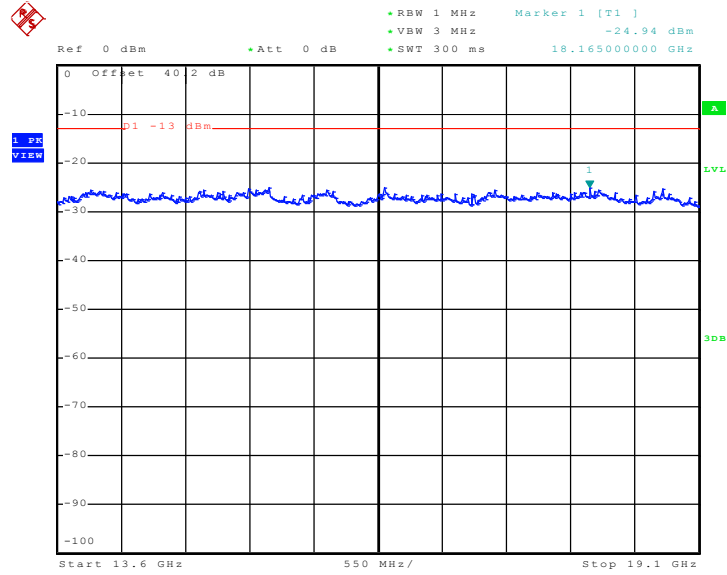

Date: 28.DEC.2010 12:55:57

## 3.6 Field Strength of Spurious Radiation Measurement

### 3.6.1 Description of Field Strength of Spurious Radiated Measurement

The radiated spurious emission was measured by substitution method according to ANSI / TIA / EIA-603-C-2004. The power of any emission outside of the authorized operating frequency ranges must be attenuated below the transmitter power (P) by a factor of at least  $43 + 10 \log (P)$  dB. The spectrum is scanned from 30 MHz up to a frequency including its 10th harmonic.

### 3.6.2 Measuring Instruments

See list of measuring instruments of this test report.

### 3.6.3 Test Procedures

1. The EUT was placed on a rotatable wooden table with 0.8 meter about ground.
2. The EUT was set 3 meters from the receiving antenna, which was mounted on the antenna tower.
3. The table was rotated 360 degrees to determine the position of the highest spurious emission.
4. The height of the receiving antenna is varied between one meter and four meters to search the maximum spurious emission for both horizontal and vertical polarizations.
5. Make the measurement with the spectrum analyzer's RBW = 1MHz, VBW = 3MHz, Sweep = 500ms, Taking the record of maximum spurious emission.
6. A horn antenna was substituted in place of the EUT and was driven by a signal generator.
7. Tune the output power of signal generator to the same emission level with EUT maximum spurious emission.
8. Taking the record of output power at antenna port.
9. Repeat step 7 to step 8 for another polarization.
10.  $EIRP (dBm) = S.G. Power - Tx Cable Loss + Tx Antenna Gain$
11.  $ERP (dBm) = EIRP - 2.15$

### 3.6.4 Test Setup

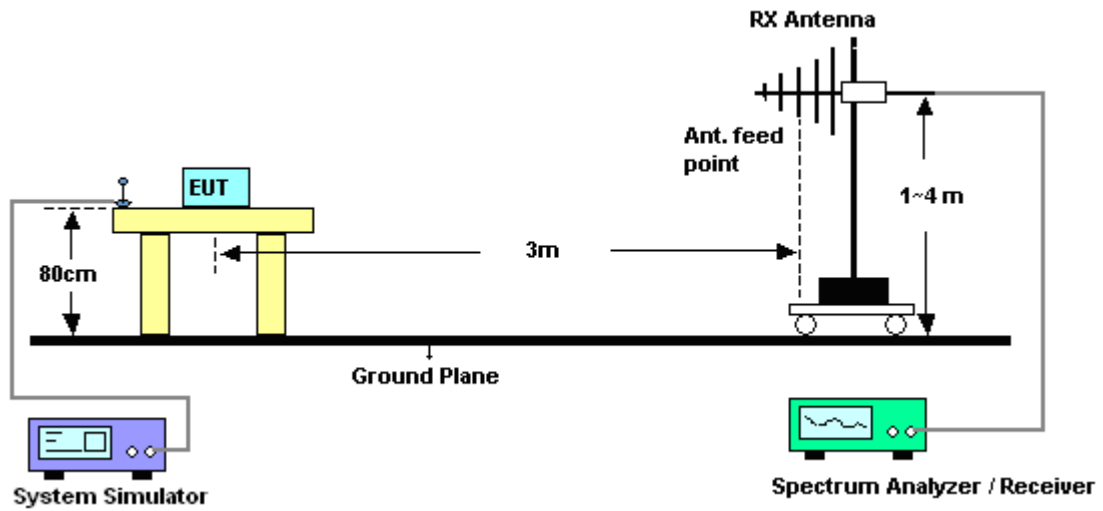



3.6.5 Test Result of Field Strength of Spurious Radiated

Band :	GSM850	Temperature :	22~24°C
Test Mode :	GSM Link	Relative Humidity :	48~50%
Test Engineer :	Ivan Chiang	Polarization :	Horizontal
Remark :	Spurious emissions within 30-1000MHz were found more than 20dB below limit line.		

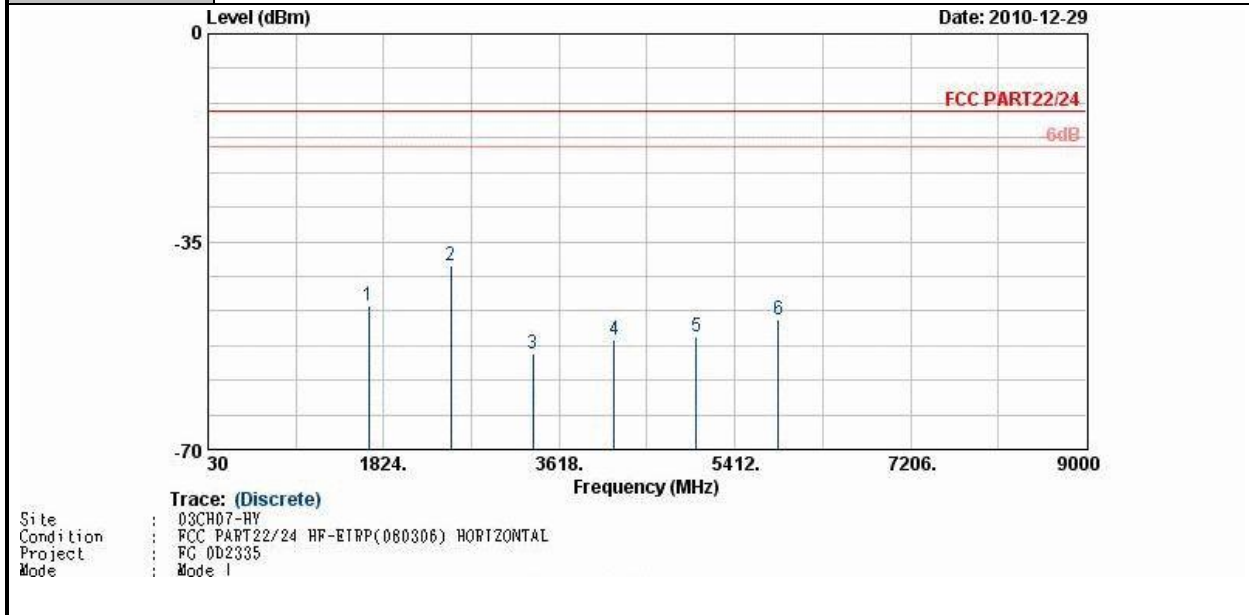

Frequency ( MHz )	ERP ( dBm )	Limit ( dBm )	Over Limit ( dB )	SPA Reading ( dBm )	S.G. Power ( dBm )	TX Cable loss ( dB )	TX Antenna Gain ( dBi )	Polarization ( H/V )	Result
1669	-45.76	-13	-32.76	-54.34	-47.48	1.62	5.49	H	Pass
2509	-39.11	-13	-26.11	-52.88	-41.08	2.1	6.22	H	Pass
3345	-53.89	-13	-40.89	-66.98	-56.78	3.03	8.07	H	Pass
4182	-51.40	-13	-38.40	-66.65	-55.94	2.52	9.21	H	Pass
5018	-50.99	-13	-37.99	-67.9	-56.44	3.1	10.70	H	Pass
5854	-48.09	-13	-35.09	-68.71	-53.33	2.92	10.31	H	Pass





<b>Band :</b>	GSM850	<b>Temperature :</b>	22~24°C
<b>Test Mode :</b>	GSM Link	<b>Relative Humidity :</b>	48~50%
<b>Test Engineer :</b>	Ivan Chiang	<b>Polarization :</b>	Vertical
<b>Remark :</b>	Spurious emissions within 30-1000MHz were found more than 20dB below limit line.		

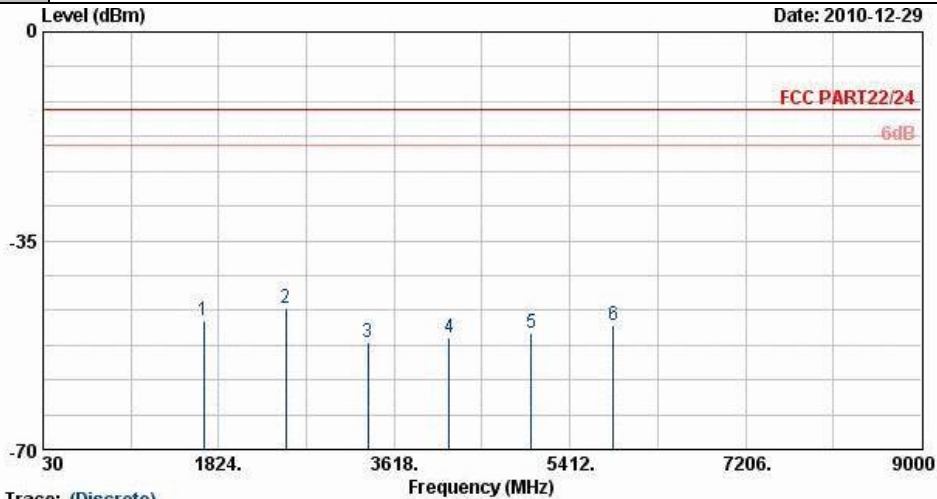

Trace: (Discrete)  
 Site : 03CH07-HY  
 Condition : FCC PART22/24 HF-ETRP(080306) VERTICAL  
 Project : FG 0D2335  
 Mode : Mode 1

Frequency (MHz)	ERP (dBm)	Limit (dBm)	Over Limit (dB)	SPA Reading (dBm)	S.G. Power (dBm)	TX Cable loss (dB)	TX Antenna Gain (dBi)	Polarization (H/V)	Result
1669	-48.39	-13	-35.39	-57.51	-50.11	1.62	5.49	V	Pass
2509	-46.27	-13	-33.27	-59.11	-48.24	2.1	6.22	V	Pass
3345	-52.16	-13	-39.16	-66.75	-55.05	3.03	8.07	V	Pass
4182	-51.17	-13	-38.17	-67.25	-55.71	2.52	9.21	V	Pass
5018	-50.55	-13	-37.55	-67.61	-56.00	3.1	10.70	V	Pass
5854	-49.23	-13	-36.23	-69.55	-54.47	2.92	10.31	V	Pass



<b>Band :</b>	GSM850	<b>Temperature :</b>	22~24°C
<b>Test Mode :</b>	EDGE 8 Link	<b>Relative Humidity :</b>	48~50%
<b>Test Engineer :</b>	Ivan Chiang	<b>Polarization :</b>	Horizontal
<b>Remark :</b>	Spurious emissions within 30-1000MHz were found more than 20dB below limit line.		

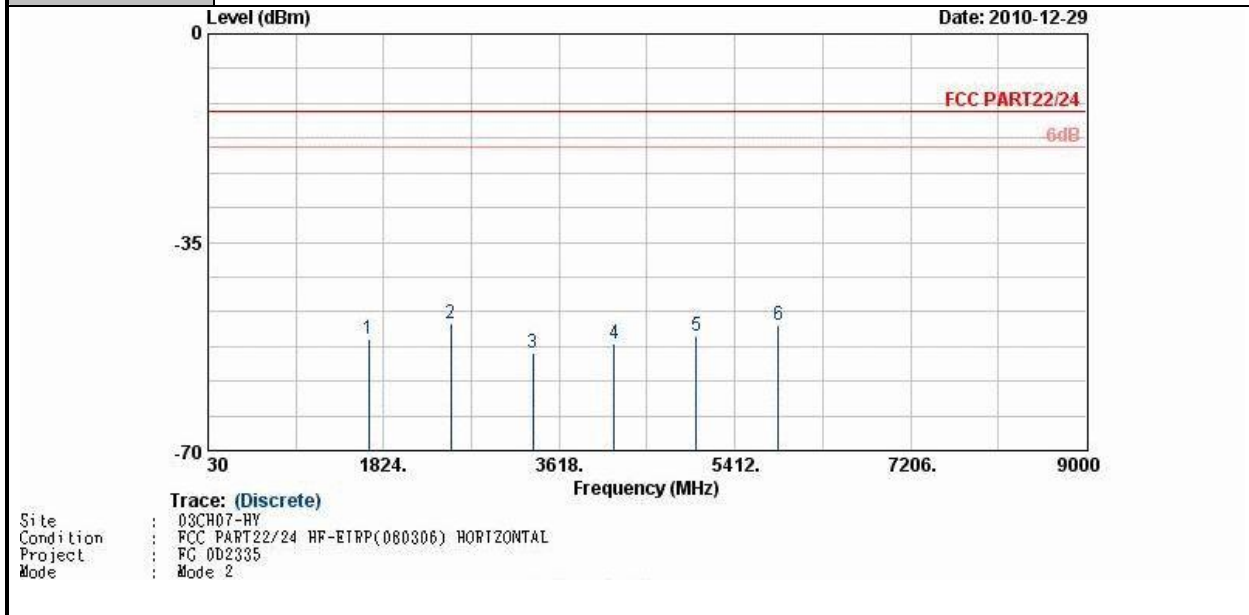

Frequency ( MHz )	ERP ( dBm )	Limit ( dBm )	Over Limit ( dB )	SPA Reading ( dBm )	S.G. Power ( dBm )	TX Cable loss ( dB )	TX Antenna Gain ( dBi )	Polarization ( H/V )	Result
1672	-51.29	-13	-38.29	-60.33	-53.01	1.62	5.49	H	Pass
2509	-48.65	-13	-35.65	-60.23	-50.62	2.1	6.22	H	Pass
3345	-53.74	-13	-40.74	-66.83	-56.63	3.03	8.07	H	Pass
4182	-52.12	-13	-39.12	-67.37	-56.66	2.52	9.21	H	Pass
5018	-50.70	-13	-37.70	-67.62	-56.15	3.1	10.70	H	Pass
5854	-49.00	-13	-36.00	-69.61	-54.24	2.92	10.31	H	Pass



<b>Band :</b>	GSM850	<b>Temperature :</b>	22~24°C
<b>Test Mode :</b>	EDGE 8 Link	<b>Relative Humidity :</b>	48~50%
<b>Test Engineer :</b>	Ivan Chiang	<b>Polarization :</b>	Vertical
<b>Remark :</b>	Spurious emissions within 30-1000MHz were found more than 20dB below limit line.		

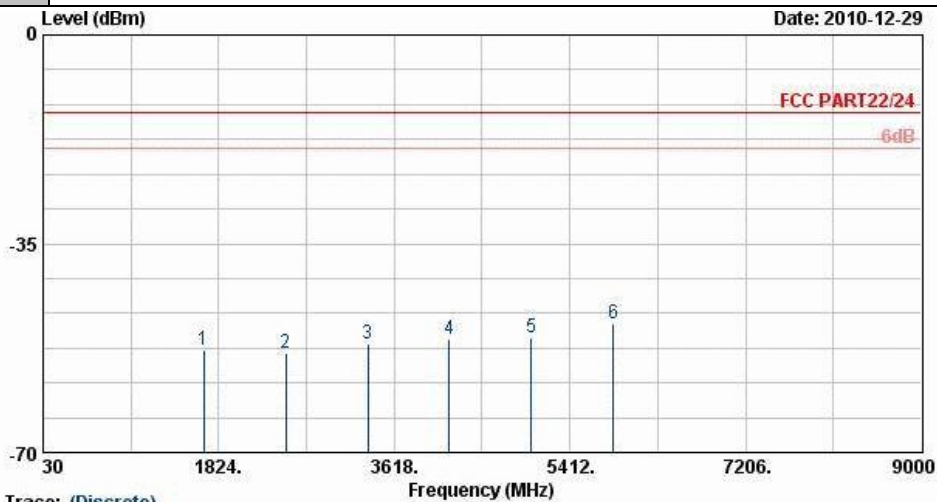

Trace: (Discrete)  
 Site : 03CH07-HY  
 Condition : FCC PART22/24 HF-ETRP(080306) VERTICAL  
 Project : FG 0D2335  
 Mode : Mode 2

Frequency (MHz)	ERP (dBm)	Limit (dBm)	Over Limit (dB)	SPA Reading (dBm)	S.G. Power (dBm)	TX Cable loss (dB)	TX Antenna Gain (dBi)	Polarization (H/V)	Result
1672	-52.84	-13	-39.84	-62.51	-54.56	1.62	5.49	V	Pass
2509	-53.40	-13	-40.40	-65	-55.37	2.1	6.22	V	Pass
3345	-51.68	-13	-38.68	-66.27	-54.57	3.03	8.07	V	Pass
4182	-50.93	-13	-37.93	-67.01	-55.47	2.52	9.21	V	Pass
5018	-50.65	-13	-37.65	-67.71	-56.10	3.1	10.70	V	Pass
5854	-48.43	-13	-35.43	-68.75	-53.67	2.92	10.31	V	Pass



<b>Band :</b>	GSM1900	<b>Temperature :</b>	22~24°C
<b>Test Mode :</b>	GSM Link	<b>Relative Humidity :</b>	48~50%
<b>Test Engineer :</b>	Ivan Chiang	<b>Polarization :</b>	Horizontal
<b>Remark :</b>	Spurious emissions within 30-1000MHz were found more than 20dB below limit line.		

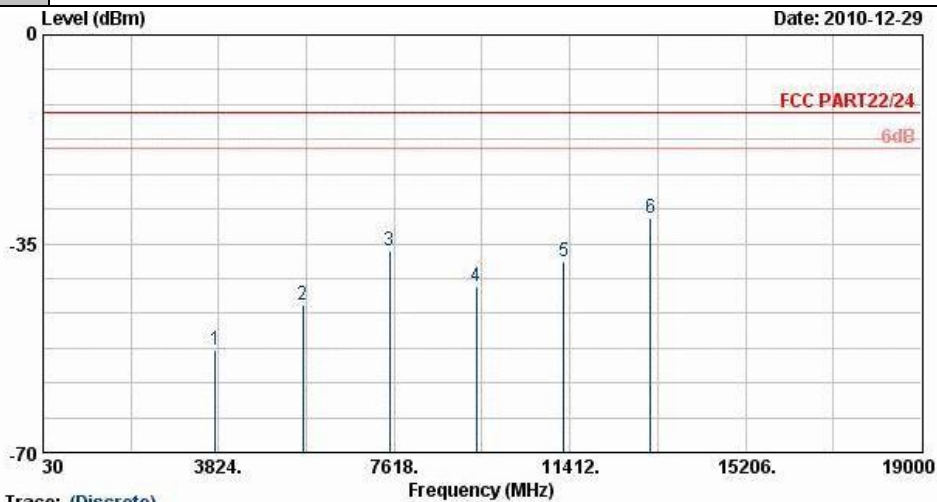

Trace: (Discrete)  
 Site : 03CH07-HY  
 Condition : FCC PART22/24 HF-ETRP(080306) HORIZONTAL  
 Project : FG 0D2335  
 Mode : Mode 1

Frequency (MHz)	EIRP (dBm)	Limit (dBm)	Over Limit (dB)	SPA Reading (dBm)	S.G. Power (dBm)	TX Cable loss (dB)	TX Antenna Gain (dBi)	Polarization (H/V)	Result
3760	-52.88	-13	-39.88	-67.23	-59.18	2.51	8.81	H	Pass
5636	-45.37	-13	-32.37	-65.29	-53.08	2.99	10.70	H	Pass
7520	-36.28	-13	-23.28	-62.84	-44.81	3.59	12.12	H	Pass
9396	-42.23	-13	-29.23	-67.69	-51.33	4.1	13.20	H	Pass
11280	-38.06	-13	-25.06	-66.93	-47.1	4.27	13.31	H	Pass
13160	-30.73	-13	-17.73	-62.5	-40.25	4.27	13.79	H	Pass



<b>Band :</b>	GSM1900	<b>Temperature :</b>	22~24°C
<b>Test Mode :</b>	GSM Link	<b>Relative Humidity :</b>	48~50%
<b>Test Engineer :</b>	Ivan Chiang	<b>Polarization :</b>	Vertical
<b>Remark :</b>	Spurious emissions within 30-1000MHz were found more than 20dB below limit line.		

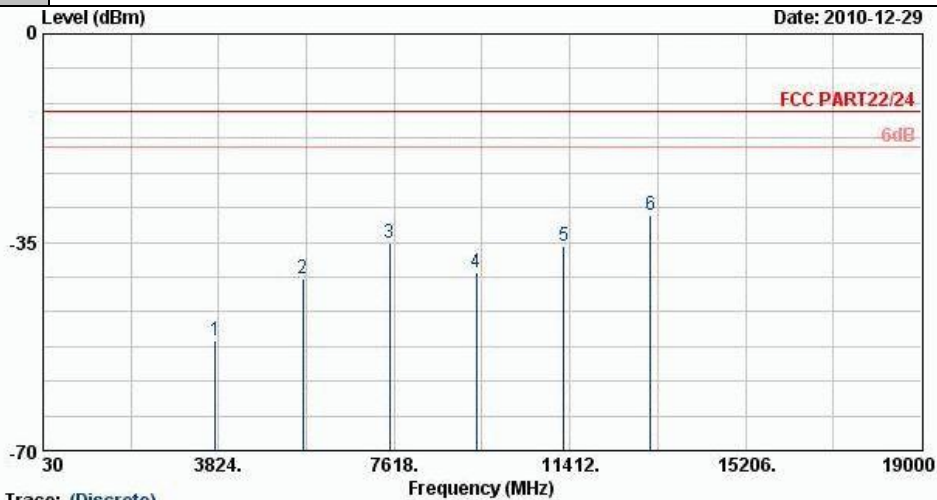

Trace: (Discrete)  
 Site : 03CH07-HY  
 Condition : FCC PART22/24 HF-ETRP(080306) VERTICAL  
 Project : FG 0D2335  
 Mode : Mode 1

Frequency (MHz)	EIRP (dBm)	Limit (dBm)	Over Limit (dB)	SPA Reading (dBm)	S.G. Power (dBm)	TX Cable loss (dB)	TX Antenna Gain (dBi)	Polarization (H/V)	Result
3760	-51.45	-13	-38.45	-66.75	-57.75	2.51	8.81	V	Pass
5636	-41.23	-13	-28.23	-61.43	-48.94	2.99	10.70	V	Pass
7520	-35.16	-13	-22.16	-62.82	-43.69	3.59	12.12	V	Pass
9396	-40.07	-13	-27.07	-65.49	-49.17	4.1	13.20	V	Pass
11280	-35.54	-13	-22.54	-63.05	-44.58	4.27	13.31	V	Pass
13160	-30.51	-13	-17.51	-62.09	-40.03	4.27	13.79	V	Pass



<b>Band :</b>	GSM1900	<b>Temperature :</b>	22~24°C
<b>Test Mode :</b>	EDGE 8 Link	<b>Relative Humidity :</b>	48~50%
<b>Test Engineer :</b>	Ivan Chiang	<b>Polarization :</b>	Horizontal
<b>Remark :</b>	Spurious emissions within 30-1000MHz were found more than 20dB below limit line.		

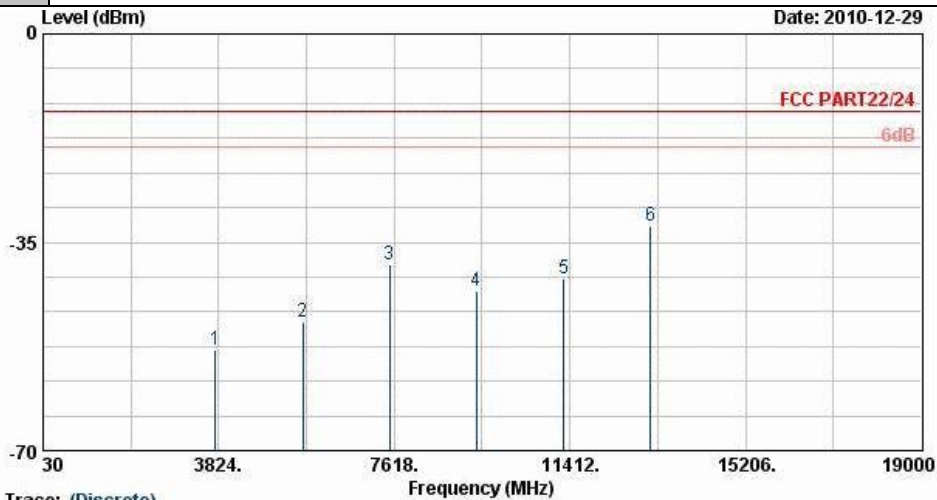

Trace: (Discrete)  
 Site : 03CH07-HY  
 Condition : FCC PART22/24 HF-ETRP(080306) HORIZONTAL  
 Project : FG 0D2335  
 Mode : Mode 2

Frequency (MHz)	EIRP (dBm)	Limit (dBm)	Over Limit (dB)	SPA Reading (dBm)	S.G. Power (dBm)	TX Cable loss (dB)	TX Antenna Gain (dBi)	Polarization (H/V)	Result
3760	-53.01	-13	-40.01	-67.37	-59.31	2.51	8.81	H	Pass
5636	-48.37	-13	-35.37	-68.14	-56.08	2.99	10.70	H	Pass
7520	-38.65	-13	-25.65	-64.36	-47.18	3.59	12.12	H	Pass
9396	-43.18	-13	-30.18	-68.64	-52.28	4.1	13.20	H	Pass
11280	-41.01	-13	-28.01	-69.44	-50.05	4.27	13.31	H	Pass
13160	-32.14	-13	-19.14	-65.72	-41.66	4.27	13.79	H	Pass



<b>Band :</b>	GSM1900	<b>Temperature :</b>	22~24°C
<b>Test Mode :</b>	EDGE 8 Link	<b>Relative Humidity :</b>	48~50%
<b>Test Engineer :</b>	Ivan Chiang	<b>Polarization :</b>	Vertical
<b>Remark :</b>	Spurious emissions within 30-1000MHz were found more than 20dB below limit line.		

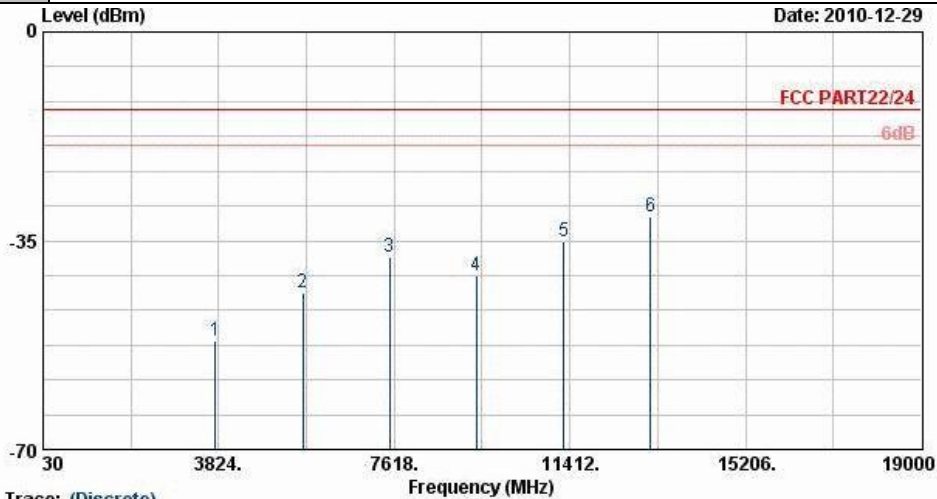

Trace: (Discrete)  
 Site : 03CH07-HY  
 Condition : FCC PART22/24 HF-ETRP(080306) VERTICAL  
 Project : FG 0D2335  
 Mode : Mode 2

Frequency (MHz)	EIRP (dBm)	Limit (dBm)	Over Limit (dB)	SPA Reading (dBm)	S.G. Power (dBm)	TX Cable loss (dB)	TX Antenna Gain (dBi)	Polarization (H/V)	Result
3760	-51.84	-13	-38.84	-67.14	-58.14	2.51	8.81	V	Pass
5636	-43.75	-13	-30.75	-62.91	-51.46	2.99	10.70	V	Pass
7520	-37.84	-13	-24.84	-64.87	-46.37	3.59	12.12	V	Pass
9396	-40.77	-13	-27.77	-66.45	-49.87	4.1	13.20	V	Pass
11280	-35.18	-13	-22.18	-62.75	-44.22	4.27	13.31	V	Pass

## 3.7 Frequency Stability Measurement

### 3.7.1 Description of Frequency Stability Measurement

The frequency stability shall be measured by variation of ambient temperature and variation of primary supply voltage to ensure that the fundamental emission stays within the authorized frequency block. The frequency stability of the transmitter shall be maintained within  $\pm 0.00025\%$  ( $\pm 2.5\text{ppm}$ ) of the center frequency.

### 3.7.2 Measuring Instruments

See list of measuring instruments of this test report.

### 3.7.3 Test Procedures for Temperature Variation

1. The EUT was set up in the thermal chamber and connected with the base station.
2. With power OFF, the temperature was decreased to  $-30^{\circ}\text{C}$  and the EUT was stabilized for three hours. Power was applied and the maximum change in frequency was recorded within one minute.
3. With power OFF, the temperature was raised in  $10^{\circ}\text{C}$  step up to  $50^{\circ}\text{C}$ . The EUT was stabilized at each step for at least half an hour. Power was applied and the maximum frequency change was recorded within one minute.
4. If the EUT can not be turned on at  $-30^{\circ}\text{C}$ , the testing lowest temperature will be raised in  $10^{\circ}\text{C}$  step until the EUT can be turned on.

### 3.7.4 Test Procedures for Voltage Variation

1. The EUT was placed in a temperature chamber at  $25\pm 5^{\circ}\text{C}$  and connected with the base station.
2. The power supply voltage to the EUT was varied from BEP to 115% of the nominal value measured at the input to the EUT.
3. The variation in frequency was measured for the worst case.



### 3.7.5 Test Setup

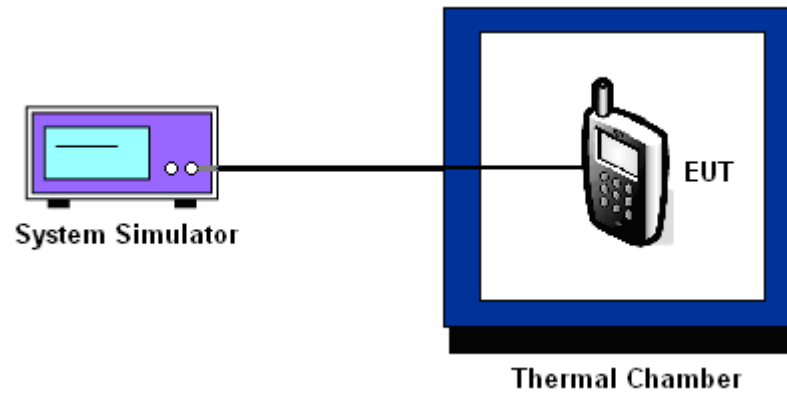

3.7.6 Test Result of Temperature Variation

Band :	GSM 850	Channel :	189
Limit (ppm) :	2.5		

Temperature (°C)	GSM		EDGE 8		Result
	Freq. Dev. (Hz)	Deviation (ppm)	Freq. Dev. (Hz)	Deviation (ppm)	
-10	-30	-0.04	12	0.01	PASS
0	-28	-0.03	13	0.02	
10	-26	-0.03	15	0.02	
20	-27	-0.03	22	0.03	
30	-29	-0.03	24	0.03	
40	-27	-0.03	17	0.02	
50	-25	-0.03	15	0.02	
55	-31	-0.04	11	0.01	

Note:

1. The EUT stops transmitting at temperatures -20°C, and -30°C.
2. The manufacturer declared that the EUT could work properly between temperatures -10°C~55°C.

Band :	GSM 1900	Channel :	661
Limit (ppm) :	2.5		

Temperature (°C)	GSM		EDGE 8		Result
	Freq. Dev. (Hz)	Deviation (ppm)	Freq. Dev. (Hz)	Deviation (ppm)	
-10	-68	-0.04	-76	-0.04	PASS
0	-65	-0.03	-83	-0.04	
10	-66	-0.03	-77	-0.04	
20	-72	-0.04	-85	-0.04	
30	-64	-0.03	-78	-0.04	
40	-63	-0.03	-80	-0.04	
50	-69	-0.04	-83	-0.04	
55	-61	-0.03	-85	-0.04	

Note:

1. The EUT stops transmitting at temperatures -20°C, and -30°C.
2. The manufacturer declared that the EUT could work properly between temperatures -10°C~55°C.



3.7.7 Test Result of Voltage Variation

Band & Channel	Mode	Voltage (Volt)	Freq. Dev. (Hz)	Deviation (ppm)	Limit (ppm)	Result
GSM 850 CH189	GSM	3.8	-33	-0.04	2.5	PASS
		BEP	-26	-0.03		
		4.2	-32	-0.04		
	EDGE 8	3.8	23	0.03		
		BEP	16	0.02		
		4.2	14	0.02		
GSM 1900 CH661	GSM	3.8	-60	-0.03		
		BEP	-62	-0.03		
		4.2	-62	-0.03		
	EDGE 8	3.8	-88	-0.05		
		BEP	-84	-0.04		
		4.2	-79	-0.04		

Note:

- 1. Normal Voltage = 3.8V.
- 2. Battery End Point (BEP) = 3.5 V.



## 4 List of Measuring Equipment

Instrument	Manufacturer	Model No.	Serial No.	Characteristics	Calibration Date	Due Date	Remark
System Simulator	R&S	CMU200	117995	N/A	Mar. 19, 2009	Mar. 18, 2011	Conducted (TH02-HY)
Spectrum Analyzer	R&S	FSP30	101329	9kHz~30GHz	Apr. 26, 2010	Apr. 25, 2011	Conducted (TH02-HY)
Thermal Chamber	Ten Billion	TTH-D35P	TBN-930701	N/A	Jul. 30,2010	Jul. 29, 2011	Conducted (TH02-HY)
Bilog Antenna	SCHAFFNER	CBL6111C	2726	30MHz ~ 1GHz	Oct. 31, 2010	Oct. 30, 2011	Radiation (03CH07-HY)
Spectrum Analyzer	R&S	FSP	101067	9KHz ~ 30GHz	Dec. 03, 2010	Dec. 02, 2011	Radiation (03CH07-HY)
Double Ridge Horn Antenna	ESCO	3117	00075962	1GHz ~ 18GHz	Aug. 19, 2010	Aug. 18, 2011	Radiation (03CH07-HY)
SHF-EHF Horn Antenna	SCHWARZBECK	BBHA 9170	BBHA917025 1	15GHz- 40GHz	Oct. 18, 2010	Oct. 17, 2011	Radiation (03CH07-HY)
Pre Amplifier	Agilent	8449B	3008A02362	1GHz~ 26.5GHz	Dec. 06, 2010	Dec. 05, 2011	Radiation (03CH07-HY)
Pre Amplifier	COM-POWER	PA-103A	161241	10-1000MHz.32dB. GAIN	Mar. 27, 2010	Mar. 26, 2011	Radiation (03CH07-HY)
Loop Antenna	R&S	HFH2-Z2	860004/001	9 kHz~30 MHz	Jul. 29, 2010	Jul. 28, 2011	Radiation (03CH07-HY)
System Simulator	R&S	CMU200	114256	N/A	Feb. 08,2010	Feb. 07, 2012	Radiation (03CH07-HY)

## 5 Uncertainty of Evaluation

### Uncertainty of Radiated Emission Measurement (30 MHz ~ 1000 MHz)

Contribution	Uncertainty of $X_i$		$u(X_i)$
	dB	Probability Distribution	
Receiver Reading	0.41	Normal (k=2)	0.21
Antenna Factor Calibration	0.83	Normal (k=2)	0.42
Cable Loss Calibration	0.25	Normal (k=2)	0.13
Pre-Amplifier Gain Calibration	0.27	Normal (k=2)	0.14
RCV/SPA Specification	2.50	Rectangular	0.72
Antenna Factor Interpolation for Frequency	1.00	Rectangular	0.29
Site Imperfection	1.43	Rectangular	0.83
Mismatch	+0.39 / -0.41	U-Shape	0.28
<b>Combined Standard Uncertainty <math>U_c(y)</math></b>	<b>1.27</b>		
<b>Measuring Uncertainty for a Level of Confidence of 95% (<math>U = 2U_c(y)</math>)</b>	<b>2.54</b>		

### Uncertainty of Radiated Emission Measurement (1 GHz ~ 40 GHz)

Contribution	Uncertainty of $X_i$		$u(X_i)$	$C_i$	$C_i * u(X_i)$
	dB	Probability Distribution			
Receiver Reading	$\pm 0.10$	Normal (k=2)	0.10	1	0.10
Antenna Factor Calibration	$\pm 1.70$	Normal (k=2)	0.85	1	0.85
Cable Loss Calibration	$\pm 0.50$	Normal (k=2)	0.25	1	0.25
Receiver Correction	$\pm 2.00$	Rectangular	1.15	1	1.15
Antenna Factor Directional	$\pm 1.50$	Rectangular	0.87	1	0.87
Site Imperfection	$\pm 2.80$	Triangular	1.14	1	1.14
Mismatch Receiver VSWR $\Gamma_1 = 0.197$ Antenna VSWR $\Gamma_2 = 0.194$ Uncertainty = $20\text{Log}(1-\Gamma_1*\Gamma_2)$	+0.34 / -0.35	U-Shape	0.244	1	0.244
<b>Combined Standard Uncertainty <math>U_c(y)</math></b>	<b>2.36</b>				
<b>Measuring Uncertainty for a Level of Confidence of 95% (<math>U = 2U_c(y)</math>)</b>	<b>4.72</b>				



## **Appendix A. Photographs of EUT**

Please refer to Sporton report number EP0D2335 as below.