



**FCC 47 CFR PART 15 SUBPART C**

**TEST REPORT**

**For**

**Smart Handheld**

**Model: E310**

**Trade Name: acer**

*Issued to*

**Acer Incorporated**  
**8F., No.88, Sec. 1, Hsin Tai Wu Rd., Hsichih Town,**  
**Taipei Hsien, Taiwan, R.O.C.**

*Issued by*

**Compliance Certification Services Inc.**  
**No. 11, Wu-Gong 6<sup>th</sup> Rd., Wugu Industrial Park,**  
**Taipei Hsien 248, Taiwan (R.O.C.)**  
**<http://www.ccsrf.com>**  
**[service@ccsrf.com](mailto:service@ccsrf.com)**



---

*Note: This report shall not be reproduced except in full, without the written approval of Compliance Certification Services Inc. This document may be altered or revised by Compliance Certification Services Inc. personnel only, and shall be noted in the revision section of the document.*



## **TABLE OF CONTENTS**

<b>1. TEST RESULT CERTIFICATION.....</b>	<b>3</b>
<b>2. EUT DESCRIPTION .....</b>	<b>4</b>
<b>3. TEST METHODOLOGY .....</b>	<b>5</b>
3.1 EUT CONFIGURATION .....	5
3.2 EUT EXERCISE.....	5
3.3 GENERAL TEST PROCEDURES.....	5
3.4 FCC PART 15.205 RESTRICTED BANDS OF OPERATIONS.....	6
3.5 DESCRIPTION OF TEST MODES .....	7
<b>4. INSTRUMENT CALIBRATION.....</b>	<b>8</b>
4.1 MEASURING INSTRUMENT CALIBRATION .....	8
4.2 MEASUREMENT EQUIPMENT USED .....	8
4.3 MEASUREMENT UNCERTAINTY .....	9
<b>5. FACILITIES AND ACCREDITATIONS .....</b>	<b>10</b>
5.1 FACILITIES .....	10
5.2 EQUIPMENT.....	10
5.3 TABLE OF ACCREDITATIONS AND LISTINGS.....	11
<b>6. SETUP OF EQUIPMENT UNDER TEST .....</b>	<b>12</b>
6.1 SETUP CONFIGURATION OF EUT.....	12
6.2 SUPPORT EQUIPMENT .....	12
<b>7. FCC PART 15.247 REQUIREMENTS.....</b>	<b>13</b>
7.1 6DB BANDWIDTH.....	13
7.2 PEAK POWER.....	18
7.3 AVERAGE POWER .....	20
7.4 BAND EDGES MEASUREMENT .....	21
7.5 PEAK POWER SPECTRAL DENSITY.....	30
7.6 SPURIOUS EMISSIONS.....	35
7.7 POWERLINE CONDUCTED EMISSIONS.....	50
<b>APPENDIX I RADIO FREQUENCY EXPOSURE .....</b>	<b>53</b>
<b>APPENDIX II PHOTOGRAPHS OF TEST SETUP .....</b>	<b>54</b>
<b>APPENDIX 1 - PHOTOGRAPHS OF EUT</b>	



# 1. TEST RESULT CERTIFICATION

**Applicant:** Acer Incorporated  
 8F., No.88, Sec. 1, Hsin Tai Wu Rd., Hsichih Town,  
 Taipei Hsien, Taiwan, R.O.C.

**Equipment Under Test:** Smart Handheld

**Trade Name:** acer

**Model:** E310

**Date of Test:** November 29 ~ December 2, 2010

APPLICABLE STANDARDS	
STANDARD	TEST RESULT
FCC 47 CFR Part 15 Subpart C	No non-compliance noted
Deviation from Applicable Standard	
N/A	

## We hereby certify that:

The above equipment was tested by Compliance Certification Services Inc. The test data, data evaluation, test procedures, and equipment configurations shown in this report were made in accordance with the procedures given in **ANSI C63.4: 2003** and the energy emitted by the sample EUT tested as described in this report is in compliance with the requirements of FCC Rules Part 15.207, 15.209, 15.247.

The test results of this report relate only to the tested sample EUT identified in this report.

Approved by:

Reviewed by:

---

Rex Lai  
 Section Manager  
 Compliance Certification Services Inc.

---

Gina Lo  
 Section Manager  
 Compliance Certification Services Inc.



## 2. EUT DESCRIPTION

<b>Product</b>	Smart Handheld
<b>Trade Name</b>	acer
<b>Model Number</b>	E310
<b>Model Discrepancy</b>	N/A
<b>Power Supply</b>	1. Power Adapter: Trade Name: PHIHONG / Model: PSAI05R-050Q Input: 100-240V, 0.3A, 50-60Hz Output: 5V, 1.0A 2. Battery: Trade Name: acer Model: BAT-310(1ICP5/42/61) Rating: 3.7V, 1300mAh, 4.81Wh
<b>Frequency Range</b>	2412 ~ 2462 MHz
<b>Transmit Power</b>	IEEE 802.11b: 18.31 dBm IEEE 802.11g: 23.16 dBm
<b>Modulation Technique</b>	IEEE 802.11b: DSSS (CCK, DQPSK, DBPSK) IEEE 802.11g: OFDM (QPSK, BPSK, 16-QAM, 64-QAM)
<b>Transmit Data Rate</b>	IEEE 802.11b Mode: 11, 5.5, 2, 1 Mbps IEEE 802.11g Mode: 54, 48, 36, 24, 18, 12, 9, 6Mbps
<b>Number of Channels</b>	11 Channels
<b>Antenna Specification</b>	Gain: -0.7 dBi
<b>Antenna Designation</b>	PIFA Antenna

**Remark:**

1. The sample selected for test was production product and was provided by manufacturer.
2. This submittal(s) (test report) is intended for FCC ID: **HLZDME310SC** filing to comply with Section 15.207, 15.209 and 15.247 of the FCC Part 15, Subpart C Rules.



### **3. TEST METHODOLOGY**

The tests documented in this report were performed in accordance with ANSI C63.4 and FCC CFR 47 Part 15.207, 15.209 and 15.247.

#### **3.1 EUT CONFIGURATION**

The EUT configuration for testing is installed on RF field strength measurement to meet the Commissions requirement and operating in a manner that intends to maximize its emission characteristics in a continuous normal application.

#### **3.2 EUT EXERCISE**

The EUT was operated in the engineering mode to fix the TX frequency that was for the purpose of the measurements.

According to its specifications, the EUT must comply with the requirements of the Section 15.207, 15.209 and 15.247 under the FCC Rules Part 15 Subpart C.

#### **3.3 GENERAL TEST PROCEDURES**

##### **Conducted Emissions**

The EUT is placed on the turntable, which is 0.8 m above ground plane. According to the requirements in Section 13.1.4.1 of ANSI C63.4: 2003 Conducted emissions from the EUT measured in the frequency range between 0.15 MHz and 30MHz using CISPR Quasi-peak and average detector modes.

##### **Radiated Emissions**

The EUT is placed on a turn table, which is 0.8 m above ground plane. The turntable shall rotate 360 degrees to determine the position of maximum emission level. EUT is set 3m away from the receiving antenna, which varied from 1m to 4m to find out the highest emission. And also, each emission was to be maximized by changing the polarization of receiving antenna both horizontal and vertical. In order to find out the maximum emissions, exploratory radiated emission measurements were made according to the requirements in Section 13.1.4.1 of ANSI C63.4: 2003.



### 3.4 FCC PART 15.205 RESTRICTED BANDS OF OPERATIONS

(a) Except as shown in paragraph (d) of this section, only spurious emissions are permitted in any of the frequency bands listed below:

MHz	MHz	MHz	GHz
0.090 - 0.110	16.42 - 16.423	399.9 - 410	4.5 - 5.15
<sup>1</sup> 0.495 - 0.505	16.69475 - 16.69525	608 - 614	5.35 - 5.46
2.1735 - 2.1905	16.80425 - 16.80475	960 - 1240	7.25 - 7.75
4.125 - 4.128	25.5 - 25.67	1300 - 1427	8.025 - 8.5
4.17725 - 4.17775	37.5 - 38.25	1435 - 1626.5	9.0 - 9.2
4.20725 - 4.20775	73 - 74.6	1645.5 - 1646.5	9.3 - 9.5
6.215 - 6.218	74.8 - 75.2	1660 - 1710	10.6 - 12.7
6.26775 - 6.26825	108 - 121.94	1718.8 - 1722.2	13.25 - 13.4
6.31175 - 6.31225	123 - 138	2200 - 2300	14.47 - 14.5
8.291 - 8.294	149.9 - 150.05	2310 - 2390	15.35 - 16.2
8.362 - 8.366	156.52475 -	2483.5 - 2500	17.7 - 21.4
8.37625 - 8.38675	156.52525	2655 - 2900	22.01 - 23.12
8.41425 - 8.41475	156.7 - 156.9	3260 - 3267	23.6 - 24.0
12.29 - 12.293	162.0125 - 167.17	3332 - 3339	31.2 - 31.8
12.51975 - 12.52025	167.72 - 173.2	3345.8 - 3358	36.43 - 36.5
12.57675 - 12.57725	240 - 285	3600 - 4400	( <sup>2</sup> )
13.36 - 13.41	322 - 335.4		

<sup>1</sup> Until February 1, 1999, this restricted band shall be 0.490-0.510 MHz.

<sup>2</sup> Above 38.6

(b) Except as provided in paragraphs (d) and (e), the field strength of emissions appearing within these frequency bands shall not exceed the limits shown in Section 15.209. At frequencies equal to or less than 1000 MHz, compliance with the limits in Section 15.209 shall be demonstrated using measurement instrumentation employing a CISPR quasi-peak detector. Above 1000 MHz, compliance with the emission limits in Section 15.209 shall be demonstrated based on the average value of the measured emissions. The provisions in Section 15.35 apply to these measurements.



### **3.5 DESCRIPTION OF TEST MODES**

The EUT (model: E310) had been tested under operating condition.

Software used to control the EUT for staying in continuous transmitting mode was programmed.

This device is for handheld operation only.

After verification, all tests were carried out with the worst case test modes as shown below except radiated spurious emission below 1GHz and power line conducted emissions below 30MHz, which worst case was in normal link mode only.

IEEE 802.11b mode:

Channel 1(2412MHz), Channel 6(2437MHz) and Channel 11(2462MHz) with 1Mbps data rate were chosen for the final testing.

IEEE 802.11g mode:

Channel 1(2412MHz), Channel 6(2437MHz) and Channel 11(2462MHz) with 6Mbps data rate were chosen for the final testing.

The field strength of spurious emission was measured in the following position: EUT stand-up position (Z axis), lie-down position (X, Y axis). The worst emission was found in stand-up position (Z axis) and the worst case was recorded.



## 4. INSTRUMENT CALIBRATION

### 4.1 MEASURING INSTRUMENT CALIBRATION

The measuring equipment, which was utilized in performing the tests documented herein, has been calibrated in accordance with the manufacturer's recommendations for utilizing calibration equipment, which is traceable to recognized national standards.

### 4.2 MEASUREMENT EQUIPMENT USED

#### Equipment Used for Emissions Measurement

*Remark: Each piece of equipment is scheduled for calibration once a year and Loop Antenna is scheduled for calibration once three years.*

Conducted Emissions Test Site				
Name of Equipment	Manufacturer	Model	Serial Number	Calibration Due
Spectrum Analyzer	Agilent	E4446A	MY43360131	03/03/2011
Power Meter	Anritsu	ML2495A	1012009	03/28/2011
Power Sensor	Anritsu	MA2411B	0917072	03/09/2011

3M Semi Anechoic Chamber				
Name of Equipment	Manufacturer	Model	Serial Number	Calibration Due
Spectrum Analyzer	Agilent	E4446A	US42510252	10/25/2011
EMI Test Receiver	R&S	ESCI	100064	02/04/2011
Pre-Amplifier	Mini-Circuits	ZFL-1000LN	SF350700823	01/13/2011
Pre-Amplifier	MITEQ	AFS44-00102650-42-10P-44	1415367	11/19/2011
Bilog Antenna	Sunol Sciences	JB3	A030105	09/10/2011
Horn Antenna	EMCO	3117	00055165	12/06/2011
Loop Antenna	EMCO	6502	8905/2356	06/10/2013
Turn Table	CCS	CC-T-1F	N/A	N.C.R
Antenna Tower	CCS	CC-A-1F	N/A	N.C.R
Controller	CCS	CC-C-1F	N/A	N.C.R
Site NSA	CCS	N/A	N/A	12/31/2010
Test S/W	EZ-EMC (CCS-3A1RE)			

Powerline Conducted Emissions Test Site				
Name of Equipment	Manufacturer	Model	Serial Number	Calibration Due
EMI Test Receiver	R&S	ESHS10	843743/015	03/25/2011
LISN	SCHWARZBECK	NSLK 8127	8127-541	03/14/2011
LISN	SCHAFFNER	NNB 41	03/10013	12/02/2011
Test S/W	CCS-3A1-CE			





### 4.3 MEASUREMENT UNCERTAINTY

PARAMETER	UNCERTAINTY
Powerline Conducted Emission	+/- 1.6202
3M Semi Anechoic Chamber / 30M~200M	+/- 4.0606
3M Semi Anechoic Chamber / 200M~1000M	+/- 3.9979
3M Semi Anechoic Chamber / 1G~8G	+/- 2.5790
3M Semi Anechoic Chamber / 8G~18G	+/- 2.5928
3M Semi Anechoic Chamber / 18G~26G	+/- 2.7212
3M Semi Anechoic Chamber / 26G~40G	+/- 2.9520

**Remark:** This uncertainty represents an expanded uncertainty expressed at approximately the 95% confidence level using a coverage factor of  $k=2$ .



## **5. FACILITIES AND ACCREDITATIONS**

### **5.1 FACILITIES**

All measurement facilities used to collect the measurement data are located at

No.199, Chunghsen Road, Hsintien City, Taipei Hsien, Taiwan, R.O.C.

Tel: 886-2-2217-0894 / Fax: 886-2-2217-1029

No.11, Wugong 6th Rd., Wugu Industrial Park, Taipei Hsien 248, Taiwan

Tel: 886-2-2299-9720 / Fax: 886-2-2298-4045

No.139, Wugong Rd., Wugu Industrial Park, Taipei Hsien 248, Taiwan

No.81-1, Lane 210, Bade 2nd Rd., Luchu Hsiang, Taoyuan Hsien 338, Taiwan

Tel: 886-3-324-0332 / Fax: 886-3-324-5235

The sites are constructed in conformance with the requirements of ANSI C63.7, ANSI C63.4 and CISPR Publication 22.

### **5.2 EQUIPMENT**

Radiated emissions are measured with one or more of the following types of linearly polarized antennas: tuned dipole, biconical, log periodic, bi-log, and/or ridged waveguide, horn. Spectrum analyzers with pre-selectors and quasi-peak detectors are used to perform radiated measurements.



Conducted emissions are measured with Line Impedance Stabilization Networks and EMI Test Receivers.

Calibrated wideband preamplifiers, coaxial cables, and coaxial attenuators are also used for making measurements.

All receiving equipment conforms to CISPR Publication 16-1, "Radio Interference Measuring Apparatus and Measurement Methods."



### 5.3 TABLE OF ACCREDITATIONS AND LISTINGS

Country	Agency	Scope of Accreditation	Logo
USA	FCC	3M Semi Anechoic Chamber (FCC MRA: TW1039) to perform FCC Part 15 measurements	 FCC MRA: TW1039
Taiwan	TAF	LP0002, RTTE01, FCC Method-47 CFR Part 15 Subpart C, D, E, RSS-210, RSS-310 IDA TS SRD, AS/NZS 4268, AS/NZS 4771, TS 12.1 & 12.2, ETSI EN 300 440-1, ETSI EN 300 440-2, ETSI EN 300 328, ETSI EN 300 220-1, ETSI EN 300 220-2, ETSI EN 301 893, ETSI EN 301 489-1/3/7/17 FCC OET Bulletin 65 + Supplement C, EN 50360, EN 50361, EN 50371, RSS 102, EN 50383, EN 50385, EN 50392, IEC 62209, CNS 14958-1, CNS 14959 FCC Method -47 CFR Part 15 Subpart B IEC / EN 61000-3-2, IEC / EN 61000-3-3, IEC / EN 61000-4-2/3/4/5/6/8/11	
Canada	Industry Canada	3M Semi Anechoic Chamber (IC 2324G-1 / IC 2324G-2) to perform	 IC 2324G-1 IC 2324G-2

\* No part of this report may be used to claim or imply product endorsement by A2LA or any agency of the US Government.



## 6. SETUP OF EQUIPMENT UNDER TEST

### 6.1 SETUP CONFIGURATION OF EUT

See test photographs attached in Appendix II for the actual connections between EUT and support equipment.

### 6.2 SUPPORT EQUIPMENT

No.	Device Type	Brand	Model	Series No.	FCC ID	Data Cable	Power Cord
1.	SD Card	SANDISK	N/A	N/A	N/A	N/A	N/A
2.	SIM Card	N/A	N/A	N/A	N/A	N/A	N/A
3.	Bluetooth Tester (Remote)	Anritsu	MT8852B	750013	N/A	N/A	Unshielded, 1.8m
4.	Notebook PC (Remote)	HP	dv6-1332TX	CNF9491GM9	PD9112BNHU	N/A	AC I/P: Unshielded, 1.8m DC O/P: Unshielded, 1.8m with a core
5.	Wireless Router (Remote)	ASUS	WL-500g	471GA12838	MSQWL500G	LAN Cable: Unshielded, 10m	Unshielded, 1.8m
6.	Universal Radio Communication Tester (Remote)	R&S	CMU200	101245	N/A	N/A	Unshielded, 1.8m
7.	GPS Simulator (Remote)	HWAJEAT	GPS-101	EN001	N/A	N/A	N/A

**Remark:**

1. All the equipment/cables were placed in the worst-case configuration to maximize the emission during the test.
2. Grounding was established in accordance with the manufacturer's requirements and conditions for the intended use.



## 7. FCC PART 15.247 REQUIREMENTS

### 7.1 6DB BANDWIDTH

#### LIMIT

According to §15.247(a)(2), systems using digital modulation techniques may operate in the 902 - 928 MHz, 2400 - 2483.5 MHz, and 5725 - 5850 MHz bands. The minimum 6 dB bandwidth shall be at least 500 kHz.

#### Test Configuration

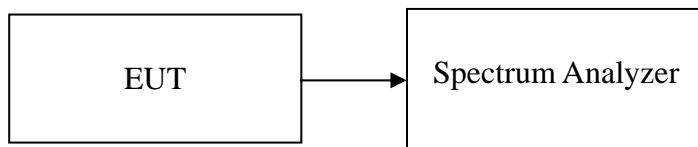

#### TEST PROCEDURE

1. Place the EUT on the table and set it in the transmitting mode.
2. Remove the antenna from the EUT and then connect a low loss RF cable from the antenna port to the spectrum analyzer.
3. Set the spectrum analyzer as RBW = 100kHz, VBW = RBW, Span = 50MHz, Sweep = auto.
4. Mark the peak frequency and -6dB (upper and lower) frequency.
5. Repeat until all the rest channels are investigated.

#### TEST RESULTS

*No non-compliance noted.*



**Test mode: IEEE 802.11b**

Channel	Frequency (MHz)	6dB Bandwidth (kHz)	Limit (kHz)	Result
Low	2412	8580	>500	PASS
Mid	2437	9000		PASS
High	2462	8580		PASS

**Test mode: IEEE 802.11g**

Channel	Frequency (MHz)	6dB Bandwidth (kHz)	Limit (kHz)	Result
Low	2412	16500	>500	PASS
Mid	2437	16420		PASS
High	2462	16330		PASS



### Test Plot

#### IEEE 802.11b

#### 6dB Bandwidth (CH Low)

Agilent 13:26:32 Nov 29, 2010

R T

Δ Mkr1 8.58 MHz  
0.31 dB

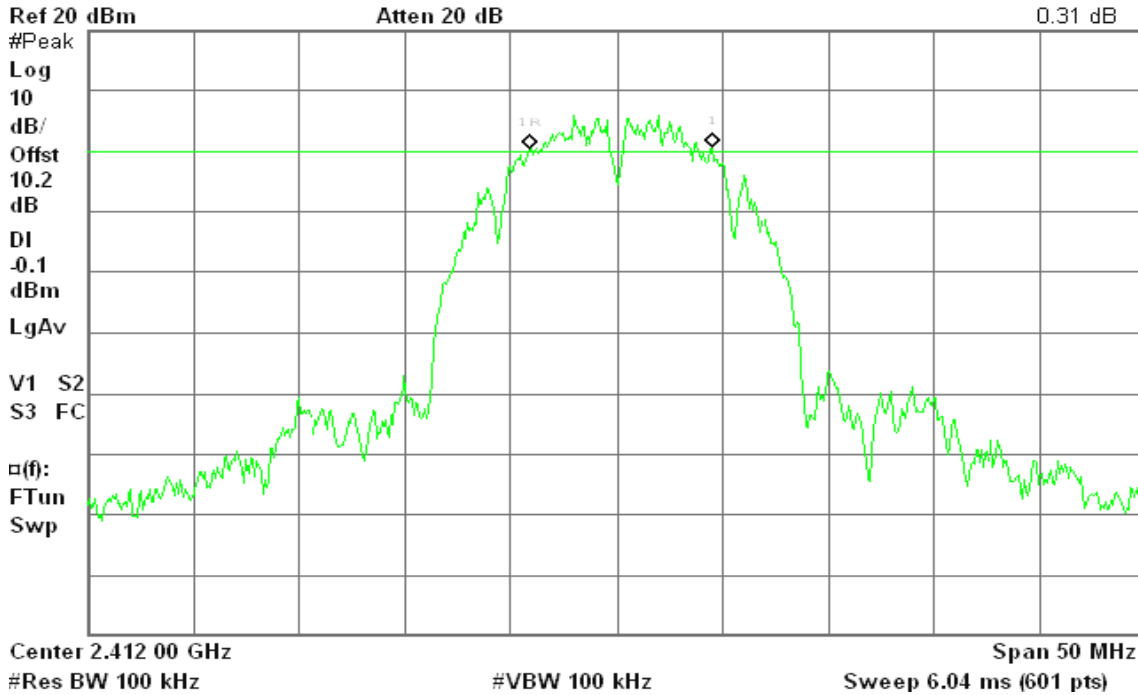

#### 6dB Bandwidth (CH Mid)

Agilent 13:31:11 Nov 29, 2010

R T

Δ Mkr1 9.00 MHz  
-1.04 dB

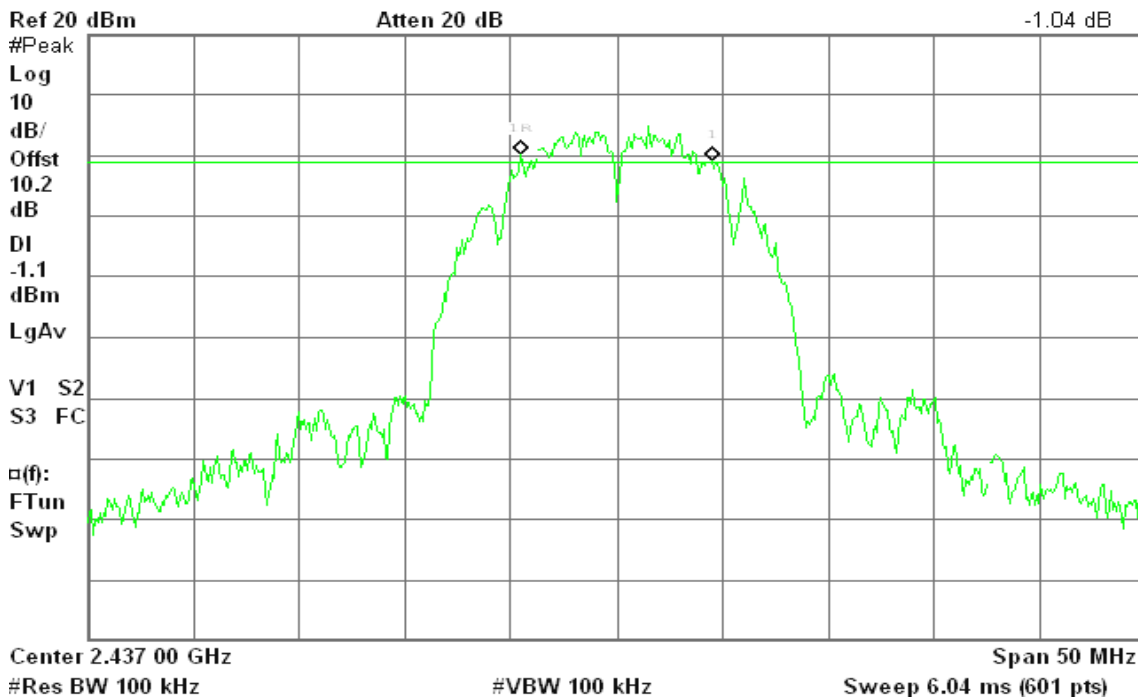



### 6dB Bandwidth (CH High)

Agilent 13:34:57 Nov 29, 2010

R T

Δ Mkr1 8.58 MHz  
0.08 dB

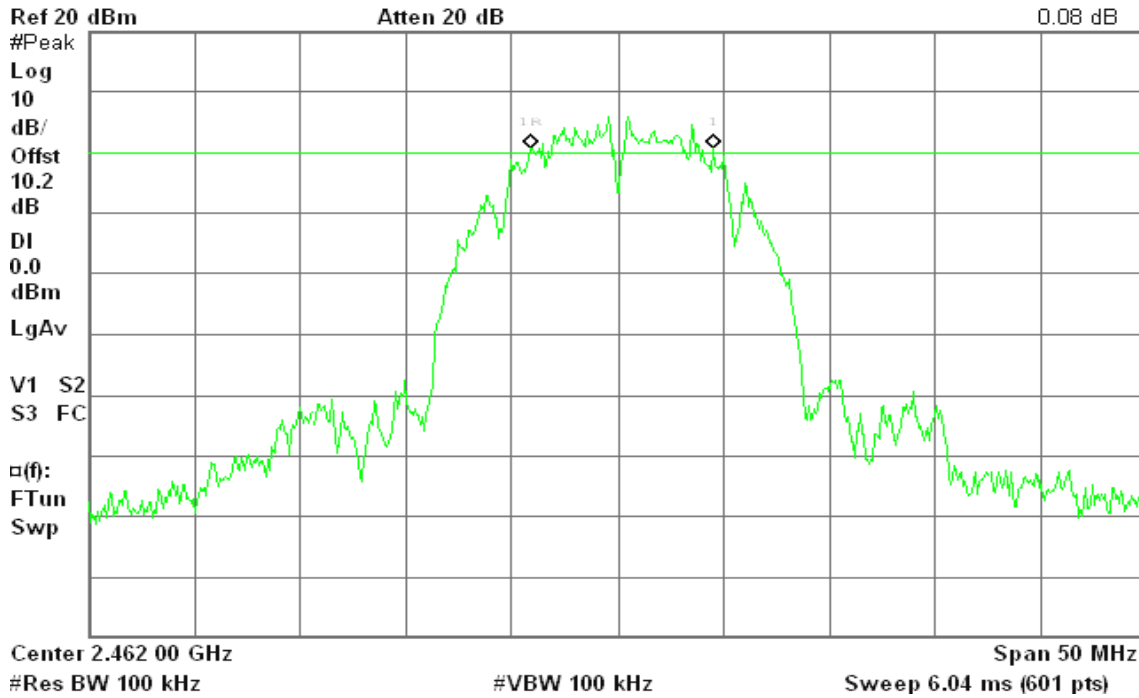

### IEEE 802.11g

### 6dB Bandwidth (CH Low)

Agilent 13:38:59 Nov 29, 2010

R T

Δ Mkr1 16.50 MHz  
0.94 dB

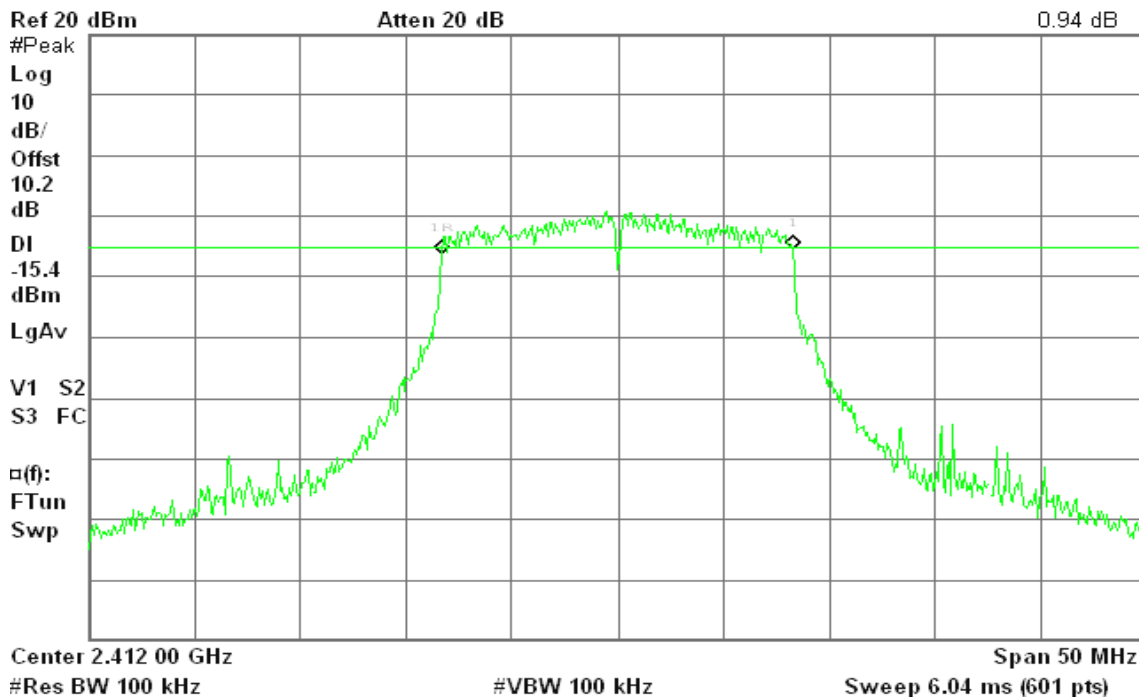





### 6dB Bandwidth (CH Mid)

Agilent 13:49:23 Nov 29, 2010

R T

Δ Mkr1 16.42 MHz  
-2.17 dB

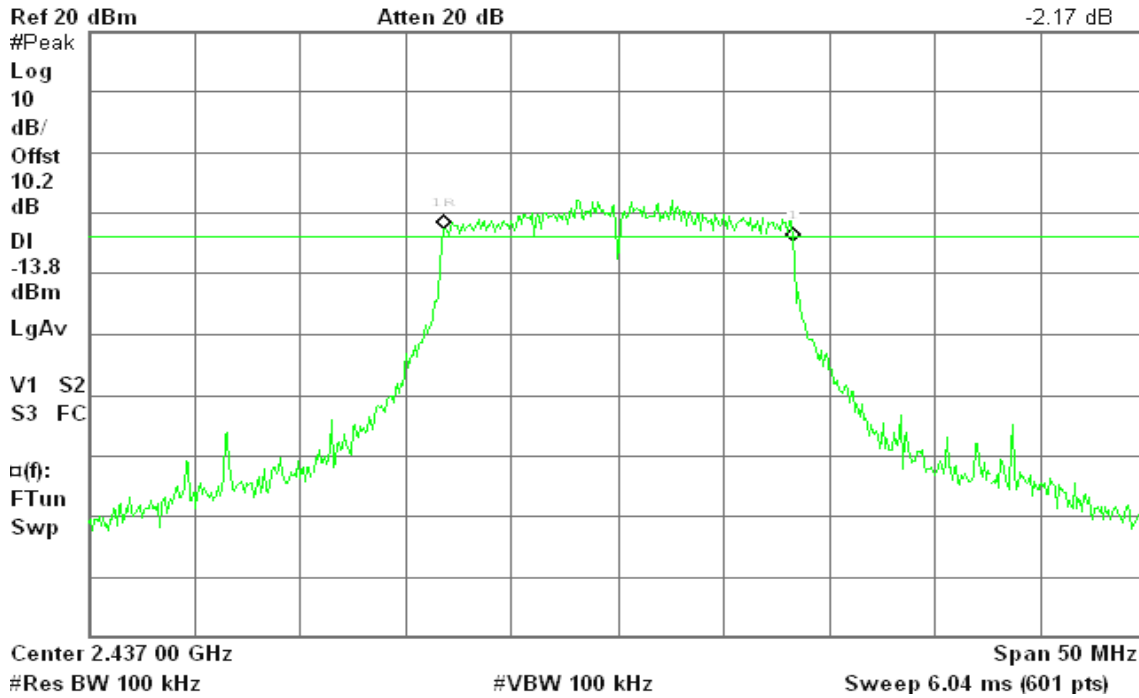

### 6dB Bandwidth (CH High)

Agilent 14:01:49 Nov 29, 2010

R L

Δ Mkr1 16.33 MHz  
0.36 dB

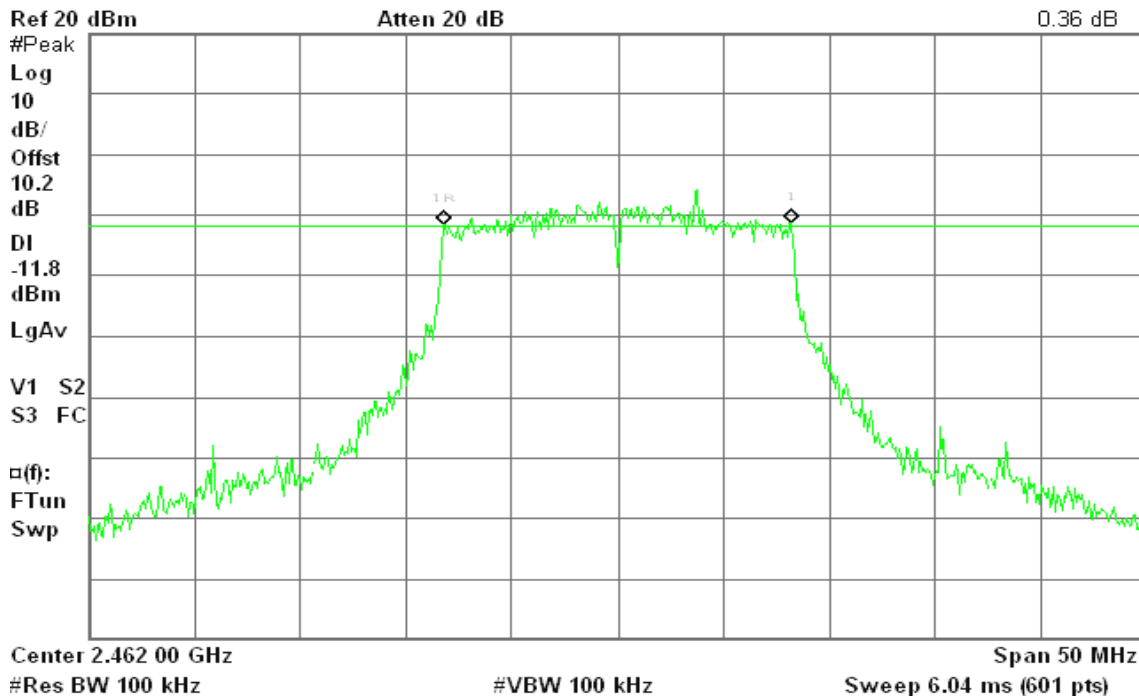



## 7.2 PEAK POWER

### LIMIT

The maximum peak output power of the intentional radiator shall not exceed the following:

1. According to §15.247(b)(3), for systems using digital modulation in the bands of 902-928 MHz, 2400-2483.5 MHz, and 5725-5850 MHz: 1 Watt.
2. According to §15.247(b)(4), the conducted output power limit specified in paragraph (b) of this section is based on the use of antennas with directional gains that do not exceed 6 dBi. Except as shown in paragraph (c) of this section, if transmitting antennas of directional gain greater than 6 dBi are used, the conducted output power from the intentional radiator shall be reduced below the stated values in paragraphs (b)(1), (b)(2), and (b)(3) of this section, as appropriate, by the amount in dB that the directional gain of the antenna exceeds 6 dBi.

### Test Configuration

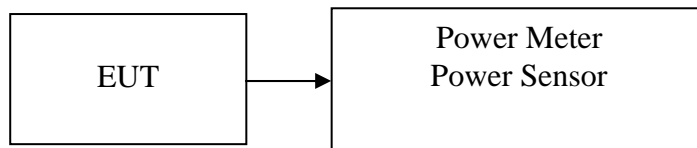

### TEST PROCEDURE

The transmitter output is connected to the Power Meter. The Power Meter is set to the peak power detection.

IEEE 802.11b mode:

Channel 1(2412MHz), Channel 6(2437MHz) and Channel 11(2462MHz) with 1Mbps data rate.

IEEE 802.11g mode:

Channel 1(2412MHz), Channel 6(2437MHz) and Channel 11(2462MHz) with 6Mbps data rate.

### TEST RESULTS

*No non-compliance noted.*



**Test Data**

**Test mode: IEEE 802.11b**

Channel	Frequency (MHz)	Output Power (dBm)	Output Power (W)	Limit (W)	Result
Low	2412	18.22	0.0664	1.00	PASS
Mid	2437	18.31	0.0678		PASS
High	2462	18.31	0.0678		PASS

**Test mode: IEEE 802.11g**

Channel	Frequency (MHz)	Output Power (dBm)	Output Power (W)	Limit (W)	Result
Low	2412	23.16	0.2070	1.00	PASS
Mid	2437	23.16	0.2070		PASS
High	2462	23.13	0.2056		PASS



### 7.3 AVERAGE POWER

#### LIMIT

None; for reporting purposes only.

#### Test Configuration

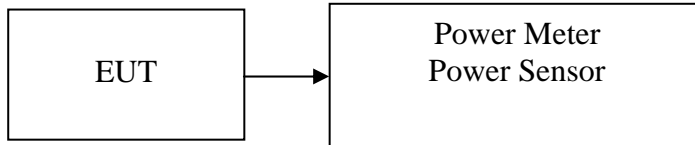

#### TEST PROCEDURE

The transmitter output is connected to the Power Meter. The Power Meter is set to the peak power detection.

#### TEST RESULTS

*No non-compliance noted.*

#### Test Data

##### Test mode: IEEE 802.11b mode

Channel	Frequency (MHz)	Output Power (dBm)
Low	2412	15.27
Mid	2437	15.40
High	2462	15.40

##### Test mode: IEEE 802.11g mode

Channel	Frequency (MHz)	Output Power (dBm)
Low	2412	12.37
Mid	2437	12.49
High	2462	12.46



## 7.4 BAND EDGES MEASUREMENT

### LIMIT

According to §15.247(d), in any 100 kHz bandwidth outside the frequency bands in which the spread spectrum intentional radiator is operating, the radio frequency power that is produced by the intentional radiator shall be at least 20 dB below that in the 100 kHz bandwidth within the band that contains the highest level of the desired power, based on either an RF conducted or a radiated measurement, provided the transmitter demonstrates compliance with the peak conducted power limits. In addition, radiated emissions which fall in the restricted bands, as defined in §15.205(a), must also comply with the radiated emission limits specified in 15.209(a) (see Section 15.205(c)).

### Test Configuration

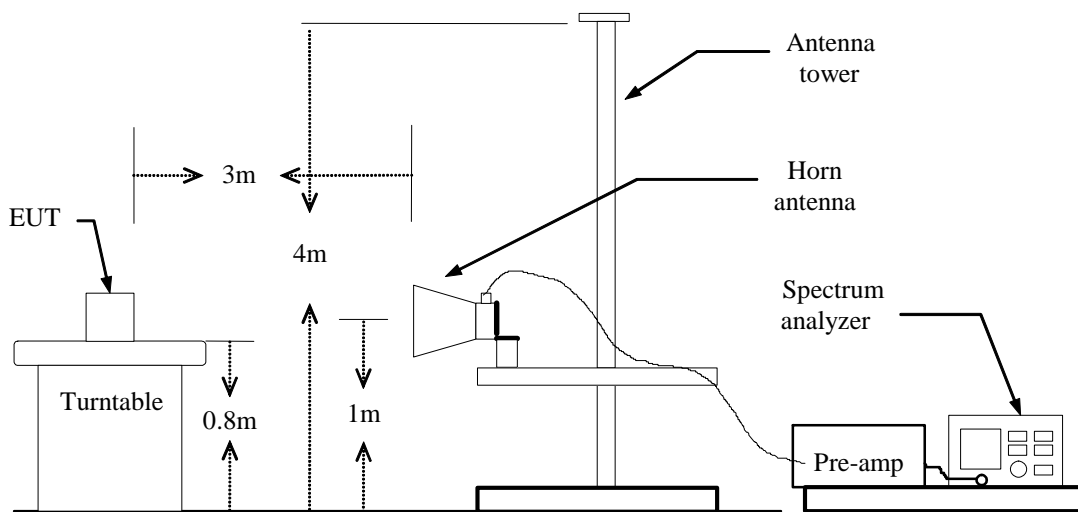

### TEST PROCEDURE

1. The EUT is placed on a turntable, which is 0.8m above the ground plane.
2. The turntable shall be rotated for 360 degrees to determine the position of maximum emission level.
3. EUT is set 3m away from the receiving antenna, which is varied from 1m to 4m to find out the highest emission.
4. Set the spectrum analyzer in the following setting in order to capture the lower and upper band-edges of the emission:
  - (a) PEAK: RBW=VBW=1MHz / Sweep=AUTO
  - (b) AVERAGE: RBW=1MHz / VBW=10Hz / Sweep=AUTO
5. Repeat the procedures until all the PEAK and AVERAGE versus POLARIZATION are measured.

### TEST RESULTS

Refer to attach spectrum analyzer data chart.



### Band Edges (IEEE 802.11b / CH Low)

Detector mode: Peak

Polarity: Vertical

Agilent 11:17:43 Nov 30, 2010

R T

Mkr3 2.413 0 GHz  
98.90 dBµV

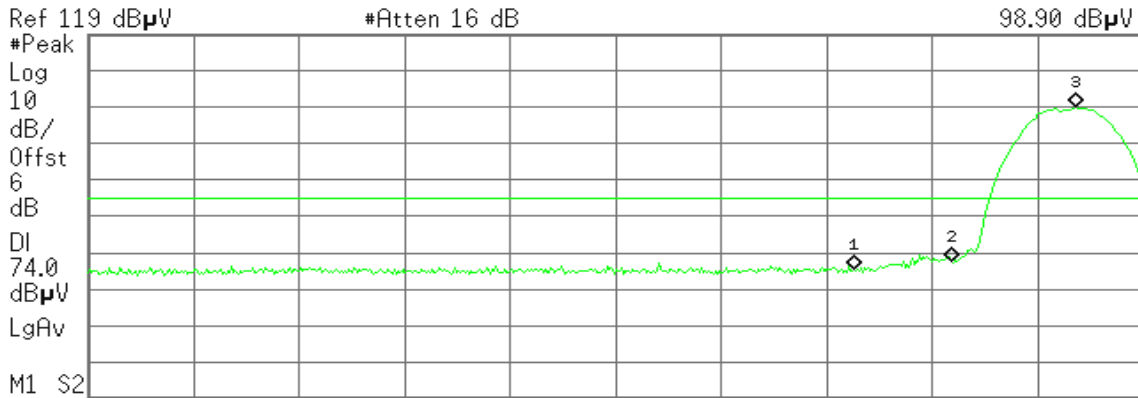

Marker	Trace	Type	X Axis	Amplitude
1	(1)	Freq	2.390 0 GHz	54.44 dBµU
2	(1)	Freq	2.400 0 GHz	56.72 dBµU
3	(1)	Freq	2.413 0 GHz	98.90 dBµU

Detector mode: Average

Polarity: Vertical

Agilent 11:18:15 Nov 30, 2010

R T

Mkr3 2.413 0 GHz  
95.80 dBµV

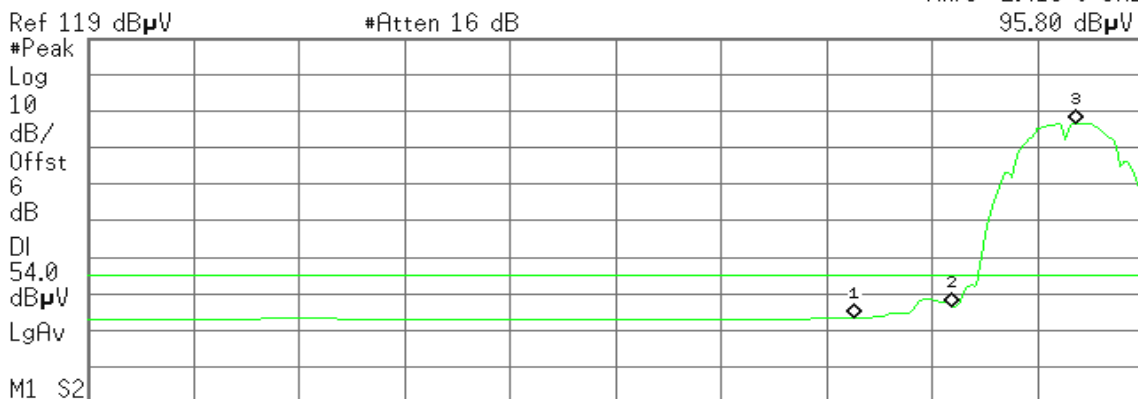

Marker	Trace	Type	X Axis	Amplitude
1	(1)	Freq	2.390 0 GHz	42.42 dBµU
2	(1)	Freq	2.400 0 GHz	45.46 dBµU
3	(1)	Freq	2.413 0 GHz	95.80 dBµU



Detector mode: Peak

Polarity: Horizontal

Agilent 11:09:22 Nov 30, 2010

R T

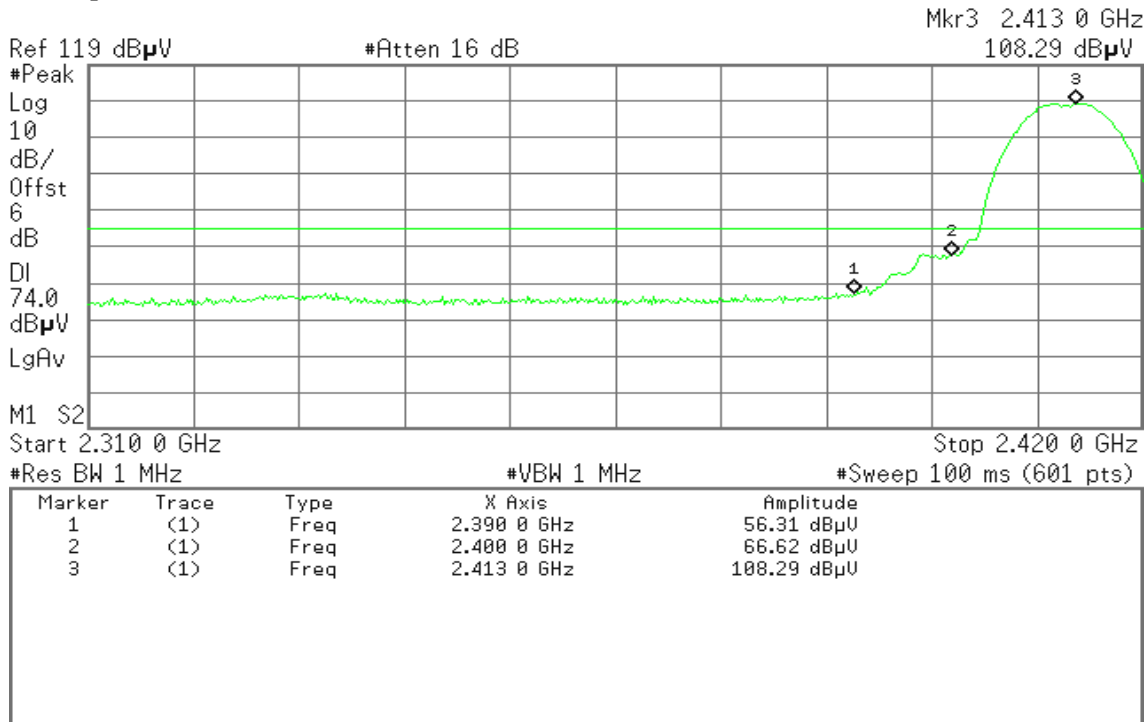

Detector mode: Average

Polarity: Horizontal

Agilent 11:08:44 Nov 30, 2010

R T

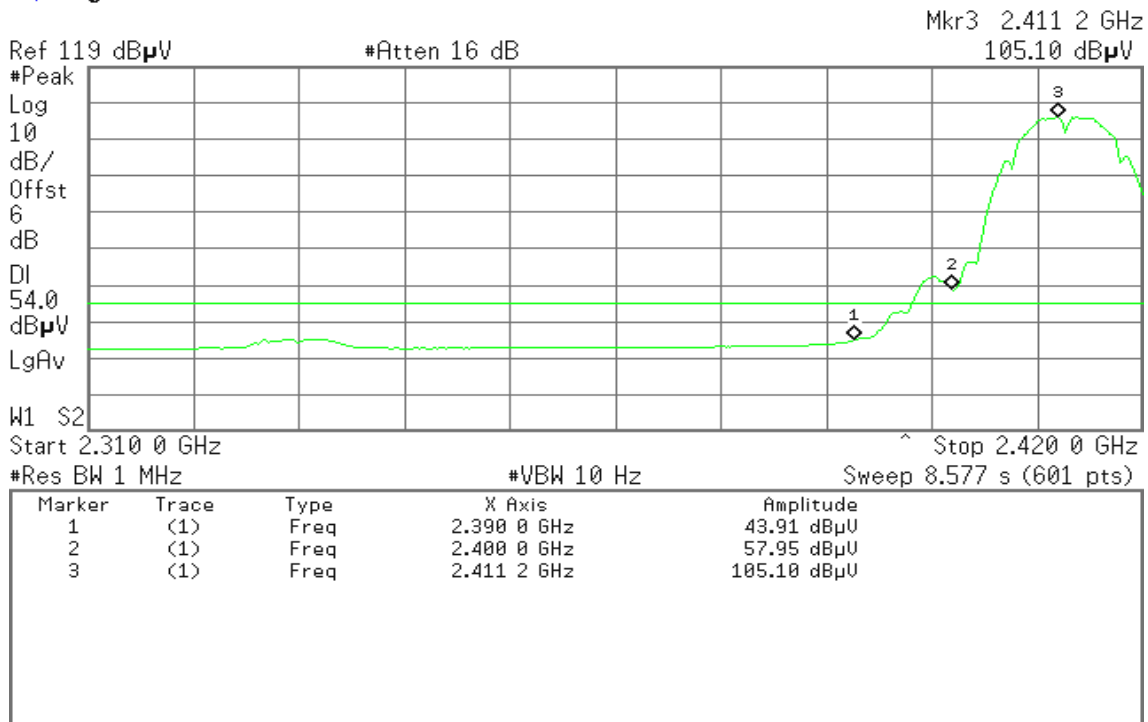



### Band Edges (IEEE 802.11b / CH High)

Detector mode: Peak

Polarity: Vertical

Agilent 11:32:21 Nov 30, 2010

R T

Mkr1 2.483 50 GHz  
55.09 dB $\mu$ V

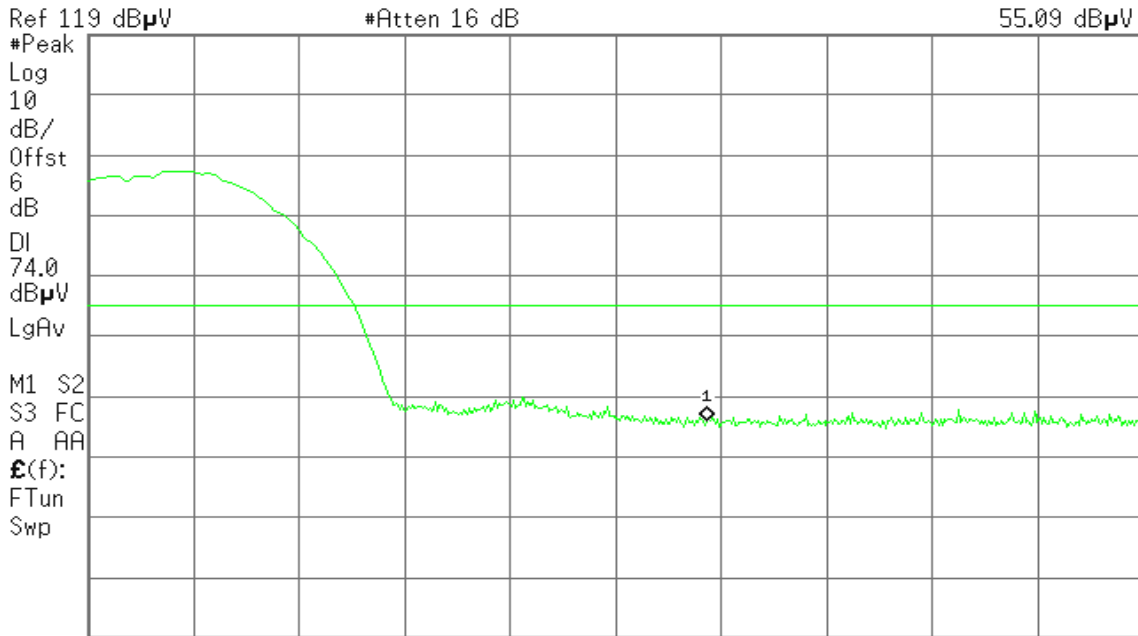

Detector mode: Average

Polarity: Vertical

Agilent 11:31:53 Nov 30, 2010

R T

Mkr1 2.483 50 GHz  
42.85 dB $\mu$ V

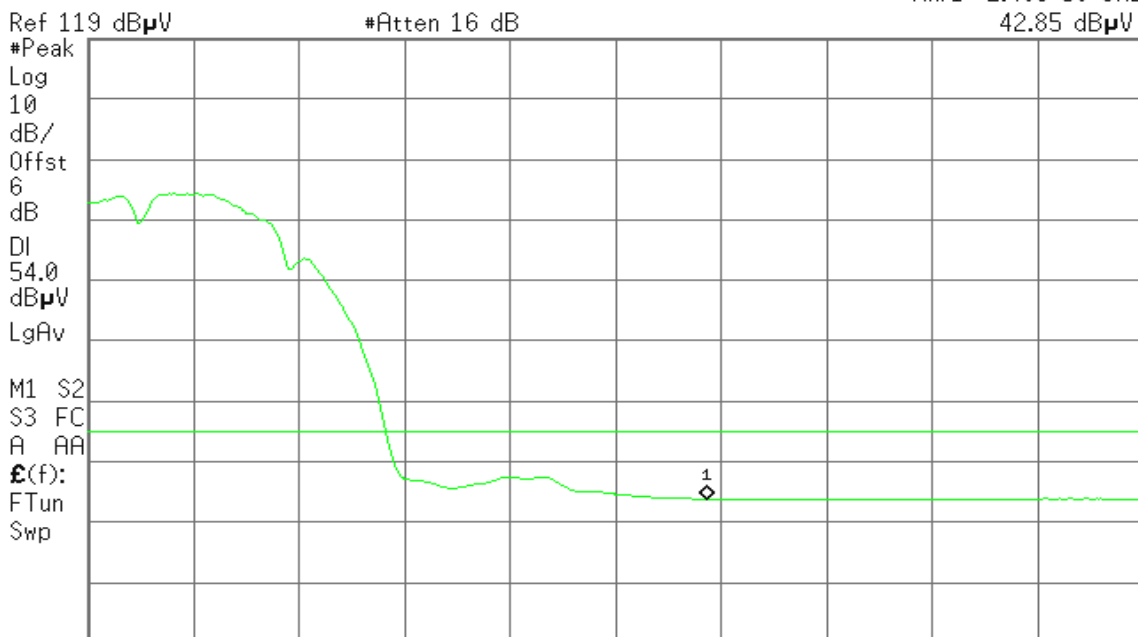





**Detector mode: Peak**

**Polarity: Horizontal**

Agilent 11:36:06 Nov 30, 2010

R T

Mkr1 2.483 50 GHz  
57.46 dB $\mu$ V

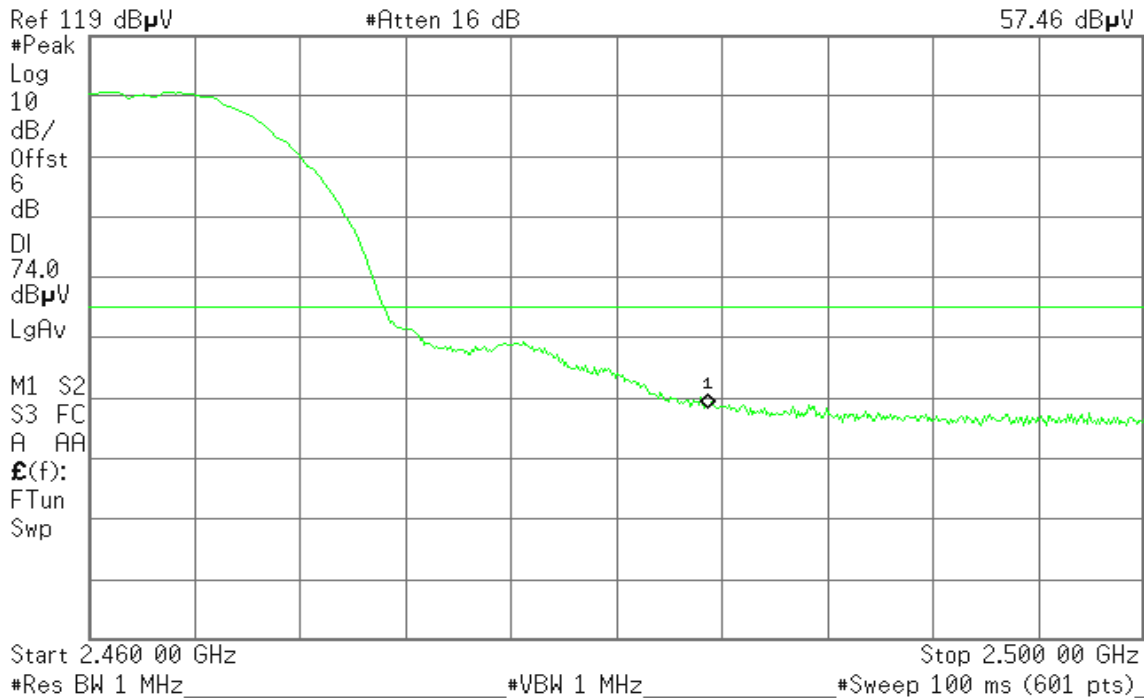

**Detector mode: Average**

**Polarity: Horizontal**

Agilent 11:36:27 Nov 30, 2010

R T

Mkr1 2.483 50 GHz  
45.82 dB $\mu$ V

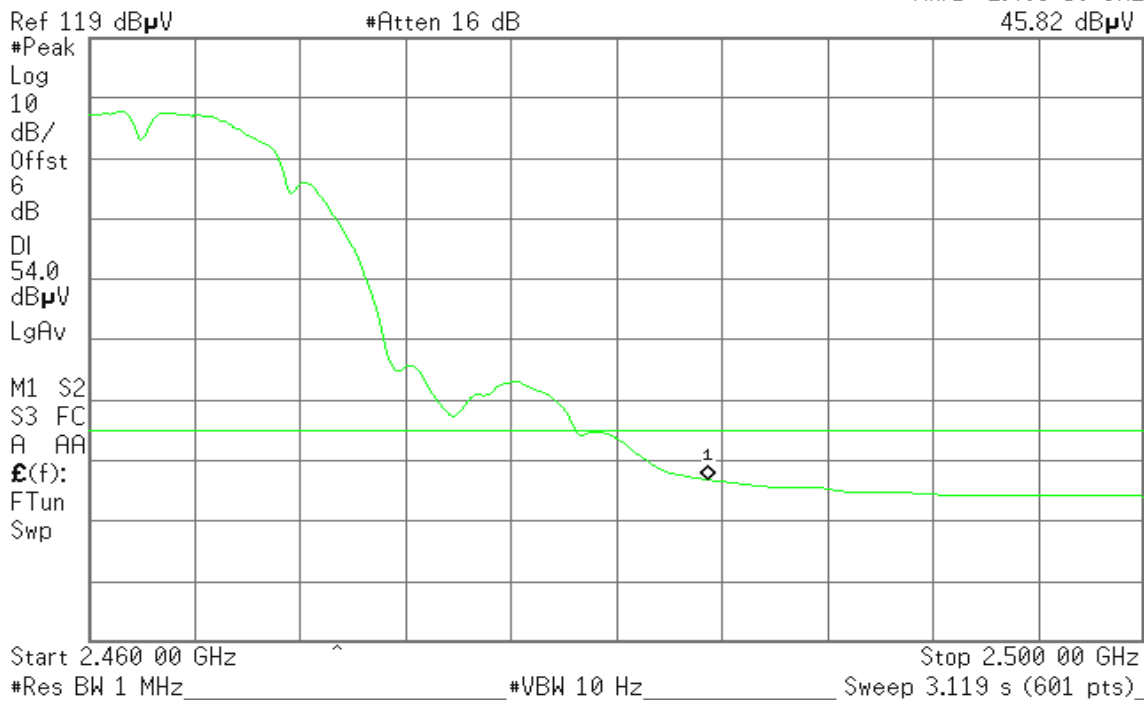



### Band Edges (IEEE 802.11g / CH Low)

Detector mode: Peak

Polarity: Vertical

Agilent 11:19:43 Nov 30, 2010

R T

Mkr3 2.413 2 GHz  
94.06 dBμV

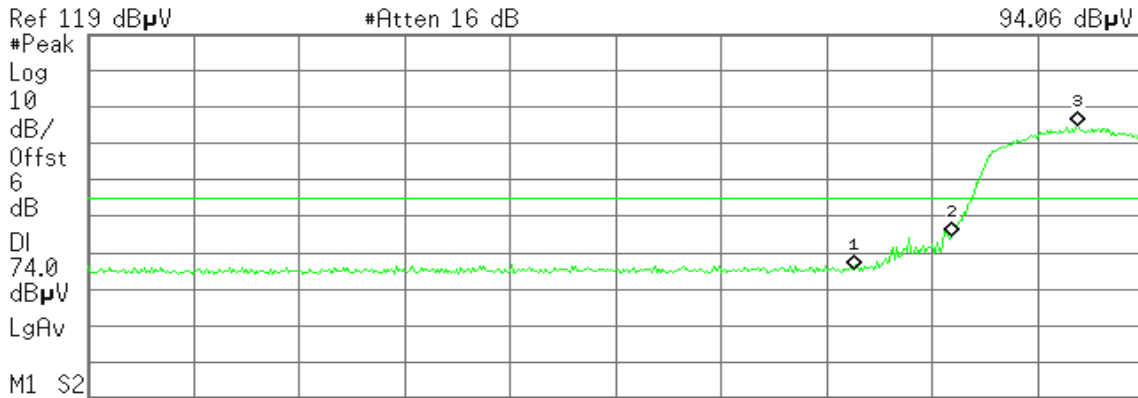

Marker	Trace	Type	X Axis	Amplitude
1	(1)	Freq	2.390 0 GHz	54.45 dBμU
2	(1)	Freq	2.400 0 GHz	63.68 dBμU
3	(1)	Freq	2.413 2 GHz	94.06 dBμU

Detector mode: Average

Polarity: Vertical

Agilent 11:19:07 Nov 30, 2010

R T

Mkr3 2.413 4 GHz  
81.21 dBμV

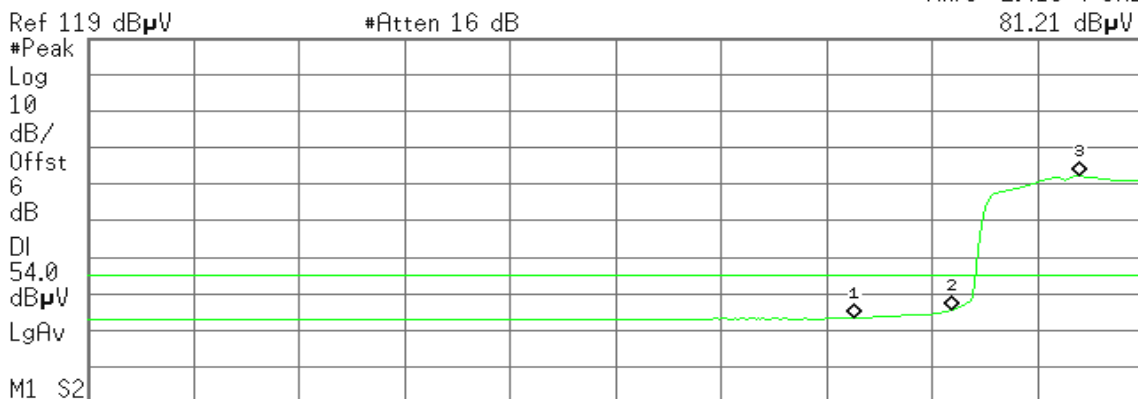

Marker	Trace	Type	X Axis	Amplitude
1	(1)	Freq	2.390 0 GHz	42.32 dBμU
2	(1)	Freq	2.400 0 GHz	44.58 dBμU
3	(1)	Freq	2.413 4 GHz	81.21 dBμU



Detector mode: Peak

Polarity: Horizontal

Agilent 11:06:14 Nov 30, 2010

R T

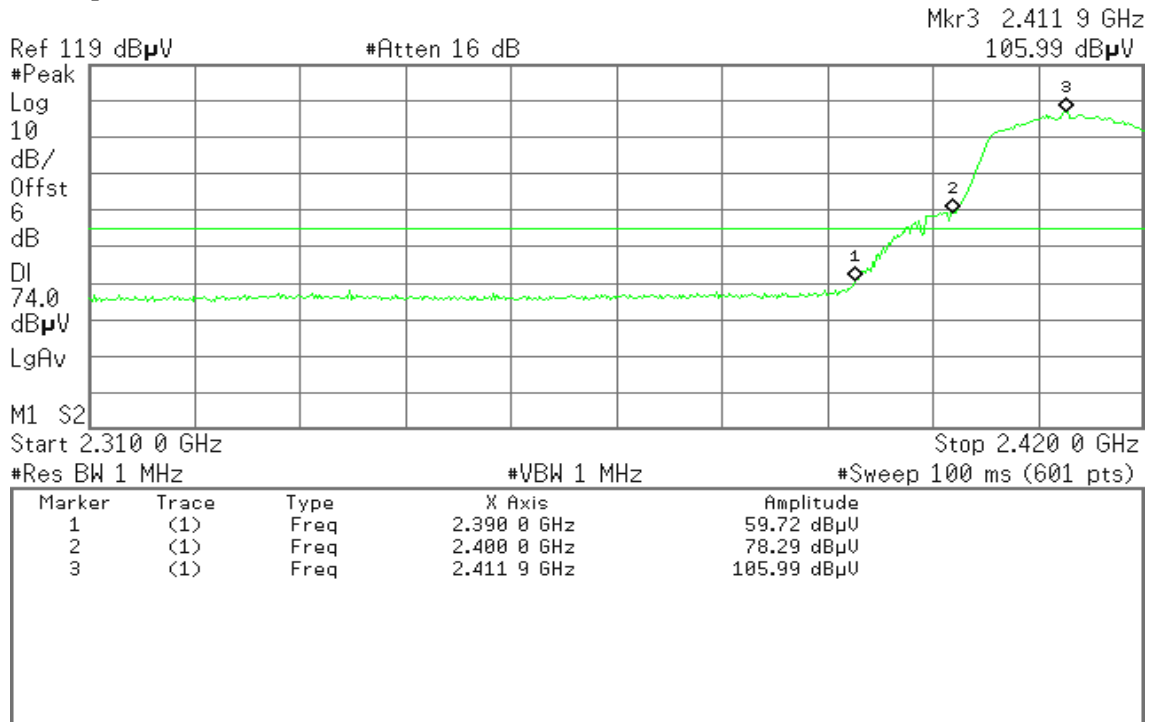

Detector mode: Average

Polarity: Horizontal

Agilent 11:07:09 Nov 30, 2010

R T

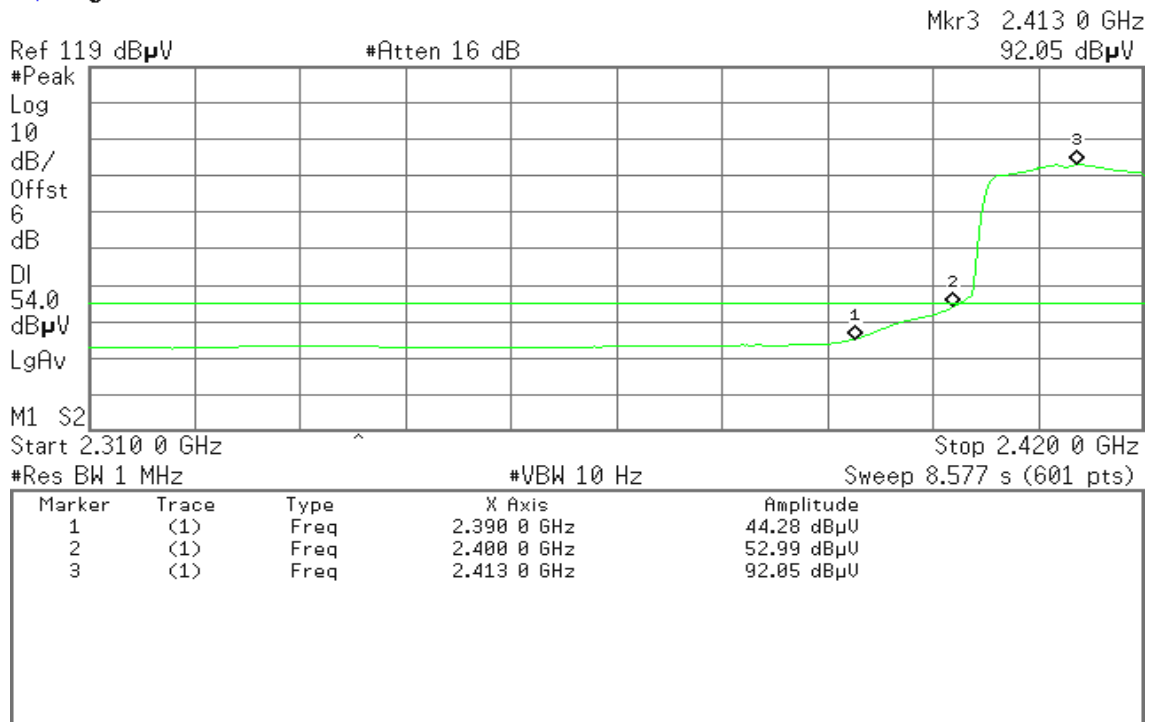



### Band Edges (IEEE 802.11g / CH High)

Detector mode: Peak

Polarity: Vertical

Agilent 11:30:51 Nov 30, 2010

R T

Mkr1 2.483 50 GHz  
55.08 dB $\mu$ V

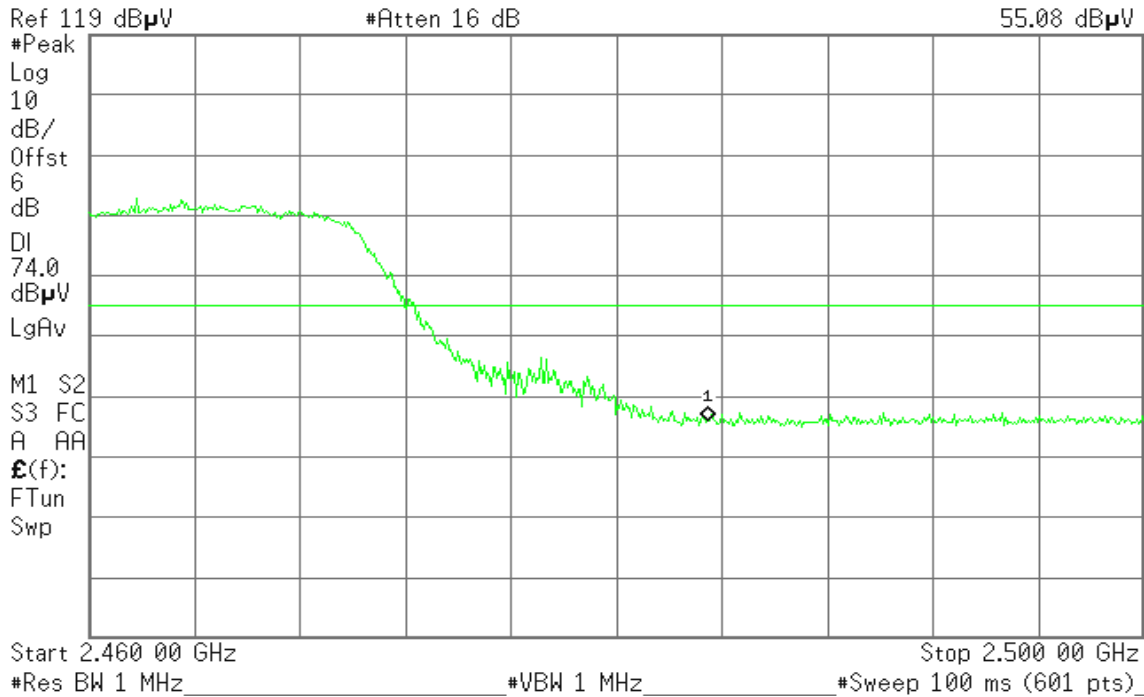

Detector mode: Average

Polarity: Vertical

Agilent 11:31:13 Nov 30, 2010

R T

Mkr1 2.483 50 GHz  
42.78 dB $\mu$ V

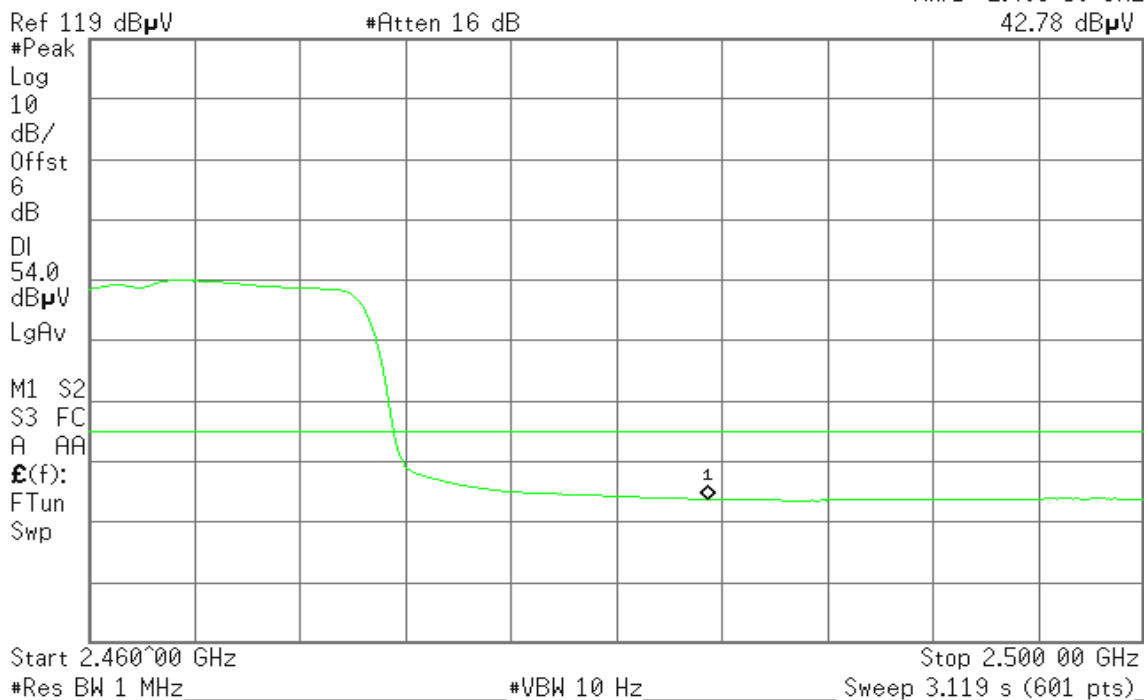



**Detector mode: Peak**

**Polarity: Horizontal**

Agilent 11:37:44 Nov 30, 2010

R T

Mkr1 2.483 50 GHz  
61.20 dB $\mu$ V

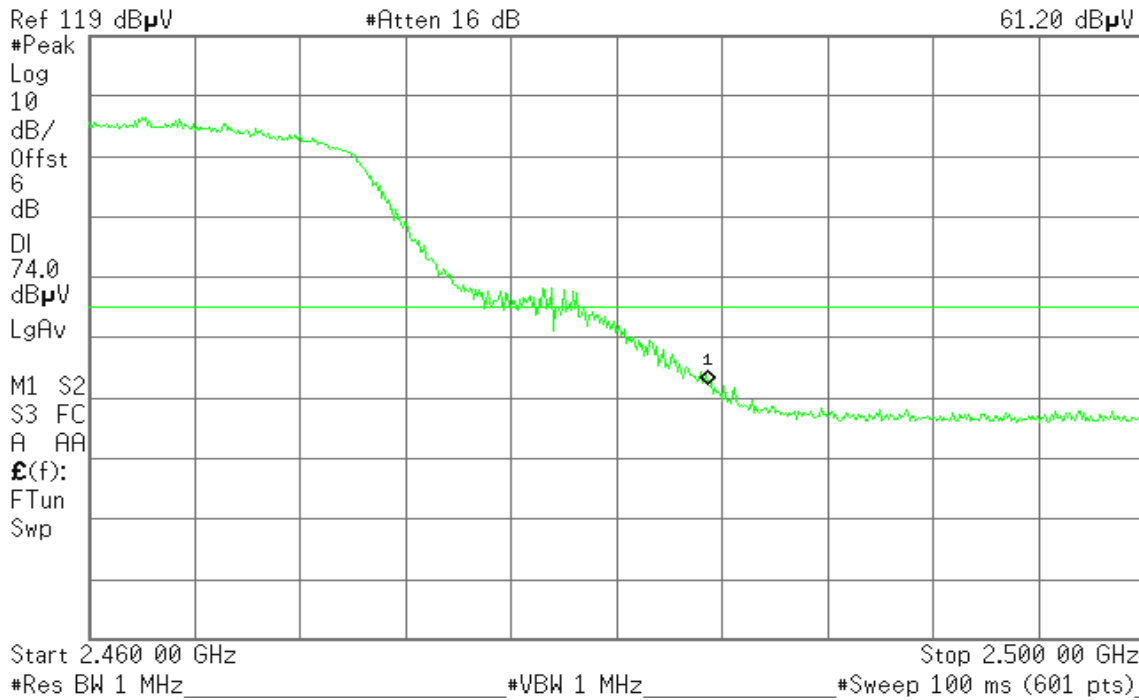

**Detector mode: Average**

**Polarity: Horizontal**

Agilent 11:36:59 Nov 30, 2010

R T

Mkr1 2.483 50 GHz  
45.68 dB $\mu$ V

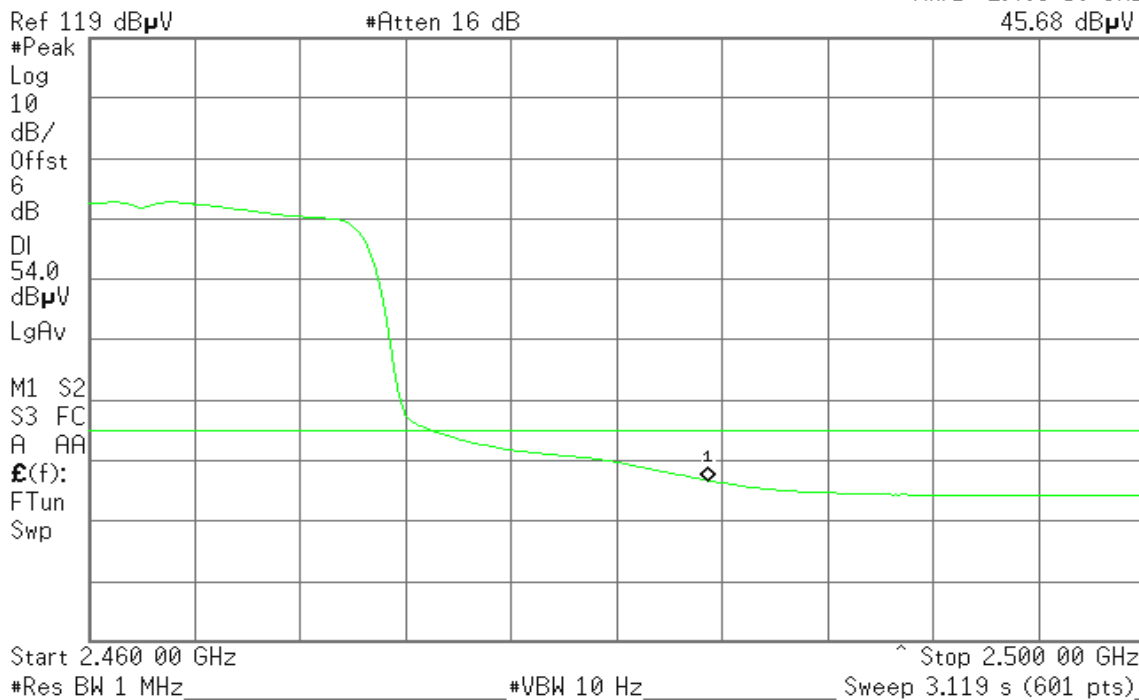



## 7.5 PEAK POWER SPECTRAL DENSITY

### LIMIT

1. According to §15.247(e), for digitally modulated systems, the power spectral density conducted from the intentional radiator to the antenna shall not be greater than 8 dBm in any 3 kHz band during any time interval of continuous transmission.
2. According to §15.247(f), the digital modulation operation of the hybrid system, with the frequency hopping turned off, shall comply with the power density requirements of paragraph (d) of this section.

### Test Configuration

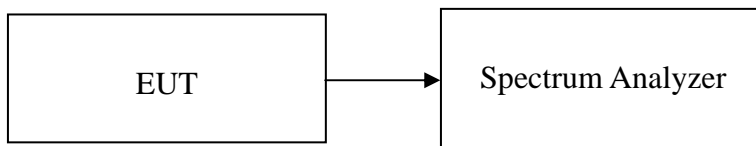

### TEST PROCEDURE

1. Place the EUT on the table and set it in transmitting mode.  
Remove the antenna from the EUT and then connect a low loss RF cable from the antenna port to the spectrum analyzer.
2. Set the spectrum analyzer as RBW = 3kHz, VBW = 10kHz, Span = 300kHz, Sweep=100s
3. Record the max. reading.
4. Repeat the above procedure until the measurements for all frequencies are completed.

### TEST RESULTS

*No non-compliance noted.*



**Test Data**

**Test mode: IEEE 802.11b**

Channel	Frequency (MHz)	PPSD (dBm)	Limit (dBm)	Result
Low	2412	-4.62	8.00	PASS
Mid	2437	-7.07		PASS
High	2462	-5.74		PASS

**Test mode: IEEE 802.11g**

Channel	Frequency (MHz)	PPSD (dBm)	Limit (dBm)	Result
Low	2412	-19.86	8.00	PASS
Mid	2437	-18.17		PASS
High	2462	-18.05		PASS



**Test Plot**

**IEEE 802.11b**

**PPSD (CH Low)**

Agilent 13:29:09 Nov 29, 2010

R T

Mkr1 2.412 784 1 GHz

-4.62 dBm

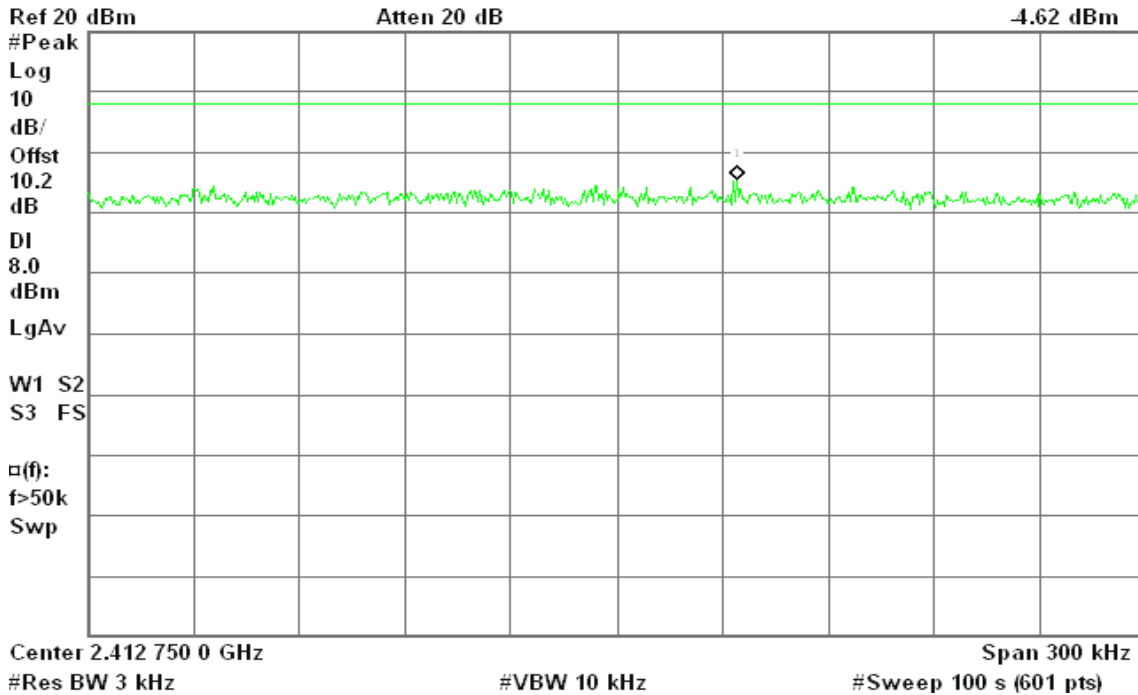

**PPSD (CH Mid)**

Agilent 13:33:44 Nov 29, 2010

R L

Mkr1 2.438 519 9 GHz

-7.07 dBm

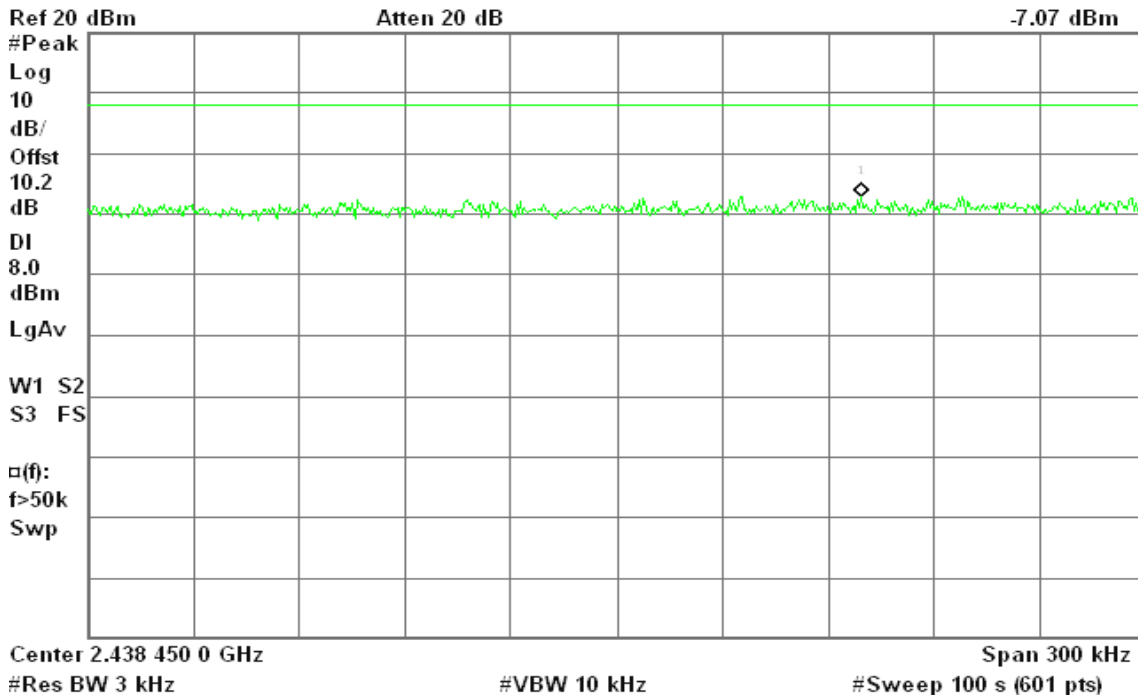





### PPSD (CH High)

Agilent 13:37:29 Nov 29, 2010

R T

Mkr1 2.461 222 9 GHz  
-5.74 dBm

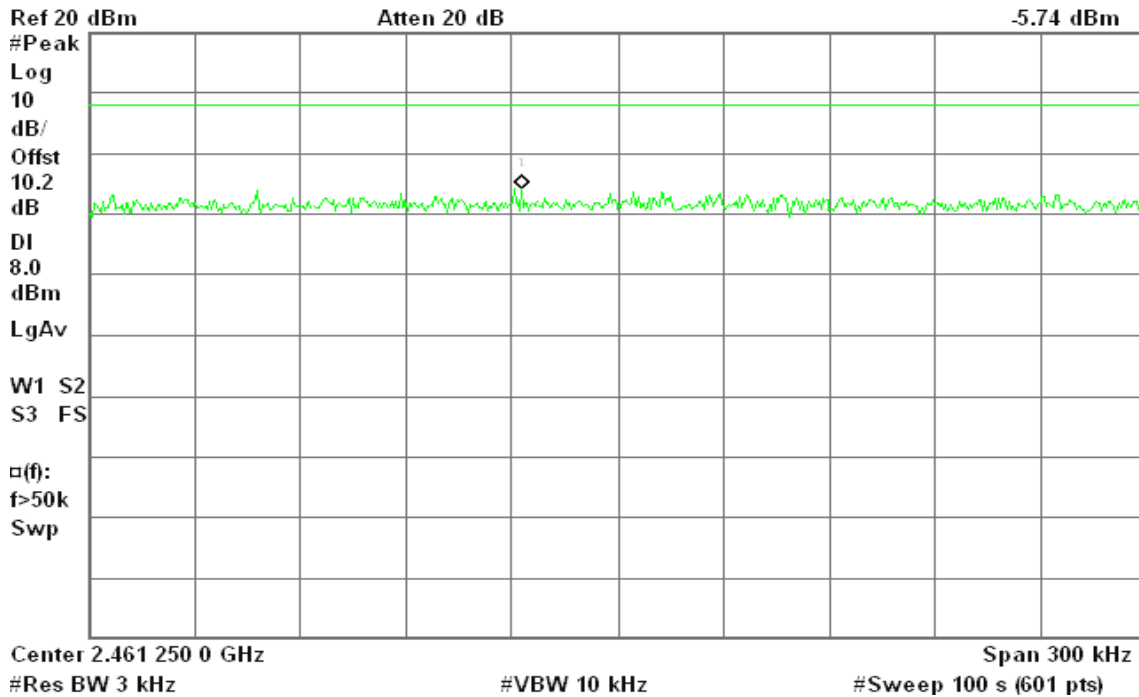

### IEEE 802.11g

### PPSD (CH Low)

Agilent 13:47:15 Nov 29, 2010

R L

Mkr1 2.412 612 8 GHz  
-19.86 dBm

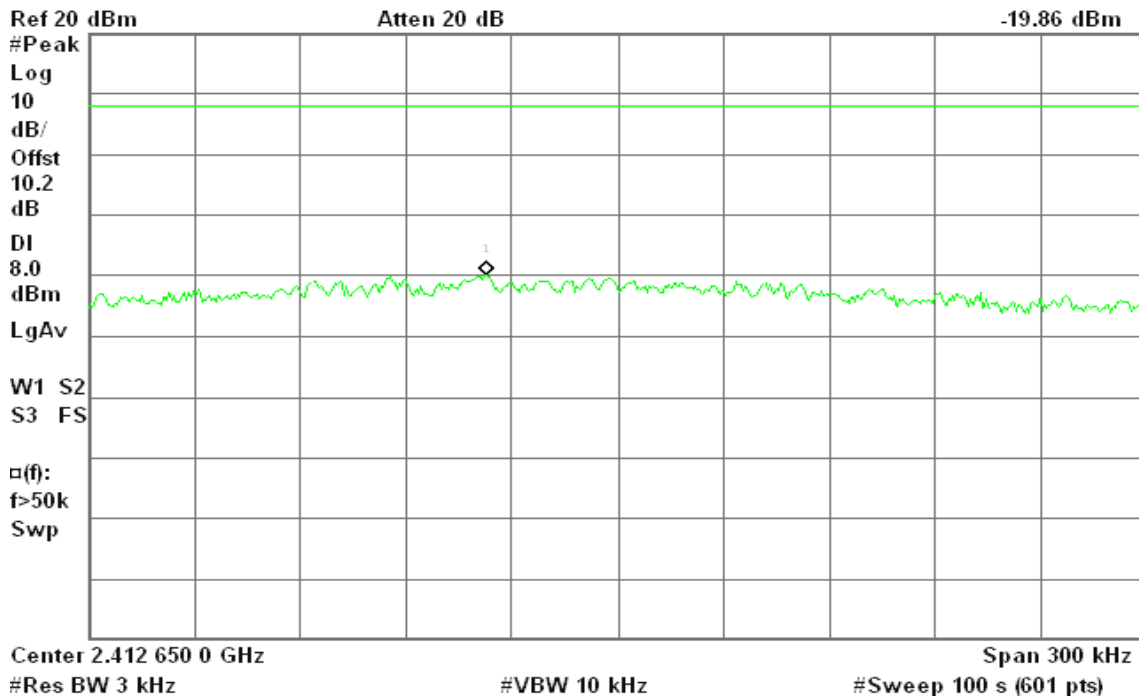



### PPSD (CH Mid)

Agilent 14:00:16 Nov 29, 2010

R T

Mkr1 2.437 319 6 GHz  
-18.17 dBm

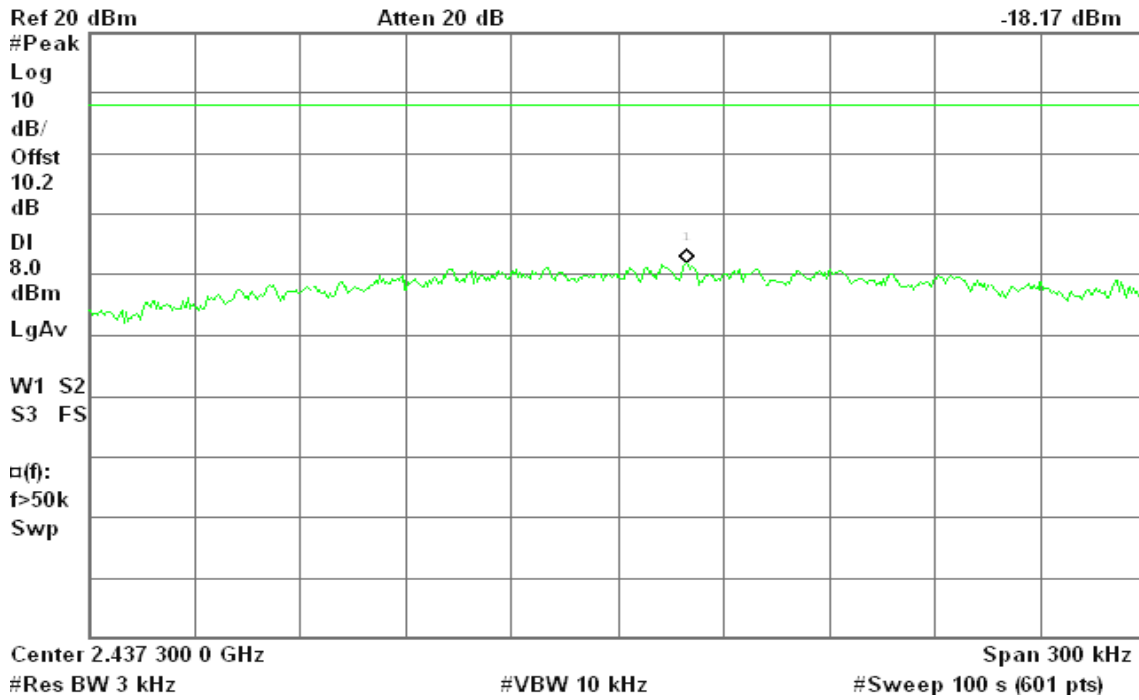

### PPSD (CH High)

Agilent 14:04:24 Nov 29, 2010

R T

Mkr1 2.462 627 9 GHz  
-18.05 dBm

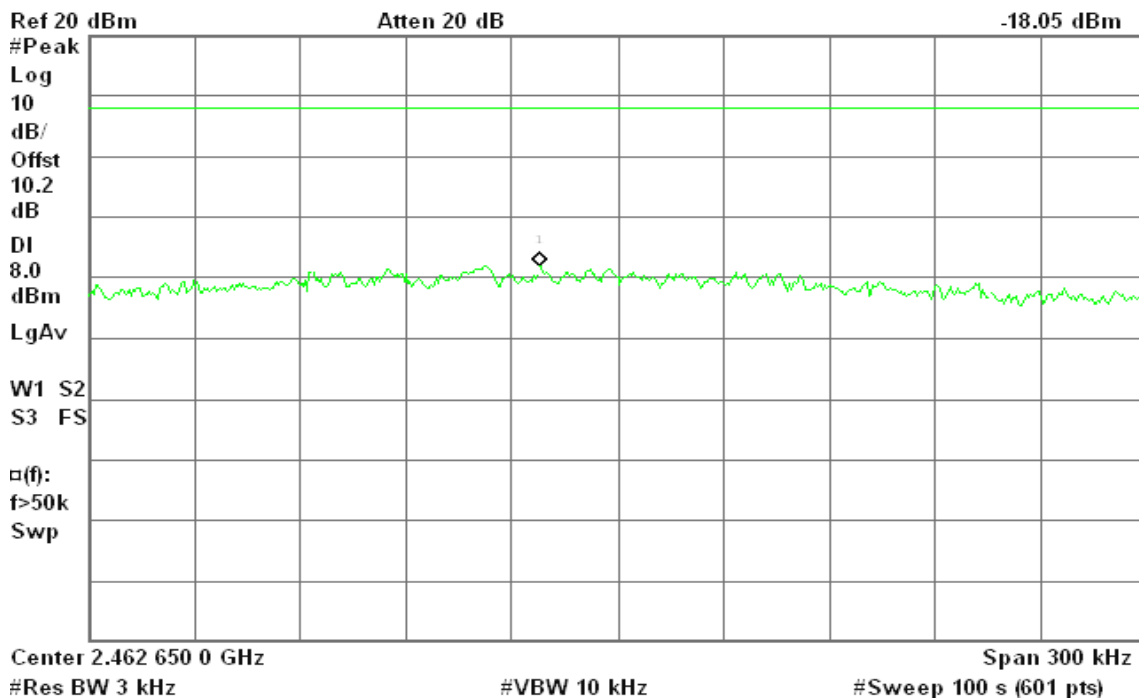



## 7.6 SPURIOUS EMISSIONS

### 7.6.1 Conducted Measurement

#### LIMIT

According to §15.247(d), in any 100 kHz bandwidth outside the frequency bands in which the spread spectrum intentional radiator is operating, the radio frequency power that is produced by the intentional radiator shall be at least 20 dB below that in the 100 kHz bandwidth within the band that contains the highest level of the desired power, based on either an RF conducted or a radiated measurement, provided the transmitter demonstrates compliance with the peak conducted power limits. In addition, radiated emissions which fall in the restricted bands, as defined in §15.205(a), must also comply with the radiated emission limits specified in 15.209(a) (see Section 15.205(c)).

#### Test Configuration

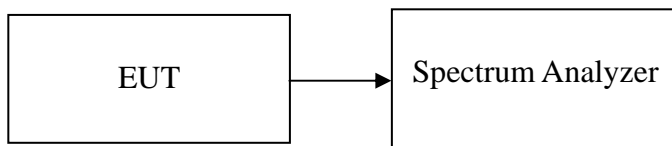

#### TEST PROCEDURE

Conducted RF measurements of the transmitter output were made to confirm that the EUT antenna port conducted emissions meet the specified limit and to identify any spurious signals that require further investigation or measurements on the radiated emissions site.

The transmitter output is connected to the spectrum analyzer. The resolution bandwidth is set to 100 kHz. The video bandwidth is set to 100 kHz.

Measurements are made over the 30MHz to 26GHz range with the transmitter set to the lowest, middle, and highest channels.

#### TEST RESULTS

*No non-compliance noted.*





### CH High

Agilent 13:38:13 Nov 29, 2010

R T

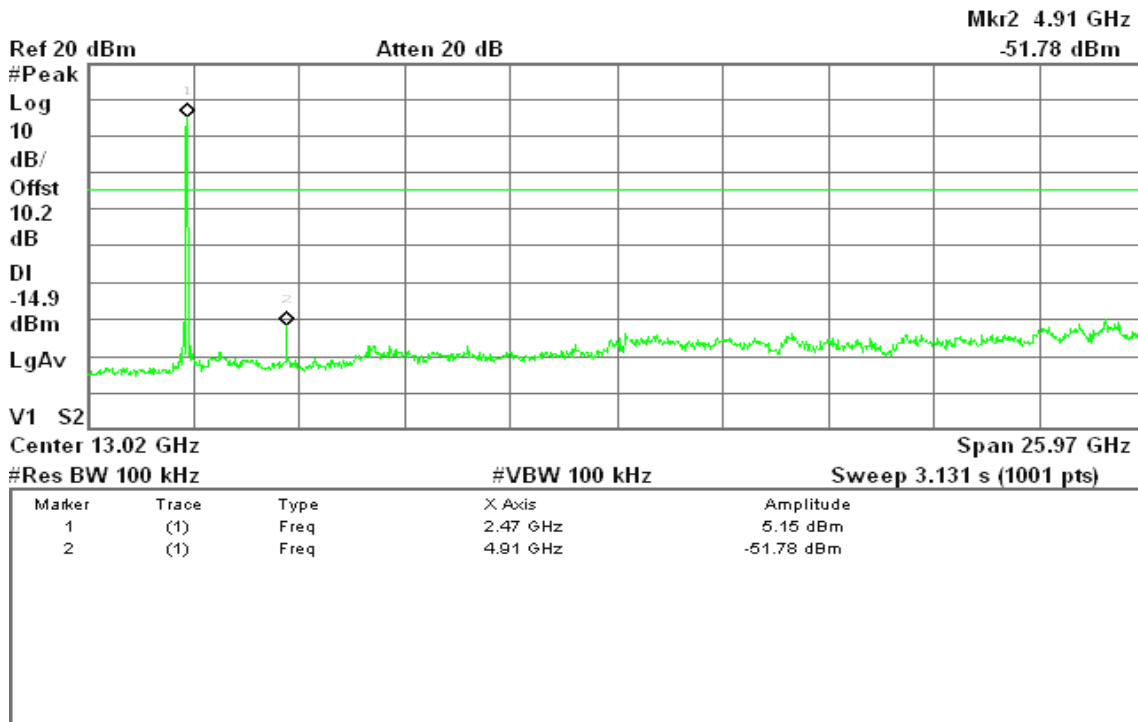

### IEEE 802.11g

#### CH Low

Agilent 13:48:57 Nov 29, 2010

R T

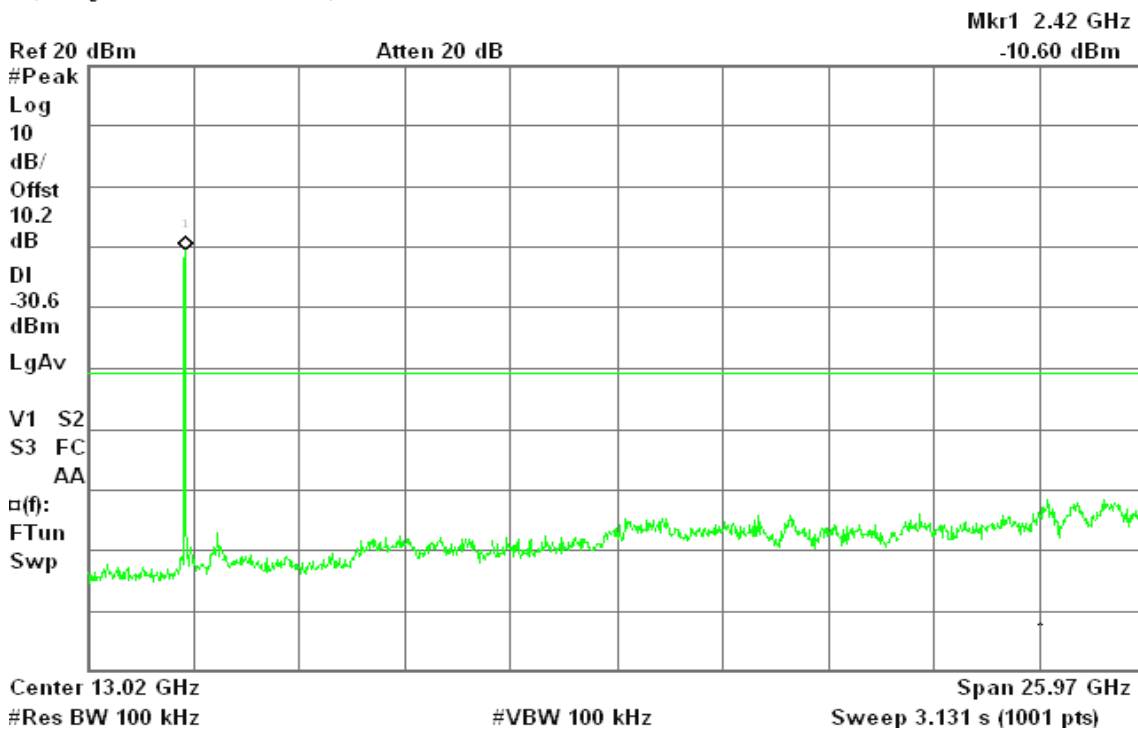



### CH Mid

Agilent 14:01:05 Nov 29, 2010

R L

Mkr1 2.42 GHz  
-6.47 dBm

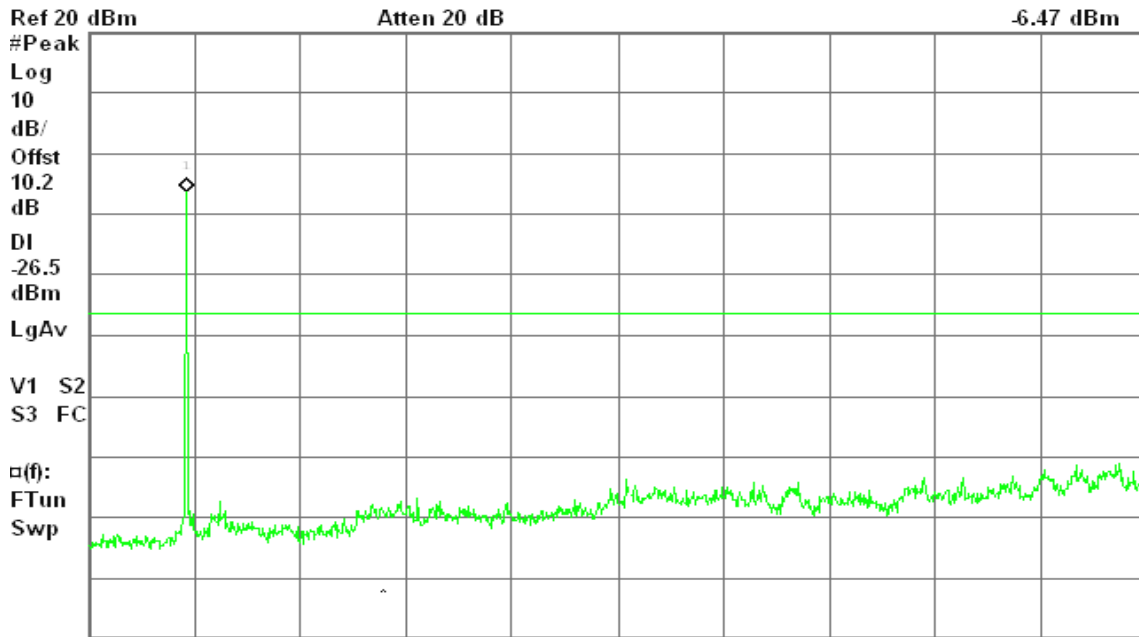

Center 13.02 GHz  
#Res BW 100 kHz

#VBW 100 kHz

Span 25.97 GHz  
Sweep 3.131 s (1001 pts)

### CH High

Agilent 14:05:07 Nov 29, 2010

R T

Mkr1 2.47 GHz  
-8.59 dBm

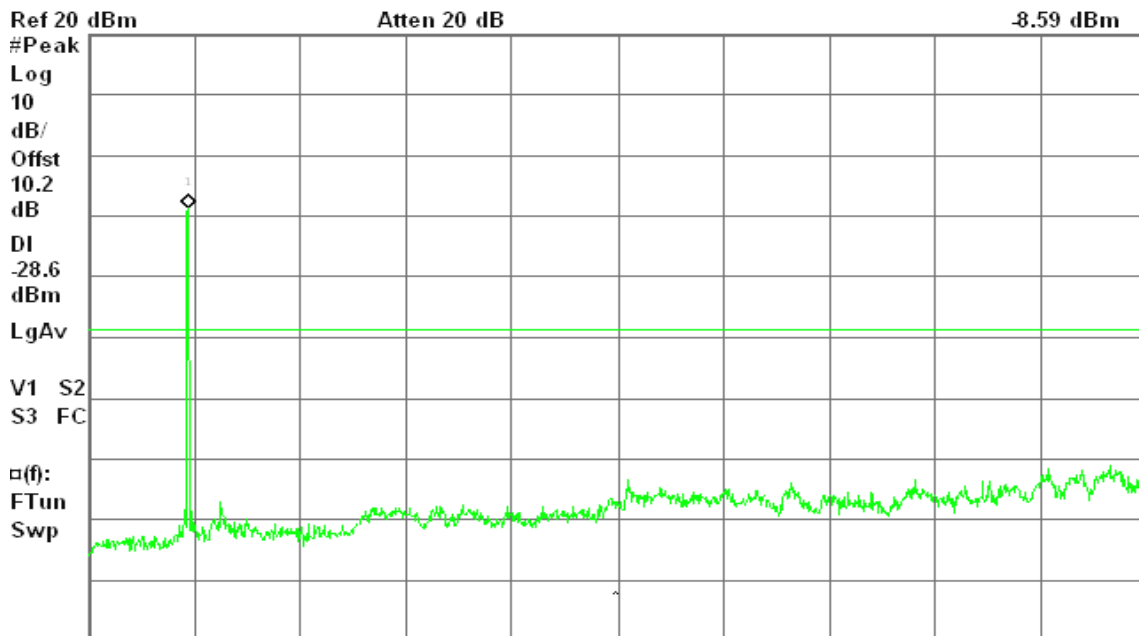

Center 13.02 GHz  
#Res BW 100 kHz

#VBW 100 kHz

Span 25.97 GHz  
Sweep 3.131 s (1001 pts)



## 7.6.2 Radiated Emissions

### LIMIT

1. According to §15.209(a), except as provided elsewhere in this Subpart, the emissions from an intentional radiator shall not exceed the field strength levels specified in the following table:

Frequency (MHz)	Field Strength ( $\mu\text{V/m}$ )	Measurement Distance (m)
30-88	100*	3
88-216	150*	3
216-960	200*	3
Above 960	500	3

**Remark:** Except as provided in paragraph (g), fundamental emissions from intentional radiators operating under this Section shall not be located in the frequency bands 54-72 MHz, 76-88 MHz, 174-216 MHz or 470-806 MHz. However, operation within these frequency bands is permitted under other sections of this Part, e.g., Sections 15.231 and 15.241.

2. In the emission table above, the tighter limit applies at the band edges.

Frequency (MHz)	Field Strength ( $\mu\text{V/m}$ at 3-meter)	Field Strength (dB $\mu\text{V/m}$ at 3-meter)
30-88	100	40
88-216	150	43.5
216-960	200	46
Above 960	500	54



### Test Configuration

#### 9kHz ~ 30MHz

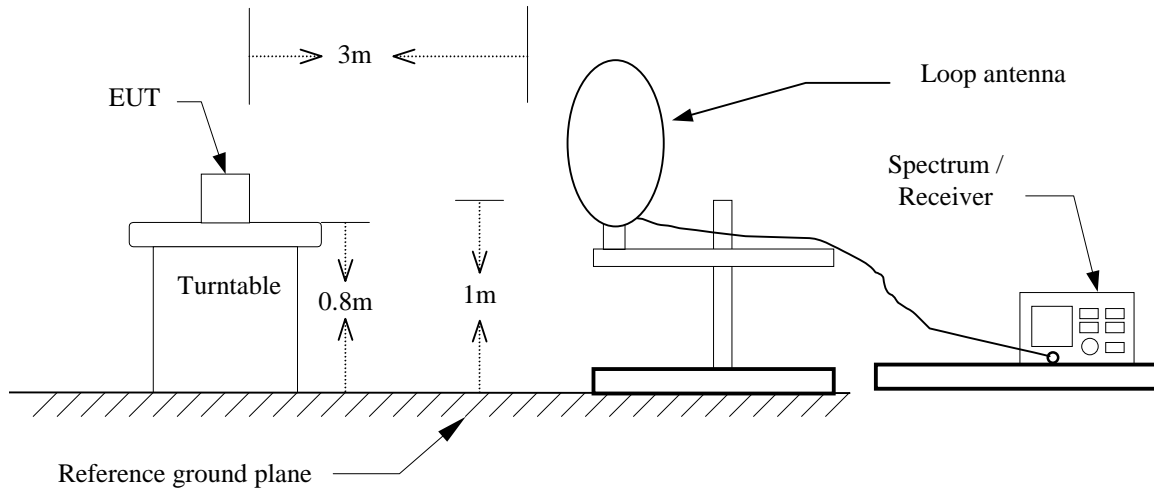

#### 30MHz ~ 1GHz

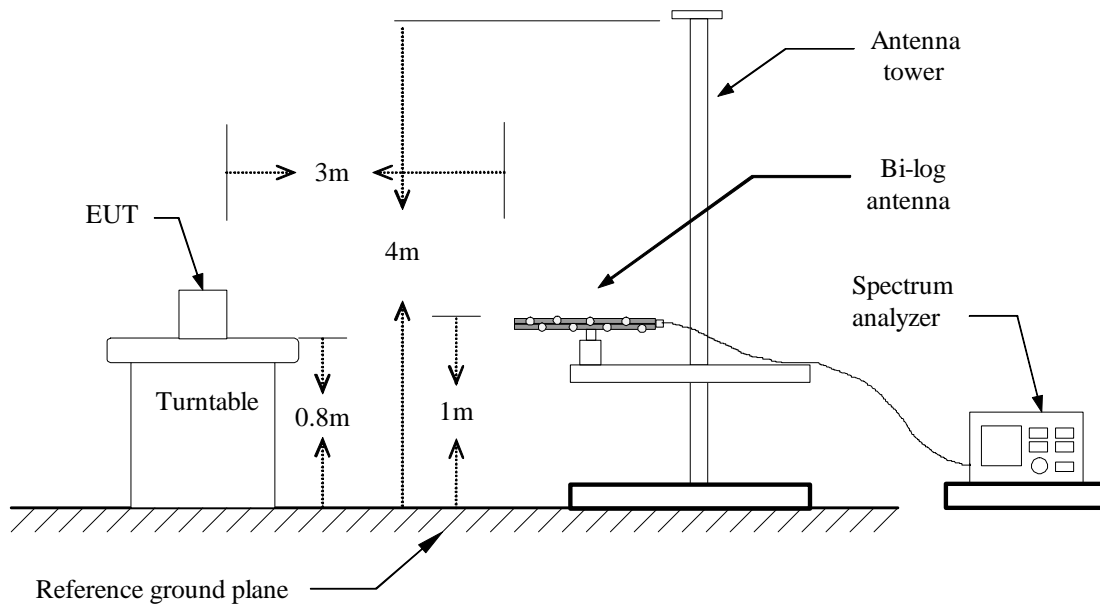





Above 1 GHz

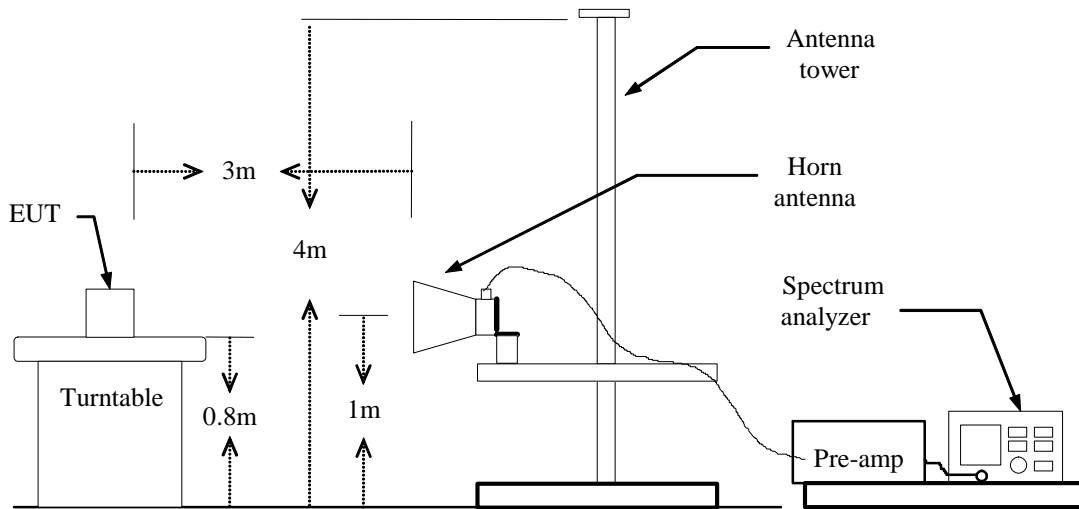



## **TEST PROCEDURE**

1. The EUT is placed on a turntable, which is 0.8m above ground plane.
2. The turntable shall be rotated for 360 degrees to determine the position of maximum emission level.
3. EUT is set 3m away from the receiving antenna, which is varied from 1m to 4m to find out the highest emissions.
4. Maximum procedure was performed on the six highest emissions to ensure EUT compliance.
5. And also, each emission was to be maximized by changing the polarization of receiving antenna both horizontal and vertical.
6. Set the spectrum analyzer in the following setting as:  
Below 1GHz:  
RBW=100kHz / VBW=300kHz / Sweep=AUTO  
Above 1GHz:  
(a) PEAK: RBW=VBW=1MHz / Sweep=AUTO  
(b) AVERAGE: RBW=1MHz / VBW=10Hz / Sweep=AUTO
7. Repeat above procedures until the measurements for all frequencies are complete.



**Below 1 GHz**

**Operation Mode:** Normal Link

**Test Date:** November 30, 2010

**Temperature:** 23°C

**Tested by:** Wolf Huang

**Humidity:** 48 % RH

**Polarity:** Ver. / Hor.

Frequency (MHz)	Reading (dBuV)	Correction Factor (dB/m)	Result (dBuV/m)	Limit (dBuV/m)	Margin (dB)	Remark	Ant.Pol. (H/V)
59.10	47.20	-15.90	31.30	40.00	-8.70	Peak	V
215.92	45.30	-11.15	34.15	43.50	-9.35	Peak	V
233.70	45.60	-11.21	34.39	46.00	-11.61	Peak	V
390.52	42.69	-7.27	35.42	46.00	-10.58	Peak	V
647.57	31.84	-2.95	28.89	46.00	-17.11	Peak	V
728.40	32.45	-2.13	30.32	46.00	-15.68	Peak	V
59.10	49.96	-15.90	34.06	40.00	-5.94	Peak	H
131.85	43.21	-9.76	33.45	43.50	-10.05	Peak	H
206.22	39.20	-10.40	28.80	43.50	-14.70	Peak	H
235.32	46.54	-11.18	35.36	46.00	-10.64	Peak	H
385.67	37.41	-7.37	30.04	46.00	-15.96	Peak	H
712.23	27.64	-2.36	25.28	46.00	-20.72	Peak	H

**Remark:**

1. No emission found between lowest internal used/generated frequency to 30MHz (9kHz~30MHz)
2. Radiated emissions measured in frequency range from 30 MHz to 1000MHz were made with an instrument using peak/quasi-peak detector mode.
3. Quasi-peak test would be performed if the peak result were greater than the quasi-peak limit or as required by the applicant.
4. Measurements above show only up to 6 maximum emissions noted, or would be lesser, with " N/A " remark, if no specific emissions from the EUT are recorded (ie: margin>20dB from the applicable limit) and considered that's already beyond the background noise floor.
5. Margin (dB) = Remark result (dBuV/m) – Quasi-peak limit (dBuV/m).



**Above 1 GHz**

**Operation Mode:** IEEE 802.11b / TX / CH Low

**Test Date:** November 30, 2010

**Temperature:** 23°C

**Tested by:** Wolf Huang

**Humidity:** 51 % RH

**Polarity:** Ver. / Hor.

Frequency (MHz)	Reading (Peak) (dBuV)	Reading (Average) (dBuV)	Correction Factor (dB/m)	Result (Peak) (dBuV/m)	Result (Average) (dBuV/m)	Limit (Peak) (dBuV/m)	Limit (Average) (dBuV/m)	Margin (dB)	Remark	Ant.Pol. (H/V)
1780.00	57.76	---	-6.18	51.58	---	74.00	54.00	-2.42	Peak	V
N/A										
1776.67	57.61	---	-6.21	51.40	---	74.00	54.00	-2.60	Peak	H
N/A										

**Remark:**

1. Measuring frequencies from 1 GHz to the 10th harmonic of highest fundamental frequency.
2. Radiated emissions measured in frequency above 1000MHz were made with an instrument using peak/average detector mode.
3. Average test would be performed if the peak result were greater than the average limit or as required by the applicant.
4. Data of measurement within this frequency range shown " --- " in the table above means the reading of emissions are attenuated more than 20dB below the permissible limits or the field strength is too small to be measured.
5. Measurements above show only up to 6 maximum emissions noted, or would be lesser, with " N/A " remark, if no specific emissions from the EUT are recorded (ie: margin>20dB from the applicable limit) and considered that's already beyond the background noise floor.
6. Margin (dB) = Remark result (dBuV/m) – Average limit (dBuV/m).



Operation Mode: IEEE 802.11b / TX / CH Mid

Test Date: November 30, 2010

Temperature: 23°C

Tested by: Wolf Huang

Humidity: 51 % RH

Polarity: Ver. / Hor.

Frequency (MHz)	Reading (Peak) (dBuV)	Reading (Average) (dBuV)	Correction Factor (dB/m)	Result (Peak) (dBuV/m)	Result (Average) (dBuV/m)	Limit (Peak) (dBuV/m)	Limit (Average) (dBuV/m)	Margin (dB)	Remark	Ant.Pol. (H/V)
1880.00	57.19	---	-5.26	51.94	---	74.00	54.00	-2.06	Peak	V
N/A										
1863.33	57.23	---	-5.41	51.82	---	74.00	54.00	-2.18	Peak	H
N/A										

**Remark:**

1. Measuring frequencies from 1 GHz to the 10th harmonic of highest fundamental frequency.
2. Radiated emissions measured in frequency above 1000MHz were made with an instrument using peak/average detector mode.
3. Average test would be performed if the peak result were greater than the average limit or as required by the applicant.
4. Data of measurement within this frequency range shown “ --- ” in the table above means the reading of emissions are attenuated more than 20dB below the permissible limits or the field strength is too small to be measured.
5. Measurements above show only up to 6 maximum emissions noted, or would be lesser, with “ N/A ” remark, if no specific emissions from the EUT are recorded (ie: margin>20dB from the applicable limit) and considered that's already beyond the background noise floor.
6. Margin (dB) = Remark result (dBuV/m) – Average limit (dBuV/m).



Operation Mode: IEEE 802.11b / TX / CH High

Test Date: November 30, 2010

Temperature: 23°C

Tested by: Wolf Huang

Humidity: 51 % RH

Polarity: Ver. / Hor.

Frequency (MHz)	Reading (Peak) (dBuV)	Reading (Average) (dBuV)	Correction Factor (dB/m)	Result (Peak) (dBuV/m)	Result (Average) (dBuV/m)	Limit (Peak) (dBuV/m)	Limit (Average) (dBuV/m)	Margin (dB)	Remark	Ant.Pol. (H/V)
1823.33	56.90	---	-5.78	51.12	---	74.00	54.00	-2.88	Peak	V
N/A										
1716.67	58.30	---	-6.76	51.54	---	74.00	54.00	-2.46	Peak	H
N/A										

**Remark:**

1. Measuring frequencies from 1 GHz to the 10th harmonic of highest fundamental frequency.
2. Radiated emissions measured in frequency above 1000MHz were made with an instrument using peak/average detector mode.
3. Average test would be performed if the peak result were greater than the average limit or as required by the applicant.
4. Data of measurement within this frequency range shown “ --- ” in the table above means the reading of emissions are attenuated more than 20dB below the permissible limits or the field strength is too small to be measured.
5. Measurements above show only up to 6 maximum emissions noted, or would be lesser, with “ N/A ” remark, if no specific emissions from the EUT are recorded (ie: margin>20dB from the applicable limit) and considered that's already beyond the background noise floor.
6. Margin (dB) = Remark result (dBuV/m) – Average limit (dBuV/m).



Operation Mode: IEEE 802.11g / TX / CH Low

Test Date: November 30, 2010

Temperature: 23°C

Tested by: Wolf Huang

Humidity: 51 % RH

Polarity: Ver. / Hor.

Frequency (MHz)	Reading (Peak) (dBuV)	Reading (Average) (dBuV)	Correction Factor (dB/m)	Result (Peak) (dBuV/m)	Result (Average) (dBuV/m)	Limit (Peak) (dBuV/m)	Limit (Average) (dBuV/m)	Margin (dB)	Remark	Ant.Pol. (H/V)
1836.67	56.95	---	-5.66	51.29	---	74.00	54.00	-2.71	Peak	V
N/A										
1776.67	57.78	---	-6.21	51.57	---	74.00	54.00	-2.43	Peak	H
N/A										

**Remark:**

1. Measuring frequencies from 1 GHz to the 10th harmonic of highest fundamental frequency.
2. Radiated emissions measured in frequency above 1000MHz were made with an instrument using peak/average detector mode.
3. Average test would be performed if the peak result were greater than the average limit or as required by the applicant.
4. Data of measurement within this frequency range shown “ --- ” in the table above means the reading of emissions are attenuated more than 20dB below the permissible limits or the field strength is too small to be measured.
5. Measurements above show only up to 6 maximum emissions noted, or would be lesser, with “ N/A ” remark, if no specific emissions from the EUT are recorded (ie: margin > 20dB from the applicable limit) and considered that's already beyond the background noise floor.
6. Margin (dB) = Remark result (dBuV/m) – Average limit (dBuV/m).



Operation Mode: IEEE 802.11g / TX / CH Mid

Test Date: November 30, 2010

Temperature: 23°C

Tested by: Wolf Huang

Humidity: 51 % RH

Polarity: Ver. / Hor.

Frequency (MHz)	Reading (Peak) (dBuV)	Reading (Average) (dBuV)	Correction Factor (dB/m)	Result (Peak) (dBuV/m)	Result (Average) (dBuV/m)	Limit (Peak) (dBuV/m)	Limit (Average) (dBuV/m)	Margin (dB)	Remark	Ant.Pol. (H/V)
1836.67	56.54	---	-5.66	50.89	---	74.00	54.00	-3.11	Peak	V
N/A										
1853.33	57.38	---	-5.50	51.88	---	74.00	54.00	-2.12	Peak	H
N/A										

**Remark:**

1. Measuring frequencies from 1 GHz to the 10th harmonic of highest fundamental frequency.
2. Radiated emissions measured in frequency above 1000MHz were made with an instrument using peak/average detector mode.
3. Average test would be performed if the peak result were greater than the average limit or as required by the applicant.
4. Data of measurement within this frequency range shown “ --- ” in the table above means the reading of emissions are attenuated more than 20dB below the permissible limits or the field strength is too small to be measured.
5. Measurements above show only up to 6 maximum emissions noted, or would be lesser, with “ N/A ” remark, if no specific emissions from the EUT are recorded (ie: margin>20dB from the applicable limit) and considered that's already beyond the background noise floor.
6. Margin (dB) = Remark result (dBuV/m) – Average limit (dBuV/m).





Operation Mode: IEEE 802.11g / TX / CH High

Test Date: November 30, 2010

Temperature: 23 °C

Tested by: Wolf Huang

Humidity: 51 % RH

Polarity: Ver. / Hor.

Frequency (MHz)	Reading (Peak) (dBuV)	Reading (Average) (dBuV)	Correction Factor (dB/m)	Result (Peak) (dBuV/m)	Result (Average) (dBuV/m)	Limit (Peak) (dBuV/m)	Limit (Average) (dBuV/m)	Margin (dB)	Remark	Ant.Pol. (H/V)
1826.67	57.60	---	-5.75	51.85	---	74.00	54.00	-2.15	Peak	V
N/A										
1796.67	57.23	---	-6.02	51.21	---	74.00	54.00	-2.79	Peak	H
N/A										

Remark:

1. Measuring frequencies from 1 GHz to the 10th harmonic of highest fundamental frequency.
2. Radiated emissions measured in frequency above 1000MHz were made with an instrument using peak/average detector mode.
3. Average test would be performed if the peak result were greater than the average limit or as required by the applicant.
4. Data of measurement within this frequency range shown “ --- ” in the table above means the reading of emissions are attenuated more than 20dB below the permissible limits or the field strength is too small to be measured.
5. Measurements above show only up to 6 maximum emissions noted, or would be lesser, with “ N/A ” remark, if no specific emissions from the EUT are recorded (ie: margin>20dB from the applicable limit) and considered that's already beyond the background noise floor.
6. Margin (dB) = Remark result (dBuV/m) – Average limit (dBuV/m).



## 7.7 POWERLINE CONDUCTED EMISSIONS

### LIMIT

According to §15.207(a), except as shown in paragraphs (b) and (c) of this section, for an intentional radiator that is designed to be connected to the public utility (AC) power line, the radio frequency voltage that is conducted back onto the AC power line on any frequency or frequencies within the band 150 kHz to 30 MHz shall not exceed the limits in the following table, as measured using a 50  $\mu$ H/50 ohms line impedance stabilization network (LISN). Compliance with the provisions of this paragraph shall be based on the measurement of the radio frequency voltage between each power line and ground at the power terminal. The lower limit applies at the boundary between the frequency ranges.

Frequency Range (MHz)	Limits (dB $\mu$ V)	
	Quasi-peak	Average
0.15 to 0.50	66 to 56*	56 to 46*
0.50 to 5	56	46
5 to 30	60	50

### Test Configuration

See test photographs attached in Appendix II for the actual connections between EUT and support equipment.

### TEST PROCEDURE

1. The EUT was placed on a table, which is 0.8m above ground plane.
2. Maximum procedure was performed on the six highest emissions to ensure EUT compliance.
3. Repeat above procedures until all frequency measured were complete.



### TEST RESULTS

The initial step in collecting conducted data is a spectrum analyzer peak scan of the measurement range. Significant peaks are then marked as shown on the following data page, and these signals are then quasi-peaked.

#### Test Data

**Operation Mode:** Normal Link                      **Test Date:** December 2, 2010  
**Temperature:** 26°C                                      **Tested by:** Shawn Wu  
**Humidity:** 60% RH

Frequency (MHz)	QP Reading (dBuV)	AV Reading (dBuV)	Corr. factor (dB)	QP Result (dBuV)	AV Result (dBuV)	QP Limit (dBuV)	AV Limit (dBuV)	QP Margin (dB)	AV Margin (dB)	Note
0.2400	36.97	32.87	0.13	37.10	33.00	62.10	52.10	-25.00	-19.10	L1
0.3600	31.76	27.96	0.14	31.90	28.10	58.73	48.73	-26.83	-20.63	L1
0.4800	29.76	25.86	0.14	29.90	26.00	56.34	46.34	-26.44	-20.34	L1
4.0500	23.01	16.71	0.09	23.10	16.80	56.00	46.00	-32.90	-29.20	L1
10.5000	35.10	25.00	0.30	35.40	25.30	60.00	50.00	-24.60	-24.70	L1
20.1600	38.07	16.97	0.43	38.50	17.40	60.00	50.00	-21.50	-32.60	L1
0.2400	32.38	28.58	0.12	32.50	28.70	62.10	52.10	-29.60	-23.40	L2
0.3600	34.97	32.07	0.13	35.10	32.20	58.73	48.73	-23.63	-16.53	L2
0.6000	27.17	21.47	0.13	27.30	21.60	56.00	46.00	-28.70	-24.40	L2
3.2100	23.84	16.24	0.06	23.90	16.30	56.00	46.00	-32.10	-29.70	L2
10.5000	39.62	29.32	0.28	39.90	29.60	60.00	50.00	-20.10	-20.40	L2
19.2300	43.23	24.23	0.37	43.60	24.60	60.00	50.00	-16.40	-25.40	L2

#### **Remark:**

1. *Measuring frequencies from 0.15 MHz to 30MHz.*
2. *The emissions measured in frequency range from 0.15 MHz to 30MHz were made with an instrument using Quasi-peak detector and average detector.*
3. *The IF bandwidth of SPA between 0.15MHz to 30MHz was 10kHz; the IF bandwidth of Test Receiver between 0.15MHz to 30MHz was 9kHz;*
4. *L1 = Line One (Live Line) / L2 = Line Two (Neutral Line)*
5. *"-" means Quasi-peak reading value also meets average limit and measurement with the average detector is unnecessary.*



**Test Plots**

**Conducted emissions (Line 1)**

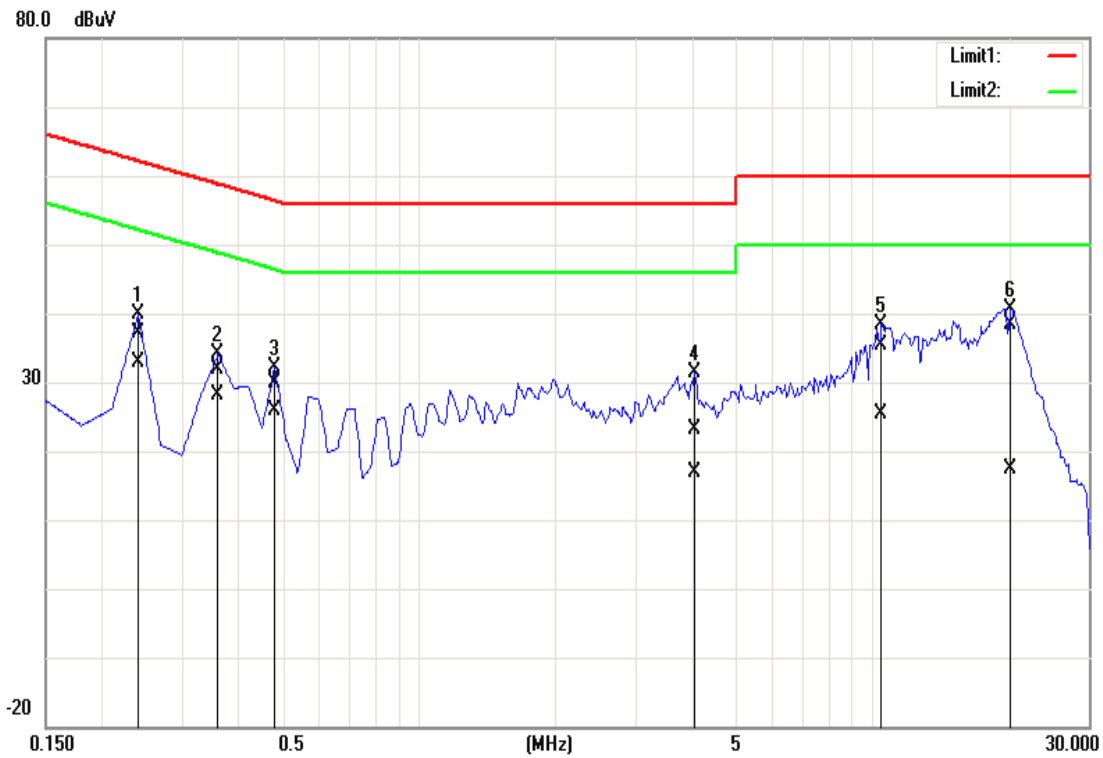

**Conducted emissions (Line 2)**

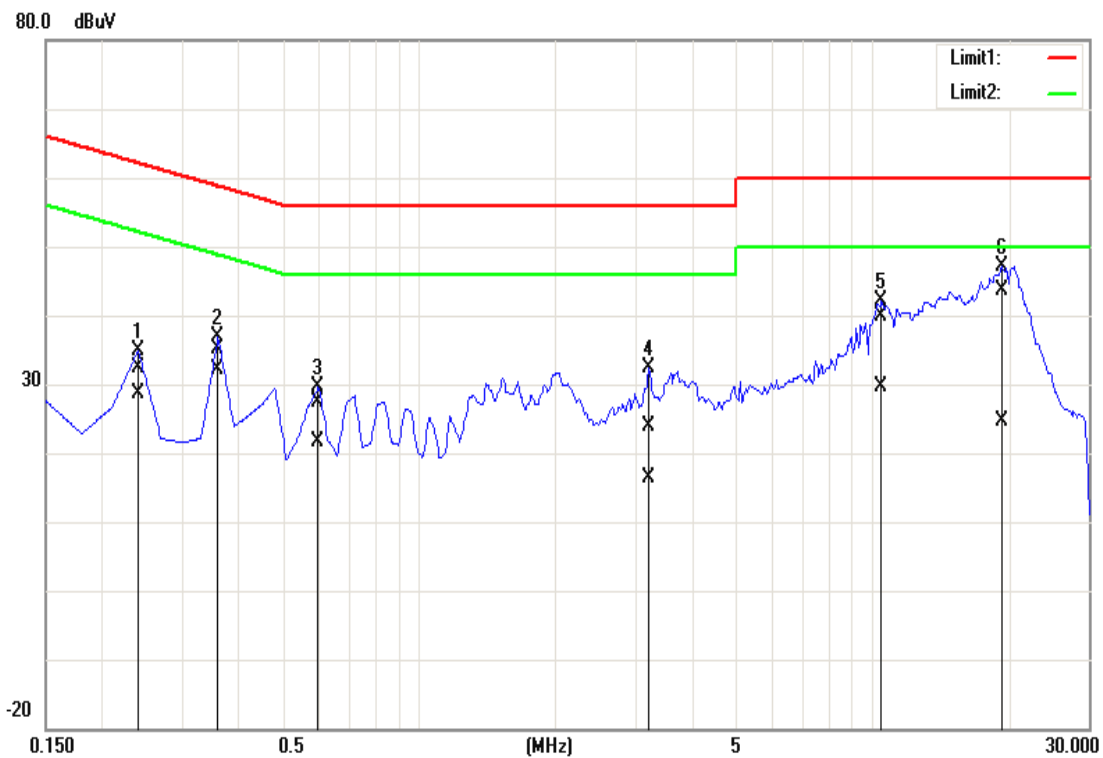



# APPENDIX I RADIO FREQUENCY EXPOSURE

## LIMIT

Systems operating under the provisions of this section shall be operated in a manner that ensures that the public is not exposed to radio frequency energy levels in excess of the Commission's guidelines. See §15.247(i) and §1.1307(b)(1) of this chapter.

## EUT Specification

<b>EUT</b>	Smart Handheld
<b>Frequency band (Operating)</b>	<input checked="" type="checkbox"/> WLAN: 2.412GHz ~ 2.462GHz <input type="checkbox"/> WLAN: 5.18GHz ~ 5.32GHz / 5.50GHz ~ 5.70GHz <input type="checkbox"/> WLAN: 5.745GHz ~ 5.825GHz <input type="checkbox"/> Bluetooth: <u>2.402GHz ~ 2.480 GHz</u>
<b>Device category</b>	<input checked="" type="checkbox"/> Portable (<20cm separation) <input type="checkbox"/> Mobile (>20cm separation)
<b>Exposure classification</b>	<input type="checkbox"/> Occupational/Controlled exposure (S = 5mW/cm2) <input checked="" type="checkbox"/> General Population/Uncontrolled exposure (S=1mW/cm2)
<b>Antenna diversity</b>	<input checked="" type="checkbox"/> Single antenna <input type="checkbox"/> Multiple antennas <input type="checkbox"/> Tx diversity <input type="checkbox"/> Rx diversity <input type="checkbox"/> Tx/Rx diversity
<b>Max. output power</b>	IEEE 802.11b: 18.31 dBm (67.76mW) IEEE 802.11g: 23.16 dBm (207.01mW)
<b>Antenna gain (Max)</b>	-0.7 dBi (Numeric gain: 0.85)
<b>Evaluation applied</b>	<input type="checkbox"/> MPE Evaluation <input checked="" type="checkbox"/> SAR Evaluation* <input type="checkbox"/> N/A
<b>Remark:</b> <i>The maximum output power is <u>23.16dBm (207.01mW)</u> at <u>2437MHz</u> (with <u>0.85numeric antenna gain.</u>)</i>	

## TEST RESULTS

No non-compliance noted.  
Please refer to the separated SAR report.

## MPE EVALUATION

Not applicable.