



FCC RF Test Report

APPLICANT : Acer Incorporated
EQUIPMENT : Smart HandHeld
BRAND NAME : Acer
MODEL NAME : E101
FCC ID : HLZDME101
STANDARD : FCC 47 CFR Part 2, 22(H), 24(E)
CLASSIFICATION : PCS Licensed Transmitter Held to Ear (PCE)
Tx/Rx FREQUENCY RANGE : GSM850 : 824.2 ~ 848.8 MHz /
869.2 ~ 893.8 MHz
GSM1900 : 1850.2 ~ 1909.8 MHz /
1930.2 ~ 1989.8 MHz
MAX. ERP/EIRP POWER : GSM850 (GSM) : 1.17 W
GSM850 (EDGE 8) : 0.36 W
GSM1900 (GSM) : 1.01 W
GSM1900 (EDGE 10) : 0.50 W
EMISSION DESIGNATOR : GMSK : 246KGXW
8PSK : 244KG7W

The product was received on Aug. 13, 2009 and completely tested on Oct. 01, 2009. We, SPORTON INTERNATIONAL INC., would like to declare that the tested sample has been evaluated in accordance with the procedures given in ANSI / TIA / EIA-603-C-2004 and shown compliance with the applicable technical standards.

The test results in this report apply exclusively to the tested model / sample. Without written approval of SPORTON INTERNATIONAL INC., the test report shall not be reproduced except in full.

Reviewed by:

Roy Wu / Manager



SPORTON INTERNATIONAL INC.

No. 52, Hwa Ya 1st Rd., Hwa Ya Technology Park, Kwei-Shan Hsiang, Tao Yuan Hsien, Taiwan, R.O.C.



TABLE OF CONTENTS

REVISION HISTORY.....3

SUMMARY OF TEST RESULT4

1 GENERAL DESCRIPTION.....5

 1.1 Applicant.....5

 1.2 Manufacturer5

 1.3 Feature of Equipment Under Test.....5

 1.4 Testing Site7

 1.5 Applied Standards7

 1.6 Ancillary Equipment List.....7

2 TEST CONFIGURATION OF EQUIPMENT UNDER TEST.....8

 2.1 Test Mode.....8

 2.2 Connection Diagram of Test System9

3 TEST RESULT.....10

 3.1 Conducted Output Power Measurement.....10

 3.2 Effective Radiated Power and Effective Isotropic Radiated Power Measurement12

 3.3 Occupied Bandwidth Measurement16

 3.4 Band Edge Measurement.....21

 3.5 Conducted Emission Measurement26

 3.6 Field Strength of Spurious Radiation Measurement37

 3.7 Frequency Stability Measurement.....49

4 LIST OF MEASURING EQUIPMENT52

5 UNCERTAINTY OF EVALUATION.....53

6 CERTIFICATION OF TAF ACCREDITATION54

APPENDIX A. PHOTOGRAPHS OF EUT

APPENDIX B. SETUP PHOTOGRAPHS



REVISION HISTORY

REPORT NO.	VERSION	DESCRIPTION	ISSUED DATE
FG972007-01	Rev. 01	Initial issue of report	Oct. 07, 2009



SUMMARY OF TEST RESULT

Report Section	FCC Rule	IC Rule	Description	Limit	Result	Remark
3.1	§2.1046	N/A	Conducted Output Power	N/A	PASS	
3.2	§22.913(a)(2)	RSS-132(4.4) SRSP-503(5.1.3)	Effective Radiated Power	< 7 Watts for FCC (<6.3 Watts for IC)	PASS	-
3.2	§24.232(c)	RSS-133 (6.4) SRSP-510(5.1.2)	Equivalent Isotropic Radiated Power	< 2 Watts	PASS	-
3.3	§2.1049 §22.917(a) §24.238(a)	N/A	Occupied Bandwidth	N/A	PASS	-
3.4	§2.1051 §22.917(a) §24.238(a)	RSS-132 (4.5.1) RSS-133 (6.5.1)	Band Edge Measurement	< 43+10log ₁₀ (P[Watts])	PASS	-
3.5	§2.1051 §22.917(a) §24.238(a)	RSS-132 (4.5.1) RSS-133 (6.5.1)	Conducted Emission	< 43+10log ₁₀ (P[Watts])	PASS	-
3.6	§2.1053 §22.917(a) §24.238(a)	RSS-132 (4.5.1) RSS-133 (6.5.1)	Field Strength of Spurious Radiation	< 43+10log ₁₀ (P[Watts])	PASS	Under limit -18.80 dB at 9396 MHz
3.7	§2.1055 §22.355 §24.235	RSS-132(4.3) RSS-133(6.3)	Frequency Stability for Temperature & Voltage	< 2.5 ppm	PASS	-



1 General Description

1.1 Applicant

Acer Incorporated

8F., No. 88, Sec. 1, Hsin Tai Wu Rd., Hsichih, Taipei Hsien 221, Taiwan

1.2 Manufacturer

Inventec Appliances (Pudong) Corporation

No. 789, Puxing Rd., Minhang District, Shanghai, P.R.C.

1.3 Feature of Equipment Under Test

Product Feature & Specification	
Equipment	Smart HandHeld
Brand Name	Acer
Model Name	E101
FCC ID	HLZDME101
Tx Frequency	GSM850 : 824 MHz ~ 849 MHz GSM1900 : 1850 MHz ~ 1910 MHz
Rx Frequency	GSM850 : 869 MHz ~ 894 MHz GSM1900 : 1930 MHz ~ 1990 MHz
Maximum Output Power to Antenna	GSM850 : 32.55 dBm GSM1900 : 29.78 dBm
Maximum ERP/EIRP	GSM850 (GSM) : 1.17 W (30.70 dBm) GSM850 (EDGE 8) : 0.36 W (25.54 dBm) GSM1900 (GSM) : 1.01 W (30.03 dBm) GSM1900 (EDGE 10) : 0.50 W (27.00 dBm)
Antenna Type	Fixed Internal Antenna with gain -7.18 dBi for GSM850 Fixed Internal Antenna with gain -6.19 dBi for GSM1900
HW Version	D20
SW Version	Acer_E101_0.017.01_EN
Type of Modulation	GSM / GPRS : GMSK EDGE : 8PSK
Type of Emission	GMSK : 246KGXW 8PSK : 244KG7W
EUT Stage	Identical Prototype

Remark:

1. For other wireless features of this EUT, the test report will be issued separately.
2. This test report recorded only product characteristics and test results of PCS Licensed Transmitter Held to Ear (PCE).

List of Accessory:

Specification of Accessory		
AC Adapter	Brand Name	PHIHONG
	Model Name	PSAC05R-050
	Power Rating	I/P:100-240Vac, 50-60Hz, 0.3A; O/P: 5Vdc, 1A
	DC Power Cord Type	1.5 meter non-shielded cable without ferrite core
Battery	Brand Name	Acer
	Model Name	A7BTA040H
	Part Number	BT.00107.004
	Power Rating	3.7Vdc, 1140mAh, 4.218Wh
	Type	Li-ion
Earphone	Brand Name	Merry
	Model Name	EMC292-002-02
	Signal Line Type	1.4 meter non-shielded cable without ferrite core
USB Cable	Brand Name	PHIHONG
	Model Name	DCM1000(AI-H)
	Signal Line Type	1.0 meter shielded cable without ferrite core
LCD Panel	Brand Name	CHIMEI
	Model Name	LT320AC9009

Remark:

1. The above EUT's information was declared by manufacturer. Please refer to the specifications or user's manual for more detailed description.
2. For accessories equipped with this EUT, please refer to the appendix of the external photo.

1.4 Testing Site

Test Site	SPORTON INTERNATIONAL INC.		
Test Site Location	No. 52, Hwa Ya 1 st Rd., Hwa Ya Technology Park, Kwei-Shan Hsiang, Tao Yuan Hsien, Taiwan, R.O.C. TEL: +886-3-327-3456 FAX: +886-3-328-4978		
Test Site No.	Sporton Site No.		FCC/IC Registration No.
	TH02-HY	03CH07-HY	TW1022/4086B-1

1.5 Applied Standards

According to the specifications of the manufacturer, the EUT must comply with the requirements of the following standards:

- ♦ FCC 47 CFR Part 2, 22(H), 24(E)
- ♦ ANSI / TIA / EIA-603-C-2004
- ♦ IC RSS-132 Issue 2
- ♦ IC RSS-133 Issue 5

Remark:

1. All test items were verified and recorded according to the standards and without any deviation during the test.
2. This EUT has also been tested and complied with the requirements of FCC Part 15, Subpart B (DoC), recorded in a separate test report.

1.6 Ancillary Equipment List

Item	Equipment	Trade Name	Model No.	FCC ID	Data Cable	Power Cord
1.	System Simulator	R&S	CMU200	N/A	N/A	Unshielded, 1.8 m
2.	Bluetooth Base Station	Anritsu	8852B	N/A	N/A	Unshielded, 1.8 m

2 Test Configuration of Equipment Under Test

2.1 Test Mode

During all testing, EUT is in link mode with base station emulator at maximum power level. The spurious emission measurements were carried out in semi-anechoic chamber with 3-meter test range, and EUT is rotated on three test planes to find out the worst emission.

Frequency range investigated for radiated emission is as follows:

1. 30 MHz to 9000 MHz for GSM850
2. 30 MHz to 19000 MHz for GSM1900

Test Modes		
Band	Radiated TCs	Conducted TCs
GSM 850	<ul style="list-style-type: none"> ■ GSM Link ■ EDGE 8 Link 	<ul style="list-style-type: none"> ■ GSM Link ■ EDGE 8 Link
GSM 1900	<ul style="list-style-type: none"> ■ GSM Link ■ EDGE 10 Link ■ GSM Link + Bluetooth Tx CH78 	<ul style="list-style-type: none"> ■ GSM Link ■ EDGE 10 Link

Note: The maximum power levels are GSM mode in GMSK link, EDGE multi-slot class 8 mode for GSM850, and EDGE multi-slot class 10 mode for GSM1900 in 8PSK link; only these modes were used for all tests.

The conducted power tables are as follows:

Conducted Power						
Band	GSM850			GSM1900		
Channel	128	189	251	512	661	810
Frequency	824.2	836.4	848.8	1850.2	1880.0	1909.8
GSM	32.33	32.45	32.55	29.78	29.73	29.50
GPRS 8	32.27	32.39	32.50	29.74	29.66	29.41
GPRS 10	32.25	32.36	32.44	29.71	29.63	29.38
GPRS 12	30.43	30.56	30.65	29.69	29.60	29.37
EGPRS 8	26.55	26.65	26.75	26.09	26.02	25.53
EGPRS 10	26.54	26.64	26.73	26.06	26.25	25.51
EGPRS 12	26.54	26.65	26.74	26.06	25.99	25.76

(*Unit: dBm)

2.2 Connection Diagram of Test System

<GSM Link Mode>

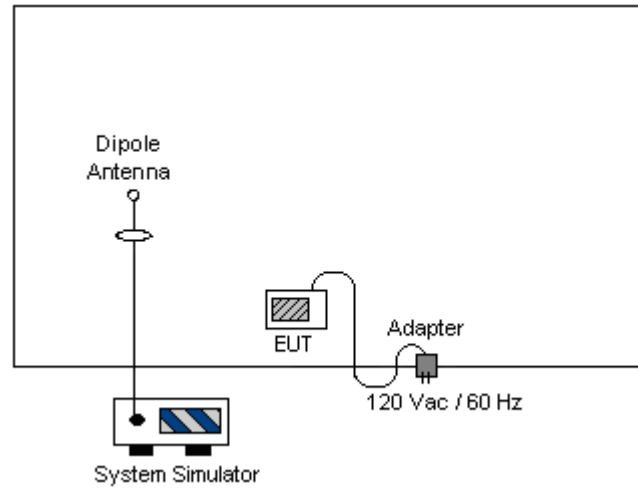

<GSM and Bluetooth Link Mode>

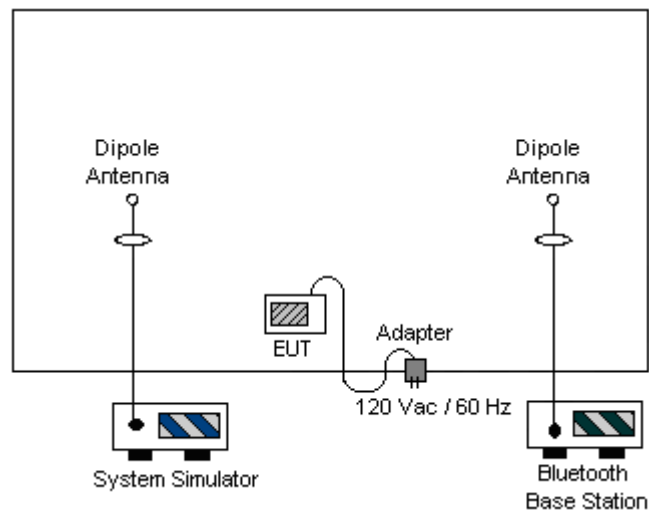

3 Test Result

3.1 Conducted Output Power Measurement

3.1.1 Description of the Conducted Output Power Measurement

A base station simulator was used to establish communication with the EUT. Its parameters were set to transmit the maximum power on the EUT. The measured power in the radio frequency on the transmitter output terminals shall be reported.

3.1.2 Measuring Instruments

See list of measuring instruments of this test report.

3.1.3 Test Procedures

1. The transmitter output port was connected to base station.
2. Set EUT at maximum power through base station.
3. Select lowest, middle, and highest channels for each band and different modulation.

3.1.4 Test Setup

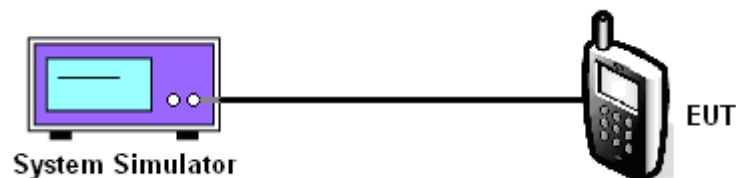



3.1.5 Test Result of Conducted Output Power

Cellular Band				
Modes	Channel	Frequency (MHz)	Conducted Power (dBm)	Conducted Power (Watts)
GSM850 (GSM)	128 (Low)	824.2	32.33	1.71
	189 (Mid)	836.4	32.45	1.76
	251 (High)	848.8	32.55	1.80
GSM850 (EDGE 8)	128 (Low)	824.2	26.55	0.45
	189 (Mid)	836.4	26.65	0.46
	251 (High)	848.8	26.75	0.47

PCS Band				
Modes	Channel	Frequency (MHz)	Conducted Power (dBm)	Conducted Power (Watts)
GSM1900 (GSM)	512 (Low)	1850.2	29.78	0.95
	661 (Mid)	1880.0	29.73	0.94
	810 (High)	1909.8	29.50	0.89
GSM1900 (EDGE 10)	512 (Low)	1850.2	26.06	0.40
	661 (Mid)	1880.0	26.25	0.42
	810 (High)	1909.8	25.51	0.36



3.2 Effective Radiated Power and Effective Isotropic Radiated Power Measurement

3.2.1 Description of the ERP/EIRP Measurement

ERP/EIRP is measured by substitution method according to ANSI / TIA / EIA-603-C-2004. The ERP of mobile transmitters must not exceed 7 Watts and the EIRP of mobile transmitters are limited to 2 Watts.

3.2.2 Measuring Instruments

See list of measuring instruments of this test report.

3.2.3 Test Procedures

1. The EUT was placed on a turntable with 1.0 meter height in a fully anechoic chamber.
2. The EUT was set at 1.2 meters from the receiving antenna, which was mounted on the antenna tower.
3. The table was rotated 360 degrees to determine the position of the highest radiated power.
4. The height of the receiving antenna is adjusted to look for the maximum ERP/EIRP.
5. Taking the record of maximum ERP/EIRP.
6. A dipole antenna was substituted in place of the EUT and was driven by a signal generator.
7. The conducted power at the terminal of the dipole antenna is measured.
8. Repeat step 3 to step 5 to get the maximum ERP/EIRP of the substitution antenna.
9. $ERP/EIRP = P_s + E_t - E_s + G_s = P_s + R_t - R_s + G_s$
Ps (dBm) : Input power to substitution antenna.
Gs (dBi or dBd) : Substitution antenna Gain.
 $E_t = R_t + AF$
 $E_s = R_s + AF$
AF (dB/m) : Receive antenna factor
Rt : The highest received signal in spectrum analyzer for EUT.
Rs : The highest received signal in spectrum analyzer for substitution antenna.

3.2.4 Test Setup

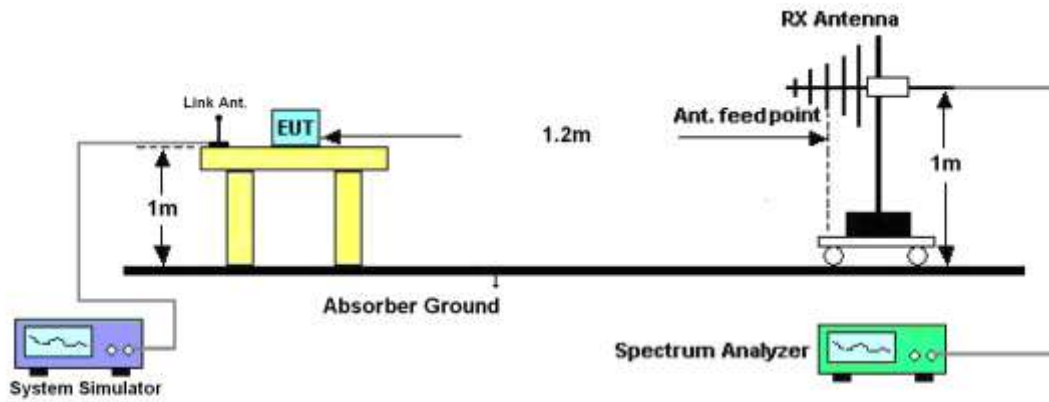



3.2.5 Test Result of ERP

GSM850 (GSM) Radiated Power ERP						
Horizontal Polarization						
Frequency (MHz)	Rt (dBm)	Rs (dBm)	Ps (dBm)	Gs (dBd)	ERP (dBm)	ERP (W)
824.20	-17.48	-48.12	0.00	-1.08	29.56	0.90
836.40	-16.65	-48.28	0.00	-0.93	30.70	1.17
848.80	-18.10	-48.35	0.00	-0.76	29.49	0.89
Vertical Polarization						
Frequency (MHz)	Rt (dBm)	Rs (dBm)	Ps (dBm)	Gs (dBd)	ERP (dBm)	ERP (W)
824.20	-31.34	-47.97	0.00	-1.08	15.55	0.04
836.40	-30.51	-48.01	0.00	-0.93	16.57	0.05
848.80	-31.76	-48.05	0.00	-0.76	15.53	0.04

GSM850 (EDGE 8) Radiated Power ERP						
Horizontal Polarization						
Frequency (MHz)	Rt (dBm)	Rs (dBm)	Ps (dBm)	Gs (dBd)	ERP (dBm)	ERP (W)
824.20	-22.92	-48.12	0.00	-1.08	24.12	0.26
836.40	-22.38	-48.28	0.00	-0.93	24.97	0.31
848.80	-22.05	-48.35	0.00	-0.76	25.54	0.36
Vertical Polarization						
Frequency (MHz)	Rt (dBm)	Rs (dBm)	Ps (dBm)	Gs (dBd)	ERP (dBm)	ERP (W)
824.20	-36.81	-47.97	0.00	-1.08	10.08	0.01
836.40	-36.33	-48.01	0.00	-0.93	10.75	0.01
848.80	-35.97	-48.05	0.00	-0.76	11.32	0.01



3.2.6 Test Result of EIRP

GSM1900 (GSM) Radiated Power EIRP						
Horizontal Polarization						
Frequency (MHz)	Rt (dBm)	Rs (dBm)	Ps (dBm)	Gs (dBi)	EIRP (dBm)	EIRP (W)
1850.20	-23.86	-51.88	0.00	1.96	29.98	1.00
1880.00	-26.81	-52.99	0.00	2.00	28.18	0.66
1909.80	-29.66	-54.28	0.00	1.98	26.60	0.46
Vertical Polarization						
Frequency (MHz)	Rt (dBm)	Rs (dBm)	Ps (dBm)	Gs (dBi)	EIRP (dBm)	EIRP (W)
1850.20	-24.06	-52.13	0.00	1.96	30.03	1.01
1880.00	-26.02	-53.17	0.00	2.00	29.15	0.82
1909.80	-28.08	-54.13	0.00	1.98	28.03	0.64

GSM1900 (EDGE 10) Radiated Power EIRP						
Horizontal Polarization						
Frequency (MHz)	Rt (dBm)	Rs (dBm)	Ps (dBm)	Gs (dBi)	EIRP (dBm)	EIRP (W)
1850.20	-27.26	-51.88	0.00	1.96	26.58	0.45
1880.00	-30.16	-52.99	0.00	2.00	24.83	0.30
1909.80	-33.13	-54.28	0.00	1.98	23.13	0.21
Vertical Polarization						
Frequency (MHz)	Rt (dBm)	Rs (dBm)	Ps (dBm)	Gs (dBi)	EIRP (dBm)	EIRP (W)
1850.20	-27.09	-52.13	0.00	1.96	27.00	0.50
1880.00	-29.28	-53.17	0.00	2.00	25.89	0.39
1909.80	-31.54	-54.13	0.00	1.98	24.57	0.29

3.3 Occupied Bandwidth Measurement

3.3.1 Description of Occupied Bandwidth Measurement

The emission bandwidth is defined as the width of the signal between two points, located at the 2 sides of the carrier frequency, outside of which all emissions are attenuated at least 26 dB below the transmitter power.

3.3.2 Measuring Instruments

See list of measuring instruments of this test report.

3.3.3 Test Procedures

1. The EUT was connected to Spectrum Analyzer and Base Station via power divider.
2. The 99% and 26 dB occupied bandwidth (BW) of the middle channel for the highest RF powers were measured.

3.3.4 Test Setup

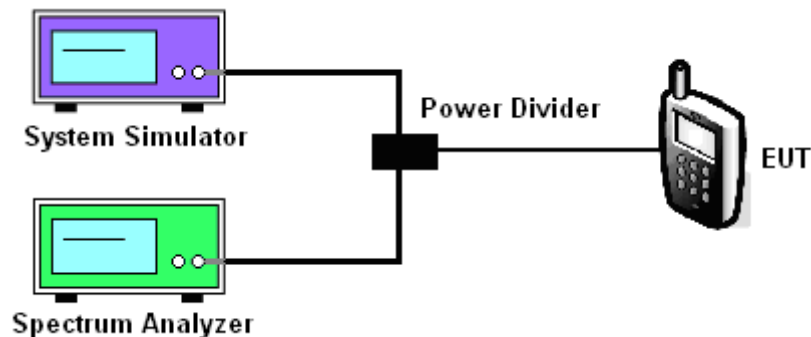



3.3.5 Test Result (Plots) of Occupied Bandwidth

Band :	GSM 850	Power Stage :	High
Test Mode :	GSM Link		

99% Occupied Bandwidth Plot on Channel 189

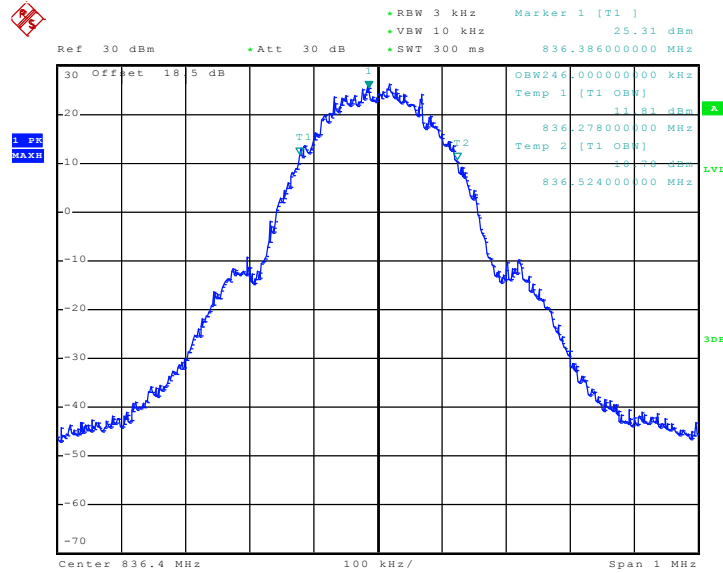

Date: 29.SEP.2009 19:27:26

26dB Bandwidth Plot on Channel 189

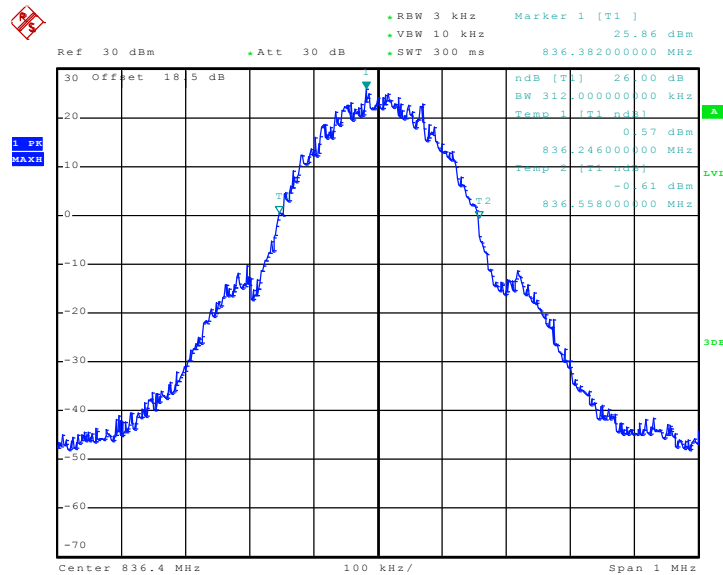

Date: 29.SEP.2009 19:09:10



Band :	GSM 850	Power Stage :	High
Test Mode :	EDGE 8 Link		

99% Occupied Bandwidth Plot on Channel 189

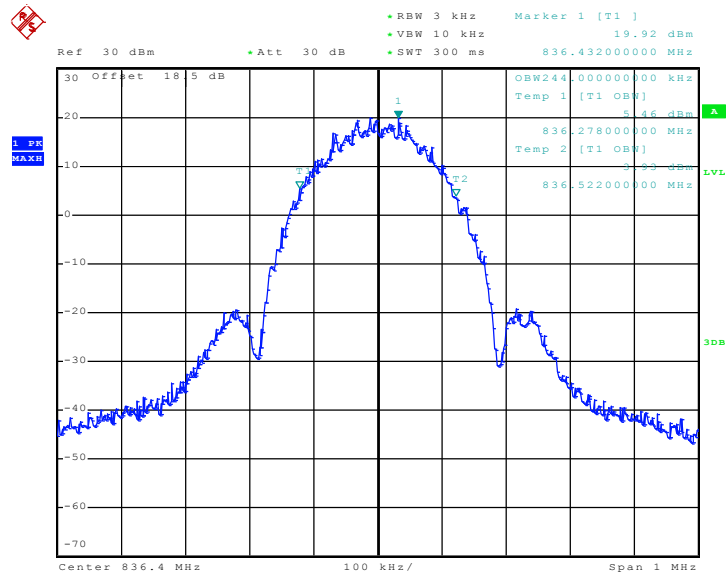

Date: 29.SEP.2009 20:17:56

26dB Bandwidth Plot on Channel 189

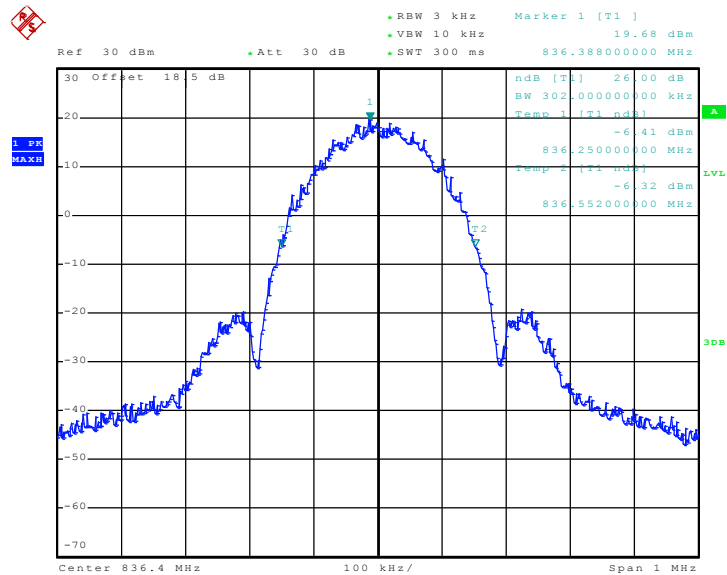

Date: 29.SEP.2009 20:12:06



Band :	GSM 1900	Power Stage :	High
Test Mode :	GSM Link		

99% Occupied Bandwidth Plot on Channel 661

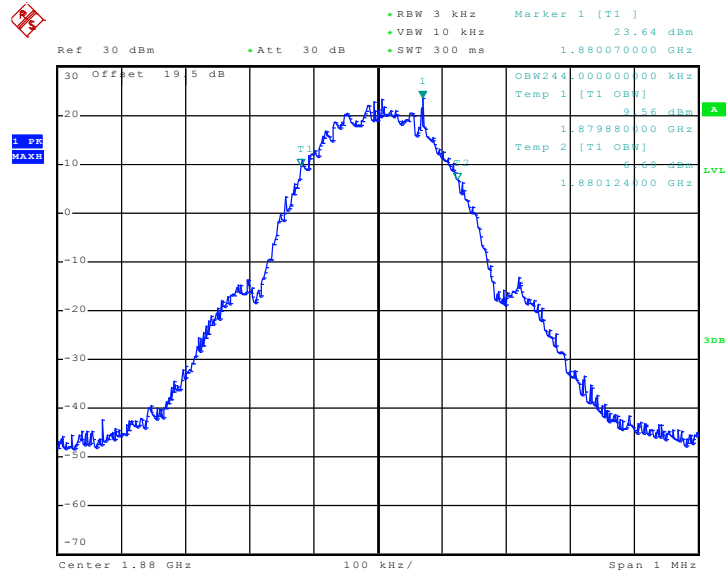

Date: 29.SEP.2009 21:50:30

26dB Bandwidth Plot on Channel 661

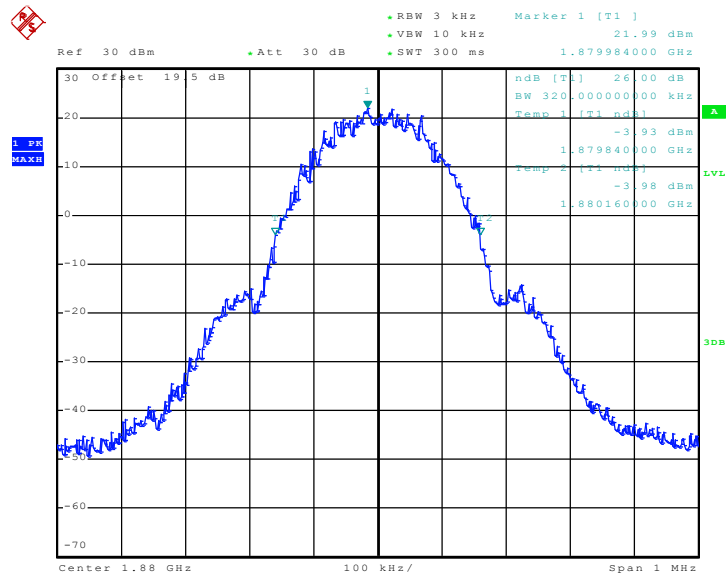

Date: 29.SEP.2009 21:46:40



Band :	GSM 1900	Power Stage :	High
Test Mode :	EDGE 10 Link		

99% Occupied Bandwidth Plot on Channel 661

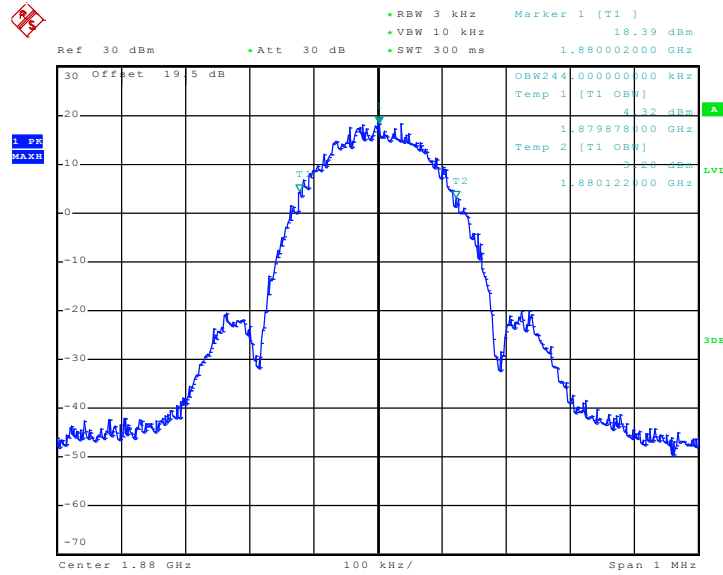

Date: 29.SEP.2009 21:14:46

26dB Bandwidth Plot on Channel 661

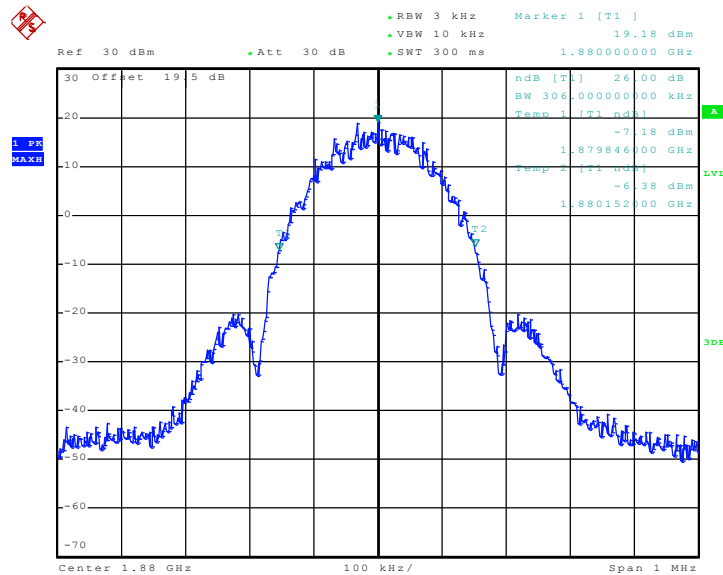

Date: 29.SEP.2009 21:06:43

3.4 Band Edge Measurement

3.4.1 Description of Band Edge Measurement

The power of any emission outside of the authorized operating frequency ranges must be lower than the transmitter power (P) by a factor of at least $43 + 10 \log (P)$ dB.

3.4.2 Measuring Instruments

See list of measuring instruments of this test report.

3.4.3 Test Procedures

1. The EUT was connected to Spectrum Analyzer and Base Station via power divider.
2. The band edges of low and high channels for the highest RF powers were measured. Setting RBW as roughly $BW/100$.

3.4.4 Test Setup

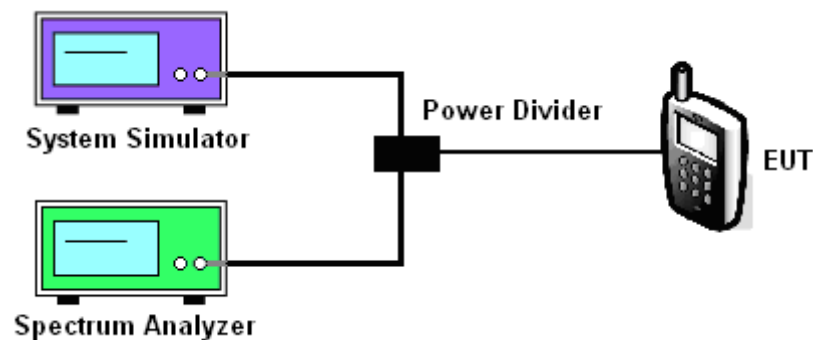



3.4.5 Test Result (Plots) of Conducted Band Edge

Band :	GSM850	Power Stage :	High
Test Mode :	GSM Link		

Lower Band Edge Plot on Channel 128

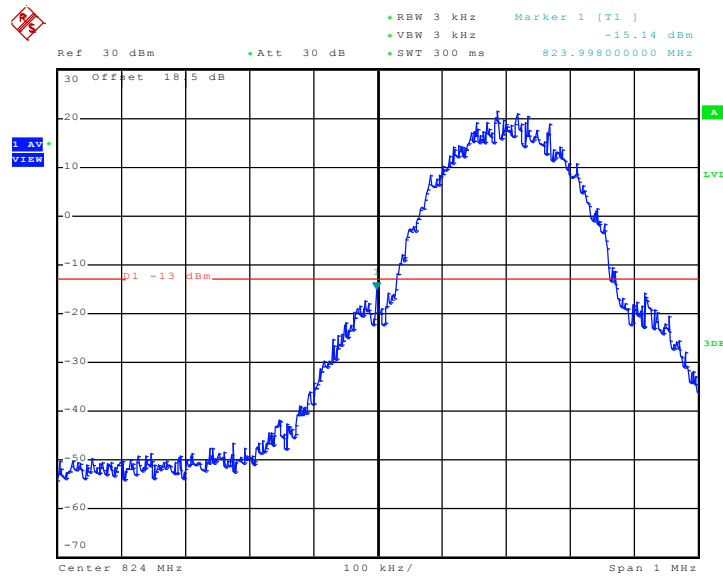

Date: 29.SEP.2009 19:18:37

Higher Band Edge Plot on Channel 251

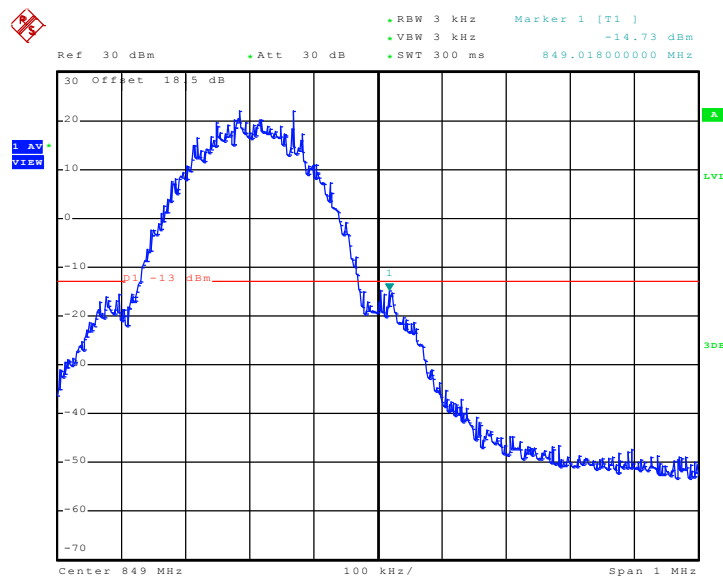

Date: 29.SEP.2009 19:13:12



Band :	GSM850	Power Stage :	High
Test Mode :	EDGE 8 Link		

Lower Band Edge Plot on Channel 128

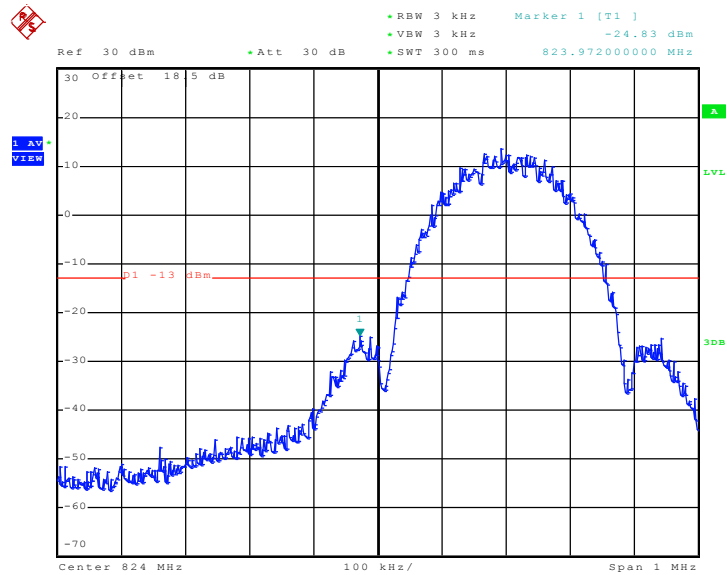

Date: 29.SEP.2009 20:23:36

Higher Band Edge Plot on Channel 251

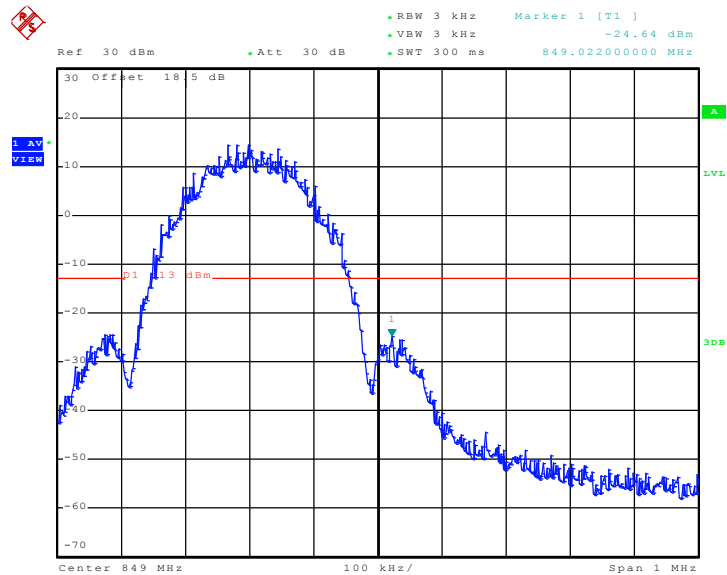

Date: 29.SEP.2009 20:28:00



Band :	GSM1900	Power Stage :	High
Test Mode :	GSM Link		

Lower Band Edge Plot on Channel 512

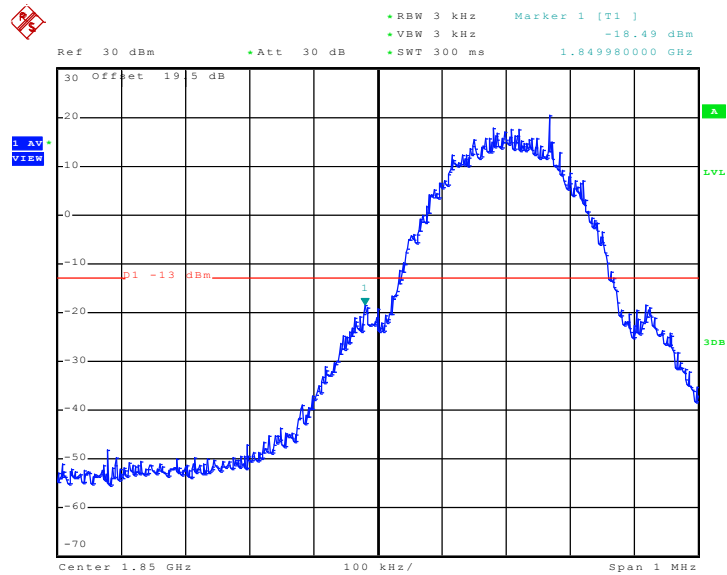

Date: 29.SEP.2009 21:54:29

Higher Band Edge Plot on Channel 810

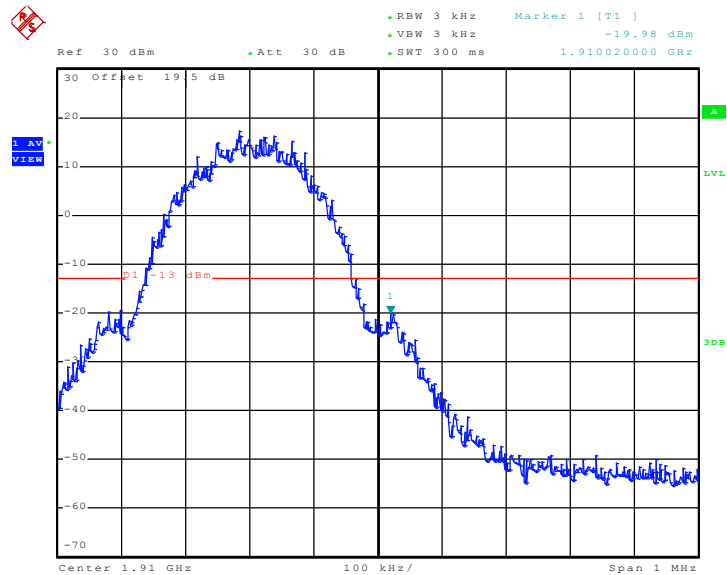

Date: 29.SEP.2009 21:58:06



Band :	GSM1900	Power Stage :	High
Test Mode :	EDGE 10 Link		

Lower Band Edge Plot on Channel 512

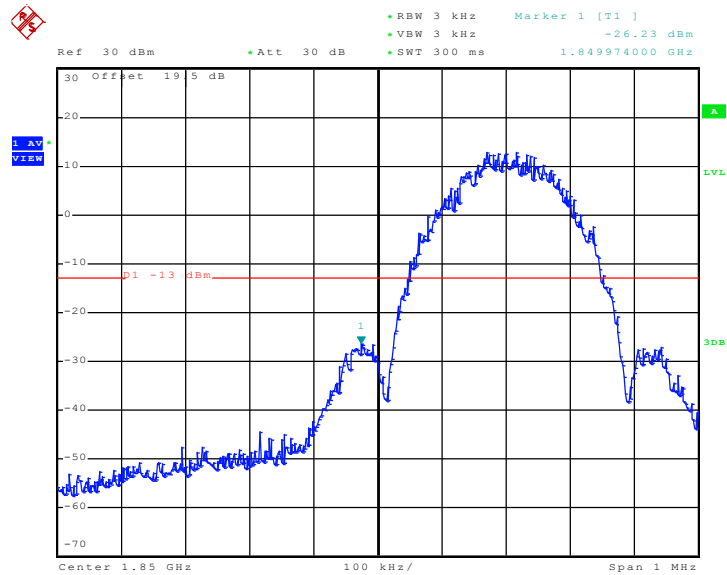

Date: 29.SEP.2009 21:18:16

Higher Band Edge Plot on Channel 810

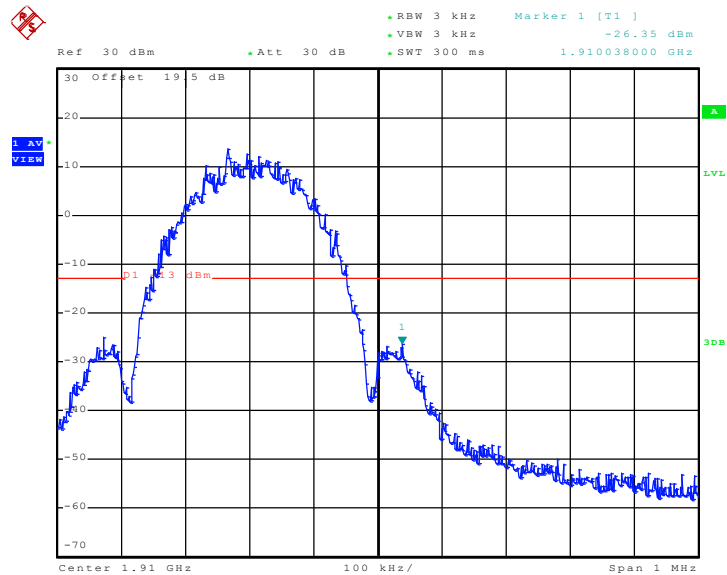

Date: 29.SEP.2009 21:21:56

3.5 Conducted Emission Measurement

3.5.1 Description of Conducted Emission Measurement

The power of any emission outside of the authorized operating frequency ranges must be lower than the transmitter power (P) by a factor of at least $43 + 10 \log (P)$ dB.

It is measured by means of a calibrated spectrum analyzer and scanned from 30 MHz up to a frequency including its 10th harmonic.

3.5.2 Measuring Instruments

See list of measuring instruments of this test report.

3.5.3 Test Procedures

1. The EUT was connected to spectrum analyzer and base station via power divider.
2. The middle channel for the highest RF power within the transmitting frequency was measured.
3. The conducted spurious emission for the whole frequency range was taken.

3.5.4 Test Setup

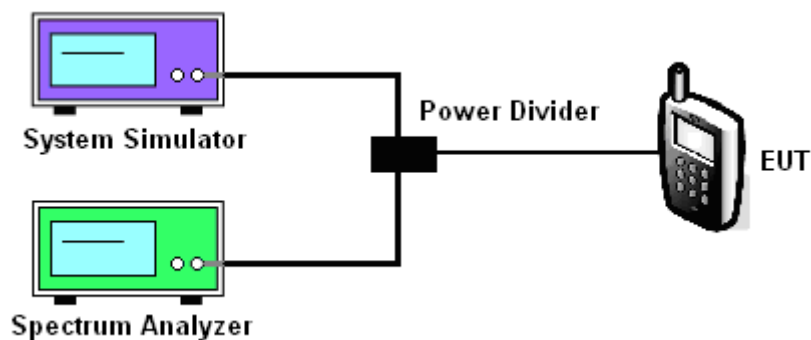



3.5.5 Test Result (Plots) of Conducted Emission

Band :	GSM850	Channel :	CH189
Test Mode :	GSM Link		

Conducted Emission Plot between 30MHz ~ 1GHz

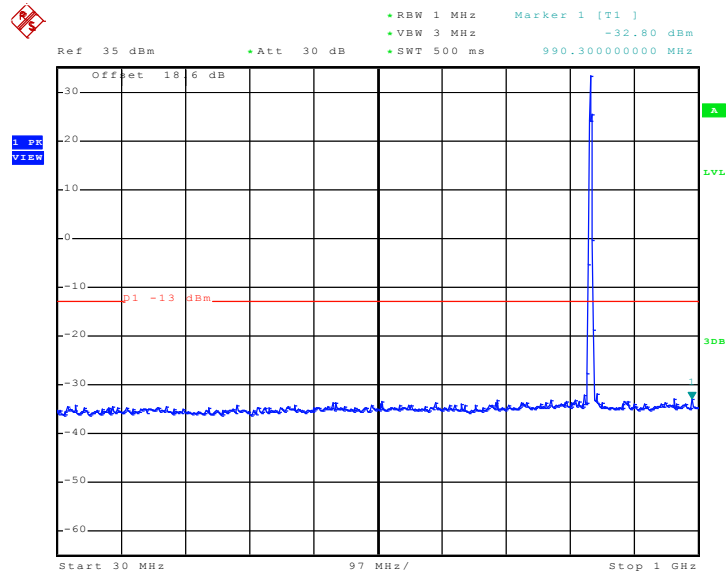

Date: 29.SEP.2009 19:47:48

Conducted Emission Plot between 1GHz ~ 3GHz

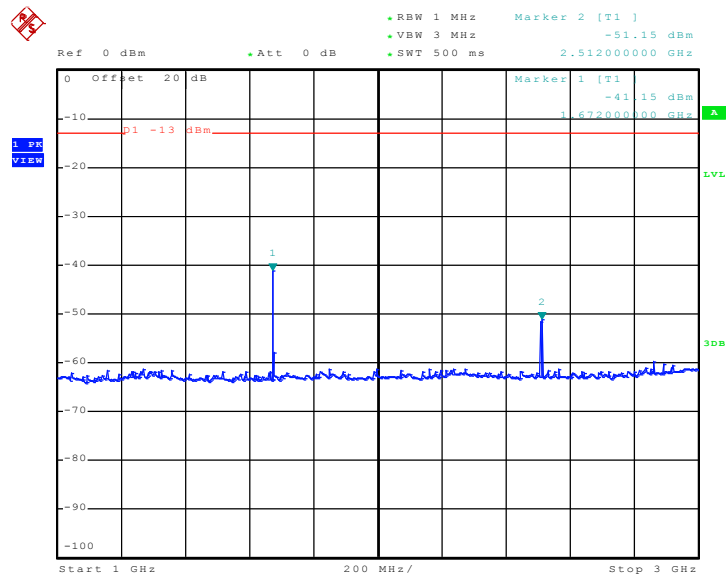

Date: 29.SEP.2009 20:52:58



Conducted Emission Plot between 3GHz ~ 7GHz

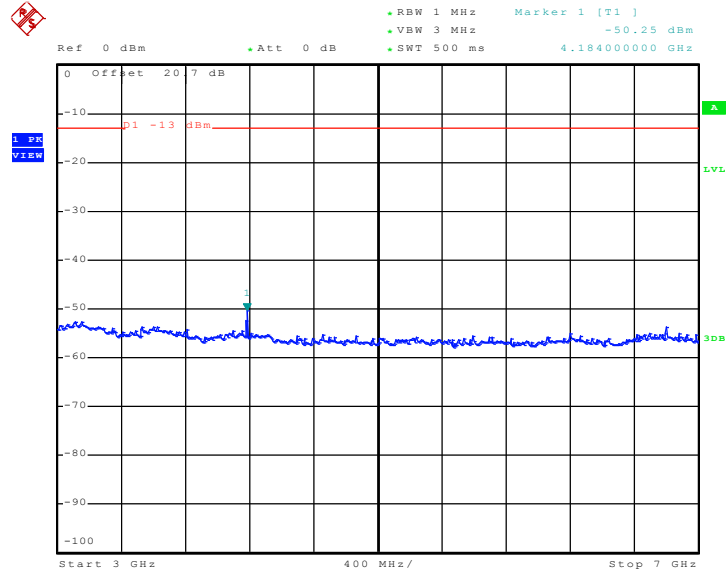

Date: 29.SEP.2009 19:53:51

Conducted Emission Plot between 7GHz ~ 9GHz

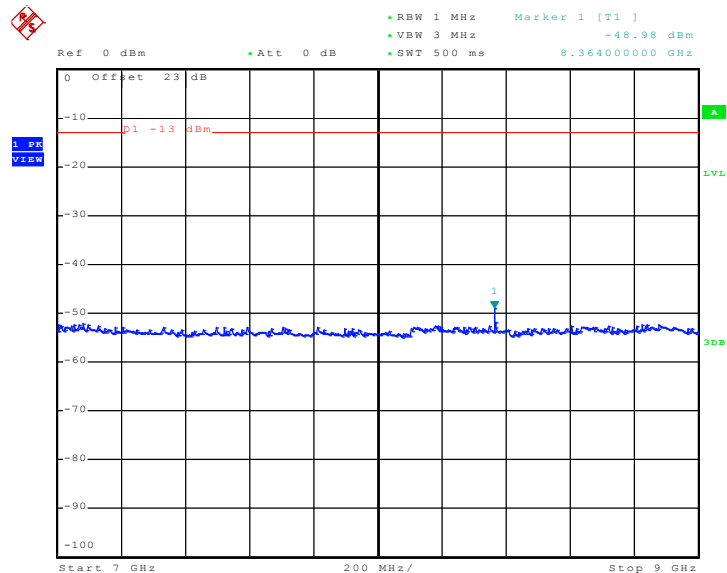

Date: 29.SEP.2009 19:55:55



Band :	GSM850	Channel :	CH189
Test Mode :	EDGE 8 Link		

Conducted Emission Plot between 30MHz ~ 1GHz

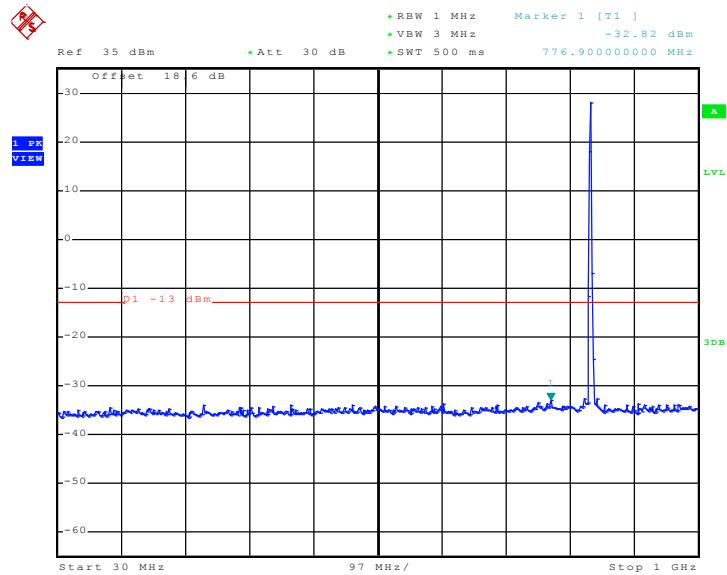

Date: 29.SEP.2009 20:41:54

Conducted Emission Plot between 1GHz ~ 3GHz

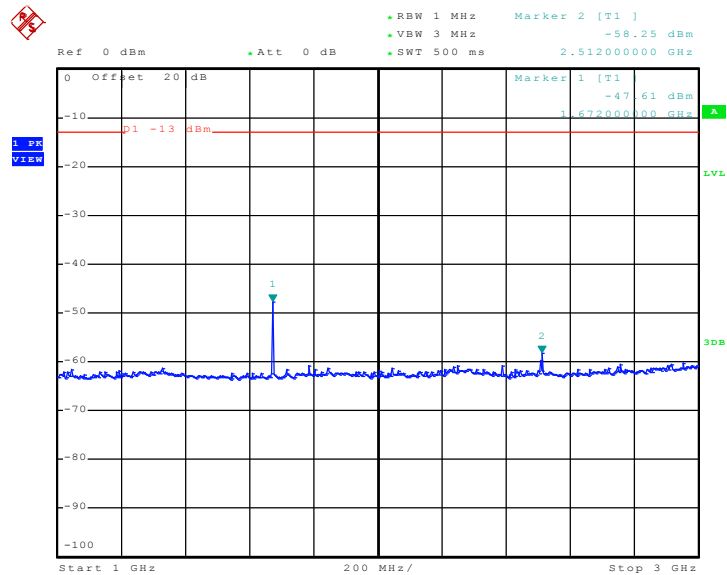

Date: 29.SEP.2009 20:51:38



Conducted Emission Plot between 3GHz ~ 7GHz

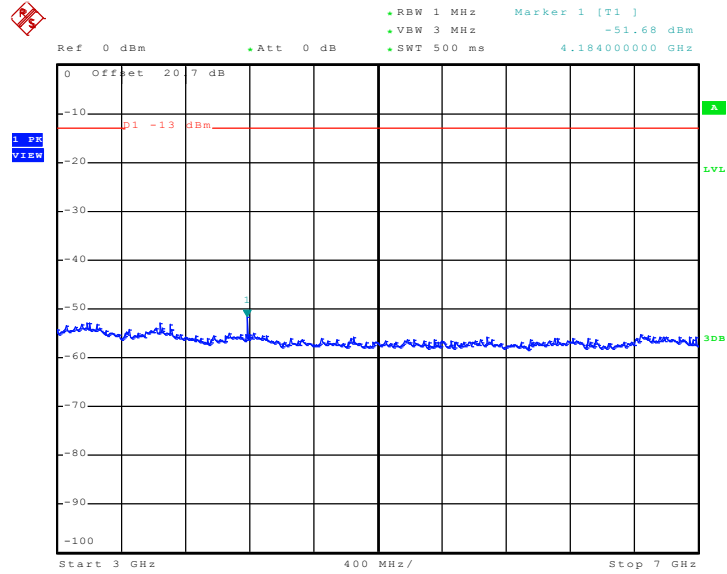

Date: 29.SEP.2009 20:54:40

Conducted Emission Plot between 7GHz ~ 9GHz

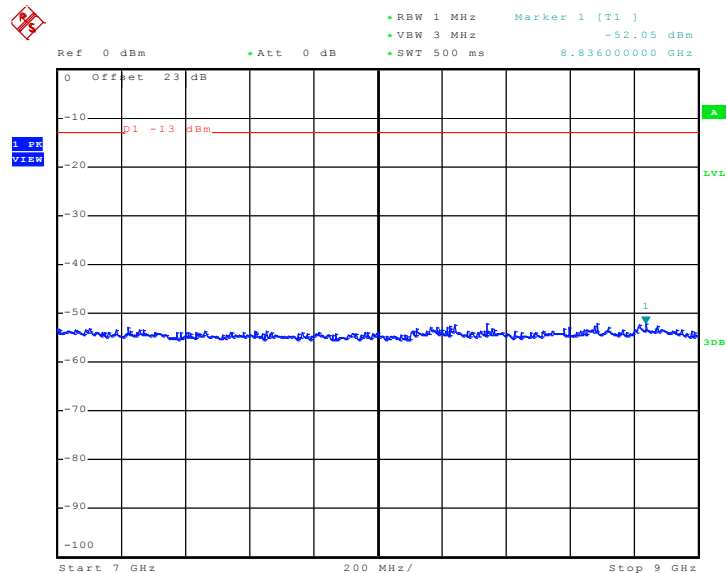

Date: 29.SEP.2009 20:55:36



Band :	GSM1900	Channel :	CH661
Test Mode :	GSM Link		

Conducted Emission Plot between 30MHz ~ 1GHz

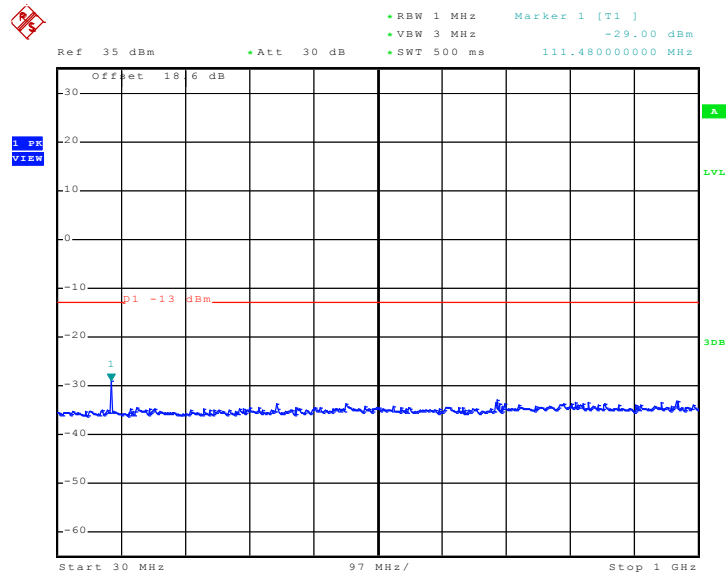

Date: 29.SEP.2009 22:02:36

Conducted Emission Plot between 1GHz ~ 3GHz

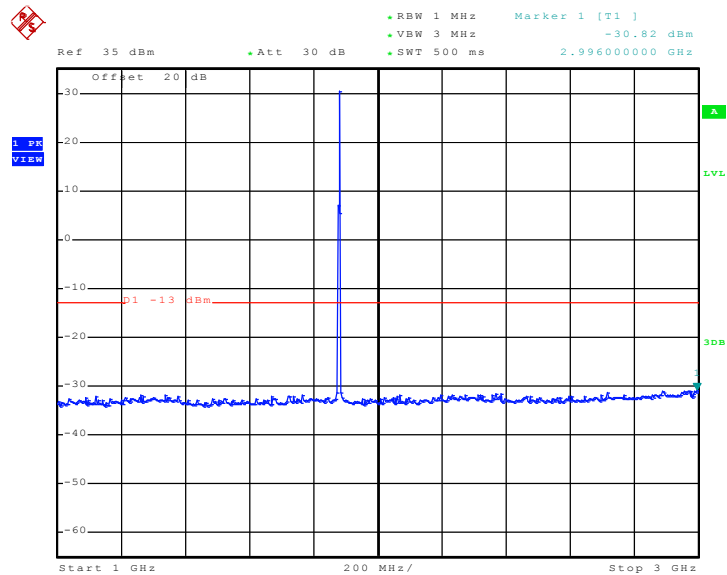

Date: 29.SEP.2009 22:04:24



Conducted Emission Plot between 3GHz ~ 7GHz

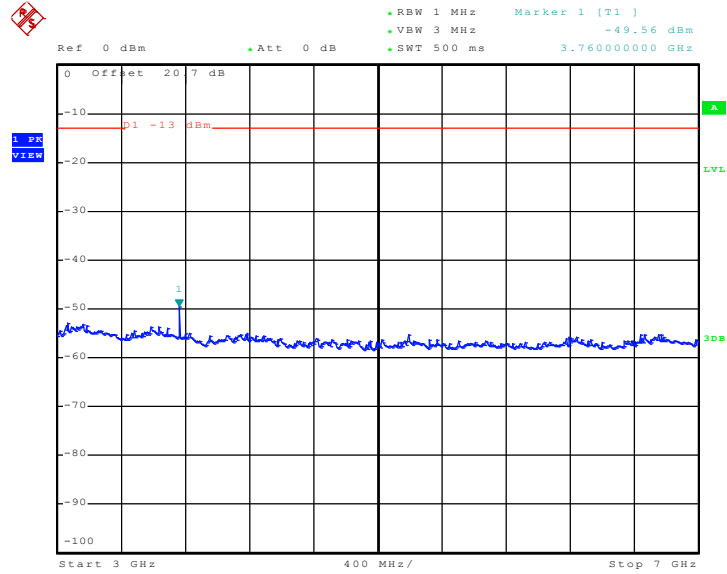

Date: 29.SEP.2009 22:05:31

Conducted Emission Plot between 7GHz ~ 13.6GHz

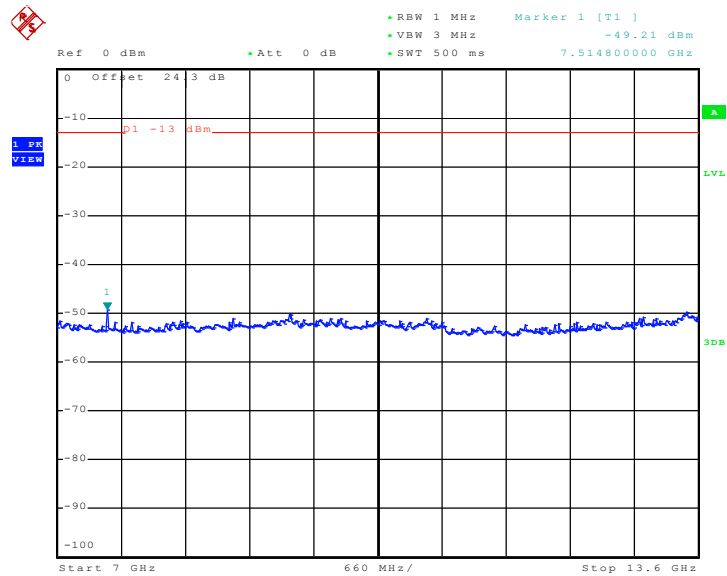

Date: 29.SEP.2009 22:07:46



Conducted Emission Plot between 13.6GHz ~ 19.1GHz

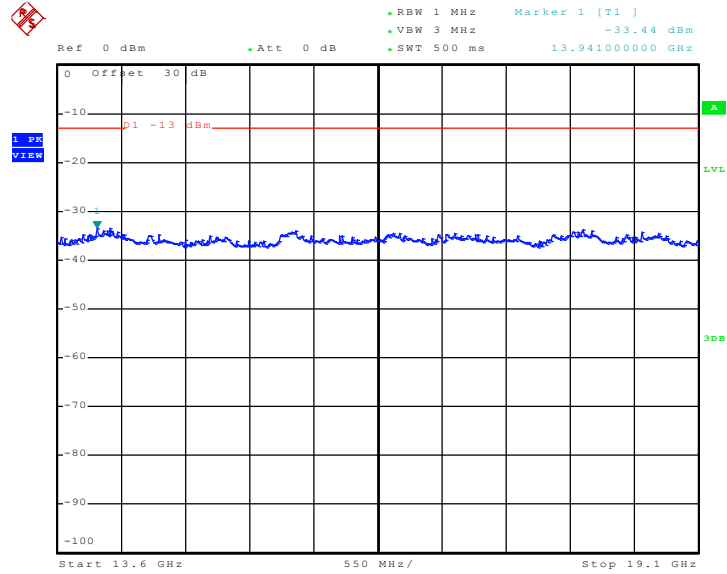

Date: 29.SEP.2009 22:10:06



Band :	GSM1900	Channel :	CH661
Test Mode :	EDGE 10 Link		

Conducted Emission Plot between 30MHz ~ 1GHz

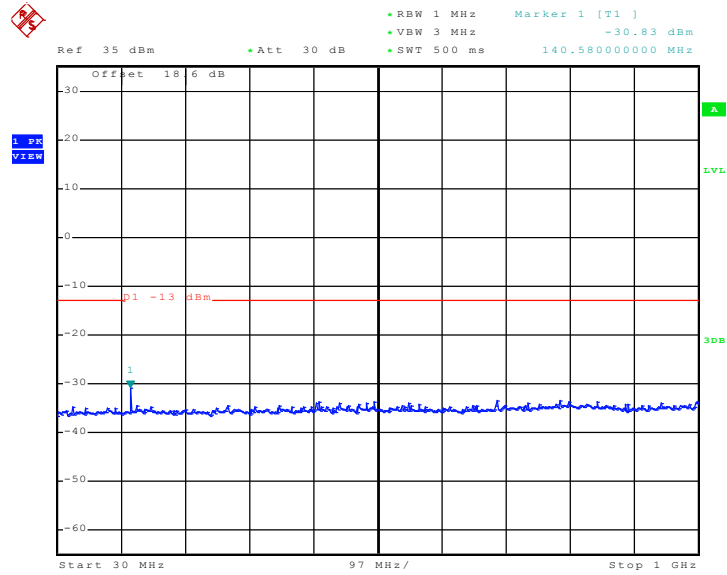

Date: 29.SEP.2009 21:30:21

Conducted Emission Plot between 1GHz ~ 3GHz

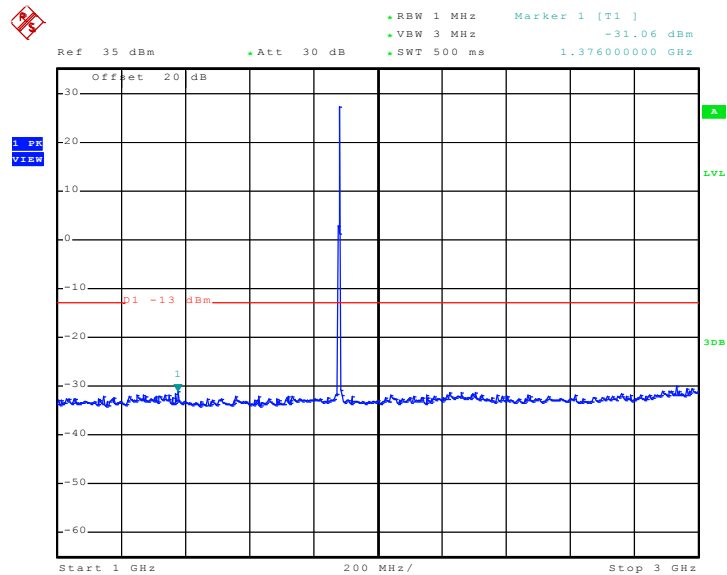

Date: 29.SEP.2009 21:31:57



Conducted Emission Plot between 3GHz ~ 7GHz

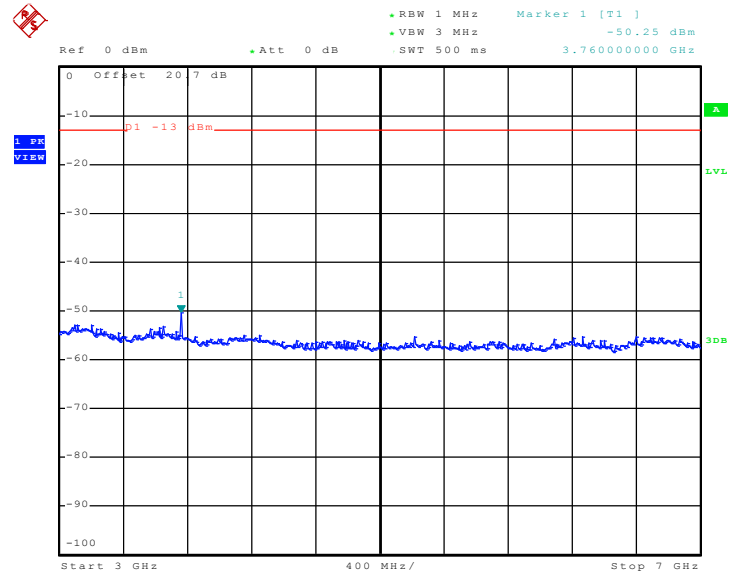

Date: 29.SEP.2009 21:33:33

Conducted Emission Plot between 7GHz ~ 13.6GHz

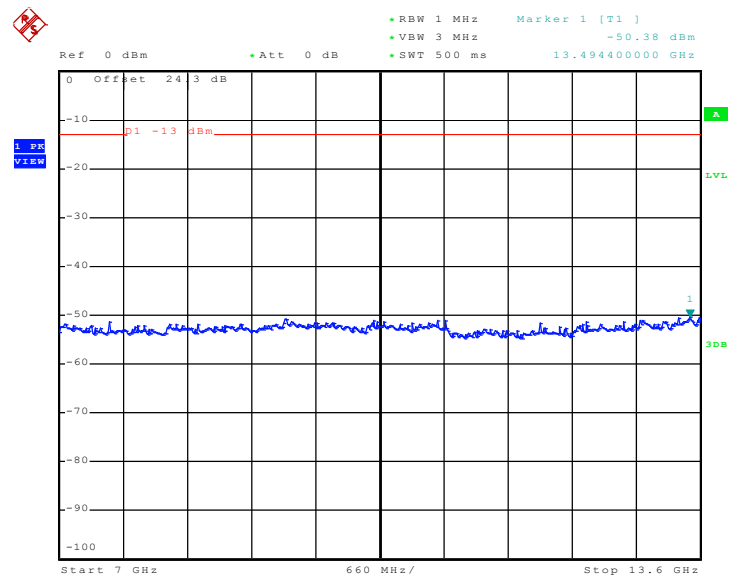

Date: 29.SEP.2009 21:37:29



Conducted Emission Plot between 13.6GHz ~ 19.1GHz

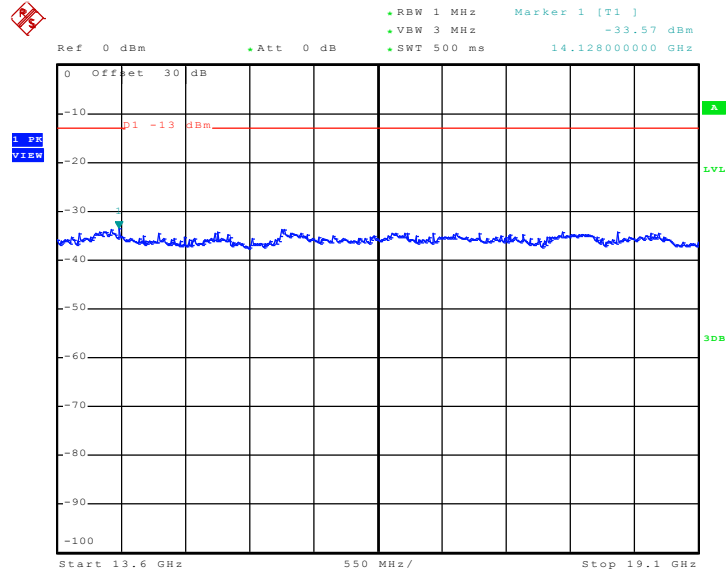

Date: 29.SEP.2009 21:38:58



3.6 Field Strength of Spurious Radiation Measurement

3.6.1 Description of Field Strength of Spurious Radiated Measurement

The radiated spurious emission was measured by substitution method according to ANSI / TIA / EIA-603-C-2004. The power of any emission outside of the authorized operating frequency ranges must be attenuated below the transmitter power (P) by a factor of at least $43 + 10 \log (P)$ dB. The spectrum is scanned from 30 MHz up to a frequency including its 10th harmonic.

3.6.2 Measuring Instruments

See list of measuring instruments of this test report.

3.6.3 Test Procedures

1. The EUT was placed on a rotatable wooden table with 0.8 meter about ground.
2. The EUT was set 3 meters from the receiving antenna, which was mounted on the antenna tower.
3. The table was rotated 360 degrees to determine the position of the highest spurious emission.
4. The height of the receiving antenna is varied between one meter and four meters to search the maximum spurious emission for both horizontal and vertical polarizations.
5. Make the measurement with the spectrum analyzer's RBW = 1MHz, VBW = 3MHz, Sweep = 500ms, Taking the record of maximum spurious emission.
6. A horn antenna was substituted in place of the EUT and was driven by a signal generator.
7. Tune the output power of signal generator to the same emission level with EUT maximum spurious emission.
8. Taking the record of output power at antenna port.
9. Repeat step 7 to step 8 for another polarization.
10. $EIRP \text{ (dBm)} = S.G. \text{ Power} - Tx \text{ Cable Loss} + Tx \text{ Antenna Gain}$
11. $ERP \text{ (dBm)} = EIRP - 2.15$

3.6.4 Test Setup

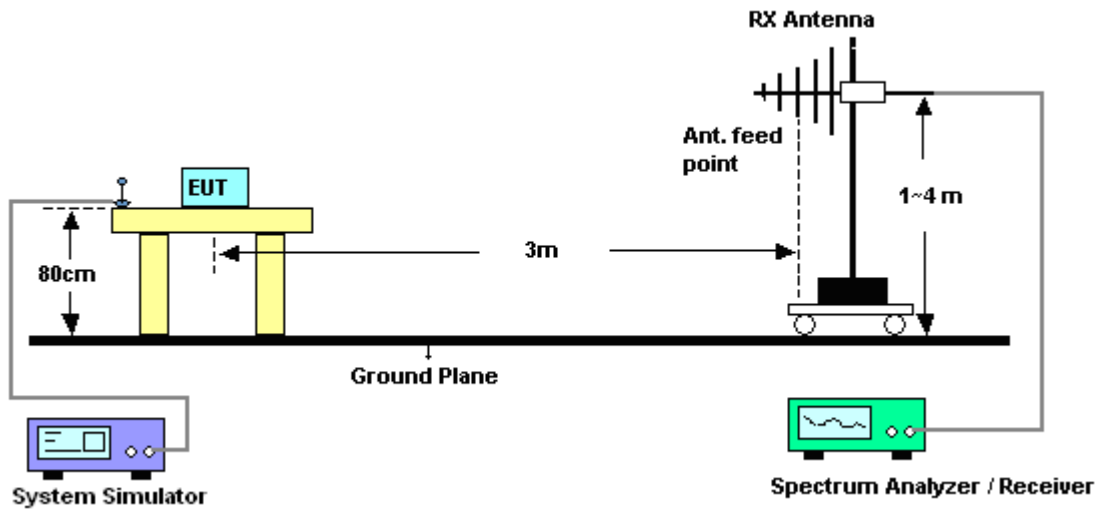



3.6.5 Test Result of Field Strength of Spurious Radiated

Band :	GSM850	Temperature :	23~24°C
Test Mode :	GSM Link	Relative Humidity :	47~48%
Test Engineer :	Kay Wu	Polarization :	Horizontal
Remark :	Spurious emissions within 30-1000MHz were found more than 20dB below limit line.		

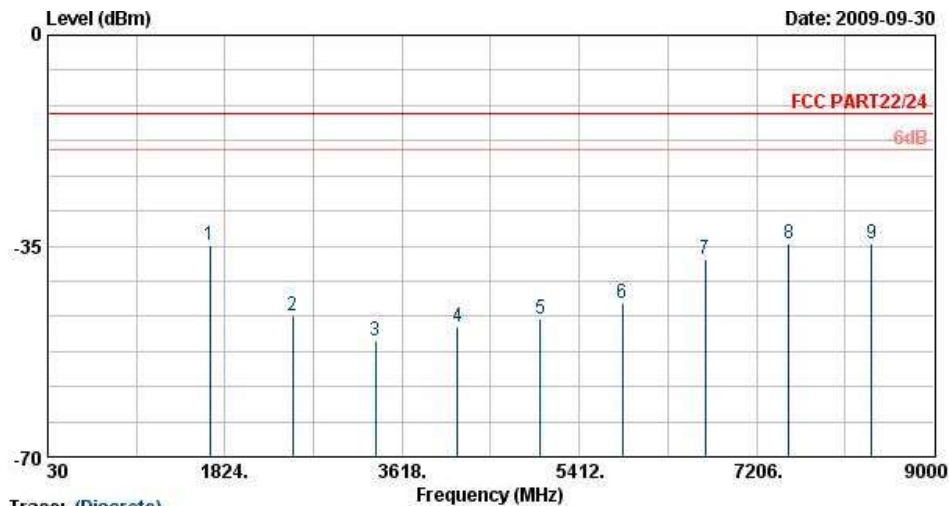

Site : 03CH07-HY
 Condition : FCC PART 22/24 HF-ETRP(080306) HORIZONTAL
 Project : FG 972007-01
 Mode : Mode 1
 TMET : 355885030000073

Frequency (MHz)	ERP (dBm)	Limit (dBm)	Over Limit (dB)	SPA Reading (dBm)	S.G. Power (dBm)	TX Cable loss (dB)	TX Antenna Gain (dBi)	Polarization (H/V)	Result
1669	-34.76	-13	-21.76	-44.02	-34.61	3.39	5.39	H	Pass
2509	-46.61	-13	-33.61	-56.75	-46.87	3.71	6.12	H	Pass
3346	-50.84	-13	-37.84	-61.79	-53.56	3.13	8.00	H	Pass
4175	-48.41	-13	-35.41	-61.51	-52.25	3.01	9.00	H	Pass
5015	-47.20	-13	-34.20	-61.96	-52.17	2.61	9.73	H	Pass
5850	-44.37	-13	-31.37	-62.77	-48.24	4.38	10.40	H	Pass
6690	-37.21	-13	-24.21	-59.02	-40.99	5.22	11.15	H	Pass
7530	-34.64	-13	-21.64	-58.76	-38.49	6.22	12.22	H	Pass
8370	-34.60	-13	-21.60	-56.25	-39.9	5.59	13.04	H	Pass



Band :	GSM850	Temperature :	23~24°C
Test Mode :	GSM Link	Relative Humidity :	47~48%
Test Engineer :	Kay Wu	Polarization :	Vertical
Remark :	Spurious emissions within 30-1000MHz were found more than 20dB below limit line.		

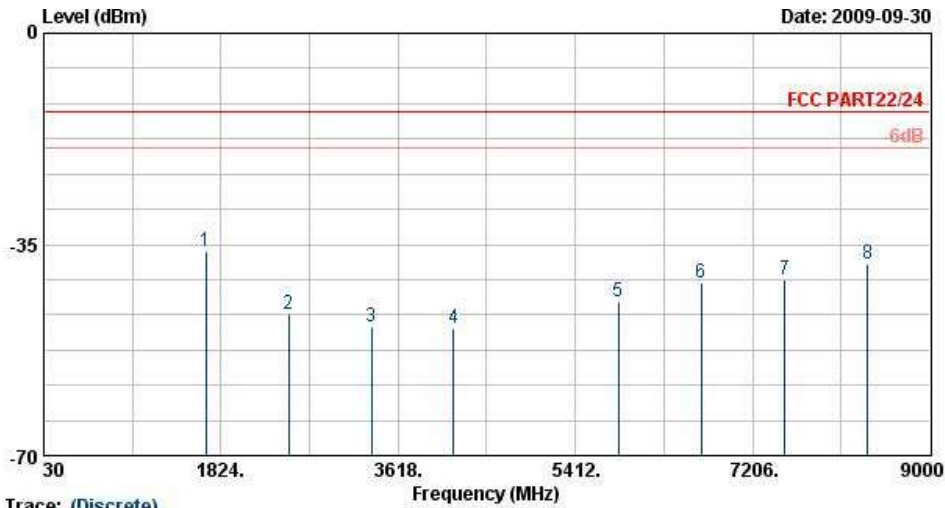

Trace: (Discrete)
 Site : 03CH07-HY
 Condition : FCC PART22/24 HF-ETRP(080306) VERTICAL
 Project : FG 972007-01
 Mode : Mode 1
 TA#ET : 355885030000073

Frequency (MHz)	ERP (dBm)	Limit (dBm)	Over Limit (dB)	SPA Reading (dBm)	S.G. Power (dBm)	TX Cable loss (dB)	TX Antenna Gain (dBi)	Polarization (H/V)	Result
1669	-36.23	-13	-23.23	-45.32	-36.08	3.39	5.39	V	Pass
2509	-46.57	-13	-33.57	-56.82	-46.83	3.71	6.12	V	Pass
3346	-48.75	-13	-35.75	-61.19	-51.47	3.13	8.00	V	Pass
4175	-48.89	-13	-35.89	-62.82	-52.73	3.01	9.00	V	Pass
5850	-44.40	-13	-31.40	-62.52	-48.27	4.38	10.40	V	Pass
6690	-41.42	-13	-28.42	-62.64	-45.20	5.22	11.15	V	Pass
7530	-40.83	-13	-27.83	-64.73	-44.68	6.22	12.22	V	Pass
8370	-38.33	-13	-25.33	-59.72	-43.63	5.59	13.04	V	Pass



Band :	GSM850	Temperature :	23~24°C
Test Mode :	EDGE 8 Link	Relative Humidity :	47~48%
Test Engineer :	Kay Wu	Polarization :	Horizontal
Remark :	Spurious emissions within 30-1000MHz were found more than 20dB below limit line.		

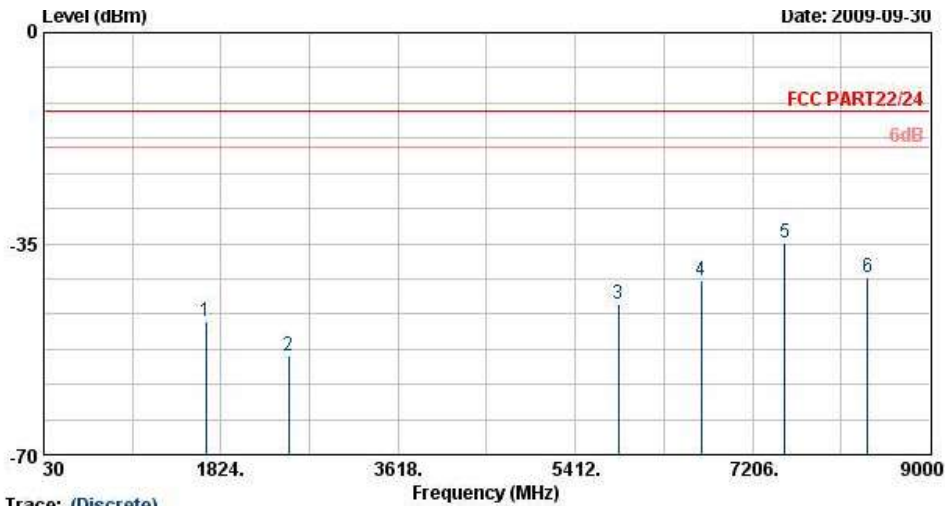

Trace: (Discrete)
 Site : 03CH07-RY
 Condition : FCC PART22/24 HF-ETRP(080306) HORIZONTAL
 Project : FG 972007-01
 Mode : Mode 2
 TAET : 355885030000073

Frequency (MHz)	ERP (dBm)	Limit (dBm)	Over Limit (dB)	SPA Reading (dBm)	S.G. Power (dBm)	TX Cable loss (dB)	TX Antenna Gain (dBi)	Polarization (H/V)	Result
1669	-48.01	-13	-35.01	-55.36	-47.86	3.39	5.39	H	Pass
2509	-53.63	-13	-40.63	-63.77	-53.89	3.71	6.12	H	Pass
5850	-45.10	-13	-32.10	-63.50	-48.97	4.38	10.40	H	Pass
6690	-40.99	-13	-27.99	-62.80	-44.77	5.22	11.15	H	Pass
7530	-34.99	-13	-21.99	-59.11	-38.84	6.22	12.22	H	Pass
8370	-40.51	-13	-27.51	-62.33	-45.81	5.59	13.04	H	Pass



Band :	GSM850	Temperature :	23~24°C
Test Mode :	EDGE 8 Link	Relative Humidity :	47~48%
Test Engineer :	Kay Wu	Polarization :	Vertical
Remark :	Spurious emissions within 30-1000MHz were found more than 20dB below limit line.		

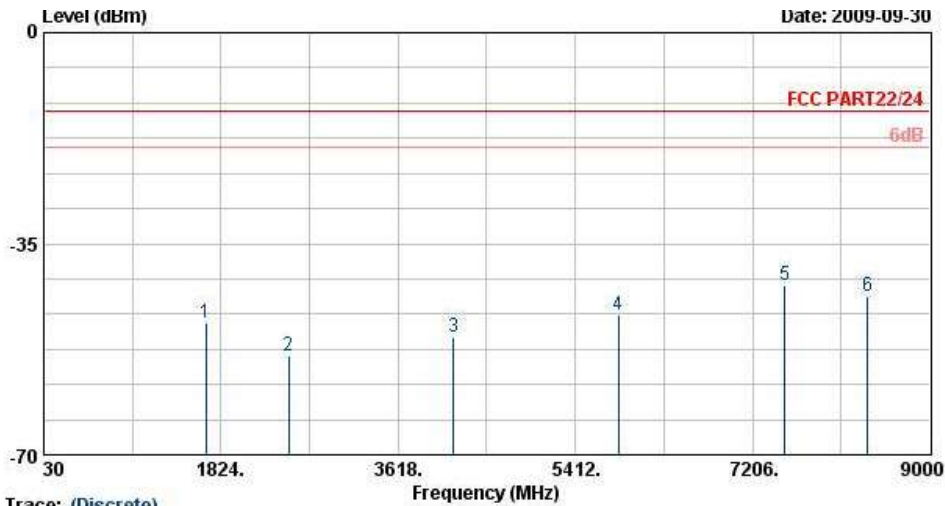

Trace: (Discrete)
 Site : D3CH07-HY
 Condition : FCC PART22/24 HF-ETRP(080306) VERTICAL
 Project : FG 972007-01
 Mode : Mode 2
 TRFET : 355R85030000073

Frequency (MHz)	ERP (dBm)	Limit (dBm)	Over Limit (dB)	SPA Reading (dBm)	S.G. Power (dBm)	TX Cable loss (dB)	TX Antenna Gain (dBi)	Polarization (H/V)	Result
1669	-48.23	-13	-35.23	-55.78	-48.08	3.39	5.39	V	Pass
2509	-53.59	-13	-40.59	-64.18	-53.85	3.71	6.12	V	Pass
4175	-50.52	-13	-37.52	-64.45	-54.36	3.01	9.00	V	Pass
5850	-46.72	-13	-33.72	-64.84	-50.59	4.38	10.40	V	Pass
7530	-42.00	-13	-29.00	-65.9	-45.85	6.22	12.22	V	Pass
8370	-43.67	-13	-30.67	-65.25	-48.97	5.59	13.04	V	Pass



Band :	GSM1900	Temperature :	23~24°C
Test Mode :	GSM Link	Relative Humidity :	47~48%
Test Engineer :	Kay Wu	Polarization :	Horizontal
Remark :	Spurious emissions within 30-1000MHz were found more than 20dB below limit line.		

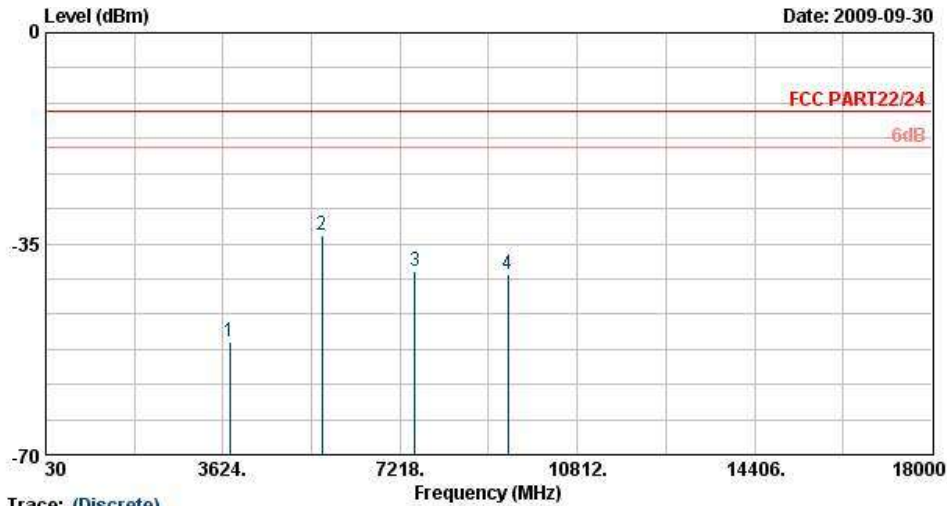

Trace: (Discrete)
 Site : 03CH07-HY
 Condition : FCC PART22/24 HF-ETRP(080306) HORIZONTAL
 Project : FG 972007-01
 Mode : Mode 1
 TRFET : 355885030000073

Frequency (MHz)	EIRP (dBm)	Limit (dBm)	Over Limit (dB)	SPA Reading (dBm)	S.G. Power (dBm)	TX Cable loss (dB)	TX Antenna Gain (dBi)	Polarization (H/V)	Result
3760	-51.39	-13	-38.39	-62.63	-54.42	4.88	7.91	H	Pass
5636	-33.52	-13	-20.52	-54.68	-37.74	5.55	9.77	H	Pass
7520	-39.50	-13	-26.50	-62.1	-43.67	6.64	10.81	H	Pass
9396	-40.06	-13	-27.06	-62.68	-43.87	6.91	10.72	H	Pass



Band :	GSM1900	Temperature :	23~24°C
Test Mode :	GSM Link	Relative Humidity :	47~48%
Test Engineer :	Kay Wu	Polarization :	Vertical
Remark :	Spurious emissions within 30-1000MHz were found more than 20dB below limit line.		

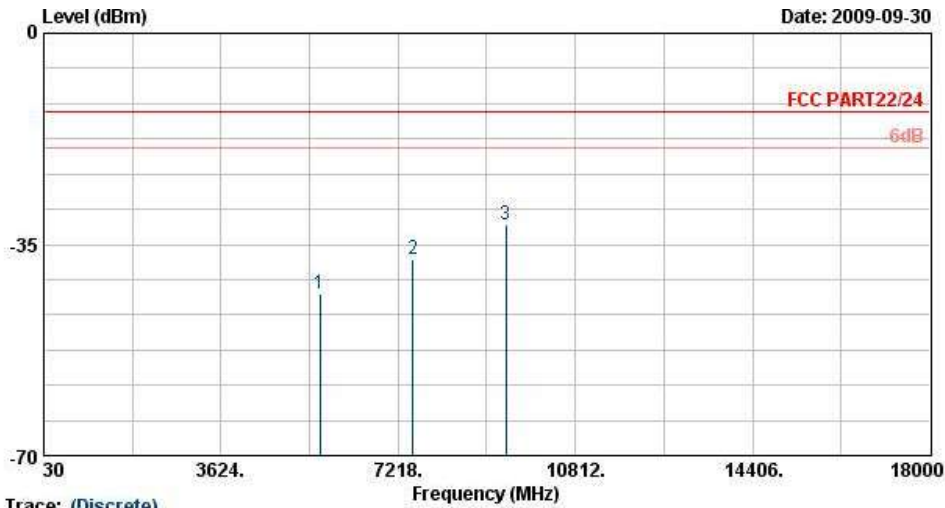

Trace: (Discrete)
 Site : 03CH07-HY
 Condition : FCC PART22/24 HF-ETRP(080306) VERTICAL
 Project : FG 972007-01
 Mode : Mode 1
 TAET : 355885030000073

Frequency (MHz)	EIRP (dBm)	Limit (dBm)	Over Limit (dB)	SPA Reading (dBm)	S.G. Power (dBm)	TX Cable loss (dB)	TX Antenna Gain (dBi)	Polarization (H/V)	Result
5636	-42.32	-13	-29.32	-61.78	-46.54	5.55	9.77	V	Pass
7520	-37.56	-13	-24.56	-63.61	-41.73	6.64	10.81	V	Pass
9396	-31.80	-13	-18.80	-60.13	-36.41	6.91	11.52	V	Pass



Band :	GSM1900	Temperature :	23~24°C
Test Mode :	EDGE 10 Link	Relative Humidity :	47~48%
Test Engineer :	Kay Wu	Polarization :	Horizontal
Remark :	Spurious emissions within 30-1000MHz were found more than 20dB below limit line.		

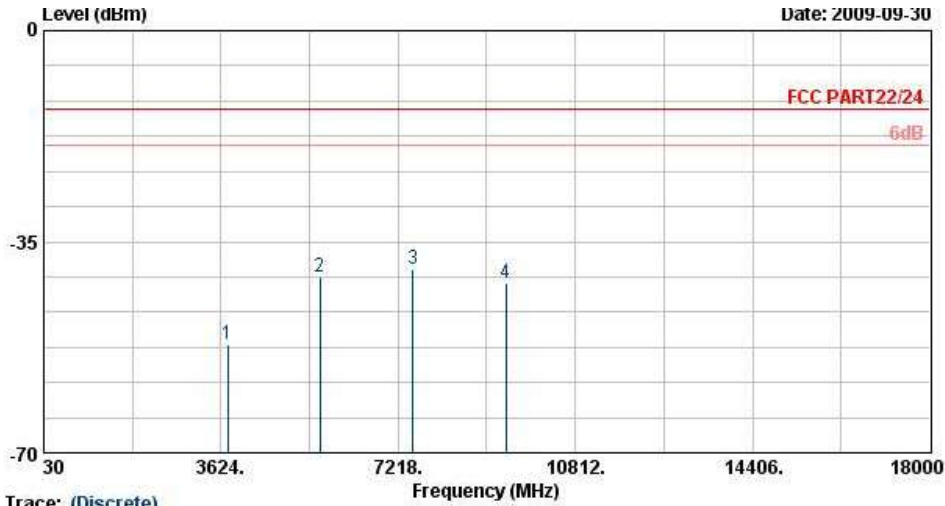

Trace: (Discrete)
 Site : D3CH07-HY
 Condition : FCC PART22/24 HF-ETRP(080306) HORIZONTAL
 Project : FG 972007-01
 Mode : Mode 2
 TRFET : 355885030000073

Frequency (MHz)	EIRP (dBm)	Limit (dBm)	Over Limit (dB)	SPA Reading (dBm)	S.G. Power (dBm)	TX Cable loss (dB)	TX Antenna Gain (dBi)	Polarization (H/V)	Result
3760	-52.13	-13	-39.13	-63.16	-55.16	4.88	7.91	H	Pass
5636	-40.79	-13	-27.79	-60.67	-45.01	5.55	9.77	H	Pass
7520	-39.57	-13	-26.57	-62.17	-43.74	6.64	10.81	H	Pass
9396	-41.86	-13	-28.86	-63.79	-45.67	6.91	10.72	H	Pass



Band :	GSM1900	Temperature :	23~24°C
Test Mode :	EDGE 10 Link	Relative Humidity :	47~48%
Test Engineer :	Kay Wu	Polarization :	Vertical
Remark :	Spurious emissions within 30-1000MHz were found more than 20dB below limit line.		

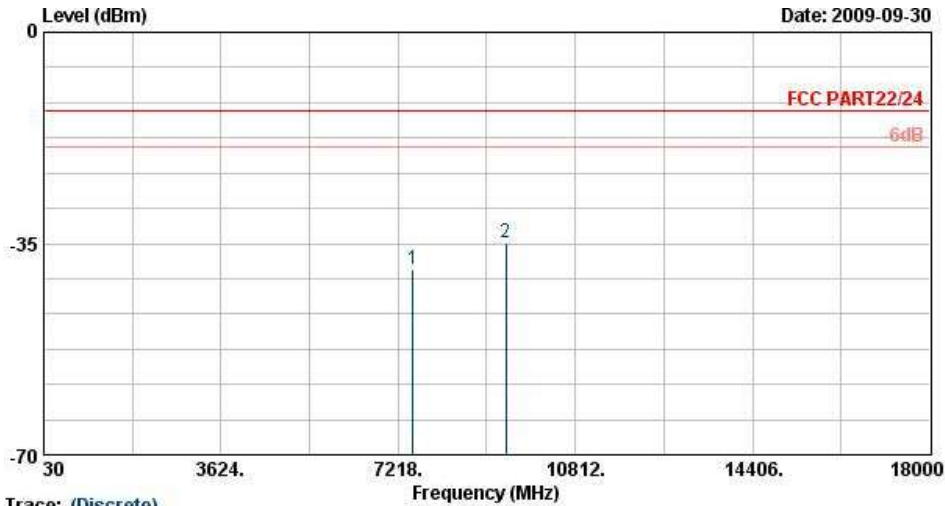

Trace: (Discrete)
 Site : D3CH07-HY
 Condition : FCC PART22/24 HF-ETRP(080306) VERTICAL
 Project : FG 972007-01
 Mode : Mode 2
 TRMT : 055R05000000070

Frequency (MHz)	EIRP (dBm)	Limit (dBm)	Over Limit (dB)	SPA Reading (dBm)	S.G. Power (dBm)	TX Cable loss (dB)	TX Antenna Gain (dBi)	Polarization (H/V)	Result
7520	-39.35	-13	-26.35	-65.4	-43.52	6.64	10.81	V	Pass
9396	-34.78	-13	-21.78	-62.77	-39.39	6.91	11.52	V	Pass



Band :	GSM1900	Temperature :	23~24°C
Test Mode :	GSM Link + Bluetooth Tx CH78	Relative Humidity :	47~48%
Test Engineer :	Kay Wu	Polarization :	Horizontal
Remark :	Spurious emissions within 30-1000MHz were found more than 20dB below limit line.		

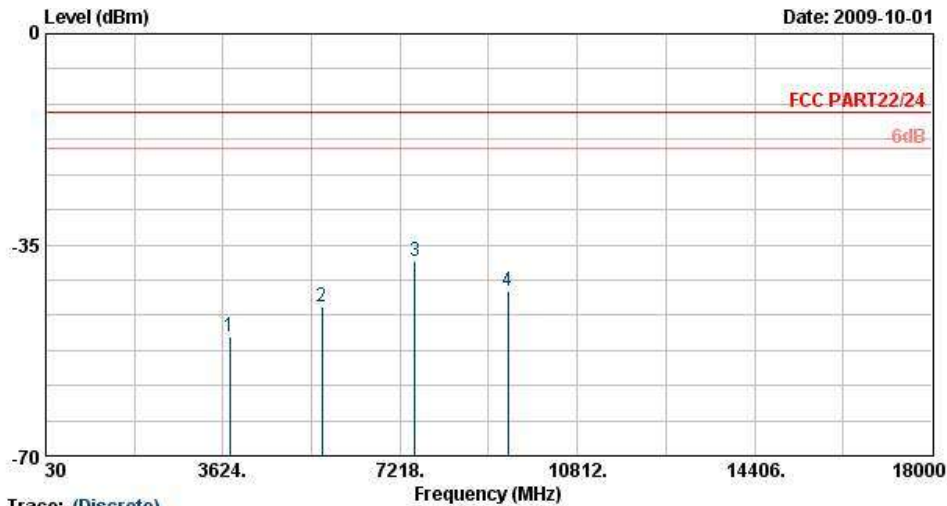

Trace: (Discrete)
 Site : 03CH07-HY
 Condition : FCC PART22/24 HF-ETRP(080306) HORIZONTAL
 Project : FG 972007-01
 Mode : Mode 1
 TRFET : 355R8503000000R1

Frequency (MHz)	EIRP (dBm)	Limit (dBm)	Over Limit (dB)	SPA Reading (dBm)	S.G. Power (dBm)	TX Cable loss (dB)	TX Antenna Gain (dBi)	Polarization (H/V)	Result
3760	-50.20	-13	-37.20	-62.36	-53.23	4.88	7.91	H	Pass
5636	-45.21	-13	-32.21	-63.82	-49.43	5.55	9.77	H	Pass
7520	-37.77	-13	-24.77	-60.76	-41.94	6.64	10.81	H	Pass
9396	-42.63	-13	-29.63	-64.9	-46.44	6.91	10.72	H	Pass



Band :	GSM1900	Temperature :	23~24°C
Test Mode :	GSM Link + Bluetooth Tx CH78	Relative Humidity :	47~48%
Test Engineer :	Kay Wu	Polarization :	Vertical
Remark :	Spurious emissions within 30-1000MHz were found more than 20dB below limit line.		

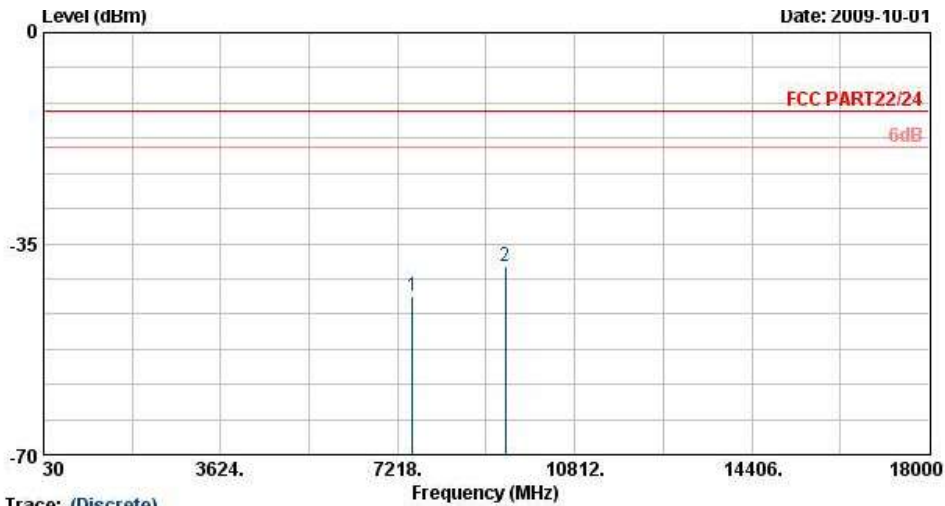

Trace: (Discrete)
 Site : 03CH07-HY
 Condition : FCC PART22/24 HF-ETRP(080306) VERTICAL
 Project : FG 972007-01
 Mode : Mode 1
 TAET : 355895030000081

Frequency (MHz)	EIRP (dBm)	Limit (dBm)	Over Limit (dB)	SPA Reading (dBm)	S.G. Power (dBm)	TX Cable loss (dB)	TX Antenna Gain (dBi)	Polarization (H/V)	Result
7520	-43.79	-13	-30.79	-64.64	-47.96	6.64	10.81	V	Pass
9396	-38.83	-13	-25.83	-65.55	-43.44	6.91	11.52	V	Pass

3.7 Frequency Stability Measurement

3.7.1 Description of Frequency Stability Measurement

The frequency stability shall be measured by variation of ambient temperature and variation of primary supply voltage to ensure that the fundamental emission stays within the authorized frequency block. The frequency stability of the transmitter shall be maintained within $\pm 0.00025\%$ ($\pm 2.5\text{ppm}$) of the center frequency.

3.7.2 Measuring Instruments

See list of measuring instruments of this test report.

3.7.3 Test Procedures for Temperature Variation

1. The EUT was set up in the thermal chamber and connected with the base station.
2. With power OFF, the temperature was decreased to -30°C and the EUT was stabilized for three hours. Power was applied and the maximum change in frequency was recorded within one minute.
3. With power OFF, the temperature was raised in 10°C step up to 50°C . The EUT was stabilized at each step for at least half an hour. Power was applied and the maximum frequency change was recorded within one minute.
4. If the EUT can not be turned on at -30°C , the testing lowest temperature will be raised in 10°C step until the EUT can be turned on.

3.7.4 Test Procedures for Voltage Variation

1. The EUT was placed in a temperature chamber at $25\pm 5^{\circ}\text{C}$ and connected with the base station.
2. The power supply voltage to the EUT was varied from BEP to 115% of the nominal value measured at the input to the EUT.
3. The variation in frequency was measured for the worst case.

3.7.5 Test Setup

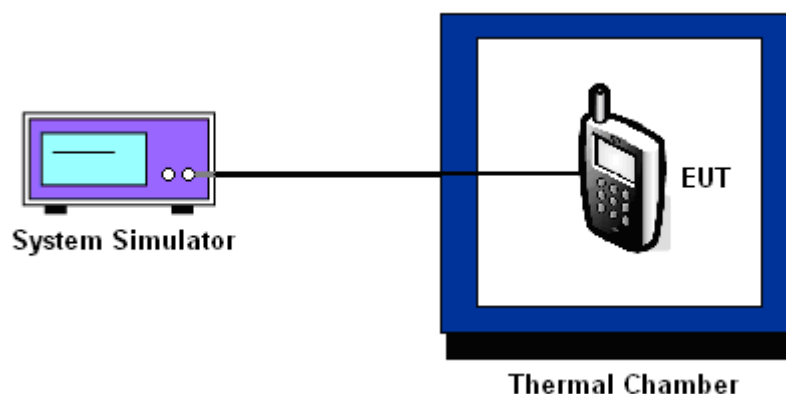



3.7.6 Test Result of Temperature Variation

Band :	GSM 850	Channel :	189
Limit (ppm) :	2.5		

Temperature (°C)	GSM		EDGE 8		Result
	Freq. Dev. (Hz)	Deviation (ppm)	Freq. Dev. (Hz)	Deviation (ppm)	
-30	N/A	N/A	N/A	N/A	PASS
-20	-44	-0.05	-41	-0.05	
-10	-41	-0.05	-42	-0.05	
0	-38	-0.04	-32	-0.04	
10	-23	-0.03	26	0.03	
20	-11	-0.01	-16	-0.02	
30	-19	-0.02	32	0.04	
40	-20	-0.02	-25	-0.03	
50	-42	-0.05	-40	-0.05	

Note: The manufacturer declared that the EUT could work properly between temperatures -20°C~55°C.

Band :	GSM 1900	Channel :	661
Limit (ppm) :	2.5		

Temperature (°C)	GSM		EDGE 10		Result
	Freq. Dev. (Hz)	Deviation (ppm)	Freq. Dev. (Hz)	Deviation (ppm)	
-30	N/A	N/A	N/A	N/A	PASS
-20	-54	-0.03	-66	-0.03	
-10	-53	-0.03	-67	-0.04	
0	-58	-0.03	-73	-0.04	
10	-52	-0.03	-45	-0.02	
20	-44	-0.02	-23	-0.01	
30	-35	-0.02	-38	-0.02	
40	-42	-0.02	-28	-0.01	
50	-65	-0.03	-74	-0.04	

Note: The manufacturer declared that the EUT could work properly between temperatures -20°C~55°C.



3.7.7 Test Result of Voltage Variation

Band & Channel	Mode	Voltage (Volt)	Freq. Dev. (Hz)	Deviation (ppm)	Limit (ppm)	Result
GSM 850 CH189	GSM	3.8	-33	-0.04	2.5	PASS
		BEP	-30	-0.04		
		4.2	-29	-0.03		
	EDGE 8	3.8	-30	-0.04		
		BEP	-37	-0.04		
		4.2	-28	-0.03		
GSM 1900 CH661	GSM	3.8	-55	-0.03		
		BEP	-59	-0.03		
		4.2	-53	-0.03		
	EDGE 10	3.8	-73	-0.04		
		BEP	-80	-0.04		
		4.2	-77	-0.04		

Note:

- 1. Normal Voltage = 3.8V.
- 2. Battery End Point (BEP) = 3.5 V.



4 List of Measuring Equipment

Instrument	Manufacturer	Model No.	Serial No.	Characteristics	Calibration Date	Due Date	Remark
System Simulator	R&S	CMU200	116456	N/A	Jun. 05, 2008	Jun. 04, 2010	Conducted (TH02-HY)
Spectrum Analyzer	R&S	FSP40	100055	9kHz~40GHz	Jun. 23, 2009	Jun. 22, 2010	Conducted (TH02-HY)
Thermal Chamber	TEN BILLION	TTH-D35P	TBN-930701	N/A	Jul. 29, 2009	Jul. 28, 2010	Conducted (TH02-HY)
Bilog Antenna	SCHAFFNER	CBL6111C	2726	30MHz ~ 1GHz	Nov. 20, 2008	Nov. 19, 2009	Radiation (03CH07-HY)
Spectrum Analyzer	R&S	FSP	101067	9KHz ~ 30GHz	Dec. 02, 2008	Dec. 01, 2009	Radiation (03CH07-HY)
Double Ridge Horn Antenna	ESCO	3117	00075962	1GHz ~ 18GHz	Aug. 20, 2009	Aug. 19, 2010	Radiation (03CH07-HY)
Double Ridge Horn Antenna	ESCO	3117	66584	1GHz ~ 18GHz	Aug. 05, 2009	Aug. 04, 2010	Radiation (03CH07-HY)
SHF-EHF Horn Antenna	SCHWARZBECK	BBHA 9170	BBHA9170251	15GHz- 40GHz	Oct. 16, 2008	Oct. 15, 2009	Radiation (03CH07-HY)
Pre Amplifier	Agilent	8449B	3008A02362	1GHz~ 26.5GHz	Dec. 17, 2008	Dec. 16, 2009	Radiation (03CH07-HY)
Pre Amplifier	COM-POWER	PA-103A	161241	10-1000MHz.32dB. GAIN	Mar. 27, 2009	Mar. 26, 2010	Radiation (03CH07-HY)
Loop Antenna	R&S	HFH2-Z2	860004/001	9 KHz~30 MHz	May 22, 2008	May 21, 2010	Radiation (03CH07-HY)
System Simulator	R&S	CMU200	117997	N/A	May 14, 2009	May 13, 2011	Radiation (03CH07-HY)
Bluetooth Base Station	Anritsu	MT8852B	6K00005722	N/A	Oct. 23, 2007	Oct. 22, 2009	Radiation (03CH07-HY)

5 Uncertainty of Evaluation

Uncertainty of Radiated Emission Measurement (30 MHz ~ 1000 MHz)

Contribution	Uncertainty of X_i		$u(X_i)$
	dB	Probability Distribution	
Receiver Reading	0.41	Normal (k=2)	0.21
Antenna Factor Calibration	0.83	Normal (k=2)	0.42
Cable Loss Calibration	0.25	Normal (k=2)	0.13
Pre-Amplifier Gain Calibration	0.27	Normal (k=2)	0.14
RCV/SPA Specification	2.50	Rectangular	0.72
Antenna Factor Interpolation for Frequency	1.00	Rectangular	0.29
Site Imperfection	1.43	Rectangular	0.83
Mismatch	+0.39 / -0.41	U-Shape	0.28
Combined Standard Uncertainty $U_c(y)$	1.27		
Measuring Uncertainty for a Level of Confidence of 95% ($U = 2U_c(y)$)	2.54		

Uncertainty of Radiated Emission Measurement (1 GHz ~ 40 GHz)

Contribution	Uncertainty of X_i		$u(X_i)$	C_i	$C_i * u(X_i)$
	dB	Probability Distribution			
Receiver Reading	± 0.10	Normal (k=2)	0.10	1	0.10
Antenna Factor Calibration	± 1.70	Normal (k=2)	0.85	1	0.85
Cable Loss Calibration	± 0.50	Normal (k=2)	0.25	1	0.25
Receiver Correction	± 2.00	Rectangular	1.15	1	1.15
Antenna Factor Directional	± 1.50	Rectangular	0.87	1	0.87
Site Imperfection	± 2.80	Triangular	1.14	1	1.14
Mismatch Receiver VSWR $\Gamma_1 = 0.197$ Antenna VSWR $\Gamma_2 = 0.194$ Uncertainty = $20\text{Log}(1-\Gamma_1*\Gamma_2)$	+0.34 / -0.35	U-Shape	0.244	1	0.244
Combined Standard Uncertainty $U_c(y)$	2.36				
Measuring Uncertainty for a Level of Confidence of 95% ($U = 2U_c(y)$)	4.72				

6 Certification of TAF Accreditation



Certificate No. : L1190-090417

財團法人全國認證基金會
Taiwan Accreditation Foundation

Certificate of Accreditation

This is to certify that

Sporton International Inc.
EMC & Wireless Communications Laboratory
No.52, Hwa Ya 1st Rd., Hwa Ya Technology Park, Kwei-Shan Hsiang, Tao Yuan Hsien,
Taiwan, R.O.C.

is accredited in respect of laboratory

Accreditation Criteria	: ISO/IEC 17025:2005
Accreditation Number	: 1190
Originally Accredited	: December 15, 2003
Effective Period	: January 10, 2007 to January 09, 2010
Accredited Scope	: Testing Field, see described in the Appendix
Specific Accreditation Program	: Accreditation Program for Designated Testing Laboratory for Commodities Inspection Accreditation Program for Telecommunication Equipment Testing Laboratory Accreditation Program for BSMI Mutual Recognition Arrangement with Foreign Authorities

Jay-San Chen

Jay-San Chen
President, Taiwan Accreditation Foundation
Date : April 17, 2009

P1, total 20 pages

The Appendix forms an integral part of this Certificate, which shall be invalid when use without the Appendix



Appendix A. Photographs of EUT

Please refer to Sporton report number EP972007-01 as below.