

FCC RF Test Report

APPLICANT : Acer Incorporated
EQUIPMENT : Smart HandHeld
BRAND NAME : Acer
MODEL NAME : E101
FCC ID : HLZDME101
STANDARD : FCC Part 15 Subpart C §15.247
CLASSIFICATION : Digital Spread Spectrum (DSS)

The product was received on Aug. 13, 2009 and completely tested on Oct. 11, 2009. We, SPORTON INTERNATIONAL INC., would like to declare that the tested sample has been evaluated in accordance with the procedures given in ANSI C63.4-2003 and shown the compliance with the applicable technical standards.

The test results in this report apply exclusively to the tested model / sample. Without written approval of SPORTON INTERNATIONAL INC., the test report shall not be reproduced except in full.

Reviewed by:

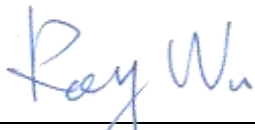

Roy Wu / Manager



SPORTON INTERNATIONAL INC.

No. 52, Hwa Ya 1st Rd., Hwa Ya Technology Park, Kwei-Shan Hsiang, Tao Yuan Hsien, Taiwan, R.O.C.



TABLE OF CONTENTS

REVISION HISTORY.....3

SUMMARY OF TEST RESULT4

1 GENERAL DESCRIPTION.....5

 1.1 Applicant.....5

 1.2 Manufacturer.....5

 1.3 Feature of Equipment Under Test.....5

 1.4 Testing Site.....7

 1.5 Applied Standards7

 1.6 Ancillary Equipment List7

2 TEST CONFIGURATION OF EQUIPMENT UNDER TEST.....8

 2.1 RF Output Power.....8

 2.2 Test Mode.....9

 2.3 Connection Diagram of Test System.....10

 2.4 RF Utility10

3 TEST RESULT11

 3.1 Number of Channel Measurement11

 3.2 20dB Bandwidth Measurement13

 3.3 Hopping Channel Separation Measurement20

 3.4 Dwell Time Measurement.....23

 3.5 Peak Output Power Measurement25

 3.6 Band Edges Measurement.....28

 3.7 AC Conducted Emission Measurement.....31

 3.8 Radiated Emission Measurement.....35

 3.9 Antenna Requirements.....44

4 LIST OF MEASURING EQUIPMENT.....45

5 UNCERTAINTY OF EVALUATION.....46

6 CERTIFICATION OF TAF ACCREDITATION48

APPENDIX A. PHOTOGRAPHS OF EUT

APPENDIX B. SETUP PHOTOGRAPHS



SUMMARY OF TEST RESULT

Report Section	FCC Rule	IC Rule	Description	Limit	Result	Remark
3.1	15.247(a)(1)	A8.4(2)	Number of Channels	≥ 15Chs	Pass	
3.2	15.247(a)(1)	A8.1(a)	20dB Bandwidth	NA	Pass	-
3.3	15.247(a)(1)	A8.1(b)	Channel Separation	≥ 2/3 of 20dB BW	Pass	-
3.4	15.247(a)(1)	A8.1(d)	Dwell Time of Each Channel	≤ 0.4sec in 31.6sec period	Pass	-
3.5	15.247(b)(1)	A8.1(b)	Peak Output Power	≤ 1W	Pass	-
3.6	15.247(d)	A8.5	Frequency Band Edges	≤ 20dBc	Pass	-
3.7	15.207	Gen 7.2.2	AC Conducted Emission	15.207(a)	Pass	Under limit 8.2 dB at 0.310000 MHz
3.8	15.247(d)	A8.5	Transmitter Radiated Emission	15.209(a) & 15.247(d)	Pass	Under limit 4.93 dB at 2483.50 MHz
3.9	15.203 & 15.247(b)	A8.4	Antenna Requirement	N/A	Pass	-



1 General Description

1.1 Applicant

Acer Incorporated

8F., No. 88, Sec. 1, Hsin Tai Wu Rd. Hsichih Taipei Hsien 221, Taiwan

1.2 Manufacturer

Inventec Appliances (Pudong) Corporation

No.789, Puxing Rd., Minhang District, Shanghai, P.R.C.

1.3 Feature of Equipment Under Test

Product Feature & Specification	
Equipment	Smart HandHeld
Brand Name	Acer
Model Name	E101
FCC ID	HLZDME101
Tx/Rx Frequency Range	2400 MHz ~ 2483.5 MHz
Number of Channels	79
Carrier Frequency of Each Channel	2402+n*1 MHz; n=0~78
Channel Spacing	1 MHz
Maximum Output Power to Antenna	Bluetooth (1Mbps) : -0.12 dBm (0.97 mW) Bluetooth EDR (2Mbps) : -0.24 dBm (0.95 mW) Bluetooth EDR (3Mbps) : -0.45 dBm (0.90 mW)
Antenna Type	Monopole Antenna with gain -0.49 dBi
HW Version	D20
SW Version	Acer_E101_0.017.01_EN
Type of Modulation	Bluetooth (1Mbps) : GFSK Bluetooth EDR (2Mbps) : π /4-DQPSK Bluetooth EDR (3Mbps) : 8-DPSK
EUT Stage	Identical Prototype

Remark:

1. For other wireless features of this EUT, test report will be issued separately.
2. This test report recorded only product characteristics and test results of Digital Spread Spectrum (DSS).



List of Accessory:

Specification of Accessory		
AC Adapter	Brand Name	PHIHONG
	Model Name	PSAC05R-050
	Power Rating	I/P:100-240Vac, 50-60Hz, 0.3A; O/P: 5Vdc, 1A
	DC Power Cord Type	1.5 meter non-shielded cable without ferrite core
Battery	Brand Name	Acer
	Model Name	A7BTA040H
	Part Number	BT.00107.004
	Power Rating	3.7Vdc, 1140mAh, 4.218Wh
	Type	Li-ion
Earphone	Brand Name	Merry
	Model Name	EMC292-002-02
	Signal Line Type	1.4 meter non-shielded cable without ferrite core
USB Cable	Brand Name	PHIHONG
	Model Name	DCM1000(AI-H)
	Signal Line Type	1.0 meter shielded cable without ferrite core
LCD Panel	Brand Name	CHIMEI
	Model Name	LT320AC9009

Remark:

1. The above EUT's information was declared by manufacturer. Please refer to the specifications or user's manual for more detailed description.
2. For accessories equipped with this EUT, please refer to the appendix of the external photo.

1.4 Testing Site

Test Site	SPORTON INTERNATIONAL INC.		
Test Site Location	No. 52, Hwa Ya 1 st Rd., Hwa Ya Technology Park, Kwei-Shan Hsiang, Tao Yuan Hsien, Taiwan, R.O.C. TEL: +886-3-3273456 / FAX: +886-3-3284978		
Test Site No.	Sporton Site No.		FCC/IC Registration No.
	CO05-HY	03CH07-HY	TW1022/4086B-1

1.5 Applied Standards

According to the specifications of the manufacturer, the EUT must comply with the requirements of the following standards:

- ♦ FCC Part 15 Subpart C §15.247
- ♦ FCC Public Notice DA 00-705
- ♦ ANSI C63.4-2003
- ♦ IC RSS-210 Issue 7

Remark:

1. All test items were verified and recorded according to the standards and without any deviation during the test.
2. This EUT has also been tested and complied with the requirements of FCC Part 15, Subpart B (DoC), recorded in a separate test report.

1.6 Ancillary Equipment List

Item	Equipment	Trade Name	Model Name	FCC ID	Data Cable	Power Cord
1.	System Simulator	R&S	CMU 200	N/A	N/A	Unshielded, 1.8 m
2.	GPS Station	T&E	GS-50	N/A	N/A	Unshielded, 1.8 m
3.	Notebook	DELL	Vostro 1510	FCC DoC	N/A	AC I/P: Unshielded, 1.2 m DC O/P: Shielded, 1.8 m
4.	LCD Monitor	Lenovo	6135-AB1	FCC DoC	Shielded, 1.6 m	Unshielded, 1.8 m
5.	Bluetooth Earphone	Nokia	BH-102	PYAHS-107W	N/A	N/A
6.	iPod	Apple	A1285	FCC DoC	Shielded, 1.0 m	N/A

2 Test Configuration of Equipment Under Test

2.1 RF Output Power

Preliminary tests were performed in different data rate and recorded the RF output power in the following table:

Channel	Frequency	Bluetooth RF Output Power		
		Data Rate / Modulation		
		GFSK	π /4-DQPSK	8-DPSK
		1Mbps	2Mbps	3Mbps
Ch00	2402MHz	-0.12 dBm	-0.24 dBm	-0.45 dBm
Ch39	2441MHz	-0.54 dBm	-0.64 dBm	-1.01 dBm
Ch78	2480MHz	-0.53 dBm	-0.95 dBm	-1.24 dBm

Remark:

1. The data rate was set in 1Mbps for all the test items due to the highest RF output power.
2. The EUT is programmed to transmit signals continuously for all testing.

2.2 Test Mode

The EUT has been associated with peripherals pursuant to ANSI C63.4-2003 and configuration operated in a manner tended to maximize its emission characteristics in a typical application. Frequency range investigated: conduction (150 kHz to 30 MHz), radiation (9 kHz to the 10th harmonic of the highest fundamental frequency or to 40 GHz, whichever is lower).

Pre-scanned tests were conducted to determine the final configuration from all possible combinations.

The following tables are showing the test modes as the worst cases and recorded in this report.

Test Cases			
Test Item	Data Rate / Modulation		
	Bluetooth 1Mbps GFSK	Bluetooth EDR 2Mbps π /4-DQPSK	Bluetooth EDR 3Mbps 8-DPSK
Conducted TCs	Mode 1: CH00_2402 MHz Mode 2: CH39_2441 MHz Mode 3: CH78_2480 MHz	Mode 4: CH00_2402 MHz Mode 5: CH39_2441 MHz Mode 6: CH78_2480 MHz	Mode 7: CH00_2402 MHz Mode 8: CH39_2441 MHz Mode 9: CH78_2480 MHz
Radiated TCs	Mode 1: CH00_2402 MHz Mode 2: CH39_2441 MHz Mode 3: CH78_2480 MHz	N/A	N/A
AC Conducted Emission	Mode 1: GSM850 Idle + Bluetooth Link + GPS Rx + Camera + USB Cable (Link with Notebook)		
Remark: For radiated TCs, the data rate was set in 1Mbps due to the highest RF output power; only the data of these modes was reported.			

2.3 Connection Diagram of Test System

<Conducted Emission>

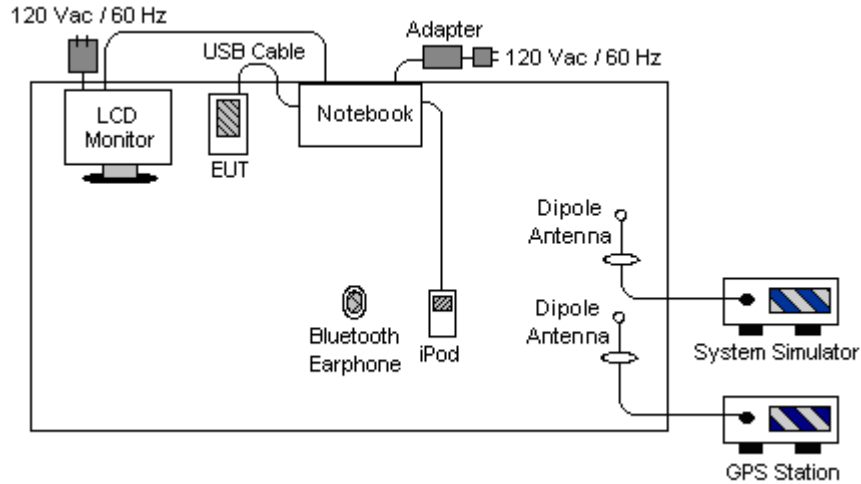

<Radiated Emission>

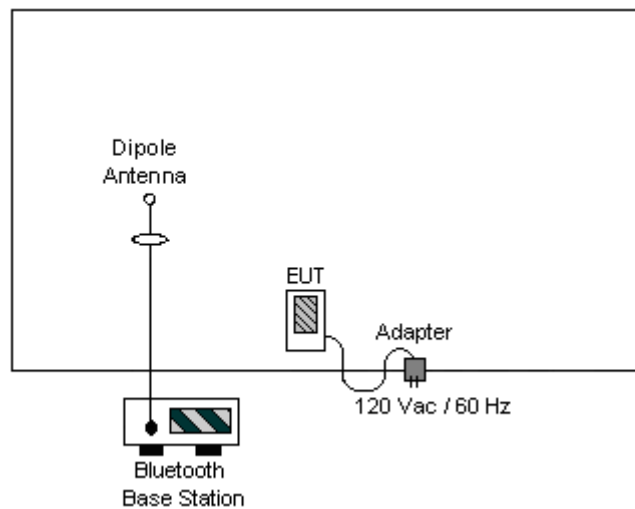

2.4 RF Utility

The RF utility, "PHM Regedit" was installed in EUT which was programmed in order to make the EUT into the engineering modes to contact with Bluetooth base station for transmitting and receiving signals continuously.

3 Test Result

3.1 Number of Channel Measurement

3.1.1 Limits of Number of Hopping Frequency

Frequency hopping systems in the 2400-2483.5 MHz band shall use at least 15 channels.

3.1.2 Measuring Instruments

See list of measuring instruments of this test report.

3.1.3 Test Procedure

1. The testing follows FCC Public Notice DA 00-705 Measurement Guidelines.
2. The RF output of EUT was connected to the spectrum analyzer by a low loss cable.
3. The modulation types of EUT are irrelevant to number of hopping channels deviation.
4. The EUT must have its hopping function enabled. Use the following spectrum analyzer settings:
Span = the frequency band of operation; $RBW \geq 1\%$ of the span; $VBW \geq RBW$; Sweep = auto;
Detector function = peak; Trace = max hold.
5. The number of hopping frequency used is defined as the device has the numbers of total channel.

3.1.4 Test Setup





3.1.5 Test Result of Number of Hopping Frequency

Test Mode :	Mode 1~3	Temperature :	26~28°C		
Test Engineer :	Tang Liu	Relative Humidity :	52~55%		
Number of Hopping Channels (Channel)		Limits (Channel)		Pass/Fail	
79		> 15		Pass	

Number of Hopping Channel Plot on Channel 00 - 78

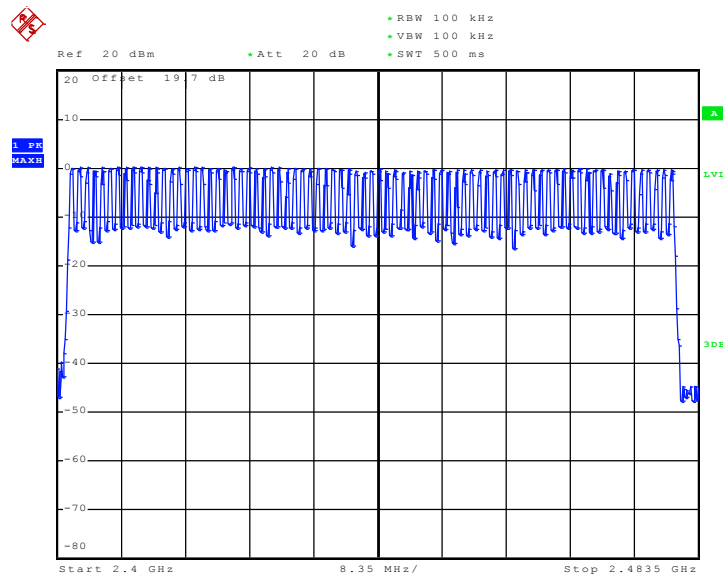

Date: 29.SEP.2009 18:07:08

3.2 20dB Bandwidth Measurement

3.2.1 Limit of 20dB Bandwidth

N/A

3.2.2 Measuring Instruments

See list of measuring instruments of this test report.

3.2.3 Test Procedures

1. The testing follows FCC Public Notice DA 00-705 Measurement Guidelines.
2. The RF output of EUT was connected to the spectrum analyzer by a low loss cable.
3. The EUT should be transmitting at its maximum data rate as the worst cases.
4. Use the following spectrum analyzer settings:
Span = approximately 2 to 3 times the 20 dB bandwidth, centered on a hopping channel;
RBW \geq 1% of the 20 dB bandwidth; VBW \geq RBW; Sweep = auto; Detector function = peak;
Trace = max hold.
5. The marker-delta reading at this point is the 20 dB bandwidth of the emission.

3.2.4 Test Setup

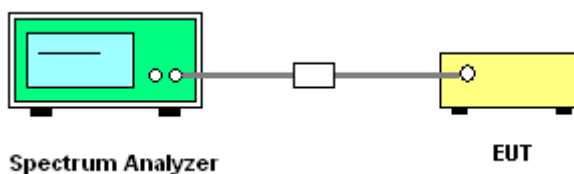



3.2.5 Test Result of 20dB Bandwidth

Test Mode :	Mode 1, 2, 3	Temperature :	26~28°C
Test Engineer :	Tang Liu	Relative Humidity :	52~55%

Channel	Frequency (MHz)	20dB Bandwidth (MHz)
00	2402	0.802
39	2441	0.804
78	2480	0.802

20 dB Bandwidth Plot on Channel 00

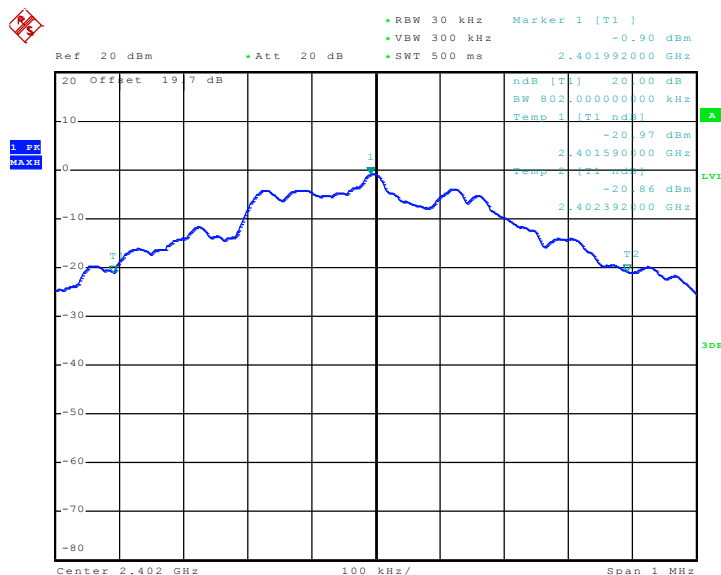

Date: 29.SEP.2009 15:22:44



20 dB Bandwidth Plot on Channel 39

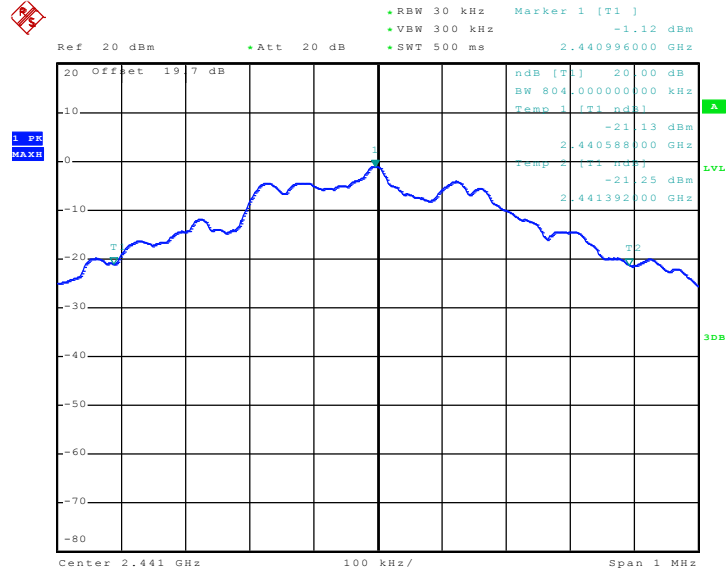

Date: 29.SEP.2009 15:22:09

20 dB Bandwidth Plot on Channel 78

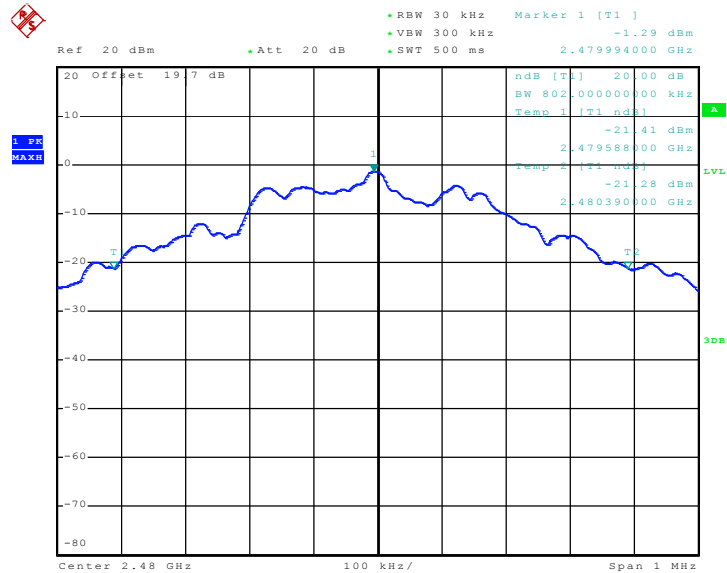

Date: 29.SEP.2009 15:21:28



Test Mode :	Mode 4, 5, 6	Temperature :	26~28°C
Test Engineer :	Tang Liu	Relative Humidity :	52~55%

Channel	Frequency (MHz)	20dB Bandwidth (MHz)
00	2402	1.236
39	2441	1.216
78	2480	1.216

20 dB Bandwidth Plot on Channel 00

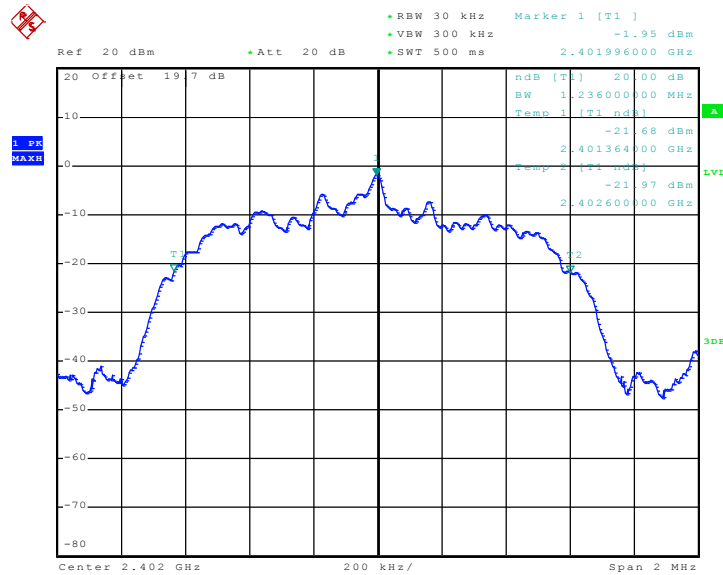

Date: 29.SEP.2009 15:19:51



20 dB Bandwidth Plot on Channel 39

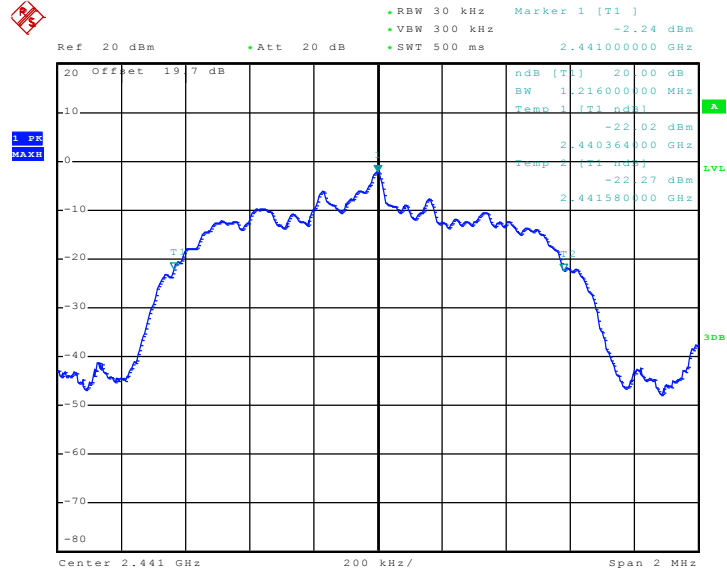

Date: 29.SEP.2009 15:20:22

20 dB Bandwidth Plot on Channel 78

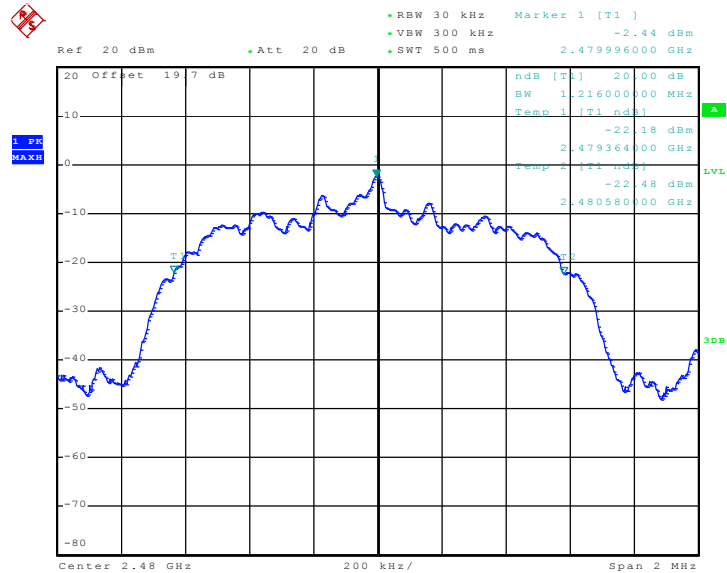

Date: 29.SEP.2009 15:20:53



Test Mode :	Mode 7, 8, 9	Temperature :	26~28°C
Test Engineer :	Tang Liu	Relative Humidity :	52~55%

Channel	Frequency (MHz)	20dB Bandwidth (MHz)
00	2402	1.260
39	2441	1.260
78	2480	1.260

20 dB Bandwidth Plot on Channel 00

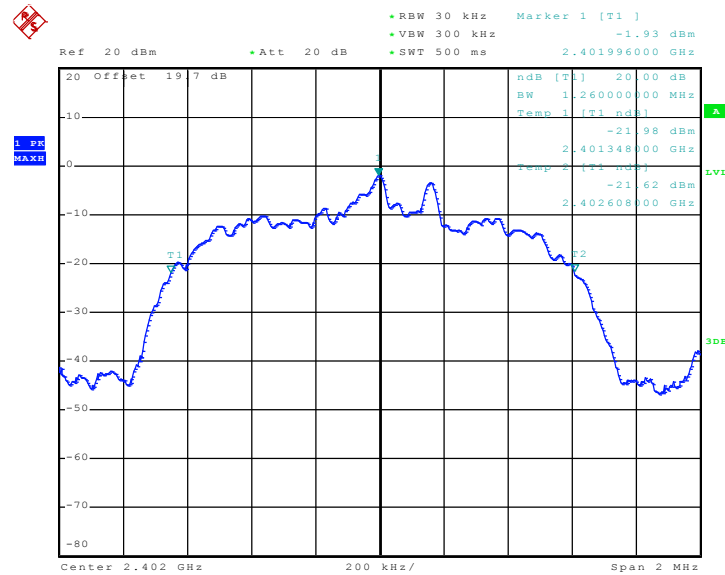

Date: 29.SEP.2009 15:19:24



20 dB Bandwidth Plot on Channel 39

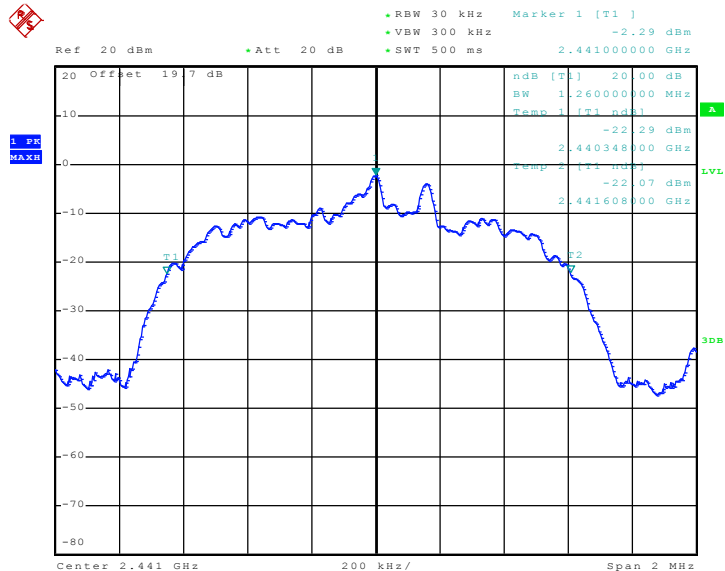

Date: 29.SEP.2009 15:18:58

20 dB Bandwidth Plot on Channel 78

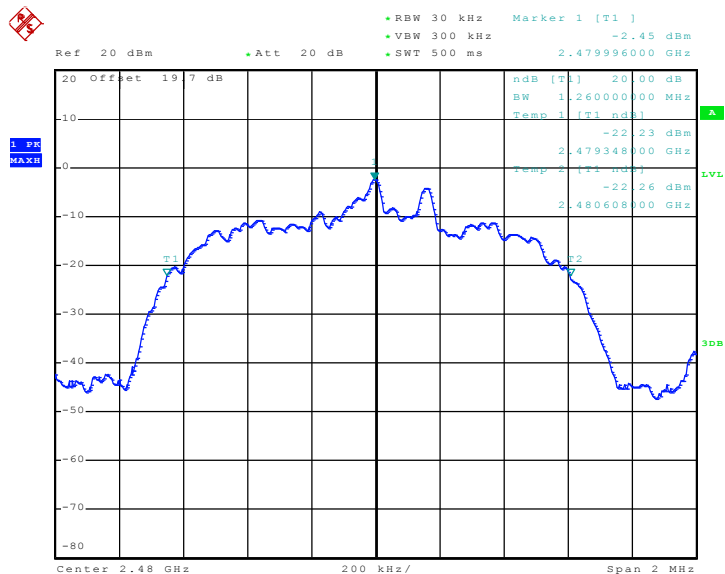

Date: 29.SEP.2009 15:18:16

3.3 Hopping Channel Separation Measurement

3.3.1 Limit of Hopping Channel Separation

Frequency hopping systems operating in the 2400-2483.5 MHz band may have hopping channel carrier frequencies that are separated by 25 kHz or two-thirds of the 20 dB bandwidth of the hopping channel, whichever is greater.

3.3.2 Measuring Instruments

See list of measuring instruments of this test report.

3.3.3 Test Procedures

1. Please refer FCC Public Notice DA 00-705 Measurement Guidelines.
2. The RF output of EUT was connected to the spectrum analyzer by a low loss cable.
3. The EUT should be transmitting at its maximum data rate as the worst cases.
4. Use the following spectrum analyzer settings:
Span = wide enough to capture the peaks of two adjacent channels; $RBW \geq 1\%$ of the span;
 $VBW \geq RBW$; Sweep = auto; Detector function = peak; Trace = max hold.
5. Use the marker-delta function to determine the separation between the peaks of the adjacent channels.

3.3.4 Test Setup

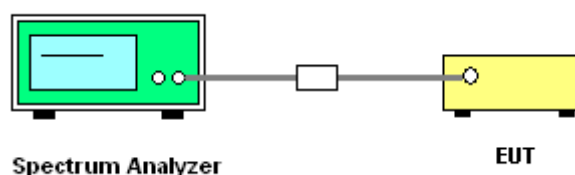



3.3.5 Test Result of Hopping Channel Separation

Test Mode :	Mode 1	Temperature :	26~28°C
Test Engineer :	Tang Liu	Relative Humidity :	52~55%

Channel	Frequency (MHz)	Frequency Separation (MHz)	(2/3 of 20dB BW) Limits (MHz)	Pass/Fail
00	2402	1.000	0.535	Pass
39	2441	1.004	0.536	Pass
78	2480	1.000	0.535	Pass

Channel Separation Plot on Channel 00 - 01

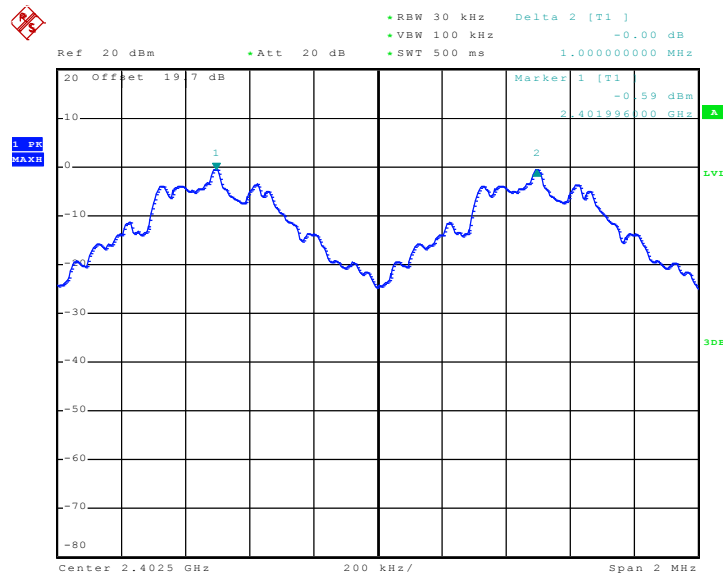

Date: 29.SEP.2009 15:55:10



Channel Separation Plot on Channel 39 - 40

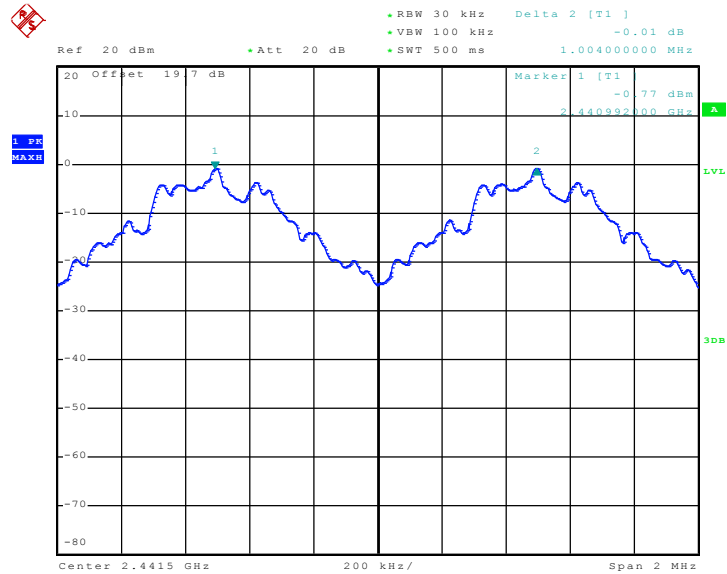

Date: 29.SEP.2009 15:48:48

Channel Separation Plot on Channel 77 - 78

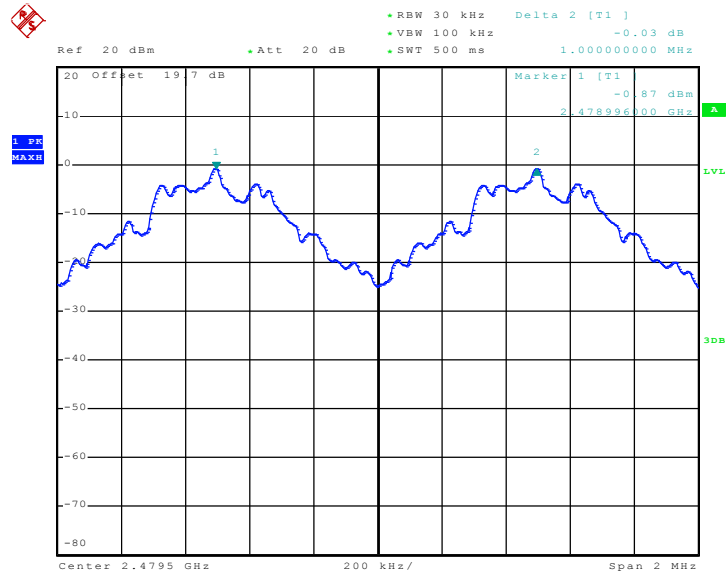

Date: 29.SEP.2009 15:47:37

3.4 Dwell Time Measurement

3.4.1 Limit of Dwell Time

The average time of occupancy on any channel shall not be greater than 0.4 seconds within a period of 0.4 seconds multiplied by the number of hopping channels employed.

3.4.2 Measuring Instruments

See list of measuring instruments of this test report.

3.4.3 Test Procedures

1. The testing follows FCC Public Notice DA 00-705 Measurement Guidelines.
2. The RF output of EUT was connected to the spectrum analyzer by a low loss cable.
3. The EUT should be transmitting at its maximum data rate as the worst cases.
4. The EUT must have its hopping function enabled. Use the following spectrum analyzer settings:
Span = zero span, centered on a hopping channel; RBW = 1 MHz; VBW ≥ RBW; Sweep = as necessary to capture the entire dwell time per hopping channel; Detector function = peak; Trace = max hold.
5. Use the marker-delta function to calculate the dwell time.

3.4.4 Test Setup

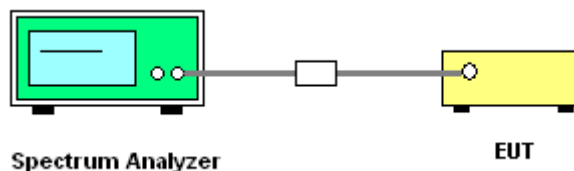

3.4.5 Test Result of Dwell Time

Test Mode :	Mode 1	Temperature :	26~28°C
Test Engineer :	Tang Liu	Relative Humidity :	52~55%

Package Mode	Average Hopping Channel	Package Transfer Time (usec)	Dwell Time (sec)	Limits (sec)	Pass/Fail
DH5	3.20	2980.00	0.30	0.4	Pass

Remark:

1. Dwell Time=79(channels) x 0.4(s) x average hopping channel x package transfer time
2. 79 channels come from the Hopping Channel number.
3. Average Hopping Channel = hops/sweep time
4. t: Package Transfer Time(us)



DH5 Dwell Time (One Pulse) Plot on Channel 39

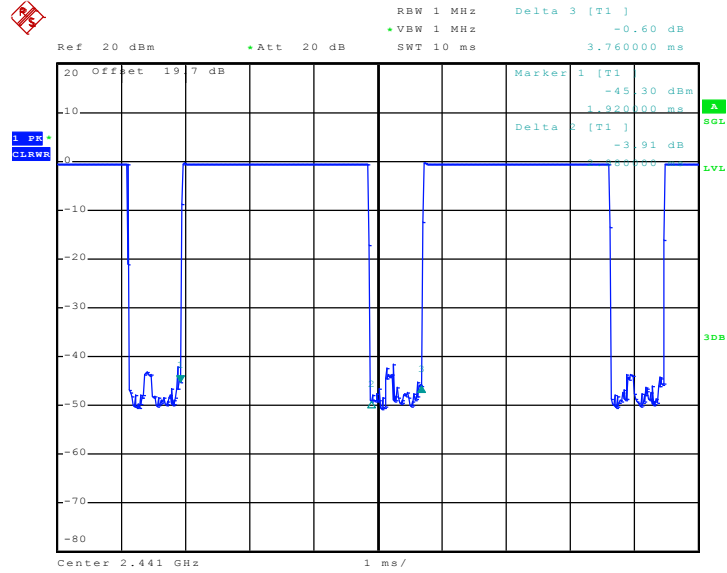

Date: 29.SEP.2009 16:06:19

DH5 Dwell Time (Count Pulses) Plot on Channel 39

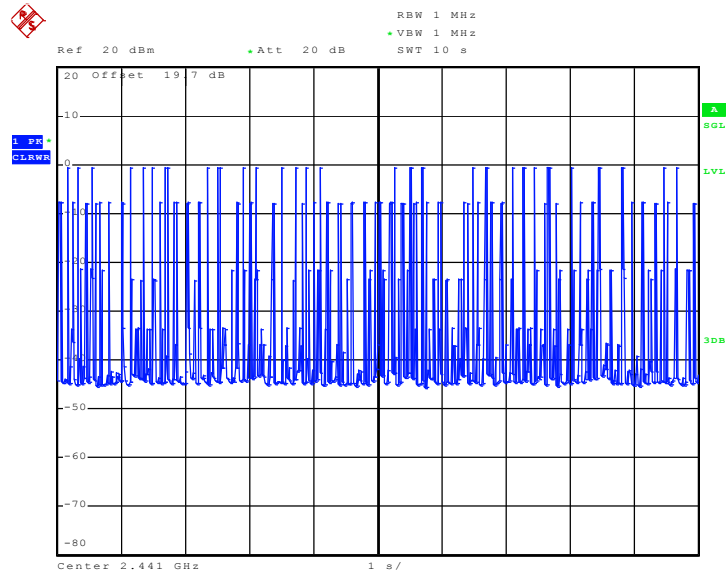

Date: 29.SEP.2009 16:21:05

3.5 Peak Output Power Measurement

3.5.1 Limit of Peak Output Power

Frequency hopping systems operating in the 2400-2483.5 MHz band employing at least 75 non-overlapping hopping channels: 1W (30 dBm).

3.5.2 Measuring Instruments

See list of measuring instruments of this test report.

3.5.3 Test Procedures

1. The testing follows FCC Public Notice DA 00-705 Measurement Guidelines.
2. The RF output of EUT was connected to the spectrum analyzer by a low loss cable.

3.5.4 Test Setup

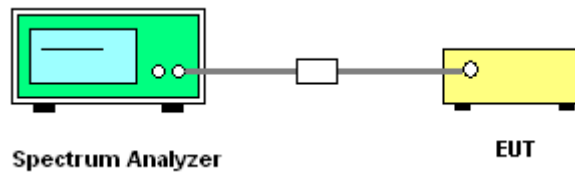

3.5.5 Test Result of Peak Output Power

Test Mode :	Mode 1	Temperature :	26~28°C
Test Engineer :	Tang Liu	Relative Humidity :	52~55%

Channel	Frequency (MHz)	RF Power (dBm)		
		GFSK	Max. Limits (dBm)	Pass/Fail
		1 Mbps		
00	2402	-0.12	30	Pass
39	2441	-0.54	30	Pass
78	2480	-0.53	30	Pass



Peak Output Power Plot on Channel 00

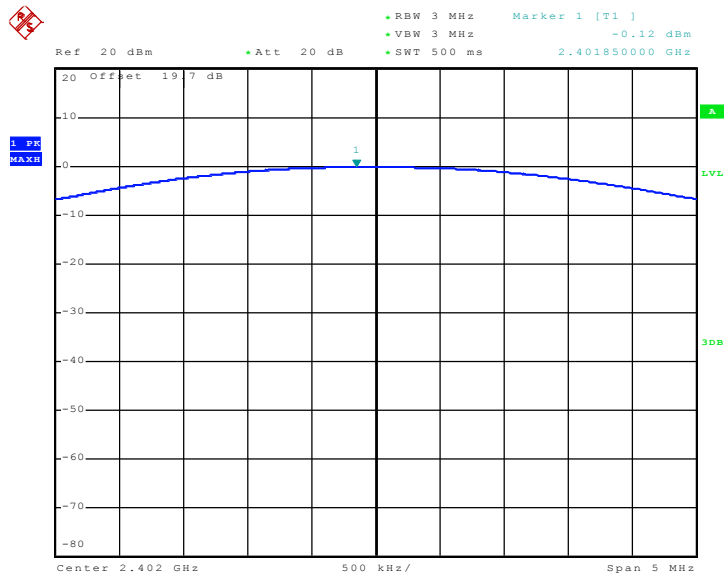

Date: 29.SEP.2009 14:47:01

Peak Output Power Plot on Channel 39

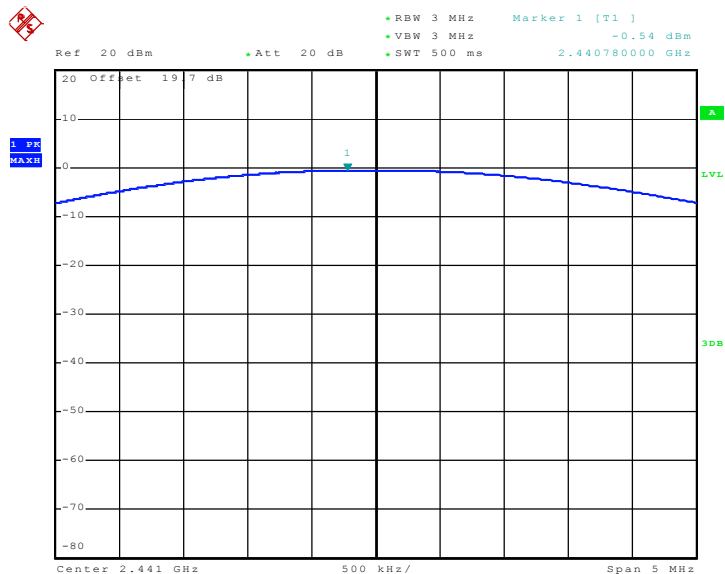

Date: 29.SEP.2009 14:56:15



Peak Output Power Plot on Channel 78

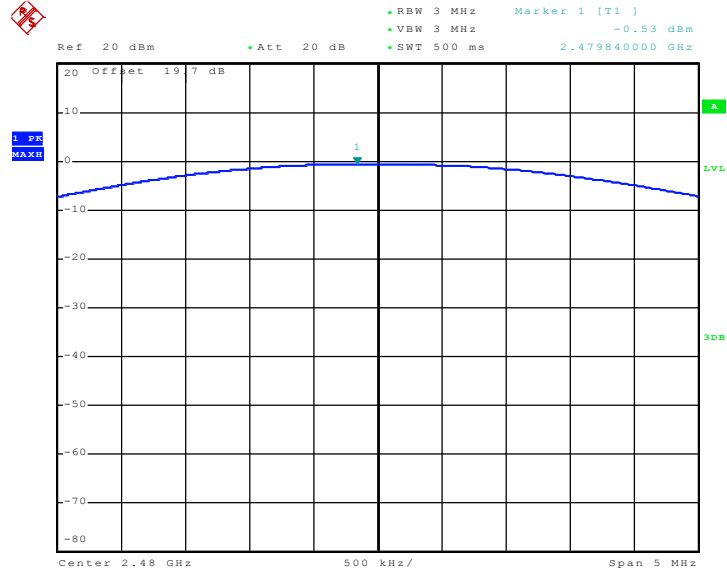

Date: 29.SEP.2009 14:57:14

3.6 Band Edges Measurement

3.6.1 Limit of Band Edges

In any 100 kHz bandwidth outside the intentional radiation frequency band, the radio frequency power shall be at least 20 dB below the highest level of the radiated power. In addition, radiated emissions which fall in the restricted bands must also comply with the radiated emission limits.

3.6.2 Measuring Instruments

See list of measuring instruments of this test report.

3.6.3 Test Procedures

1. The testing follows the guidelines in ANSI C63.4-2003 and FCC Public Notice DA 00-705 Measurement Guidelines.
2. RF antenna conducted test: Set RBW = 1MHz, Video bandwidth (VBW) \geq RBW. Band edge emissions must be at least 20 dB down from the highest emission level within the authorized band as measured with a 1MHz RBW. Note: If the device complies with the use of power option 2 the attenuation under this paragraph shall be 30 dB instead of 20 dB.
3. Radiated emission test: Applies to band edge emissions that fall in the restricted bands listed in FCC Section 15.205. The maximum permitted average field strength is listed in FCC Section 15.209. A pre-amp is necessary for this measurement. For measurements above 1 GHz, set RBW = 1MHz, VBW = 1MHz, Sweep: Auto for Peak; set RBW = 1MHz, VBW = 10 Hz, Sweep: Auto for Average. If the emission is pulsed, modify the unit for continuous operation; use the settings shown above, then correct the reading by subtracting the peak-average correction factor, derived from the appropriate duty cycle calculation. See FCC Section 15.35(b) and (c).
4. In case the emission is fail due to the used RBW / VBW is too wide, marker-delta method of FCC Public Notice DA 00-705 will be followed.

3.6.4 Test Setup

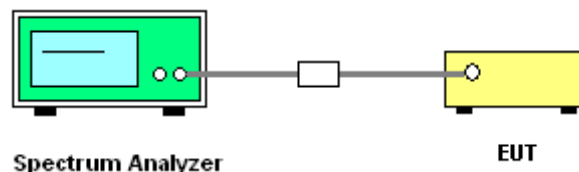



3.6.5 Test Result of Radiated Band Edges

Test Mode :	Mode 1	Temperature :	25~26°C
Test Channel :	00	Relative Humidity :	39~40%
		Test Engineer :	Kay Wu

ANTENNA POLARITY : HORIZONTAL										
Frequency (MHz)	Level (dBuV/m)	Over Limit (dB)	Limit Line (dBuV/m)	Read Level (dBuV)	Antenna Factor (dB)	Cable Loss (dB)	Preamp Factor (dB)	Ant Pos (cm)	Table Pos (deg)	Remark
2389.99	46.00	-28.00	74.00	42.79	32.13	5.46	34.38	105	349	Peak
2389.99	34.62	-19.38	54.00	31.41	32.13	5.46	34.38	105	349	Average

ANTENNA POLARITY : VERTICAL										
Frequency (MHz)	Level (dBuV/m)	Over Limit (dB)	Limit Line (dBuV/m)	Read Level (dBuV)	Antenna Factor (dB)	Cable Loss (dB)	Preamp Factor (dB)	Ant Pos (cm)	Table Pos (deg)	Remark
2311.33	45.05	-28.95	74	41.89	32.00	5.53	34.36	100	267	Peak
2311.33	32.94	-21.06	54	29.78	32.00	5.53	34.36	100	267	Average

Test Mode :	Mode 3	Temperature :	25~26°C
Test Channel :	78	Relative Humidity :	39~40%
		Test Engineer :	Kay Wu

ANTENNA POLARITY : HORIZONTAL										
Frequency (MHz)	Level (dBuV/m)	Over Limit (dB)	Limit Line (dBuV/m)	Read Level (dBuV)	Antenna Factor (dB)	Cable Loss (dB)	Preamp Factor (dB)	Ant Pos (cm)	Table Pos (deg)	Remark
2483.5	62.47	-11.53	74.00	59.21	32.27	5.38	34.40	103	347	Peak
2483.5	49.07	-4.93	54.00	45.81	32.27	5.38	34.4	103	347	Average

ANTENNA POLARITY : VERTICAL										
Frequency (MHz)	Level (dBuV/m)	Over Limit (dB)	Limit Line (dBuV/m)	Read Level (dBuV)	Antenna Factor (dB)	Cable Loss (dB)	Preamp Factor (dB)	Ant Pos (cm)	Table Pos (deg)	Remark
2483.5	56.98	-17.02	74.00	53.72	32.27	5.38	34.40	128	13	Peak
2483.5	44.05	-9.95	54.00	40.79	32.27	5.38	34.40	128	13	Average



3.6.6 Test Result of Conducted Band Edges

Test Mode :	Mode 1 and 3	Temperature :	26~28°C
Test Channel :	00 and 78	Relative Humidity :	52~55%
		Test Engineer :	Tang Liu

Low Band Edge Plot on Channel 00

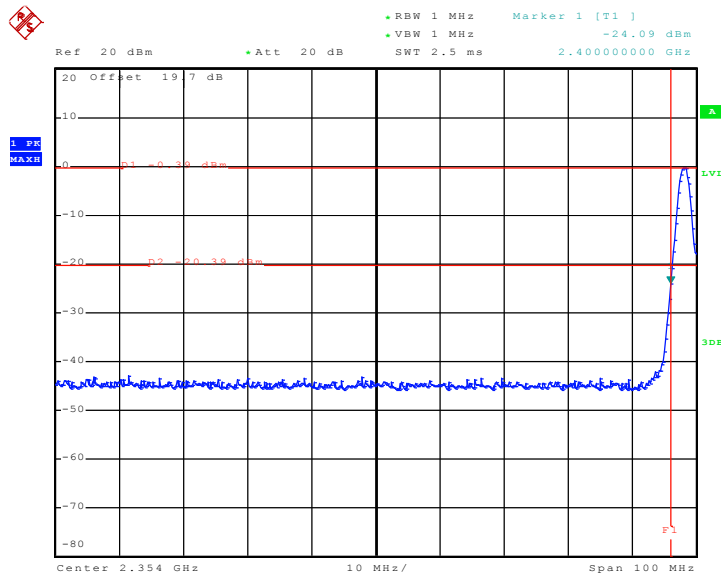

Date: 11.OCT.2009 16:33:56

High Band Edge Plot on Channel 78

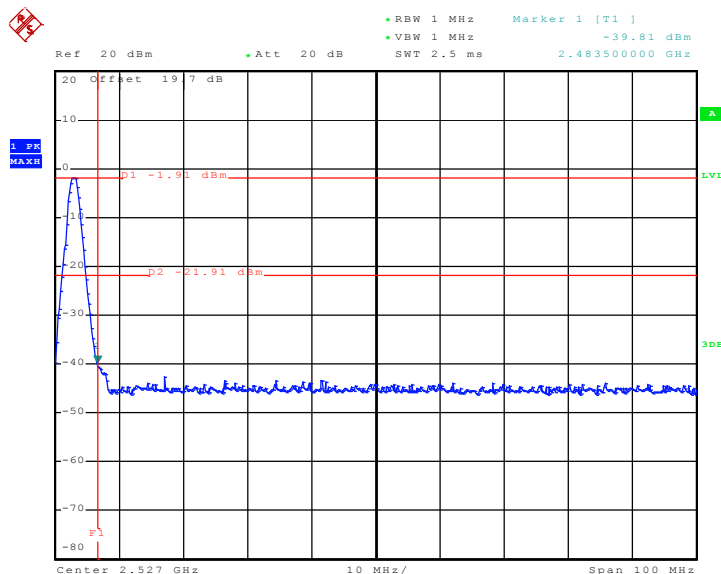

Date: 11.OCT.2009 16:05:48

3.7 AC Conducted Emission Measurement

3.7.1 Limit of AC Conducted Emission

For equipment that is designed to be connected to the public utility (AC) power line, the radio frequency voltage that is conducted back onto the AC power line on any frequency or frequencies within the band 150 kHz to 30 MHz shall not exceed the limits in the following table.

Frequency of emission (MHz)	Conducted limit (dBuV)	
	Quasi-peak	Average
0.15-0.5	66 to 56*	56 to 46*
0.5-5	56	46
5-30	60	50

*Decreases with the logarithm of the frequency.

3.7.2 Measuring Instruments

See list of measuring instruments of this test report.

3.7.3 Test Procedures

1. Please follow the guidelines in ANSI C63.4-2003.
2. The EUT was placed 0.4 meter from the conducting wall of the shielding room was kept at least 80 centimeters from any other grounded conducting surface.
3. Connect EUT to the power mains through a line impedance stabilization network (LISN).
4. All the support units are connecting to the other LISN.
5. The LISN provides 50 ohm coupling impedance for the measuring instrument.
6. The FCC states that a 50 ohm, 50 microhenry LISN should be used.
7. Both sides of AC line were checked for maximum conducted interference.
8. The frequency range from 150 kHz to 30 MHz was searched.
9. Set the test-receiver system to Peak Detect Function and specified bandwidth with Maximum Hold Mode.

3.7.4 Test Setup

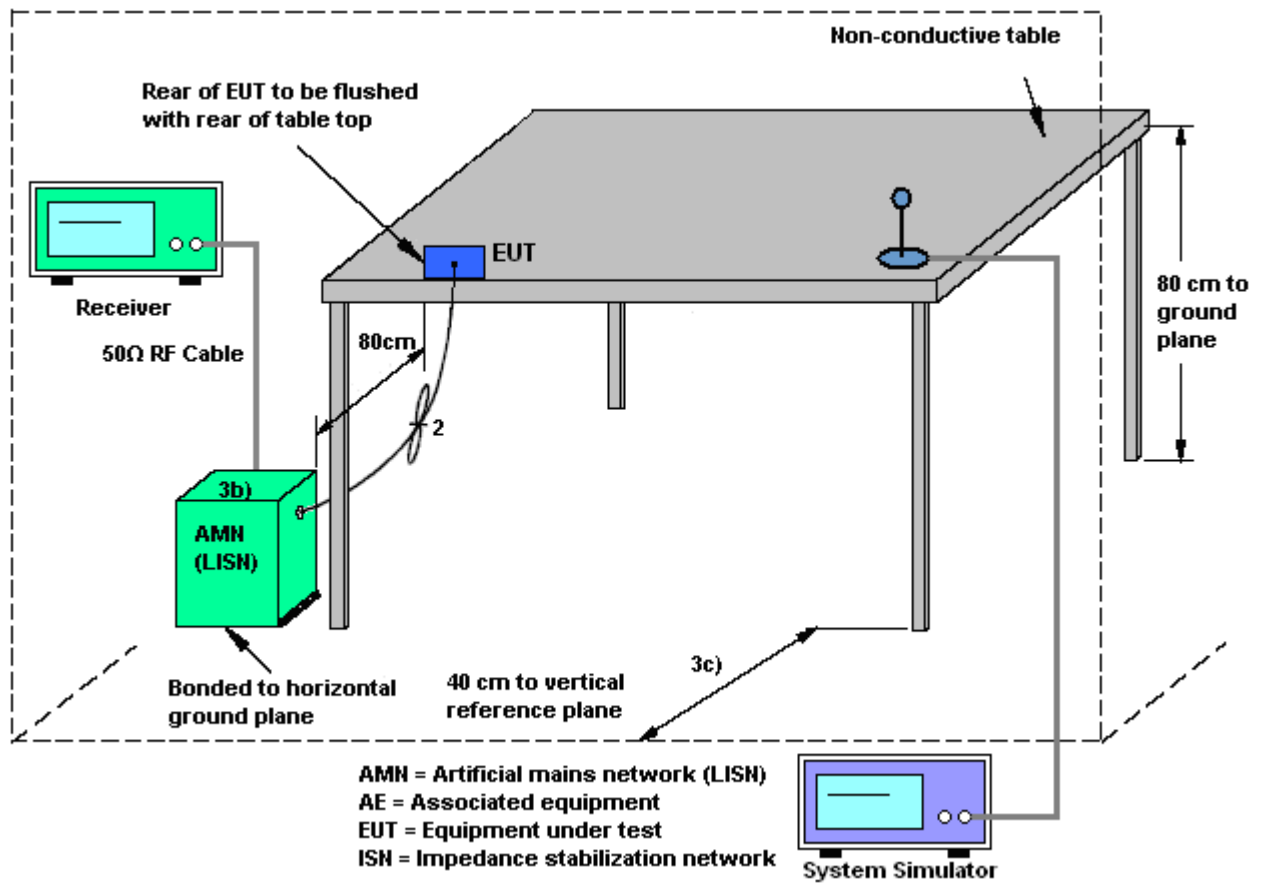

3.7.5 Test Result of AC Conducted Emission

Test Mode :	Mode 1	Temperature :	24~25°C
Test Engineer :	Cona Huang	Relative Humidity :	49~53%
Test Voltage :	120Vac / 60Hz	Phase :	Line
Function Type :	GSM850 Idle + Bluetooth Link + GPS Rx + Camera + USB Cable (Link with Notebook)		
Remark :	All emissions not reported here are more than 10 dB below the prescribed limit.		

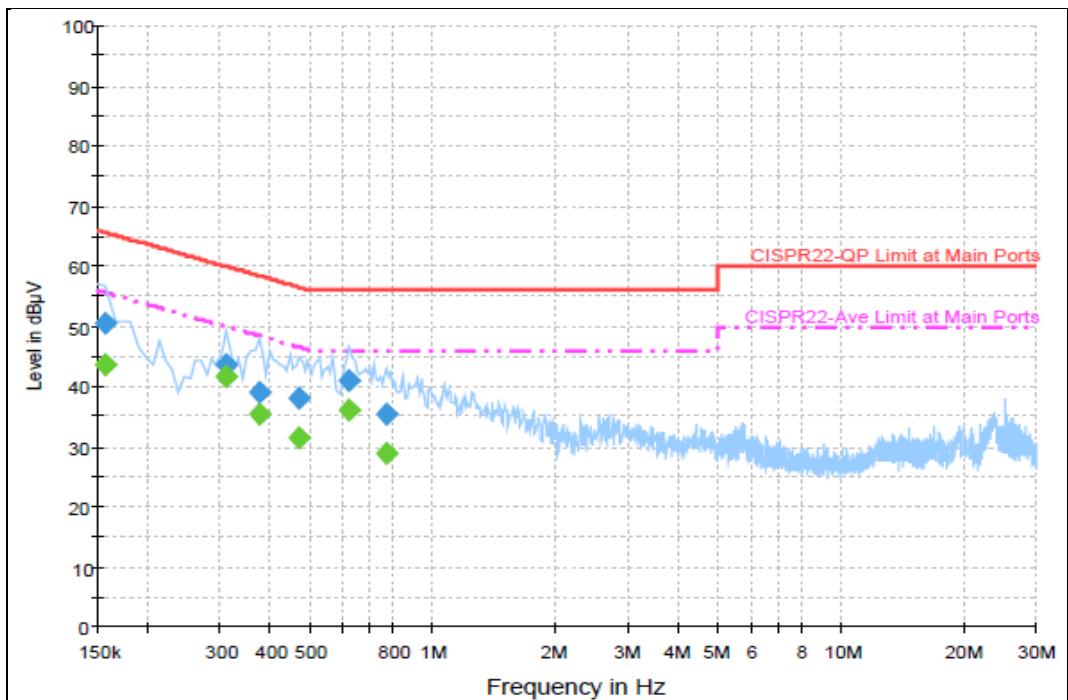

Final Result 1

Frequency (MHz)	QuasiPeak (dBµV)	Filter	Line	Corr. (dB)	Margin (dB)	Limit (dBµV)
0.158000	50.4	Off	L1	19.5	15.2	65.6
0.310000	43.4	Off	L1	19.4	16.6	60.0
0.374000	39.1	Off	L1	19.4	19.3	58.4
0.470000	38.0	Off	L1	19.4	18.5	56.5
0.622000	41.0	Off	L1	19.5	15.0	56.0
0.766000	35.5	Off	L1	19.5	20.5	56.0

Final Result 2

Frequency (MHz)	Average (dBµV)	Filter	Line	Corr. (dB)	Margin (dB)	Limit (dBµV)
0.158000	43.6	Off	L1	19.5	12.0	55.6
0.310000	41.8	Off	L1	19.4	8.2	50.0
0.374000	35.4	Off	L1	19.4	13.0	48.4
0.470000	31.4	Off	L1	19.4	15.1	46.5
0.622000	36.1	Off	L1	19.5	9.9	46.0
0.766000	29.0	Off	L1	19.5	17.0	46.0



Test Mode :	Mode 1	Temperature :	24~25°C
Test Engineer :	Cona Huang	Relative Humidity :	49~53%
Test Voltage :	120Vac / 60Hz	Phase :	Neutral
Function Type :	GSM850 Idle + Bluetooth Link + GPS Rx + Camera + USB Cable (Link with Notebook)		
Remark :	All emissions not reported here are more than 10 dB below the prescribed limit.		

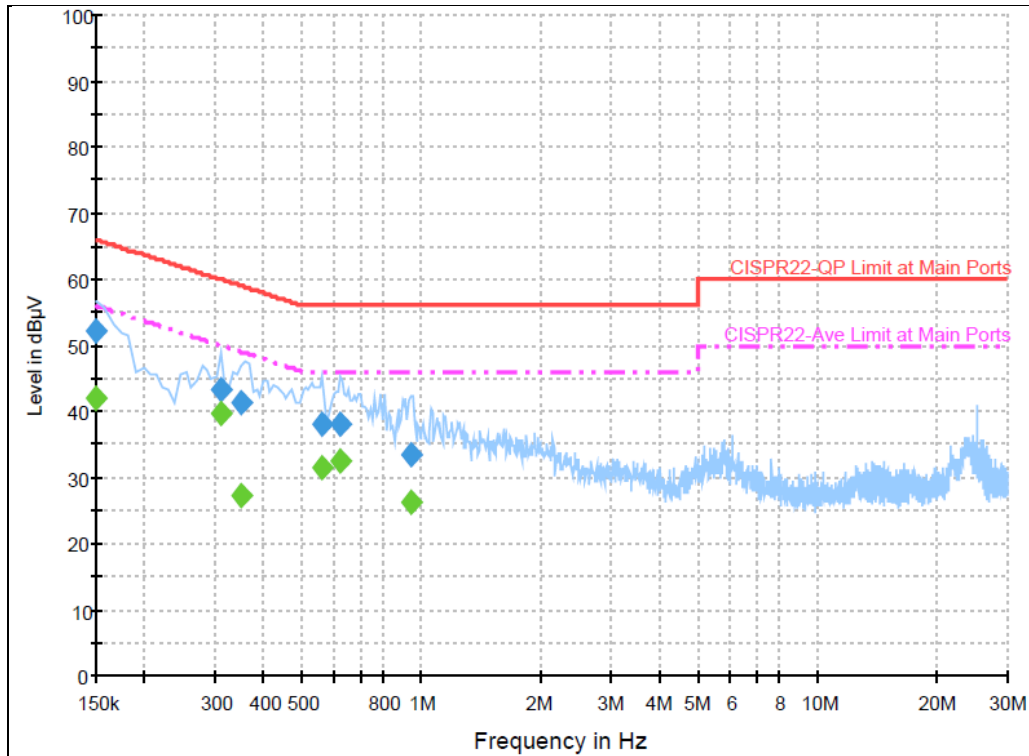

Final Result 1

Frequency (MHz)	QuasiPeak (dBµV)	Filter	Line	Corr. (dB)	Margin (dB)	Limit (dBµV)
0.150000	52.2	Off	N	19.5	13.8	66.0
0.310000	43.4	Off	N	19.5	16.6	60.0
0.350000	41.4	Off	N	19.4	17.6	59.0
0.558000	37.9	Off	N	19.5	18.1	56.0
0.622000	38.2	Off	N	19.5	17.8	56.0
0.934000	33.3	Off	N	19.5	22.7	56.0

Final Result 2

Frequency (MHz)	Average (dBµV)	Filter	Line	Corr. (dB)	Margin (dB)	Limit (dBµV)
0.150000	42.1	Off	N	19.5	13.9	56.0
0.310000	39.5	Off	N	19.5	10.5	50.0
0.350000	27.2	Off	N	19.4	21.8	49.0
0.558000	31.6	Off	N	19.5	14.4	46.0
0.622000	32.5	Off	N	19.5	13.5	46.0
0.934000	26.4	Off	N	19.5	19.6	46.0



3.8 Radiated Emission Measurement

3.8.1 Limit of Radiated Emission

In any 100 kHz bandwidth outside the intentional radiator frequency band, all harmonics/spurious must be at least 20 dB below the highest emission level within the authorized band. In addition, radiated emissions which fall in the restricted bands must also comply with the FCC section 15.209 limits as below.

Frequency (MHz)	Field Strength (microvolts/meter)	Measurement Distance (meters)
0.009 – 0.490	2400/F(kHz)	300
0.490 – 1.705	24000/F(kHz)	30
1.705 – 30.0	30	30
30 – 88	100	3
88 – 216	150	3
216 - 960	200	3
Above 960	500	3

3.8.2 Measuring Instruments

See list of measuring instruments of this test report.

3.8.3 Test Procedures

1. The testing follows the guidelines in FCC Public Notice DA 00-705 Measurement Guidelines.
2. Use the following spectrum analyzer settings:
Span = wide enough to fully capture the emission being measured; RBW = 1 MHz for $f \geq 1$ GHz, 100 kHz for $f < 1$ GHz; VBW \geq RBW; Sweep = auto; Detector function = peak; Trace = max hold.
3. Follow the guidelines in ANSI C63.4-2003 with respect to maximizing the emission by rotating the EUT, measuring the emission for three EUT orthogonal planes, and adjusting the measurement antenna height and polarization. A pre-amp and a high pass filter are used for this test in order to get the good signal level.

3.8.4 Test Setup

For radiated emissions below 30MHz

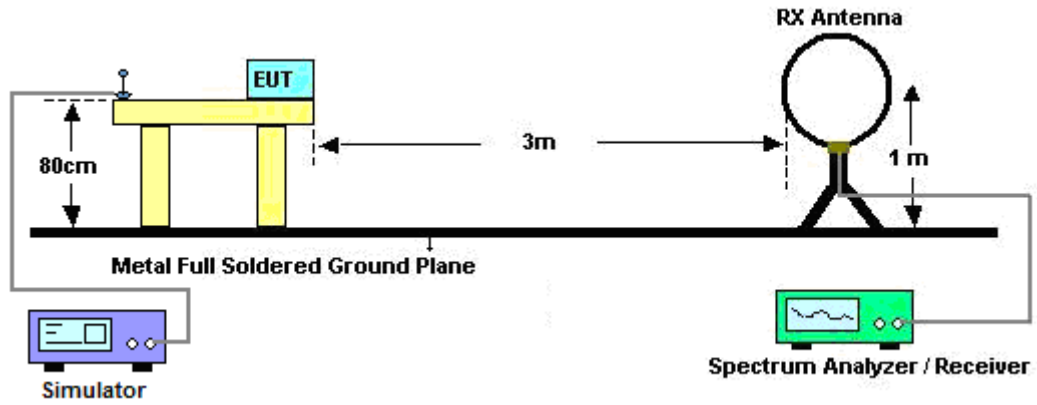

For radiated emissions above 30MHz

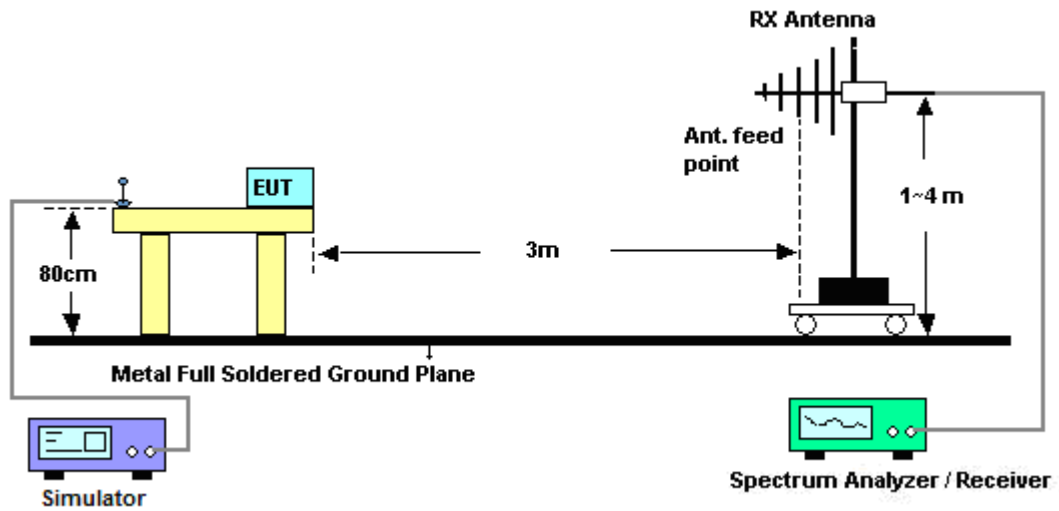



3.8.5 Test Results of Radiated Emissions (9 kHz ~ 30 MHz)

Test Engineer :	Kay Wu	Temperature :	25~26°C	
		Relative Humidity :	39~40%	
Frequency (MHz)	Level (dBuV)	Over Limit (dB)	Limit Line (dBuV)	Remark
-	-	-	-	See Note

Note:

The amplitude of spurious emissions that are attenuated by more than 20dB below the permissible value has no need to be reported.

Distance extrapolation factor = $40 \log(\text{specific distance} / \text{test distance})$ (dB);

Limit line = specific limits (dBuV) + distance extrapolation factor.



3.8.6 Test Result of Radiated Emission (30 MHz ~ 10th Harmonic)

Test Mode :	Mode 1	Temperature :	25~26°C
Test Channel :	00	Relative Humidity :	39~40%
Test Engineer :	Kay Wu	Polarization :	Horizontal
Remark :	#9 and #10 are Fundamental Signals which can be ignored.		

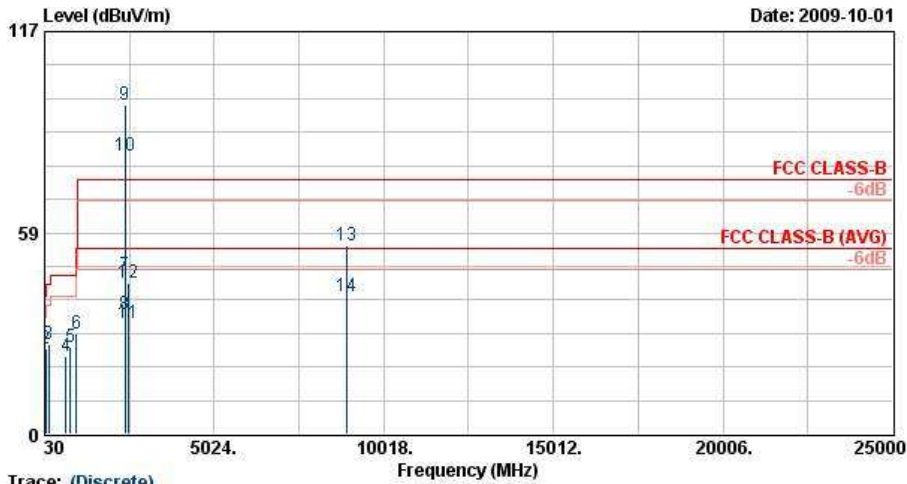

Site
Condition
Project
Mode
TNET

Trace: (Discrete)
: 03CH07-HY
: FCC CLASS-B 3m SHF-EHF HORN HORIZONTAL
: FR 972007-01
: Mode 1
: 355895030000081

	Freq	Level	Over	Limit	Read	Antenna	Cable	Preamp	Ant	Table	Remark
	MHz	dBuV/m	Limit	Line	Level	Factor	Loss	Factor	Pos	Pos	
			dB	dBuV/m	dBuV	dB/m	dB	dB	cm	deg	
1	30.27	33.39	-6.61	40.00	44.55	19.90	0.64	31.70	100	121	Peak
2	54.30	24.77	-15.23	40.00	47.73	7.88	0.86	31.70	---	---	Peak
3	147.45	26.03	-17.47	43.50	44.42	11.81	1.45	31.65	---	---	Peak
4	663.30	22.58	-23.42	46.00	29.76	20.32	3.45	30.94	---	---	Peak
5	786.50	25.20	-20.80	46.00	30.24	21.87	3.81	30.73	---	---	Peak
6	957.30	29.22	-16.78	46.00	31.21	24.37	4.28	30.64	---	---	Peak
7	2389.99	46.00	-28.00	74.00	42.79	32.13	5.46	34.38	105	349	Peak
8	2389.99	34.62	-19.38	54.00	31.41	32.13	5.46	34.38	105	349	Average
9 @	2402.00	95.70	---	---	92.48	32.16	5.44	34.38	105	349	Peak
10 @	2402.00	80.90	---	---	77.69	32.13	5.46	34.38	105	349	Average
11	2492.00	32.14	-21.86	54.00	28.87	32.30	5.37	34.40	105	349	Average
12	2492.00	43.71	-30.29	74.00	40.44	32.30	5.37	34.40	105	349	Peak
13	8913.00	54.69	-19.31	74.00	43.52	36.24	10.31	35.38	100	73	Peak
14	8913.00	40.15	-13.85	54.00	28.98	36.24	10.31	35.38	100	73	Average



Test Mode :	Mode 1	Temperature :	25~26°C
Test Channel :	00	Relative Humidity :	39~40%
Test Engineer :	Kay Wu	Polarization :	Vertical
Remark :	#9 and #10 are Fundamental Signals which can be ignored.		

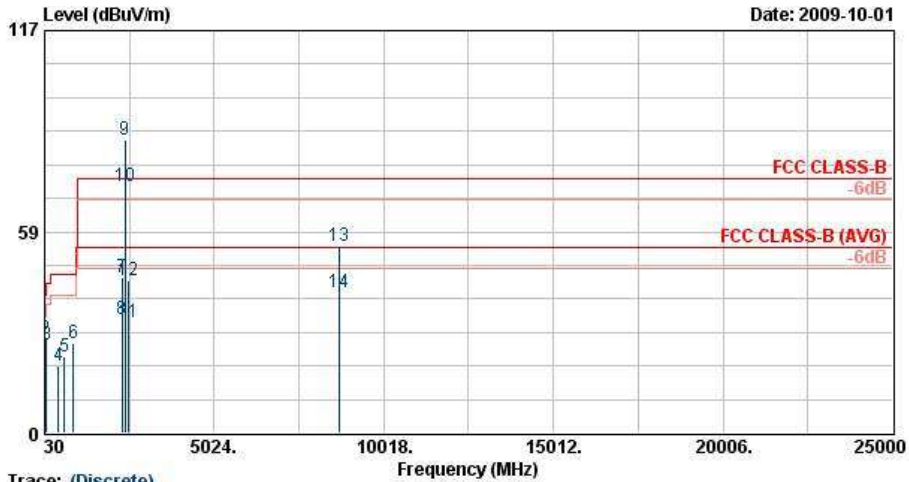

Trace: (Discrete)

Site : 03CH07-HY
 Condition : FCC CLASS-B 3m SHF-EHF HORN VERTICAL
 Project : FR 972007-01
 Mode : Mode 1
 TMEI : 355885030000081

	Freq	Level	Over	Limit	ReadAntenna	Cable	Preamp	Ant	Table	Remark	
	MHz	dBuV/m	dB	dBuV/m	dBuV	dB/m	dB	dB	cm	deg	
1	30.00	24.93	-15.07	40.00	36.09	19.90	0.64	31.70	---	---	Peak
2	62.94	27.27	-12.73	40.00	51.87	6.17	0.93	31.70	100	244	Peak
3	93.45	25.88	-17.62	43.50	46.86	9.59	1.13	31.70	---	---	Peak
4	442.10	19.38	-26.62	46.00	30.60	17.16	2.78	31.16	---	---	Peak
5	609.40	22.14	-23.86	46.00	30.25	19.61	3.28	30.99	---	---	Peak
6	887.30	26.21	-19.79	46.00	29.87	22.93	4.11	30.70	---	---	Peak
7	2311.33	45.05	-28.95	74.00	41.89	32.00	5.53	34.36	100	267	Peak
8	2311.33	32.94	-21.06	54.00	29.78	32.00	5.53	34.36	100	267	Average
9 X	2402.00	85.15			81.93	32.16	5.44	34.38	100	267	Peak
10 @	2402.00	71.55			68.34	32.13	5.46	34.38	100	267	Average
11	2486.00	32.08	-21.92	54.00	28.82	32.27	5.38	34.40	100	267	Average
12	2486.00	44.34	-29.66	74.00	41.08	32.27	5.38	34.40	100	267	Peak
13	8685.00	54.38	-19.62	74.00	43.37	36.11	10.24	35.34	100	44	Peak
14	8685.00	40.89	-13.11	54.00	29.88	36.11	10.24	35.34	100	44	Average



Test Mode :	Mode 2	Temperature :	25~26°C
Test Channel :	39	Relative Humidity :	39~40%
Test Engineer :	Kay Wu	Polarization :	Horizontal
Remark :	#9 and #10 are Fundamental Signals which can be ignored.		

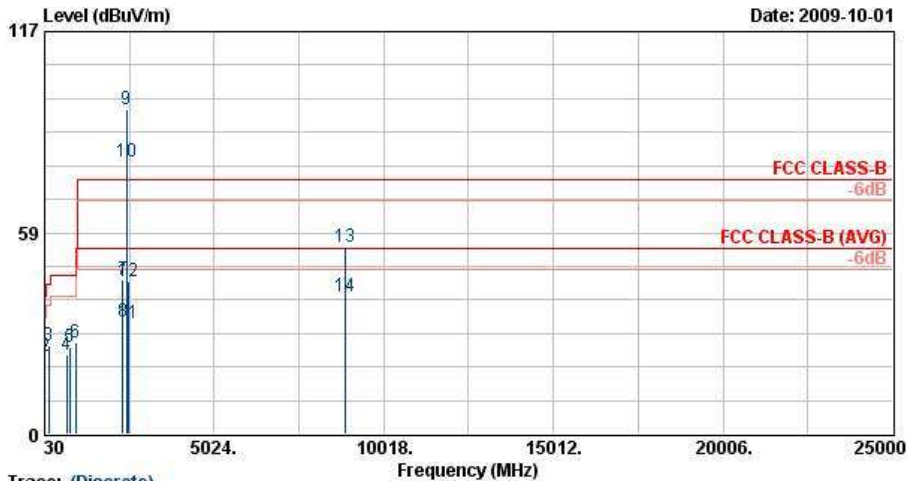

Trace: (Discrete)
 Site : 03CH07-HY
 Condition : FCC CLASS-B 3m SHF-EHF HORN HORIZONTAL
 Project : FR 972007-01
 Mode : Mode 2
 TMEI : 355895030000081

	Freq	Level	Over	Limit	Read	Antenna	Cable	Preamp	Ant	Table	Remark
	MHz	dBuV/m	Limit	Line	Level	Factor	Loss	Factor	Pos	Pos	
			dB	dBuV/m	dBuV	dB/m	dB	dB	cm	deg	
1	30.00	32.69	-7.31	40.00	43.85	19.90	0.64	31.70	100	87	Peak
2	39.18	22.49	-17.51	40.00	38.59	14.88	0.72	31.70	---	---	Peak
3	147.45	25.71	-17.79	43.50	44.11	11.81	1.45	31.65	---	---	Peak
4	668.90	22.86	-23.14	46.00	29.92	20.41	3.46	30.93	---	---	Peak
5	769.00	25.05	-20.95	46.00	30.22	21.84	3.76	30.76	---	---	Peak
6	942.60	26.74	-19.26	46.00	28.96	24.19	4.25	30.66	---	---	Peak
7	2340.00	44.65	-29.35	74.00	41.46	32.05	5.50	34.37	128	346	Peak
8	2340.00	32.66	-21.34	54.00	29.48	32.05	5.50	34.37	128	346	Average
9 @	2441.00	94.31			91.07	32.22	5.41	34.39	128	346	Peak
10 @	2441.00	79.00			75.76	32.22	5.41	34.39	128	346	Average
11	2492.00	32.20	-21.80	54.00	28.93	32.30	5.37	34.40	128	346	Average
12	2492.00	44.24	-29.76	74.00	40.97	32.30	5.37	34.40	128	346	Peak
13	8901.00	54.54	-19.46	74.00	43.37	36.24	10.31	35.38	100	132	Peak
14	8901.00	39.91	-14.09	54.00	28.74	36.24	10.31	35.38	100	132	Average



Test Mode :	Mode 2	Temperature :	25~26°C
Test Channel :	39	Relative Humidity :	39~40%
Test Engineer :	Kay Wu	Polarization :	Vertical
Remark :	#9 and #10 are Fundamental Signals which can be ignored.		

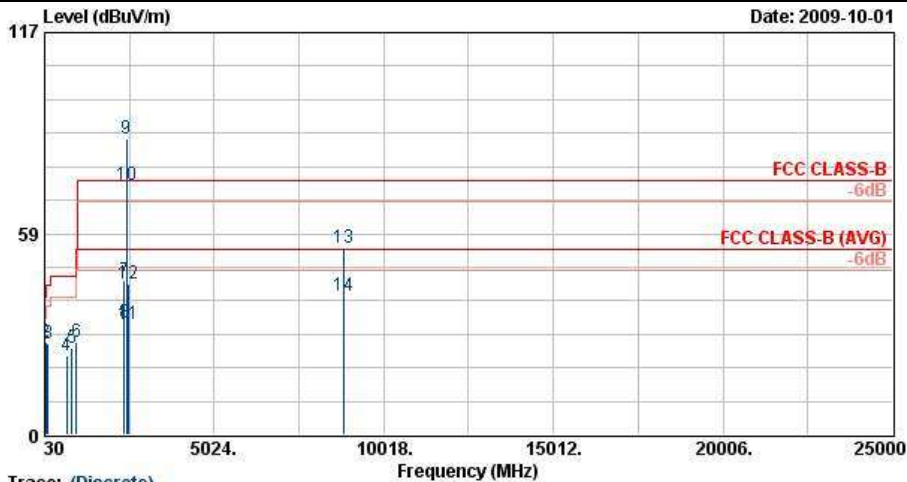

Trace: (Discrete)
 Site : D3CH07-HY
 Condition : FCC CLASS-B 3m SHF-EHF HORN VERTICAL
 Project : FR 972007-01
 Mode : Mode 2
 TMEI : 355895030000081

	Freq	Level	Over	Limit	ReadAntenna	Cable	Preamp	Ant	Table	Remark
	MHz	dBuV/m	Limit	Line	Level	Loss	Factor	Pos	Pos	
			dB	dBuV/m	dBuV	dB	dB	cm	deg	
1	30.27	32.34	-7.66	40.00	43.50	19.90	0.64	31.70	68	Peak
2	60.78	27.13	-12.87	40.00	51.92	5.99	0.92	31.70	---	Peak
3	125.85	26.60	-16.90	43.50	44.70	12.22	1.35	31.67	---	Peak
4	682.20	22.90	-23.10	46.00	29.71	20.61	3.50	30.92	---	Peak
5	830.60	25.30	-20.70	46.00	29.52	22.57	3.92	30.70	---	Peak
6	955.90	26.87	-19.13	46.00	28.87	24.37	4.28	30.64	---	Peak
7	2380.00	44.81	-29.19	74.00	41.61	32.11	5.47	34.38	100	265 Peak
8	2380.00	32.64	-21.36	54.00	29.44	32.11	5.47	34.38	100	265 Average
9 X	2441.00	86.02			82.78	32.22	5.41	34.39	100	265 Peak
10 @	2441.00	72.46			69.22	32.22	5.41	34.39	100	265 Average
11	2500.00	32.11	-21.89	54.00	28.84	32.30	5.37	34.40	100	265 Average
12	2500.00	44.09	-29.91	74.00	40.82	32.30	5.37	34.40	100	265 Peak
13	8817.00	54.53	-19.47	74.00	43.42	36.19	10.28	35.36	100	95 Peak
14	8817.00	40.56	-13.44	54.00	29.45	36.19	10.28	35.36	100	95 Average



Test Mode :	Mode 3	Temperature :	25~26°C
Test Channel :	78	Relative Humidity :	39~40%
Test Engineer :	Kay Wu	Polarization :	Horizontal
Remark :	#9 and #10 are Fundamental Signals which can be ignored.		

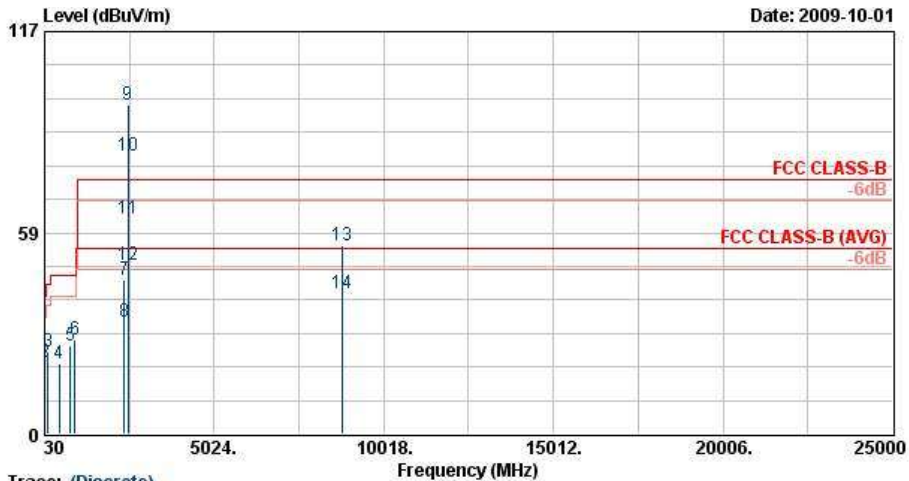

Trace: (Discrete)
 Site : 03CH07-HY
 Condition : FCC CLASS-B 3m SHF-EHF HORN HORIZONTAL
 Project : FR 972007-01
 Mode : Mode 3
 TMEI : 355895030000081

	Freq	Level	Over	Limit	Read	Antenna	Cable	Preamp	Ant	Table	Remark
	MHz	dBuV/m	dB	dBuV/m	dBuV	dB/m	dB	dB	cm	deg	
1	30.54	32.00	-8.00	40.00	43.69	19.36	0.65	31.70	100	84	Peak
2	44.85	20.79	-19.21	40.00	40.17	11.60	0.72	31.70	---	---	Peak
3	127.74	23.86	-19.64	43.50	41.91	12.26	1.36	31.67	---	---	Peak
4	469.40	20.63	-25.37	46.00	31.27	17.65	2.84	31.13	---	---	Peak
5	792.10	25.72	-20.28	46.00	30.73	21.88	3.83	30.72	---	---	Peak
6	932.10	27.43	-18.57	46.00	30.01	23.87	4.22	30.67	---	---	Peak
7	2372.00	44.79	-29.21	74.00	41.59	32.11	5.47	34.38	103	347	Peak
8	2372.00	32.72	-21.28	54.00	29.52	32.11	5.47	34.38	103	347	Average
9 @	2480.00	95.82			92.56	32.27	5.38	34.40	103	347	Peak
10 @	2480.00	81.03			77.77	32.27	5.38	34.40	103	347	Average
11	2483.50	62.47	-11.53	74.00	59.21	32.27	5.38	34.40	103	347	Peak
12 !	2483.50	49.07	-4.93	54.00	45.81	32.27	5.38	34.40	103	347	Average
13	8805.00	54.85	-19.15	74.00	43.75	36.18	10.28	35.36	100	24	Peak
14	8805.00	40.94	-13.06	54.00	29.84	36.18	10.28	35.36	100	24	Average



Test Mode :	Mode 3	Temperature :	25~26°C
Test Channel :	78	Relative Humidity :	39~40%
Test Engineer :	Kay Wu	Polarization :	Vertical
Remark :	#9 and #10 are Fundamental Signals which can be ignored.		

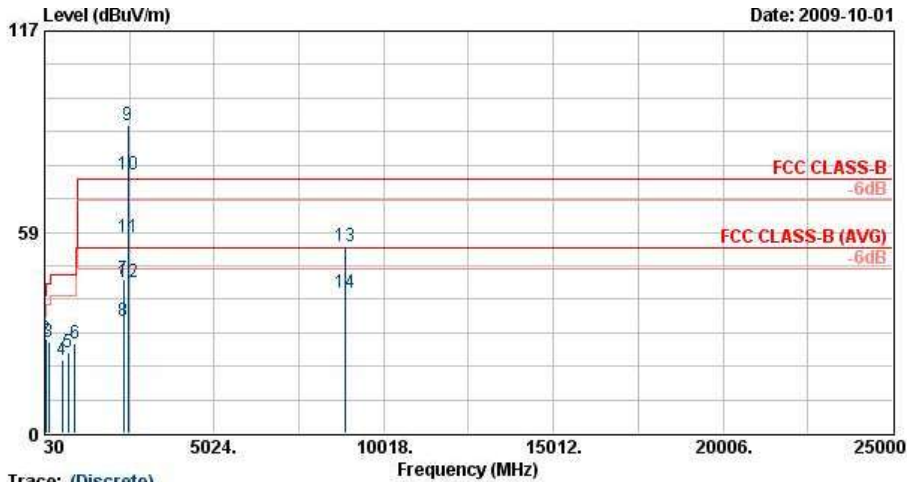

Trace: (Discrete)

Site : 03CH07-HY
 Condition : FCC CLASS-B 3m SHF-EHF HORN VERTICAL
 Project : FR 972007-01
 Mode : Mode 3
 TMET : 355895030000081

	Freq	Level	Over	Limit	Read	Antenna	Cable	Preamp	Ant	Table	Remark
	MHz	dBuV/m	dB	dBuV/m	dBuV	dB/m	dB	dB	cm	deg	
1	30.27	32.56	-7.44	40.00	43.72	19.90	0.64	31.70	100	75	Peak
2	62.13	27.56	-12.44	40.00	52.26	6.08	0.92	31.70	---	---	Peak
3	159.33	26.52	-16.98	43.50	45.49	11.16	1.51	31.64	---	---	Peak
4	551.30	21.31	-24.69	46.00	30.36	18.91	3.09	31.05	---	---	Peak
5	719.30	23.48	-22.52	46.00	29.48	21.25	3.61	30.86	---	---	Peak
6	917.40	26.22	-19.78	46.00	29.28	23.43	4.20	30.68	---	---	Peak
7	2364.00	44.62	-29.38	74.00	41.42	32.08	5.49	34.37	128	13	Peak
8	2364.00	32.65	-21.35	54.00	29.46	32.08	5.49	34.37	128	13	Average
9 X	2480.00	89.51			86.25	32.27	5.38	34.40	128	13	Peak
10 @	2480.00	75.43			72.17	32.27	5.38	34.40	128	13	Average
11	2483.50	56.98	-17.02	74.00	53.72	32.27	5.38	34.40	128	13	Peak
12	2483.50	44.05	-9.95	54.00	40.79	32.27	5.38	34.40	128	13	Average
13	8898.00	54.46	-19.54	74.00	43.29	36.24	10.31	35.38	100	77	Peak
14	8898.00	40.72	-13.28	54.00	29.55	36.24	10.31	35.38	100	77	Average



3.9 Antenna Requirements

3.9.1 Standard Applicable

If directional gain of transmitting antennas is greater than 6dBi, the power shall be reduced by the same level in dB comparing to gain minus 6dBi. The use of a permanently attached antenna or of an antenna that uses a unique coupling to the intentional radiator shall be considered sufficient to comply with the FCC rule.

3.9.2 Antenna Connected Construction

The antennas type used in this product is Monopole Antenna without connector and it is considered to meet antenna requirement.

3.9.3 Antenna Gain

The antenna peak gain of EUT is less than 6 dBi. Therefore, it is not necessary to reduce maximum peak output power limit.



4 List of Measuring Equipment

Instrument	Manufacturer	Model No.	Serial No.	Characteristics	Calibration Date	Due Date	Remark
Spectrum Analyzer	R&S	FSP40	100055	9kHz~40GHz	Jun. 23, 2009	Jun. 22, 2010	Conducted (TH02-HY)
Power Meter	Anritsu	ML2495A	0932001	N/A	Sep. 17, 2009	Sep. 16, 2010	Conducted (TH02-HY)
Power Sensor	Anritsu	MA2411B	0846202	N/A	Sep. 10, 2009	Sep. 09, 2010	Conducted (TH02-HY)
EMI Test Receive	R&S	ESCS 30	100356	9KHz – 2.75GHz	Aug. 05, 2009	Aug. 04, 2010	Conduction (CO05-HY)
Two-LISN	R&S	ENV216	11-100081	9kHz~30MHz	Nov. 26, 2008	Nov. 25, 2009	Conduction (CO05-HY)
Two-LISN	R&S	ENV216	11-100080	9kHz~30MHz	Nov. 26, 2008	Nov. 25, 2009	Conduction (CO05-HY)
AC Power Source	APC	APC-1000W	N/A	N/A	N/A	N/A	Conduction (CO05-HY)
System Simulator	R&S	CMU200	105934	N/A	Nov. 11, 2008	Nov. 10, 2010	Conduction (CO05-HY)
Bilog Antenna	SCHAFFNER	CBL6111C	2726	30MHz ~ 1GHz	Nov. 20, 2008	Nov. 19, 2009	Radiation (03CH07-HY)
Spectrum Analyzer	R&S	FSP	101067	9KHz ~ 30GHz	Dec. 02, 2008	Dec. 01, 2009	Radiation (03CH07-HY)
Double Ridge Horn Antenna	ESCO	3117	00075962	1GHz ~ 18GHz	Aug. 20, 2009	Aug. 19, 2010	Radiation (03CH07-HY)
SHF-EHF Horn Antenna	SCHWARZBECK	BBHA 9170	BBHA9170251	15GHz- 40GHz	Oct. 16, 2008	Oct. 15, 2009	Radiation (03CH07-HY)
Pre Amplifier	Agilent	8449B	3008A02362	1GHz~ 26.5GHz	Dec. 17, 2008	Dec. 16, 2009	Radiation (03CH07-HY)
Pre Amplifier	COM-POWER	PA-103A	161241	10-1000MHz.32 dB.GAIN	Mar. 27, 2009	Mar. 26, 2010	Radiation (03CH07-HY)
Loop Antenna	R&S	HFH2-Z2	860004/001	9 KHz~30 MHz	May 22, 2008	May 21, 2010	Radiation (03CH07-HY)
Bluetooth Base Station	Anritsu	MT8852B	6K00005722	N/A	Oct. 23, 2007	Oct. 22, 2009	Radiation (03CH07-HY)

5 Uncertainty of Evaluation

Uncertainty of Conducted Emission Measurement (150 kHz ~ 30 MHz)

Contribution	Uncertainty of X_i		$u(X_i)$
	dB	Probability Distribution	
Receiver Reading	0.10	Normal (k=2)	0.05
Cable Loss	0.10	Normal (k=2)	0.05
AMN Insertion Loss	2.50	Rectangular	0.63
Receiver Specification	1.50	Rectangular	0.43
Site Imperfection	1.39	Rectangular	0.80
Mismatch	+0.34 / -0.35	U-Shape	0.24
Combined Standard Uncertainty $U_c(y)$	1.13		
Measuring Uncertainty for a Level of Confidence of 95% ($U = 2U_c(y)$)	2.26		

Uncertainty of Radiated Emission Measurement (30 MHz ~ 1000 MHz)

Contribution	Uncertainty of X_i		$u(X_i)$
	dB	Probability Distribution	
Receiver Reading	0.41	Normal (k=2)	0.21
Antenna Factor Calibration	0.83	Normal (k=2)	0.42
Cable Loss Calibration	0.25	Normal (k=2)	0.13
Pre-Amplifier Gain Calibration	0.27	Normal (k=2)	0.14
RCV/SPA Specification	2.50	Rectangular	0.72
Antenna Factor Interpolation for Frequency	1.00	Rectangular	0.29
Site Imperfection	1.43	Rectangular	0.83
Mismatch	+0.39 / -0.41	U-Shape	0.28
Combined Standard Uncertainty $U_c(y)$	1.27		
Measuring Uncertainty for a Level of Confidence of 95% ($U = 2U_c(y)$)	2.54		



Uncertainty of Radiated Emission Measurement (1 GHz ~ 40 GHz)

Contribution	Uncertainty of X_i		$u(X_i)$	C_i	$C_i * u(X_i)$
	dB	Probability Distribution			
Receiver Reading	±0.10	Normal (k=2)	0.10	1	0.10
Antenna Factor Calibration	±1.70	Normal (k=2)	0.85	1	0.85
Cable Loss Calibration	±0.50	Normal (k=2)	0.25	1	0.25
Receiver Correction	±2.00	Rectangular	1.15	1	1.15
Antenna Factor Directional	±1.50	Rectangular	0.87	1	0.87
Site Imperfection	±2.80	Triangular	1.14	1	1.14
Mismatch Receiver VSWR $\Gamma_1 = 0.197$ Antenna VSWR $\Gamma_2 = 0.194$ Uncertainty = $20\text{Log}(1-\Gamma_1*\Gamma_2)$	+0.34 / -0.35	U-Shape	0.244	1	0.244
Combined Standard Uncertainty $U_c(y)$	2.36				
Measuring Uncertainty for a Level of Confidence of 95% ($U = 2U_c(y)$)	4.72				

6 Certification of TAF Accreditation



Certificate No. : L1190-090417

財團法人全國認證基金會
Taiwan Accreditation Foundation

Certificate of Accreditation

This is to certify that

Sporton International Inc.
EMC & Wireless Communications Laboratory
No.52, Hwa Ya 1st Rd., Hwa Ya Technology Park, Kwei-Shan Hsiang, Tao Yuan Hsien,
Taiwan, R.O.C.

is accredited in respect of laboratory

Accreditation Criteria	: ISO/IEC 17025:2005
Accreditation Number	: 1190
Originally Accredited	: December 15, 2003
Effective Period	: January 10, 2007 to January 09, 2010
Accredited Scope	: Testing Field, see described in the Appendix
Specific Accreditation Program	: Accreditation Program for Designated Testing Laboratory for Commodities Inspection Accreditation Program for Telecommunication Equipment Testing Laboratory Accreditation Program for BSMI Mutual Recognition Arrangement with Foreign Authorities

Jay-San Chen
President, Taiwan Accreditation Foundation
Date : April 17, 2009

P1, total 20 pages

The Appendix forms an integral part of this Certificate, which shall be invalid when use without the Appendix



Appendix A. Photographs of EUT

Please refer to Sporton report number EP972007-01 as below.