

# FCC RF Test Report

**APPLICANT** : Acer Incorporated  
**EQUIPMENT** : Smart HandHeld  
**BRAND NAME** : Acer  
**MODEL NAME** : E100  
**FCC ID** : HLZDME100EU  
**STANDARD** : FCC Part 15 Subpart C §15.247  
**CLASSIFICATION** : Digital Spread Spectrum (DSS)

The product was received on Nov. 06, 2009 and completely tested on Nov. 13, 2009. We, SPORTON INTERNATIONAL INC., would like to declare that the tested sample has been evaluated in accordance with the procedures given in ANSI C63.4-2003 and shown the compliance with the applicable technical standards.

The test results in this report apply exclusively to the tested model / sample. Without written approval of SPORTON INTERNATIONAL INC., the test report shall not be reproduced except in full.

Reviewed by:

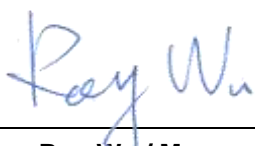

Roy Wu / Manager



## **SPORTON INTERNATIONAL INC.**

**No. 52, Hwa Ya 1<sup>st</sup> Rd., Hwa Ya Technology Park, Kwei-Shan Hsiang, Tao Yuan Hsien, Taiwan, R.O.C.**



# TABLE OF CONTENTS

**REVISION HISTORY..... 3**

**SUMMARY OF TEST RESULT ..... 4**

**1 GENERAL DESCRIPTION..... 5**

    1.1 Applicant ..... 5

    1.2 Manufacturer..... 5

    1.3 Feature of Equipment Under Test ..... 5

    1.4 Testing Site ..... 7

    1.5 Applied Standards ..... 7

    1.6 Ancillary Equipment List ..... 7

**2 TEST CONFIGURATION OF EQUIPMENT UNDER TEST..... 8**

    2.1 RF Output Power ..... 8

    2.2 Test Mode..... 9

    2.3 Connection Diagram of Test System..... 10

    2.4 RF Utility ..... 10

**3 TEST RESULT ..... 11**

    3.1 Number of Channel Measurement ..... 11

    3.2 20dB Bandwidth Measurement ..... 13

    3.3 Hopping Channel Separation Measurement ..... 20

    3.4 Dwell Time Measurement..... 23

    3.5 Peak Output Power Measurement ..... 25

    3.6 Band Edges Measurement ..... 28

    3.7 Spurious Emission Measurement..... 32

    3.8 AC Conducted Emission Measurement..... 36

    3.9 Radiated Emission Measurement..... 40

    3.10 Antenna Requirements ..... 49

**4 LIST OF MEASURING EQUIPMENT..... 50**

**5 UNCERTAINTY OF EVALUATION..... 51**

**6 CERTIFICATION OF TAF ACCREDITATION ..... 53**

**APPENDIX A. PHOTOGRAPHS OF EUT**

**APPENDIX B. SETUP PHOTOGRAPHS**



### REVISION HISTORY

REPORT NO.	VERSION	DESCRIPTION	ISSUED DATE
FR971509-03	Rev. 01	Initial issue of report	Nov. 20, 2009



### SUMMARY OF TEST RESULT

Report Section	FCC Rule	IC Rule	Description	Limit	Result	Remark
3.1	15.247(a)(1)	A8.4(2)	Number of Channels	≥ 15Chs	Pass	
3.2	15.247(a)(1)	A8.1(a)	20dB Bandwidth	NA	Pass	-
3.3	15.247(a)(1)	A8.1(b)	Channel Separation	≥ 2/3 of 20dB BW	Pass	-
3.4	15.247(a)(1)	A8.1(d)	Dwell Time of Each Channel	≤ 0.4sec in 31.6sec period	Pass	-
3.5	15.247(b)(1)	A8.1(b)	Peak Output Power	≤ 1W	Pass	-
3.6	15.247(d)	A8.5	Frequency Band Edges	≤ 20dBc	Pass	-
3.7	15.247(d)	A8.5	Spurious Emission	< 20 dBc	Pass	-
3.8	15.207	Gen 7.2.2	AC Conducted Emission	15.207(a)	Pass	Under limit 6.4 dB at 0.614 MHz
3.9	15.247(d)	A8.5	Transmitter Radiated Emission	15.209(a) & 15.247(d)	Pass	Under limit 4.84 dB at 70.23 MHz
3.10	15.203 & 15.247(b)	A8.4	Antenna Requirement	N/A	Pass	-

# 1 General Description

## 1.1 Applicant

**Acer Incorporated**

8F., No. 88, Sec. 1, Hsin Tai Wu Rd. Hsichih Taipei Hsien 221, Taiwan

## 1.2 Manufacturer

**Inventec Appliances (Pudong) Corporation**

No. 789, Puxing Rd., Minhang District, Shanghai, P.R.C.

## 1.3 Feature of Equipment Under Test

Product Feature & Specification	
Equipment	Smart HandHeld
Brand Name	Acer
Model Name	E100
FCC ID	HLZDME100EU
Tx/Rx Frequency Range	2400 MHz ~ 2483.5 MHz
Number of Channels	79
Carrier Frequency of Each Channel	2402+n*1 MHz; n=0~78
Channel Spacing	1 MHz
Maximum Output Power to Antenna	Bluetooth (1Mbps) : 0.96 dBm (1.25 mW) Bluetooth EDR (2Mbps) : 0.72 dBm (1.18 mW) Bluetooth EDR (3Mbps) : 1.01 dBm (1.26 mW)
Antenna Type	Monopole Antenna with gain -0.49 dBi
HW Version	D20
SW Version	OS : Acer_E100_0.010.00_EN
Type of Modulation	Bluetooth (1Mbps) : GFSK Bluetooth EDR (2Mbps) : $\pi$ /4-DQPSK Bluetooth EDR (3Mbps) : 8-DPSK
EUT Stage	Identical Prototype

**Remark:**

1. For other wireless features of this EUT, test report will be issued separately.
2. This test report recorded only product characteristics and test results of Digital Spread Spectrum (DSS).

**List of Accessory:**

<b>Specification of Accessory</b>		
<b>AC Adapter</b>	<b>Brand Name</b>	PHIHONG
	<b>Model Name</b>	PSAC05R-050
	<b>Power Rating</b>	I/P:100-240Vac, 50-60Hz, 300mA; O/P: 5Vdc, 1A
	<b>AC Power Cord Type</b>	1.5 meter non-shielded cable without ferrite core
<b>Battery</b>	<b>Brand Name</b>	Acer
	<b>Model Name</b>	A7BTA040H
	<b>Part Number</b>	BT.00107.004
	<b>Power Rating</b>	3.7Vdc, 1140mAh, 4.218Wh
	<b>Type</b>	Li-ion Polymer
<b>Earphone</b>	<b>Brand Name</b>	Merry
	<b>Model Name</b>	EMC292-002-02
	<b>Signal Line Type</b>	1.4 meter non-shielded cable without ferrite core
<b>USB Cable</b>	<b>Brand Name</b>	PHIHONG
	<b>Model Name</b>	DCM1000(AI-H)
	<b>Signal Line Type</b>	1.0 meter shielded cable without ferrite core
<b>LCD Panel</b>	<b>Brand Name</b>	CHIMEI
	<b>Model Name</b>	LT320AC9009
<b>Camera</b>	<b>Brand Name</b>	Lite-On
	<b>Model Name</b>	DCN-200MGV

**Remark:**

1. The above EUT's information was declared by manufacturer. Please refer to the specifications or user's manual for more detailed description.
2. For accessories equipped with this EUT, please refer to the appendix of the external photo.

## 1.4 Testing Site

<b>Test Site</b>	SPORTON INTERNATIONAL INC.		
<b>Test Site Location</b>	No. 52, Hwa Ya 1 <sup>st</sup> Rd., Hwa Ya Technology Park, Kwei-Shan Hsiang, Tao Yuan Hsien, Taiwan, R.O.C. TEL: +886-3-3273456 / FAX: +886-3-3284978		
<b>Test Site No.</b>	<b>Sporton Site No.</b>		<b>FCC/IC Registration No.</b>
	CO05-HY	03CH06-HY	TW1022/4086B-1

## 1.5 Applied Standards

According to the specifications of the manufacturer, the EUT must comply with the requirements of the following standards:

- ♦ FCC Part 15 Subpart C §15.247
- ♦ FCC Public Notice DA 00-705
- ♦ ANSI C63.4-2003
- ♦ IC RSS-210 Issue 7

### Remark:

1. All test items were verified and recorded according to the standards and without any deviation during the test.
2. This EUT has also been tested and complied with the requirements of FCC Part 15, Subpart B (DoC), recorded in a separate test report.

## 1.6 Ancillary Equipment List

Item	Equipment	Trade Name	Model Name	FCC ID	Data Cable	Power Cord
1.	System Simulator	R&S	CMU 200	N/A	N/A	Unshielded, 1.8 m
2.	Notebook	DELL	Vostro 1510	FCC DoC	N/A	AC I/P: Unshielded, 1.2 m DC O/P: Shielded, 1.8 m
3.	LCD Monitor	Lenovo	6135-AB1	FCC DoC	Shielded, 1.6 m	Unshielded, 1.8 m
4.	iPod	Apple	A1285	FCC DoC	Shielded, 1.0 m	N/A

## 2 Test Configuration of Equipment Under Test

### 2.1 RF Output Power

Preliminary tests were performed in different data rate and recorded the RF output power in the following table:

Channel	Frequency	Bluetooth RF Output Power		
		Data Rate / Modulation		
		GFSK	$\pi/4$ -DQPSK	8-DPSK
		1Mbps	2Mbps	3Mbps
Ch00	2402MHz	0.96 dBm	0.72 dBm	<b>1.01 dBm</b>
Ch39	2441MHz	0.42 dBm	-0.06 dBm	0.26 dBm
Ch78	2480MHz	-0.08 dBm	-0.68 dBm	-0.37 dBm

**Remark:**

1. The data rate was set in 3Mbps for all the test items due to the highest RF output power.
2. The EUT is programmed to transmit signals continuously for all testing.



## 2.2 Test Mode

The EUT has been associated with peripherals pursuant to ANSI C63.4-2003 and configuration operated in a manner tended to maximize its emission characteristics in a typical application. Frequency range investigated: conduction (150 kHz to 30 MHz), radiation (9 kHz to the 10th harmonic of the highest fundamental frequency or to 40 GHz, whichever is lower).

Pre-scanned tests, X, Y, Z in three orthogonal panels, were conducted to determine the final configuration from all possible combinations.

The following tables are showing the test modes as the worst cases and recorded in this report.

Test Cases			
Test Item	Data Rate / Modulation		
	Bluetooth 1Mbps GFSK	Bluetooth EDR 2Mbps $\pi$ /4-DQPSK	Bluetooth EDR 3Mbps 8-DPSK
Conducted TCs	Mode 1: CH00_2402 MHz Mode 2: CH39_2441 MHz Mode 3: CH78_2480 MHz	Mode 4: CH00_2402 MHz Mode 5: CH39_2441 MHz Mode 6: CH78_2480 MHz	Mode 7: CH00_2402 MHz Mode 8: CH39_2441 MHz Mode 9: CH78_2480 MHz
Radiated TCs	N/A	N/A	Mode 1: CH00_2402 MHz Mode 2: CH39_2441 MHz Mode 3: CH78_2480 MHz
AC Conducted Emission	Mode 1 : GPRS850 Idle + Bluetooth Link + Camera + USB Cable (Link with Notebook)		
<b>Remark:</b> For radiated TCs, the data rate was set in 3Mbps due to the highest RF output power; only the data of these modes was reported.			

## 2.3 Connection Diagram of Test System

### <Conducted Emission>

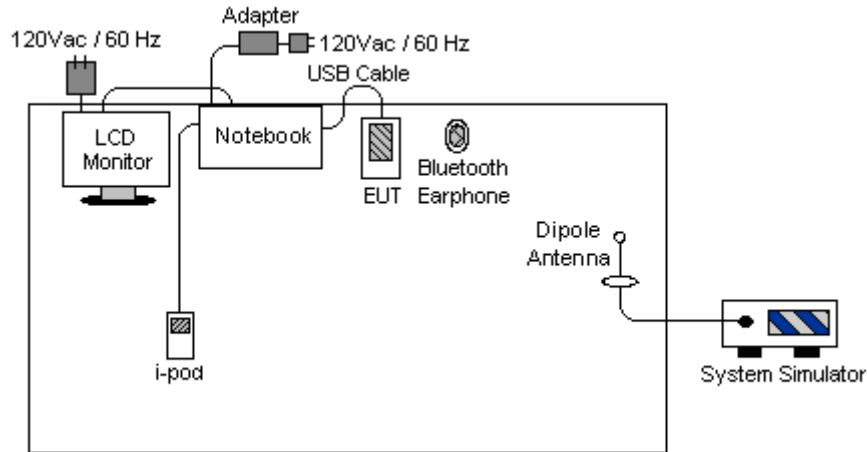

### <Radiated Emission>

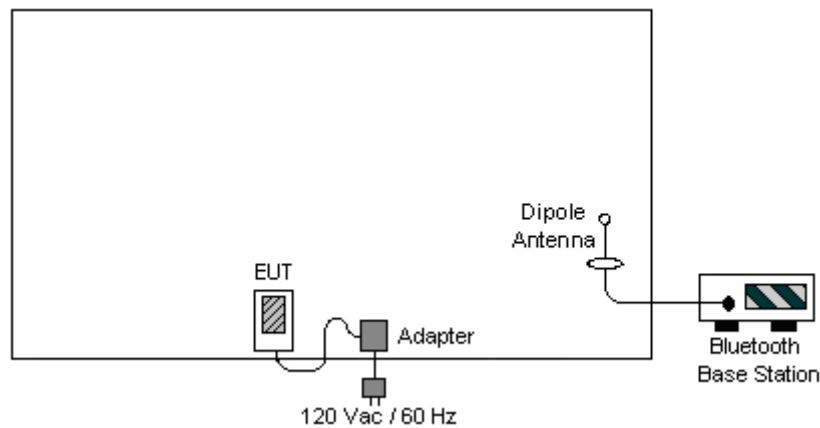

## 2.4 RF Utility

For Bluetooth function, the RF utility was installed in EUT which was programmed in order to make the EUT into the engineering modes to contact with Bluetooth base station for transmitting and receiving signals continuously.

### 3 Test Result

#### 3.1 Number of Channel Measurement

##### 3.1.1 Limits of Number of Hopping Frequency

Frequency hopping systems in the 2400-2483.5 MHz band shall use at least 15 channels.

##### 3.1.2 Measuring Instruments

See list of measuring instruments of this test report.

##### 3.1.3 Test Procedure

1. The testing follows FCC Public Notice DA 00-705 Measurement Guidelines.
2. The RF output of EUT was connected to the spectrum analyzer by a low loss cable.
3. The modulation types of EUT are irrelevant to number of hopping channels deviation.
4. The EUT must have its hopping function enabled. Use the following spectrum analyzer settings:  
Span = the frequency band of operation;  $RBW \geq 1\%$  of the span;  $VBW \geq RBW$ ; Sweep = auto;  
Detector function = peak; Trace = max hold.
5. The number of hopping frequency used is defined as the device has the numbers of total channel.

##### 3.1.4 Test Setup

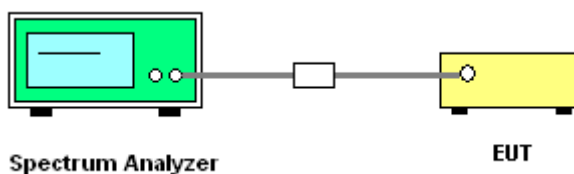



### 3.1.5 Test Result of Number of Hopping Frequency

Test Mode :	Mode 7~9	Temperature :	25~27°C		
Test Engineer :	Ken Hsu	Relative Humidity :	45~47%		
<b>Number of Hopping Channels (Channel)</b>		<b>Limits (Channel)</b>		<b>Pass/Fail</b>	
79		> 15		Pass	

Number of Hopping Channel Plot on Channel 00 - 78

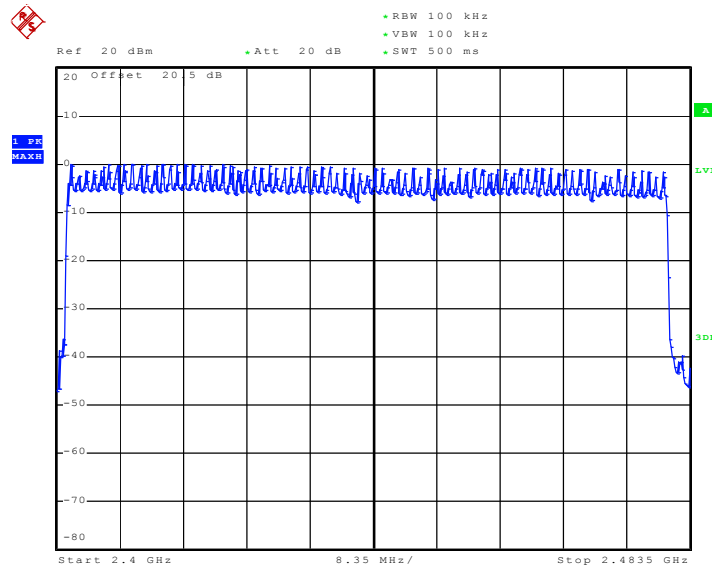

Date: 11.NOV.2009 18:22:14

## 3.2 20dB Bandwidth Measurement

### 3.2.1 Limit of 20dB Bandwidth

N/A

### 3.2.2 Measuring Instruments

See list of measuring instruments of this test report.

### 3.2.3 Test Procedures

1. The testing follows FCC Public Notice DA 00-705 Measurement Guidelines.
2. The RF output of EUT was connected to the spectrum analyzer by a low loss cable.
3. The EUT should be transmitting at its maximum data rate as the worst cases.
4. Use the following spectrum analyzer settings:  
Span = approximately 2 to 3 times the 20 dB bandwidth, centered on a hopping channel;  
RBW  $\geq$  1% of the 20 dB bandwidth; VBW  $\geq$  RBW; Sweep = auto; Detector function = peak;  
Trace = max hold.
5. The marker-delta reading at this point is the 20 dB bandwidth of the emission.

### 3.2.4 Test Setup

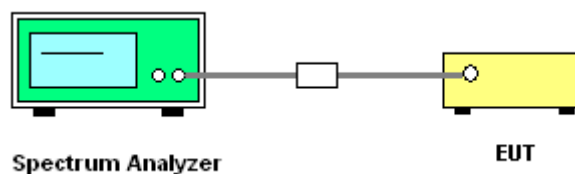



3.2.5 Test Result of 20dB Bandwidth

Test Mode :	Mode 1, 2, 3	Temperature :	25~27°C
Test Engineer :	Ken Hsu	Relative Humidity :	45~47%

Channel	Frequency (MHz)	20dB Bandwidth (MHz)
00	2402	0.802
39	2441	0.800
78	2480	0.800

20 dB Bandwidth Plot on Channel 00

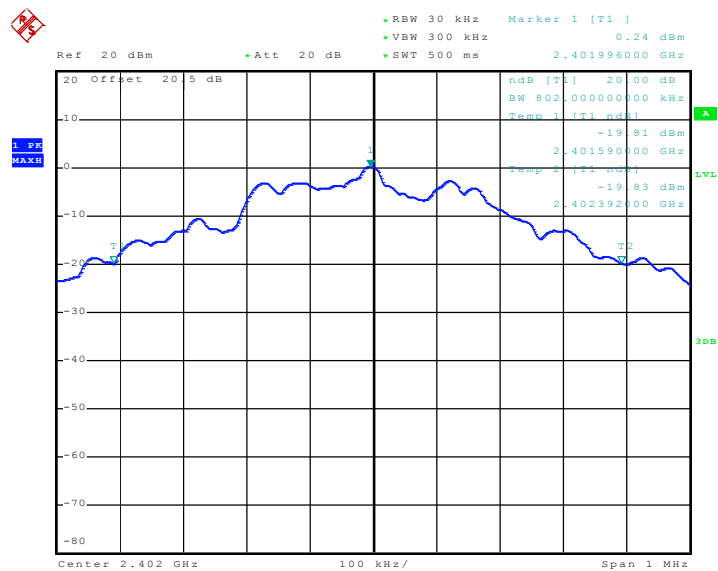

Date: 11.NOV.2009 17:37:23



20 dB Bandwidth Plot on Channel 39

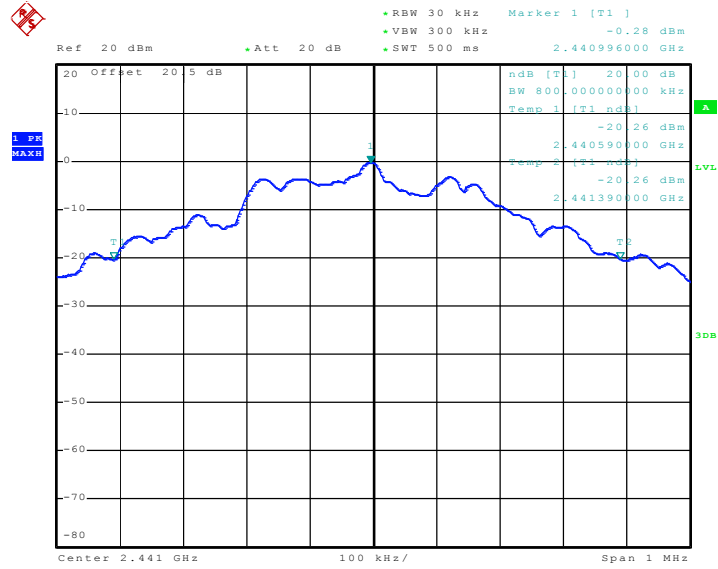

Date: 11.NOV.2009 17:37:42

20 dB Bandwidth Plot on Channel 78

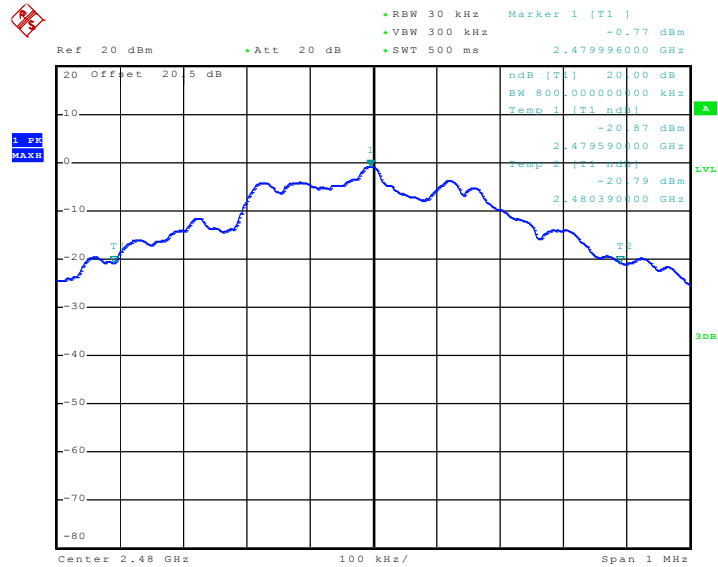

Date: 11.NOV.2009 17:37:59



Test Mode :	Mode 4, 5, 6	Temperature :	25~27°C
Test Engineer :	Ken Hsu	Relative Humidity :	45~47%

Channel	Frequency (MHz)	20dB Bandwidth (MHz)
00	2402	1.264
39	2441	1.240
78	2480	1.240

20 dB Bandwidth Plot on Channel 00

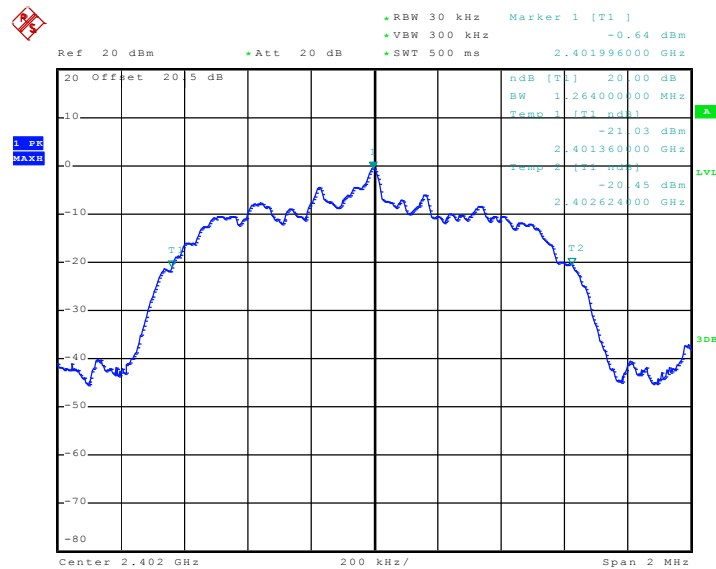

Date: 11.NOV.2009 17:44:57





20 dB Bandwidth Plot on Channel 39

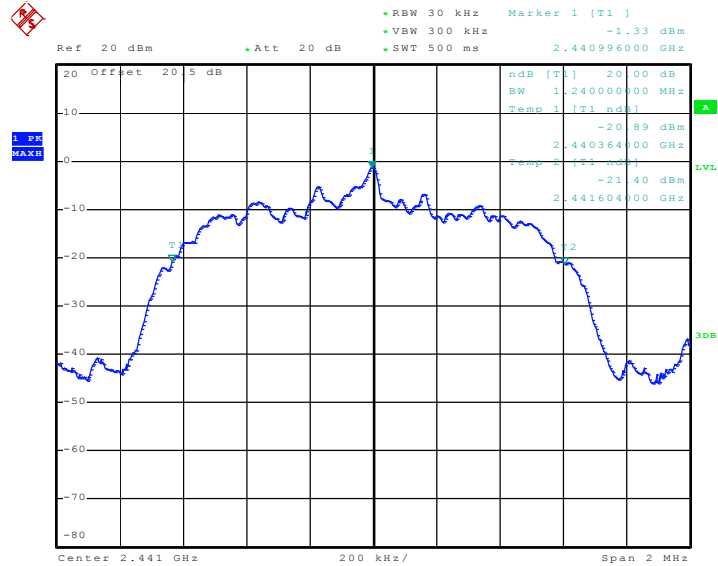

Date: 11.NOV.2009 17:44:31

20 dB Bandwidth Plot on Channel 78

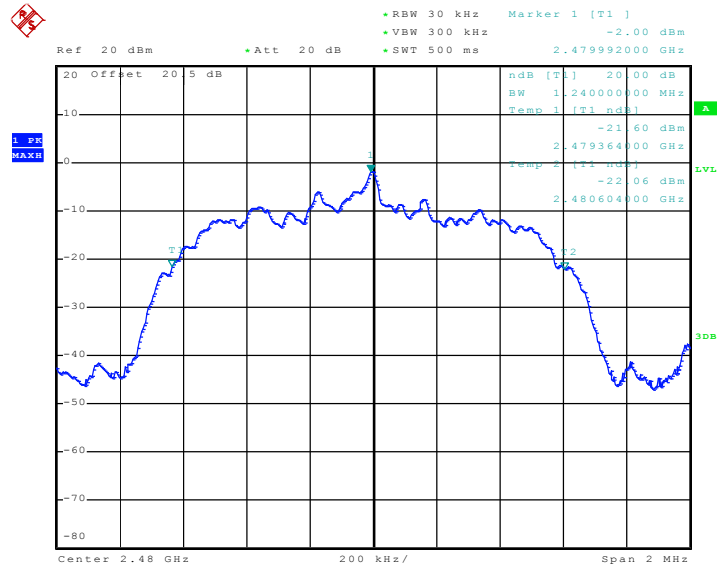

Date: 11.NOV.2009 17:44:11



Test Mode :	Mode 7, 8, 9	Temperature :	25~27°C
Test Engineer :	Ken Hsu	Relative Humidity :	45~47%

Channel	Frequency (MHz)	20dB Bandwidth (MHz)
00	2402	1.264
39	2441	1.260
78	2480	1.260

20 dB Bandwidth Plot on Channel 00

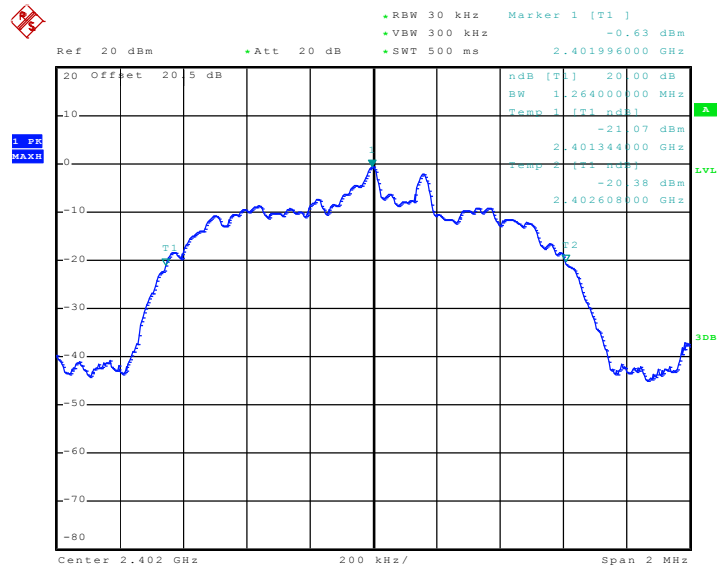

Date: 11.NOV.2009 17:42:57



20 dB Bandwidth Plot on Channel 39

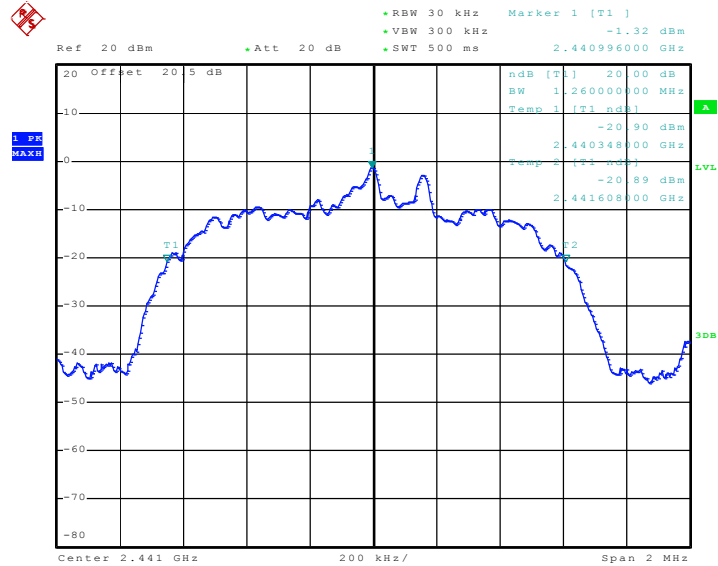

Date: 11.NOV.2009 17:43:19

20 dB Bandwidth Plot on Channel 78

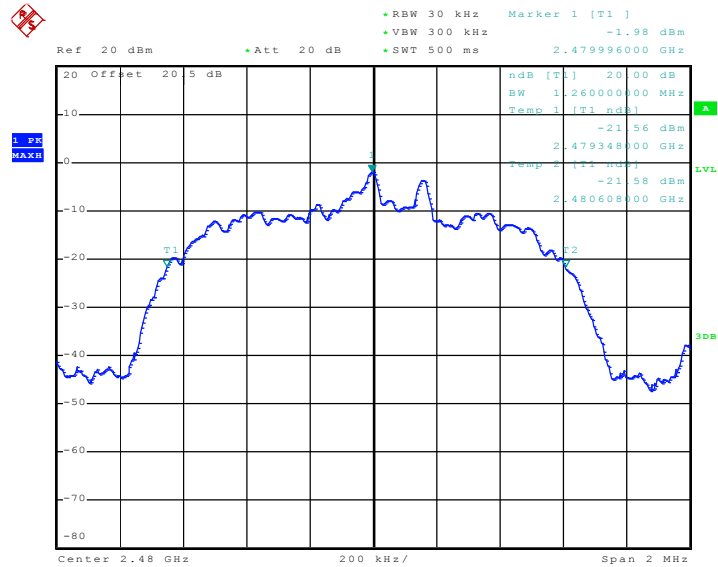

Date: 11.NOV.2009 17:43:43

### 3.3 Hopping Channel Separation Measurement

#### 3.3.1 Limit of Hopping Channel Separation

Frequency hopping systems operating in the 2400-2483.5 MHz band may have hopping channel carrier frequencies that are separated by 25 kHz or two-thirds of the 20 dB bandwidth of the hopping channel, whichever is greater.

#### 3.3.2 Measuring Instruments

See list of measuring instruments of this test report.

#### 3.3.3 Test Procedures

1. Please refer FCC Public Notice DA 00-705 Measurement Guidelines.
2. The RF output of EUT was connected to the spectrum analyzer by a low loss cable.
3. The EUT should be transmitting at its maximum data rate as the worst cases.
4. Use the following spectrum analyzer settings:  
Span = wide enough to capture the peaks of two adjacent channels;  $RBW \geq 1\%$  of the span;  
VBW  $\geq$  RBW; Sweep = auto; Detector function = peak; Trace = max hold.
5. Use the marker-delta function to determine the separation between the peaks of the adjacent channels.

#### 3.3.4 Test Setup

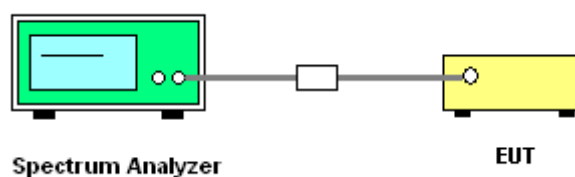



### 3.3.5 Test Result of Hopping Channel Separation

Test Mode :	Mode 7, 8, 9	Temperature :	25~27°C
Test Engineer :	Ken Hsu	Relative Humidity :	45~47%

Channel	Frequency (MHz)	Frequency Separation (MHz)	(2/3 of 20dB BW) Limits (MHz)	Pass/Fail
00	2402	1.000	0.843	Pass
39	2441	1.000	0.840	Pass
78	2480	1.000	0.840	Pass

Channel Separation Plot on Channel 00 - 01

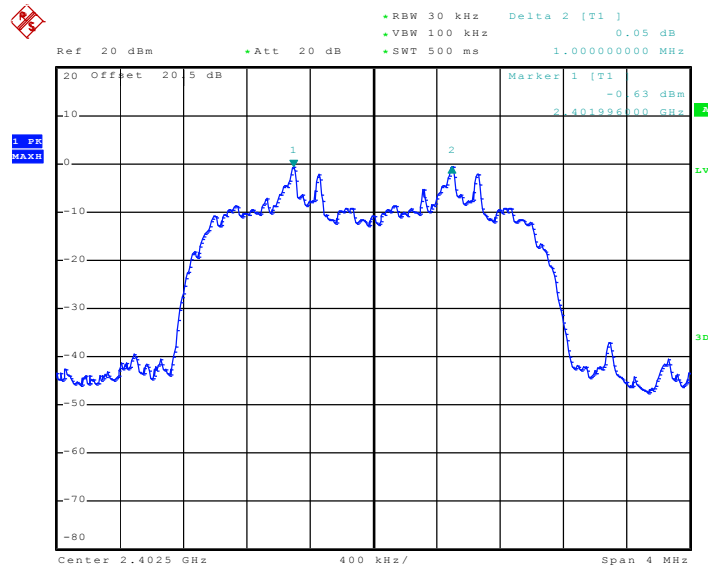

Date: 11.NOV.2009 17:52:10



Channel Separation Plot on Channel 39 - 40

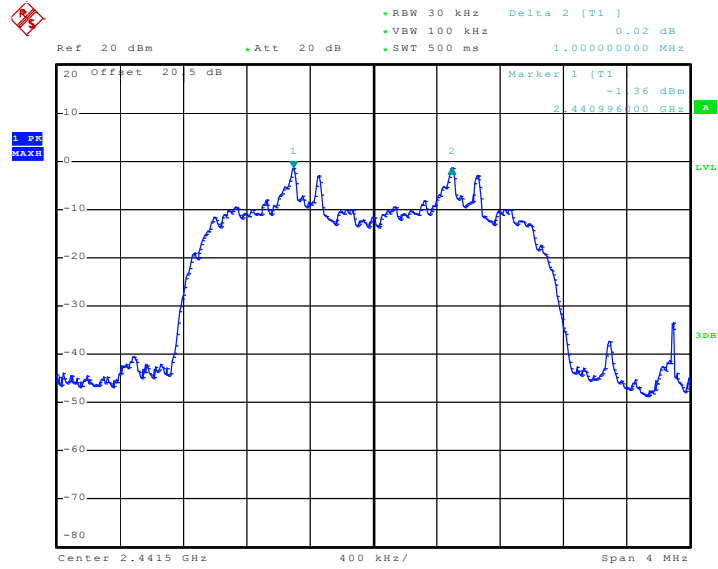

Date: 11.NOV.2009 17:52:39

Channel Separation Plot on Channel 77 - 78

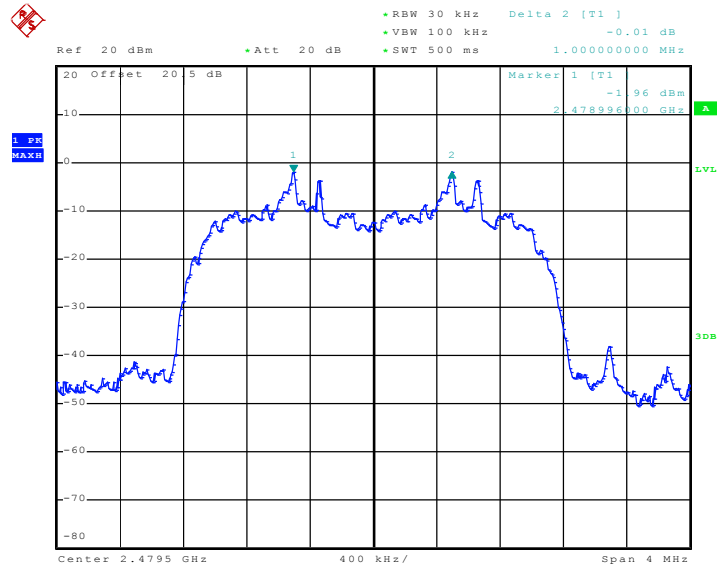

Date: 11.NOV.2009 17:53:00

### 3.4 Dwell Time Measurement

#### 3.4.1 Limit of Dwell Time

The average time of occupancy on any channel shall not be greater than 0.4 seconds within a period of 0.4 seconds multiplied by the number of hopping channels employed.

#### 3.4.2 Measuring Instruments

See list of measuring instruments of this test report.

#### 3.4.3 Test Procedures

1. The testing follows FCC Public Notice DA 00-705 Measurement Guidelines.
2. The RF output of EUT was connected to the spectrum analyzer by a low loss cable.
3. The EUT should be transmitting at its maximum data rate as the worst cases.
4. The EUT must have its hopping function enabled. Use the following spectrum analyzer settings:  
Span = zero span, centered on a hopping channel; RBW = 1 MHz; VBW ≥ RBW; Sweep = as necessary to capture the entire dwell time per hopping channel; Detector function = peak; Trace = max hold.
5. Use the marker-delta function to calculate the dwell time.

#### 3.4.4 Test Setup

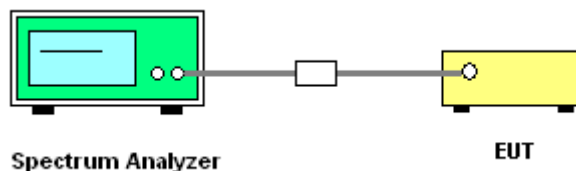

#### 3.4.5 Test Result of Dwell Time

<b>Test Mode :</b>	Mode 8	<b>Temperature :</b>	25~27°C		
<b>Test Engineer :</b>	Ken Hsu	<b>Relative Humidity :</b>	45~47%		
Package Mode	Average Hopping Channel	Package Transfer Time (usec)	Dwell Time (sec)	Limits (sec)	Pass/Fail
3DH5	3.90	3046.00	0.38	0.4	Pass

**Remark:**

1. Dwell Time=79(channels) x 0.4(s) x average hopping channel x package transfer time
2. 79 channels come from the Hopping Channel number.
3. Average Hopping Channel = hops/sweep time
4. t: Package Transfer Time(us)



### 3DH5 Dwell Time (One Pulse) Plot on Channel 39

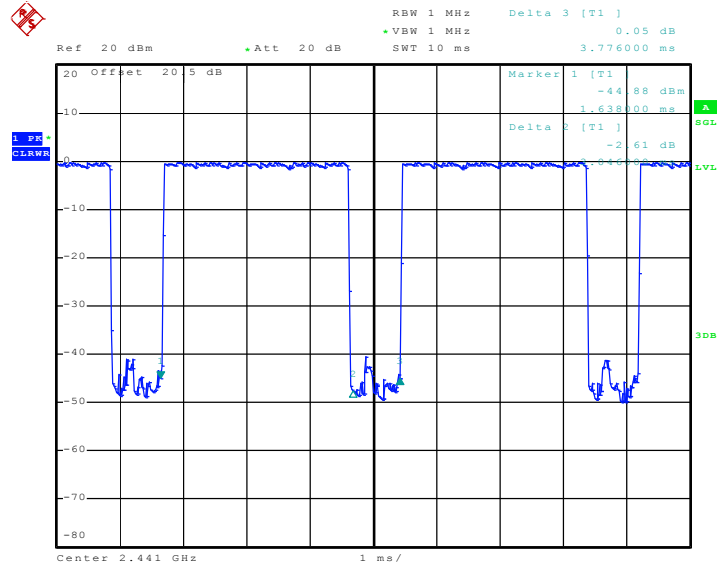

Date: 11.NOV.2009 18:02:43

### 3DH5 Dwell Time (Count Pulses) Plot on Channel 39

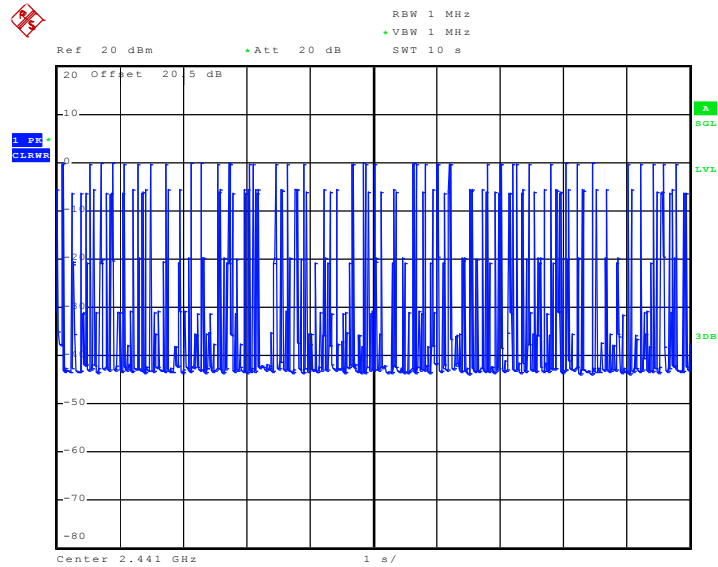

Date: 11.NOV.2009 18:05:58



### 3.5 Peak Output Power Measurement

#### 3.5.1 Limit of Peak Output Power

Frequency hopping systems operating in the 2400-2483.5 MHz band employing at least 75 non-overlapping hopping channels: 1W (30 dBm).

#### 3.5.2 Measuring Instruments

See list of measuring instruments of this test report.

#### 3.5.3 Test Procedures

1. The testing follows FCC Public Notice DA 00-705 Measurement Guidelines.
2. The RF output of EUT was connected to the spectrum analyzer by a low loss cable.

#### 3.5.4 Test Setup

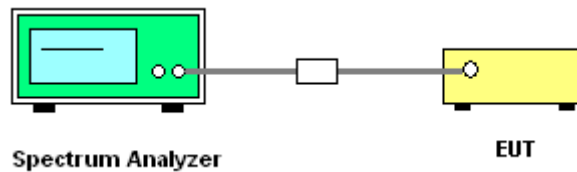

#### 3.5.5 Test Result of Peak Output Power

<b>Test Mode :</b>	Mode 7, 8, 9	<b>Temperature :</b>	25~27°C
<b>Test Engineer :</b>	Ken Hsu	<b>Relative Humidity :</b>	45~47%

Channel	Frequency (MHz)	RF Power (dBm)		
		8-DPSK	Max. Limits (dBm)	Pass/Fail
		3 Mbps		
00	2402	1.01	30	Pass
39	2441	0.26	30	Pass
78	2480	-0.37	30	Pass



Peak Output Power Plot on Channel 00

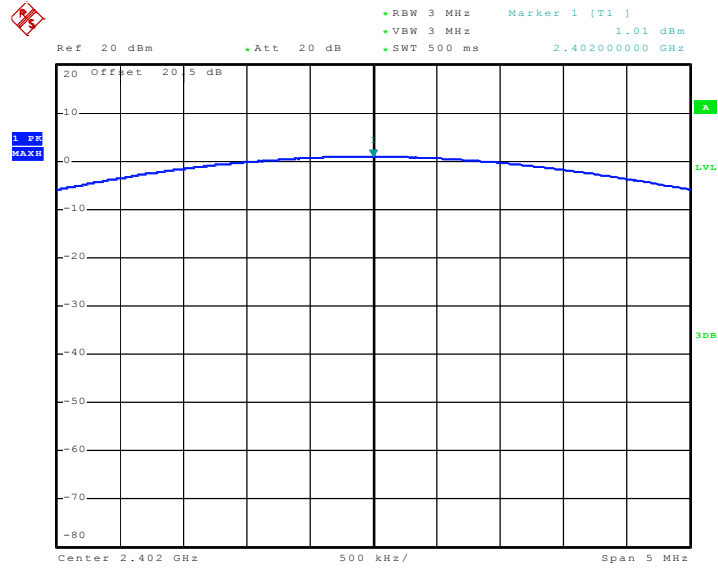

Date: 11.NOV.2009 17:03:58

Peak Output Power Plot on Channel 39

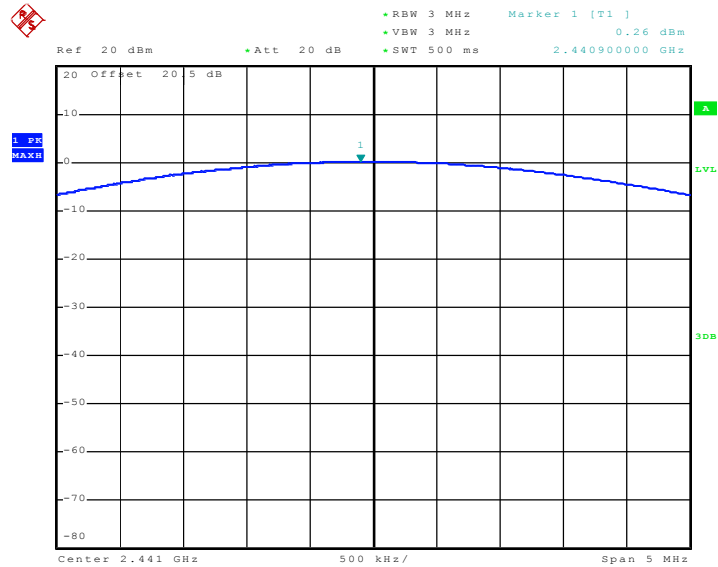

Date: 11.NOV.2009 17:06:24



Peak Output Power Plot on Channel 78

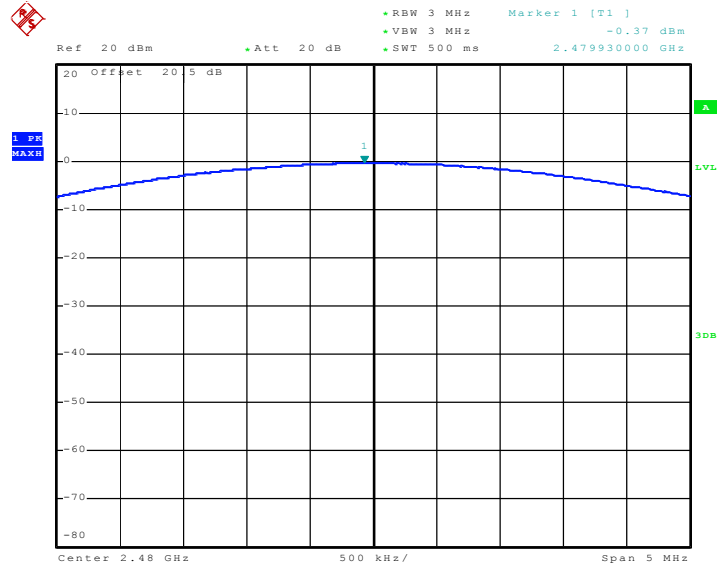

Date: 11.NOV.2009 17:08:01



## **3.6 Band Edges Measurement**

### **3.6.1 Limit of Band Edges**

In any 100 kHz bandwidth outside the intentional radiation frequency band, the radio frequency power shall be at least 20 dB below the highest level of the radiated power. In addition, radiated emissions which fall in the restricted bands must also comply with the radiated emission limits.

### **3.6.2 Measuring Instruments**

See list of measuring instruments of this test report.

### **3.6.3 Test Procedures**

1. The testing follows the guidelines in ANSI C63.4-2003 and FCC Public Notice DA 00-705 Measurement Guidelines.
2. RF antenna conducted test: Set RBW = 1MHz, Video bandwidth (VBW)  $\geq$  RBW. Band edge emissions must be at least 20 dB down from the highest emission level within the authorized band as measured with a 1MHz RBW. Note: If the device complies with the use of power option 2 the attenuation under this paragraph shall be 30 dB instead of 20 dB.
3. Radiated emission test: Applies to band edge emissions that fall in the restricted bands listed in FCC Section 15.205. The maximum permitted average field strength is listed in FCC Section 15.209. A pre-amp is necessary for this measurement. For measurements above 1 GHz, set RBW = 1MHz, VBW = 1MHz, Sweep: Auto for Peak; set RBW = 1MHz, VBW = 10 Hz, Sweep: Auto for Average. If the emission is pulsed, modify the unit for continuous operation; use the settings shown above, then correct the reading by subtracting the peak-average correction factor, derived from the appropriate duty cycle calculation. See FCC Section 15.35(b) and (c).
4. In case the emission is fail due to the used RBW / VBW is too wide, marker-delta method of FCC Public Notice DA 00-705 will be followed.

### 3.6.4 Test Setup

#### <Radiated Band Edges>

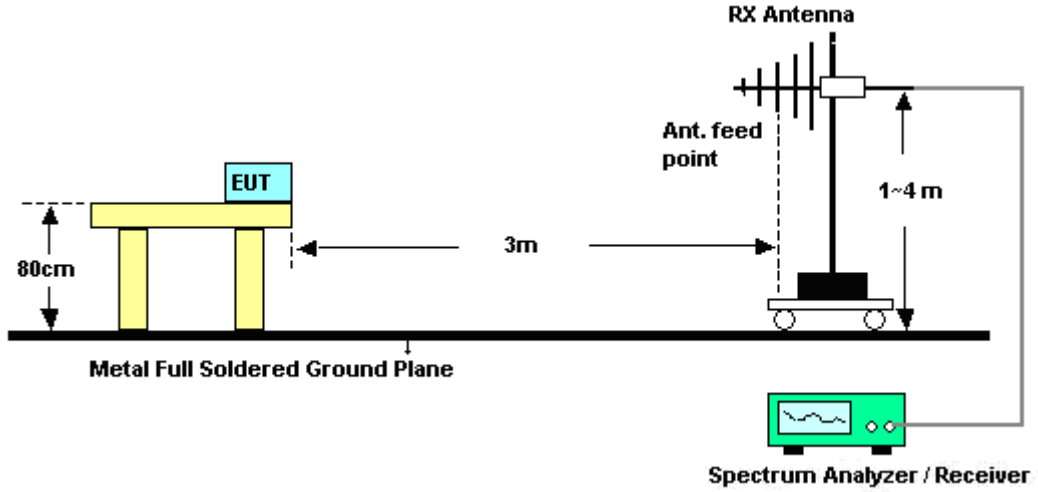

#### <Conducted Band Edges>

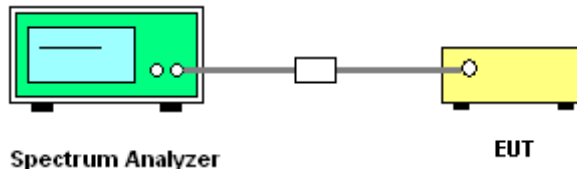



3.6.5 Test Result of Radiated Band Edges

Test Mode :	Mode 1	Temperature :	23~24°C
Test Channel :	00	Relative Humidity :	46~47%
		Test Engineer :	Mac Lin

ANTENNA POLARITY : HORIZONTAL										
Frequency ( MHz )	Level ( dBuV/m )	Over Limit ( dB )	Limit Line ( dBuV/m )	Read Level ( dBuV )	Antenna Factor ( dB )	Cable Loss ( dB )	Preamp Factor ( dB )	Ant Pos ( cm )	Table Pos ( deg )	Remark
2382.58	44.92	-29.08	74.00	45.44	31.83	3.92	36.28	109	349	Peak
2382.58	32.29	-21.71	54.00	32.81	31.83	3.92	36.28	109	349	Average

ANTENNA POLARITY : VERTICAL										
Frequency ( MHz )	Level ( dBuV/m )	Over Limit ( dB )	Limit Line ( dBuV/m )	Read Level ( dBuV )	Antenna Factor ( dB )	Cable Loss ( dB )	Preamp Factor ( dB )	Ant Pos ( cm )	Table Pos ( deg )	Remark
2381.82	44.29	-29.71	74.00	44.81	31.83	3.92	36.28	100	308	Peak
2381.82	31.29	-22.71	54.00	31.81	31.83	3.92	36.28	100	308	Average

Test Mode :	Mode 3	Temperature :	23~24°C
Test Channel :	78	Relative Humidity :	46~47%
		Test Engineer :	Mac Lin

ANTENNA POLARITY : HORIZONTAL										
Frequency ( MHz )	Level ( dBuV/m )	Over Limit ( dB )	Limit Line ( dBuV/m )	Read Level ( dBuV )	Antenna Factor ( dB )	Cable Loss ( dB )	Preamp Factor ( dB )	Ant Pos ( cm )	Table Pos ( deg )	Remark
2483.50	62.10	-11.90	74.00	62.37	31.98	4.05	36.30	103	354	Peak
2483.50	47.58	-6.42	54.00	47.85	31.98	4.05	36.30	103	354	Average

ANTENNA POLARITY : VERTICAL										
Frequency ( MHz )	Level ( dBuV/m )	Over Limit ( dB )	Limit Line ( dBuV/m )	Read Level ( dBuV )	Antenna Factor ( dB )	Cable Loss ( dB )	Preamp Factor ( dB )	Ant Pos ( cm )	Table Pos ( deg )	Remark
2483.50	55.45	-18.55	74.00	55.72	31.98	4.05	36.30	100	95	Peak
2483.50	42.28	-11.72	54.00	42.55	31.98	4.05	36.30	100	95	Average



### 3.6.6 Test Result of Conducted Band Edges

Test Mode :	Mode 7 and 9	Temperature :	25~27°C
Test Channel :	00 and 78	Relative Humidity :	45~47%
		Test Engineer :	Ken Hsu

Low Band Edge Plot on Channel 00

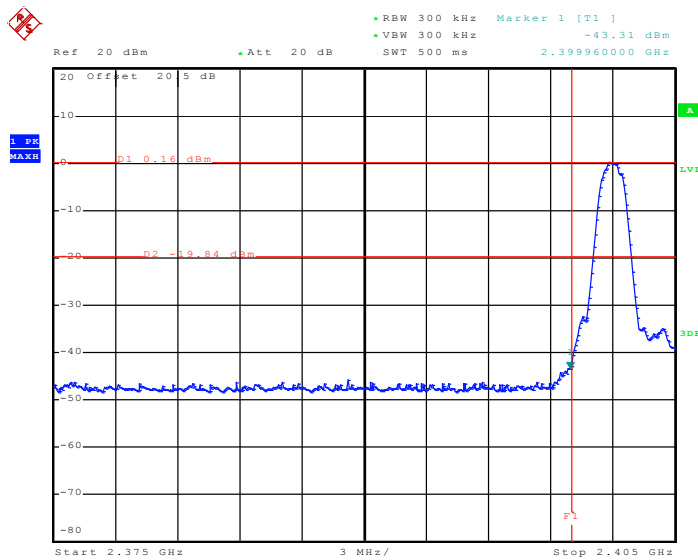

Date: 11.NOV.2009 17:33:41

High Band Edge Plot on Channel 78

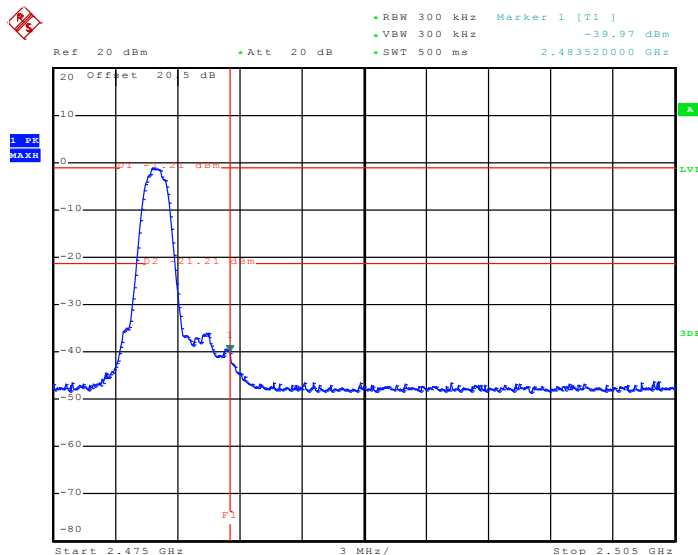

Date: 11.NOV.2009 17:34:58

## 3.7 Spurious Emission Measurement

### 3.7.1 Limit of Spurious Emission Measurement

All harmonics/spurs must be at least 20 dB down from the highest emission level within the authorized band.

### 3.7.2 Measuring Instruments

See list of measuring instruments of this test report.

### 3.7.3 Test Procedure

1. The transmitter output was connected to the spectrum analyzer via a low lose cable.
2. Set RBW = 100 kHz, Video bandwidth (VBW)  $\geq$  RBW, scan up through 10th harmonic. All harmonics / spurs must be at least 20 dB down from the highest emission level within the authorized band as measured with a 100 kHz RBW.

### 3.7.4 Test Setup

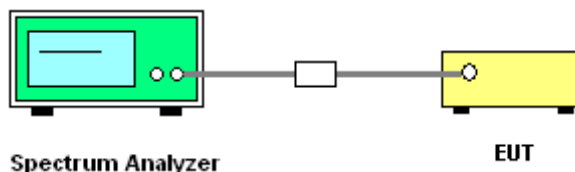





3.7.5 Test Result

Test Mode :	Mode 7	Temperature :	25~27°C
Test Channel :	00	Relative Humidity :	45~47%
		Test Engineer :	Ken Hsu

Conducted Spurious Emission Plot between 9 kHz ~ 3 GHz

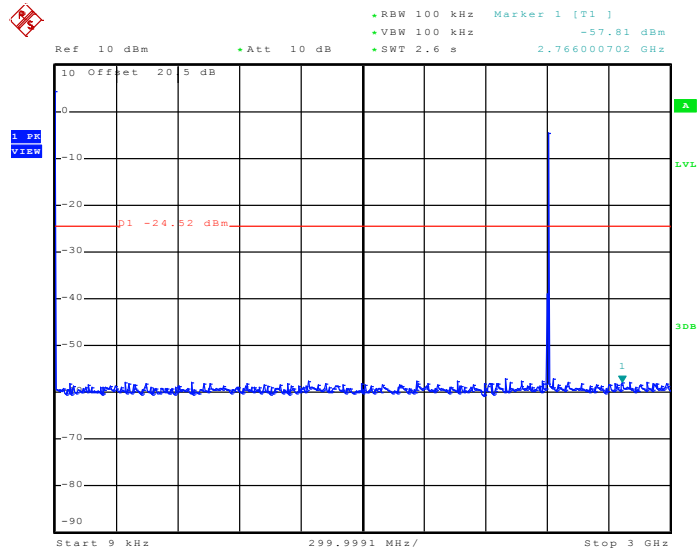

Date: 11.NOV.2009 17:20:19

Conducted Spurious Emission Plot between 1 GHz ~ 25 GHz

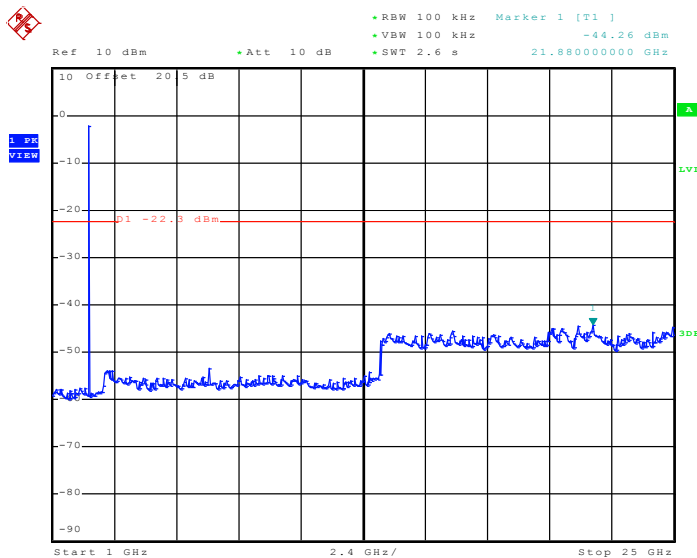

Date: 11.NOV.2009 17:20:28



Test Mode :	Mode 8	Temperature :	25~27°C
Test Channel :	39	Relative Humidity :	45~47%
		Test Engineer :	Ken Hsu

Conducted Spurious Emission Plot between 9 kHz ~ 3 GHz

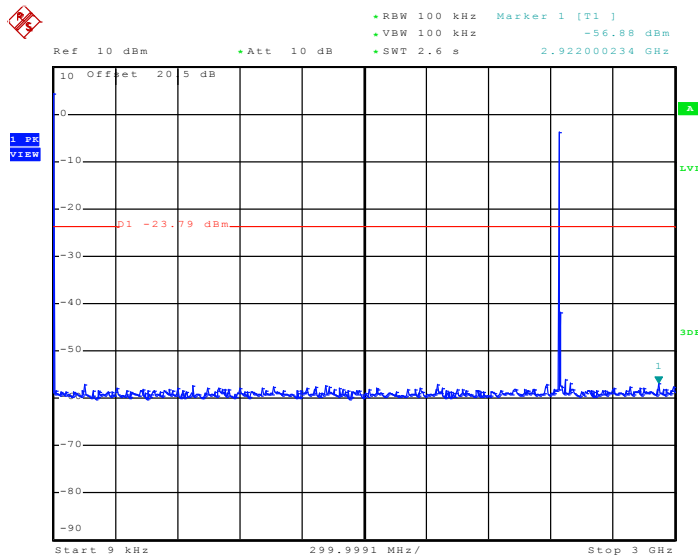

Date: 11.NOV.2009 17:20:46

Conducted Spurious Emission Plot between 1 GHz ~ 25 GHz

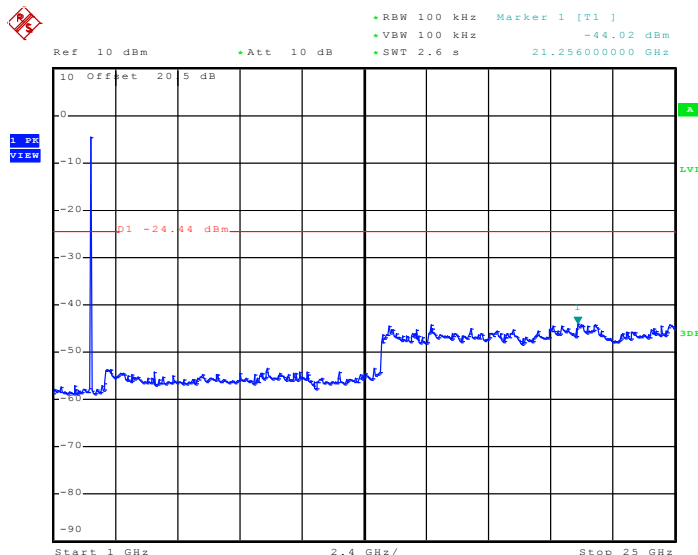

Date: 11.NOV.2009 17:21:25



Test Mode :	Mode 9	Temperature :	25~27°C
Test Channel :	78	Relative Humidity :	45~47%
		Test Engineer :	Ken Hsu

Conducted Spurious Emission Plot between 9 kHz ~ 3 GHz

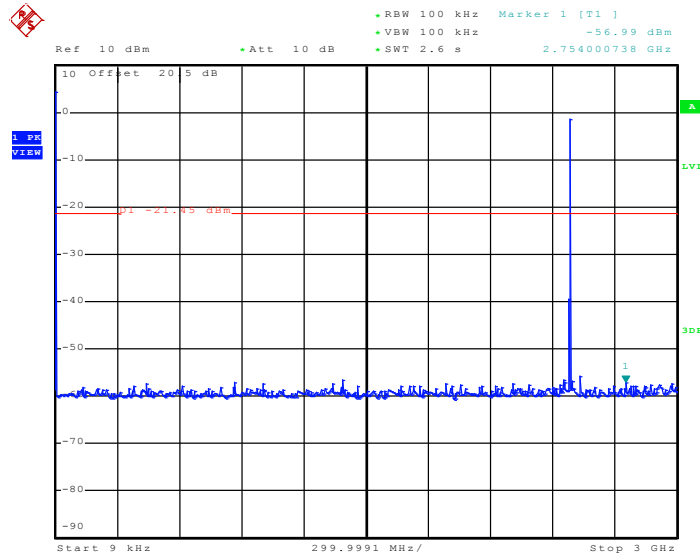

Date: 11.NOV.2009 17:21:36

Conducted Spurious Emission Plot between 1 GHz ~ 25 GHz

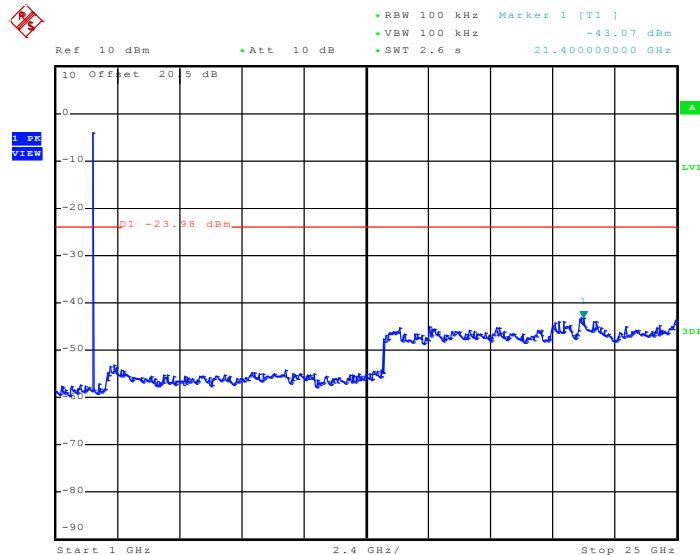

Date: 11.NOV.2009 17:22:00

### 3.8 AC Conducted Emission Measurement

#### 3.8.1 Limit of AC Conducted Emission

For equipment that is designed to be connected to the public utility (AC) power line, the radio frequency voltage that is conducted back onto the AC power line on any frequency or frequencies within the band 150 kHz to 30 MHz shall not exceed the limits in the following table.

Frequency of emission (MHz)	Conducted limit (dBuV)	
	Quasi-peak	Average
0.15-0.5	66 to 56*	56 to 46*
0.5-5	56	46
5-30	60	50

\*Decreases with the logarithm of the frequency.

#### 3.8.2 Measuring Instruments

See list of measuring instruments of this test report.

#### 3.8.3 Test Procedures

1. Please follow the guidelines in ANSI C63.4-2003.
2. The EUT was placed 0.4 meter from the conducting wall of the shielding room was kept at least 80 centimeters from any other grounded conducting surface.
3. Connect EUT to the power mains through a line impedance stabilization network (LISN).
4. All the support units are connecting to the other LISN.
5. The LISN provides 50 ohm coupling impedance for the measuring instrument.
6. The FCC states that a 50 ohm, 50 microhenry LISN should be used.
7. Both sides of AC line were checked for maximum conducted interference.
8. The frequency range from 150 kHz to 30 MHz was searched.
9. Set the test-receiver system to Peak Detect Function and specified bandwidth with Maximum Hold Mode.

### 3.8.4 Test Setup

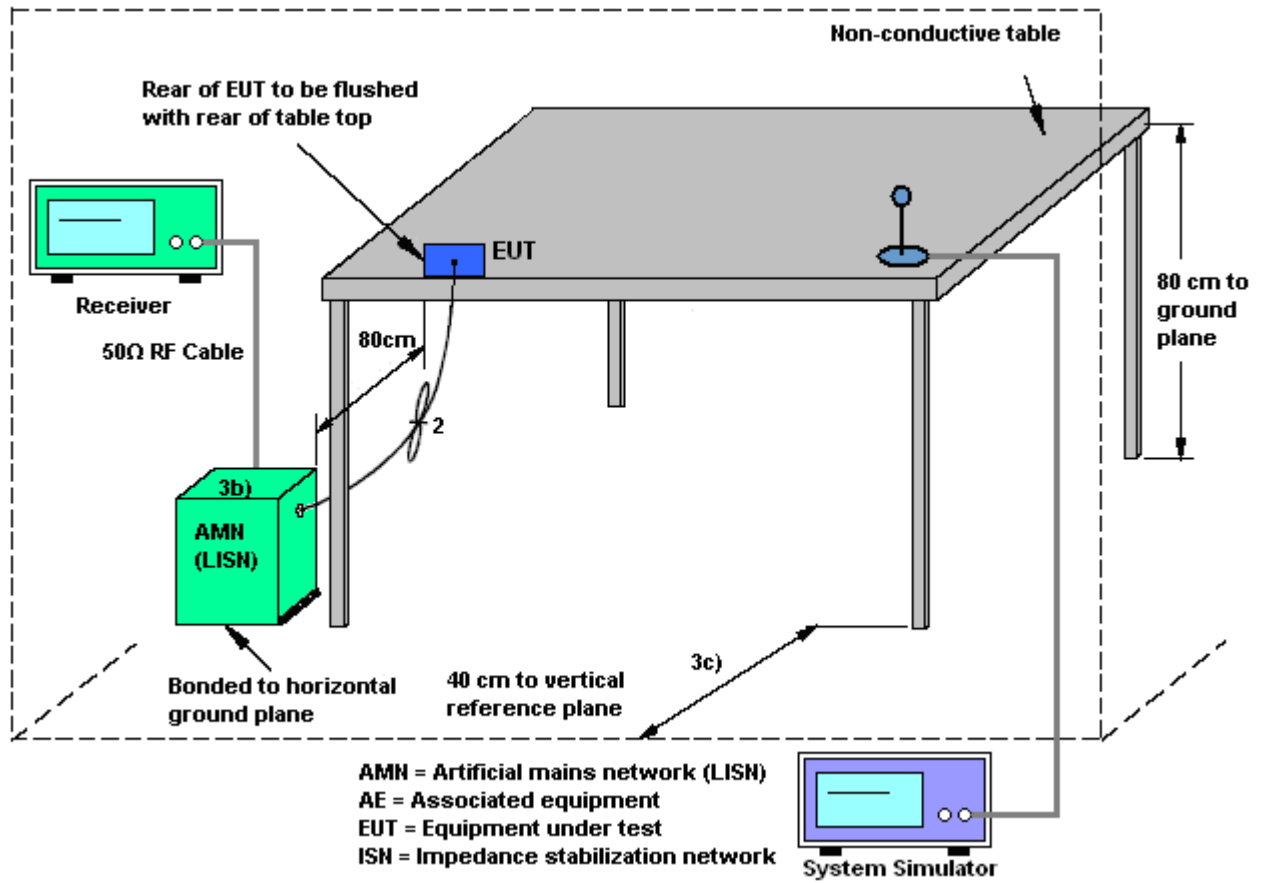

3.8.5 Test Result of AC Conducted Emission

Test Mode :	Mode 1	Temperature :	22~24°C
Test Engineer :	Hayden Wu	Relative Humidity :	48~51%
Test Voltage :	120Vac / 60Hz	Phase :	Line
Function Type :	GPRS850 Idle + Bluetooth Link + Camera + USB Cable (Link with Notebook)		
Remark :	All emissions not reported here are more than 10 dB below the prescribed limit.		

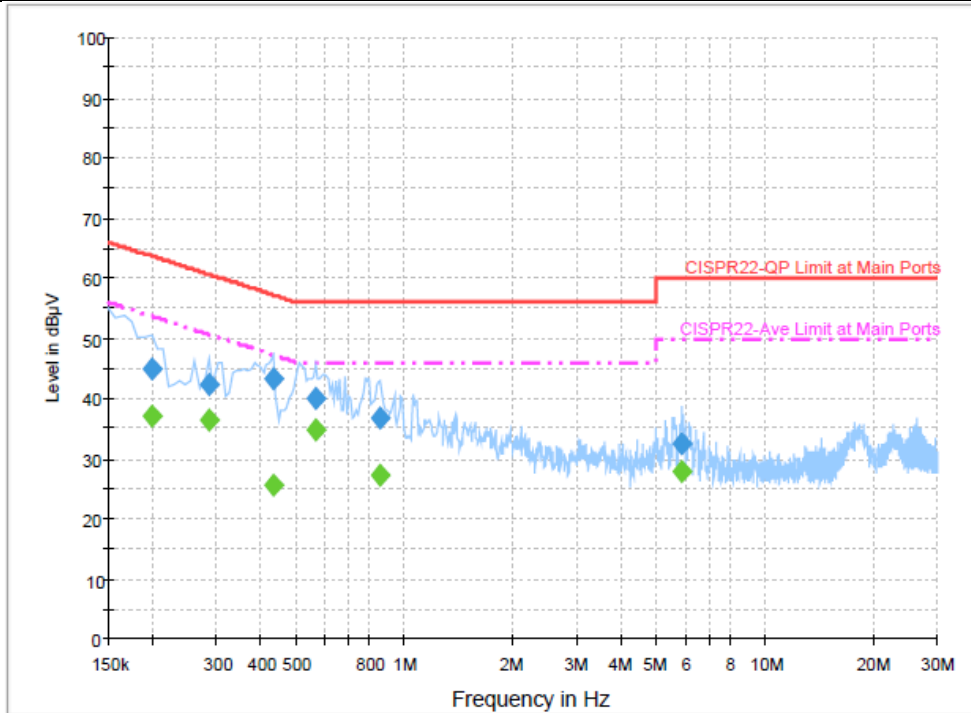

Final Result 1

Frequency (MHz)	QuasiPeak (dBµV)	Filter	Line	Corr. (dB)	Margin (dB)	Limit (dBµV)
0.198000	45.1	Off	L1	19.6	18.6	63.7
0.286000	42.2	Off	L1	19.5	18.4	60.6
0.430000	43.2	Off	L1	19.5	14.1	57.3
0.566000	40.1	Off	L1	19.5	15.9	56.0
0.854000	36.6	Off	L1	19.5	19.4	56.0
5.862000	32.5	Off	L1	19.6	27.5	60.0

Final Result 2

Frequency (MHz)	Average (dBµV)	Filter	Line	Corr. (dB)	Margin (dB)	Limit (dBµV)
0.198000	37.1	Off	L1	19.6	16.6	53.7
0.286000	36.5	Off	L1	19.5	14.1	50.6
0.430000	25.6	Off	L1	19.5	21.7	47.3
0.566000	34.8	Off	L1	19.5	11.2	46.0
0.854000	27.1	Off	L1	19.5	18.9	46.0
5.862000	27.8	Off	L1	19.6	22.2	50.0



Test Mode :	Mode 1	Temperature :	22~24°C
Test Engineer :	Hayden Wu	Relative Humidity :	48~51%
Test Voltage :	120Vac / 60Hz	Phase :	Neutral
Function Type :	GPRS850 Idle + Bluetooth Link + Camera + USB Cable (Link with Notebook)		
Remark :	All emissions not reported here are more than 10 dB below the prescribed limit.		

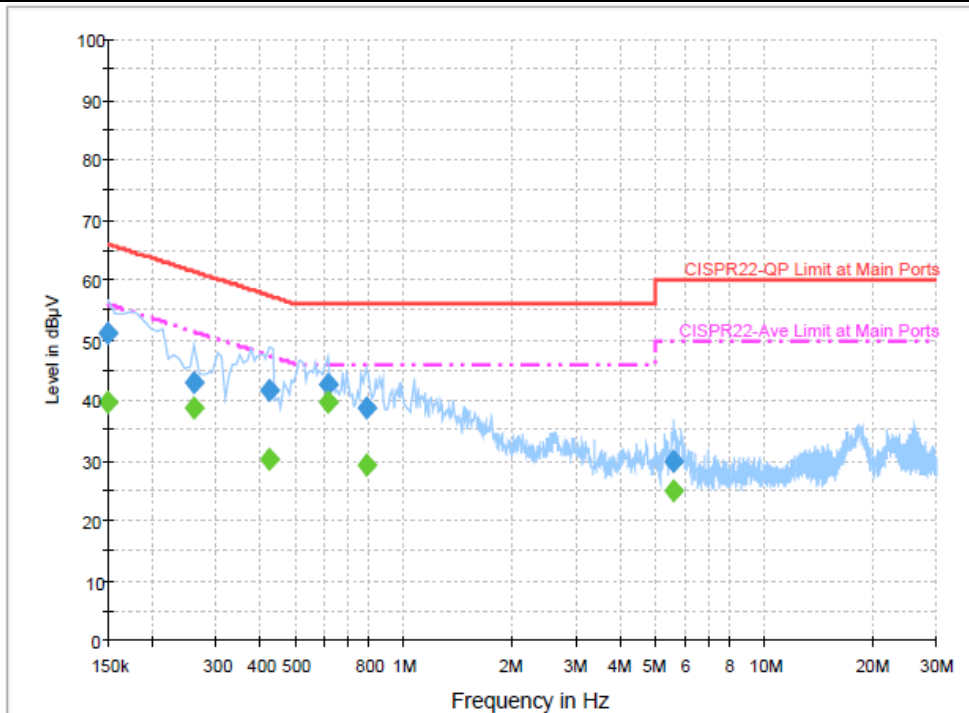

**Final Result 1**

Frequency (MHz)	QuasiPeak (dBµV)	Filter	Line	Corr. (dB)	Margin (dB)	Limit (dBµV)
0.150000	51.3	Off	N	19.6	14.7	66.0
0.262000	42.8	Off	N	19.5	18.6	61.4
0.422000	41.6	Off	N	19.5	15.8	57.4
0.614000	42.5	Off	N	19.5	13.5	56.0
0.790000	38.6	Off	N	19.5	17.4	56.0
5.606000	29.7	Off	N	19.5	30.3	60.0

**Final Result 2**

Frequency (MHz)	Average (dBµV)	Filter	Line	Corr. (dB)	Margin (dB)	Limit (dBµV)
0.150000	39.5	Off	N	19.6	16.5	56.0
0.262000	38.7	Off	N	19.5	12.7	51.4
0.422000	30.2	Off	N	19.5	17.2	47.4
0.614000	39.6	Off	N	19.5	6.4	46.0
0.790000	29.3	Off	N	19.5	16.7	46.0
5.606000	24.9	Off	N	19.5	25.1	50.0

## 3.9 Radiated Emission Measurement

### 3.9.1 Limit of Radiated Emission

In any 100 kHz bandwidth outside the intentional radiator frequency band, all harmonics/spurious must be at least 20 dB below the highest emission level within the authorized band. In addition, radiated emissions which fall in the restricted bands must also comply with the FCC section 15.209 limits as below.

Frequency (MHz)	Field Strength (microvolts/meter)	Measurement Distance (meters)
0.009 – 0.490	2400/F(kHz)	300
0.490 – 1.705	24000/F(kHz)	30
1.705 – 30.0	30	30
30 – 88	100	3
88 – 216	150	3
216 - 960	200	3
Above 960	500	3

### 3.9.2 Measuring Instruments

See list of measuring instruments of this test report.

### 3.9.3 Test Procedures

1. The testing follows the guidelines in FCC Public Notice DA 00-705 Measurement Guidelines.
2. Use the following spectrum analyzer settings:  
Span = wide enough to fully capture the emission being measured; RBW = 1 MHz for  $f \geq 1$  GHz, 100 kHz for  $f < 1$  GHz; VBW  $\geq$  RBW; Sweep = auto; Detector function = peak; Trace = max hold.
3. Follow the guidelines in ANSI C63.4-2003 with respect to maximizing the emission by rotating the EUT, measuring the emission for three EUT orthogonal planes, and adjusting the measurement antenna height and polarization. A pre-amp and a high pass filter are used for this test in order to get the good signal level.



### 3.9.4 Test Setup

For radiated emissions below 30MHz

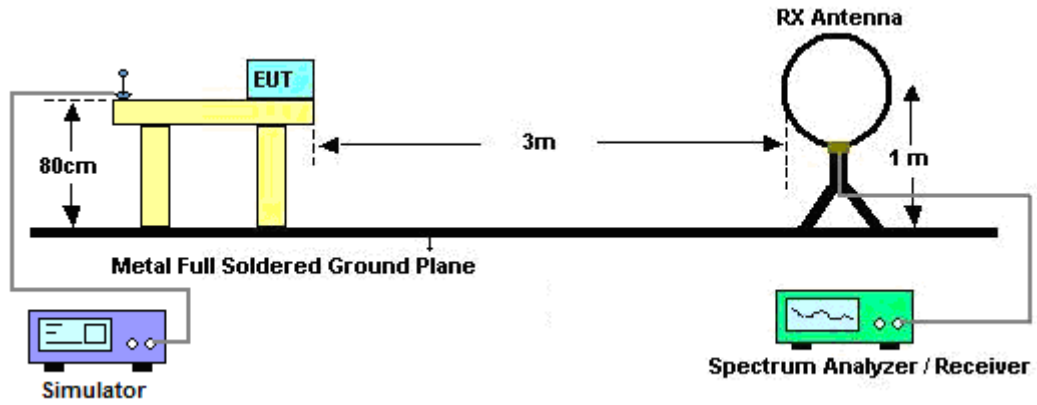

For radiated emissions above 30MHz

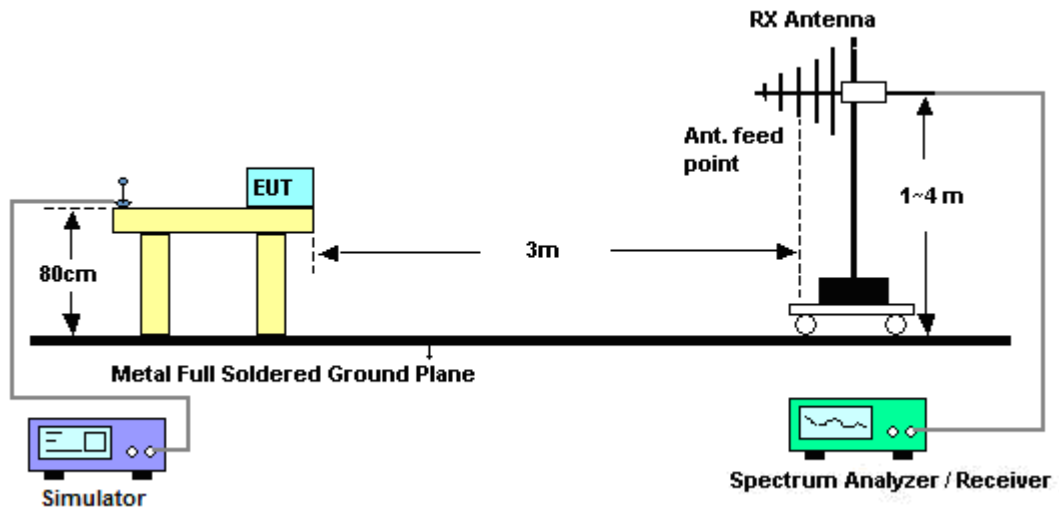



3.9.5 Test Results of Radiated Emissions (9 kHz ~ 30 MHz)

Test Engineer :	Mac Lin	Temperature :	23~24°C	
		Relative Humidity :	46~47%	
Frequency (MHz)	Level (dBuV)	Over Limit (dB)	Limit Line (dBuV)	Remark
-	-	-	-	See Note

Note:

The amplitude of spurious emissions that are attenuated by more than 20dB below the permissible value has no need to be reported.

Distance extrapolation factor =  $40 \log(\text{specific distance} / \text{test distance})$  (dB);

Limit line = specific limits (dBuV) + distance extrapolation factor.



3.9.6 Test Result of Radiated Emission (30 MHz ~ 10<sup>th</sup> Harmonic)

Test Mode :	Mode 1	Temperature :	23~24°C
Test Channel :	00	Relative Humidity :	46~47%
Test Engineer :	Mac Lin	Polarization :	Horizontal
Remark :	#9 and #10 are Fundamental Signals which can be ignored.		

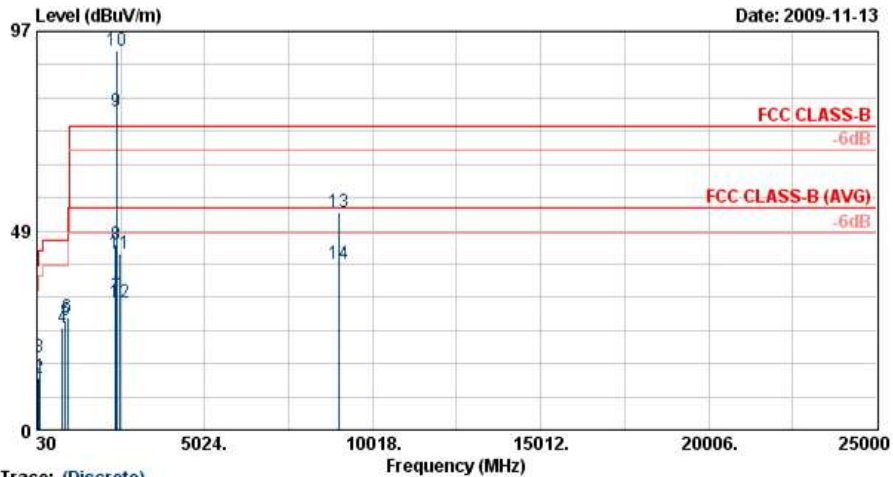

Site : 03CH06-HY  
 Condition : FCC CLASS-B 3m SHF-EHF HORN HORIZONTAL  
 Project : FR 971509-03

	Freq	Level	Over	Limit	Read	Antenna	Cable	Preamp	Ant	Table	Remark
	MHz	dBuV/m	dB	dBuV/m	dBuV	dB/m	dB	dB	cm	deg	
1	30.00	18.19	-21.81	40.00	30.41	18.51	0.83	31.56	---	---	Peak
2	74.28	12.71	-27.29	40.00	36.25	6.94	1.33	31.81	---	---	Peak
3	101.28	17.82	-25.68	43.50	37.32	10.87	1.65	32.02	---	---	Peak
4	782.30	25.04	-20.96	46.00	32.20	19.92	5.05	32.14	---	---	Peak
5	882.40	26.75	-19.25	46.00	32.65	20.61	5.41	31.92	---	---	Peak
6	936.30	27.27	-18.73	46.00	32.36	20.88	5.53	31.50	100	30	Peak
7	2382.58	32.29	-21.71	54.00	32.81	31.83	3.92	36.28	109	349	Average
8	2382.58	44.92	-29.08	74.00	45.44	31.83	3.92	36.28	109	349	Peak
9 @	2402.00	77.53			78.03	31.86	3.92	36.28	109	349	Average
10 @	2402.00	92.30			92.78	31.88	3.92	36.28	109	349	Peak
11	2500.00	42.86	-31.14	74.00	43.11	32.00	4.05	36.30	109	349	Peak
12	2500.00	30.92	-23.08	54.00	31.17	32.00	4.05	36.30	109	349	Average
13	9000.00	52.88	-21.12	74.00	45.88	36.10	7.80	36.90	100	255	Peak
14	9000.00	40.41	-13.59	54.00	33.41	36.10	7.80	36.90	100	255	Average



Test Mode :	Mode 1	Temperature :	23~24°C
Test Channel :	00	Relative Humidity :	46~47%
Test Engineer :	Mac Lin	Polarization :	Vertical
Remark :	#9 and #10 are Fundamental Signals which can be ignored.		

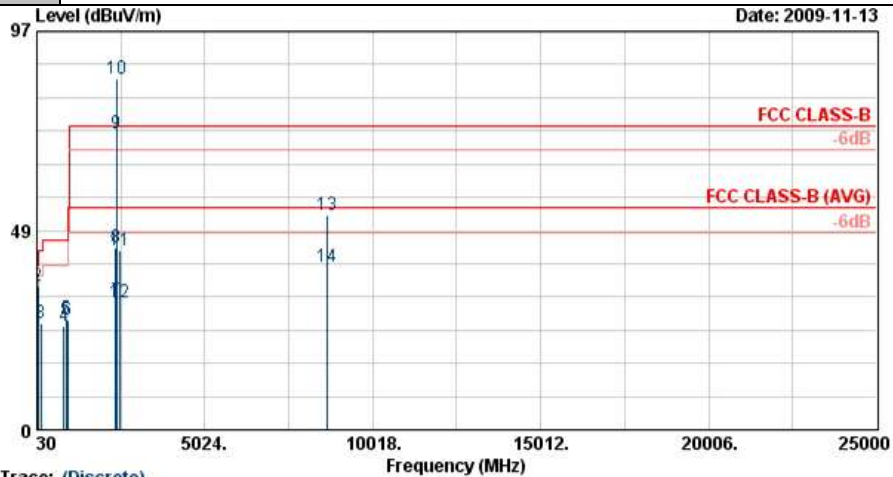

Trace: (Discrete)  
 Site : 03CH06-HY  
 Condition : FCC CLASS-B 3m SHF-EHF HORN VERTICAL  
 Project : FR 971509-03

	Freq	Level	Over	Limit	Read	Antenna	Cable	Preamp	Ant	Table	Remark
	MHz	dBuV/m	Limit	Line	Level	Factor	Loss	Factor	Pos	Pos	
			dB	dBuV/m	dBuV	dB/m	dB	dB	cm	deg	
1	56.73	21.58	-18.42	40.00	44.47	7.88	1.19	31.96	---	---	Peak
2 !	71.58	34.87	-5.13	40.00	58.59	6.73	1.33	31.78	100	299	Peak
3	150.69	26.02	-17.48	43.50	45.39	10.30	2.01	31.68	---	---	Peak
4	833.40	25.28	-20.72	46.00	32.07	20.29	5.24	32.33	---	---	Peak
5	896.40	27.04	-18.96	46.00	32.62	20.70	5.45	31.73	---	---	Peak
6	939.80	26.58	-19.42	46.00	31.62	20.89	5.54	31.48	---	---	Peak
7	2381.82	31.29	-22.71	54.00	31.81	31.83	3.92	36.28	100	308	Average
8	2381.82	44.29	-29.71	74.00	44.81	31.83	3.92	36.28	100	308	Peak
9 @	2402.00	72.16			72.66	31.86	3.92	36.28	100	308	Average
10 X	2402.00	85.63			86.11	31.88	3.92	36.28	100	308	Peak
11	2500.00	43.52	-30.48	74.00	43.77	32.00	4.05	36.30	100	308	Peak
12	2500.00	30.88	-23.12	54.00	31.13	32.00	4.05	36.30	100	308	Average
13	8661.00	52.24	-21.76	74.00	45.78	35.83	7.39	36.76	100	294	Peak
14	8661.00	39.78	-14.22	54.00	33.32	35.83	7.39	36.76	100	294	Average



Test Mode :	Mode 2	Temperature :	23~24°C
Test Channel :	39	Relative Humidity :	46~47%
Test Engineer :	Mac Lin	Polarization :	Horizontal
Remark :	#9 and #10 are Fundamental Signals which can be ignored.		

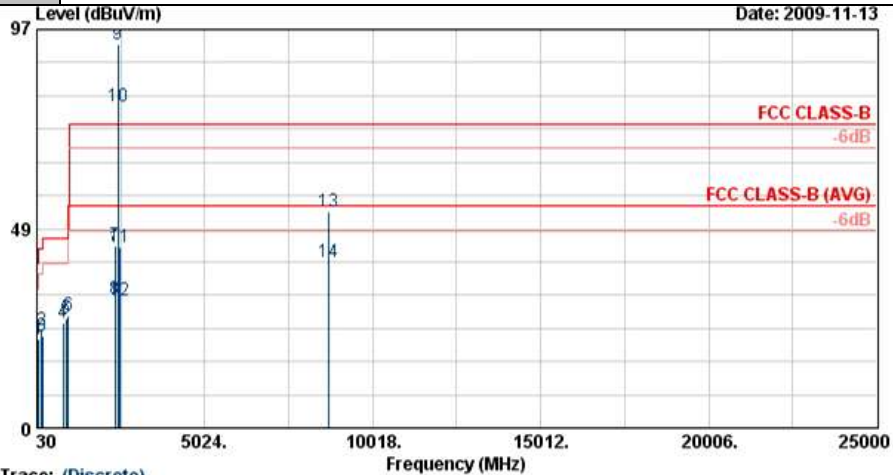

Trace: (Discrete)  
 Site : 03CH06-HY  
 Condition : FCC CLASS-B 3m SHF-EHF HORN HORIZONTAL  
 Project : FR 971509-03

	Freq	Level	Over	Limit	Read	Antenna	Cable	Preamp	Ant	Table	Remark
	MHz	dBuV/m	dB	dBuV/m	dBuV	dB/m	dB	dB	cm	deg	
1	78.33	21.66	-18.34	40.00	44.98	7.23	1.40	31.96	100	185	Peak
2	167.43	23.75	-19.75	43.50	43.70	9.81	2.13	31.90	---	---	Peak
3	184.44	22.41	-21.09	43.50	43.20	8.99	2.29	32.06	---	---	Peak
4	801.90	25.73	-20.27	46.00	32.72	20.08	5.12	32.19	---	---	Peak
5	896.40	26.52	-19.48	46.00	32.09	20.70	5.45	31.73	---	---	Peak
6	957.30	27.34	-18.66	46.00	32.11	20.96	5.59	31.32	---	---	Peak
7	2356.00	44.31	-29.69	74.00	44.92	31.81	3.86	36.27	106	354	Peak
8	2356.00	31.19	-22.81	54.00	31.80	31.81	3.86	36.27	106	354	Average
9 @	2441.00	93.29			93.67	31.93	3.99	36.29	106	354	Peak
10 @	2441.00	78.35			78.73	31.93	3.99	36.29	106	354	Average
11	2486.00	43.82	-30.18	74.00	44.09	31.98	4.05	36.30	106	354	Peak
12	2486.00	31.07	-22.93	54.00	31.34	31.98	4.05	36.30	106	354	Average
13	8721.00	52.68	-21.32	74.00	46.13	35.87	7.48	36.79	100	216	Peak
14	8721.00	40.32	-13.68	54.00	33.76	35.87	7.48	36.79	100	216	Average



Test Mode :	Mode 2	Temperature :	23~24°C
Test Channel :	39	Relative Humidity :	46~47%
Test Engineer :	Mac Lin	Polarization :	Vertical
Remark :	#9 and #10 are Fundamental Signals which can be ignored.		

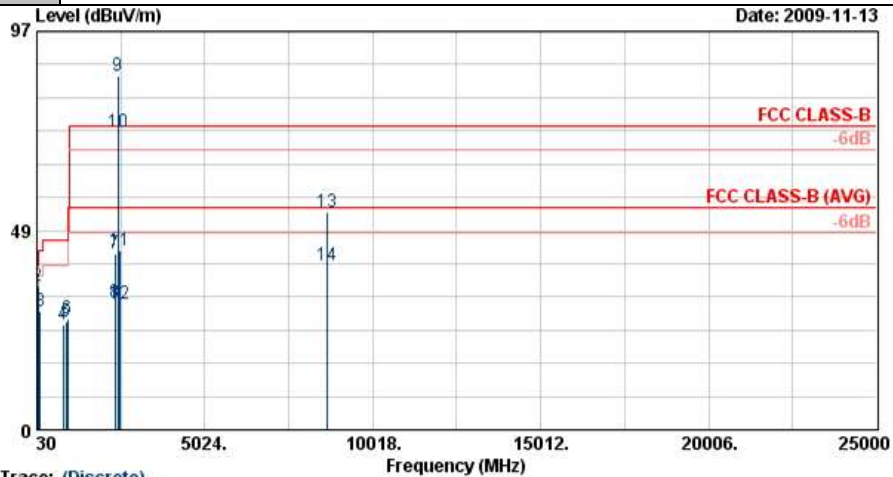

Trace: (Discrete)

Site : 03CH06-HV  
 Condition : FCC CLASS-B 3m SHF-EHF HORN VERTICAL  
 Project : FR 971509-03

	Freq	Level	Over	Limit	Read	Antenna	Cable	Preamp	Ant	Table	Remark
	MHz	dBuV/m	Limit	Line	Level	Factor	Loss	Factor	Pos	Pos	
			dB	dBuV/m	dBuV	dB/m	dB	dB	cm	deg	
1	52.68	26.80	-13.20	40.00	47.33	10.31	1.13	31.97	---	---	Peak
2 !	70.23	35.16	-4.84	40.00	59.00	6.59	1.33	31.76	100	338	Peak
3	129.63	28.76	-14.74	43.50	46.98	11.64	1.83	31.69	---	---	Peak
4	813.80	25.67	-20.33	46.00	32.59	20.16	5.16	32.24	---	---	Peak
5	904.80	26.43	-19.57	46.00	31.86	20.75	5.47	31.65	---	---	Peak
6	952.40	26.94	-19.06	46.00	31.81	20.94	5.57	31.39	---	---	Peak
7	2350.00	42.99	-31.01	74.00	43.62	31.78	3.86	36.27	155	268	Peak
8	2350.00	31.09	-22.91	54.00	31.72	31.78	3.86	36.27	155	268	Average
9 X	2441.00	86.05			86.42	31.93	3.99	36.29	155	268	Peak
10 @	2441.00	72.65			73.03	31.93	3.99	36.29	155	268	Average
11	2500.00	43.54	-30.46	74.00	43.79	32.00	4.05	36.30	155	268	Peak
12	2500.00	30.83	-23.17	54.00	31.08	32.00	4.05	36.30	155	268	Average
13	8646.00	52.89	-21.11	74.00	46.44	35.82	7.39	36.76	100	58	Peak
14	8646.00	40.14	-13.86	54.00	33.69	35.82	7.39	36.76	100	58	Average



Test Mode :	Mode 3	Temperature :	23~24°C
Test Channel :	78	Relative Humidity :	46~47%
Test Engineer :	Mac Lin	Polarization :	Horizontal
Remark :	#9 and #10 are Fundamental Signals which can be ignored.		

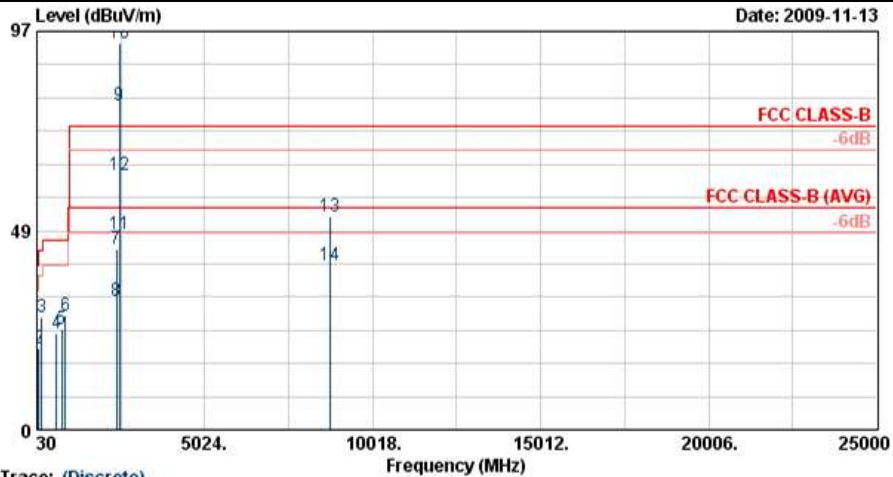

Trace: (Discrete)  
 Site : 03CH06-HY  
 Condition : FCC CLASS-B 3m SHF-EHF HORN HORIZONTAL  
 Project : FR 971509-03

	Freq	Level	Over	Limit	Read	Antenna	Cable	Preamp	Ant	Table	Remark
	MHz	dBuV/m	dB	dBuV/m	dBuV	dB/m	dB	dB	cm	deg	
1	30.54	20.59	-19.41	40.00	33.37	17.98	0.85	31.61	---	---	Peak
2	81.03	19.72	-20.28	40.00	42.79	7.53	1.45	32.04	---	---	Peak
3	169.59	27.50	-16.00	43.50	47.51	9.74	2.14	31.89	100	15	Peak
4	623.40	23.30	-22.70	46.00	32.00	18.84	4.50	32.04	---	---	Peak
5	757.80	24.46	-21.54	46.00	31.86	19.72	4.97	32.08	---	---	Peak
6	882.40	27.85	-18.15	46.00	33.75	20.61	5.41	31.92	---	---	Peak
7	2390.00	44.06	-29.94	74.00	44.57	31.86	3.92	36.28	103	354	Peak
8	2390.00	31.24	-22.76	54.00	31.74	31.86	3.92	36.28	103	354	Average
9 @	2480.00	79.04			79.31	31.98	4.05	36.30	103	354	Average
10 @	2480.00	94.22			94.48	31.98	4.05	36.30	103	354	Peak
11	2483.50	47.58	-6.42	54.00	47.85	31.98	4.05	36.30	103	354	Average
12	2483.50	62.10	-11.90	74.00	62.37	31.98	4.05	36.30	103	354	Peak
13	8766.00	52.09	-21.91	74.00	45.45	35.91	7.53	36.81	100	99	Peak
14	8766.00	39.88	-14.12	54.00	33.24	35.91	7.53	36.81	100	99	Average



Test Mode :	Mode 3	Temperature :	23~24°C
Test Channel :	78	Relative Humidity :	46~47%
Test Engineer :	Mac Lin	Polarization :	Vertical
Remark :	#9 and #10 are Fundamental Signals which can be ignored.		

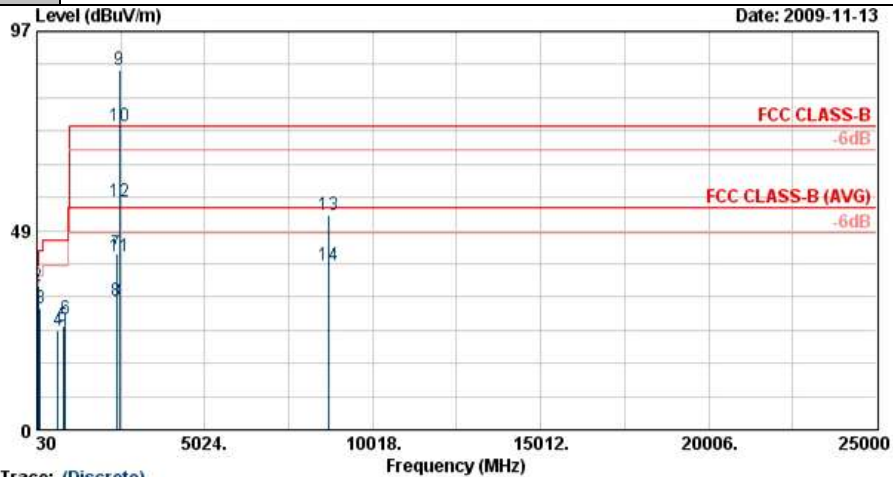

Trace: (Discrete)  
 Site : 03CH06-HV  
 Condition : FCC CLASS-B 3m SHF-EHF HORN VERTICAL  
 Project : FR 971509-03

	Freq	Level	Over	Limit	Read	Antenna	Cable	Preamp	Ant	Table	Remark
	MHz	dBuV/m	Limit	Line	Level	Factor	Loss	Factor	Pos	Pos	
			dB	dBuV/m	dBuV	dB/m	dB	dB	cm	deg	
1	53.49	26.60	-13.40	40.00	47.59	9.82	1.13	31.94	---	---	Peak
2 !	71.58	35.05	-4.95	40.00	58.76	6.73	1.33	31.78	100	293	Peak
3	135.03	29.49	-14.01	43.50	47.95	11.37	1.88	31.71	---	---	Peak
4	651.40	24.27	-21.73	46.00	32.61	18.99	4.57	31.90	---	---	Peak
5	806.80	25.34	-20.66	46.00	32.30	20.11	5.14	32.21	---	---	Peak
6	882.40	27.21	-18.79	46.00	33.11	20.61	5.41	31.92	---	---	Peak
7	2388.00	42.89	-31.11	74.00	43.39	31.86	3.92	36.28	100	95	Peak
8	2388.00	31.29	-22.71	54.00	31.79	31.86	3.92	36.28	100	95	Average
9 X	2480.00	87.45			87.72	31.98	4.05	36.30	100	95	Peak
10 @	2480.00	73.78			74.05	31.98	4.05	36.30	100	95	Average
11	2483.50	42.28	-11.72	54.00	42.55	31.98	4.05	36.30	100	95	Average
12	2483.50	55.45	-18.55	74.00	55.72	31.98	4.05	36.30	100	95	Peak
13	8697.00	52.23	-21.77	74.00	45.71	35.86	7.45	36.78	100	312	Peak
14	8697.00	40.21	-13.79	54.00	33.68	35.86	7.45	36.78	100	312	Average





## **3.10 Antenna Requirements**

### **3.10.1 Standard Applicable**

If directional gain of transmitting antennas is greater than 6dBi, the power shall be reduced by the same level in dB comparing to gain minus 6dBi. The use of a permanently attached antenna or of an antenna that uses a unique coupling to the intentional radiator shall be considered sufficient to comply with the FCC rule.

### **3.10.2 Antenna Connected Construction**

The antennas type used in this product is Monopole Antenna without connector and it is considered to meet antenna requirement.

### **3.10.3 Antenna Gain**

The antenna peak gain of EUT is less than 6 dBi. Therefore, it is not necessary to reduce maximum peak output power limit.



## 4 List of Measuring Equipment

Instrument	Manufacturer	Model No.	Serial No.	Characteristics	Calibration Date	Due Date	Remark
Spectrum Analyzer	R&S	FSP40	100055	9kHz~40GHz	Jun. 23, 2009	Jun. 22, 2010	Conducted (TH02-HY)
Power Meter	Anritsu	ML2495A	0932001	N/A	Sep. 17, 2009	Sep. 16, 2010	Conducted (TH02-HY)
Power Sensor	Anritsu	MA2411B	0846202	N/A	Sep. 10, 2009	Sep. 09, 2010	Conducted (TH02-HY)
EMI Test Receive	R&S	ESCS 30	100356	9KHz – 2.75GHz	Aug. 05, 2009	Aug. 04, 2010	Conduction (CO05-HY)
Two-LISN	R&S	ENV216	11-100081	9kHz~30MHz	Nov. 26, 2008	Nov. 25, 2009	Conduction (CO05-HY)
Two-LISN	R&S	ENV216	11-100080	9kHz~30MHz	Nov. 26, 2008	Nov. 25, 2009	Conduction (CO05-HY)
AC Power Source	APC	APC-1000W	N/A	N/A	N/A	N/A	Conduction (CO05-HY)
Spectrum Analyzer	Agilent	E4408B	MY44211030	9KHz-26.5GHz	Oct. 23, 2009	Oct. 22, 2010	Radiation (03CH06-HY)
Spectrum Analyzer	R&S	FSP40	100057	9KHz-40GHz	Oct. 20, 2009	Oct. 19, 2010	Radiation (03CH06-HY)
EMI Test Receiver	R&S	ESVS10	834468/003	20MHz-1000MHz	Apr. 28, 2009	Apr. 27, 2010	Radiation (03CH06-HY)
Bilog Antenna	SCHAFFNER	CBL6112B	2885	30MHz -2GHz	Oct. 31, 2009	Oct. 30, 2010	Radiation (03CH06-HY)
Double Ridge Horn Antenna	EMCO	3117	00066583	1GHz~18GHz	Aug. 20, 2009	Aug. 19, 2010	Radiation (03CH06-HY)
Double Ridge Horn Antenna	Training Research	AH-0801	95119	8GHz~18GHz	Nov. 02, 2009	Nov. 01, 2010	Radiation (03CH06-HY)
SHF-EHF Horn Antenna	SCHWARZBECK	BBHA 9170	BBHA9170251	15GHz- 40GHz	Oct. 14, 2009	Oct. 13, 2010	Radiation (03CH06-HY)
Pre Amplifier	Agilent	8449B	3008A01917	1GHz- 26.5GHz	Nov. 11, 2009	Nov. 10, 2010	Radiation (03CH06-HY)
Amplifier	Agilent	310N	186713	9KHz~1GHz	Apr. 20, 2009	Apr. 19, 2010	Radiation (03CH06-HY)
System Simulator	R&S	CMU200	117591	N/A	Oct. 15, 2008	Oct. 14, 2010	-

## 5 Uncertainty of Evaluation

### Uncertainty of Conducted Emission Measurement (150 kHz ~ 30 MHz)

Contribution	Uncertainty of $X_i$		$u(X_i)$
	dB	Probability Distribution	
Receiver Reading	0.10	Normal (k=2)	0.05
Cable Loss	0.10	Normal (k=2)	0.05
AMN Insertion Loss	2.50	Rectangular	0.63
Receiver Specification	1.50	Rectangular	0.43
Site Imperfection	1.39	Rectangular	0.80
Mismatch	+0.34 / -0.35	U-Shape	0.24
<b>Combined Standard Uncertainty <math>U_c(y)</math></b>	<b>1.13</b>		
<b>Measuring Uncertainty for a Level of Confidence of 95% (<math>U = 2U_c(y)</math>)</b>	<b>2.26</b>		

### Uncertainty of Radiated Emission Measurement (30 MHz ~ 1000 MHz)

Contribution	Uncertainty of $X_i$		$u(X_i)$
	dB	Probability Distribution	
Receiver Reading	0.41	Normal (k=2)	0.21
Antenna Factor Calibration	0.83	Normal (k=2)	0.42
Cable Loss Calibration	0.25	Normal (k=2)	0.13
Pre-Amplifier Gain Calibration	0.27	Normal (k=2)	0.14
RCV/SPA Specification	2.50	Rectangular	0.72
Antenna Factor Interpolation for Frequency	1.00	Rectangular	0.29
Site Imperfection	1.43	Rectangular	0.83
Mismatch	+0.39 / -0.41	U-Shape	0.28
<b>Combined Standard Uncertainty <math>U_c(y)</math></b>	<b>1.27</b>		
<b>Measuring Uncertainty for a Level of Confidence of 95% (<math>U = 2U_c(y)</math>)</b>	<b>2.54</b>		



**Uncertainty of Radiated Emission Measurement (1 GHz ~ 40 GHz)**

Contribution	Uncertainty of $X_i$		$u(X_i)$	$C_i$	$C_i * u(X_i)$
	dB	Probability Distribution			
Receiver Reading	±0.10	Normal (k=2)	0.10	1	0.10
Antenna Factor Calibration	±1.70	Normal (k=2)	0.85	1	0.85
Cable Loss Calibration	±0.50	Normal (k=2)	0.25	1	0.25
Receiver Correction	±2.00	Rectangular	1.15	1	1.15
Antenna Factor Directional	±1.50	Rectangular	0.87	1	0.87
Site Imperfection	±2.80	Triangular	1.14	1	1.14
Mismatch Receiver VSWR $\Gamma_1 = 0.197$ Antenna VSWR $\Gamma_2 = 0.194$ Uncertainty = $20\text{Log}(1-\Gamma_1*\Gamma_2)$	+0.34 / -0.35	U-Shape	0.244	1	0.244
<b>Combined Standard Uncertainty Uc(y)</b>	<b>2.36</b>				
<b>Measuring Uncertainty for a Level of Confidence of 95% (U = 2Uc(y))</b>	<b>4.72</b>				

## 6 Certification of TAF Accreditation



Certificate No. : L1190-090417

財團法人全國認證基金會  
Taiwan Accreditation Foundation

### Certificate of Accreditation

This is to certify that

**Sporton International Inc.**  
**EMC & Wireless Communications Laboratory**  
No.52, Hwa Ya 1st Rd., Hwa Ya Technology Park, Kwei-Shan Hsiang, Tao Yuan Hsien,  
Taiwan, R.O.C.

**is accredited in respect of laboratory**

<b>Accreditation Criteria</b>	: ISO/IEC 17025:2005
<b>Accreditation Number</b>	: 1190
<b>Originally Accredited</b>	: December 15, 2003
<b>Effective Period</b>	: January 10, 2007 to January 09, 2010
<b>Accredited Scope</b>	: Testing Field, see described in the Appendix
<b>Specific Accreditation Program</b>	: Accreditation Program for Designated Testing Laboratory for Commodities Inspection Accreditation Program for Telecommunication Equipment Testing Laboratory Accreditation Program for BSMI Mutual Recognition Arrangement with Foreign Authorities

  
Jay-San Chen  
President, Taiwan Accreditation Foundation  
Date : April 17, 2009

P1, total 20 pages

The Appendix forms an integral part of this Certificate, which shall be invalid when use without the Appendix



## **Appendix A. Photographs of EUT**

Please refer to Sporton report number EP971509-03 as below.