



FCC RF Test Report

APPLICANT : Acer Incorporated
EQUIPMENT : Smart Camera
BRAND NAME : acer
MODEL NAME : C01
MARKETING NAME : Holo360
FCC ID : HLZC01
STANDARD : FCC Part 15 Subpart C §15.247
CLASSIFICATION : (DTS) Digital Transmission System

The product was received on May 12, 2017 and testing was completed on Aug. 22, 2017. We, Sporton International (Shenzhen) Inc., would like to declare that the tested sample has been evaluated in accordance with the test procedures and has been in compliance with the applicable technical standards.

The test results in this report apply exclusively to the tested model / sample. Without written approval of Sporton International (Shenzhen) Inc., the test report shall not be reproduced except in full.



Approved by: Eric Shih / Manager

Sporton International (Shenzhen) Inc.
1/F, 2/F, Bldg 5, Shiling Industrial Zone, Xinwei Village, Xili, Nanshan Shenzhen City
Guangdong Province 518055 China



TABLE OF CONTENTS

REVISION HISTORY 3

SUMMARY OF TEST RESULT 4

1 GENERAL DESCRIPTION 5

 1.1 Applicant 5

 1.2 Manufacturer 5

 1.3 Product Feature of Equipment Under Test 5

 1.4 Product Specification of Equipment Under Test 6

 1.5 Modification of EUT 6

 1.6 Testing Location 7

 1.7 Applicable Standards 7

2 TEST CONFIGURATION OF EQUIPMENT UNDER TEST 8

 2.1 Carrier Frequency and Channel 8

 2.2 Test Mode 8

 2.3 Connection Diagram of Test System 9

 2.4 Support Unit used in test configuration and system 10

 2.5 EUT Operation Test Setup 10

 2.6 Measurement Results Explanation Example 10

3 TEST RESULT 11

 3.1 6dB and 99% Bandwidth Measurement 11

 3.2 Output Power Measurement 13

 3.3 Power Spectral Density Measurement 14

 3.4 Conducted Band Edges and Spurious Emission Measurement 16

 3.5 Radiated Band Edges and Spurious Emission Measurement 29

 3.6 AC Conducted Emission Measurement 33

 3.7 Antenna Requirements 37

4 LIST OF MEASURING EQUIPMENT 38

5 UNCERTAINTY OF EVALUATION 39

APPENDIX A. CONDUCTED TEST RESULTS

APPENDIX B. RADIATED SPURIOUS EMISSION

APPENDIX C. DUTY CYCLE PLOTS

APPENDIX D. SETUP PHOTOGRAPHS



REVISION HISTORY

REPORT NO.	VERSION	DESCRIPTION	ISSUED DATE
FR751212C	Rev. 01	Initial issue of report	Sep. 05, 2017



SUMMARY OF TEST RESULT

Report Section	FCC Rule	IC Rule	Description	Limit	Result	Remark
3.1	15.247(a)(2)	RSS-247 5.2(a)	6dB Bandwidth	$\geq 0.5\text{MHz}$	Pass	-
3.1	-	RSS-Gen 6.6	99% Bandwidth	-	Pass	-
3.2	15.247(b)	RSS-247 5.4(d)	Power Output Measurement	$\leq 30\text{dBm}$	Pass	-
3.3	15.247(e)	RSS-247 5.2(b)	Power Spectral Density	$\leq 8\text{dBm}/3\text{kHz}$	Pass	-
3.4	15.247(d)	RSS-247 5.5	Conducted Band Edges	$\leq 20\text{dBc}$	Pass	-
			Conducted Spurious Emission		Pass	-
3.5	15.247(d)	RSS-247 5.5	Radiated Band Edges and Radiated Spurious Emission	15.209(a) & 15.247(d)	Pass	Under limit 1.98 dB at 2483.68 MHz
3.6	15.207	RSS-GEN 8.8	AC Conducted Emission	15.207(a)	Pass	Under limit 9.46 dB at 0.160 MHz
3.7	15.203 & 15.247(b)	N/A	Antenna Requirement	N/A	Pass	-



1 General Description

1.1 Applicant

Acer Incorporated

8F , 88, Sec.1 Xintai 5th Rd., Xizhi, New Taipei City 221, Taiwan, R.O.C

1.2 Manufacturer

Acer Incorporated

8F , 88, Sec.1 Xintai 5th Rd., Xizhi, New Taipei City 221, Taiwan, R.O.C

1.3 Product Feature of Equipment Under Test

Product Feature	
Equipment	Smart Camera
Brand Name	acer
Model Name	C01
Marketing Name	Holo360
FCC ID	HLZC01
EUT supports Radios application	WCDMA/HSPA/DC-HSDPA/ HSPA+(16QAM uplink is not supported)/LTE/ WLAN 2.4GHz 802.11b/g/n HT20/HT40/ WLAN 5GHz 802.11a/n HT20/HT40/ WLAN 5GHz 802.11ac VHT20/VHT40/VHT80/ Bluetooth v3.0 + EDR/ Bluetooth v4.0 LE Bluetooth v4.1 LE
IMEI Code	Conducted: 358083080000858 Radiation: 358083080000841 Conduction: 358083080000874
HW Version	V1.03
SW Version	Acer_AV0N0_C01_0.000.08_EMEA_GEN1
EUT Stage	Pre-Production

Remark: The above EUT's information was declared by manufacturer. Please refer to the specifications or user's manual for more detailed description.



1.4 Product Specification of Equipment Under Test

Standards-related Product Specification	
Tx/Rx Channel Frequency Range	2412 MHz ~ 2462 MHz
Maximum (Peak) Output Power to antenna	802.11b : 18.09 dBm (0.0644 W) 802.11g : 21.92 dBm (0.1556 W) 802.11n HT20 : 21.31 dBm (0.1352 W) 802.11n HT40 : 21.63 dBm (0.1455 W)
99% Occupied Bandwidth	802.11b : 13.69MHz 802.11g : 18.68MHz 802.11n HT20 : 19.53MHz 802.11n HT40 : 36.86MHz
Antenna Type / Gain	PIFA Antenna type with gain 0.99 dBi
Type of Modulation	802.11b : DSSS (DBPSK / DQPSK / CCK) 802.11g/n : OFDM (BPSK / QPSK / 16QAM / 64QAM)

1.5 Modification of EUT

No modifications are made to the EUT during all test items.



1.6 Testing Location

Sporton Lab is accredited to ISO 17025 by National Voluntary Laboratory Accreditation Program (NVLAP code: 600156-0) and the FCC designation No are CN5018 and CN5019.

Test Site	Sporton International (Shenzhen) Inc.		
Test Site Location	1/F, 2/F, Bldg 5, Shiling Industrial Zone, Xinwei Village, Xili, Nanshan Shenzhen City Guangdong Province 518055 China TEL: +86-755-8637-9589 FAX: +86-755-8637-9595		
Test Site No.	Sporton Site No.		FCC Test Firm Registration No.
	TH01-SZ	CO01-SZ	251365

Test Site	Sporton International (Shenzhen) Inc.		
Test Site Location	No. 3 Bldg the third floor of south, Shahe River west, Fengzeyuan Warehouse, Nanshan District Shenzhen City Guangdong Province 518055 China TEL: +86-755-3320-2398		
Test Site No.	Sporton Site No.		FCC Test Firm Registration No.
	03CH03-SZ		577730

Note: The test site complies with ANSI C63.4 2014 requirement.

1.7 Applicable Standards

According to the specifications of the manufacturer, the EUT must comply with the requirements of the following standards:

- ♦ FCC Part 15 Subpart C §15.247
- ♦ FCC KDB Publication No. 558074 D01 DTS Meas. Guidance v04
- ♦ ANSI C63.10-2013
- ♦ IC RSS-247 Issue 2
- ♦ IC RSS-Gen Issue 4

Remark:

1. All test items were verified and recorded according to the standards and without any deviation during the test.
2. This EUT has also been tested and complied with the requirements of FCC Part 15, Subpart B, recorded in a separate test report.



2 Test Configuration of Equipment Under Test

The EUT has been associated with peripherals and configuration operated in a manner tended to maximize its emission characteristics in a typical application. Frequency range investigated: conducted emission (150 kHz to 30 MHz) and radiated emission (9 kHz to the 10th harmonic of the highest fundamental frequency or to 40 GHz, whichever is lower). For radiated measurement, pre-scanned in three orthogonal panels, X, Y, Z. The worst cases (Z plane) were recorded in this report.

2.1 Carrier Frequency and Channel

Frequency Band	Channel	Freq. (MHz)	Channel	Freq. (MHz)
2400-2483.5 MHz	1	2412	7	2442
	2	2417	8	2447
	3	2422	9	2452
	4	2427	10	2457
	5	2432	11	2462
	6	2437	-	-

2.2 Test Mode

Final test mode of conducted test items and radiated spurious emissions are considering the modulation and worse data rates as below table.

Modulation	Data Rate
802.11b	1 Mbps
802.11g	6 Mbps
802.11n HT20	MCS0
802.11n HT40	MCS0

Test Cases	
AC Conducted Emission	Mode 1 : WCDMA Band II Idle + Bluetooth Link + WLAN Link(2.4G) + Earphone + USB Cable (Charging from Adapter)

2.3 Connection Diagram of Test System

<WLAN Tx Mode>

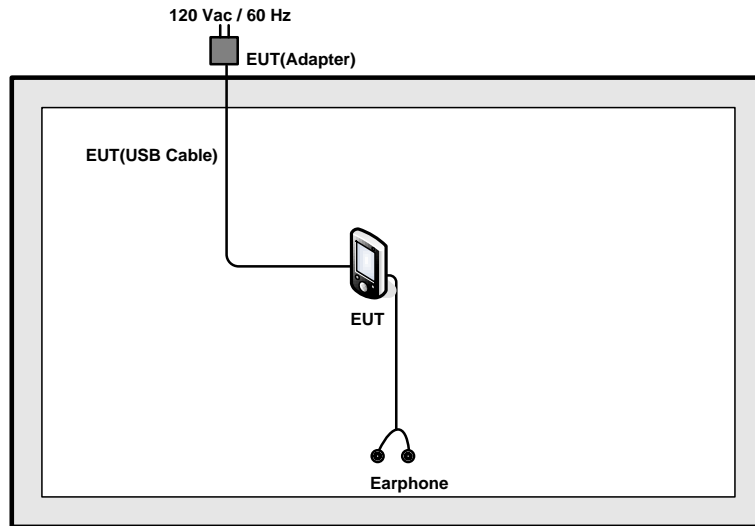

<AC Conducted Emission Mode>

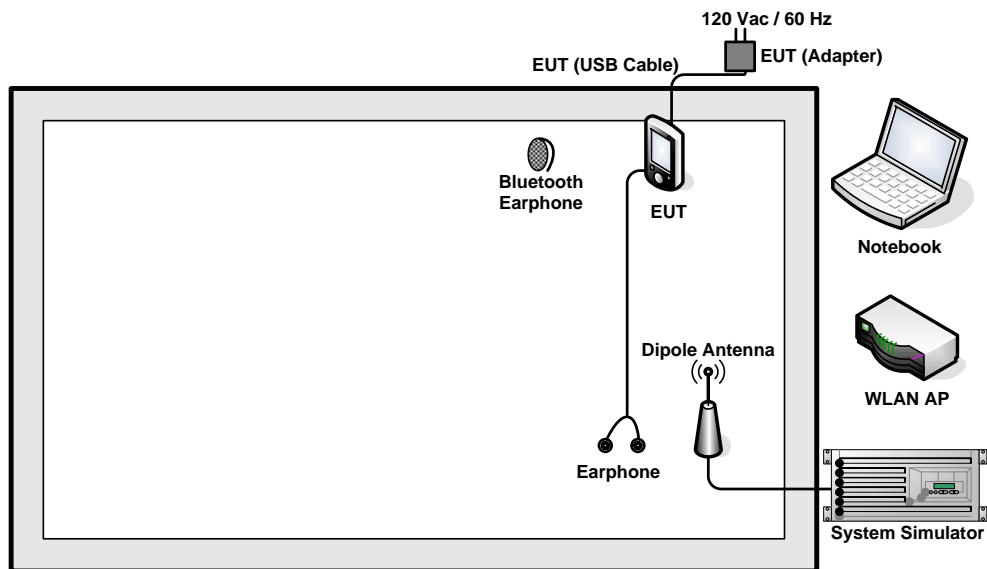

2.4 Support Unit used in test configuration and system

Item	Equipment	Trade Name	Model Name	FCC ID	Data Cable	Power Cord
1.	System Simulator	Anritsu	MT8820C	N/A	N/A	Unshielded,1.8m
2.	WLAN AP	D-Link	DIR-865L	KA2IR865LA1	N/A	Unshielded,1.8m
3.	Notebook	Lenovo	E450	FCC DoC	N/A	AC I/P: Unshielded, 1.2 m DC O/P: Shielded, 1.8 m
4.	Bluetooth Earphone	NOKIA	BH-108	PYAHS-107W	N/A	N/A
5.	Earphone	Lenovo	LH102	N/A	Unshielded,1.2m	N/A

2.5 EUT Operation Test Setup

For WLAN function, the engineering test program was provided and enabled to make EUT continuous transmit/receive.

For AC power line conducted emissions, the EUT was set to connect with the WLAN AP under large package sizes transmission.

2.6 Measurement Results Explanation Example

For all conducted test items:

The offset level is set in the spectrum analyzer to compensate the RF cable loss and attenuator factor between EUT conducted output port and spectrum analyzer. With the offset compensation, the spectrum analyzer reading level is exactly the EUT RF output level.

Example :

The spectrum analyzer offset is derived from RF cable loss and attenuator factor.

Offset = RF cable loss + attenuator factor.

Following shows an offset computation example with cable loss 5.0dB and 10dB attenuator.

$$\begin{aligned} \text{Offset(dB)} &= \text{RF cable loss(dB)} + \text{attenuator factor(dB)}. \\ &= 5.0 + 10 = 15.0 \text{ (dB)} \end{aligned}$$

3 Test Result

3.1 6dB and 99% Bandwidth Measurement

3.1.1 Limit of 6dB and 99% Bandwidth

The minimum 6 dB bandwidth shall be at least 500 kHz.

3.1.2 Measuring Instruments

The measuring equipment is listed in the section 4 of this test report.

3.1.3 Test Procedures

1. The testing follows FCC KDB Publication No. 558074 DTS D01 Meas. Guidance v04.
2. The RF output of EUT was connected to the spectrum analyzer by RF cable and attenuator. The path loss was compensated to the results for each measurement.
3. Set to the maximum power setting and enable the EUT transmit continuously.
4. Make the measurement with the spectrum analyzer's resolution bandwidth (RBW) = 100 kHz. Set the Video bandwidth (VBW) = 300 kHz. In order to make an accurate measurement. The 6 dB bandwidth must be greater than 500 kHz.
5. For 99% Bandwidth Measurement, the spectrum analyzer's resolution bandwidth (RBW) = 1MHz and set the Video bandwidth (VBW) = 3MHz.
6. Measure and record the results in the test report.

3.1.4 Test Setup

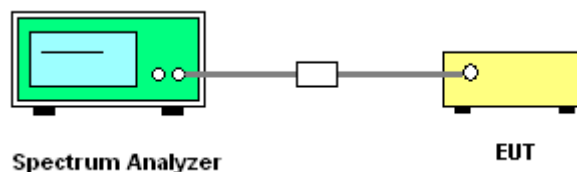



3.1.5 Test Result of 6dB and 99% Occupied Bandwidth

Please refer to Appendix A.

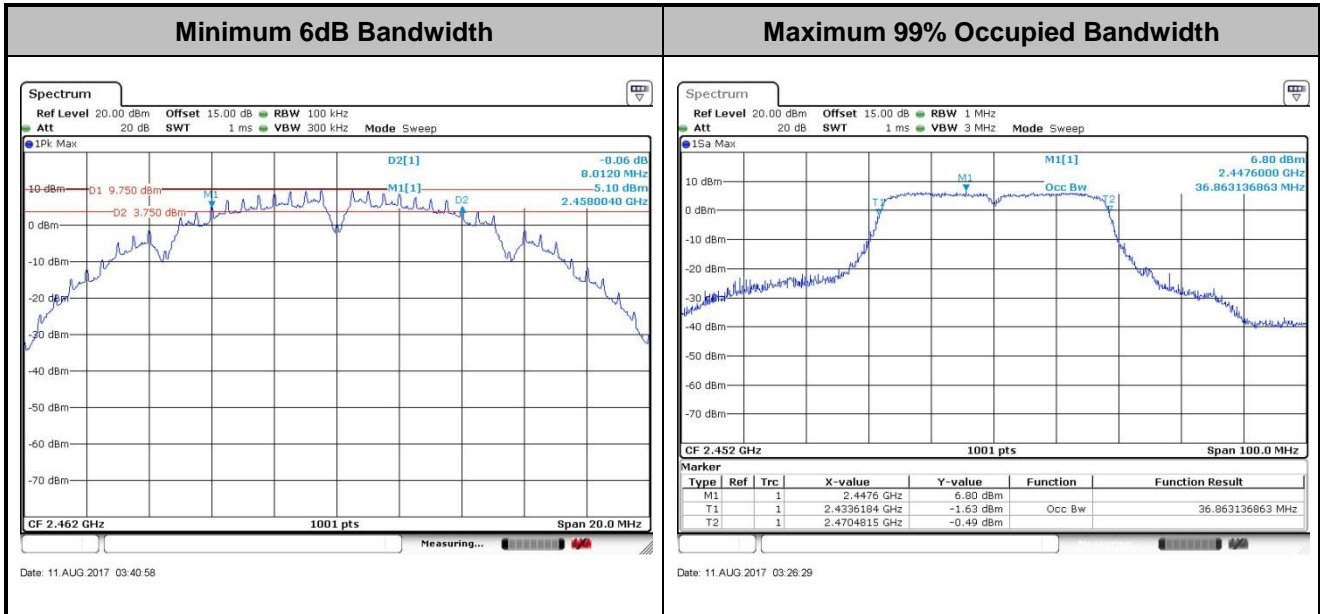

Note : The occupied channel bandwidth is maintained within the band of operation for all of the modulations.

3.2 Output Power Measurement

3.2.1 Limit of Output Power

For systems using digital modulation in the 2400-2483.5MHz, the limit for peak output power is 30dBm. If transmitting antenna of directional gain greater than 6dBi are used the peak output power from the intentional radiator shall be reduced below the above stated value by the amount in dB that the directional gain of the antenna exceeds 6 dBi. In case of point-to-point operation, the limit has to be reduced by 1dB for every 3dB that the directional gain of the antenna exceeds 6dBi.

3.2.2 Measuring Instruments

The measuring equipment is listed in the section 4 of this test report.

3.2.3 Test Procedures

1. The testing follows the Measurement Procedure of FCC KDB No. 558074 DTS D01 Meas. Guidance v04 section 9.1.2 PKPM1 Peak power meter method.
2. The RF output of EUT was connected to the power meter by RF cable and attenuator. The path loss was compensated to the results for each measurement.
3. Set to the maximum power setting and enable the EUT transmit continuously.
4. Measure the conducted output power and record the results in the test report.

3.2.4 Test Setup

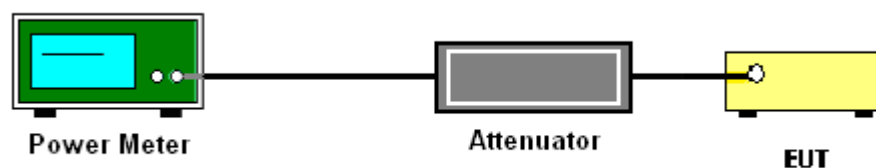

3.2.5 Test Result of Peak Output Power

Please refer to Appendix A.

3.2.6 Test Result of Average output Power (Reporting Only)

Please refer to Appendix A.

3.3 Power Spectral Density Measurement

3.3.1 Limit of Power Spectral Density

The peak power spectral density shall not be greater than 8dBm in any 3kHz band at any time interval of continuous transmission.

3.3.2 Measuring Instruments

The measuring equipment is listed in the section 4 of this test report.

3.3.3 Test Procedures

1. The testing follows Measurement Procedure 10.2 Method PKPSD of FCC KDB Publication No. 558074 D01 DTS Meas. Guidance v04
2. The RF output of EUT was connected to the spectrum analyzer by RF cable and attenuator. The path loss was compensated to the results for each measurement.
3. Set to the maximum power setting and enable the EUT transmit continuously.
4. Make the measurement with the spectrum analyzer's resolution bandwidth (RBW) = 3 kHz. Video bandwidth VBW = 10 kHz In order to make an accurate measurement, set the span to 1.5 times DTS Channel Bandwidth. (6dB BW)
5. Detector = peak, Sweep time = auto couple, Trace mode = max hold, Allow trace to fully stabilize. Use the peak marker function to determine the maximum power level.
6. Measure and record the results in the test report.

3.3.4 Test Setup





3.3.5 Test Result of Power Spectral Density

Please refer to Appendix A.

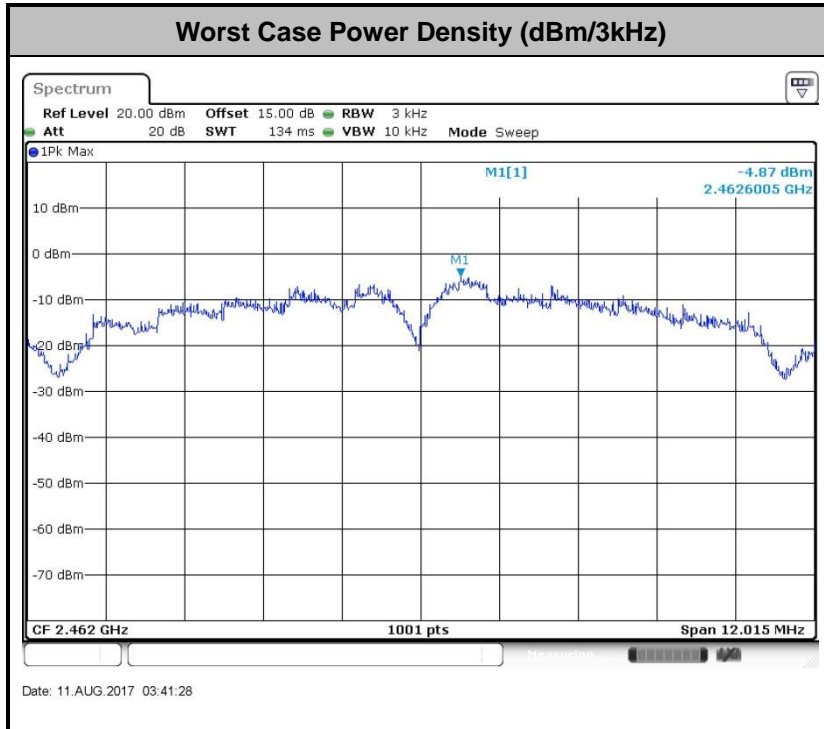

3.4 Conducted Band Edges and Spurious Emission Measurement

3.4.1 Limit of Conducted Band Edges and Spurious Emission Measurement

In any 100 kHz bandwidth outside of the authorized frequency band, the emissions which fall in the non-restricted bands shall be attenuated at least 20 dB / 30dB relative to the maximum PSD level in 100 kHz by RF conducted measurement.

3.4.2 Measuring Instruments

The measuring equipment is listed in the section 4 of this test report.

3.4.3 Test Procedures

1. The testing follows FCC KDB Publication No. 558074 D01 DTS Meas. Guidance v04.
2. The RF output of EUT was connected to the spectrum analyzer by RF cable and attenuator. The path loss was compensated to the results for each measurement.
3. Set to the maximum power setting and enable the EUT transmit continuously.
4. Set RBW = 100 kHz, VBW=300 kHz, Peak Detector. Unwanted Emissions measured in any 100 kHz bandwidth outside of the authorized frequency band shall be attenuated by at least 20 dB relative to the maximum in-band peak PSD level in 100 kHz when maximum peak conducted output power procedure is used. If the transmitter complies with the conducted power limits based on the use of RMS averaging over a time interval, the attenuation required under this paragraph shall be 30 dB instead of 20 dB.
5. Measure and record the results in the test report.
6. The RF fundamental frequency should be excluded against the limit line in the operating frequency band.

3.4.4 Test Setup

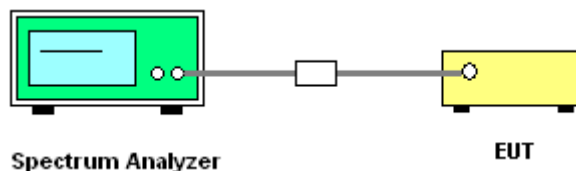



3.4.5 Test Result of Conducted Band Edges and Spurious Emission

Test Mode :	802.11b	Temperature :	24~26°C
Test Band :	2.4GHz Low	Relative Humidity :	50~53%
Test Channel :	01	Test Engineer :	Sam Zheng

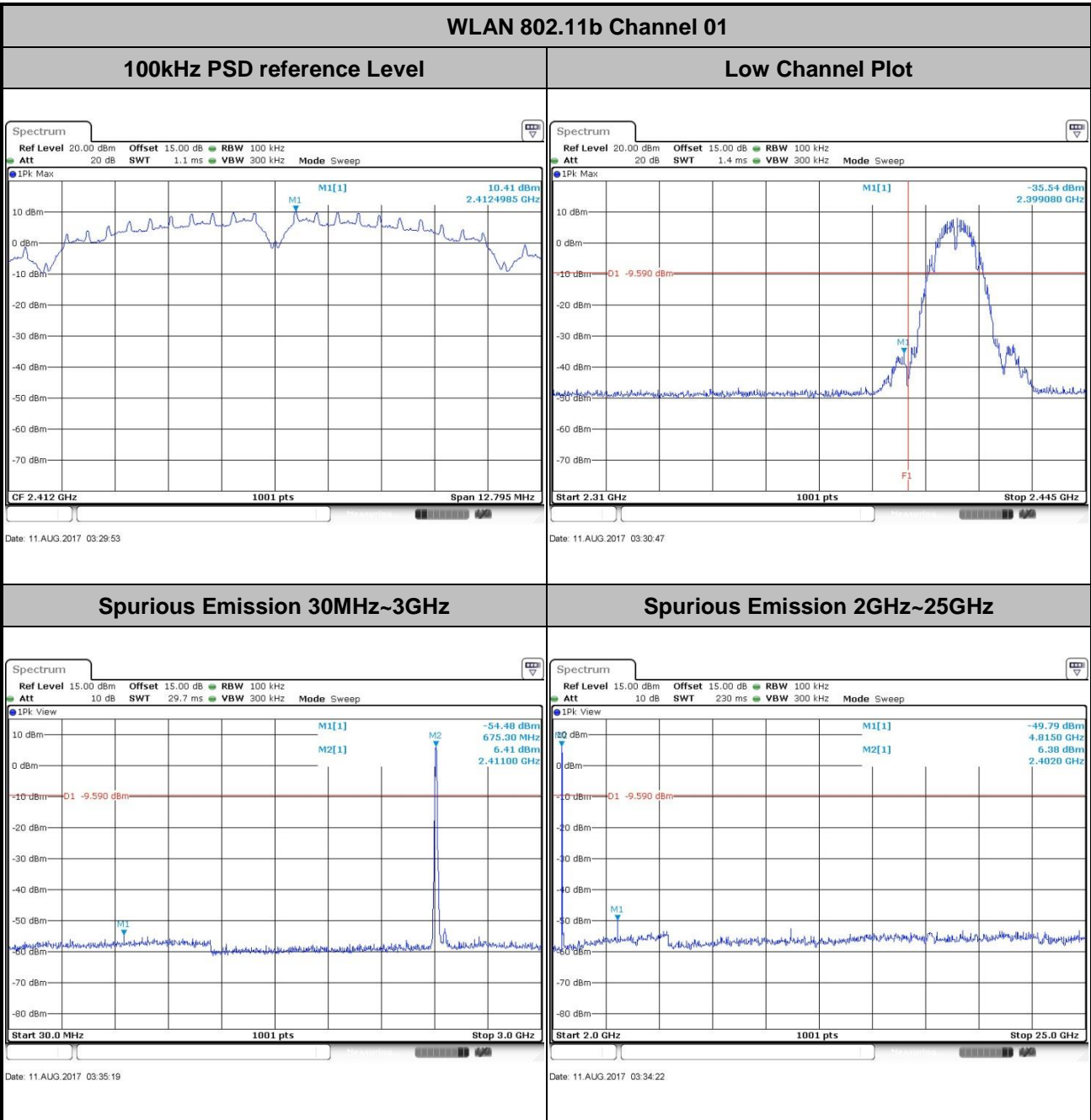



Test Mode :	802.11b	Temperature :	24~26°C
Test Band :	2.4GHz Mid	Relative Humidity :	50~53%
Test Channel :	06	Test Engineer :	Sam Zheng

WLAN 802.11b Channel 06

100kHz PSD reference Level

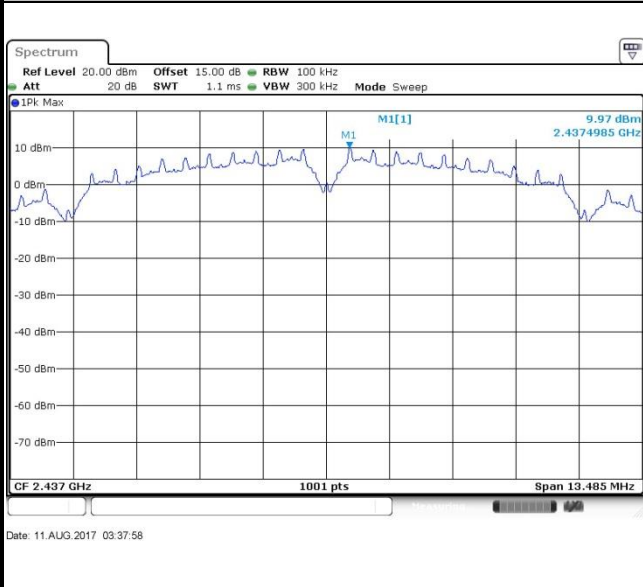

Spurious Emission 30MHz~3GHz

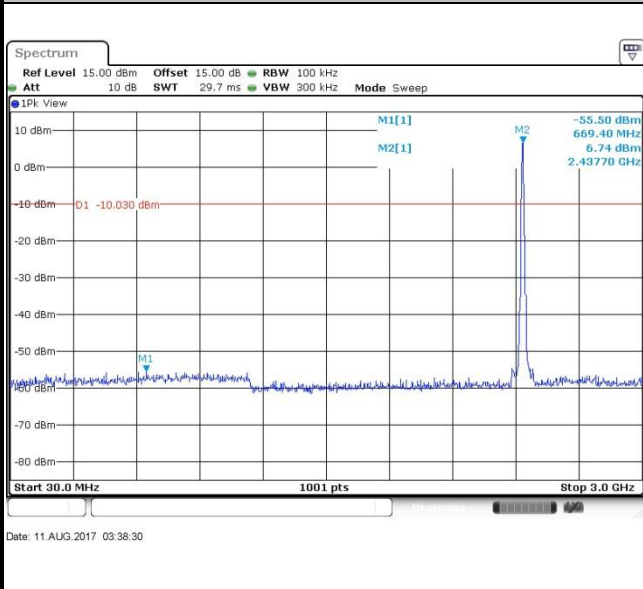

Spurious Emission 2GHz~25GHz

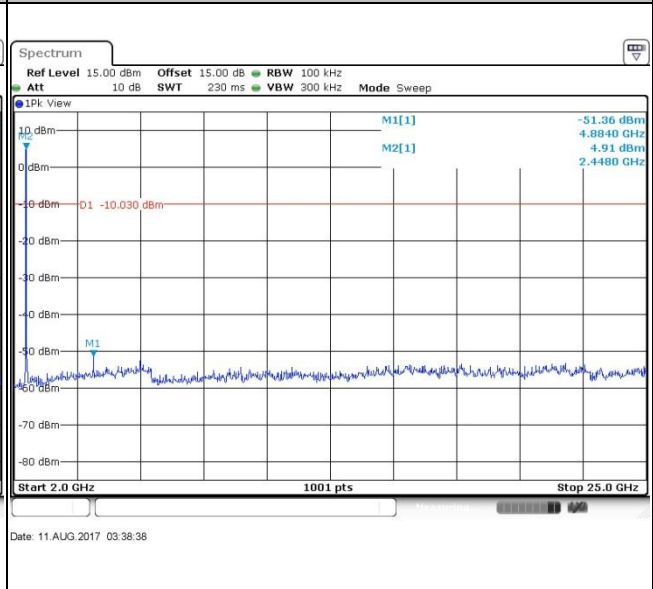



Test Mode :	802.11b	Temperature :	24~26°C
Test Band :	2.4GHz High	Relative Humidity :	50~53%
Test Channel :	11	Test Engineer :	Sam Zheng

WLAN 802.11b Channel 11

100kHz PSD reference Level

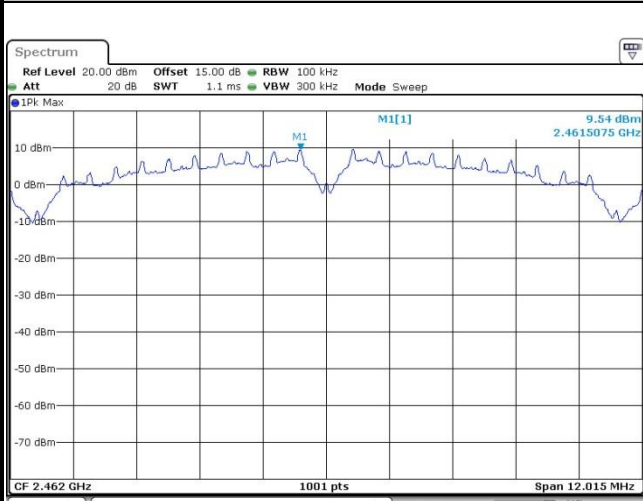

Date: 11.AUG.2017 03:41:47

High Channel Plot

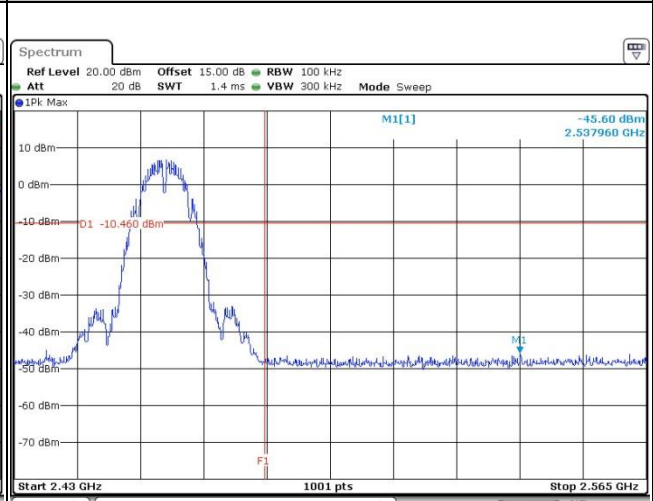

Date: 11.AUG.2017 03:42:01

Spurious Emission 30MHz~3GHz

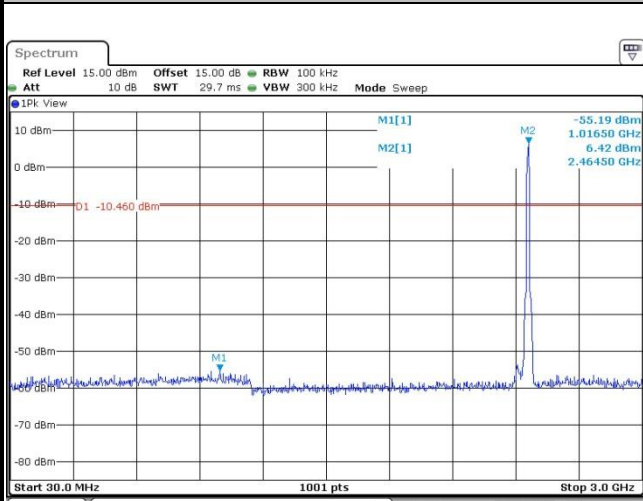

Date: 11.AUG.2017 03:43:32

Spurious Emission 2GHz~25GHz

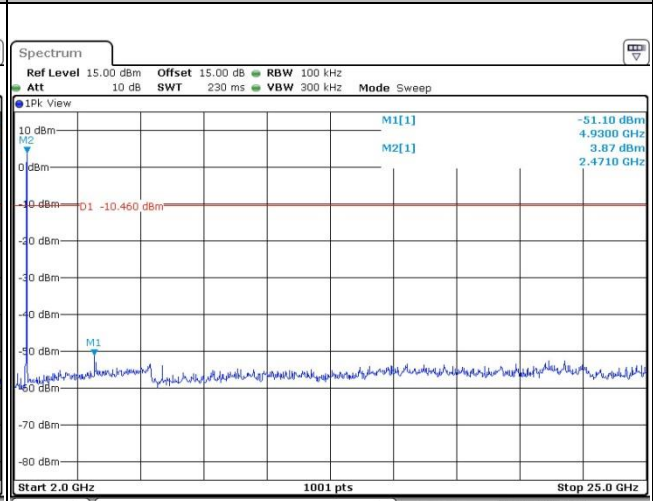

Date: 11.AUG.2017 03:43:00



Test Mode :	802.11g	Temperature :	24~26°C
Test Band :	2.4GHz Low	Relative Humidity :	50~53%
Test Channel :	01	Test Engineer :	Sam Zheng

WLAN 802.11g Channel 01

100kHz PSD reference Level

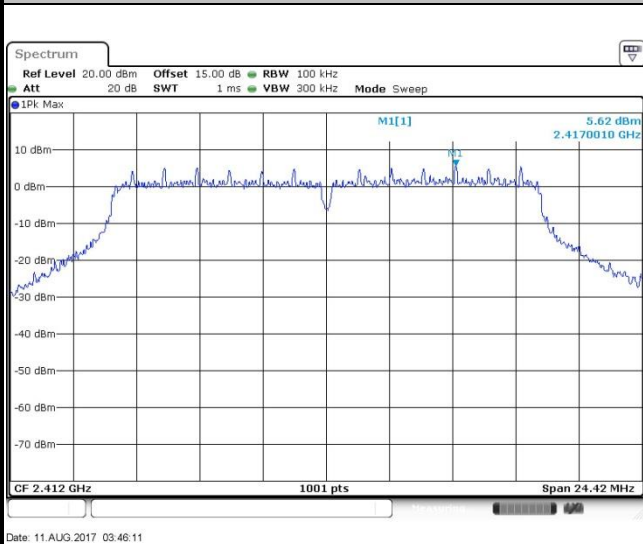

Low Channel Plot

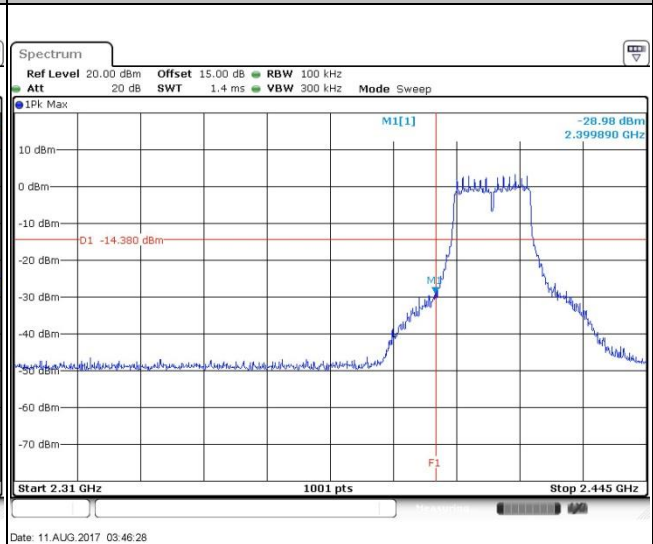

Spurious Emission 30MHz~3GHz

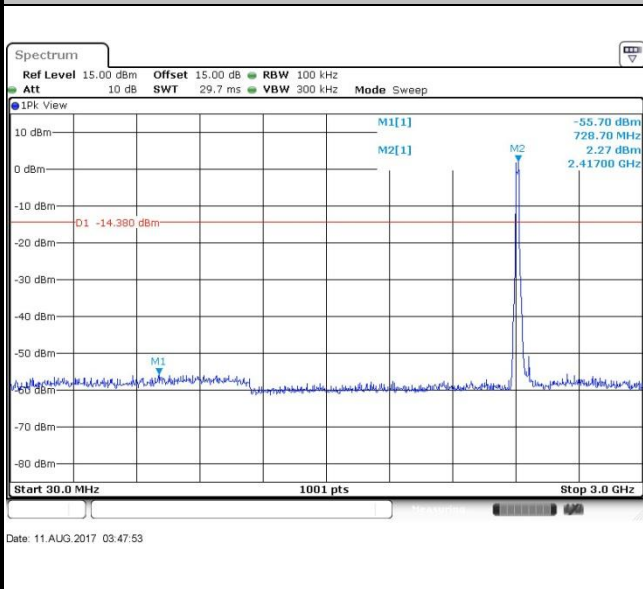

Spurious Emission 2GHz~25GHz

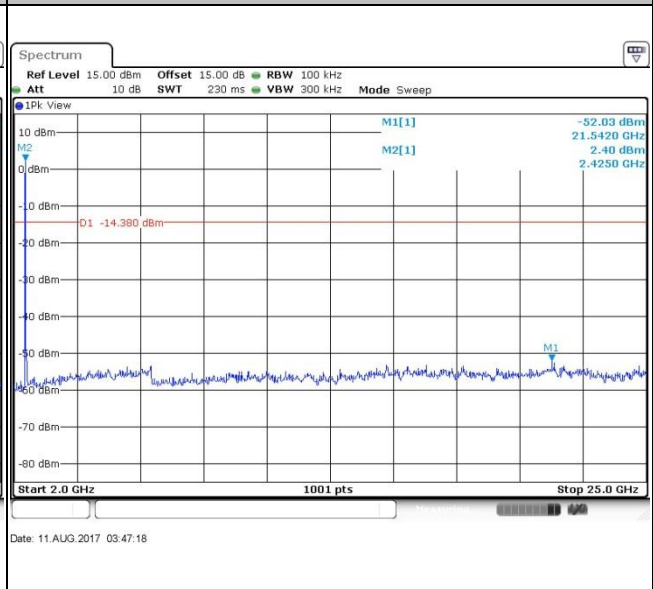



Test Mode :	802.11g	Temperature :	24~26°C
Test Band :	2.4GHz Mid	Relative Humidity :	50~53%
Test Channel :	06	Test Engineer :	Sam Zheng

WLAN 802.11g Channel 06

100kHz PSD reference Level

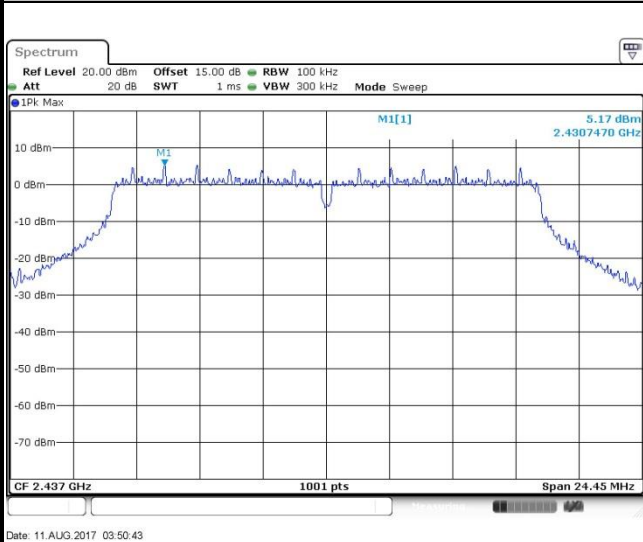

Spurious Emission 30MHz~3GHz

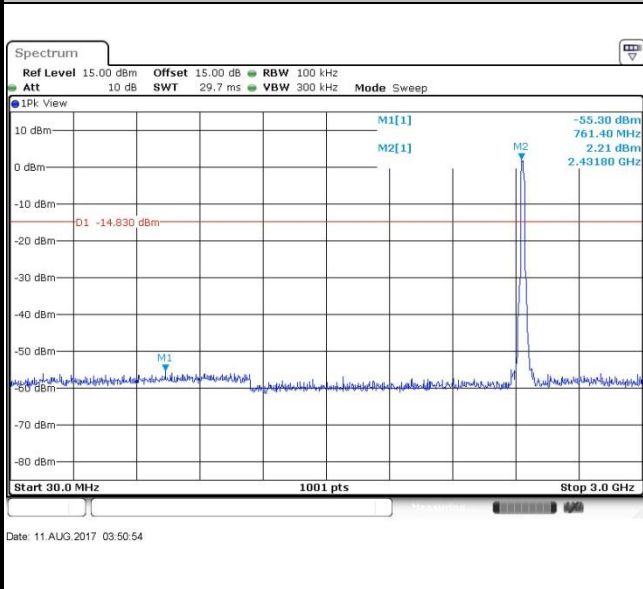

Spurious Emission 2GHz~25GHz

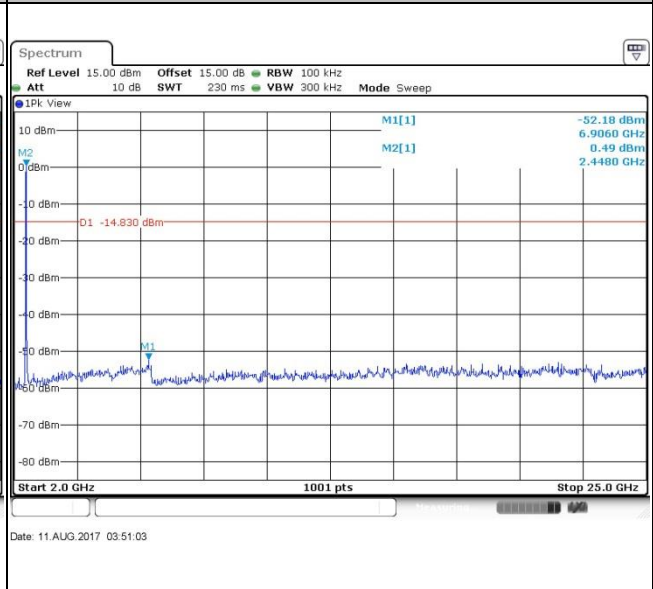



Test Mode :	802.11g	Temperature :	24~26°C
Test Band :	2.4GHz High	Relative Humidity :	50~53%
Test Channel :	11	Test Engineer :	Sam Zheng

WLAN 802.11g Channel 11

100kHz PSD reference Level

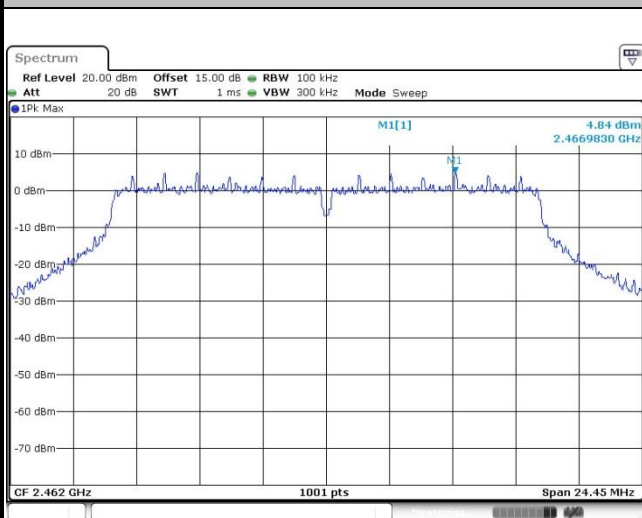

Date: 11.AUG.2017 03:54:09

High Channel Plot

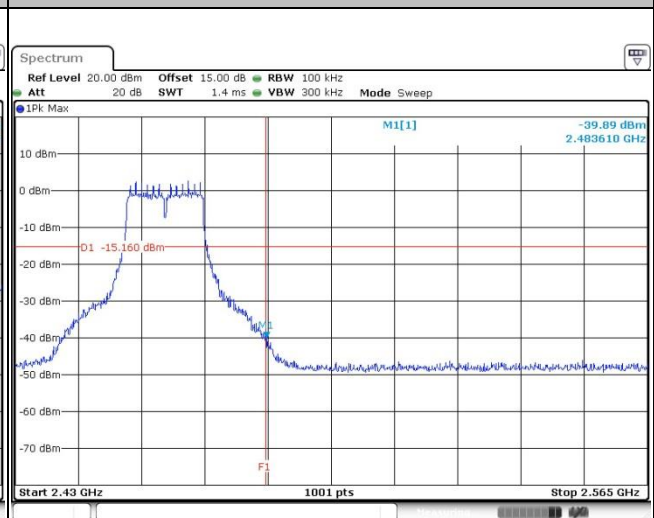

Date: 11.AUG.2017 03:54:26

Spurious Emission 30MHz~3GHz

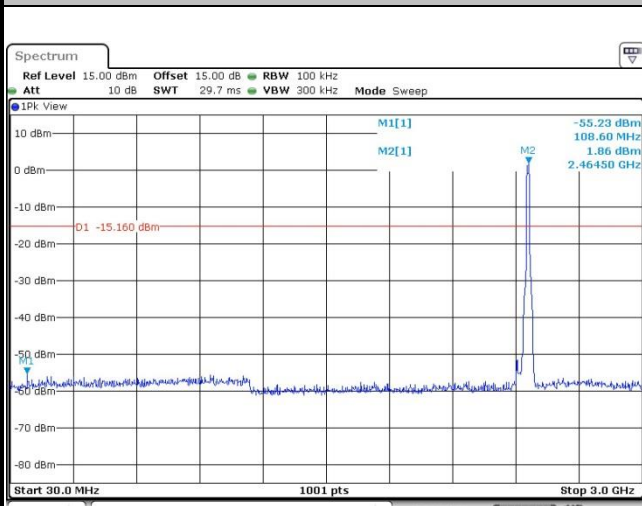

Date: 11.AUG.2017 03:55:43

Spurious Emission 2GHz~25GHz

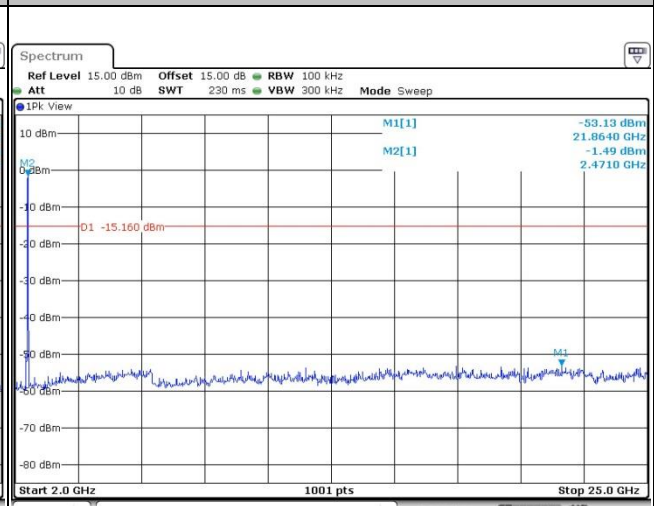

Date: 11.AUG.2017 03:55:07



Test Mode :	802.11n HT20	Temperature :	24~26°C
Test Band :	2.4GHz Low	Relative Humidity :	50~53%
Test Channel :	01	Test Engineer :	Sam Zheng

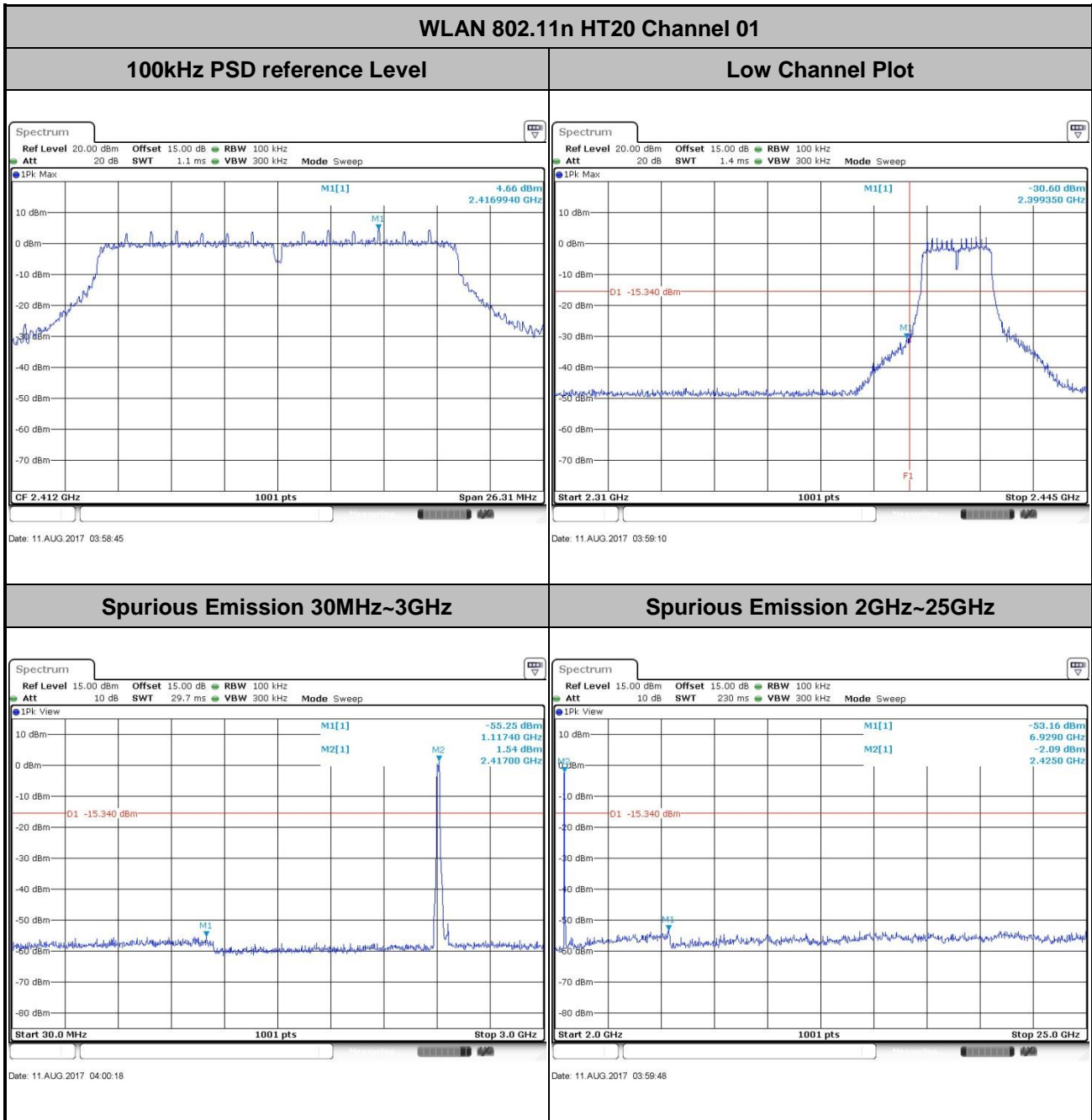



Test Mode :	802.11n HT20	Temperature :	24~26°C
Test Band :	2.4GHz Mid	Relative Humidity :	50~53%
Test Channel :	06	Test Engineer :	Sam Zheng

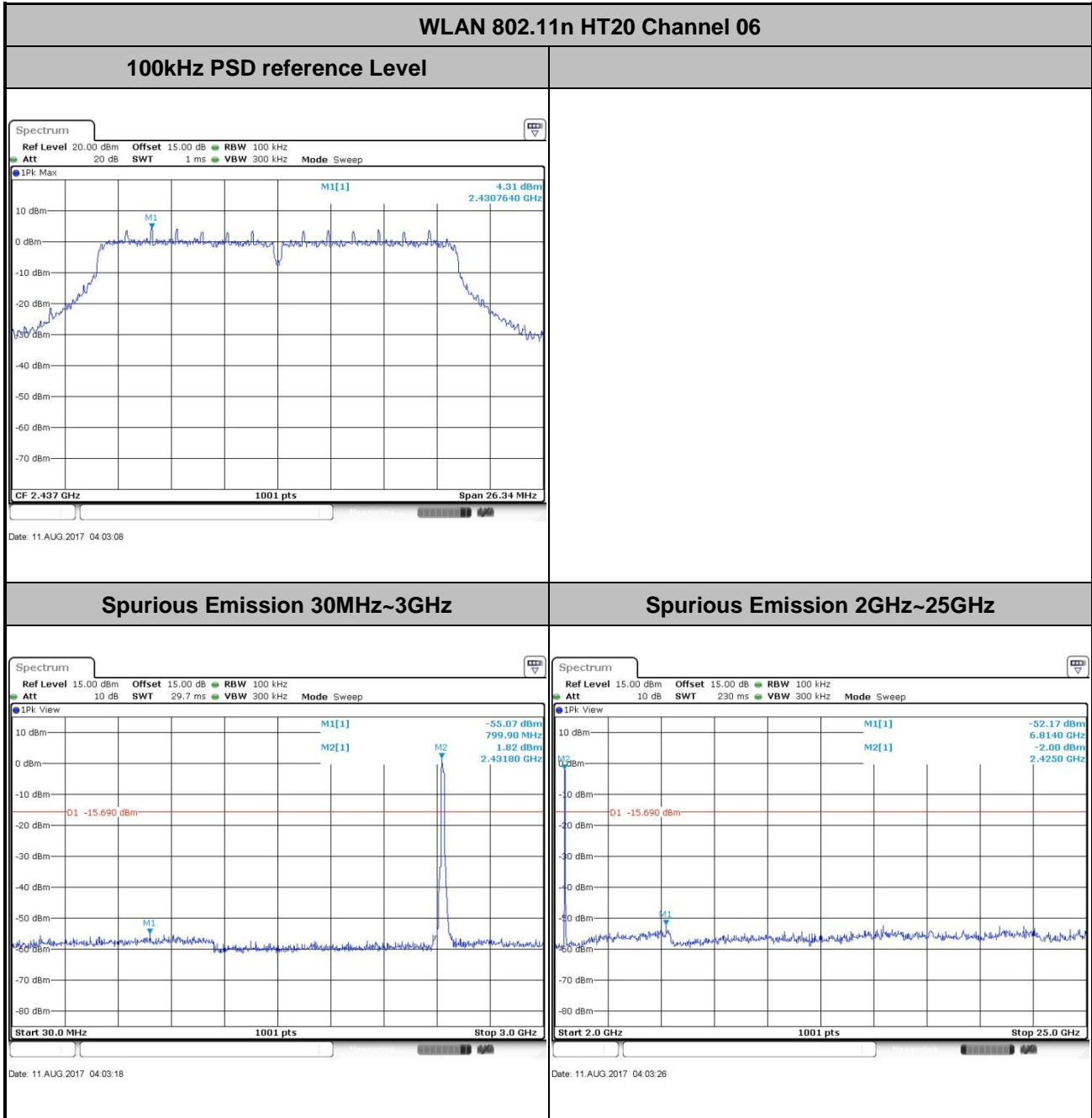



Test Mode :	802.11n HT20	Temperature :	24~26°C
Test Band :	2.4GHz High	Relative Humidity :	50~53%
Test Channel :	11	Test Engineer :	Sam Zheng

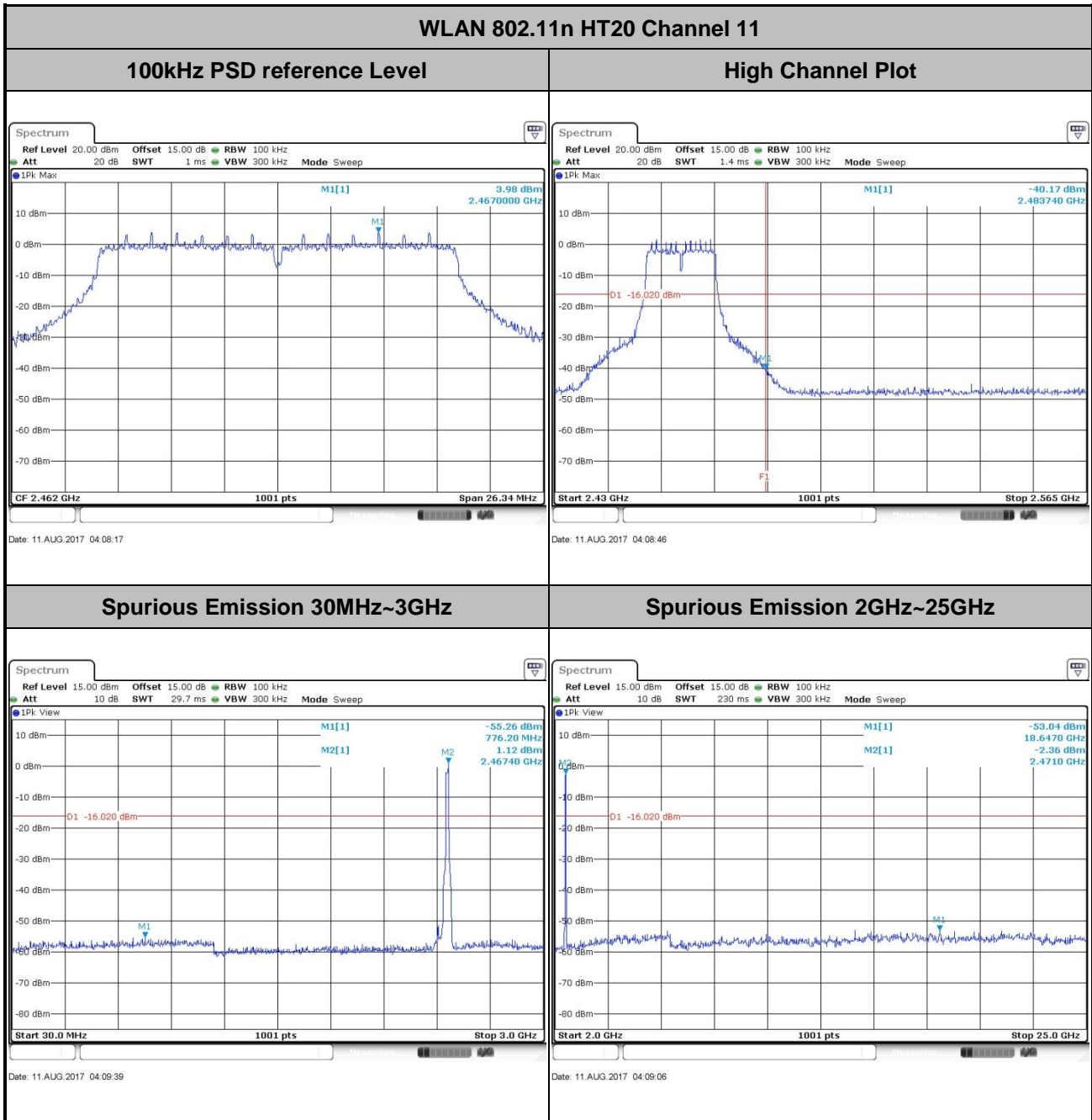



Test Mode :	802.11n HT40	Temperature :	24~26°C
Test Band :	2.4GHz Low	Relative Humidity :	50~53%
Test Channel :	03	Test Engineer :	Sam Zheng

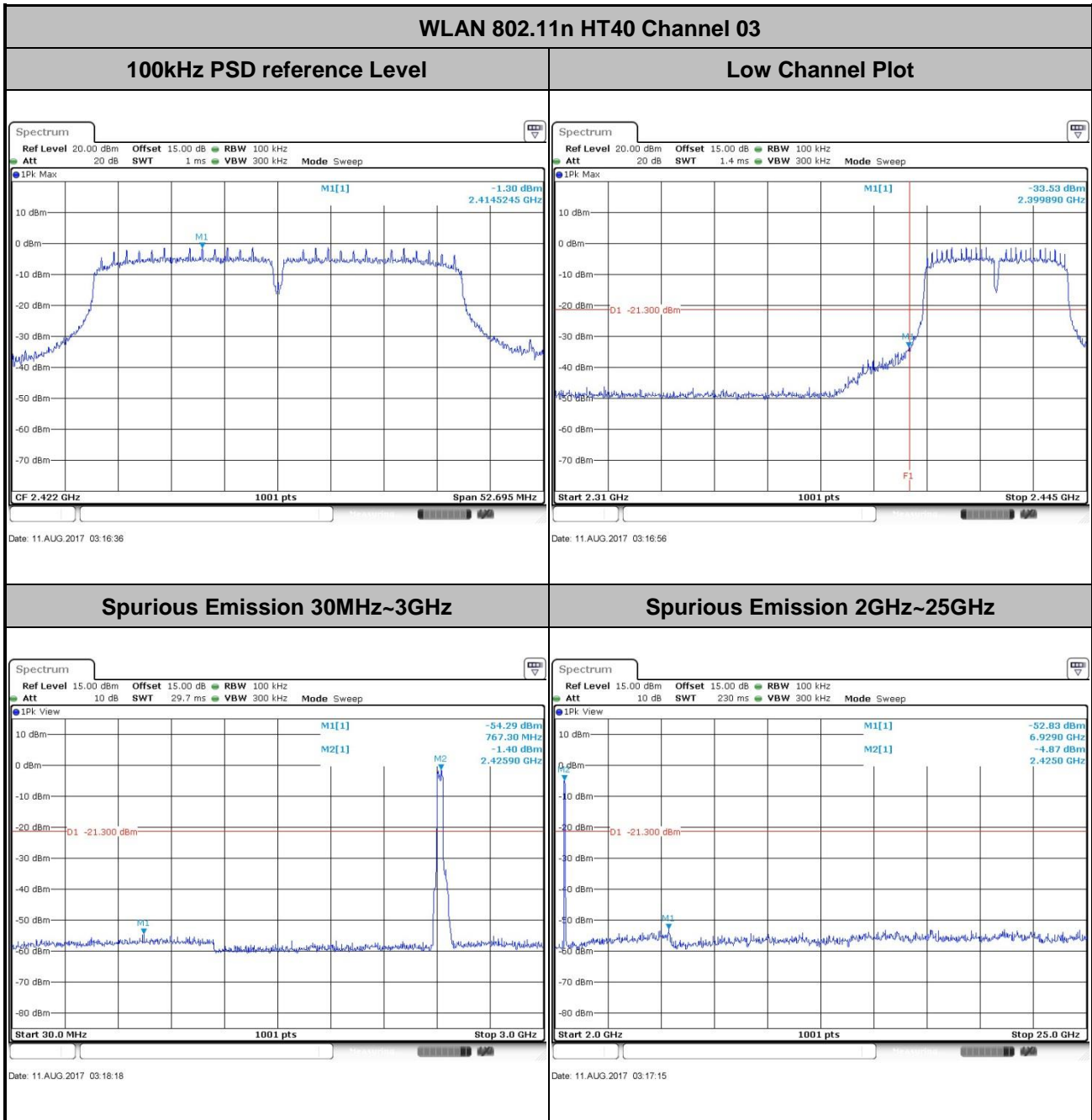



Test Mode :	802.11n HT40	Temperature :	24~26°C
Test Band :	2.4GHz Mid	Relative Humidity :	50~53%
Test Channel :	06	Test Engineer :	Sam Zheng

WLAN 802.11n HT40 Channel 06

100kHz PSD reference Level

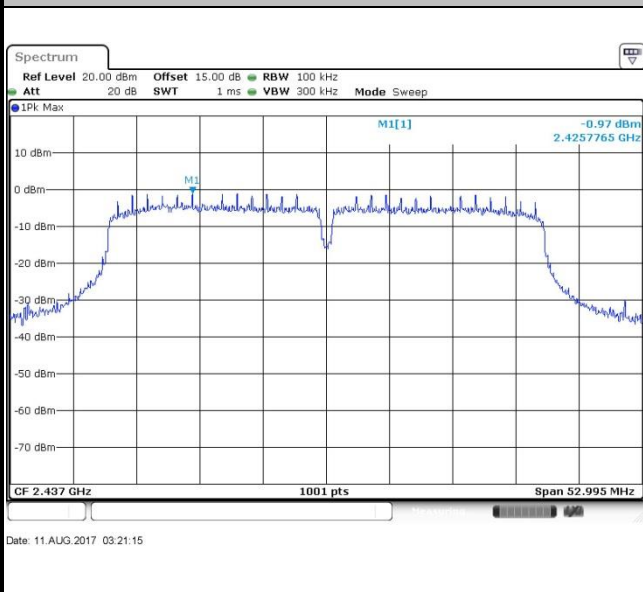

Spurious Emission 30MHz~3GHz

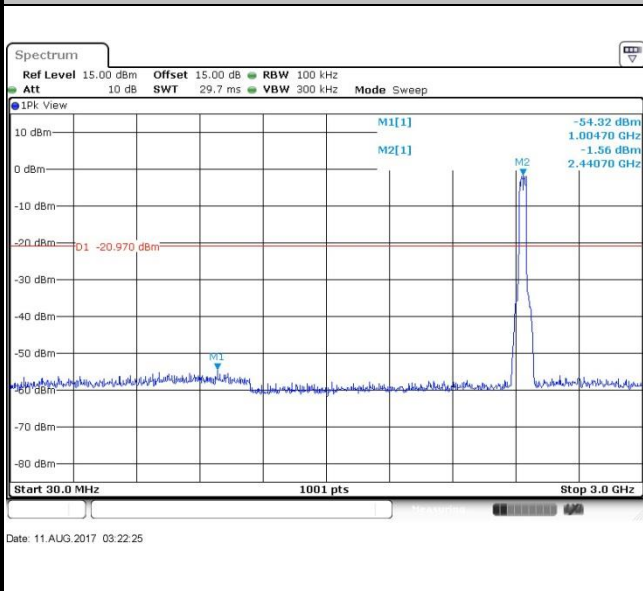

Spurious Emission 2GHz~25GHz

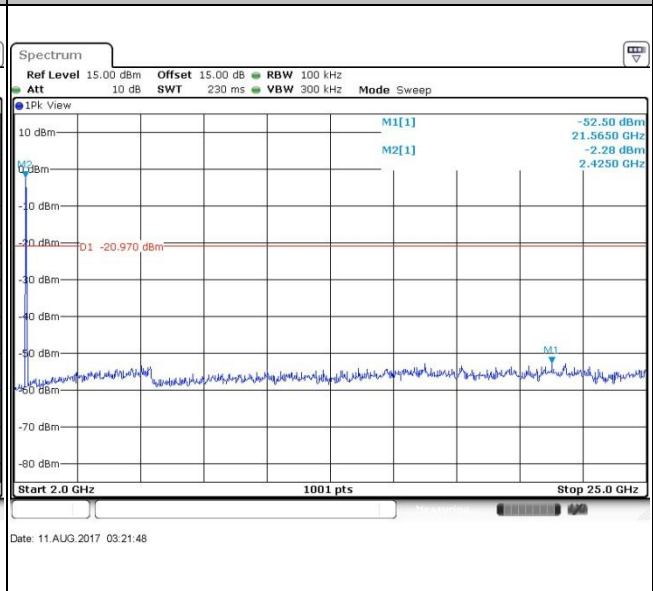



Test Mode :	802.11n HT40	Temperature :	24~26°C
Test Band :	2.4GHz High	Relative Humidity :	50~53%
Test Channel :	09	Test Engineer :	Sam Zheng

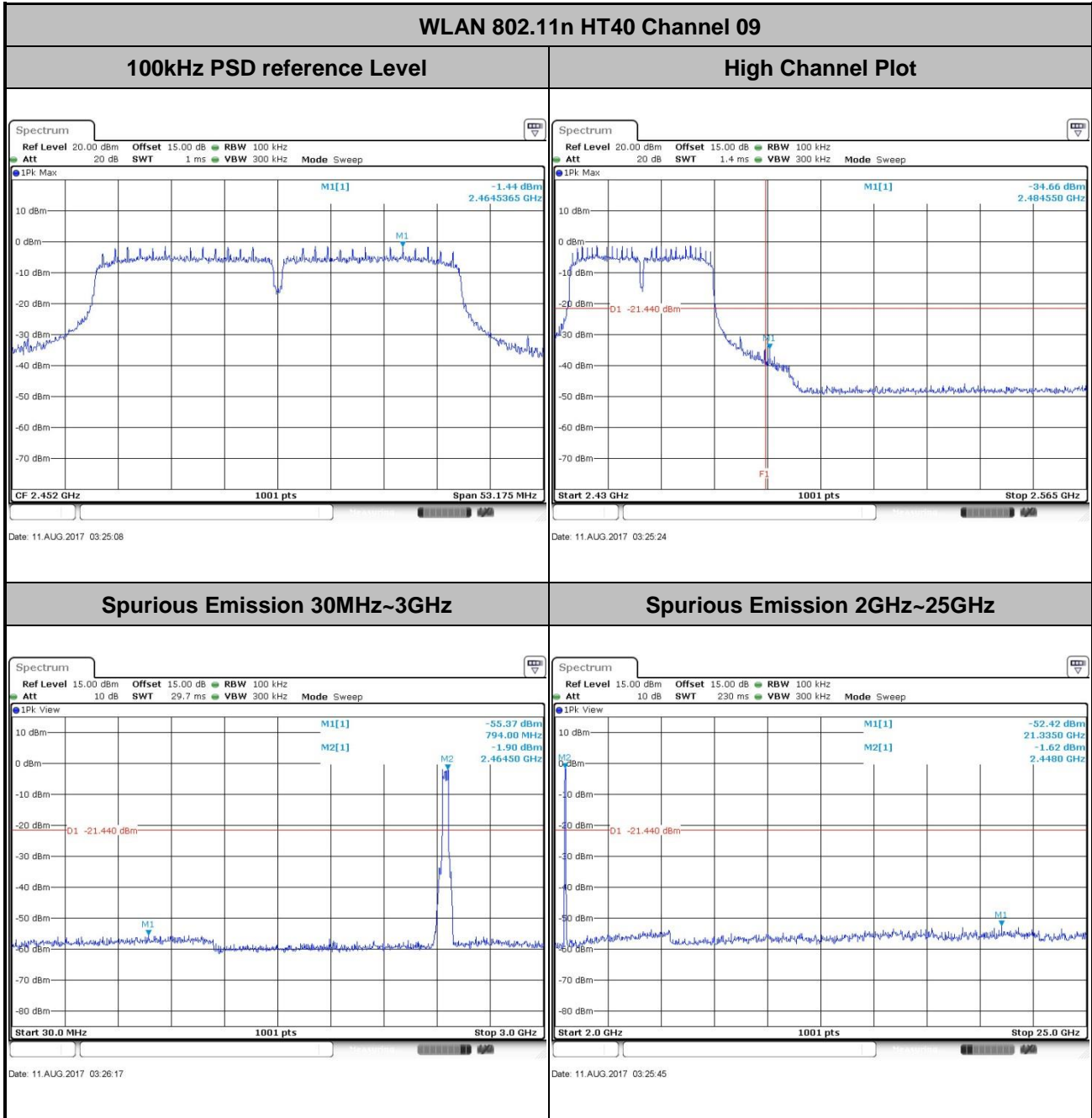



3.5 Radiated Band Edges and Spurious Emission Measurement

3.5.1 Limit of Radiated band edge and Spurious Emission Measurement

In any 100 kHz bandwidth outside the intentional radiator frequency band, all harmonics/spurious must be at least 20 dB below the highest emission level within the authorized band. If the output power of this device was measured by spectrum analyzer, the attenuation under this paragraph shall be 30 dB instead of 20 dB. In addition, radiated emissions which fall in the restricted bands must also comply with the limits as below.

Frequency (MHz)	Field Strength (microvolts/meter)	Measurement Distance (meters)
0.009 – 0.490	2400/F(kHz)	300
0.490 – 1.705	24000/F(kHz)	30
1.705 – 30.0	30	30
30 – 88	100	3
88 – 216	150	3
216 - 960	200	3
Above 960	500	3

3.5.2 Measuring Instruments

The measuring equipment is listed in the section 4 of this test report.



3.5.3 Test Procedures

1. The testing follows FCC KDB Publication No. 558074 D01 DTS Meas. Guidance v04.
2. The EUT was arranged to its worst case and then tune the antenna tower (from 1 m to 4 m) and turntable (from 0 degree to 360 degrees) to find the maximum reading. A pre-amp and a high pass filter are used for the test in order to get better signal level.
3. The EUT was placed on a turntable with 0.8 meter for frequency below 1GHz and 1.5 meter for frequency above 1GHz respectively above ground.
4. The EUT was set 3 meters from the interference receiving antenna, which was mounted on the top of a variable height antenna tower.
5. Corrected Reading: Antenna Factor + Cable Loss + Read Level - Preamp Factor = Level
6. For measurement below 1GHz, If the emission level of the EUT measured by the peak detector is 3 dB lower than the applicable limit, the peak emission level will be reported. Otherwise, the emission measurement will be repeated using the quasi-peak detector and reported.
7. Use the following spectrum analyzer settings:
 - (1) Span shall wide enough to fully capture the emission being measured;
 - (2) Set RBW=100 kHz for $f < 1$ GHz; VBW \geq RBW; Sweep = auto; Detector function = peak; Trace = max hold;
 - (3) Set RBW = 1 MHz, VBW= 3MHz for $f \geq 1$ GHz for peak measurement.
For average measurement:
 - VBW = 10 Hz, when duty cycle is no less than 98 percent.
 - VBW $\geq 1/T$, when duty cycle is less than 98 percent where T is the minimum transmission duration over which the transmitter is on and is transmitting at its maximum power control level for the tested mode of operation.

3.5.4 Test Setup

For radiated emissions below 30MHz

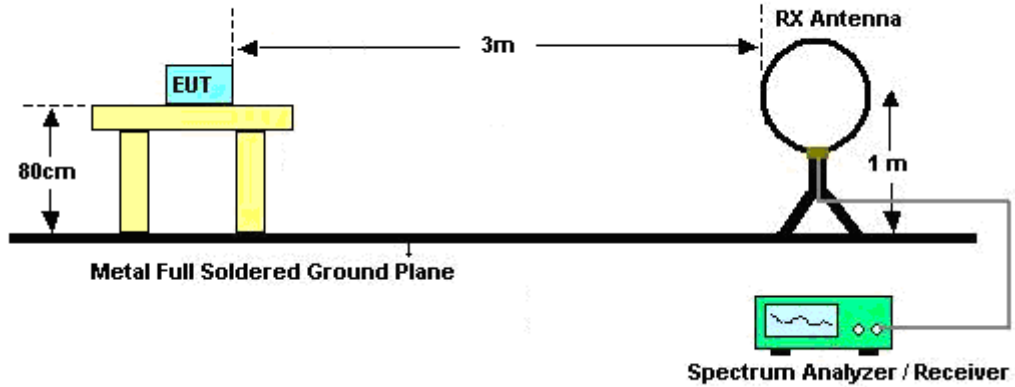

For radiated emissions from 30MHz to 1GHz

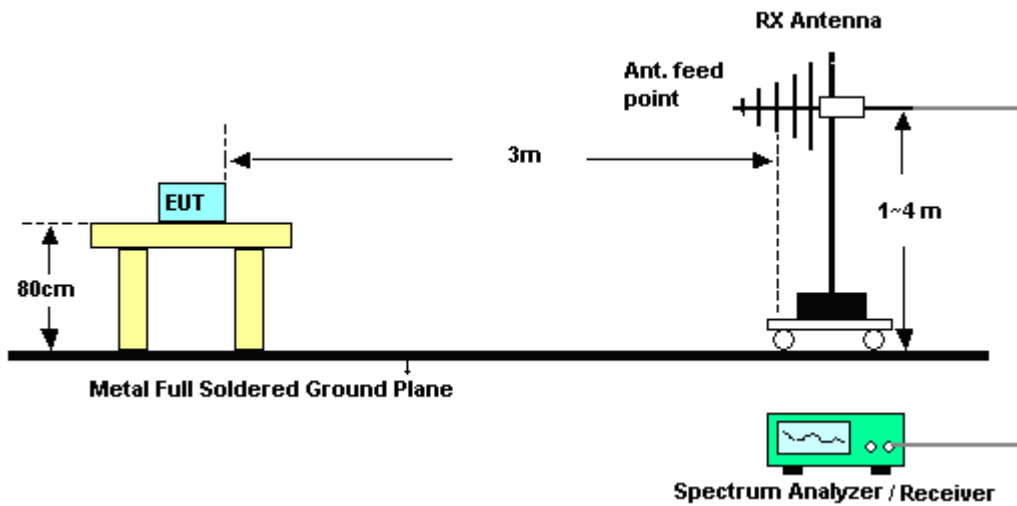

For radiated emissions above 1GHz

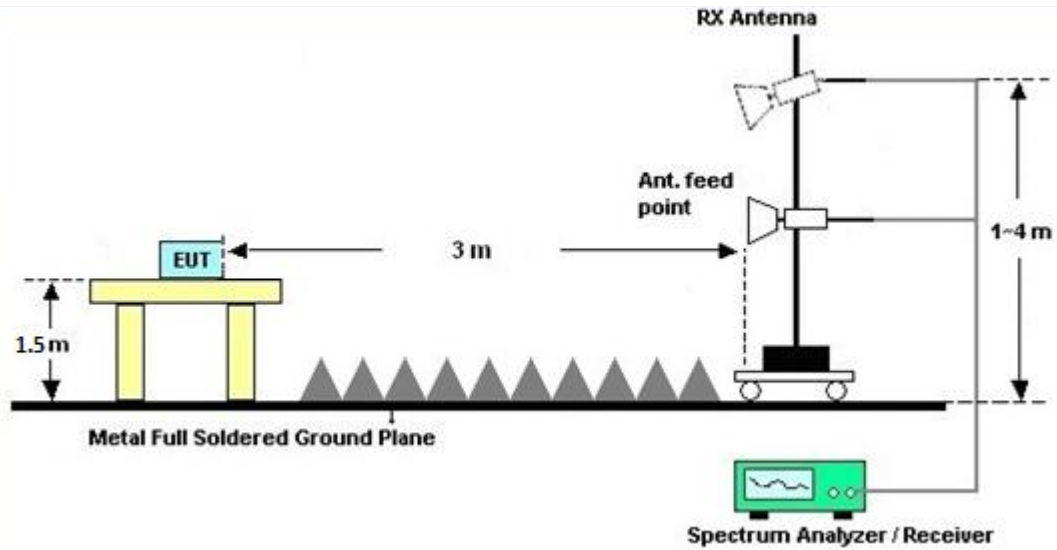

3.5.5 Test Results of Radiated Spurious Emissions (9kHz ~ 30MHz)

The low frequency, which started from 9 kHz to 30MHz, was pre-scanned and the result which was 20dB lower than the limit line was not reported.

3.5.6 Test Result of Radiated Spurious at Band Edges

Please refer to Appendix B.

3.5.7 Duty Cycle

Please refer to Appendix C.

3.5.8 Test Result of Radiated Spurious Emission (30MHz ~ 10th Harmonic)

Please refer to Appendix B.



3.6 AC Conducted Emission Measurement

3.6.1 Limit of AC Conducted Emission

For equipment that is designed to be connected to the public utility (AC) power line, the radio frequency voltage that is conducted back onto the AC power line on any frequency or frequencies within the band 150 kHz to 30 MHz shall not exceed the limits in the following table.

Frequency of Emission (MHz)	Conducted Limit (dBµV)	
	Quasi-Peak	Average
0.15-0.5	66 to 56*	56 to 46*
0.5-5	56	46
5-30	60	50

*Decreases with the logarithm of the frequency.

3.6.2 Measuring Instruments

The measuring equipment is listed in the section 4 of this test report.

3.6.3 Test Procedures

1. The EUT was placed 0.4 meter from the conducting wall of the shielding room, and it was kept at least 80 centimeters from any other grounded conducting surface.
2. Connect EUT to the power mains through a line impedance stabilization network (LISN).
3. All the support units are connecting to the other LISN.
4. The LISN provides 50 ohm coupling impedance for the measuring instrument.
5. The FCC states that a 50 ohm, 50 microhenry LISN should be used.
6. Both sides of AC line were checked for maximum conducted interference.
7. The frequency range from 150 kHz to 30 MHz was searched.
8. Set the test-receiver system to Peak Detect Function and specified bandwidth (IF bandwidth = 9kHz) with Maximum Hold Mode.

3.6.4 Test Setup





3.6.5 Test Result of AC Conducted Emission

Test Mode :	Mode 1	Temperature :	24~25°C
Test Engineer :	Peng Wang	Relative Humidity :	50~55%
Test Voltage :	120Vac / 60Hz	Phase :	Line
Function Type :	WCDMA Band II Idle + Bluetooth Link + WLAN Link(2.4G) + Earphone + USB Cable (Charging from Adapter)		

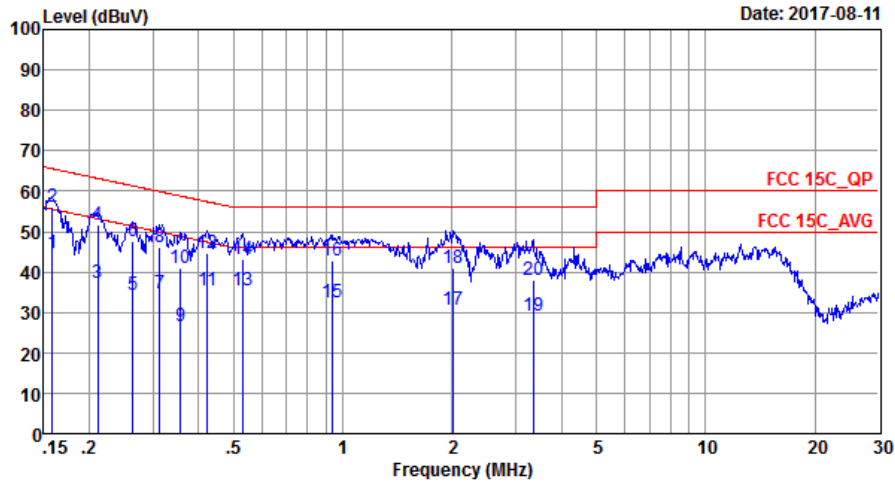

Site : CO01-SZ
 Condition: FCC 15C QP LISN 20170301_L LINE

	Freq	Level	Over Limit	Limit Line	Read Level	LISN Factor	Cable Loss	Remark
	MHz	dBuV	dB	dBuV	dBuV	dB	dB	
1	0.16	44.70	-10.86	55.56	34.30	0.03	10.37	Average
2 *	0.16	56.10	-9.46	65.56	45.70	0.03	10.37	QP
3	0.21	37.15	-15.99	53.14	26.90	0.03	10.22	Average
4	0.21	51.55	-11.59	63.14	41.30	0.03	10.22	QP
5	0.26	34.25	-17.04	51.29	24.00	0.03	10.22	Average
6	0.26	47.55	-13.74	61.29	37.30	0.03	10.22	QP
7	0.31	34.55	-15.33	49.88	24.30	0.03	10.22	Average
8	0.31	46.05	-13.83	59.88	35.80	0.03	10.22	QP
9	0.36	26.73	-22.05	48.78	16.50	0.03	10.20	Average
10	0.36	41.03	-17.75	58.78	30.80	0.03	10.20	QP
11	0.42	35.51	-11.86	47.37	25.29	0.03	10.19	Average
12	0.42	44.71	-12.66	57.37	34.49	0.03	10.19	QP
13	0.53	35.30	-10.70	46.00	25.10	0.02	10.18	Average
14	0.53	43.30	-12.70	56.00	33.10	0.02	10.18	QP
15	0.93	32.61	-13.39	46.00	22.40	0.06	10.15	Average
16	0.93	42.71	-13.29	56.00	32.50	0.06	10.15	QP
17	2.02	30.47	-15.53	46.00	20.20	0.11	10.16	Average
18	2.02	41.07	-14.93	56.00	30.80	0.11	10.16	QP
19	3.35	29.29	-16.71	46.00	18.89	0.17	10.23	Average
20	3.35	37.99	-18.01	56.00	27.59	0.17	10.23	QP



Test Mode :	Mode 1	Temperature :	24~25°C
Test Engineer :	Peng Wang	Relative Humidity :	50~55%
Test Voltage :	120Vac / 60Hz	Phase :	Neutral
Function Type :	WCDMA Band II Idle + Bluetooth Link + WLAN Link(2.4G) + Earphone + USB Cable (Charging from Adapter)		

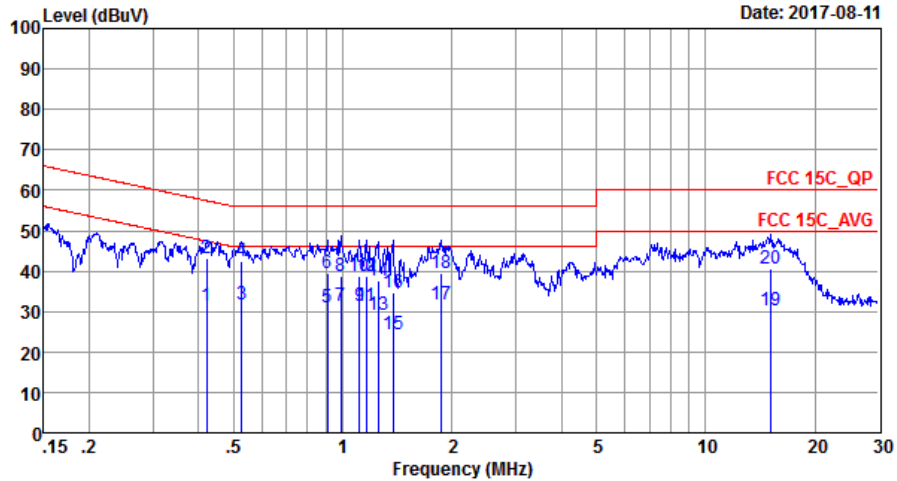

Site : C001-SZ
 Condition: FCC 15C_QP LISN_20170301_N NEUTRAL

	Freq	Level	Over Limit	Limit Line	Read Level	LISN Factor	Cable Loss	Remark
	MHz	dBuV	dB	dBuV	dBuV	dB	dB	
1	0.42	31.31	-16.11	47.42	21.10	0.02	10.19	Average
2	0.42	43.01	-14.41	57.42	32.80	0.02	10.19	QP
3	0.53	31.80	-14.20	46.00	21.60	0.02	10.18	Average
4 *	0.53	42.60	-13.40	56.00	32.40	0.02	10.18	QP
5	0.91	30.90	-15.10	46.00	20.71	0.04	10.15	Average
6	0.91	39.40	-16.60	56.00	29.21	0.04	10.15	QP
7	0.99	31.40	-14.60	46.00	21.20	0.05	10.15	Average
8	0.99	38.60	-17.40	56.00	28.40	0.05	10.15	QP
9	1.11	31.20	-14.80	46.00	21.00	0.05	10.15	Average
10	1.11	38.60	-17.40	56.00	28.40	0.05	10.15	QP
11	1.16	31.30	-14.70	46.00	21.10	0.05	10.15	Average
12	1.16	38.70	-17.30	56.00	28.50	0.05	10.15	QP
13	1.25	29.10	-16.90	46.00	18.90	0.05	10.15	Average
14	1.25	37.60	-18.40	56.00	27.40	0.05	10.15	QP
15	1.37	24.50	-21.50	46.00	14.30	0.05	10.15	Average
16	1.37	34.80	-21.20	56.00	24.60	0.05	10.15	QP
17	1.86	31.91	-14.09	46.00	21.70	0.05	10.16	Average
18	1.86	39.31	-16.69	56.00	29.10	0.05	10.16	QP
19	15.07	30.35	-19.65	50.00	19.70	0.33	10.32	Average
20	15.07	40.75	-19.25	60.00	30.10	0.33	10.32	QP



3.7 Antenna Requirements

3.7.1 Standard Applicable

If directional gain of transmitting antennas is greater than 6dBi, the power shall be reduced by the same level in dB comparing to gain minus 6dBi. For the fixed point-to-point operation, the power shall be reduced by one dB for every 3 dB that the directional gain of the antenna exceeds 6 dBi. The use of a permanently attached antenna or of an antenna that uses a unique coupling to the intentional radiator shall be considered sufficient to comply with the rule.

3.7.2 Antenna Anti-Replacement Construction

An embedded-in antenna design is used.

3.7.3 Antenna Gain

The antenna peak gain of EUT is less than 6 dBi. Therefore, it is not necessary to reduce maximum peak output power limit.



4 List of Measuring Equipment

Instrument	Manufacturer	Model No.	Serial No.	Characteristics	Calibration Date	Test Date	Due Date	Remark
Spectrum Analyzer	R&S	FSV40	101078	9kHz~40GHz	Apr. 20, 2017	Aug. 11, 2017	Apr. 19, 2018	Conducted (TH01-SZ)
Pulse Power Sensor	Anritsu	MA2411B	1207253	30MHz~40GHz	Jan. 06, 2017	Aug. 11, 2017	Jan. 05, 2018	Conducted (TH01-SZ)
Power Meter	Anritsu	ML2495A	1218010	50MHz Bandwidth	Jan. 06, 2017	Aug. 11, 2017	Jan. 05, 2018	Conducted (TH01-SZ)
EMI Receiver	R&S	ESR7	101630	9kHz~7GHz;	Jan. 06, 2017	Aug. 11, 2017	Jan. 05, 2018	Conduction (CO01-SZ)
AC LISN	EMCO	3816/2SH	00103912	9kHz~30MHz	Jan. 05, 2017	Aug. 11, 2017	Jan. 04, 2018	Conduction (CO01-SZ)
AC LISN (for auxiliary equipment)	MessTec	3816/2SH	00103892	9kHz~30MHz	Jan. 05, 2017	Aug. 11, 2017	Jan. 04, 2018	Conduction (CO01-SZ)
AC Power Source	Chroma	61602	616020000891	100Vac~250Vac	Jul. 19, 2017	Aug. 11, 2017	Jul. 18, 2017	Conduction (CO01-SZ)
Pulse Limiter	COM-POWER	LIT-153 Transient Limiter	53139	150kHz~30MHz	Oct. 11, 2016	Aug. 11, 2017	Oct. 10, 2017	Conduction (CO01-SZ)
RF Cable	Woken	B0720#0001	CO01SZ0007	150kHz~30MHz	Oct. 08, 2016	Aug. 11, 2017	Oct. 07, 2017	Conduction (CO01-SZ)
EMI Test Receiver&SA	KEYSIGHT	N9038A	MY54450083	20Hz~8.4GHz	Apr. 20, 2017	Aug. 22, 2017	Apr. 19, 2018	Radiation (03CH03-SZ)
EXA Spectrum Analyzer	KEYSIGHT	N9010A	MY55150246	10Hz~44GHz;	Apr. 20, 2017	Aug. 22, 2017	Apr. 19, 2018	Radiation (03CH03-SZ)
Loop Antenna	R&S	HFH2-Z2	100354	9kHz~30MHz	May 14, 2017	Aug. 22, 2017	May 13, 2018	Radiation (03CH03-SZ)
Bilog Antenna	TeseQ	CBL6112D	35408	30MHz-2GHz	May 14, 2017	Aug. 22, 2017	May 13, 2018	Radiation (03CH03-SZ)
Double Ridge Horn Antenna	SCHWARZBECK	BBHA 9120D	9120D-1285	1GHz~18GHz	Jan. 12, 2017	Aug. 22, 2017	Jan. 11, 2018	Radiation (03CH03-SZ)
SHF-EHF Horn	com-power	AH-840	101071	18Ghz-40GHz	Jun. 16, 2017	Aug. 22, 2017	Jun. 15, 2018	Radiation (03CH03-SZ)
Amplifier	Burgeon	BPA-530	102210	0.01Hz ~3000MHz	Oct. 11, 2016	Aug. 22, 2017	Oct. 10, 2017	Radiation (03CH03-SZ)
HF Amplifier	MITEQ	AMF-7D-00101800-30-10P-R	1943528	1GHz~18GHz	Oct. 11, 2016	Aug. 22, 2017	Oct. 10, 2017	Radiation (03CH03-SZ)
Amplifier	Agilent Technologies	83017A	MY39501302	500MHz~26.5G Hz	Jan. 06, 2017	Aug. 22, 2017	Jan. 05, 2018	Radiation (03CH03-SZ)
HF Amplifier	MITEQ	TTA1840-35-HG	1988315	18GHz~40GHz	Jul. 27, 2017	Aug. 22, 2017	Jul. 26, 2018	Radiation (03CH03-SZ)
AC Power Source	Chroma	61601	616010001985	N/A	NCR	Aug. 22, 2017	NCR	Radiation (03CH03-SZ)
Turn Table	EM	EM1000	N/A	0~360 degree	NCR	Aug. 22, 2017	NCR	Radiation (03CH03-SZ)
Antenna Mast	EM	EM1000	N/A	1 m~4 m	NCR	Aug. 22, 2017	NCR	Radiation (03CH03-SZ)

NCR: No Calibration Required



5 Uncertainty of Evaluation

Uncertainty of Conducted Emission Measurement (150kHz ~ 30MHz)

Measuring Uncertainty for a Level of Confidence of 95% ($U = 2Uc(y)$)	2.5dB
---	-------

Uncertainty of Radiated Emission Measurement (30 MHz ~ 1000 MHz)

Measuring Uncertainty for a Level of Confidence of 95% ($U = 2Uc(y)$)	5.1 dB
---	--------

Uncertainty of Radiated Emission Measurement (1000 MHz ~ 18000 MHz)

Measuring Uncertainty for a Level of Confidence of 95% ($U = 2Uc(y)$)	5.0 dB
---	--------

Uncertainty of Radiated Emission Measurement (18000 MHz ~ 40000 MHz)

Measuring Uncertainty for a Level of Confidence of 95% ($U = 2Uc(y)$)	5.0 dB
---	--------



Appendix A. Conducted Test Results

A1 - DTS Part

Test Engineer:	Sam Zheng	Temperature:	24~26	°C
Test Date:	2017/8/11	Relative Humidity:	50~53	%

TEST RESULTS DATA
6dB and 99% Occupied Bandwidth

2.4GHz Band								
Mod.	Data Rate	NTX	CH.	Freq. (MHz)	99% Occupied BW (MHz)	6dB BW (MHz)	6dB BW Limit (MHz)	Pass/Fail
11b	1Mbps	1	1	2412	13.64	8.53	0.50	Pass
11b	1Mbps	1	6	2437	13.69	8.99	0.50	Pass
11b	1Mbps	1	11	2462	13.69	8.01	0.50	Pass
11g	6Mbps	1	1	2412	18.58	16.28	0.50	Pass
11g	6Mbps	1	6	2437	18.68	16.30	0.50	Pass
11g	6Mbps	1	11	2462	18.68	16.30	0.50	Pass
HT20	MCS0	1	1	2412	19.23	17.54	0.50	Pass
HT20	MCS0	1	6	2437	19.53	17.56	0.50	Pass
HT20	MCS0	1	11	2462	19.43	17.56	0.50	Pass
HT40	MCS0	1	3	2422	36.56	35.13	0.50	Pass
HT40	MCS0	1	6	2437	36.76	35.33	0.50	Pass
HT40	MCS0	1	9	2452	36.86	35.45	0.50	Pass

TEST RESULTS DATA
Peak Power Table

2.4GHz Band										
Mod.	Data Rate	NTX	CH.	Freq. (MHz)	Peak Conducted Power (dBm)	Conducted Power Limit (dBm)	DG (dBi)	EIRP Power (dBm)	EIRP Power Limit (dBm)	Pass /Fail
11b	1Mbps	1	1	2412	17.96	30.00	0.99	18.95	36.00	Pass
11b	1Mbps	1	6	2437	18.09	30.00	0.99	19.08	36.00	Pass
11b	1Mbps	1	11	2462	17.81	30.00	0.99	18.80	36.00	Pass
11g	6Mbps	1	1	2412	21.80	30.00	0.99	22.79	36.00	Pass
11g	6Mbps	1	6	2437	21.92	30.00	0.99	22.91	36.00	Pass
11g	6Mbps	1	11	2462	21.89	30.00	0.99	22.88	36.00	Pass
HT20	MCS0	1	1	2412	20.95	30.00	0.99	21.94	36.00	Pass
HT20	MCS0	1	6	2437	21.05	30.00	0.99	22.04	36.00	Pass
HT20	MCS0	1	11	2462	21.31	30.00	0.99	22.30	36.00	Pass
HT40	MCS0	1	3	2422	21.55	30.00	0.99	22.54	36.00	Pass
HT40	MCS0	1	6	2437	21.63	30.00	0.99	22.62	36.00	Pass
HT40	MCS0	1	9	2452	21.36	30.00	0.99	22.35	36.00	Pass

TEST RESULTS DATA
Average Power Table
(Reporting Only)

2.4GHz Band						
Mod.	Data Rate	N _{TX}	CH.	Freq. (MHz)	Duty Factor (dB)	Average Conducted Power (dBm)
11b	1Mbps	1	1	2412	0.11	15.39
11b	1Mbps	1	6	2437	0.11	15.50
11b	1Mbps	1	11	2462	0.11	15.20
11g	6Mbps	1	1	2412	0.57	13.70
11g	6Mbps	1	6	2437	0.57	13.44
11g	6Mbps	1	11	2462	0.57	13.71
HT20	MCS0	1	1	2412	0.62	12.45
HT20	MCS0	1	6	2437	0.62	12.13
HT20	MCS0	1	11	2462	0.62	12.39
HT40	MCS0	1	3	2422	1.21	12.85
HT40	MCS0	1	6	2437	1.21	12.58
HT40	MCS0	1	9	2452	1.21	12.36

TEST RESULTS DATA
Peak Power Density

2.4GHz Band								
Mod.	Data Rate	NTX	CH.	Freq. (MHz)	Peak PSD (dBm /3kHz)	DG (dBi)	Peak PSD Limit (dBm /3kHz)	Pass/Fail
11b	1Mbps	1	1	2412	-5.03	0.99	8.00	Pass
11b	1Mbps	1	6	2437	-6.77	0.99	8.00	Pass
11b	1Mbps	1	11	2462	-4.87	0.99	8.00	Pass
11g	6Mbps	1	1	2412	-10.93	0.99	8.00	Pass
11g	6Mbps	1	6	2437	-9.81	0.99	8.00	Pass
11g	6Mbps	1	11	2462	-11.14	0.99	8.00	Pass
HT20	MCS0	1	1	2412	-10.27	0.99	8.00	Pass
HT20	MCS0	1	6	2437	-11.32	0.99	8.00	Pass
HT20	MCS0	1	11	2462	-11.78	0.99	8.00	Pass
HT40	MCS0	1	3	2422	-14.12	0.99	8.00	Pass
HT40	MCS0	1	6	2437	-15.25	0.99	8.00	Pass
HT40	MCS0	1	9	2452	-15.38	0.99	8.00	Pass



Appendix B. Radiated Spurious Emission

2.4GHz 2400~2483.5MHz

WIFI 802.11b (Band Edge @ 3m)

WIFI Ant.	Note	Frequency	Level	Over Limit	Limit Line	Read Level	Antenna Factor	Cable Loss	Preamp Factor	Ant Pos	Table Pos	Peak Avg.	Pol.
1		(MHz)	(dBμV/m)	(dB)	(dBμV/m)	(dBμV)	(dB/m)	(dB)	(dB)	(cm)	(deg)	(P/A)	(H/V)
802.11b CH 01 2412MHz		2388.225	42.55	-31.45	74	42.81	27.43	5.64	33.33	169	63	P	H
		2388.12	32.4	-21.6	54	32.66	27.43	5.64	33.33	169	63	A	H
	*	2412	101.41	-	-	101.6	27.49	5.64	33.32	169	63	P	H
	*	2412	98.07	-	-	98.26	27.49	5.64	33.32	169	63	P	H
		2374.995	42.64	-31.36	74	43.01	27.37	5.59	33.33	299	251	P	V
		2390	32.45	-21.55	54	32.7	27.43	5.64	33.32	299	251	A	V
	*	2412	100.62	-	-	100.81	27.49	5.64	33.32	299	251	P	V
	*	2412	97.45	-	-	97.64	27.49	5.64	33.32	299	251	A	V
802.11b CH 06 2437MHz		2333.24	41.87	-32.13	74	42.49	27.18	5.53	33.33	169	63	P	H
		2388.96	31.86	-22.14	54	32.12	27.43	5.64	33.33	169	63	A	H
	*	2437	101.5	-	-	101.52	27.61	5.68	33.31	169	63	P	H
	*	2437	98.44	-	-	98.46	27.61	5.68	33.31	169	63	A	H
		2490.13	42.62	-31.38	74	42.41	27.8	5.72	33.31	169	63	P	H
		2483.5	32.44	-21.56	54	32.29	27.74	5.72	33.31	169	63	A	H
		2378.6	41.92	-32.08	74	42.29	27.37	5.59	33.33	299	251	P	V
		2389.94	31.81	-22.19	54	32.06	27.43	5.64	33.32	299	251	A	V
	*	2436	99.38	-	-	99.46	27.55	5.68	33.31	299	251	P	V
	*	2438	96.33	-	-	96.35	27.61	5.68	33.31	299	251	A	V
		2487.19	42.88	-31.12	74	42.73	27.74	5.72	33.31	299	251	P	V
	2483.5	32.35	-21.65	54	32.2	27.74	5.72	33.31	299	251	A	V	



802.11b CH 11 2462MHz	*	2462	101.26	-	-	101.21	27.68	5.68	33.31	169	63	P	H
	*	2462	98.36	-	-	98.31	27.68	5.68	33.31	169	63	A	H
		2484.28	44.78	-29.22	74	44.63	27.74	5.72	33.31	169	63	P	H
		2483.52	36.65	-17.35	54	36.5	27.74	5.72	33.31	169	63	A	H
	*	2462	100.35	-	-	100.3	27.68	5.68	33.31	299	251	P	V
	*	2462	97.28	-	-	97.23	27.68	5.68	33.31	299	251	A	V
		2484.4	44.28	-29.72	74	44.13	27.74	5.72	33.31	299	251	P	V
		2483.56	35.08	-18.92	54	34.93	27.74	5.72	33.31	299	251	A	V
Remark	<ol style="list-style-type: none"> No other spurious found. All results are PASS against Peak and Average limit line. 												



**2.4GHz 2400~2483.5MHz
WIFI 802.11b (Harmonic @ 3m)**

WIFI Ant. 1	Note	Frequency (MHz)	Level (dBμV/m)	Over Limit (dB)	Limit Line (dBμV/m)	Read Level (dBμV)	Antenna Factor (dB/m)	Cable Loss (dB)	Preamp Factor (dB)	Ant Pos (cm)	Table Pos (deg)	Peak Avg. (P/A)	Pol. (H/V)
802.11b CH 01 2412MHz		4824	43.1	-30.9	74	60.39	31.49	7.82	56.6	150	360	P	H
		4824	43.06	-30.94	74	60.35	31.49	7.82	56.6	150	360	P	V
802.11b CH 06 2437MHz		4874	41.68	-32.32	74	59.16	31.61	7.82	56.91	150	360	P	H
		7311	42.45	-31.55	74	55.11	36.17	9.17	58	148	360	P	H
		4874	41.33	-32.67	74	58.81	31.61	7.82	56.91	150	360	P	V
		7311	42.42	-31.58	74	55.08	36.17	9.17	58	148	360	P	V
802.11b CH 11 2462MHz		4924	42.42	-31.58	74	58.95	31.73	7.82	56.08	148	360	P	H
		7386	42.51	-31.49	74	55.03	36.28	9.21	58.01	148	360	P	H
		4924	44.66	-29.34	74	61.19	31.73	7.82	56.08	148	360	P	V
		7386	43.75	-30.25	74	56.27	36.28	9.21	58.01	148	360	P	V
Remark	1. No other spurious found. 2. All results are PASS against Peak and Average limit line.												



2.4GHz 2400~2483.5MHz
WIFI 802.11g (Band Edge @ 3m)

WIFI Ant. 1	Note	Frequency (MHz)	Level (dBμV/m)	Over Limit (dB)	Limit Line (dBμV/m)	Read Level (dBμV)	Antenna Factor (dB/m)	Cable Loss (dB)	Preamp Factor (dB)	Ant Pos (cm)	Table Pos (deg)	Peak Avg. (P/A)	Pol. (H/V)
802.11g CH 01 2412MHz		2389.695	57.32	-16.68	74	57.58	27.43	5.64	33.33	109	202	P	H
		2389.8	42.42	-11.58	54	42.67	27.43	5.64	33.32	109	202	A	H
	*	2412	98.54	-	-	98.73	27.49	5.64	33.32	109	202	P	H
	*	2412	90.38	-	-	90.57	27.49	5.64	33.32	109	202	A	H
		2389.59	58.61	-15.39	74	58.87	27.43	5.64	33.33	180	248	P	V
		2389.8	44.67	-9.33	54	44.92	27.43	5.64	33.32	180	248	A	V
	*	2412	101.14	-	-	101.33	27.49	5.64	33.32	180	248	P	V
	*	2412	93.36	-	-	93.55	27.49	5.64	33.32	180	248	A	V
802.11g CH 06 2437MHz		2383.36	43.29	-30.71	74	43.66	27.37	5.59	33.33	109	202	P	H
		2384.76	32.96	-21.04	54	33.28	27.37	5.64	33.33	109	202	A	H
	*	2437	98.9	-	-	98.92	27.61	5.68	33.31	109	202	P	H
	*	2437	89.33	-	-	89.35	27.61	5.68	33.31	109	202	A	H
		2489.08	44.56	-29.44	74	44.35	27.8	5.72	33.31	109	202	P	H
		2489.36	35.18	-18.82	54	34.97	27.8	5.72	33.31	109	202	A	H
		2364.6	42.73	-31.27	74	43.17	27.3	5.59	33.33	180	248	P	V
		2384.76	33.9	-20.1	54	34.22	27.37	5.64	33.33	180	248	A	V
	*	2437	100.53	-	-	100.55	27.61	5.68	33.31	180	248	P	V
	*	2437	93.77	-	-	93.79	27.61	5.68	33.31	180	248	A	V
		2489.43	46.25	-27.75	74	46.04	27.8	5.72	33.31	180	248	P	V
		2489.22	37.19	-16.81	54	36.98	27.8	5.72	33.31	180	248	A	V



802.11g CH 11 2462MHz	*	2462	99.17	-	-	99.12	27.68	5.68	33.31	109	202	P	H
	*	2462	91.49	-	-	91.44	27.68	5.68	33.31	109	202	A	H
		2484.04	63.96	-10.04	74	63.81	27.74	5.72	33.31	109	202	P	H
		2483.56	49.72	-4.28	54	49.57	27.74	5.72	33.31	109	202	A	H
	*	2462	101.24	-	-	101.19	27.68	5.68	33.31	180	248	P	V
	*	2462	94.03	-	-	93.98	27.68	5.68	33.31	180	248	A	V
		2483.68	65.23	-8.77	74	65.08	27.74	5.72	33.31	180	248	P	V
		2483.56	51.29	-2.71	54	51.14	27.74	5.72	33.31	180	248	A	V
Remark	1. No other spurious found. 2. All results are PASS against Peak and Average limit line.												



2.4GHz 2400~2483.5MHz

WIFI 802.11g (Harmonic @ 3m)

WIFI Ant. 1	Note	Frequency (MHz)	Level (dBμV/m)	Over Limit (dB)	Limit Line (dBμV/m)	Read Level (dBμV)	Antenna Factor (dB/m)	Cable Loss (dB)	Preamp Factor (dB)	Ant Pos (cm)	Table Pos (deg)	Peak Avg. (P/A)	Pol. (H/V)
802.11g CH 01 2412MHz		4824	43.33	-30.67	74	60.62	31.49	7.82	56.6	152	360	P	H
		4824	41.79	-32.21	74	59.08	31.49	7.82	56.6	152	360	P	V
802.11g CH 06 2437MHz		4874	40.93	-33.07	74	58.41	31.61	7.82	56.91	152	360	P	H
		7311	43.08	-30.92	74	55.74	36.17	9.17	58	152	360	P	H
		4874	40.67	-33.33	74	58.15	31.61	7.82	56.91	152	360	P	V
802.11g CH 11 2462MHz		7311	43.08	-30.92	74	55.74	36.17	9.17	58	152	360	P	V
		4924	43.82	-30.18	74	60.35	31.73	7.82	56.08	152	360	P	H
		7386	43.61	-30.39	74	56.13	36.28	9.21	58.01	152	360	P	H
		4924	43.23	-30.77	74	59.76	31.73	7.82	56.08	152	360	P	V
802.11g CH 11 2462MHz		7386	44.19	-29.81	74	56.71	36.28	9.21	58.01	152	360	P	V
	Remark 1. No other spurious found. 2. All results are PASS against Peak and Average limit line.												



**2.4GHz 2400~2483.5MHz
WIFI 802.11n HT20 (Band Edge @ 3m)**

WIFI Ant. 1	Note	Frequency (MHz)	Level (dBμV/m)	Over Limit (dB)	Limit Line (dBμV/m)	Read Level (dBμV)	Antenna Factor (dB/m)	Cable Loss (dB)	Preamp Factor (dB)	Ant Pos (cm)	Table Pos (deg)	Peak Avg. (P/A)	Pol. (H/V)
802.11n HT20 CH 01 2412MHz		2389.38	63.37	-10.63	74	63.63	27.43	5.64	33.33	192	139	P	H
		2389.8	46.2	-7.8	54	46.45	27.43	5.64	33.32	192	139	A	H
	*	2412	99.64	-	-	99.83	27.49	5.64	33.32	192	139	P	H
	*	2412	92.09	-	-	92.28	27.49	5.64	33.32	192	139	A	H
		2389.38	60.09	-13.91	74	60.35	27.43	5.64	33.33	100	97	P	V
		2389.695	45.31	-8.69	54	45.57	27.43	5.64	33.33	100	97	A	V
	*	2412	99.46	-	-	99.65	27.49	5.64	33.32	100	97	P	V
	*	2412	91.65	-	-	91.84	27.49	5.64	33.32	100	97	A	V
802.11n HT20 CH 06 2437MHz		2383.64	42.22	-31.78	74	42.59	27.37	5.59	33.33	187	142	P	H
		2385.46	34.29	-19.71	54	34.61	27.37	5.64	33.33	187	142	A	H
	*	2437	99.93	-	-	99.95	27.61	5.68	33.31	187	142	P	H
	*	2437	92.1	-	-	92.12	27.61	5.68	33.31	187	142	A	H
		2488.8	46.26	-27.74	74	46.05	27.8	5.72	33.31	187	142	P	H
		2488.8	37.54	-16.46	54	37.33	27.8	5.72	33.31	187	142	A	H
		2384.9	43.42	-30.58	74	43.74	27.37	5.64	33.33	100	96	P	V
		2385.46	33.83	-20.17	54	34.15	27.37	5.64	33.33	100	96	A	V
	*	2437	99.08	-	-	99.1	27.61	5.68	33.31	100	96	P	V
	*	2437	91.5	-	-	91.52	27.61	5.68	33.31	100	96	A	V
		2486.98	46.37	-27.63	74	46.22	27.74	5.72	33.31	100	96	P	V
	2488.8	37.25	-16.75	54	37.04	27.8	5.72	33.31	100	96	A	V	



802.11n HT20 CH 11 2462MHz	*	2462	100.41	-	-	100.36	27.68	5.68	33.31	182	145	P	H
	*	2462	92.79	-	-	92.74	27.68	5.68	33.31	182	145	A	H
		2484.84	65.71	-8.29	74	65.56	27.74	5.72	33.31	182	145	P	H
		2483.68	52.02	-1.98	54	51.87	27.74	5.72	33.31	182	145	A	H
	*	2462	100.24	-	-	100.19	27.68	5.68	33.31	100	97	P	V
	*	2462	92.77	-	-	92.72	27.68	5.68	33.31	100	97	A	V
		2483.64	68.18	-5.82	74	68.03	27.74	5.72	33.31	100	97	P	V
		2483.52	51.71	-2.29	54	51.56	27.74	5.72	33.31	100	97	A	V
Remark	1. No other spurious found. 2. All results are PASS against Peak and Average limit line.												



2.4GHz 2400~2483.5MHz
WIFI 802.11n HT20 (Harmonic @ 3m)

WIFI Ant. 1	Note	Frequency (MHz)	Level (dBμV/m)	Over Limit (dB)	Limit Line (dBμV/m)	Read Level (dBμV)	Antenna Factor (dB/m)	Cable Loss (dB)	Preamp Factor (dB)	Ant Pos (cm)	Table Pos (deg)	Peak Avg. (P/A)	Pol. (H/V)
802.11n HT20 CH 01 2412MHz		4824	41.93	-32.07	74	59.22	31.49	7.82	56.6	149	360	P	H
		4824	42.32	-31.68	74	59.61	31.49	7.82	56.6	149	360	P	V
802.11n HT20 CH 06 2437MHz		4874	40.23	-33.77	74	57.71	31.61	7.82	56.91	148	360	P	H
		7311	43.21	-30.79	74	55.87	36.17	9.17	58	148	360	P	H
		4874	40.46	-33.54	74	57.94	31.61	7.82	56.91	148	360	P	V
		7311	42.35	-31.65	74	55.01	36.17	9.17	58	148	360	P	V
802.11n HT20 CH 11 2462MHz		4924	44.45	-29.55	74	60.98	31.73	7.82	56.08	148	360	P	H
		7386	42.58	-31.42	74	55.1	36.28	9.21	58.01	148	360	P	H
		4924	43.84	-30.16	74	60.37	31.73	7.82	56.08	148	360	P	V
		7386	42.13	-31.87	74	54.65	36.28	9.21	58.01	148	360	P	V
Remark	1. No other spurious found. 2. All results are PASS against Peak and Average limit line.												



**2.4GHz 2400~2483.5MHz
WIFI 802.11n HT40 (Band Edge @ 3m)**

WIFI Ant. 1	Note	Frequency (MHz)	Level (dBμV/m)	Over Limit (dB)	Limit Line (dBμV/m)	Read Level (dBμV)	Antenna Factor (dB/m)	Cable Loss (dB)	Preamp Factor (dB)	Ant Pos (cm)	Table Pos (deg)	Peak Avg. (P/A)	Pol. (H/V)
802.11n HT40 CH 03 2422MHz		2389.38	54.09	-19.91	74	54.35	27.43	5.64	33.33	169	57	P	H
		2389.1	36.22	-17.78	54	36.48	27.43	5.64	33.33	169	57	A	H
	*	2422	98.71	-	-	98.83	27.55	5.64	33.31	169	57	P	H
	*	2422	91.11	-	-	91.23	27.55	5.64	33.31	169	57	A	H
		2487.19	43.16	-30.84	74	43.01	27.74	5.72	33.31	169	57	P	H
		2484.74	33.41	-20.59	54	33.26	27.74	5.72	33.31	169	57	A	H
		2389.52	55.35	-18.65	74	55.61	27.43	5.64	33.33	236	276	P	V
		2389.1	37.26	-16.74	54	37.52	27.43	5.64	33.33	236	276	A	V
	*	2422	97.74	-	-	97.86	27.55	5.64	33.31	236	276	P	V
	*	2422	90.21	-	-	90.33	27.55	5.64	33.31	236	276	A	V
		2485.93	42.52	-31.48	74	42.37	27.74	5.72	33.31	236	276	P	V
		2483.5	33.54	-20.46	54	33.39	27.74	5.72	33.31	236	276	A	V
802.11n HT40 CH 06 2437MHz		2388.54	43.21	-30.79	74	43.47	27.43	5.64	33.33	193	61	P	H
		2389.38	33.1	-20.9	54	33.36	27.43	5.64	33.33	193	61	A	H
	*	2437	98.73	-	-	98.75	27.61	5.68	33.31	193	61	P	H
	*	2437	91.4	-	-	91.42	27.61	5.68	33.31	193	61	A	H
		2486.91	46.84	-27.16	74	46.69	27.74	5.72	33.31	193	61	P	H
		2484.18	34.41	-19.59	54	34.26	27.74	5.72	33.31	193	61	A	H
		2388.96	44.02	-29.98	74	44.28	27.43	5.64	33.33	236	276	P	V
		2389.94	33.13	-20.87	54	33.38	27.43	5.64	33.32	236	276	A	V
	*	2437	97.45	-	-	97.47	27.61	5.68	33.31	236	276	P	V
	*	2437	89.48	-	-	89.5	27.61	5.68	33.31	236	276	A	V
		2485.79	46.12	-27.88	74	45.97	27.74	5.72	33.31	236	276	P	V
		2484.25	33.77	-20.23	54	33.62	27.74	5.72	33.31	236	276	A	V



802.11n HT40 CH 09 2452MHz		2363.9	41.47	-32.53	74	41.91	27.3	5.59	33.33	193	61	P	H
		2387.98	33.02	-20.98	54	33.28	27.43	5.64	33.33	193	61	A	H
	*	2452	98.71	-	-	98.73	27.61	5.68	33.31	193	61	P	H
	*	2452	91.27	-	-	91.29	27.61	5.68	33.31	193	61	A	H
		2486.63	54.87	-19.13	74	54.72	27.74	5.72	33.31	193	61	P	H
		2486.84	37.69	-16.31	54	37.54	27.74	5.72	33.31	193	61	A	H
		2389.52	41.89	-32.11	74	42.15	27.43	5.64	33.33	236	276	P	V
		2389.52	32.56	-21.44	54	32.82	27.43	5.64	33.33	236	276	A	V
	*	2452	97.91	-	-	97.93	27.61	5.68	33.31	236	276	P	V
	*	2452	90.39	-	-	90.41	27.61	5.68	33.31	236	276	A	V
		2486.56	54.45	-19.55	74	54.3	27.74	5.72	33.31	236	276	P	V
		2484.88	36.89	-17.11	54	36.74	27.74	5.72	33.31	236	276	A	V
Remark	1. No other spurious found. 2. All results are PASS against Peak and Average limit line.												



2.4GHz 2400~2483.5MHz
WIFI 802.11n HT40 (Harmonic @ 3m)

WIFI Ant. 1	Note	Frequency (MHz)	Level (dBμV/m)	Over Limit (dB)	Limit Line (dBμV/m)	Read Level (dBμV)	Antenna Factor (dB/m)	Cable Loss (dB)	Preamp Factor (dB)	Ant Pos (cm)	Table Pos (deg)	Peak Avg. (P/A)	Pol. (H/V)
802.11n		4844	40.74	-33.26	74	57.97	31.53	7.82	56.58	148	360	P	H
HT40		7266	44.28	-29.72	74	57.28	36.13	9.14	58.27	148	360	P	H
CH 03		4844	41.48	-32.52	74	58.71	31.53	7.82	56.58	148	360	P	V
2422MHz		7266	44.18	-29.82	74	57.18	36.13	9.14	58.27	148	360	P	V
802.11n		4874	39.8	-34.2	74	57.28	31.61	7.82	56.91	149	360	P	H
HT40		7311	43.12	-30.88	74	55.78	36.17	9.17	58	149	360	P	H
CH 06		4874	40.35	-33.65	74	57.83	31.61	7.82	56.91	149	360	P	V
2437MHz		7311	43.66	-30.34	74	56.32	36.17	9.17	58	149	360	P	V
802.11n		4904	41.98	-32.02	74	58.82	31.69	7.82	56.35	148	360	P	H
HT40		7356	42.22	-31.78	74	54.76	36.23	9.19	57.96	148	360	P	H
CH 09		4904	41.31	-32.69	74	58.15	31.69	7.82	56.35	148	360	P	V
2452MHz		7356	40.88	-33.12	74	53.42	36.23	9.19	57.96	148	360	P	V
Remark	1. No other spurious found. 2. All results are PASS against Peak and Average limit line.												



Emission below 1GHz

2.4GHz WIFI 802.11n HT20 (LF)

WIFI	Note	Frequency	Level	Over	Limit	Read	Antenna	Cable	Preamp	Ant	Table	Peak	Pol.
Ant.				Limit	Line	Level	Factor	Loss	Factor	Pos	Pos	Avg.	
1		(MHz)	(dBμV/m)	(dB)	(dBμV/m)	(dBμV)	(dB/m)	(dB)	(dB)	(cm)	(deg)	(P/A)	(H/V)
2.4GHz 802.11n HT20 LF		30	28.91	-11.09	40	37.05	17.28	0.65	26.07	100	0	P	H
		411.21	26.01	-19.99	46	33.49	16.72	1.67	25.87	-	-	P	H
		684.75	29.62	-16.38	46	34.33	19.62	2.05	26.38	-	-	P	H
		795.33	29.63	-16.37	46	33.18	20.43	2.2	26.18	-	-	P	H
		934.04	31.86	-14.14	46	33.33	21.73	2.41	25.61	-	-	P	H
		985.45	31.98	-22.02	54	32.49	22.24	2.47	25.22	-	-	P	H
		30	28.36	-11.64	40	36.5	17.28	0.65	26.07	100	0	P	V
		435.46	26.45	-19.55	46	33.79	16.99	1.67	26	-	-	P	V
		674.08	28.57	-17.43	46	33.42	19.49	2.05	26.39	-	-	P	V
		856.44	31.1	-14.9	46	33.81	20.99	2.3	26	-	-	P	V
		960.23	31.92	-22.08	54	32.93	21.99	2.41	25.41	-	-	P	V
	999.03	32.6	-21.4	54	32.96	22.29	2.47	25.12	-	-	P	V	
Remark	1. No other spurious found. 2. All results are PASS against limit line.												



Note symbol

*	Fundamental Frequency which can be ignored. However, the level of any unwanted emissions shall not exceed the level of the fundamental frequency.
!	Test result is over limit line.
P/A	Peak or Average
H/V	Horizontal or Vertical



A calculation example for radiated spurious emission is shown as below:

WIFI	Note	Frequency	Level	Over	Limit	Read	Antenna	Cable	Preamp	Ant	Table	Peak	Pol.
Ant.				Limit	Line	Level	Factor	Loss	Factor	Pos	Pos	Avg.	
1		(MHz)	(dBμV/m)	(dB)	(dBμV/m)	(dBμV)	(dB/m)	(dB)	(dB)	(cm)	(deg)	(P/A)	(H/V)
802.11b		2390	55.45	-18.55	74	54.51	32.22	4.58	35.86	103	308	P	H
CH 01													
2412MHz		2390	43.54	-10.46	54	42.6	32.22	4.58	35.86	103	308	A	H

- Level(dBμV/m) =
Antenna Factor(dB/m) + Cable Loss(dB) + Read Level(dBμV) - Preamp Factor(dB)
- Over Limit(dB) = Level(dBμV/m) – Limit Line(dBμV/m)

For Peak Limit @ 2390MHz:

- Level(dBμV/m)
= Antenna Factor(dB/m) + Cable Loss(dB) + Read Level(dBμV) - Preamp Factor(dB)
= 32.22(dB/m) + 4.58(dB) + 54.51(dBμV) – 35.86 (dB)
= 55.45 (dBμV/m)
- Over Limit(dB)
= Level(dBμV/m) – Limit Line(dBμV/m)
= 55.45(dBμV/m) – 74(dBμV/m)
= -18.55(dB)

For Average Limit @ 2390MHz:

- Level(dBμV/m)
= Antenna Factor(dB/m) + Cable Loss(dB) + Read Level(dBμV) - Preamp Factor(dB)
= 32.22(dB/m) + 4.58(dB) + 42.6(dBμV) – 35.86 (dB)
= 43.54 (dBμV/m)
- Over Limit(dB)
= Level(dBμV/m) – Limit Line(dBμV/m)
= 43.54(dBμV/m) – 54(dBμV/m)
= -10.46(dB)

Both peak and average measured complies with the limit line, so test result is “PASS”.



Appendix C. Duty Cycle Plots

Band	Duty Cycle(%)	T(ms)	1/T(KHz)	VBW Setting
802.11b	97.43	8.232	0.121	300Hz
802.11g	87.62	1.364	0.733	1KHz
802.11n HT20	86.70	1.275	0.784	1KHz
802.11n HT40	75.66	0.631	1.585	3KHz

802.11b

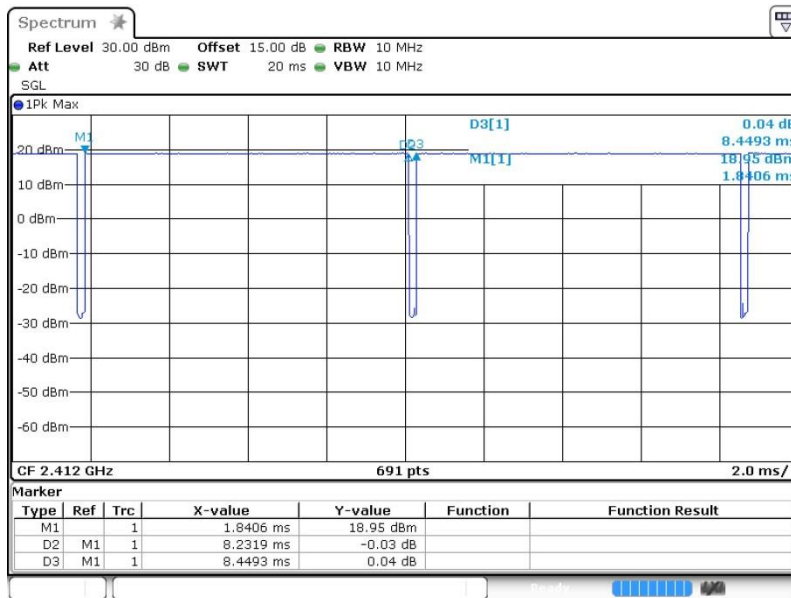



802.11g

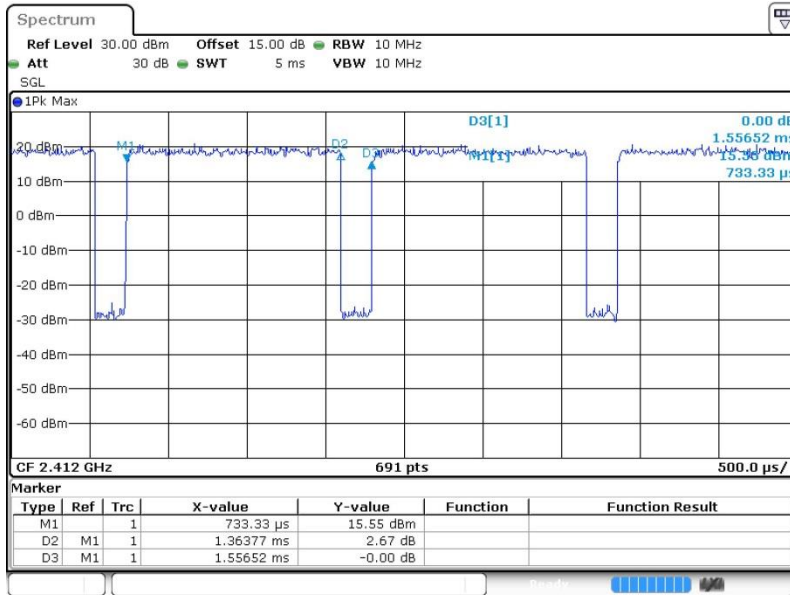

802.11n HT20

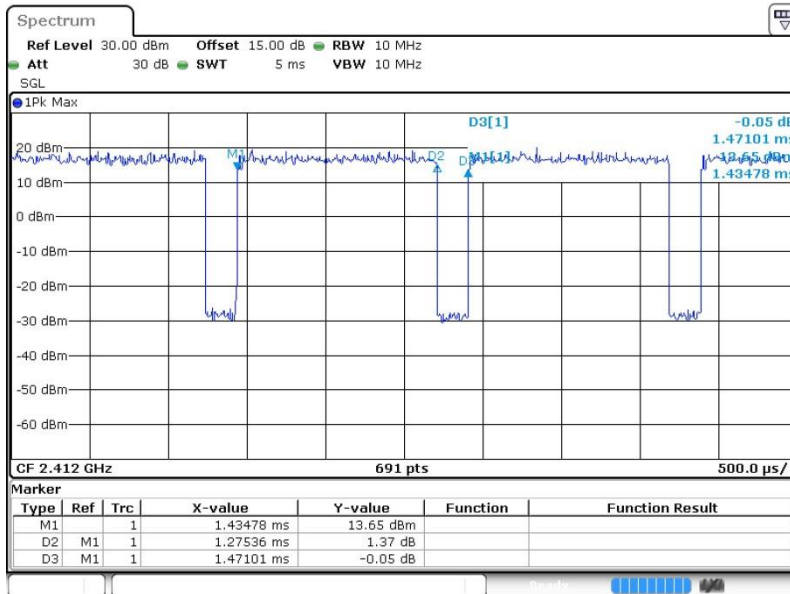



802.11n HT40

