



FCC RADIO TEST REPORT

Applicant : Acer Incorporated
Address : 9F, 88, Sec. 1, Xintai 5th Rd. New Taipei City, Taiwan
Equipment : Presenter
Model No. : BR2101
Trade Name : Acer
FCC ID. : HLZBR2101
Standard : FCC part 15 Subpart C §15.247

I HEREBY CERTIFY THAT :

The sample was received on Jun. 23, 2021 and the testing was completed on Jul. 15, 2021 at CerpPASS Technology Corp. The test result refers exclusively to the test presented test model / sample. Without written approval of CerpPASS Technology Corp., the test report shall not be reproduced except in full.

Approved by:

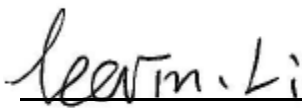

Leevin Li /Supervisor



Contents

1. Summary of Test Procedure and Test Results	5
1.1 Applicable Standards	5
2. Test Configuration of Equipment under Test	6
2.1 Feature of Equipment under Test	6
2.2 Carrier Frequency of Channels	7
2.3 Test Mode and Test Software	7
2.4 Description of Test System	8
2.5 General Information of Test	9
2.6 Measurement Uncertainty	9
3. Test Equipment and Ancillaries Used for Tests	10
4. Antenna Requirements	12
4.1 Standard Applicable	12
4.2 Antenna Construction and Directional Gain	12
5. Test of Conducted Emission	13
5.1 Test Limit	13
5.2 Test Procedures	13
5.3 Typical Test Setup	14
5.4 Test Result and Data	15
6. Test of Spurious Emission (Radiated)	17
6.1 Test Limit	17
6.2 Test Procedures	17
6.3 Typical Test Setup	18
6.4 Test Result and Data (9kHz ~ 30MHz)	19
6.5 Test Result and Data (30MHz ~ 1GHz)	19
6.6 Test Result and Data (1GHz ~ 25GHz)	21
6.7 Restricted Bands of Operation	33
7. Test of Spurious Emission (Conducted)	42
7.1 Test Limit	42
7.2 Test Procedure	42
7.3 Test Setup Layout	42
7.4 Test Result and Data	42
8. On Time, Duty Cycle and Measurement methods	45
8.1 Test Limit	45
8.2 Test Procedure	45
8.3 Test Setup Layout	45
8.4 Test Result and Data	45
9. 6dB Bandwidth Measurement Data	46
9.1 Test Limit	46
9.2 Test Procedures	46
9.3 Test Setup Layout	46
9.4 Test Result and Data	46
10. Maximum Peak and Average Output Power	48
10.1 Test Limit	48
10.2 Test Procedures	48



10.3 Test Setup Layout 48

10.4 Test Result and Data..... 48

11. Power Spectral Density 49

11.1 Test Limit 49

11.2 Test Procedures 49

11.3 Test Setup Layout 49

11.4 Test Result and Data..... 50



History of this test report

Original

Additional attachment as following record:

Report No.	Issue Date	Description
DEFQ2106052	Jul. 19, 2021	Original



1. Summary of Test Procedure and Test Results

1.1 Applicable Standards

ANSI C63.10:2013

FCC Rules and Regulations Part 15 Subpart C §15.247

FCC Rule	Description of Test	Result
15.203	Antenna Requirement	PASS
15.207	AC Power Line Conducted Emission	PASS
15.209 15.205	Radiated Spurious Emission	PASS
15.247(d)	Conducted Spurious Emission	PASS
15.247(a)(2)	6dB Bandwidth	PASS
15.247(b)	Maximum Peak Output Power	PASS
15.247(e)	Power Spectral Density	PASS
Note: Deviations Yes <input type="checkbox"/> No <input checked="" type="checkbox"/>		
*The lab has reduced the uncertainty risk factor from test equipment, environment and staff technicians which according to the standard on contract. Therefore, the test result will only be determined by standard requirement.		



2. Test Configuration of Equipment under Test

2.1 Feature of Equipment under Test

Equipment	Presenter
Model Name	BR2101
Model Discrepancy	N/A
Frequency Range	2402MHz-2480MHz
Channel Number	40
Modulation Type	GFSK
Data Rate	1Mbps&2Mbps
Supply Voltage.	5V +/-0.5V USB Power 250mA MAX
Li-ion battery with charge	250mAh/ 0.925W
BT Operation current.	150mA MAX. DC3.7V
Laser Operation current.	30mA MAX. DC3.7V
BT Standby current.	Less than 200uA. DC3.7V (connect)
Deep sleep current	Less than 20uA
BT Version	BLE 5.1
BT Distance of control	7 m any director

Note:

1. For a more detailed features description, please refer to the manufacturer's specifications or the User's Manual.



2.2 Carrier Frequency of Channels

Channel	Frequency (MHz)	Channel	Frequency (MHz)	Channel	Frequency (MHz)
*00	2402	14	2430	28	2458
01	2404	15	2432	29	2460
02	2406	16	2434	30	2462
03	2408	17	2436	31	2464
04	2410	18	2438	32	2466
05	2412	*19	2440	33	2468
06	2414	20	2442	34	2470
07	2416	21	2444	35	2472
08	2418	22	2446	36	2474
09	2420	23	2448	37	2476
10	2422	24	2450	38	2478
11	2424	25	2452	*39	2480
12	2426	26	2454	--	--
13	2428	27	2456	--	--

Note: Channels remarked * are selected to perform test.

2.3 Test Mode and Test Software

- During testing, the interface cables and equipment positions were varied according to ANSI C63.10.
- The complete test system included Notebook and EUT for RF test.
- An executive program, "nRF Connect. exe" under WIN 7 System was executed to transmit and receive data via Bluetooth.
- The following test modes were performed for the test:

Conducted Emissions from the AC mains power ports	
Test Mode	Operating Description
Mode 1	GFSK (1Mbps) for 120V
Mode 2	GFSK (2Mbps) for 120V
Mode 3	GFSK (1Mbps) for 240V
caused "Test Mode 1 at CH00:2402" generated the worst case, it was reported as the final data.	
Radiation Emissions (30MHz ~ 1GHz)	
Test Mode	Operating Description
Mode 1	GFSK (1Mbps)
Mode 2	GFSK (2Mbps)
caused "Test Mode 1 at CH00:2402" generated the worst case, it was reported as the final data.	
Radiation Emissions (1GHz ~ 25GHz)	
Test Mode	Operating Description
Mode 1	GFSK (1Mbps)
Mode 2	GFSK (2Mbps)
caused "Test Mode 1, 2" generated the worst case, they were reported as the final data.	



2.4 Description of Test System

Product	Manufacturer	Model No.	Serial No.	Power Cord
1 Notebook	Sony	PCG-71811P	N/A	Non-Shielded, 1.8m

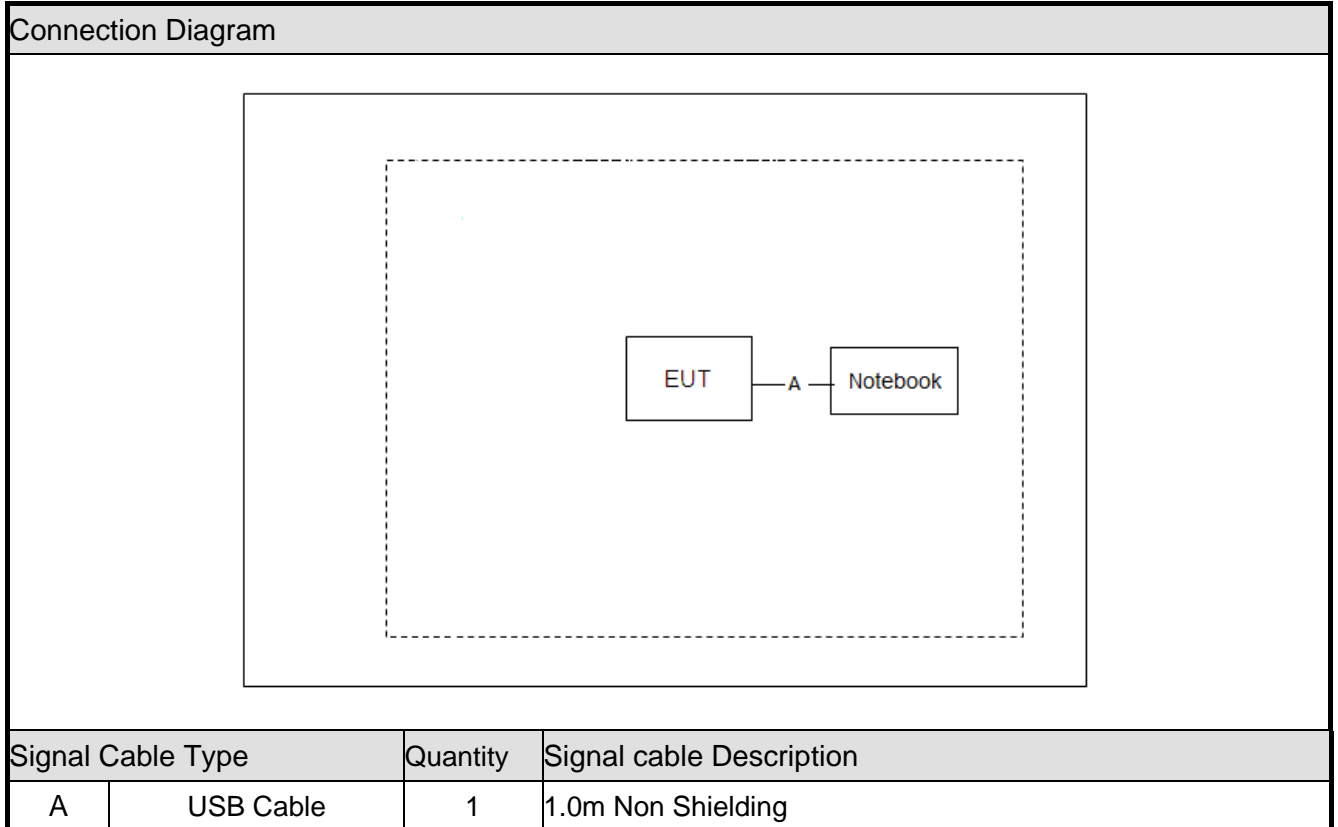



2.5 General Information of Test

Test Site	CerpPASS Technology Corporation(CerpPASS Laboratory) Address: Room 102, No. 5, Xing'an Road, Chang'an Town, Dongguan City, Guangdong Province Tel: +86-769-8547-1212 Fax: +86-769-8547-1912
FCC Designation No.:	CN1288
Frequency Range Investigated:	Conducted: from 150kHz to 30 MHz Radiation: from 30 MHz to 25,000MHz
Test Distance:	The test distance of radiated emission from antenna to EUT is 3 M.

Test Item	Test Site	Test period	Environmental Conditions	Tested By
RF Conducted	RFCON01-DG	2021/6/23~2021/07/15	22~25°C / 50~60%	Amos Zhang
Radiated Emissions	3M02-DG	2021/6/23~2021/07/15	22~25°C / 50~60%	Amos Zhang
AC Power Line Conducted Emission	CON01-DG	2021/6/23~2021/07/15	22~25°C / 50~60%	Amos Zhang

2.6 Measurement Uncertainty

ISO/IEC 17025 requires that an estimate of the measurement uncertainties associated with the emissions test results be included in the report. The measurement uncertainties given below are based on a 95% confidence level (based on a coverage factor (k=2)).

Measurement Item	Uncertainty
AC Power Line Conduction(150K~30MHz)	±2.88dB
Radiated Spurious Emission(9KHz~30MHz)	±2.15dB
Radiated Spurious Emission(30MHz~1GHz)	±4.95dB
Radiated Spurious Emission(1GHz~18GHz)	±3.24dB
Radiated Spurious Emission(18GHz~40GHz)	±5.43dB
6dB Bandwidth&26dB Bandwidth	±4.422%
Occupied Bandwidth	±4.244%
Peak Output Power(Conducted Power Meter)	±1.4 dB
Power Spectral Density	±1.387 dB
Frequency Stability	±0.6338Hz



3. Test Equipment and Ancillaries Used for Tests

Test Item	AC Power Line Conducted Emission				
Instrument/Ancillary	Manufacturer	Model No.	Serial No.	Calibration Date	Valid Date.
Test Receiver	R&S	ESCI	100564	2021.01.07	2022.01.06
LISN	SCHWARZBECK	NSLK 8127	8127748	2021.01.07	2022.01.06
LISN	SCHWARZBECK	NSLK 8127	8127749	2021.01.07	2022.01.06
ISN	TESEQ	ISN T800	42809	2021.05.10	2022.05.09
Pulse Limiter with 10dB Attenuation	SCHWARZBECK	VTSD 9561-F	9561-F106	2021.01.07	2022.01.06
Temperature/ Humidity Meter	GEMLEAD	STH200A	N/A	2020.08.20	2021.08.19

Test Item	Radiated Emissions				
Instrument	Manufacturer	Model No.	Serial No.	Calibration Date	Valid Date
EMI Test Receiver	R&S	ESCI	100563	2021.05.14	2022.05.13
H64 Preamplifier	HP	8447F	3113A05582	2021.01.07	2022.01.06
Loop Antenna	R&S	HFH2-Z2	100150	2020.06.08	2022.06.07
Bilog Antenna	Sunol Science	JB1	A072414-1	2020.06.08	2022.06.07
Preamplifier	EMEC	EM01G18G	060739	2021.05.14	2022.05.13
Preamplifier	COM-POWER	PA-840	711885	2021.05.14	2022.05.13
Horn Antenna	Sunol	DRH-118	A072913	2019.09.07	2021.09.06
Standard Gain Horn Antenna	TRC	HA-2640	18050	2020.06.08	2022.06.07
Standard Gain Horn Antenna	TRC	HA-1726	18051	2020.06.08	2022.06.07
FSQ Signal Analyzer	R&S	FSQ40	200012	2021.05.14	2022.05.13
Temperature/ Humidity Meter	GEMLEAD	STH200A	N/A	2020.08.20	2021.08.19



Test Item	RF Conducted				
Instrument	Manufacturer	Model No.	Serial No.	Calibration Date	Valid Date
MXA Signal Analyzer	KEYSIGHT	N9020A	US46220290	2021.05.14	2022.05.13
ESG VECTOR SIGNAL GENERATOR	Agilent	E4438C	MY45092582	2021.05.14	2022.05.13
MXG VECTOR SIGNAL GENERATOR	Agilent	N5182B	MY53050127	2021.05.14	2022.05.13
USB Wideband Power Sensor	Boonton	55006	9778	2021.01.07	2022.01.06
Temperature/ Humidity Meter	mingle	ETH529	N/A	2021.01.07	2022.01.06



4. Antenna Requirements

4.1 Standard Applicable

For intentional device, according to FCC 47 CFR Section 15.203, an intentional radiator shall be designed to ensure that no antenna other than that furnished by the responsible party shall be used with the device.

And according to FCC 47 CFR Section 15.247 (b), if transmitting antennas of directional gain greater than 6dBi are used, the power shall be reduced by the amount in dB that the directional gain of the antenna exceeds 6dBi.

4.2 Antenna Construction and Directional Gain

Antenna Type	Antenna Gain
PIFA Antenna	3.11dBi



5. Test of Conducted Emission

5.1 Test Limit

Conducted Emissions were measured from 150 kHz to 30 MHz with a bandwidth of 9 KHz on the 120 VAC power and return leads of the EUT according to the methods defined in ANSI C63.10-2013. The EUT was placed on a nonmetallic stand in a shielded room 0.8 meters above the ground plane as shown in section 6.2.2. The interface cables and equipment positioning were varied within limits of reasonable applications to determine the position produced maximum conducted emissions

Frequency (MHz)	Quasi Peak (dB μ V)	Average (dB μ V)
0.15 – 0.5	66-56*	56-46*
0.5 – 5.0	56	46
5.0 – 30.0	60	50

*Decreases with the logarithm of the frequency.

5.2 Test Procedures

- a. The EUT was placed 0.4 meter from the conducting wall of the shielding room was kept at least 80 centimeters from any other grounded conducting surface.
- b. Connect EUT to the power mains through a line impedance stabilization network (LISN).
- c. All the support units are connecting to the other LISN.
- d. The LISN provides 50 ohm coupling impedance for the measuring instrument.
- e. The FCC states that a 50 ohm, 50 micro-Henry LISN should be used.
- f. Both sides of AC line were checked for maximum conducted interference.
- g. The frequency range from 150 kHz to 30 MHz was searched.
- h. Set the test-receiver system to Peak Detect Function and Specified Bandwidth with Maximum Hold Mode.



5.3 Typical Test Setup

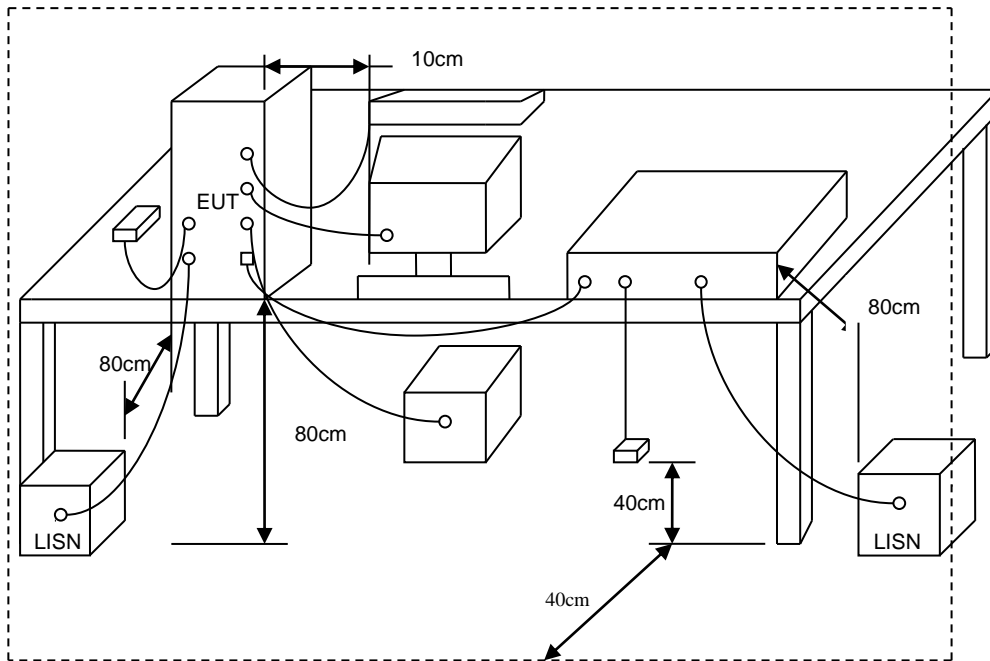



5.4 Test Result and Data

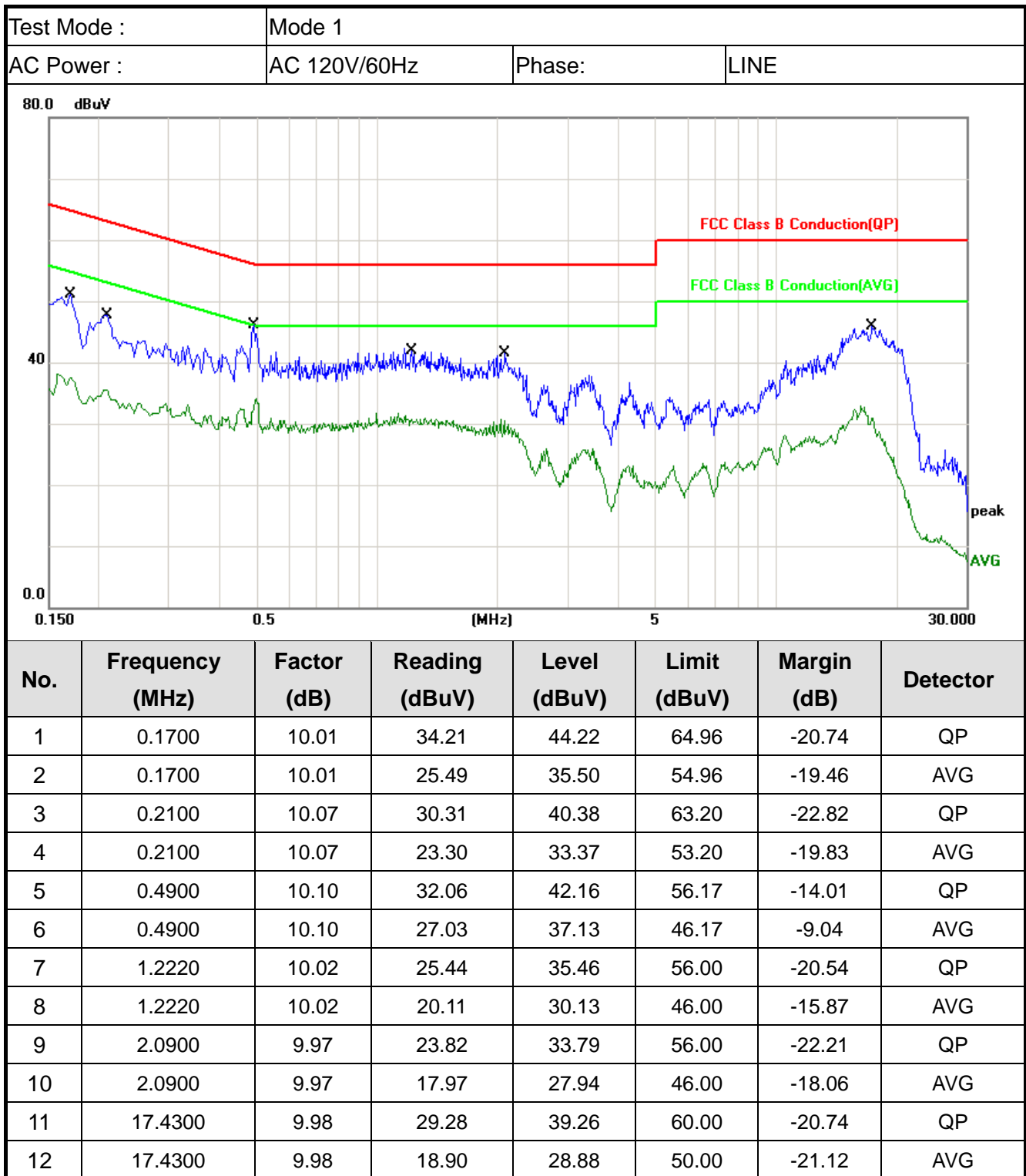

Note: Measurement Level = Reading Level + Correct Factor



Test Mode :	Mode 1		
AC Power :	AC 120V/60Hz	Phase:	NEUTRAL

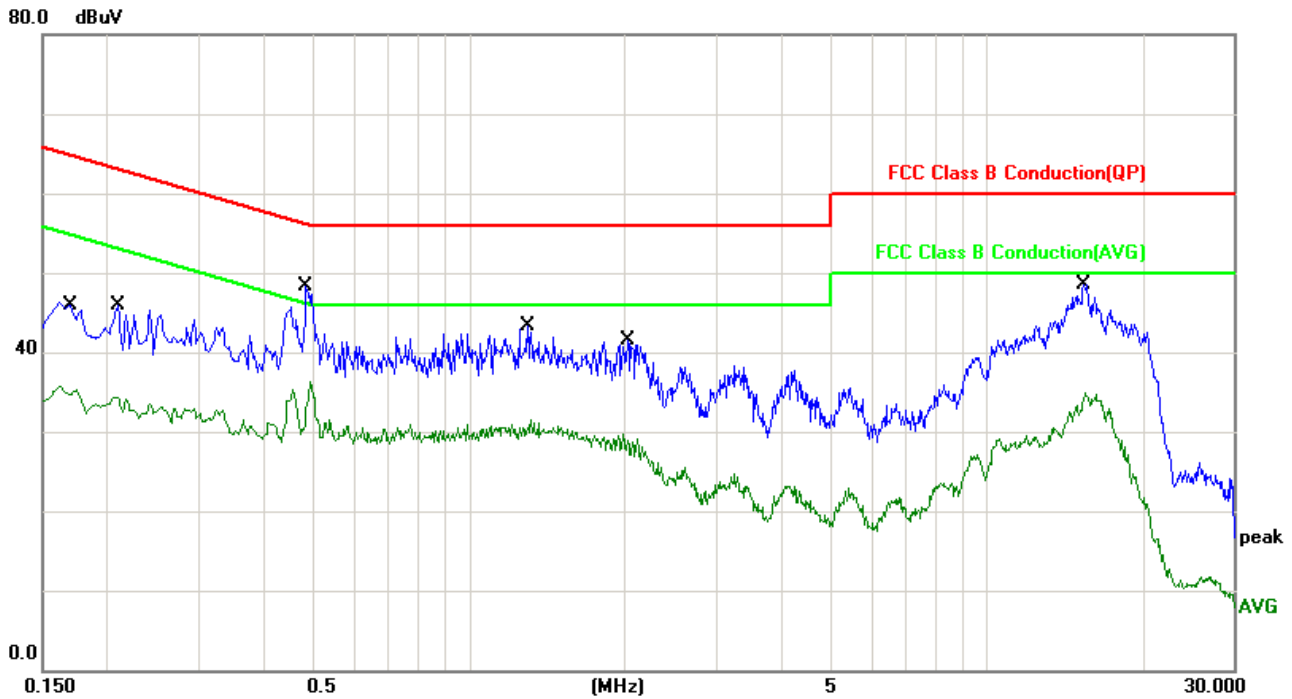

No.	Frequency (MHz)	Factor (dB)	Reading (dBuV)	Level (dBuV)	Limit (dBuV)	Margin (dB)	Detector
1	0.1700	10.15	29.70	39.85	64.96	-25.11	QP
2	0.1700	10.15	23.87	34.02	54.96	-20.94	AVG
3	0.2100	10.10	28.28	38.38	63.20	-24.82	QP
4	0.2100	10.10	22.68	32.78	53.20	-20.42	AVG
5	0.4860	10.14	35.30	45.44	56.24	-10.80	QP
6	0.4860	10.14	23.67	33.81	46.24	-12.43	AVG
7	1.2980	10.06	27.03	37.09	56.00	-18.91	QP
8	1.2980	10.06	20.08	30.14	46.00	-15.86	AVG
9	2.0300	10.08	24.49	34.57	56.00	-21.43	QP
10	2.0300	10.08	17.54	27.62	46.00	-18.38	AVG
11	15.4699	9.95	31.03	40.98	60.00	-19.02	QP
12	15.4699	9.95	22.74	32.69	50.00	-17.31	AVG

Note: Measurement Level = Reading Level + Correct Factor



6. Test of Spurious Emission (Radiated)

6.1 Test Limit

In any 100kHz bandwidth outside the frequency band in which the spread spectrum or digitally modulated intentional radiator is operating, the radio frequency power that is produced by the intentional radiator shall be at least 20dB below that in the 100kHz bandwidth within the band that contains the highest level of the desired power, based on either an RF conducted or a radiated measurement. If the transmitter measurement is based on the maximum conducted output power, the attenuation required under this paragraph shall be 30dB instead of 20dB. In addition, radiated emissions which fall in section 15.205(a) the restricted bands must also comply with the radiated emission limit specified in section 15.209(a).

Frequency (MHz)	Field Strength (microvolt/meter)	Measurement Distance (meters)
0.009 ~ 0.490	2400/F(kHz)	300
0.490 ~ 1.705	24000/F(kHz)	30
1.705 ~ 30.0	30	30
30 ~ 88	100	3
88 ~ 216	150	3
216 ~ 960	200	3
Above 960	500	3

6.2 Test Procedures

- The EUT was placed on a rotatable table top 0.8 meter above ground.
- The EUT was set 3 meters from the interference receiving antenna which was mounted on the top of a variable height antenna tower.
- The table was rotated 360 degrees to determine the position of the highest radiation.
- The antenna is a broadband antenna and its height is varied between one meter and four meters above ground to find the maximum value of the field strength both horizontal polarization and vertical polarization of the antenna are set to make the measurement.
- For each suspected emission the EUT was arranged to its worst case and then tune the antenna tower (from 1 M to 4 M) and turn table (from 0 degree to 360 degrees) to find the maximum reading.
- Set the test-receiver system to Peak or CISPR quasi-peak Detect Function and specified bandwidth with Maximum Hold Mode.
- If the emission level of the EUT in peak mode was 3 dB lower than the limit specified, then testing will be stopped and peak values of EUT will be reported, otherwise, the emissions which do not have 3 dB margin will be repeated one by one using the quasi-peak method and reported.
- For testing above 1GHz, the emission level of the EUT in peak mode was 20dB lower than average limit (that means the emission level in peak mode also complies with the limit in average mode), then testing will be stopped and peak values of EUT will be reported, otherwise, the emissions will be measured in average mode again and reported.
- "Cone of radiation" has been considered to be 3dB bandwidth of the measurement antenna.

Note: The supporting fixture shall permit orientation of the EUT in each of three orthogonal axis positions such that emissions from the EUT are maximized.
(X AXIS is the worst.)



6.3 Typical Test Setup

Below 30MHz test setup

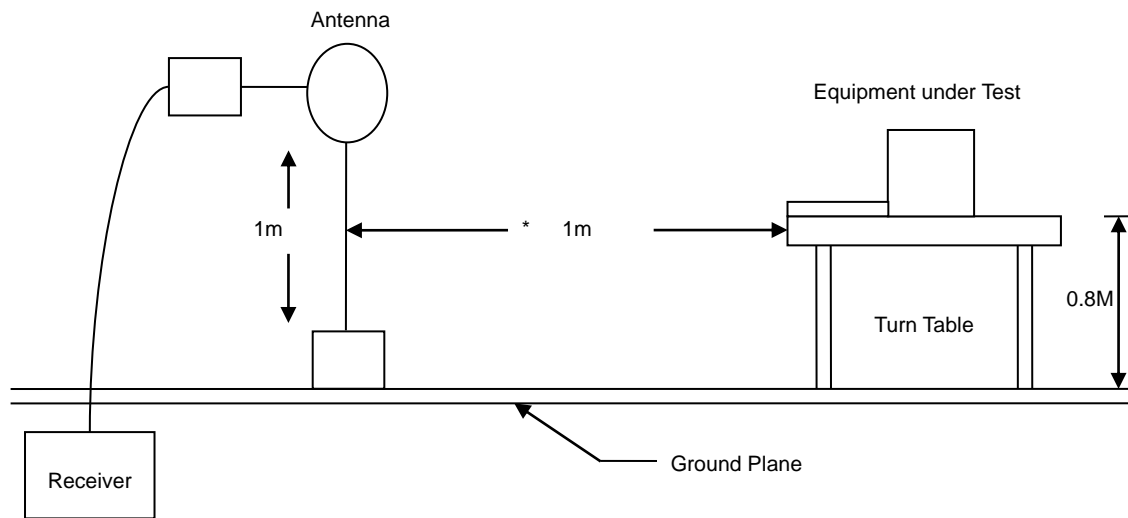

30MHz- 1GHz Test Setup

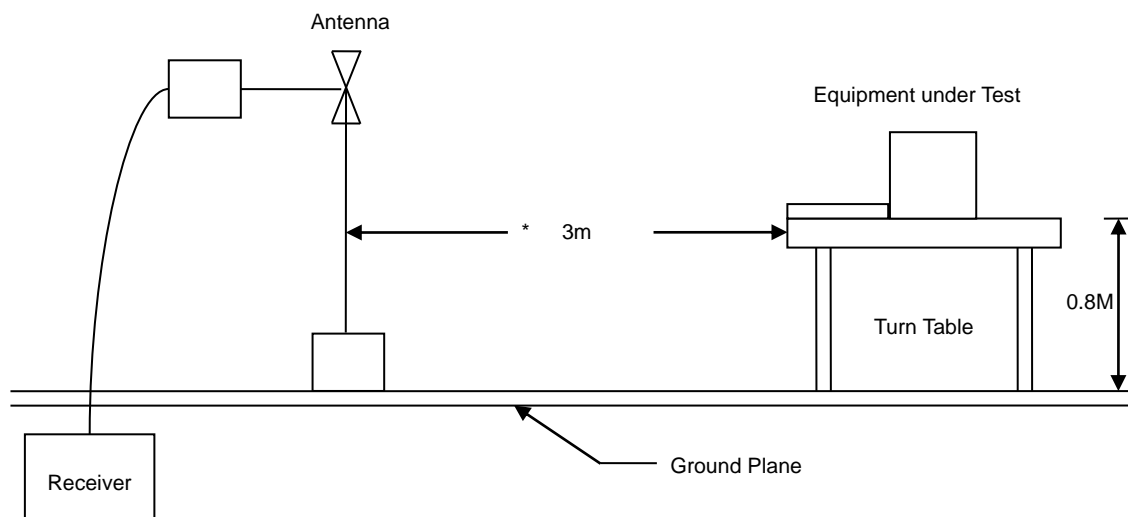

Above 1GHz Test Setup

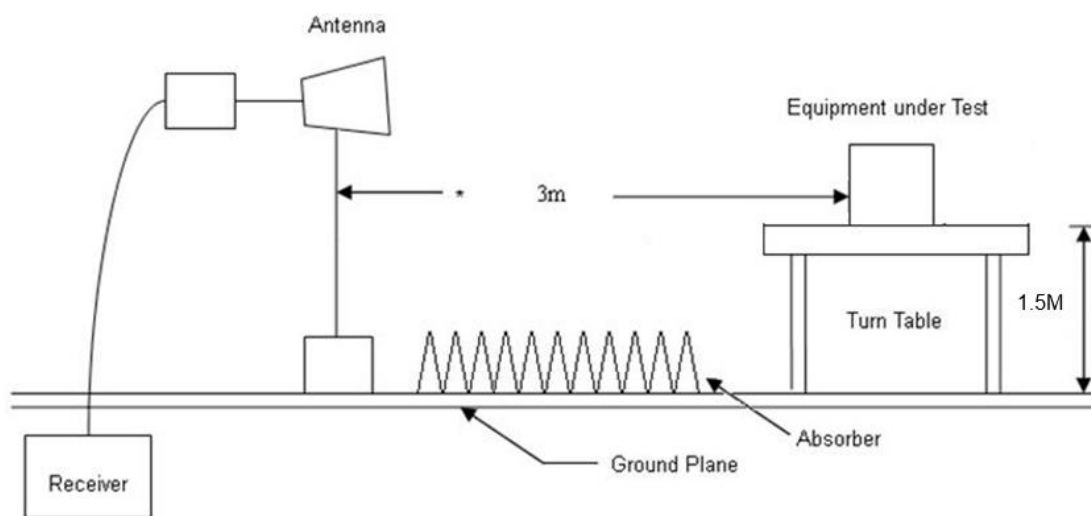



6.4 Test Result and Data (9kHz ~ 30MHz)

The 9kHz - 30MHz spurious emission is under limit 20dB more.

6.5 Test Result and Data (30MHz ~ 1GHz)

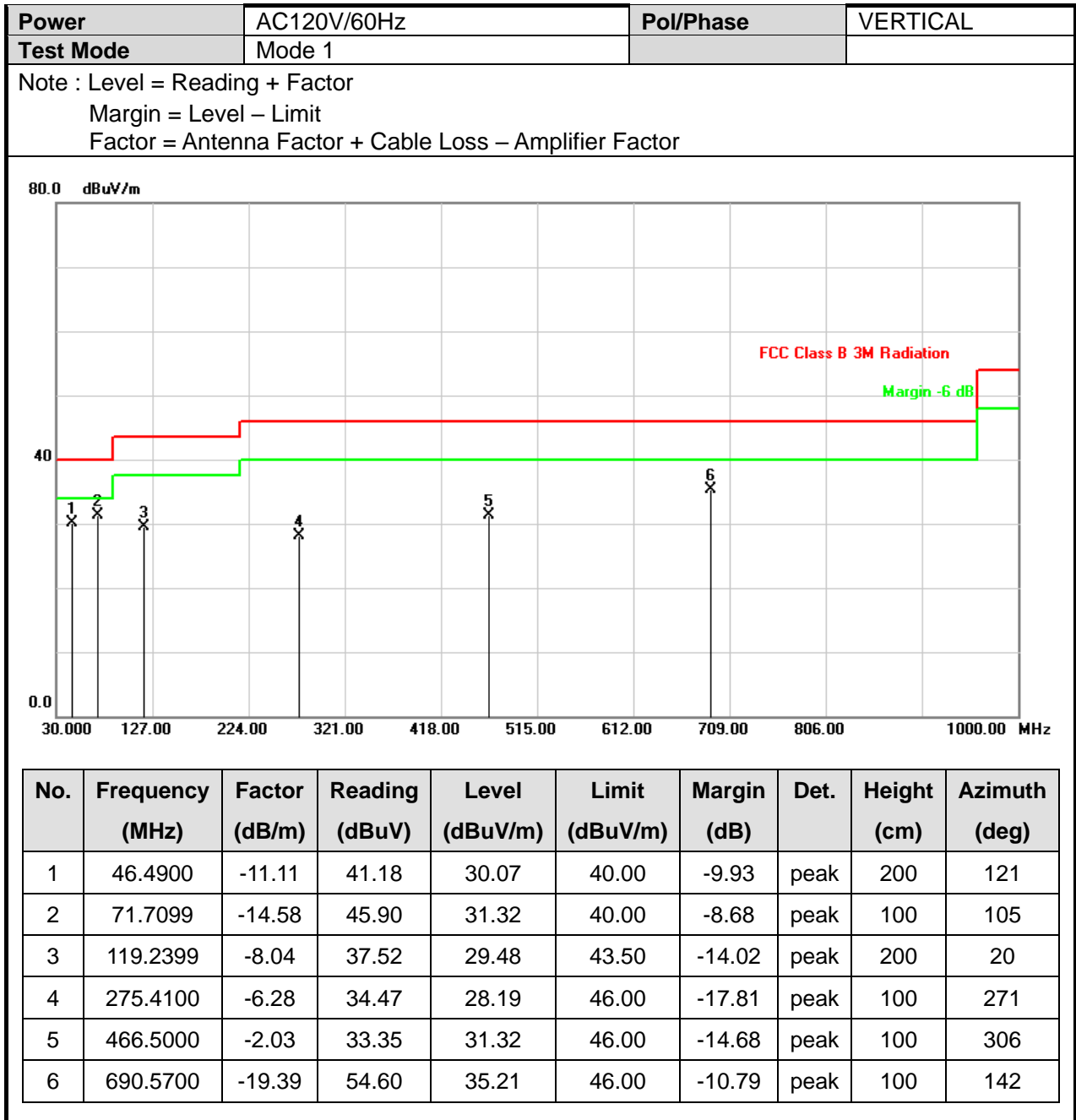

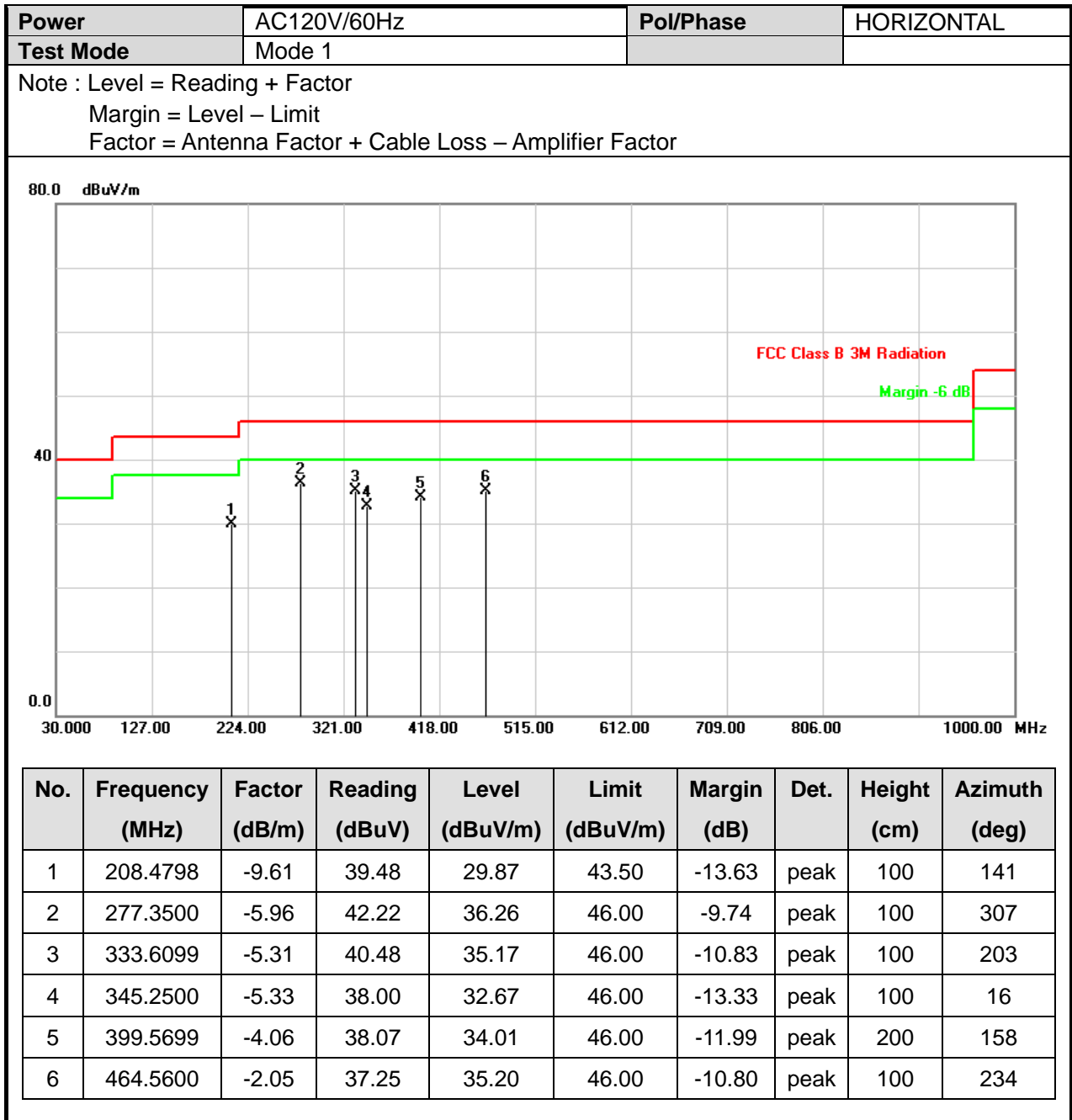



6.6 Test Result and Data (1GHz ~ 25GHz)

Power	AC120V/60Hz	Pol/Phase	VERTICAL
Test Mode	Mode 1, CH 00	Operation mode	TX

Note : Level = Reading + Factor
 Margin = Level – Limit
 Factor = Antenna Factor + Cable Loss – Amplifier Factor
 The 18000MHz - 25000MHz spurious emission is under limit 20dB more.

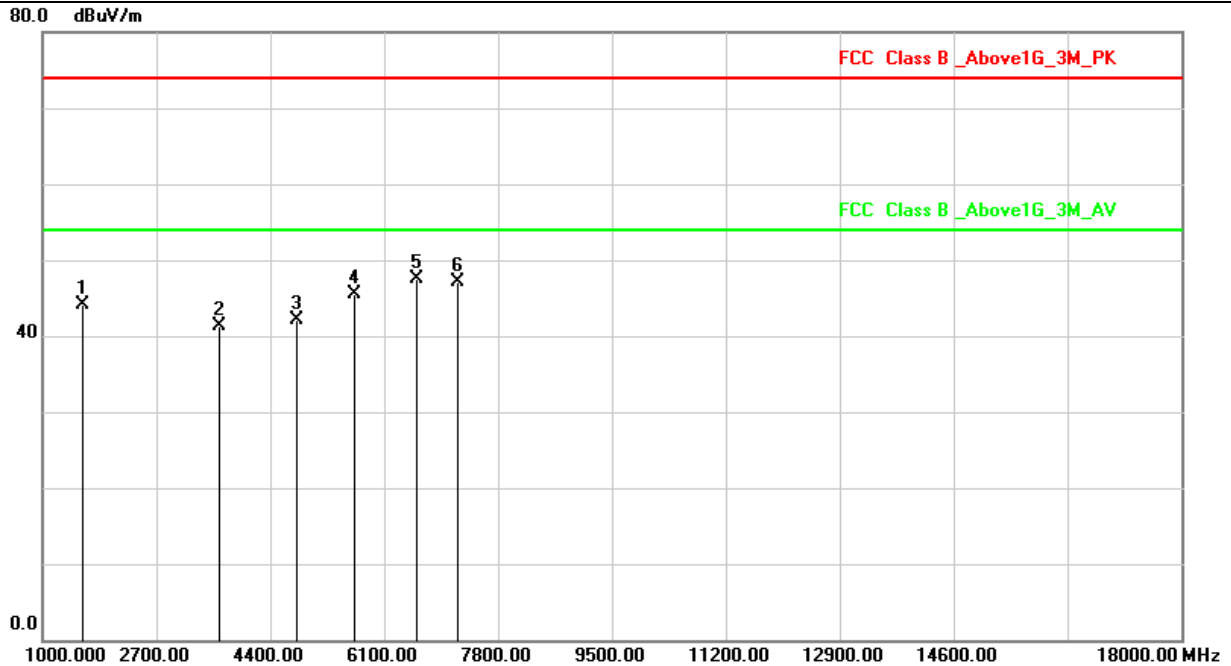

No.	Frequency (MHz)	Factor (dB/m)	Reading (dBuV)	Level (dBuV/m)	Limit (dBuV/m)	Margin (dB)	Det.
1	1595.000	-10.34	54.51	44.17	74.00	-29.83	peak
2	3635.000	-4.36	45.59	41.23	74.00	-32.77	peak
3	4804.162	-1.79	43.99	42.20	74.00	-31.80	peak
4	5658.000	0.29	45.20	45.49	74.00	-28.51	peak
5	6593.000	3.60	44.00	47.60	74.00	-26.40	peak
6	7206.344	3.47	43.63	47.10	74.00	-26.90	peak

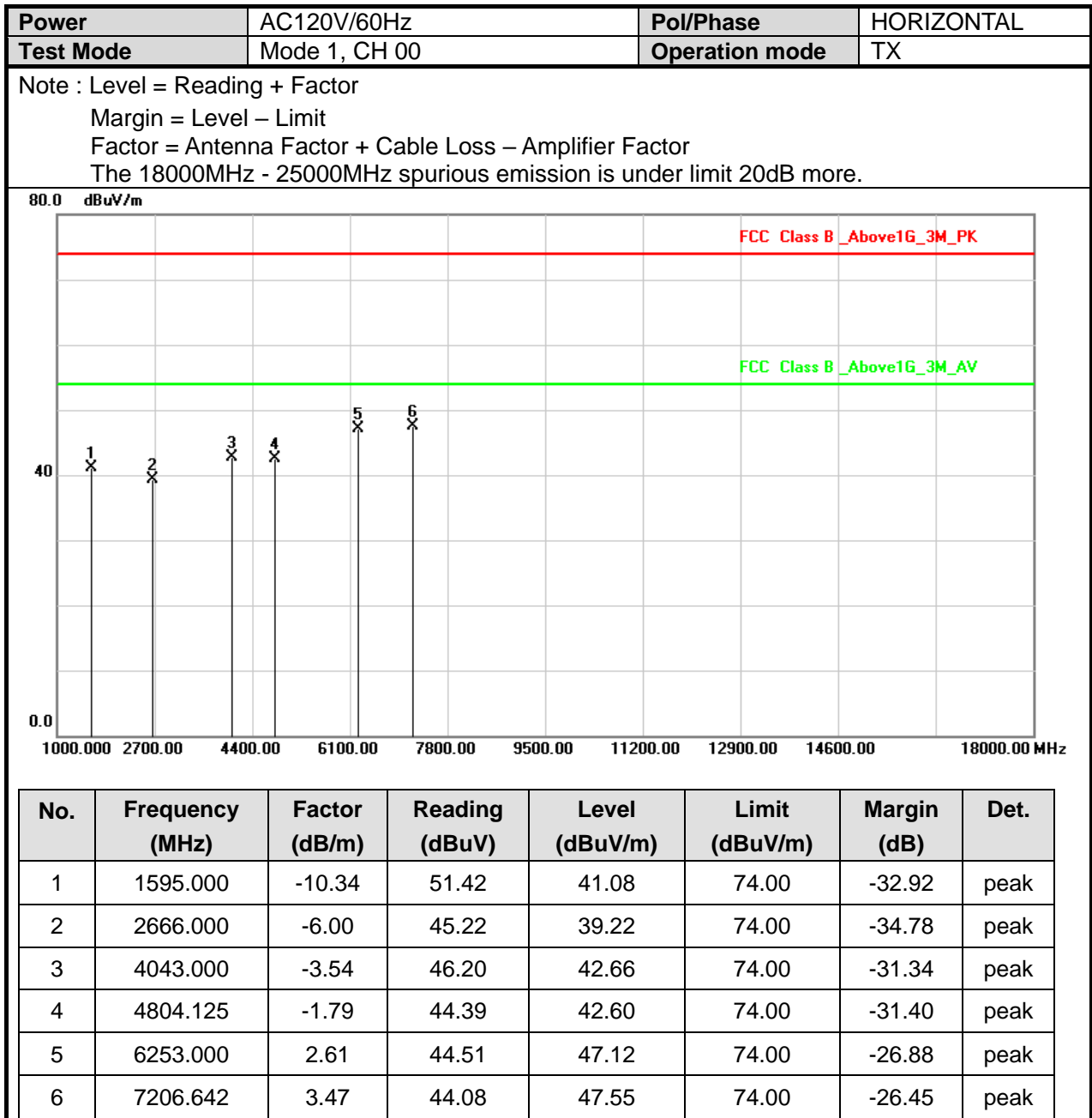

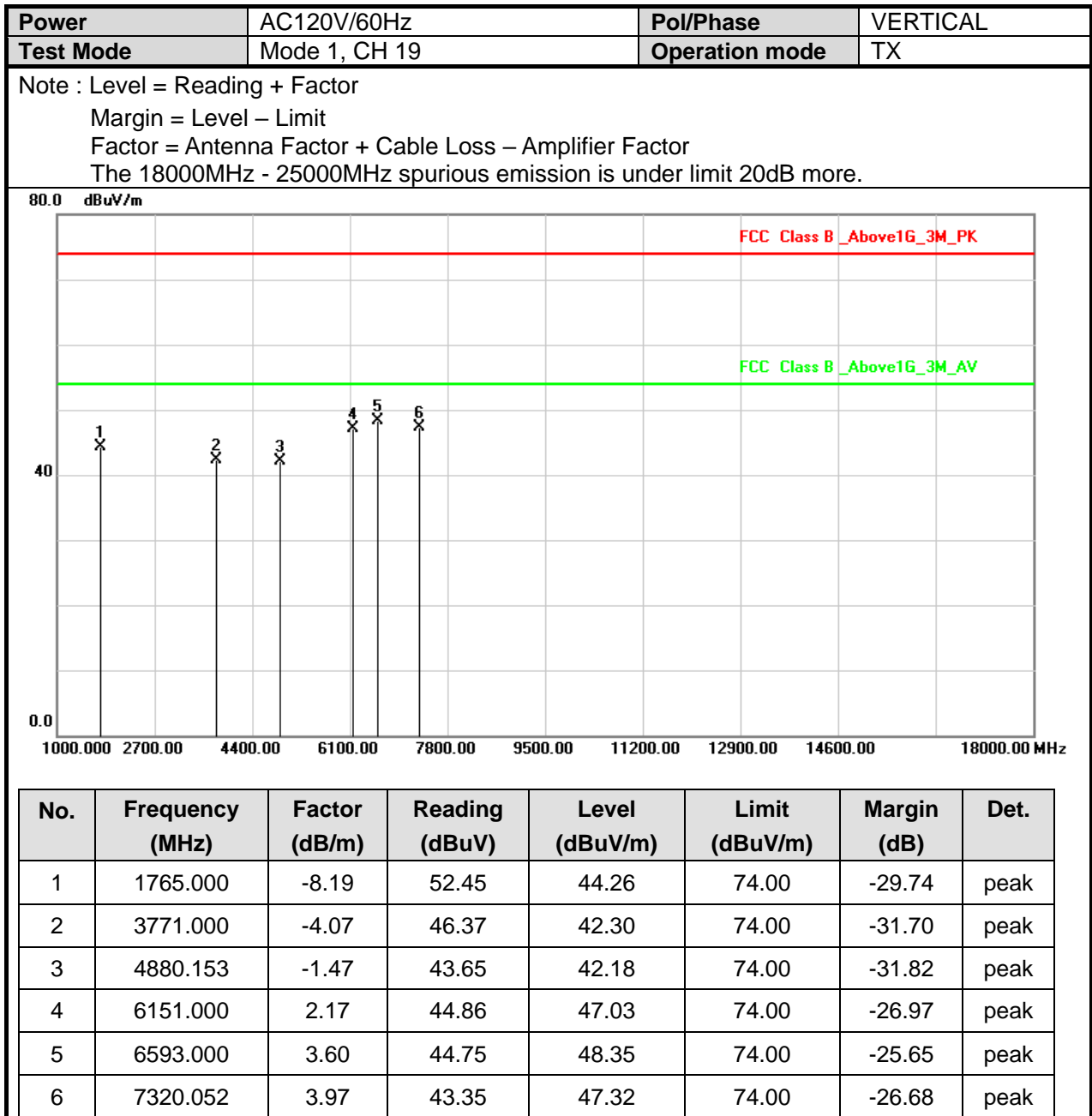



Power	AC120V/60Hz	Pol/Phase	HORIZONTAL
Test Mode	Mode 1, CH 19	Operation mode	TX

Note : Level = Reading + Factor
Margin = Level – Limit
Factor = Antenna Factor + Cable Loss – Amplifier Factor
The 18000MHz - 25000MHz spurious emission is under limit 20dB more.

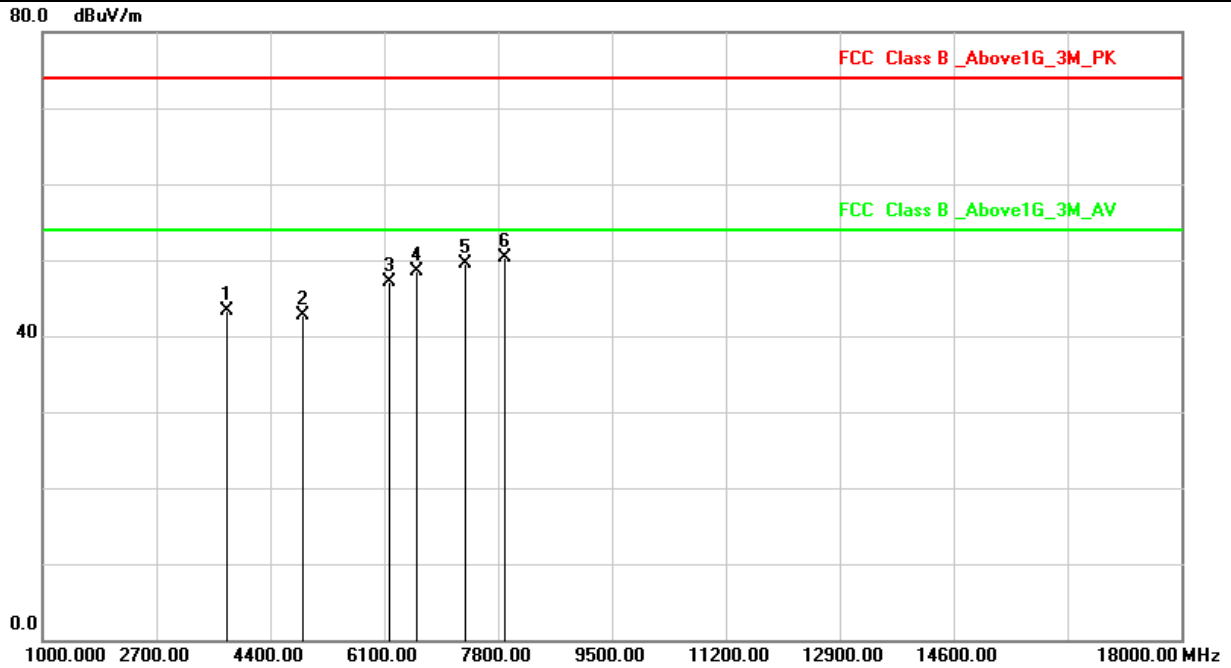

No.	Frequency (MHz)	Factor (dB/m)	Reading (dBuV)	Level (dBuV/m)	Limit (dBuV/m)	Margin (dB)	Det.
1	3754.000	-4.11	47.36	43.25	74.00	-30.75	peak
2	4880.065	-1.47	44.17	42.70	74.00	-31.30	peak
3	6185.000	2.35	44.67	47.02	74.00	-26.98	peak
4	6593.000	3.60	44.95	48.55	74.00	-25.45	peak
5	7320.245	3.97	45.55	49.52	74.00	-24.48	peak
6	7902.000	5.39	44.91	50.30	74.00	-23.70	peak



Power	AC120V/60Hz	Pol/Phase	VERTICAL
Test Mode	Mode 1, CH 39	Operation mode	TX

Note : Level = Reading + Factor
 Margin = Level – Limit
 Factor = Antenna Factor + Cable Loss – Amplifier Factor
 The 18000MHz - 25000MHz spurious emission is under limit 20dB more.

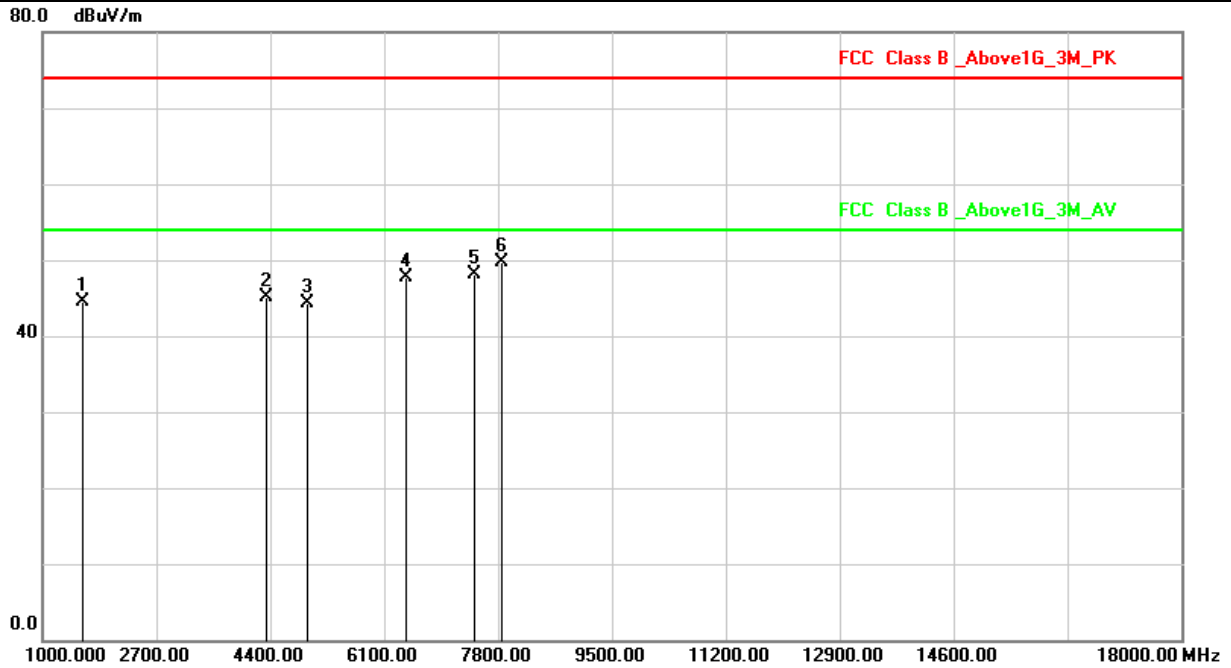

No.	Frequency (MHz)	Factor (dB/m)	Reading (dBuV)	Level (dBuV/m)	Limit (dBuV/m)	Margin (dB)	Det.
1	1595.000	-10.34	54.84	44.50	74.00	-29.50	peak
2	4349.000	-2.49	47.58	45.09	74.00	-28.91	peak
3	4960.165	-1.13	45.43	44.30	74.00	-29.70	peak
4	6423.000	3.20	44.60	47.80	74.00	-26.20	peak
5	7440.452	4.46	43.57	48.03	74.00	-25.97	peak
6	7851.000	5.48	44.29	49.77	74.00	-24.23	peak

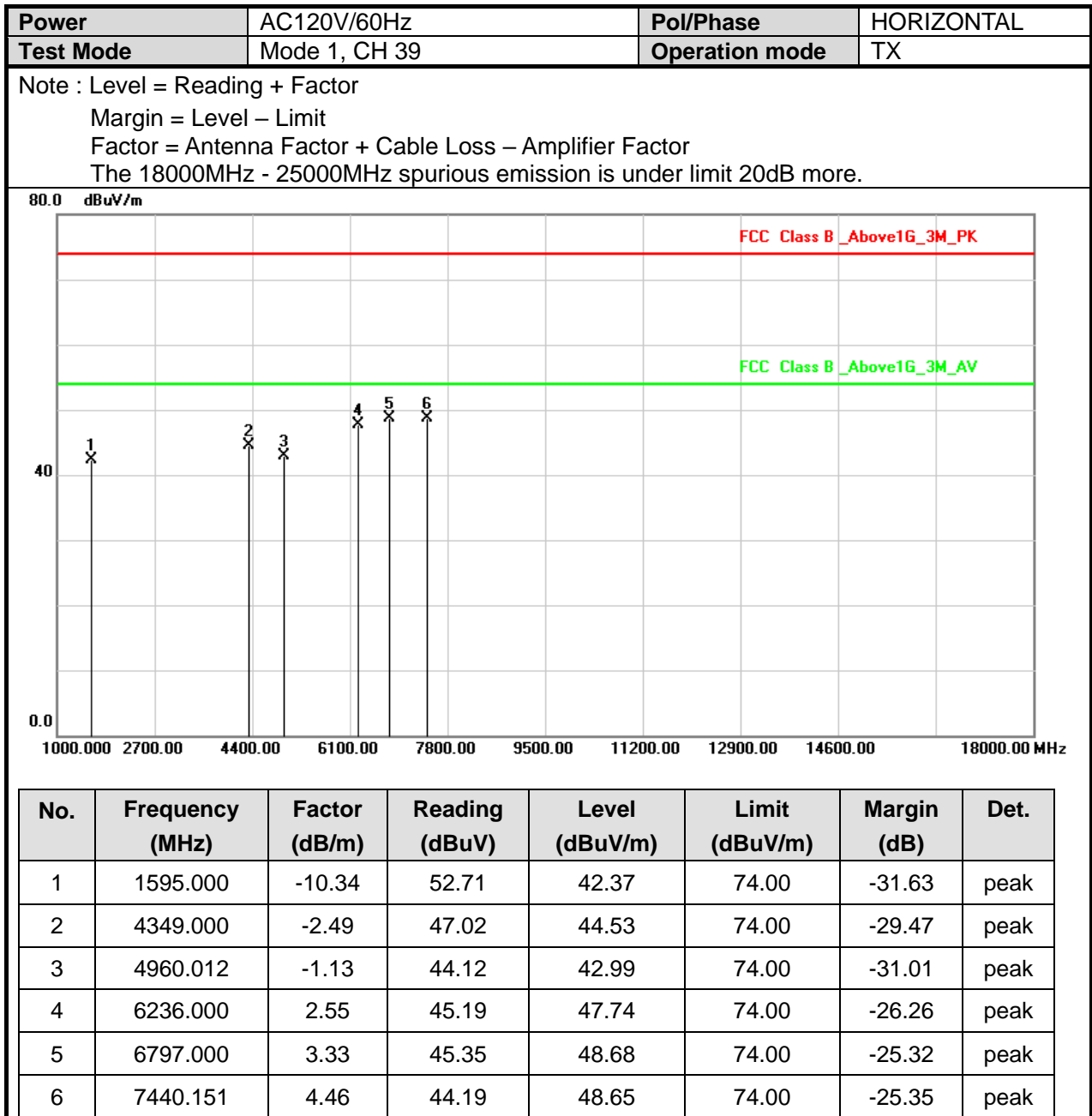

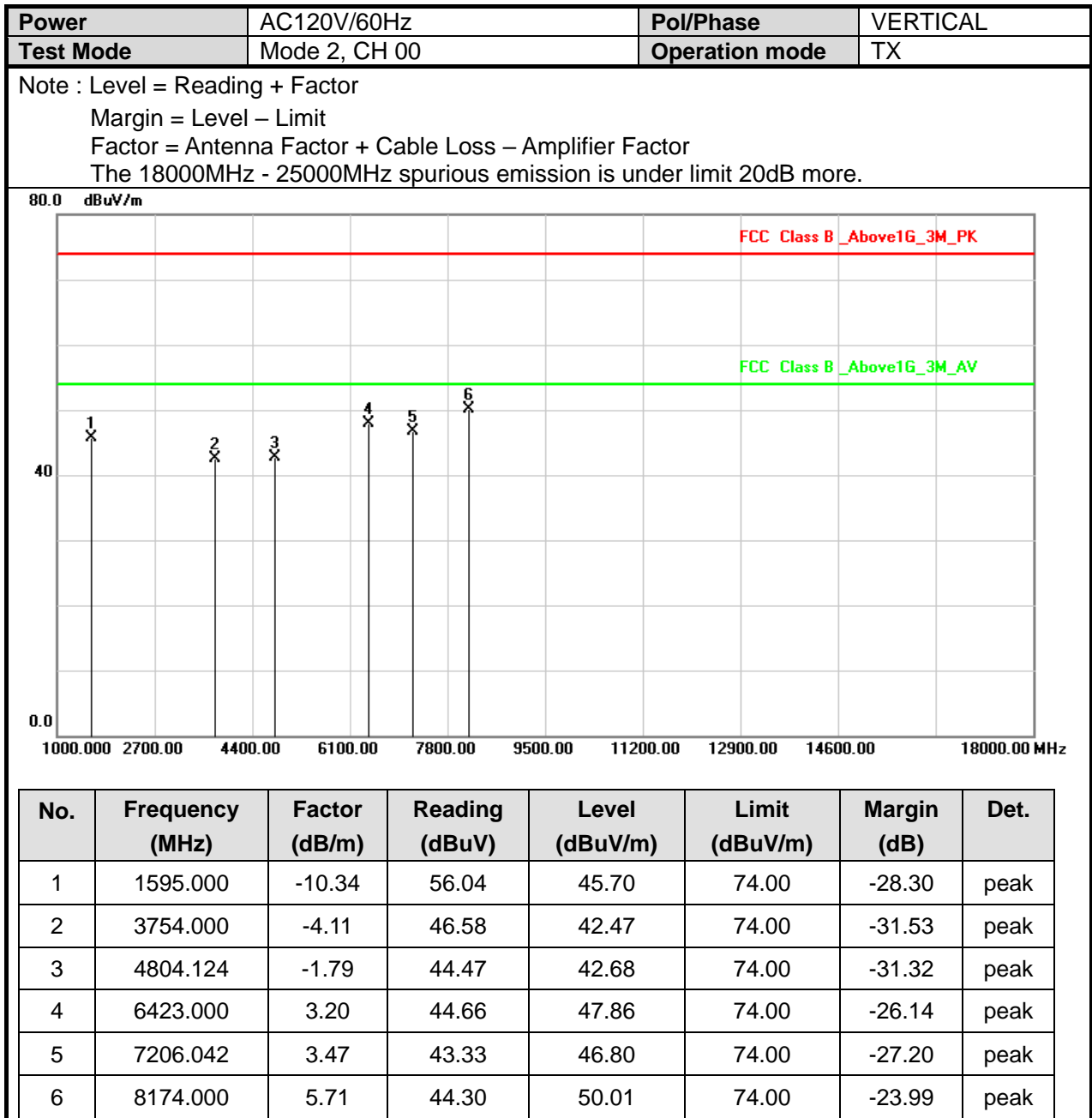

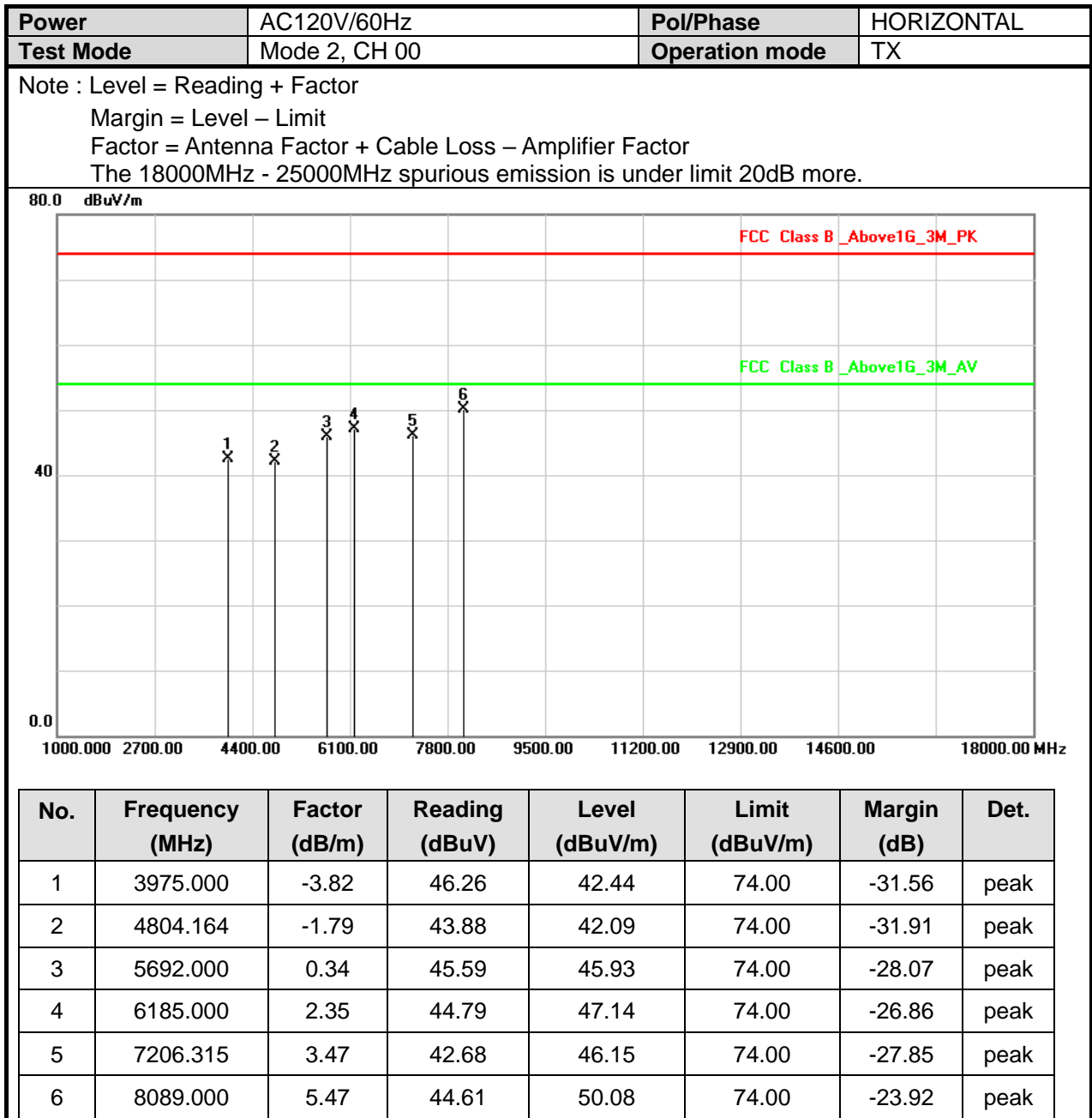

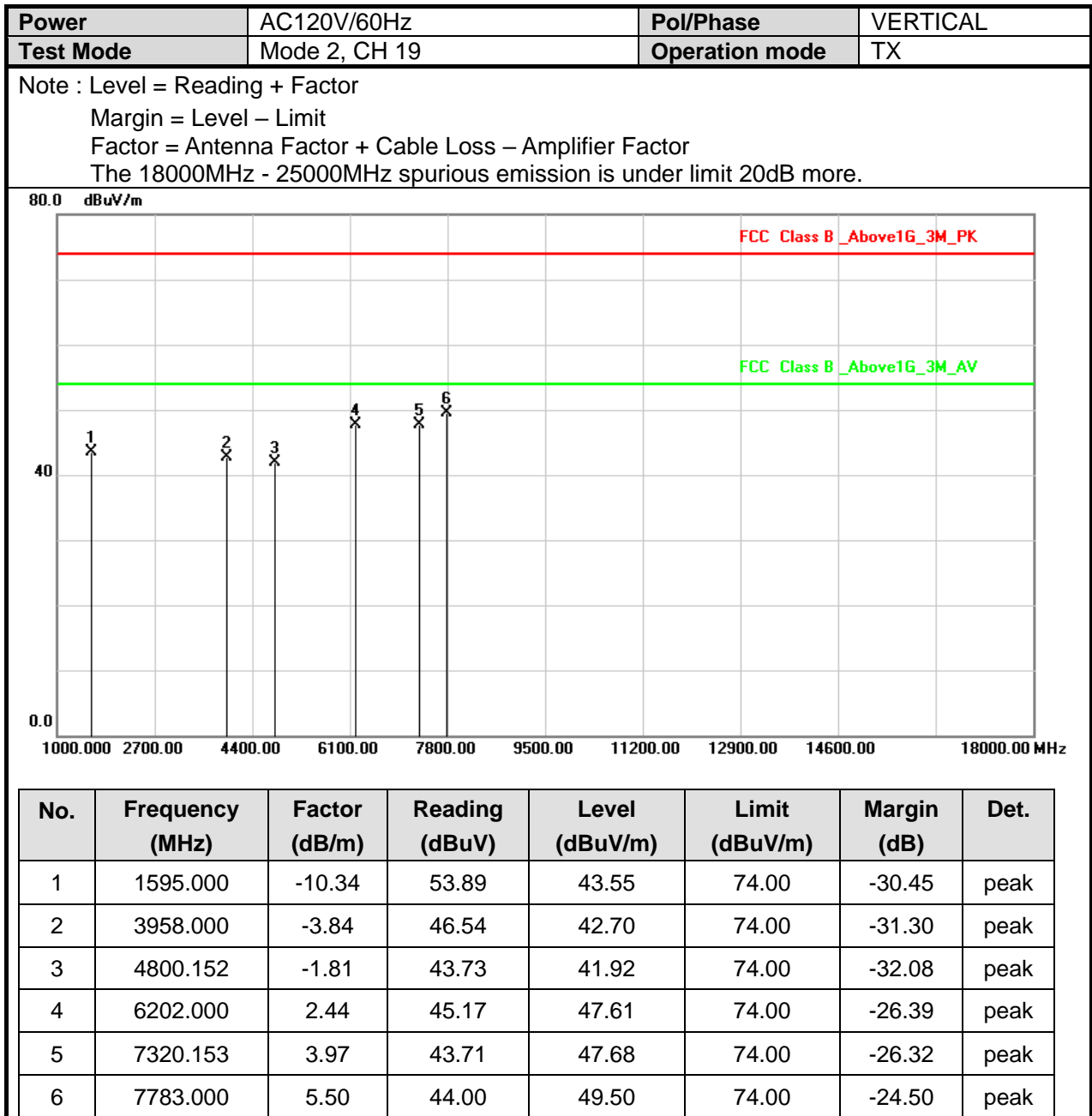

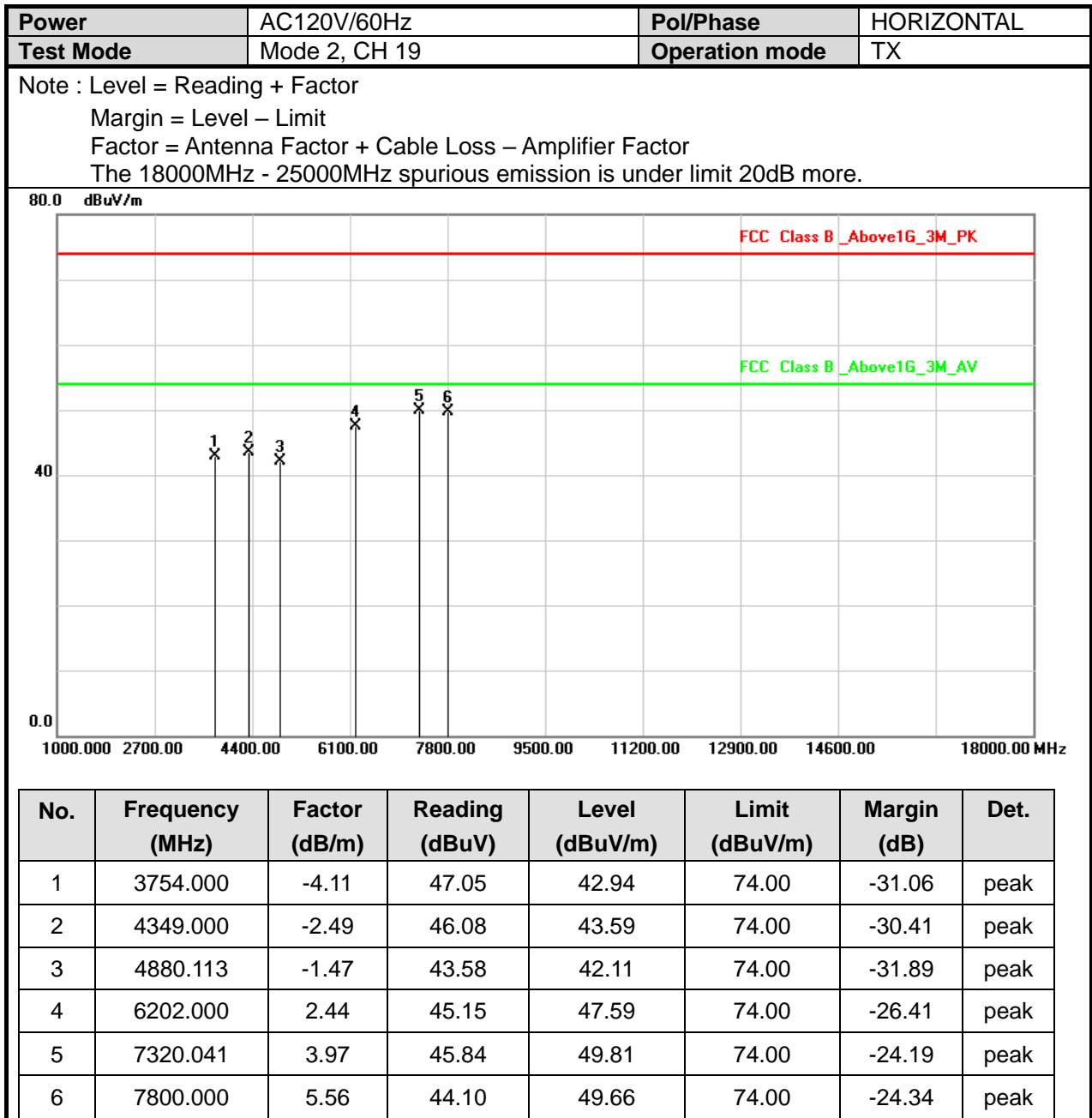

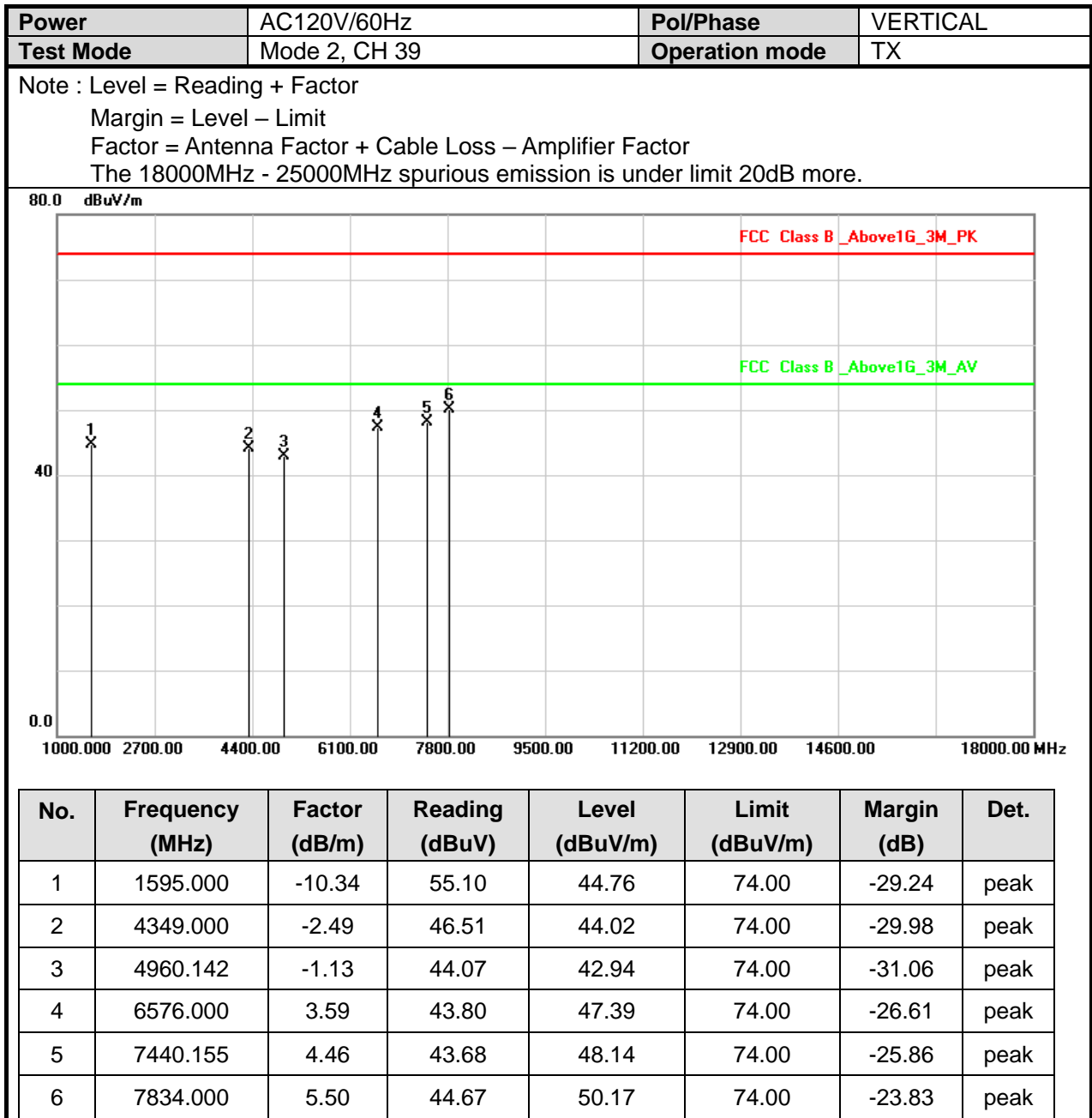

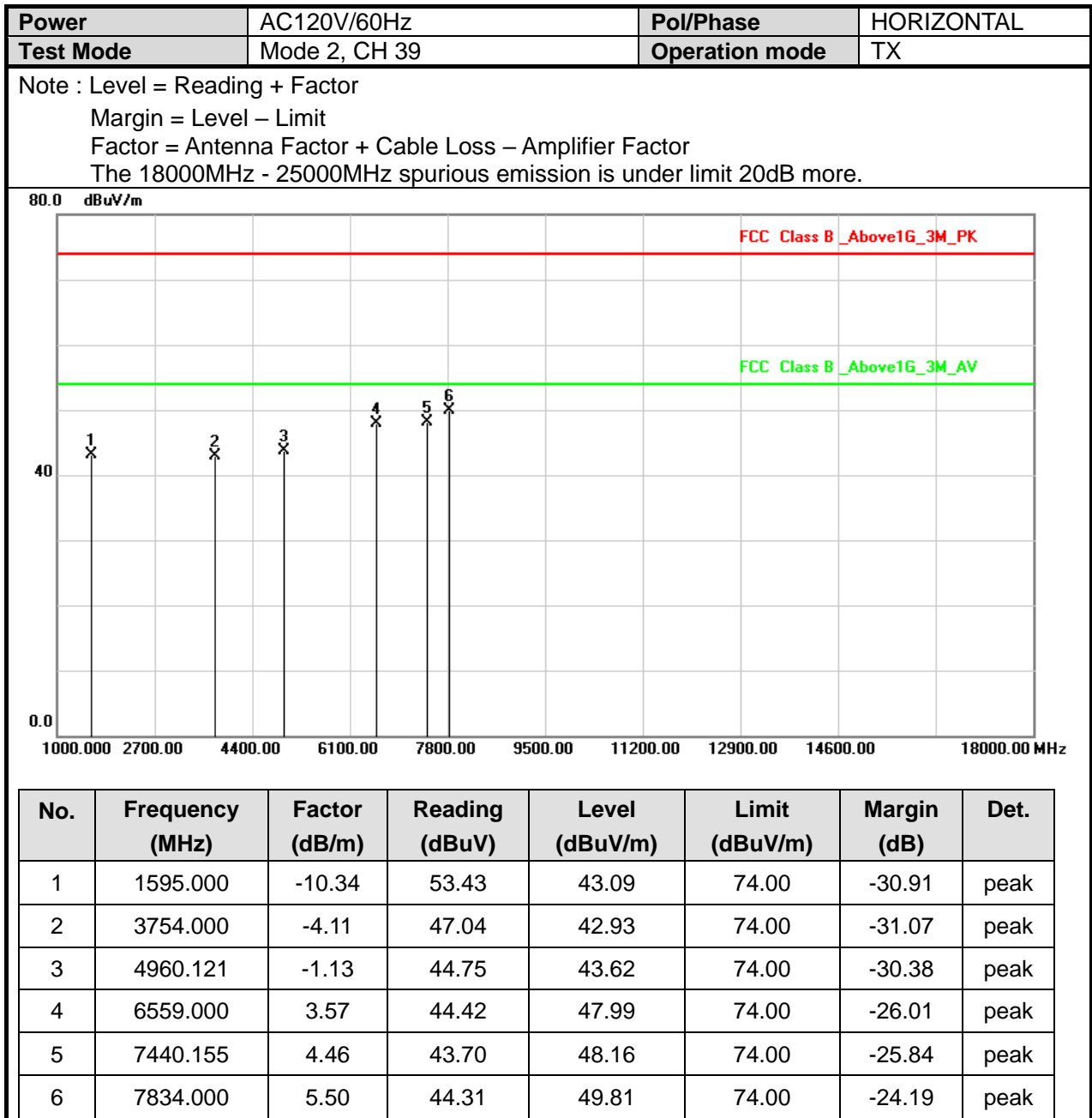



6.7 Restricted Bands of Operation

Only spurious emissions are permitted in any of the frequency bands listed below:

MHz	MHz	MHz	GHz
0.09000 – 0.11000	16.42000 – 16.42300	399.9 – 410.0	4.500 – 5.250
0.49500 – 0.505**	16.69475 – 16.69525	608.0 – 614.0	5.350 – 5.460
2.17350 – 2.19050	16.80425 – 16.80475	960.0 – 1240.0	7.250 – 7.750
4.12500 – 4.12800	25.50000 – 25.67000	1300.0 – 1427.0	8.025 – 8.500
4.17725 – 4.17775	37.50000 – 38.25000	1435.0 – 1626.5	9.000 – 9.200
4.20725 – 4.20775	73.00000 – 74.60000	1645.5 – 1646.5	9.300 – 9.500
6.21500 – 6.21800	74.80000 – 75.20000	1660.0 – 1710.0	10.600 – 12.700
6.26775 – 6.26825	108.00000 – 121.94000	1718.8 – 1722.2	13.250 – 13.400
6.31175 – 6.31225	123.00000 – 138.00000	2200.0 – 2300.0	14.470 – 14.500
8.29100 – 8.29400	149.90000 – 150.05000	2310.0 – 2390.0	15.350 – 16.200
8.36200 – 8.36600	156.52475 – 156.52525	2483.5 – 2500.0	17.700 – 21.400
8.37625 – 8.38675	156.70000 – 156.90000	2655.0 – 2900.0	22.010 – 23.120
8.41425 – 8.41475	162.01250 – 167.17000	3260.0 – 3267.0	23.600 – 24.000
12.29000 – 12.29300	167.72000 – 173.20000	3332.0 – 3339.0	31.200 – 31.800
12.51975 – 12.52025	240.00000 – 285.00000	3345.8 – 3358.0	36.430 – 36.500
12.57675 – 12.57725	322.00000 – 335.40000	3600.0 – 4400.0	Above 38.6
13.36000 – 13.41000			

** : Until February 1, 1999, this restricted band shall be 0.490-0.510 MHz

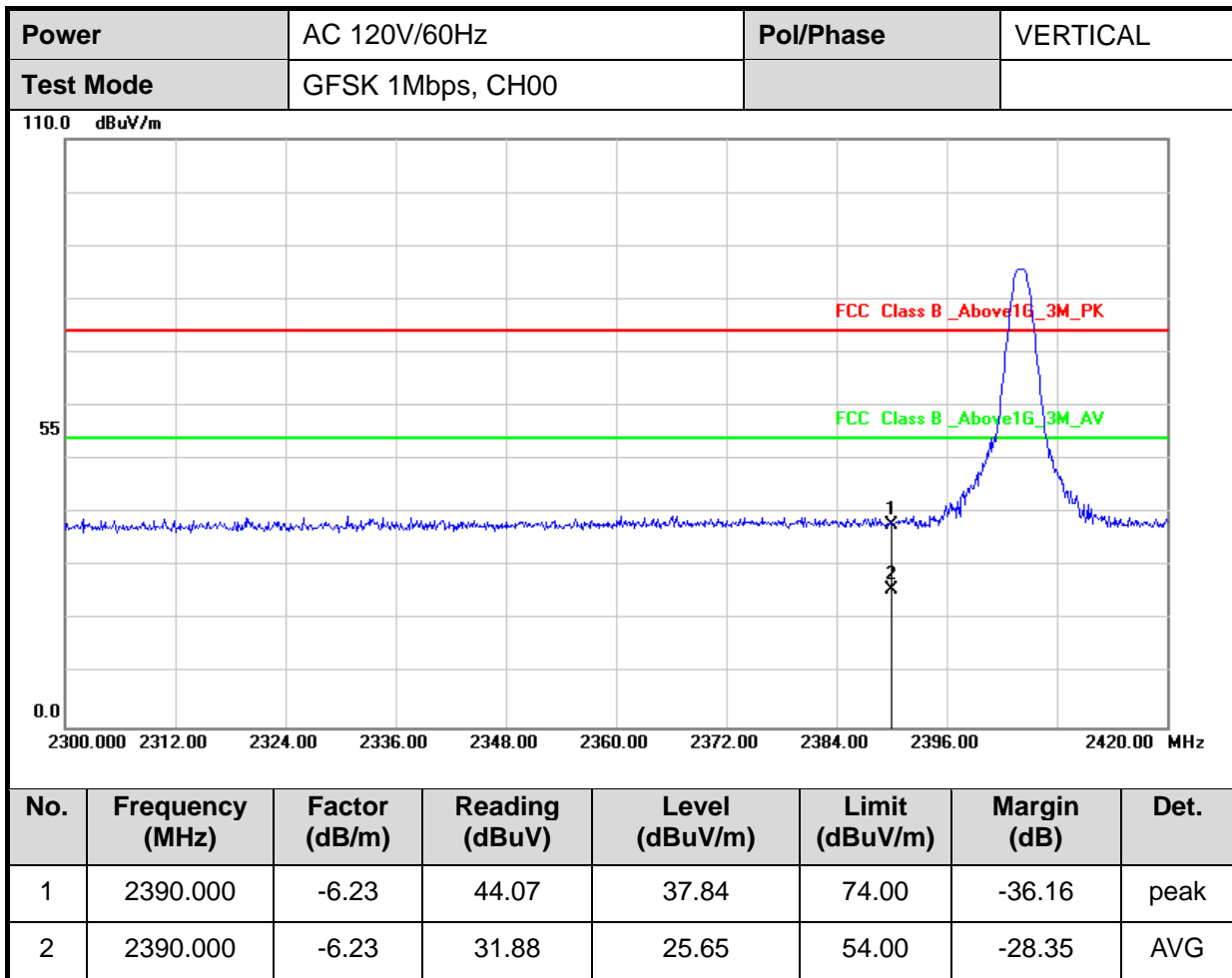

Note: Level = Reading + Factor

Margin = Level – Limit

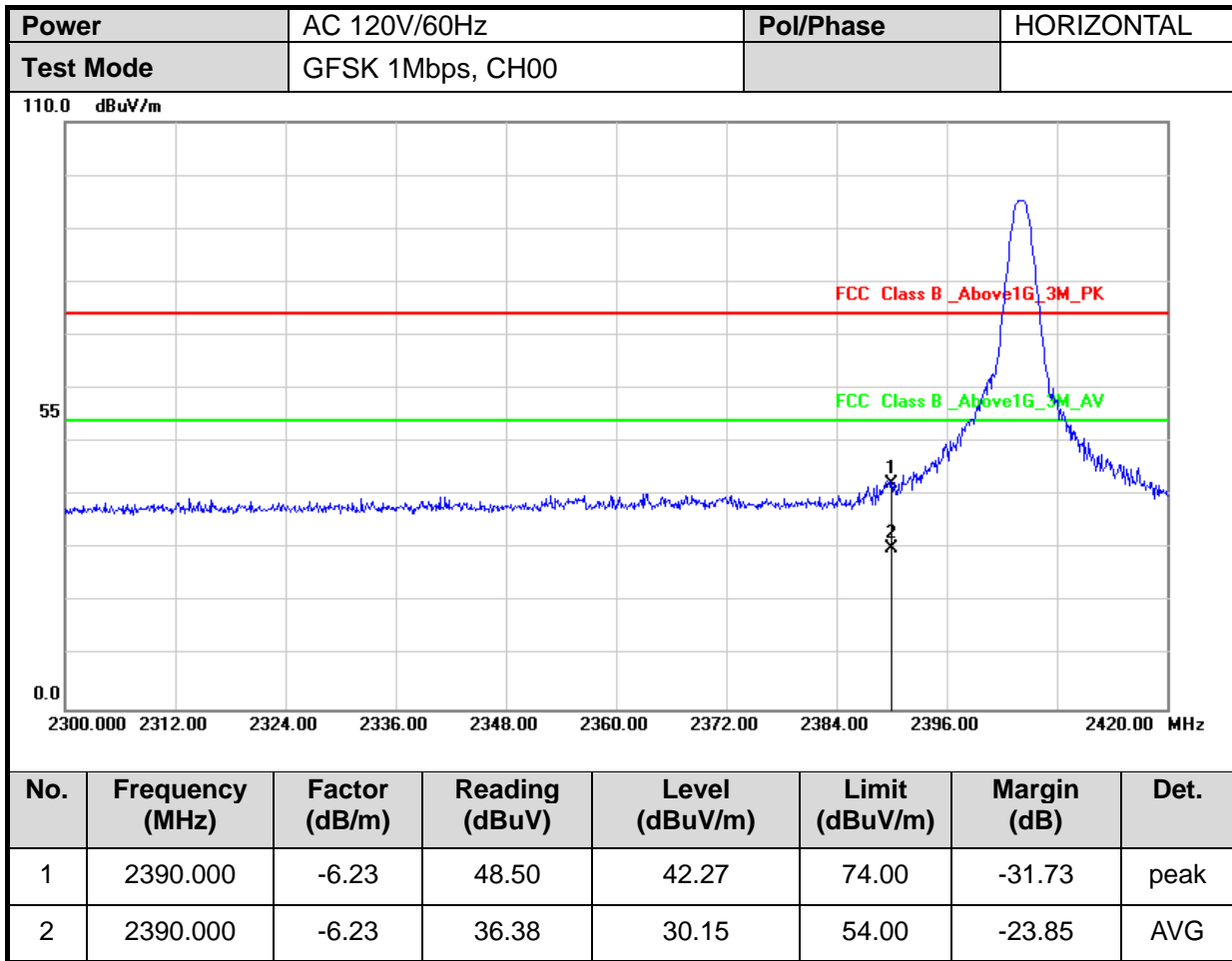

Note: Level = Reading + Factor
 Margin = Level – Limit

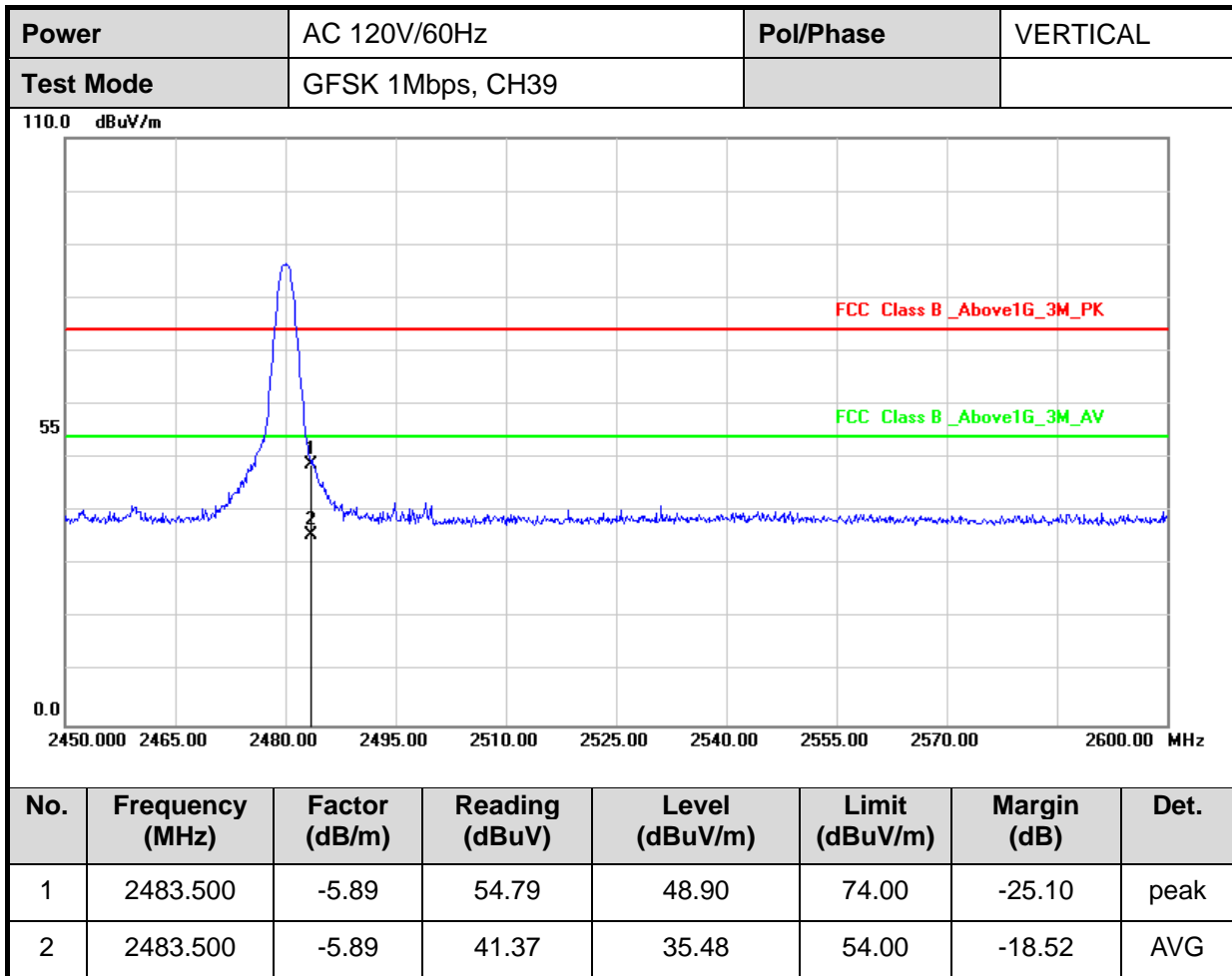

Note: Level = Reading + Factor
 Margin = Level – Limit

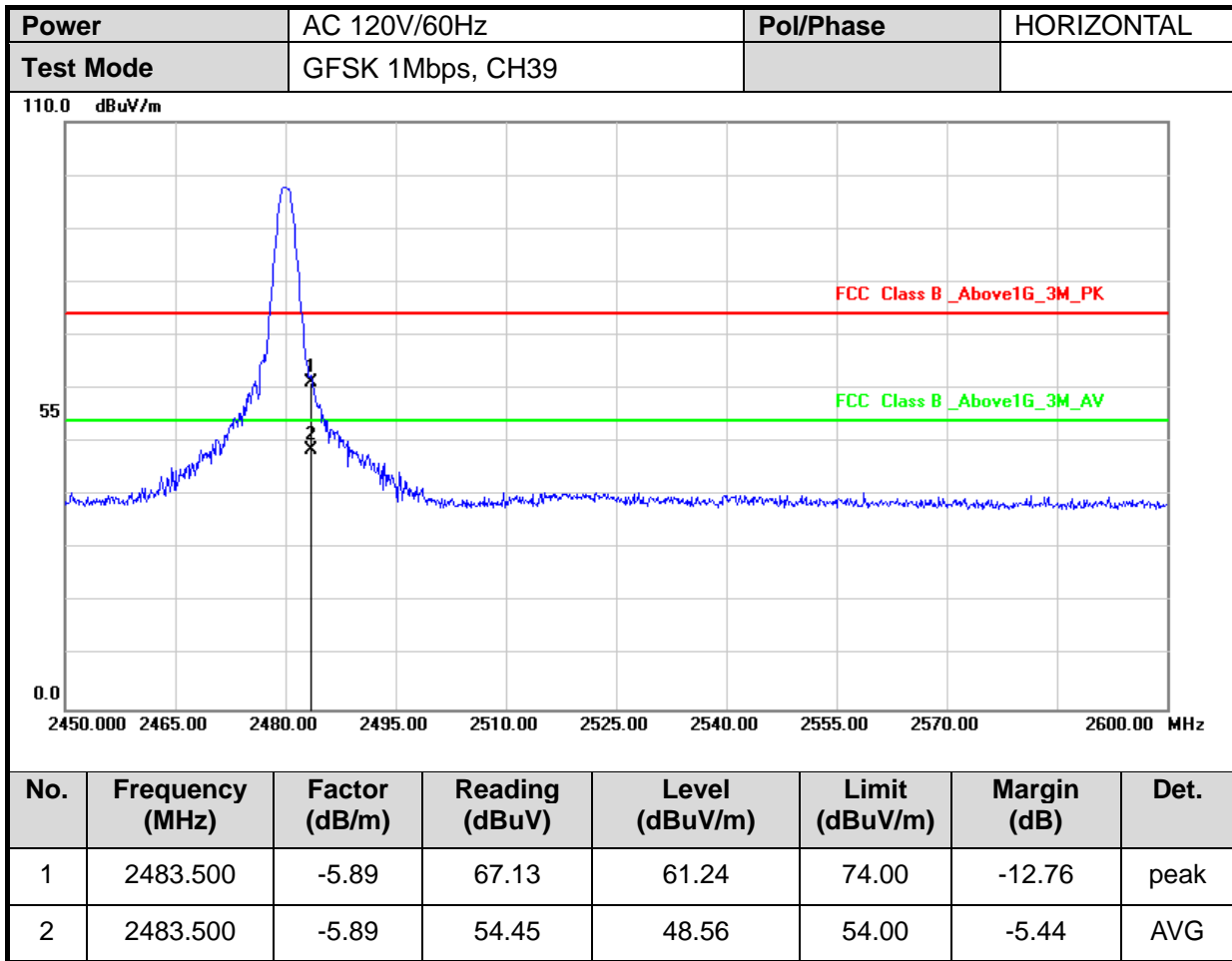

Note: Level = Reading + Factor
 Margin = Level – Limit

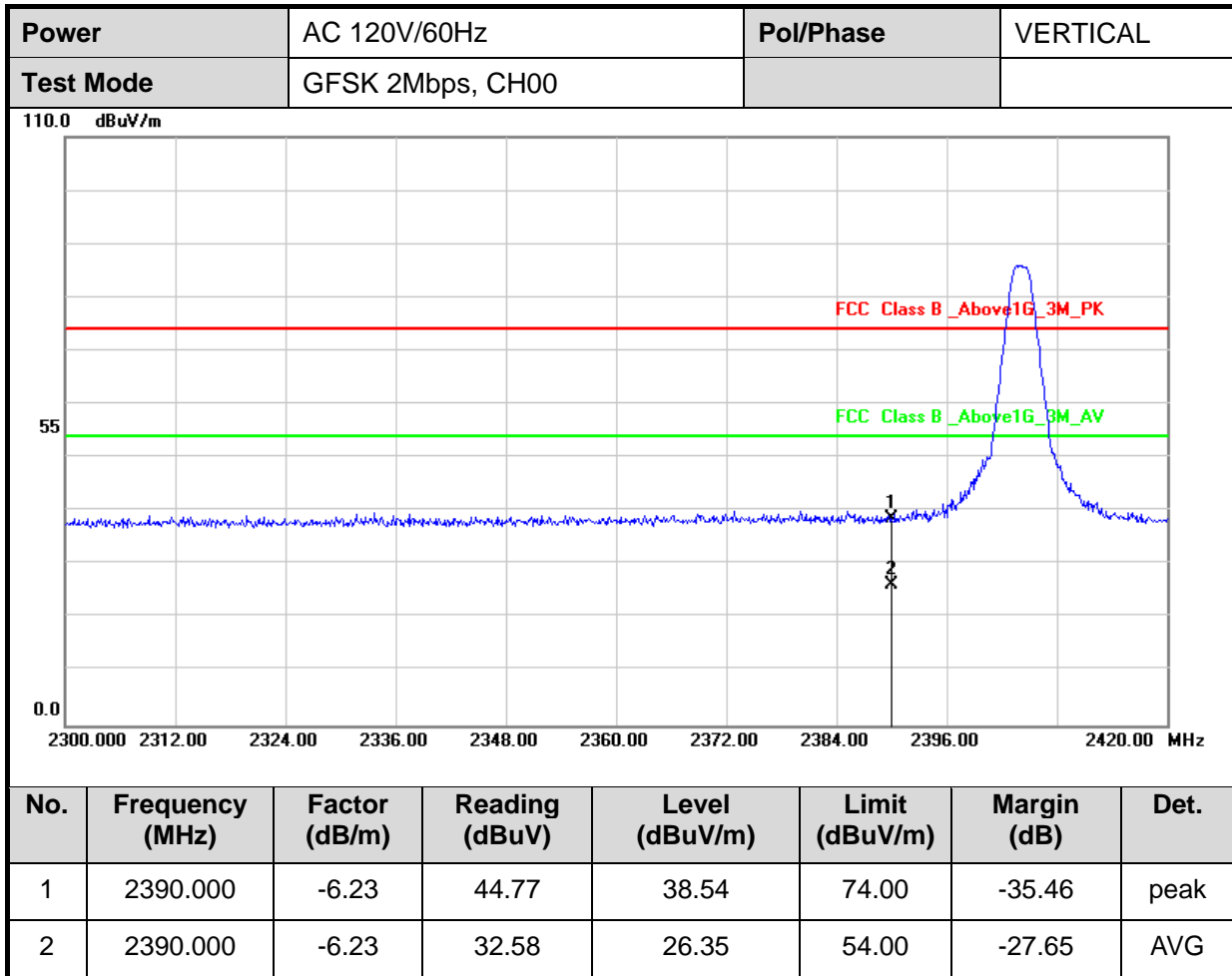

Note: Level = Reading + Factor
 Margin = Level – Limit

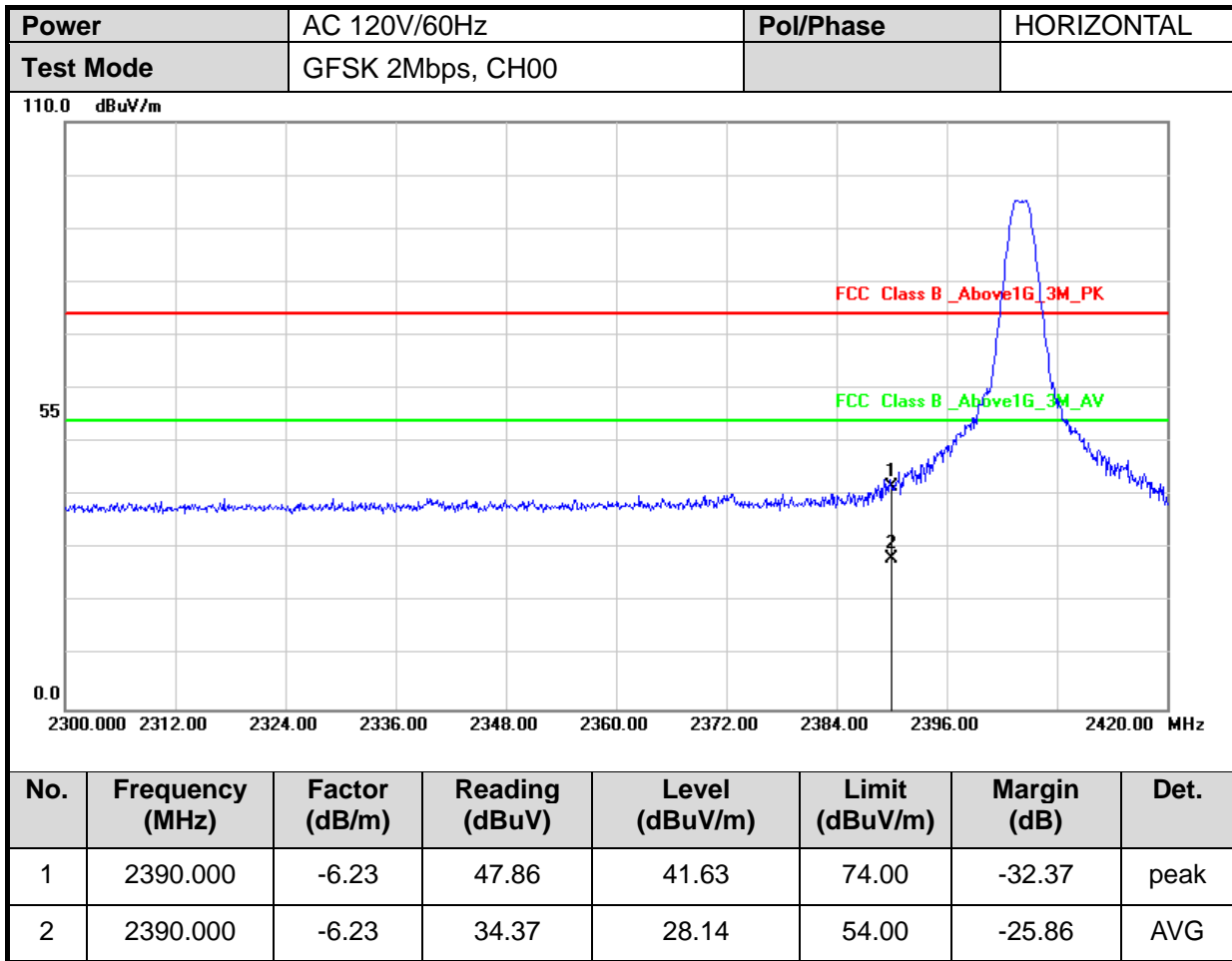

Note: Level = Reading + Factor
Margin = Level – Limit

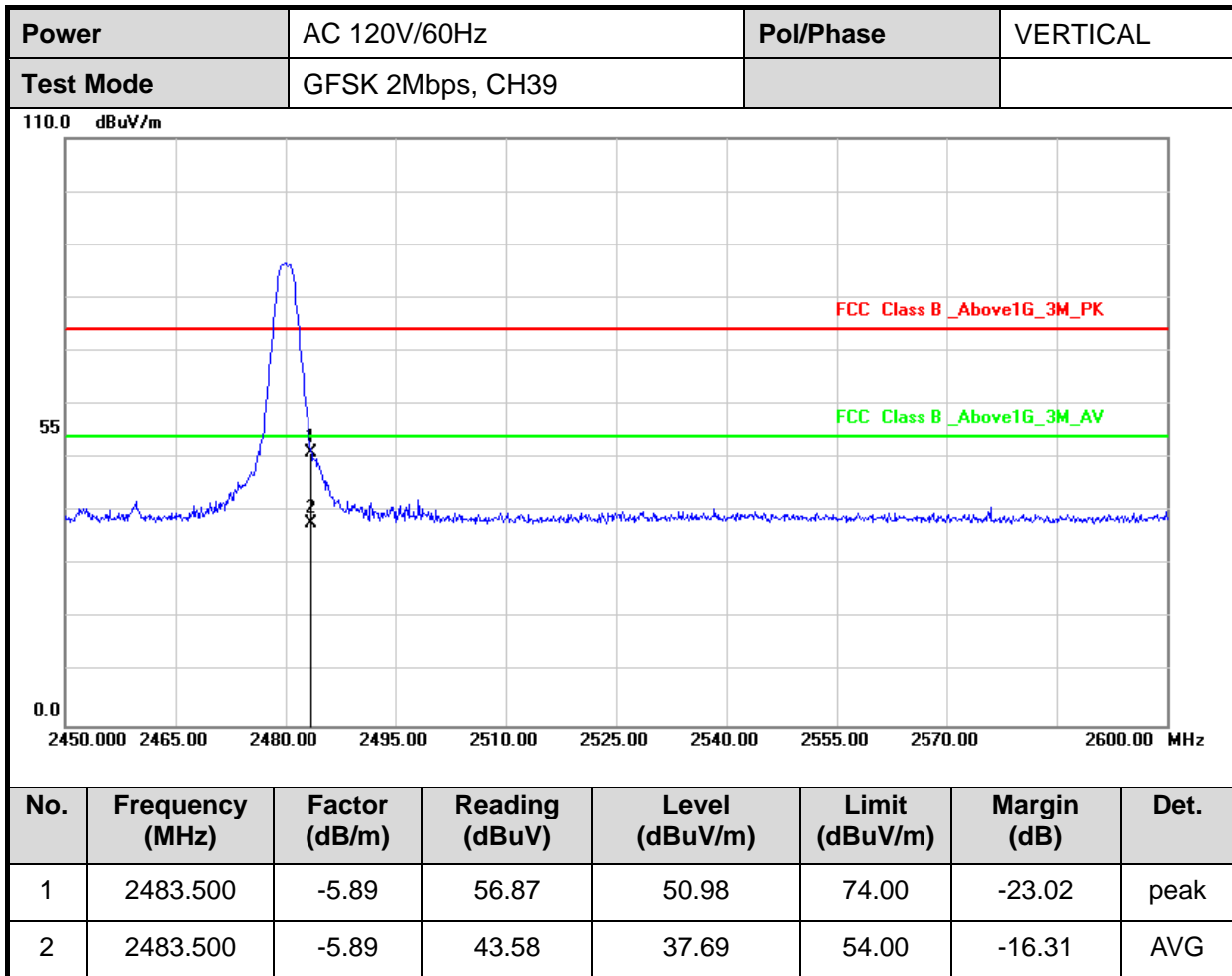

Note: Level = Reading + Factor
 Margin = Level – Limit

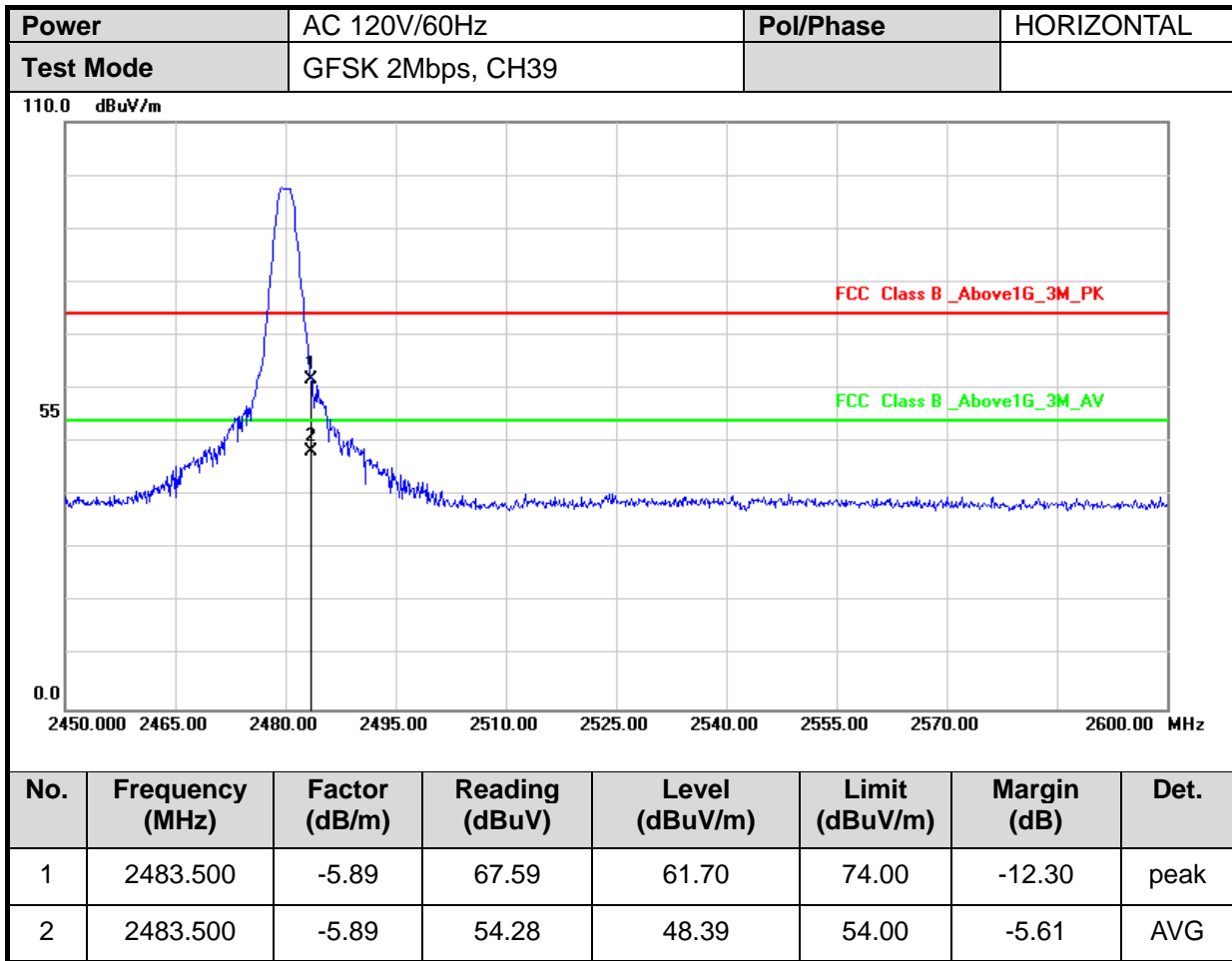

Note: Level = Reading + Factor
 Margin = Level – Limit



7. Test of Spurious Emission (Conducted)

7.1 Test Limit

Below -20dB of the highest emission level of operating band (In 100 kHz Resolution Bandwidth)

7.2 Test Procedure

- a. The transmitter output was connected to the spectrum analyzer via a low loss cable.
- b. Set RBW of spectrum analyzer to 100 KHz and VBW of spectrum analyzer to 300 KHz with convenient frequency span including 100 KHz bandwidth from band edge.
- c. Peak conducted output power measured within any 100 kHz outside the authorized frequency band shall be attenuated by at least 20dB relative to the maximum measured in-band peak PSD level.
- d. The band edges was measured and recorded.

7.3 Test Setup Layout

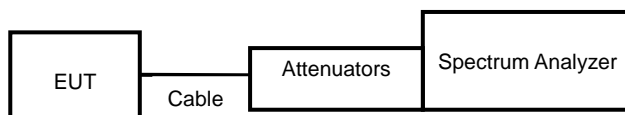

7.4 Test Result and Data

Note: Test plots refer to the following pages.



Modulation Type: GFSK 1Mbps
CH00

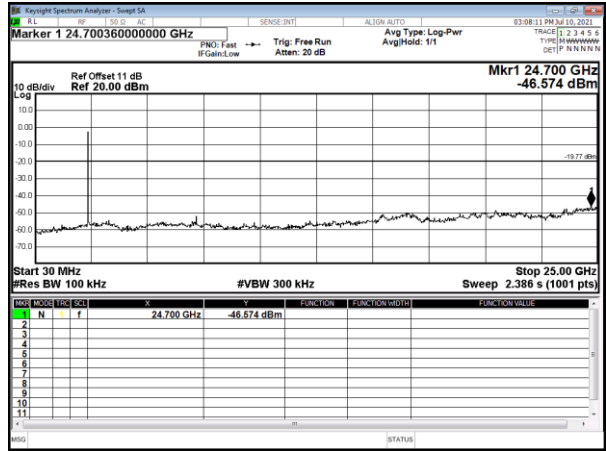
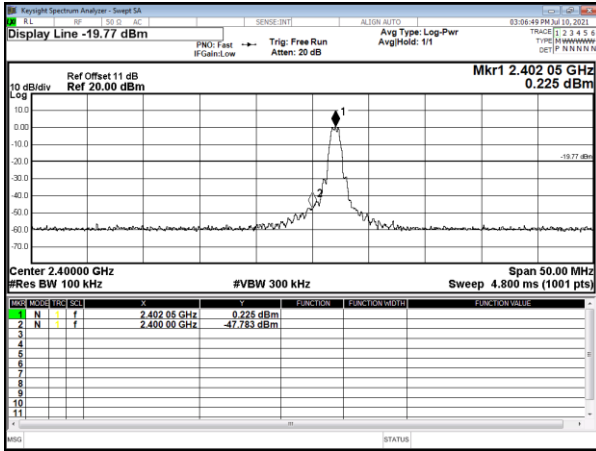

Modulation Type: GFSK 1Mbps
CH19

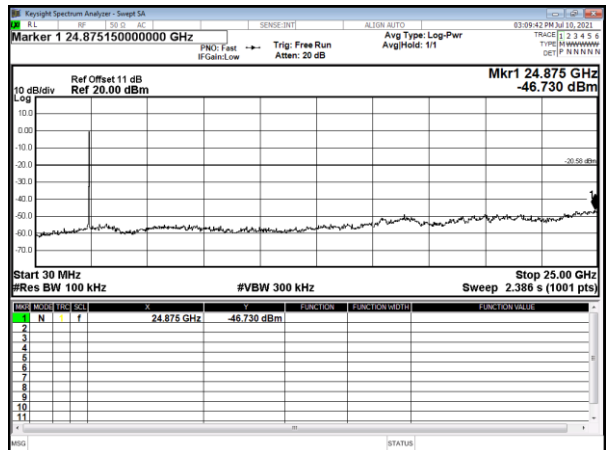
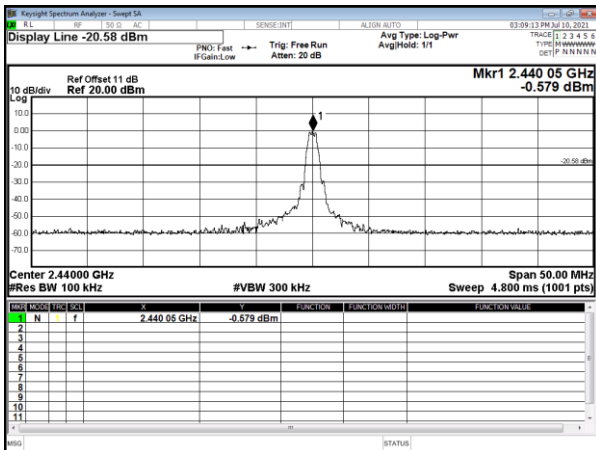

Modulation Type: GFSK 1Mbps
CH39

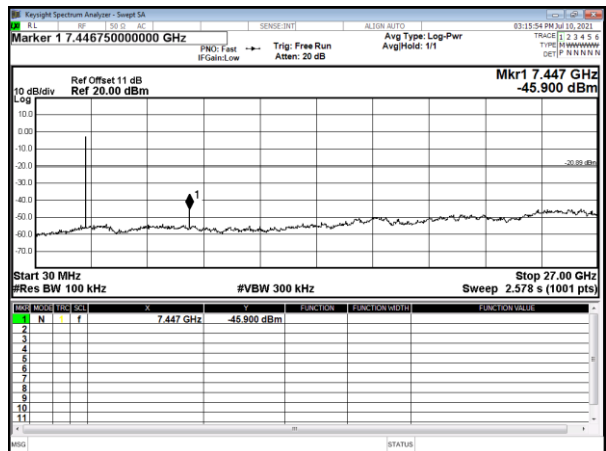
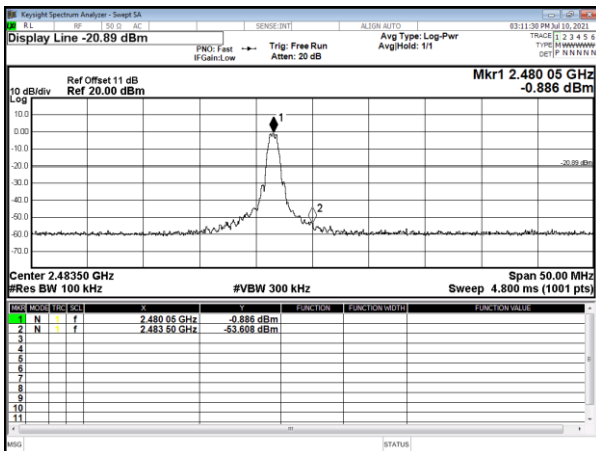



Modulation Type: GFSK 2Mbps
CH00

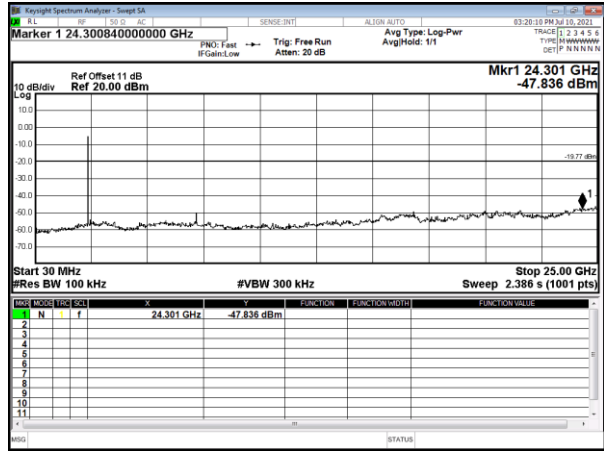
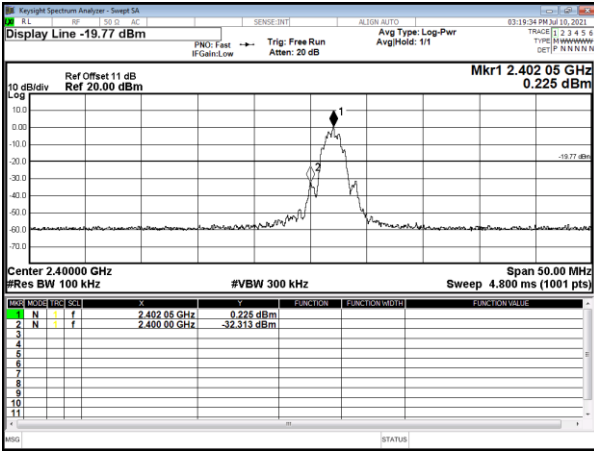

Modulation Type: GFSK 2Mbps
CH19

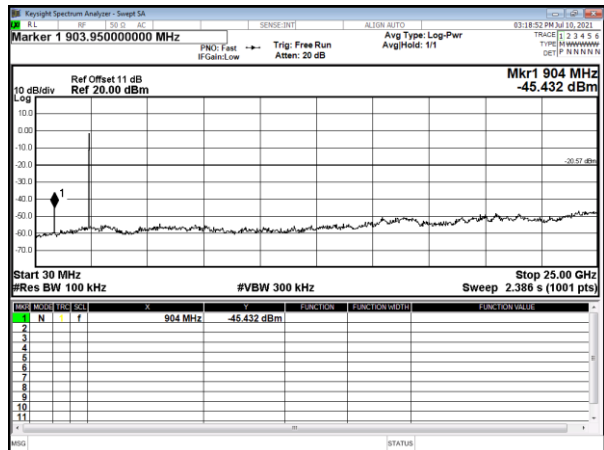
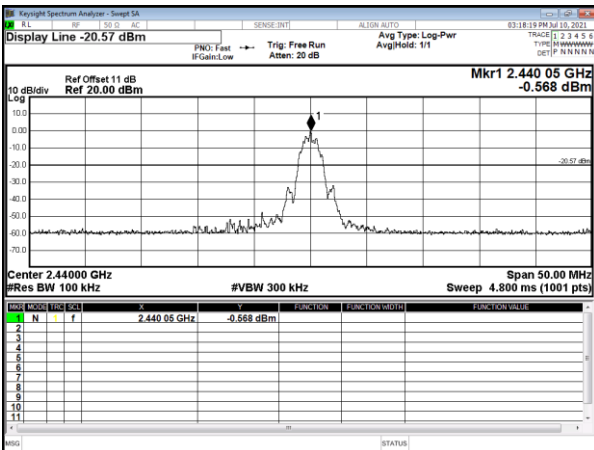

Modulation Type: GFSK 2Mbps
CH39

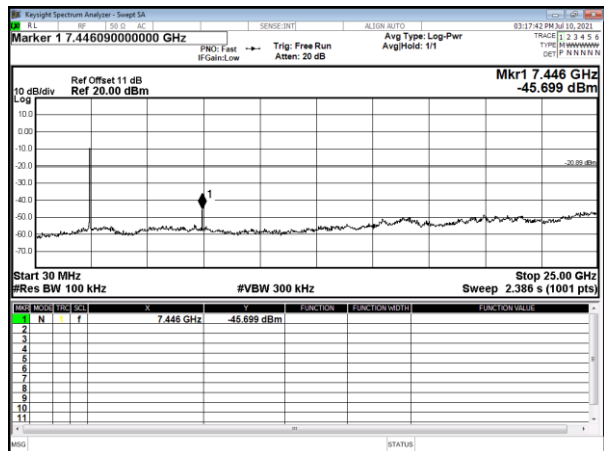
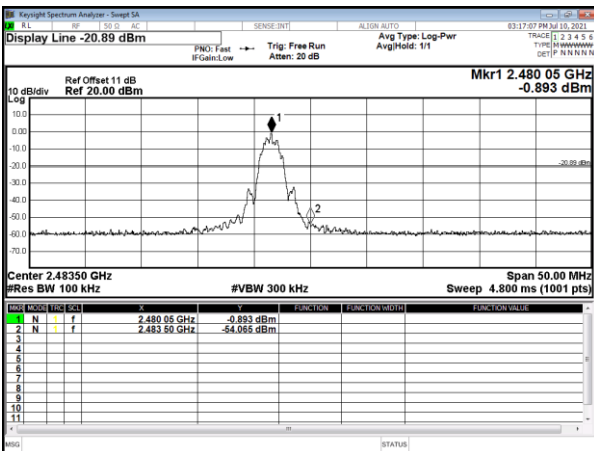



8. On Time, Duty Cycle and Measurement methods

8.1 Test Limit

None; for reporting purposes only.

8.2 Test Procedure

Zero-Span Spectrum Analyzer Method.

8.3 Test Setup Layout

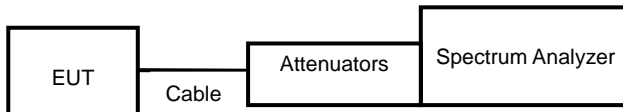

8.4 Test Result and Data

Modulation Mode	On Time (ms)	Period Time (ms)	Duty Cycle (%)
GFSK(1Mbps)	0.11	0.63	17.44%
GFSK(2Mbps)	0.07	0.63	10.88%

Modulation Type: GFSK (1Mbps)

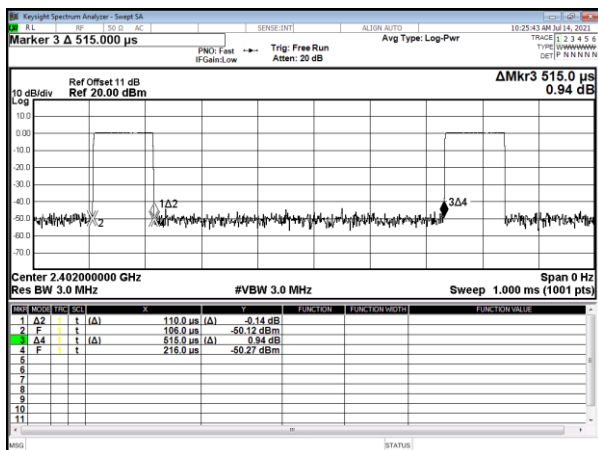

Modulation Type: GFSK (2Mbps)

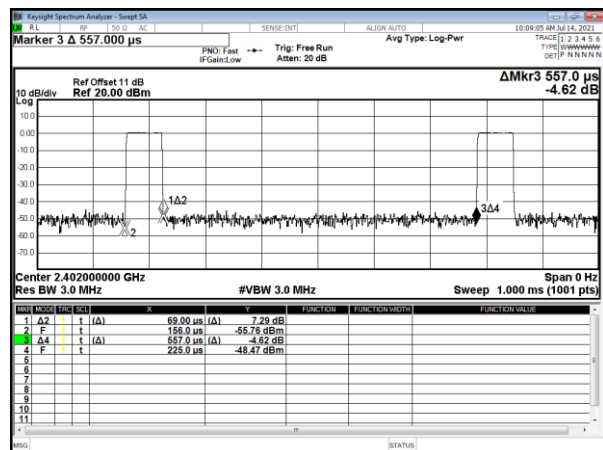



9. 6dB Bandwidth Measurement Data

9.1 Test Limit

The minimum of 6dB Bandwidth Measurement is 0.5 MHz.

9.2 Test Procedures

- a. The transmitter output was connected to the spectrum analyzer.
- b. Set RBW of spectrum analyzer to 1~5% of the emission bandwidth and VBW ≥ 3x RBW.
- c. The 6 dB bandwidth is defined as the total spectrum the power of which is higher than peak power minus 6 dB.
- d. The 6dB Bandwidth was measured and recorded.

9.3 Test Setup Layout

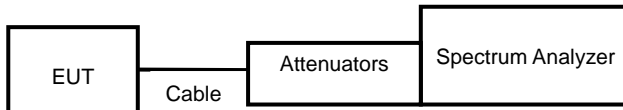

9.4 Test Result and Data

Modulation Type	Channel	Frequency (MHz)	6dB Bandwidth (KHz)	Limit (KHz)
GFSK 1Mbps	00	2402	687.70	500
	19	2440	691.20	500
	39	2480	688.80	500

Modulation Type	Channel	Frequency (MHz)	6dB Bandwidth (KHz)	Limit (KHz)
GFSK 2Mbps	00	2402	1188.00	500
	19	2440	1181.00	500
	39	2480	1182.00	500



Modulation Standard: GFSK (1Mbps)
Channel: 00

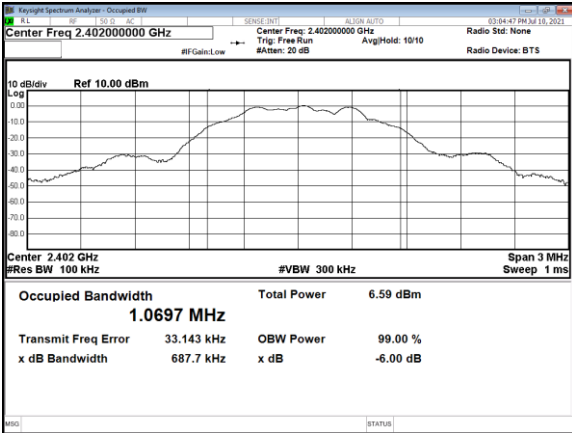

Modulation Standard: GFSK (2Mbps)
Channel: 00

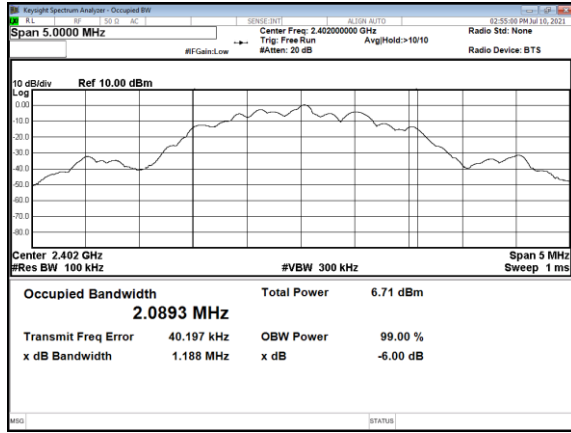

Modulation Standard: GFSK (1Mbps)
Channel: 19

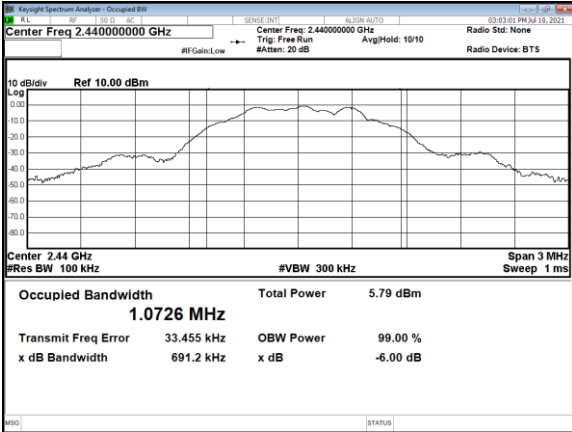

Modulation Standard: GFSK (2Mbps)
Channel: 19

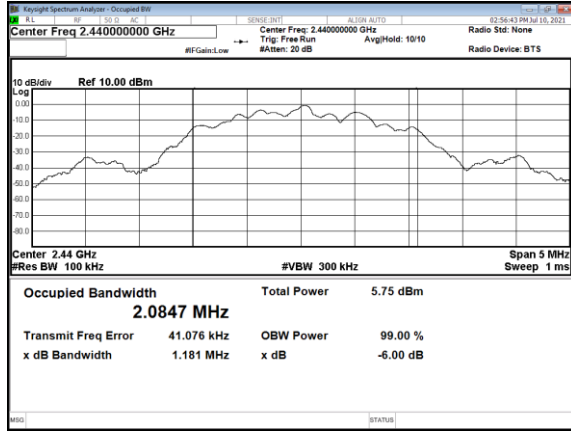

Modulation Standard: GFSK (1Mbps)
Channel: 39

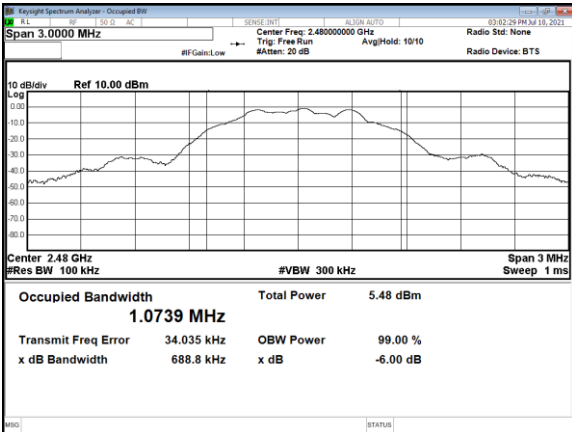

Modulation Standard: GFSK (2Mbps)
Channel: 39

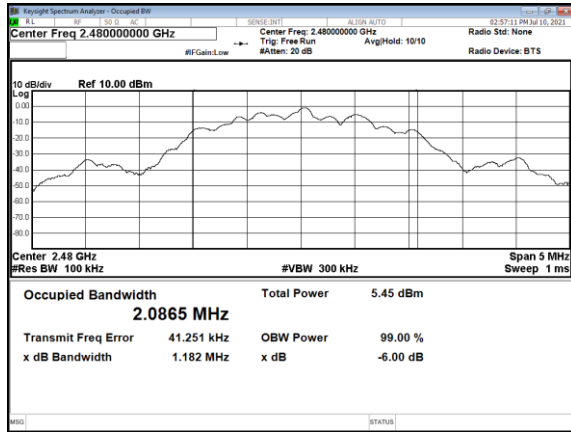



10. Maximum Peak and Average Output Power

10.1 Test Limit

The Maximum Peak Output Power Measurement is 30dBm.

10.2 Test Procedures

The antenna port (RF output) of the EUT was connected to the input (RF input) of a power meter. Power was read directly from the meter and cable loss connection was added to the reading to obtain power at the EUT antenna terminal. The EUT Output Power was set to maximum to produce the worse case test result.

10.3 Test Setup Layout

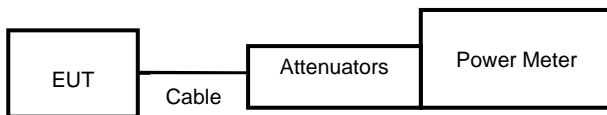

10.4 Test Result and Data

Modulation Standard	Channel	Frequency (MHz)	Power Output (dBm)	Peak Power Output (mW)
GFSK 1Mbps	00	2402	1.72	1.486
	19	2440	0.93	1.239
	39	2480	0.6	1.148

Modulation Standard	Channel	Frequency (MHz)	Power Output (dBm)	Peak Power Output (mW)
GFSK 2Mbps	00	2402	2.42	1.746
	19	2440	1.65	1.462
	39	2480	1.33	1.358



11. Power Spectral Density

11.1 Test Limit

The Maximum of Power Spectral Density Measurement is 8dBm.

11.2 Test Procedures

- a. The transmitter output was connected to spectrum analyzer.
- b. The spectrum analyzer's resolution bandwidth were set at 3KHz RBW and 10KHz VBW as that of the fundamental frequency. Set the sweep time=auto couple.
- c. The power spectral density was measured and recorded.

11.3 Test Setup Layout

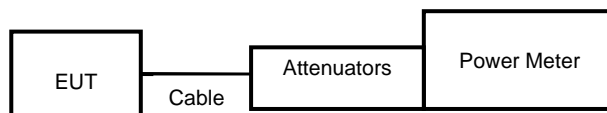



11.4 Test Result and Data

Modulation Standard	Channel	Frequency (MHz)	Maximum Power Density of 3 kHz Bandwidth (dBm)	Limit
GFSK 1Mbps	00	2402	-17.605	8.00
	19	2440	-18.305	8.00
	39	2480	-18.952	8.00

Modulation Standard	Channel	Frequency (MHz)	Maximum Power Density of 3 kHz Bandwidth (dBm)	Limit
GFSK 2Mbps	00	2402	-19.603	8.00
	19	2440	-20.341	8.00
	39	2480	-20.672	8.00



Modulation Type: GFSK(1Mbps)
CH00

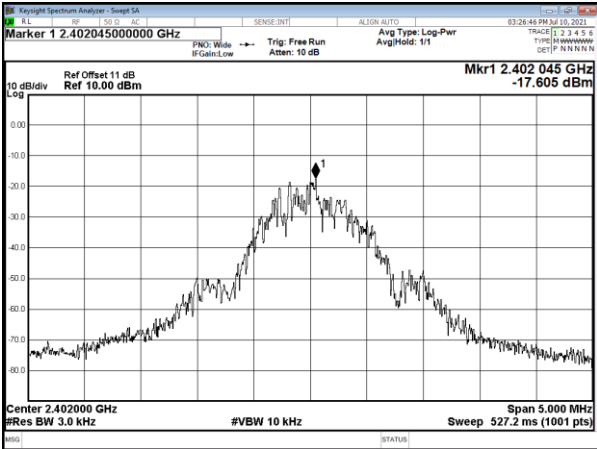

Modulation Type: GFSK(2Mbps)
CH00

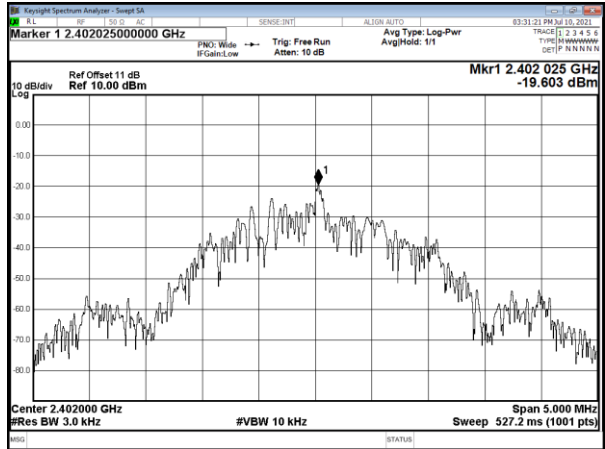

Modulation Type: GFSK(1Mbps)
CH19

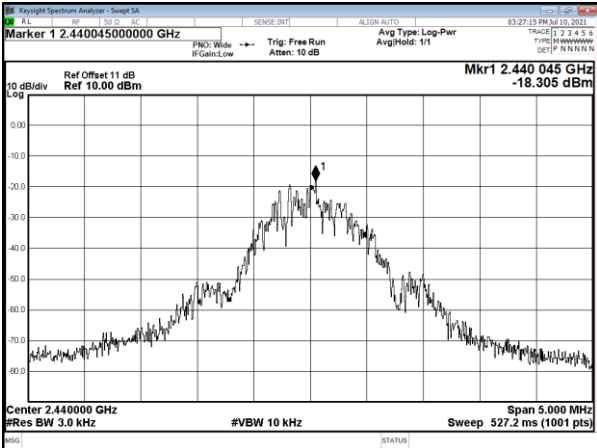

Modulation Type: GFSK(2Mbps)
CH19

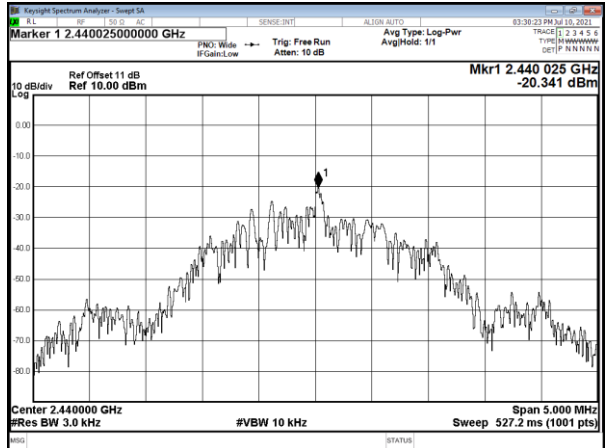

Modulation Type: GFSK(1Mbps)
CH39

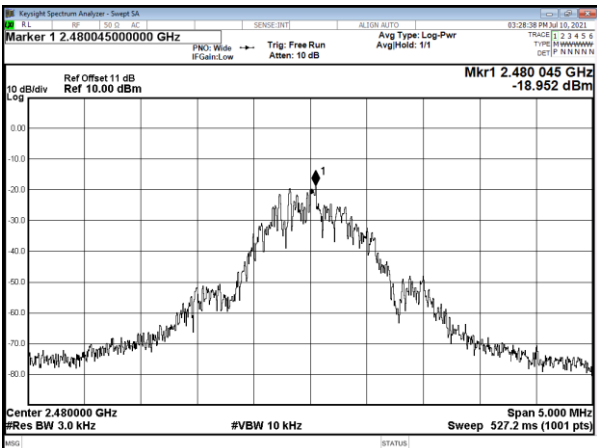

Modulation Type: GFSK(2Mbps)
CH39

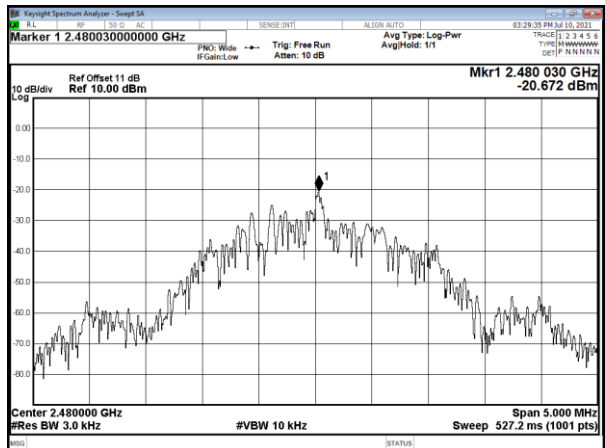

----- End of the report -----