



Test report No.: 23A0004R-SAUSV01S-A

## SAR Test Report (Class II Permissive Change)

Product Name	Intel® Wi-Fi 6E AX211
Trademark	Intel
Model and /or type reference	AX211NGW
Applicant's name / address	Acer Incorporated 8F., No.88, Sec. 1, Xintai 5th Rd., Xizhi Dist., New Taipei City 221 Taiwan
Manufacturer's name	Acer Incorporated
FCC ID	HLZAX211NG
Applicable Standard	IEEE 1528-2013 KDB 447498 D01 v06 KDB 865664 D01 v01r04
Test Result	Max. SAR Measurement (1g) 2.4 GHz: <b>1.131</b> W/kg 5 GHz: <b>1.006</b> W/kg 6 GHz: <b>1.003</b> W/kg Max. psPD Measurement (4cm <sup>2</sup> ) 6 GHz: <b>5.816</b> W/m <sup>2</sup>
Verdict Summary	IN COMPLIANCE
Documented By (Senior Project Specialist / Joanne Lin)	<i>Joanne Lin</i>
Tested By (Senior Engineer / Luke Cheng)	<i>Luke Cheng</i>
Approved By (Assistant Manager / San Lin)	<i>San Lin</i>
Date of Receipt	2023/11/30
Date of Issue	2023/12/20
Report Version	V2.0

**INDEX**

	<b>Page</b>
<b>1. General Information .....</b>	<b>5</b>
1.1 EUT Description .....	5
1.2 Antenna List .....	6
1.3 SAR Test Exclusion Calculation .....	7
1.4 Test Environment.....	9
1.5 Hall Effect and Gravity Sensor Evaluation Procedure .....	10
1.6 Measurement procedures.....	11
<b>2. SAR Measurement System .....</b>	<b>12</b>
2.1 DASY System Description .....	12
2.2 Area Scans.....	14
2.3 DASY E-Field Probe.....	15
2.4 DATA Acquisition Electronics (DAE) and Measurement Server .....	16
2.5 Robot.....	17
2.6 Device Holder.....	17
2.7 Phantom .....	18
<b>3. Tissue Simulating Liquid .....</b>	<b>19</b>
3.1 The composition of the tissue simulating liquid .....	19
3.2 Tissue Calibration Result.....	19
3.3 Tissue Dielectric Parameters for Phantoms .....	20
<b>4. Measurement Procedure.....</b>	<b>21</b>
4.1 SAR System Check.....	21
4.2 SAR Measurement Procedure.....	24
4.3 Absorbed Power Density (APD) .....	25
4.4 Power Density Measurement Procedure .....	25
<b>5. RF Exposure Limits.....</b>	<b>26</b>
<b>6. Test Equipment List .....</b>	<b>27</b>
<b>7. Measurement Uncertainty.....</b>	<b>30</b>
<b>8. Conducted Power Measurement (Including tolerance allowed for production unit).....</b>	<b>35</b>
<b>9. Test Results .....</b>	<b>51</b>
9.1 Test Results Summary .....	51
9.2 Simultaneous Transmission.....	56
<b>10. SAR measurement variability .....</b>	<b>57</b>
Appendix A. System Check Data	
Appendix B. Highest measurement Data	
Appendix C. Test Setup Photographs	
Appendix D. Probe Calibration Data	
Appendix E. Dipole & Source Calibration	
Appendix F. Product Photos-Please refer to the file: 23A0004R-Product Photos	

---

## Competences and Guarantees

---

DEKRA is a testing laboratory competent to carry out the tests described in this report.

In order to assure the traceability to other national and international laboratories, DEKRA has a calibration and maintenance program for its measurement equipment.

DEKRA guarantees the reliability of the data presented in this report, which is the result of the measurements and the tests performed to the item under test on the date and under the conditions stated in the report and it is based on the knowledge and technical facilities available at DEKRA at the time of performance of the test.

DEKRA is liable to the client for the maintenance of the confidentiality of all information related to the item under test and the results of the test.

The results presented in this Test Report apply only to the particular item under test established in this document.

**IMPORTANT:** No parts of this report may be reproduced or quoted out of context, in any form or by any means, except in full, without the previous written permission of DEKRA.

---

## General conditions

---

1. The test results relate only to the samples tested.
2. The test results shown in the test report are traceable to the national/international standard through the calibration report of the equipment and evaluated measurement uncertainty herein.
3. This report must not be used to claim product endorsement by TAF or any agency of the government.
4. The test report shall not be reproduced without the written approval of DEKRA Testing and Certification Co., Ltd.
5. Measurement uncertainties evaluated for each testing system and associated connections are given here to provide the system information for reference. Compliance determinations do not take into account measurement uncertainties for each testing system, but are based on the results of the compliance measurement.

## Revision History

---

Report No.	Version	Description	Issued Date
23A0004R-SAUSV01S-A	V1.0	Initial issue of report.	2023/11/23
23A0004R-SAUSV01S-A	V2.0	Add Gravity Sensor Evaluation to Section 8	2023/12/20

## 1. General Information

### 1.1 EUT Description

Product Name	Intel® Wi-Fi 6E AX211
Trademark	Intel
Model and /or type reference	AX211NGW
FCC ID	HLZAX211NG
Frequency Range	WLAN 2.4GHz: 2412-2472MHz WLAN 5GHz: 5180-5240MHz, 5260-5320MHz, 5500-5720MHz, 5745-5825MHz, 5845-5885MHz WLAN 6GHz: 5955-7115MHz BT: 2402-2480MHz
Type of Modulation	802.11b: DSSS 802.11a/g/n/ac/ax: OFDM, OFDMA GFSK(1Mbps) / $\pi$ /4DQPSK(2Mbps) / 8DPSK(3Mbps)
Antenna Type	PIFA
Device Category	Portable
RF Exposure Environment	Uncontrolled

Summary of test result - Reported 1g SAR (W/kg)				
Test configuration	DTS	NII	6XD	DSS(BT)
Body-worn	1.131	1.006	1.003	0.136
Simultaneous	1.131	1.141	1.019	1.141
Summary of test result - Power Density				
Test configuration	6XD			
APD (W/m <sup>2</sup> )	5.140			
Reported PD (W/m <sup>2</sup> )	5.816			

Note:

Host information				
Trademark	Product Name	Model No.	Marketing Name	Difference
acer	Notebook Computer	N24H3	A14-51M, A14-51P, ASP14-51MTN	All marketing names are electrically identical, different marketing names are for marketing purposes.

**1.2 Antenna List**

No.	Manufacturer	Part No.	Antenna Type	Peak Gain
1	Wistron NeWeb Corporation (NB)	HQ260060002W0(81EAB515.G24) (Main)	PIFA	2.77 dBi for 2400MHz 0.34 dBi for 5150~5250MHz 0.31 dBi for 5250~5350MHz 1.50 dBi for 5470~5725MHz 0.63 dBi for 5725~5850MHz 0.56 dBi for 5850~5895MHz 2.19 dBi for 5925~6425MHz 0.63 dBi for 6425~6525MHz 1.62 dBi for 6525~6875MHz 0.34 dBi for 6875~7125MHz
		HQ260060002W0(81EAB515.G24) (Aux)		2.90 dBi for 2400MHz -0.86 dBi for 5150~5250MHz 0.03 dBi for 5250~5350MHz 1.47 dBi for 5470~5725MHz 1.47 dBi for 5725~5850MHz -0.61 dBi for 5850~5925MHz 0.64 dBi for 5925~6425MHz 0.52 dBi for 6425~6525MHz 1.38 dBi for 6525~6875MHz -0.13 dBi for 6875~7125MHz
	Wistron NeWeb Corporation (PAD)	HQ260060002W0(81EAB515.G24) (Main)		2.76 dBi for 2400MHz 0.57 dBi for 5150~5250MHz 0.57 dBi for 5250~5350MHz 1.15 dBi for 5470~5725MHz 0.25 dBi for 5725~5850MHz 0.25 dBi for 5850~5895MHz 1.49 dBi for 5925~6425MHz 1.49 dBi for 6425~6525MHz 1.46 dBi for 6525~6875MHz 1.09 dBi for 6875~7125MHz
		HQ260060002W0(81EAB515.G24) (Aux)		2.96 dBi for 2400MHz -1.96 dBi for 5150~5250MHz -1.95 dBi for 5250~5350MHz -0.42 dBi for 5470~5725MHz -0.42 dBi for 5725~5850MHz -1.98 dBi for 5850~5895MHz 0.11 dBi for 5925~6425MHz 0.11 dBi for 6425~6525MHz 2.80 dBi for 6525~6875MHz 1.03 dBi for 6875~7125MHz

Note: The above EUT information by host manufacturer.

### 1.3 SAR Test Exclusion Calculation

According to KDB Publication 447498 D01, section 4.3.1, per the calculations of item 1 (Power(mW)/separation (mm)\*sqrt(f(GHz)≤3.0), SAR is required as shown in the table below where calculated values are greater than 3.0:

#### PAD Mode SAR exclusion calculations for WiFi-SISO and Bluetooth for antenna < 50mm from the user :

Antenna	Tx	Frequency (MHz)	Output Power		Separation distances (mm)						Calculated Threshold Value (≤ 3.0 SAR is not required)				
			dBm	mW	Back	Right	Left	Top	Bottom	Back	Right	Left	Top	Bottom	
Main	WiFi	2462	15.5	35	17	3.2	284.8	1.8	220		3.3	11.1	>50mm	11.1	>50mm
Main	WiFi	5240	10	10	17	3.2	284.8	1.8	220		1.3	4.6	>50mm	4.6	>50mm
Main	WiFi	5320	10	10	17	3.2	284.8	1.8	220		1.4	4.6	>50mm	4.6	>50mm
Main	WiFi	5700	10	10	17	3.2	284.8	1.8	220		1.4	4.8	>50mm	4.8	>50mm
Main	WiFi	5825	10	10	17	3.2	284.8	1.8	220		1.4	4.8	>50mm	4.8	>50mm

#### PAD Mode SAR exclusion calculations for WiFi-SISO and Bluetooth for antenna > 50mm from the user :

Antenna	Tx	Frequency (MHz)	Output Power		Separation distances (mm)						Calculated Threshold Value (SAR test exclusion power,mW)				
			dBm	mW	Back	Right	Left	Top	Bottom	Back	Right	Left	Top	Bottom	
Main	WiFi	2462	15.5	35	17	3.2	284.8	1.8	220		<50mm	<50mm	2443.6	<50mm	1795.6
Main	WiFi	5240	10	10	17	3.2	284.8	1.8	220		<50mm	<50mm	2413.5	<50mm	1765.5
Main	WiFi	5320	10	10	17	3.2	284.8	1.8	220		<50mm	<50mm	2413.0	<50mm	1765.0
Main	WiFi	5700	10	10	17	3.2	284.8	1.8	220		<50mm	<50mm	2410.8	<50mm	1762.8
Main	WiFi	5825	10	10	17	3.2	284.8	1.8	220		<50mm	<50mm	2410.2	<50mm	1762.2

**PAD Mode SAR exclusion calculations for WiFi-SISO and Bluetooth for antenna < 50mm from the user :**

Antenna	Tx	Frequency (MHz)	Output Power		Separation distances (mm)						Calculated Threshold Value (≤3.0 SAR is not required)					
			dBm	mW	Back	Right	Left	Top	Bottom		Back	Right	Left	Top	Bottom	
Aux	WiFi	2462	16.5	45	17	283.8	3.2	1.8	220		4.1	>50mm	14.0	14.0	>50mm	
Aux	WiFi	5240	12	16	17	283.8	3.2	1.8	220		2.1	>50mm	7.3	7.3	>50mm	
Aux	WiFi	5320	12	16	17	283.8	3.2	1.8	220		2.2	>50mm	7.3	7.3	>50mm	
Aux	WiFi	5700	12	16	17	283.8	3.2	1.8	220		2.2	>50mm	7.6	7.6	>50mm	
Aux	WiFi	5825	12	16	17	283.8	3.2	1.8	220		2.3	>50mm	7.7	7.7	>50mm	
Aux	BT	2480	10.5	11	17	283.8	3.2	1.8	220		1.0	>50mm	3.5	3.5	>50mm	

**PAD Mode SAR exclusion calculations for WiFi-SISO and Bluetooth for antenna > 50mm from the user :**

Antenna	Tx	Frequency (MHz)	Output Power		Separation distances (mm)						Calculated Threshold Value (SAR test exclusion power,mW)					
			dBm	mW	Back	Right	Left	Top	Bottom		Back	Right	Left	Top	Bottom	
Aux	WiFi	2462	16.5	45	17	283.8	3.2	1.8	220		<50mm	2433.6	<50mm	<50mm	1795.6	
Aux	WiFi	5240	12	16	17	283.8	3.2	1.8	220		<50mm	2403.5	<50mm	<50mm	1765.5	
Aux	WiFi	5320	12	16	17	283.8	3.2	1.8	220		<50mm	2403.0	<50mm	<50mm	1765.0	
Aux	WiFi	5700	12	16	17	283.8	3.2	1.8	220		<50mm	2400.8	<50mm	<50mm	1762.8	
Aux	WiFi	5825	12	16	17	283.8	3.2	1.8	220		<50mm	2400.2	<50mm	<50mm	1762.2	
Aux	BT	2480	10.5	11	17	283.8	3.2	1.8	220		<50mm	2433.3	<50mm	<50mm	1795.3	

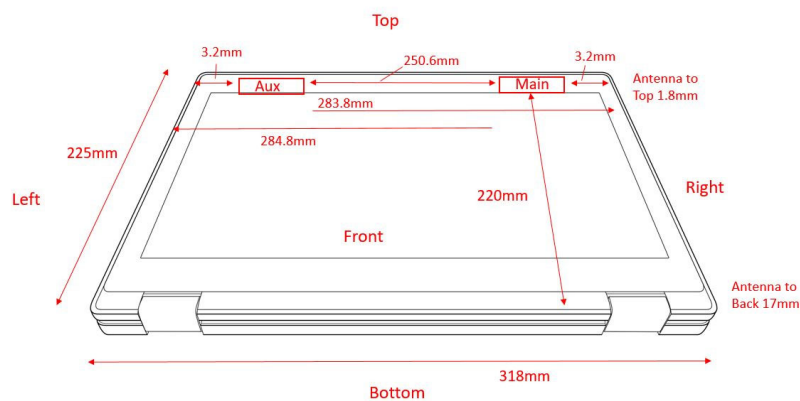



## 1.4 Test Environment

Ambient conditions in the laboratory:

Test Date: 2023/10/24 - 2023/10/26

Items	Required	Actual
Temperature (°C)	18-25	23 ± 2
Humidity (%RH)	30-70	50 ± 20

USA	FCC Registration Number: TW0033
Canada	CAB Identifier Number: TW3023 / Company Number: 26930

Site Description	Accredited by TAF
	Accredited Number: 3023

Test Laboratory	DEKRA Testing and Certification Co., Ltd.
	Linkou Laboratory
Address	No.5-22, Ruishukeng Linkou District, New Taipei City, 24451, Taiwan, R.O.C
Performed Location	No. 26, Huaya 1st Rd., Guishan Dist., Taoyuan City 333411, Taiwan, R.O.C.
Phone Number	+886-3-275-7255
Fax Number	+886-3-327-8031

---

## 1.5 Hall Effect and Gravity Sensor Evaluation Procedure

The test procedure is according to the document (2019-11-13-4.1 RF\_Exposure JN) that presented on November 2019 TCBC workshop.

The following guidance should be applied to laptops/tablets that use Hall Effect or gravity sensors to detect lid angle for the purpose of power reduction:

1. With the lid is in closed mode (0 degrees), open the screen in 10 degree steps until laptop mode is obtained.
2. Lower the screen 5 degrees. Closed mode should be re-obtained. If not, keep lowering in 5 degree steps.
3. Open the screen in 1 degree steps until laptop mode is re-obtained.
4. Continue opening the screen in 1 degree steps until at least 5 degrees past where laptop mode was obtained.
5. Then continue opening the screen in 10 degree steps until tablet mode is obtained.
6. Power measurements should be taken at each step.
7. Reverse this procedure going from tablet mode back down to closed mode
8. Related verification results, please refer to Section 8: Conducted Power Measurement.

---

## 1.6 Measurement procedures

IEEE 1528-2013

47CFR § 2.1093

KDB 248227 D01 v02r02

KDB 447498 D01 v06

KDB 616217 D04 v01r02

KDB 865664 D01 v01r04

IEC TR 63170:2018

IEC/IEEE 62209-1528:2020

## 2. SAR Measurement System

### 2.1 DASy System Description

SAR Configurations is shown below:

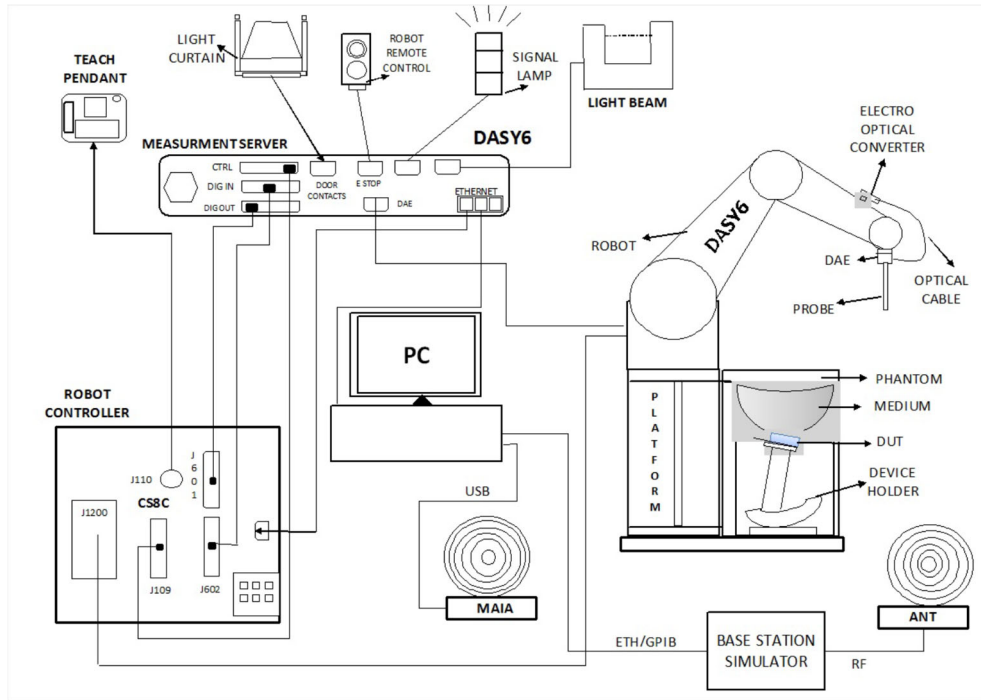

Power Density Configurations is shown below:

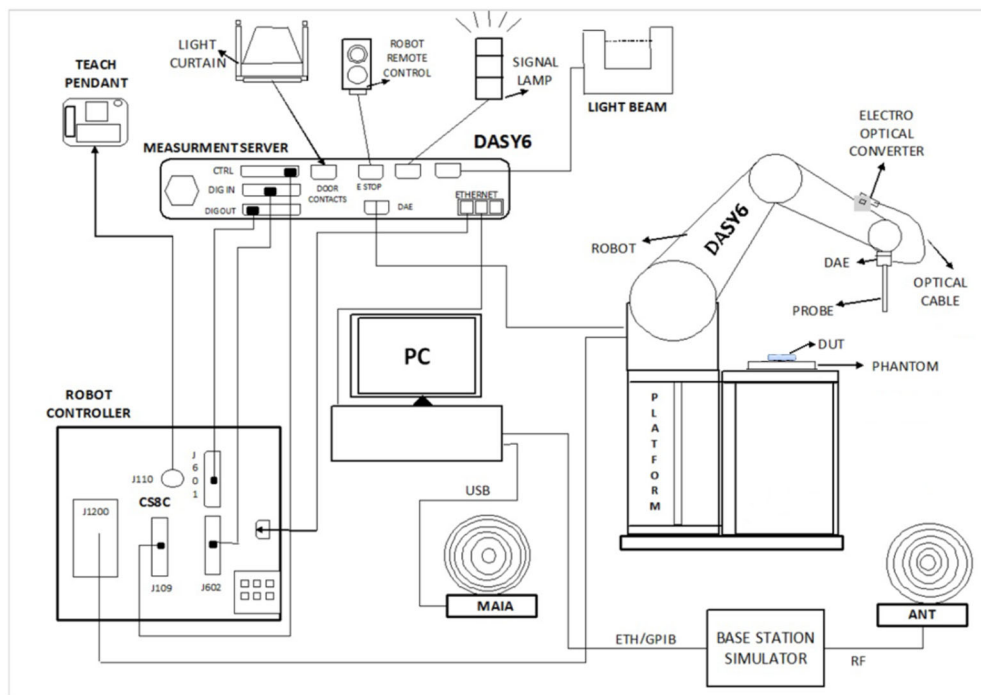

The DASYS system for performing compliance tests consists of the following items:

- A standard high precision 6-axis robot with controller, teach pendant and software. An arm extension for accommodating the data acquisition electronics (DAE).
- A data acquisition electronics (DAE) which performs the signal amplification, signal multiplexing, AD-conversion, offset measurements, mechanical surface detection, collision detection, etc. The unit is battery powered with standard or rechargeable batteries. The signal is optically transmitted to the EOC.
- The Electro-optical converter (EOC) performs the conversion from optical to electrical signals for the digital communication to the DAE. To use optical surface detection, a special version of the EOC is required. The EOC signal is transmitted to the measurement server.
- The Light Beam used is for probe alignment. This improves the (absolute) accuracy of the probe positioning.
- A computer running Win7/8/10 and the DASYS software.
- Remote control and teach pendant as well as additional circuitry for robot safety such as warning lamps, etc.
- The phantom, the device holder and other accessories according to the targeted measurement.

## 2.2 Area Scans

Area scans are defined prior to the measurement process being executed with a user defined variable spacing between each measurement point (integral) allowing low uncertainty measurements to be conducted. Scans defined for utilize a 10mm<sup>2</sup> step integral, with 1mm interpolation used to locate the peak SAR area used for zoom scan assessments.

When an Area Scan has measured all reachable points, it computes the field maxima found in the scanned area, within a range of the global maximum. The range (in dB) is specified in the standards for compliance testing.

### 2.2.1 Zoom Scan (Cube Scan Averaging)

Zoom Scans are used to assess the peak spatial SAR values within a cubic averaging volume containing 1 g and 10 g of simulated tissue. A density of 1000 kg/m<sup>3</sup> is used to represent the head and body tissue density and not the phantom liquid density, in order to be consistent with the definition of the liquid dielectric properties, i.e. the side length of the 1 g cube is 10mm, with the side length of the 10 g cube 21,5mm.

The zoom scan integer steps can be user defined so as to reduce uncertainty, but normal practice for typical test applications utilize a physical step of 5x5x7 (8mmx8mmx5mm) providing a volume of 32mm in the X & Y axis, and 30mm in the Z axis.

### 2.2.2 SAR measurement drifts

Before an area scan and after the zoom scan, single point SAR measurements are performed at defined locations to estimate the SAR measurement drift due to device output power variations. If a device is known to drift randomly, additional single point drift reference measurements should be performed at regular intervals throughout the area and zoom scan test durations. The SAR drift shall be kept within  $\pm 5\%$ , whether there are substantial drifts or not. The field difference will be calculated in dB units in the DASY software.

### 2.2.3 Uncertainty of Inter-/Extrapolation and Averaging

In order to evaluate the uncertainty of the interpolation, extrapolation and averaged SAR calculation algorithms of the Postprocessor, DASY allows the generation of measurement grids which are artificially predefined by analytically based test functions. Therefore, the grids of area scans and zoom scans can be filled with uncertainty test data, according to the SAR benchmark functions.

### 2.3 DASY E-Field Probe

The SAR measurement is conducted with the dosimetric probe manufactured by SPEAG. The probe is specially designed and calibrated for use in liquid with high permittivity. The dosimetric probe has special calibration in liquid at different frequency.

SPEAG conducts the probe calibration in compliance with international and national standards under ISO 17025.

The calibration data are in Appendix D.

#### Isotropic E-Field Probe Specification

<b>Model</b>	Ex3DV4	
<b>Construction</b>	Symmetrical design with triangular core Built-in shielding against static charges PEEK enclosure material (resistant to organic solvents, e.g., DGBE)	
<b>Frequency</b>	4 MHz – 10 GHz Linearity: $\pm 0.2$ dB (30 MHz to 10 GHz)	
<b>Directivity</b>	$\pm 0.1$ dB in TSL (rotation around probe axis) $\pm 0.3$ dB in TSL (rotation normal to probe axis)	
<b>Dynamic Range</b>	10 $\mu$ W/g to 100 mW/g Linearity: $\pm 0.2$ dB (noise: typically $< 1$ $\mu$ W/g)	
<b>Dimensions</b>	Overall length: 337 mm (Tip: 20 mm) Tip diameter: 2.5 mm (Body: 12 mm) Typical distance from probe tip to dipole centers: 1 mm	
<b>Application</b>	High precision dosimetric measurements in any exposure scenario (e.g., very strong gradient fields). Only probe which enables compliance testing for frequencies up to 6 GHz with precision of better 30%.	

### E-Field mm-Wave Probe Specification

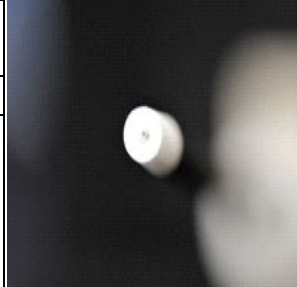
<b>Model</b>	EUmmWVx	
<b>Construction</b>	Two dipoles optimally arranged to obtain pseudo-vector information Minimum three measurements/point, 120° rotated around probe axis Sensors (0.8 mm length) printed on glass substrate protected by high density foam	
<b>Frequency</b>	750 MHz to 110 GHz	
<b>Dynamic Range</b>	< 20 V/m to 10000 V/m with PRE-10 (min < 20 V/m to 2000 V/m)	
<b>Position Precision</b>	< 0.2 mm	
<b>Dimensions</b>	Overall length: 337 mm (tip: 20 mm) Tip diameter: encapsulation 8 mm (internal sensor < 1mm) Distance from probe tip to dipole centers: < 2 mm Sensor displacement to probe's calibration point: < 0.3 mm	
<b>Application</b>	E-field measurements of 5G devices and other mm-wave transmitters operating above 10GHz in < 2 mm distance from device (free-space) Power density, H-field, and far-field analysis using total field reconstruction	

### 2.4 DATA Acquisition Electronics (DAE) and Measurement Server

The data acquisition electronics (DAE) consists of a highly sensitive electrometer-grade preamplifier with auto-zeroing, a channel and gain-switching multiplexer, a fast 16-bit AD-converter and a command decoder and control logic unit.

Transmission to the measurement server is accomplished through an optical downlink for data and status information as well as an optical uplink for commands and the clock.

The input impedance of the DAE4 is 200M Ohm; the inputs are symmetrical and floating. Common mode rejection is above 80dB.

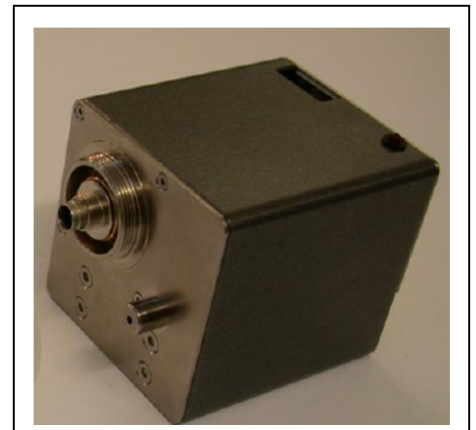



## 2.5 Robot

The DASY system uses the high precision robots TX90 XL type out of the newer series from Stäubli SA (France). For the 6-axis controller DASY system, the CS8C robot controller version from Stäubli is used.

The XL robot series have many features that are important for our application:

- High precision (repeatability 0.02 mm)
- High reliability (industrial design)
- Jerk-free straight movements
- Low ELF interference (the closed metallic construction shields against motor control fields)
- 6-axis controller



## 2.6 Device Holder

The DASY device holder is designed to cope with different positions given in the standard. It has two scales for the device rotation (with respect to the body axis) and the device inclination (with respect to the line between the ear reference points). The rotation center for both scales is the ear reference point (EPR).

Thus the device needs no repositioning when changing the angles.

The DASY device holder has been made out of low-loss POM material having the following dielectric parameters: relative permittivity  $\epsilon_r = 3$  and loss tangent  $\delta = 0.02$ . The amount of dielectric material has been reduced in the closest vicinity of the device, since measurements have suggested that the influence of the clamp on the test results could thus be lowered.

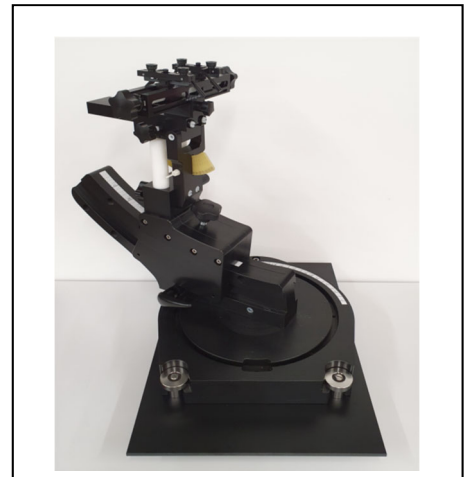

## 2.7 Phantom

### 2.7.1 SAM Twin Phantom

The SAM twin phantom is a fiberglass shell phantom with 2mm shell thickness (except the ear region where shell thickness increases to 6mm).

It has three measurement areas:

- Left head
- Right head
- Flat phantom

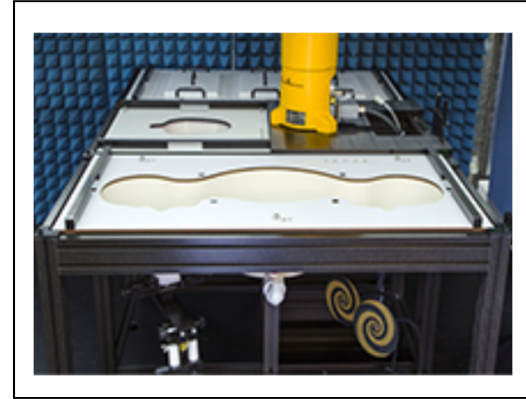

The device holder positions are adjusted to the standard measurement positions in the three sections. A cover is provided to tap the phantom during off-periods to prevent water evaporation and changes in the liquid parameters. On the phantom top, three reference markers are provided to identify the phantom position with respect to the robot.

### 2.7.2 mmWave Phantom

The mmWave Phantom approximates free-space conditions, allowing to evaluate not only the antenna side of the device but also the front (screen) side or any opposite-radiating side of wireless devices operating above 10 GHz without distorting the RF field. It consists of a 40 mm thick Rohacell plate used as a test bed, which has a loss tangent ( $\tan \delta$ )  $\leq 0.05$  and a relative permittivity ( $\epsilon_r$ )  $\leq 1.2$ . High-performance RF absorbers are placed below the foam.



### 3. Tissue Simulating Liquid

#### 3.1 The composition of the tissue simulating liquid

**Description:** Aqueous solution with surfactants and inhibitors

**Declarable, or hazardous components:**

CAS: 107-21-1 EINECS: 203-473-3 Reg.nr.: 01-2119456816-28-0000	<b>Ethenediol</b> STOT RE 2, H373; Acute Tox. 4, H302	< 5.2%
CAS: 68608-26-4 EINECS: 271-781-5 Reg.nr.: 01-2119527859-22-0000	<b>Sodium petroleum sulfonate</b> Eye Irrit. 2, H319	< 2.9%
CAS: 107-41-5 EINECS: 203-489-0 Reg.nr.: 01-2119539582-35-0000	<b>Hexylene Glycol / 2-Methyl-pentane-2,4-diol</b> Skin Irrit. 2, H315; Eye Irrit. 2, H319	< 2.9%
CAS: 68920-66-1 NLP: 500-236-9 Reg.nr.: 01-2119489407-26-0000	<b>Alkoxylated alcohol, &gt; C<sub>16</sub></b> Aquatic Chronic 2, H411; Skin Irrit. 2, H315; Eye Irrit. 2, H319	< 2.0%

#### 3.2 Tissue Calibration Result

The dielectric parameters of the liquids were verified prior to the SAR evaluation using Dielectric Probe Kit and Vector Network Analyzer.

Date	Tissue Type	Frequency (MHz)	Relative Permittivity ( $\epsilon_r$ )			Conductivity ( $\sigma$ )			Tissue Temp. (°C)
			Measured	Target	Delta (%)	Measured	Target	Delta (%)	
2023/10/24	Head	2450	40.48	39.20	3.27	1.78	1.80	-1.11	22.3
	Head	2412	40.62	39.28	3.41	1.73	1.77	-2.26	
	Head	2437	40.53	39.23	3.31	1.76	1.79	-1.68	
	Head	2441	40.51	39.22	3.29	1.76	1.79	-1.68	
	Head	2462	40.43	39.18	3.19	1.79	1.81	-1.10	
2023/10/25	Head	5250	36.49	35.95	1.50	4.73	4.71	0.42	22.1
	Head	5270	36.44	35.93	1.42	4.76	4.73	0.63	
	Head	5290	36.38	35.91	1.31	4.79	4.75	0.84	
	Head	5600	35.52	35.50	0.06	5.21	5.07	2.76	
	Head	5530	35.71	35.61	0.28	5.11	5.00	2.20	
	Head	5610	35.50	35.49	0.03	5.22	5.08	2.76	
	Head	5690	35.28	35.41	-0.37	5.32	5.16	3.10	
	Head	5800	34.97	35.30	-0.93	5.47	5.27	3.80	
	Head	5775	35.04	35.33	-0.82	5.43	5.25	3.43	
2023/10/26	Head	5855	34.83	35.25	-1.19	5.54	5.33	3.94	22.4
	Head	6500	34.10	34.50	-1.16	5.97	6.07	-1.65	
	Head	6025	35.30	35.07	0.66	5.62	5.51	2.00	
	Head	6185	35.10	34.88	0.64	5.72	5.70	0.35	
	Head	6505	34.10	34.49	-1.14	5.98	6.08	-1.64	
	Head	6825	33.50	34.11	-1.79	6.36	6.45	-1.40	
	Head	6985	33.30	33.92	-1.82	6.55	6.63	-1.21	

### 3.3 Tissue Dielectric Parameters for Phantoms

The head tissue dielectric parameters recommended by the IEC/IEEE 62209-1528 have been incorporated in the following table. These head parameters are derived from planar layer models simulating the highest expected SAR for the dielectric properties and tissue thickness variations in a human head. Other head tissue parameters that have not been specified are interpolated according to the head parameters specified in IEC/IEEE 62209-1528.

Target Frequency (MHz)	Head	
	$\epsilon_r$	$\sigma$ (S/m)
450	43.5	0.87
750	41.9	0.89
835	41.5	0.90
900	41.5	0.97
1450	40.5	1.20
1640	40.2	1.31
1750	40.1	1.37
1800 – 2000	40.0	1.40
2450	39.2	1.80
3000	38.5	2.40
5000	36.2	4.45
5200	36.0	4.66
5400	35.8	4.86
5600	35.3	5.27
5800	35.3	5.27
6000	35.1	5.48
6500	34.5	6.07
7000	33.9	6.65
7500	33.3	7.24

## 4. Measurement Procedure

### 4.1 SAR System Check

#### 4.1.1 Dipoles



The SAR dipoles are optimized symmetrical dipole with  $\lambda/4$  balun matched to a Flat phantom section filled with tissue simulating liquids. The center conductor of the feeding line is directly connected to the second arm of the dipole. The antenna is therefore short-circuited for DC signals. They are available for the variety of frequencies between 300MHz and 10 GHz. The provided tripod is used to hold the dipole below the phantom. As the distance between the dipole center and the TSL is critical, a spacer is placed between the dipole and the phantom. The spacing distance is frequency dependent.

#### 4.1.2 Verification Source

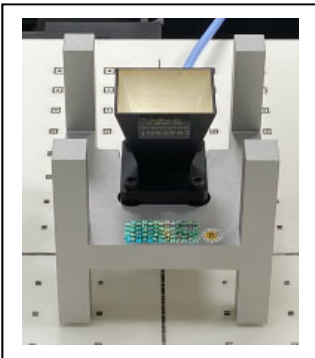

The verification sources apply to system check or verification at specific mmWave frequencies. The sources comprise horn-antennas and very stable signal generators.

### 4.1.3 SAR System Check Result

1. Comparing to the original SAR value provided by SPEAG, the verification data should be within its specification of 10 %.
2. Below table shows the target SAR and measured SAR after normalized to 1W input power. The table below indicates the system performance check can meet the variation criterion and the plots can be referred to Appendix A of this report.

Date	Frequency (MHz)	Input Power (mW)	Measured 1g SAR (W/kg)	Targeted 1g SAR (W/kg)	Normalized 1g SAR (W/kg)	Delta 1g $\pm 10$ (%)	Measured 10g SAR (W/kg)	Targeted 10g SAR (W/kg)	Normalized 10g SAR (W/kg)	Delta 10g $\pm 10$ (%)	Tissue Temp. ( $^{\circ}$ C)
2023/10/24	2450	250	12.70	52.40	50.8	-3.05	5.91	24.60	23.64	-3.90	22.3
2023/10/25	5250	100	8.15	80.80	81.5	0.87	2.35	23.20	23.5	1.29	22.1
2023/10/25	5600	100	8.93	84.20	89.3	6.06	2.54	23.80	25.4	6.72	22.1
2023/10/25	5800	100	7.84	81.80	78.4	-4.16	2.25	23.00	22.5	-2.17	22.1
2023/10/26	6500	100	29.70	293.00	297	1.37	5.52	53.80	55.2	2.60	22.4

#### 4.1.4 Power Density System Check Result

The system performance check verifies that the system operates within its specifications.

The system check is successful if the difference between the normalized measured local power density and the numerically validated target value is within the reported expanded uncertainty of the measurement system.

The recommended settings for measurement of verification sources are listed in the following:

Frequency (GHz)	Grid step	Grid extent X/Y (mm)	Measurement points
10	0.125 ( $\lambda/8$ )	60 / 60	18 x 18

According to the DASYS specification in the user's manual and SPEAG's recommendation, the deviation threshold of  $\pm 0.66$  dB represents the expanded standard uncertainty for system performance check. The system check is successful if the measured results are within  $\pm 0.66$  dB tolerances to the target value shown in the calibration certificate of the verification source.

Date	Frequency (GHz)	Distance (mm)	Input Power (mW)	Measured Avg 1 cm <sup>2</sup> (W/m <sup>2</sup> )	Targeted Avg 1 cm <sup>2</sup> (W/m <sup>2</sup> )	Deviation (dB)	Measured Avg 4 cm <sup>2</sup> (W/m <sup>2</sup> )	Targeted Avg 4 cm <sup>2</sup> (W/m <sup>2</sup> )	Deviation (dB)
2023/10/30	10	10	132	208.7	218.00	-0.19	163.3	172.00	-0.22

Note: The Measured Avg PD was the average of psPDn+, psPDtot+ and psPDmod+, which refers to the demonstration from calibration certificate.

## 4.2 SAR Measurement Procedure

The Dasy calculates SAR using the following equation,

$$\text{SAR} = \frac{\sigma |E|^2}{\rho}$$

Where :

$\sigma$ : represents the simulated tissue conductivity

$\rho$ : represents the tissue density

E :RMS electric field strength (V/m)

The SAR / APD measurements for the EUT should be performed on the channel that produces the highest rated output power of each transmitting antenna.

Pre-scans are made on the device to establish the location for the transmitting antenna, using a large area scan in either air or tissue simulation fluid.

The EUT is placed against the Universal Phantom where the maximum area scan dimensions are larger than the physical size of the resonating antenna. When the scan size is not large enough to cover the peak SAR / APD distribution, it is modified by either extending the area scan size in both the X and Y directions, or the device is shifted within the predefined area.

The area scan is then run to establish the peak SAR / APD location (interpolated resolution set at 1mm<sup>2</sup> ) which is then used to orient the center of the zoom scan. The zoom scan is then executed and the 1g and 10g averages are derived from the zoom scan volume (interpolated resolution set at 1mm<sup>3</sup>).



### 4.3 Absorbed Power Density (APD)

Absorbed Power Density (APD) is defined as the energy flow per unit area directly under the body surface that based on Poynting vector. The equation description is as below:

$$S_{ab} = \iint_A \text{Re}[S] \cdot \frac{ds}{A} = \iint_A \text{Re}[E \times H^*] \cdot \frac{ds}{A}$$

Where:

E = electric field strength (V/m)

H = magnetic field strength (A/m)

S = power density (W/m<sup>2</sup> or mW/cm<sup>2</sup>)

APD is expressed in units of Watts per square meter or units of milliwatt per square centimeter.

### 4.4 Power Density Measurement Procedure

The power density for an electromagnetic field represents the rate of energy transfer per unit area. The local power density (i.e. Poynting vector) at a given spatial point is deduced from electromagnetic fields by the following formula:

$$S = \frac{1}{2} \text{Re}[E \times H^*] \cdot \vec{n}$$

Where: E is the complex electric field peak phasor and H is the complex conjugate magnetic field peak phasor.

The spatial-average power density distribution on the evaluation surface is determined per the IEC TR 63170. The spatial area, A is specified by the applicable exposure limit or regulatory requirements. The circular shape was used.

$$S_{av} = \frac{1}{2A} \Re(\int E \times H \cdot \hat{n} dA)$$

## 5. RF Exposure Limits

SAR assessments have been made in line with the requirements of IEEE-1528, RSS-102 Issue 5, and comply with ANSI/IEEE C95.1-1992 “Uncontrolled Environments” limits. These limits apply to a location which is deemed as “Uncontrolled Environment” which can be described as a situation where the general public may be exposed to an RF source with no prior knowledge or control over their exposure.

### Limits for General Population/Uncontrolled Exposure (W/kg)

Type Exposure	Uncontrolled Environment Limit
Spatial Peak SAR (1g cube tissue for brain or body)	<b>1.60 W/kg</b>
Spatial Average SAR (whole body)	<b>0.08 W/kg</b>
Spatial Peak SAR (10g for hands, feet, ankles and wrist)	<b>4.00 W/kg</b>
Power density <sup>1</sup>	<b>1 mW/cm<sup>2</sup></b>

Note: 1 mW/cm<sup>2</sup> = 10 W/m<sup>2</sup>

## 6. Test Equipment List

Instrument	Manufacturer	Model No.	Serial No.	Last Calibration	Next Calibration
Reference Dipole 2450MHz	Speag	D2450V2	930	2022/11/21	2025/11/20
Reference Dipole 5GHz	Speag	D5GHzV2	1321	2021/02/05	2024/02/04
Reference Dipole 6.5GHz	Speag	D6.5GHzV2	1021	2021/02/09	2024/02/08
Verification Source Antenna 10GHz	Speag	5G Verification Source 10GHz	2006	2023/04/25	2024/04/24
Device Holder	Speag	N/A	N/A	N/A	N/A
Data Acquisition Electronic	Speag	DAE4	1651	2023/02/22	2024/02/21
E-Field Probe	Speag	EX3DV4	7631	2023/02/22	2024/02/21
mmWave E-field Probe	Speag	EUmmWV4	9546	2023/04/18	2024/04/17
SAR Software	Speag	DASY52	V52.10.4.1535	N/A	N/A
SAR Software	Speag	cDASY6	V16.2.4.2524	N/A	N/A
Power Amplifier	Mini-Circuit	ZVE-8G+	447202211	N/A	N/A
Directional Coupler	Agilent	87300C	MY44300353	N/A	N/A <sup>1</sup>
Attenuator	Woken	WATT-218FS-10	N/A	N/A	N/A <sup>1</sup>
Attenuator	Mini-Circuit	BW-S20W2+	N/A	N/A	N/A <sup>1</sup>
Vector Network Analyzer	Agilent	E5071C	MY46108013	2023/03/09	2024/03/08
Signal Generator	Anritsu	MG3694A	041902	2023/09/07	2024/09/06
Power Meter	Anritsu	ML2495A	1434004	2022/12/22	2023/12/21
Power Sensor	Anritsu	MA2411B	1339196	2022/12/22	2023/12/21

Note: 1. System Check, the path loss measured by the network analyzer, includes the signal generator, amplifier, cable, attenuator and directional coupler.

## Note:

Per KDB 865664 D01 requirements for dipole calibration, the following are recommended FCC procedures for SAR dipole calibration.

1. After a dipole is damaged and properly repaired to meet required specifications.
2. When the measured SAR deviates from the calibrated SAR value by more than 10% due to changes in physical, mechanical, electrical or other relevant dipole conditions.
3. When the most recent return-loss, measured at least annually, deviates by more than 20% from the previous measurement (i.e. 0.2 of the dB value) or not meeting the required -20 dB return-loss specification.

	Frequency	Tissue	Return loss	Limit	Date
Calibration	5250 MHz	Head	-39.2	Within 20%	2021/2/5
Measurement	5250 MHz	Head	-39.38		2022/2/7
Measurement	5250 MHz	Head	-39.31		2023/2/2

	Frequency	Tissue	Return loss	Limit	Date
Calibration	5600 MHz	Head	-27.4	Within 20%	2021/2/5
Measurement	5600 MHz	Head	-26.91		2022/2/7
Measurement	5600 MHz	Head	-26.6		2023/2/2

	Frequency	Tissue	Return loss	Limit	Date
Calibration	5800 MHz	Head	-23.6	Within 20%	2021/2/5
Measurement	5800 MHz	Head	-26.92		2022/2/7
Measurement	5800 MHz	Head	-23.6		2023/2/2

	Frequency	Tissue	Return loss	Limit	Date
Calibration	6500 MHz	Head	-34.1	Within 20%	2021/2/9
Measurement	6500 MHz	Head	-31.54		2022/2/9
Measurement	6500 MHz	Head	-33.89		2023/2/3

When the most recent measurement of the real or imaginary parts of the impedance, measured at least annually, deviates by more than 5 Ω from the previous measurement.

	Frequency	Tissue	Impedance	Limit	Date
Calibration	5250 MHz	Head	50.8	Within 5Ω	2021/2/5
Measurement	5250 MHz	Head	50.86		2022/2/7
Measurement	5250 MHz	Head	49.95		2023/2/2

	Frequency	Tissue	Impedance	Limit	Date
Calibration	5600 MHz	Head	52.9	Within 5Ω	2021/2/5
Measurement	5600 MHz	Head	50.99		2022/2/7
Measurement	5600 MHz	Head	50.11		2023/2/2

	Frequency	Tissue	Impedance	Limit	Date
Calibration	5800 MHz	Head	53.0	Within 5Ω	2021/2/5
Measurement	5800 MHz	Head	51.12		2022/2/7
Measurement	5800 MHz	Head	51.06		2023/2/2

	Frequency	Tissue	Impedance	Limit	Date
Calibration	6500 MHz	Head	51.0	Within 5Ω	2021/2/9
Measurement	6500 MHz	Head	51.08		2022/2/9
Measurement	6500 MHz	Head	50.97		2023/2/3

## 7. Measurement Uncertainty

Measurement uncertainty for 300 MHz to 3 GHz							
Error Description	Uncert. value	Prob. Dist.	Div.	(ci) 1g	(ci) 10g	Std. Unc. (1g)	Std. Unc. (10g)
<b>Measurement System Errors</b>							
Probe Calibration	±12.0%	N	2	1	1	±6.0%	±6.0%
Probe Calibration Drift	±1.7%	R	1.732	1	1	±1.0%	±1.0%
Probe Linearity	±4.7%	R	1.732	1	1	±2.7%	±2.7%
Broadband Signal	±2.8%	R	1.732	1	1	±1.6%	±1.6%
Probe Isotropy	±7.6%	R	1.732	1	1	±4.4%	±4.4%
Other Probe+Electronic	±0.8%	N	1	1	1	±0.8%	±0.8%
RF Ambient	±1.8%	N	1	1	1	±1.8%	±1.8%
Probe Positioning	±0.006 mm	N	1	0.14	0.14	±0.1%	±0.1%
Data Processing	±1.2%	N	1	1	1	±1.2%	±1.2%
<b>Phantom and Device Errors</b>							
Conductivity (meas.)	±2.5%	N	1	0.78	0.71	±2.0%	±1.8%
Conductivity (temp.)	±3.3%	R	1.732	0.78	0.71	±1.5%	±1.4%
Phantom Permittivity	±14.0%	R	1.732	0	0	±0.0%	±0.0%
Distance DUT - TSL	±2.0%	N	1	2	2	±4.0%	±4.0%
Device Positioning	±1.0%	N	1	1	1	±1.0%	±1.0%
Device Holder	±3.6%	N	1	1	1	±3.6%	±3.6%
DUT Modulation	±2.4%	R	1.732	1	1	±1.4%	±1.4%
Time-average SAR	±1.7%	R	1.732	1	1	±1.0%	±1.0%
DUT drift	±2.5%	N	1	1	1	±2.5%	±2.5%
Val Antenna Unc.	±0.0%	N	1	1	1	±0.0%	±0.0%
Unc. Input Power	±0.0%	N	1	1	1	±0.0%	±0.0%
<b>Correction to the SAR results</b>							
Deviation to Target	±1.9%	N	1	1	0.84	±1.9%	±1.6%
SAR scaling	±0.0%	R	1.732	1	1	±0.0%	±0.0%
<b>Combined Uncertainty</b>						±11.0%	±10.9%
<b>Expanded Uncertainty</b>						±21.9%	±21.7%

Measurement uncertainty for 3 GHz to 6 GHz							
Error Description	Uncert. value	Prob. Dist.	Div.	(ci) 1g	(ci) 10g	Std. Unc. (1g)	Std. Unc. (10g)
<b>Measurement System Errors</b>							
Probe Calibration	±14.0%	N	2	1	1	±7.0%	±7.0%
Probe Calibration Drift	±1.7%	R	1.732	1	1	±1.0%	±1.0%
Probe Linearity	±4.7%	R	1.732	1	1	±2.7%	±2.7%
Broadband Signal	±2.6%	R	1.732	1	1	±1.5%	±1.5%
Probe Isotropy	±7.6%	R	1.732	1	1	±4.4%	±4.4%
Other Probe+Electronic	±1.2%	N	1	1	1	±1.2%	±1.2%
RF Ambient	±1.8%	N	1	1	1	±1.8%	±1.8%
Probe Positioning	±0.005 mm	N	1	0.29	0.29	±0.2%	±0.2%
Data Processing	±2.3%	N	1	1	1	±2.3%	±2.3%
<b>Phantom and Device Errors</b>							
Conductivity (meas.)	±2.5%	N	1	0.78	0.71	±2.0%	±1.8%
Conductivity (temp.)	±3.4%	R	1.732	0.78	0.71	±1.5%	±1.4%
Phantom Permittivity	±14.0%	R	1.732	0.25	0.25	±2.0%	±2.0%
Distance DUT - TSL	±2.0%	N	1	2	2	±4.0%	±4.0%
Device Positioning	±1.0%	N	1	1	1	±1.0%	±1.0%
Device Holder	±3.6%	N	1	1	1	±3.6%	±3.6%
DUT Modulation	±2.4%	R	1.732	1	1	±1.4%	±1.4%
Time-average SAR	±1.7%	R	1.732	1	1	±1.0%	±1.0%
DUT drift	±2.5%	N	1	1	1	±2.5%	±2.5%
Val Antenna Unc.	±0.0%	N	1	1	1	±0.0%	±0.0%
Unc. Input Power	±0.0%	N	1	1	1	±0.0%	±0.0%
<b>Correction to the SAR results</b>							
Deviation to Target	±1.9%	N	1	1	0.84	±1.9%	±1.6%
SAR scaling	±0.0%	R	1.732	1	1	±0.0%	±0.0%
<b>Combined Uncertainty</b>						±11.9%	±11.8%
<b>Expanded Uncertainty</b>						±23.8%	±23.6%

Measurement uncertainty for 6 GHz to 10 GHz							
Error Description	Uncert. value	Prob. Dist.	Div.	(ci) 1g	(ci) 10g	Std. Unc. (1g)	Std. Unc. (10g)
<b>Measurement System Errors</b>							
Probe Calibration	±18.6%	N	2	1	1	±9.3%	±9.3%
Probe Calibration Drift	±1.7%	R	1.732	1	1	±1.0%	±1.0%
Probe Linearity	±4.7%	R	1.732	1	1	±2.7%	±2.7%
Broadband Signal	±2.6%	R	1.732	1	1	±1.5%	±1.5%
Probe Isotropy	±7.6%	R	1.732	1	1	±4.4%	±4.4%
Other Probe+Electronic	±2.4%	N	1	1	1	±2.4%	±2.4%
RF Ambient	±1.8%	N	1	1	1	±1.8%	±1.8%
Probe Positioning	±0.005 mm	N	1	0.5	0.5	±0.3%	±0.3%
Data Processing	±3.5%	N	1	1	1	±3.5%	±3.5%
<b>Phantom and Device Errors</b>							
Conductivity (meas.)	±2.5%	N	1	0.78	0.71	±2.0%	±1.8%
Conductivity (temp.)	±2.4%	R	1.732	0.78	0.71	±1.1%	±1.0%
Phantom Permittivity	±14.0%	R	1.732	0.5	0.5	±4.0%	±4.0%
Distance DUT - TSL	±2.0%	N	1	2	2	±4.0%	±4.0%
Device Positioning	±1.0%	N	1	1	1	±1.0%	±1.0%
Device Holder	±3.6%	N	1	1	1	±3.6%	±3.6%
DUT Modulation	±2.4%	R	1.732	1	1	±1.4%	±1.4%
Time-average SAR	±1.7%	R	1.732	1	1	±1.0%	±1.0%
DUT drift	±2.5%	N	1	1	1	±2.5%	±2.5%
Val Antenna Unc.	±0.0%	N	1	1	1	±0.0%	±0.0%
Unc. Input Power	±0.0%	N	1	1	1	±0.0%	±0.0%
<b>Correction to the SAR results</b>							
Deviation to Target	±1.9%	N	1	1	0.84	±1.9%	±1.6%
SAR scaling	±0.0%	R	1.732	1	1	±0.0%	±0.0%
<b>Combined Uncertainty</b>						±14.2%	±14.1%
<b>Expanded Uncertainty</b>						±28.4%	±28.3%



**APD Measurement uncertainty for 6 GHz to 10 GHz**

Error Description	Uncert. value	Prob. Dist.	Div.	(Ci) 1 cm <sup>2</sup>	(Ci) 4 cm <sup>2</sup>	Std. Unc. (1 cm <sup>2</sup> )	Std. Unc. (4 cm <sup>2</sup> )
SAR MU	±14.2/13.9%	N	1	1	1	±14.2%	±13.9%
Power Density Conversion	±13.5%	R	√3	1	1	±7.8%	±7.8%

Combined Uncertainty						±16.2%	±15.9%
<b>Expanded Uncertainty</b> in dB						±32.4% ±1.2 dB	±31.9% ±1.2 dB

Measurement uncertainty for Power Density						
Error Description	Uncert. Value ( $\pm$ dB)	Prob. Dist.	Div.	(ci)	Std. Unc. ( $\pm$ dB)	(vi) $v_{eff}$
<b>Uncertainty terms dependent on the measurement system</b>						
Calibration	0.49	N	1	1	0.49	$\infty$
Probe correction	0	R	1.732	1	0	$\infty$
Frequency response (BW $\leq$ 1 GHz)	0.2	R	1.732	1	0.12	$\infty$
Sensor cross coupling	0	R	1.732	1	0	$\infty$
Isotropy	0.5	R	1.732	1	0.29	$\infty$
Linearity	0.2	R	1.732	1	0.12	$\infty$
Probe scattering	0	R	1.732	1	0	$\infty$
Probe positioning offset	0.3	R	1.732	1	0.17	$\infty$
Probe positioning repeatability	0.04	R	1.732	1	0.02	$\infty$
Sensor mechanical offset	0	R	1.732	1	0	$\infty$
Probe spatial resolution	0	R	1.732	1	0	$\infty$
Field impedance dependance	0	R	1.732	1	0	$\infty$
Amplitude and phase drift	0	R	1.732	1	0	$\infty$
Amplitude and phase noise	0.04	R	1.732	1	0.02	$\infty$
Measurement area truncation	0	R	1.732	1	0	$\infty$
Data acquisition	0.03	N	1	1	0.03	$\infty$
Sampling	0	R	1.732	1	0	$\infty$
Field reconstruction	0.6	R	1.732	1	0.35	$\infty$
FTE/MEO	0	R	1.732	1	0	$\infty$
Power density scaling	0	R	1.732	1	0	$\infty$
Spatial averaging	0.1	R	1.732	1	0.06	$\infty$
System detection limit	0.04	R	1.732	1	0.02	$\infty$
<b>Uncertainty terms dependent on the DUT and environmental factors</b>						
Probe coupling with DUT	0	R	1.732	1	0	$\infty$
Modulation response	0.4	R	1.732	1	0.23	$\infty$
Integration time	0	R	1.732	1	0	$\infty$
Response time	0	R	1.732	1	0	$\infty$
Device holder influence	0.1	R	1.732	1	0.06	$\infty$
DUT alignment	0	R	1.732	1	0	$\infty$
RF ambient conditions	0.04	R	1.732	1	0.02	$\infty$
Ambient reflections	0.04	R	1.732	1	0.02	$\infty$
Immunity / secondary reception	0	R	1.732	1	0	$\infty$
Drift of the DUT	0.21	R	1.732	1	0.12	$\infty$
<b>Combined Standard Uncertainty</b>					0.76	$\infty$
<b>Expanded Standard Uncertainty (95%)</b>					1.52	

### 8. Conducted Power Measurement (Including tolerance allowed for production unit)

WLAN 2.4G 2TX SISO (NB Mode)									
	Frequency	Mode	BW	SISO-Main(TX1) Chain B			SISO-Aux(TX2) Chain A		
				CH	AV Power	AV Target	CH	AV Power	AV Target
DSSS/OFDM mode specified maximum output power at an antenna port	WLAN 2.4GHz	b	20	1	19.93	20	1	19.82	20
				6	19.96	20	6	19.83	20
				11	19.91	20	11	19.76	20
				12	18.92	19	12	18.92	19
				13	15.89	16	13	15.34	15.5
		g	20	1	19.41	19.5	1	19.31	19.5
				6	19.88	20	6	19.68	20
				11	18.95	19	11	18.91	19
				12	15.36	15.5	12	15.43	15.5
				13	11.89	12	13	11.88	12
		n (HT)	20	1	18.91	19	1	19.44	19.5
				6	19.85	20	6	19.75	20
				11	18.63	18.75	11	18.67	18.75
				12	15.45	15.5	12	15.32	15.5
				13	11.82	12	13	11.85	12
			40	3	16.34	16.5	3	16.43	16.5
				6	19.76	20	6	19.74	20
				9	16.94	17	9	15.77	16
				10	10.82	11	10	10.89	11
				11	10.89	11	11	10.86	11
		ax (HE)	20	1	19.84	20	1	19.42	19.5
				6	19.81	20	6	19.73	20
				11	18.63	18.75	11	18.7	18.75
				12	15.42	15.5	12	15.33	15.5
				13	11.82	12	13	11.87	12
			40	3	18.12	18.5	3	17.82	18.5
				6	19.48	20	6	19.74	20
				9	16.86	17	9	15.83	16
10	10.87			11	10	10.91	11		
11	10.88			11	11	10.82	11		

WLAN 5G 2TX SISO (NB Mode)											
OFDM mode specified maximum output power at an antenna port	Frequency	Mode	BW	SISO-Main(TX1) Chain B			SISO-Aux(TX2) Chain A				
				CH	AV Power	AV Target	CH	AV Power	AV Target		
OFDM mode specified maximum output power at an antenna port	U-NII-1 (5150~5250MHz)	a	20	36	19.14	19.25	36	19.34	20		
				40	19.46	20	40	19.38	20		
				44	19.44	20	44	19.41	20		
				48	19.41	20	48	19.37	20		
		n (HT)	20	36	19.21	19.25	36	19.41	19.5		
				40	19.41	20	40	19.39	20		
				44	19.4	20	44	19.36	20		
				48	19.36	20	48	19.38	20		
		40	38	17.61	17.75	38	19.42	19.5			
			46	19.85	20	46	19.91	20			
		ac(VHT)	80	42	18.71	18.75	42	19.44	20		
		ax (HE)	20	36	19.28	19.5	36	19.32	20		
				40	19.32	20	40	19.41	20		
				44	19.39	20	44	19.39	20		
				48	19.37	20	48	19.38	20		
			40	38	17.89	18	38	19.39	20		
				46	19.24	19.5	46	19.32	20		
			80	42	17.83	18	42	19.38	20		
			OFDM mode specified maximum output power at an antenna port	U-NII-2C (5470~5725MHz)	a	20	100	19.01	20	100	18.97
		116					18.86	20	116	19.04	20
		124					18.9	20	124	18.94	20
		132					18.91	20	132	18.83	20
		140					18.83	20	140	18.77	20
		144					18.92	20	144	18.86	20
	n (HT)	20			100	18.93	20	100	19.05	20	
					116	18.78	20	116	19.08	20	
					124	18.89	20	124	19.01	20	
					132	18.83	20	132	19.06	20	
		40			140	18.88	20	140	18.93	20	
					144	18.9	20	144	19.12	20	
		40			102	18.2	19	102	19.12	20	
					110	18.81	20	110	19.25	20	
	80	126			18.78	20	126	19.09	20		
		134			18.7	20	134	19.04	20		
		138			19.92	20	138	19.91	20		
		106			18.46	18.5	106	19.43	20		
ax (HE)	160	122			19.84	20	122	19.87	20		
		114			14.79	16	114	15.46	16		
	20	100			19.04	20	100	19.09	20		
		116			18.97	20	116	19.23	20		
		124			18.95	20	124	19.08	20		
		132			18.98	20	132	19.03	20		
		140		18.99	20	140	18.95	20			
		144		18.96	20	144	19.07	20			
	40	102		18.64	20	102	19.13	20			
		110		18.63	20	110	19.24	20			
126		18.61		20	126	19.08	20				
134		18.55		20	134	19.05	20				
80	142	18.58		20	142	19.01	20				
	138	18.34		20	138	18.97	20				
	106	18.31		18.5	106	19.14	20				
	122	18.25		20	122	19.09	20				
160	114	15.05		16	114	15.16	16.5				

WLAN 5G 2TX SISO (NB Mode)										
	Frequency	Mode	BW	SISO-Main(TX1) Chain B			SISO-Aux(TX2) Chain A			
				CH	AV Power	AV Target	CH	AV Power	AV Target	
				OFDM mode specified maximum output power at an antenna port						
	U-NII-2A (5250~5350MHz)	a	20	52	19.48	20	52	19.35	20	
				56	19.54	20	56	19.36	20	
				60	19.49	20	60	19.38	20	
				64	18.93	19	64	19.37	20	
		n (HT)	20	52	19.44	20	52	19.34	20	
				56	19.42	20	56	19.4	20	
				60	19.35	20	60	19.41	20	
			40	64	18.83	19	64	19.37	20	
				54	19.94	20	54	19.96	20	
				62	16.91	17	62	18.17	18.25	
		ac (VHT)	80	58	17.94	18	58	18.42	18.5	
			160	50	15.08	15.25	50	16.84	17	
		ax (HE)	20	52	19.4	20	52	19.36	20	
				56	19.38	20	56	19.4	20	
				60	19.34	20	60	19.41	20	
				64	18.92	19	64	19.37	20	
			40	54	19.43	20	54	19.33	20	
				62	18.94	19	62	19.38	20	
				80	58	17.88	18	58	18.46	18.5
				160	50	14.56	16	50	15.28	16.5
		U-NII-3 (5725~5850MHz)	a	20	149	19.02	20	149	18.88	20
					157	19.07	20	157	19.01	20
					165	19.11	20	165	19.14	20
				n (HT)	20	149	18.92	20	149	19.05
	157					18.97	20	157	19.18	20
	165					18.96	20	165	19.16	20
	40		151	18.89	20	151	19.13	20		
			159	18.86	20	159	19.19	20		
	ac(VHT)		80	155	19.96	20	155	19.89	20	
	ax (HE)		20	149	19.03	20	149	19.09	20	
				157	19.01	20	157	19.18	20	
				165	19.09	20	165	19.16	20	
			40	151	18.65	20	151	19.03	20	
				159	18.71	20	159	19.21	20	
				155	18.42	20	155	19.05	20	
	U-NII-4 (5850~5925MHz)		a	20	169	19.27	19.5	169	19.27	19.5
					173	19.37	19.5	173	19.25	19.5
					177	19.33	19.5	177	19.28	19.5
		n (HT)		20	169	19.27	19.5	169	19.18	19.5
					173	19.31	20	173	19.25	20
					177	19.24	20	177	19.19	20
		40	167	19.34	20	167	18.95	20		
			175	19.16	20	175	18.92	20		
		ac(VHT)	80	171	19.93	20	171	19.88	20	
			160	163	16.88	18	163	16.34	17	
		ax (HE)	20	169	19.33	20	169	18.91	20	
				173	19.34	19.5	173	18.81	19.5	
				177	19.23	19.5	177	19.06	20	
40			167	18.91	20	167	19.24	20		
			175	18.84	20	175	19.23	20		
			80	171	18.72	20	171	19.21	20	
160			163	16.69	18	177	16.29	17.5		

WLAN 6G 2TX SISO (NB Mode)																					
OFDM mode specified maximum output power at an antenna port	Frequency	Mode	BW	SISO-Main(TX1)			SISO-Aux(TX2)			Frequency	Mode	BW	SISO-Main(TX1)			SISO-Aux(TX2)					
				Chain B			Chain A						Chain B			Chain A					
				CH	AV	AV	CH	AV	AV				CH	AV	AV	CH	AV	AV	CH	AV	AV
					Power	Target		Power	Target					Power	Target		Power	Target		Power	Target
U-NII-5 (5925~6425MHz)	ax (HE)	20	1	4.54	5.0	1	4.32	5	U-NII-7 (6525~6875MHz)	ax (HE)	20	117	4.32	4.5	117	4.74	5				
			45	4.22	4.5	45	4.51	5				149	4.41	5.0	149	4.54	5				
			93	4.03	4.5	93	4.50	5				181	4.28	4.5	181	4.73	5.5				
		40	3	7.31	7.5	3	7.94	8.5			40	115	7.74	8.5	115	7.70	8				
			43	7.28	7.5	43	7.79	8				147	7.71	8.0	147	7.67	8				
			91	7.65	8.0	91	7.68	8				179	7.24	7.5	179	7.83	8				
		80	7	10.28	10.5	7	10.07	10.5			80	119	10.36	11.0	119	10.06	10.5				
			39	10.37	10.5	39	10.14	10.5				135	10.08	10.5	135	9.81	10				
			87	10.26	10.5	87	9.81	10				151	10.11	10.5	151	9.89	10.5				
		160	15	12.75	13.0	15	12.83	13			160	167	9.79	10.0	167	10.04	10.5				
			47	12.77	13.0	47	12.72	13				183	9.93	10.5	183	10.05	10.5				
			79	12.72	13.0	79	12.71	13				143	12.78	13.0	143	12.73	13				
		U-NII-6 (6425~6525MHz)	ax (HE)	20	97	4.17	5.0	97			4.52	5	U-NII-8 (6875~7125MHz)	ax (HE)	20	185	4.36	5.0	185	4.59	5.5
					105	4.59	5.5	105			4.62	5				209	4.38	5.0	209	4.53	5.5
				40	113	4.60	5.0	113			4.71	5			40	233	0.10	0.5	233	0.78	1
					99	7.73	8.0	99			7.82	8.5				187	7.63	8.0	187	7.88	8
				80	107	7.69	8.5	107			7.75	8			80	227	7.54	8.0	227	8.03	8.5
					103	10.20	11.0	103			9.91	10.5				199	10.13	11.0	199	10.65	11
				160	111	12.83	13.5	111			12.84	13.5			160	215	9.92	10.5	215	10.27	10.5
					111	12.83	13.5	111			12.84	13.5				207	12.75	13.0	207	12.78	13

※NR not required

WLAN 2.4G 2TX SISO (PAD Mode)									
	Frequency	Mode	BW	SISO-Main(TX1) Chain B			SISO-Aux(TX2) Chain A		
				CH	AV Power	AV Target	CH	AV Power	AV Target
DSSS/OFDM mode specified maximum output power at an antenna port	WLAN 2.4GHz	b	20	1	15.37	15.5	1	16.37	16.5
				6	15.42	15.5	6	16.39	16.5
				11	15.39	15.5	11	16.31	16.5
				12	15.28	15.5	12	16.22	16.5
				13	15.27	15.5	13	15.23	15.5
		g	20	1	15.11	15.5	1	16.13	16.5
				6	15.35	15.5	6	16.24	16.5
				11	15.05	15.5	11	16.09	16.5
				12	15.06	15.5	12	15.07	15.5
				13	11.67	12	13	11.71	12
		n (HT)	20	1	15.18	15.5	1	16.11	16.5
				6	15.22	15.5	6	16.23	16.5
				11	15.08	15.5	11	16.04	16.5
				12	15.21	15.5	12	15.06	15.5
				13	11.72	12	13	11.54	12
			40	3	15.16	15.5	3	16.07	16.5
				6	15.19	15.5	6	16.15	16.5
				9	15.11	15.5	9	15.79	16
				10	10.79	11	10	10.71	11
				11	10.84	11	11	10.86	11
		ax (HE)	20	1	15.21	15.5	1	16.16	16.5
				6	15.26	15.5	6	16.27	16.5
				11	15.23	15.5	11	16.14	16.5
				12	15.17	15.5	12	15.11	15.5
				13	11.61	12	13	11.52	12
			40	3	15.13	15.5	3	16.09	16.5
				6	15.16	15.5	6	16.12	16.5
				9	15.15	15.5	9	15.69	16
				10	10.51	11	10	10.51	11
				11	10.57	11	11	10.52	11

WLAN 5G 2TX SISO (PAD Mode)										
	Frequency	Mode	BW	SISO-Main(TX1) Chain B			SISO-Aux(TX2) Chain A			
				CH	AV Power	AV Target	CH	AV Power	AV Target	
OFDM mode specified maximum output power at an antenna port	U-NII-1 (5150~5250MHz)	a	20	36	9.34	10	36	11.47	12	
				40	9.42	10	40	11.49	12	
				44	9.51	10	44	11.45	12	
				48	9.41	10	48	11.41	12	
		n (HT)	20	36	9.30	10	36	11.35	12	
				40	9.34	10	40	11.44	12	
				44	9.42	10	44	11.36	12	
				48	9.35	10	48	11.51	12	
		40	38	9.28	10	38	11.44	12		
			46	9.36	10	46	11.39	12		
		ac(VHT)	80	42	9.88	10	42	11.84	12	
		ax (HE)	20	36	9.26	10	36	11.43	12	
				40	9.28	10	40	11.36	12	
				44	9.47	10	44	11.39	12	
				48	9.34	10	48	11.48	12	
			40	38	9.27	10	38	11.35	12	
				46	9.36	10	46	11.37	12	
				80	42	9.29	10	42	11.34	12
				U-NII-2C (5470~5725MHz)	a	20	100	9.44	10	100
		116	9.46				10	116	11.42	12
		124	9.43				10	124	11.43	12
		132	9.48				10	132	11.41	12
		140	9.37				10	140	11.38	12
		144	9.42				10	144	11.53	12
	n (HT)	20	100		9.35	10	100	11.26	12	
			116		9.41	10	116	11.38	12	
			124		9.53	10	124	11.27	12	
			132		9.48	10	132	11.25	12	
			140		9.44	10	140	11.43	12	
			144		9.49	10	144	11.45	12	
	40	102	9.46	10	102	11.46	12			
		110	9.42	10	110	11.48	12			
		126	9.56	10	126	11.32	12			
		134	9.47	10	134	11.25	12			
	80	138	9.95	10	138	11.94	12			
		106	9.96	10	106	11.95	12			
122		9.81	10	122	11.80	12				
160		114	9.46	10	114	11.43	12			
ax (HE)	20	100	9.15	10	100	11.42	12			
		116	9.24	10	116	11.41	12			
		124	9.53	10	124	11.43	12			
		132	9.49	10	132	11.45	12			
		140	9.45	10	140	11.38	12			
		144	9.47	10	144	11.44	12			
	40	102	9.28	10	102	11.25	12			
		110	9.41	10	110	11.26	12			
		126	9.46	10	126	11.23	12			
		134	9.33	10	134	11.18	12			
	80	142	9.31	10	142	11.32	12			
		138	9.63	10	138	11.21	12			
		106	9.27	10	106	11.22	12			
		122	9.53	10	122	11.26	12			
160	114	9.26	10	114	11.26	12				



WLAN 5G 2TX SISO (PAD Mode)										
OFDM mode specified maximum output power at an antenna port	Frequency	Mode	BW	SISO-Main(TX1) Chain B			SISO-Aux(TX2) Chain A			
				CH	AV Power	AV Target	CH	AV Power	AV Target	
OFDM mode specified maximum output power at an antenna port	U-NII-2A (5250~5350MHz)	a	20	52	9.39	10	52	11.43	12	
				56	9.27	10	56	11.33	12	
				60	9.21	10	60	11.28	12	
				64	9.24	10	64	11.31	12	
		n (HT)	20	52	9.43	10	52	11.48	12	
				56	9.25	10	56	11.42	12	
				60	9.22	10	60	11.45	12	
				64	9.13	10	64	11.43	12	
		40	54	9.23	10	54	11.42	12		
			62	9.24	10	62	11.38	12		
		ac (VHT)	80	58	9.92	10	58	11.91	12	
			160	50	9.22	10	50	11.35	12	
		ax (HE)	20	52	9.37	10	52	11.34	12	
				56	9.26	10	56	11.28	12	
				60	9.18	10	60	11.26	12	
				64	9.17	10	64	11.37	12	
			40	54	9.32	10	54	11.44	12	
				62	9.19	10	62	11.39	12	
			80	58	9.26	10	58	11.43	12	
			160	50	9.28	10	50	11.52	12	
		U-NII-3 (5725~5850MHz)	a	20	149	9.26	10	149	11.19	12
					157	9.19	10	157	11.31	12
					165	9.22	10	165	11.14	12
					149	9.28	10	149	11.23	12
	n (HT)		20	157	9.24	10	157	11.21	12	
				165	9.26	10	165	11.24	12	
				151	9.37	10	151	11.33	12	
				159	9.35	10	159	11.42	12	
	ac(VHT)		80	155	9.91	10	155	11.92	12	
			149	9.43	10	149	11.32	12		
	ax (HE)		20	157	9.38	10	157	11.40	12	
				165	9.34	10	165	11.25	12	
		40	151	9.30	10	151	11.18	12		
			159	9.26	10	159	11.31	12		
	155	9.31	10	155	11.17	12				
	U-NII-4 (5850~5925MHz)	a	20	169	9.33	10	169	11.45	12	
173				9.31	10	173	11.43	12		
177				9.35	10	177	11.49	12		
169				9.29	10	169	11.45	12		
n (HT)		20	173	9.32	10	173	11.41	12		
			177	9.27	10	177	11.38	12		
			167	9.36	10	167	11.41	12		
			175	9.39	10	175	11.38	12		
ac(VHT)		80	171	9.85	10	171	11.94	12		
		160	163	9.29	10	163	11.22	12		
ax (HE)		20	169	9.41	10	169	11.51	12		
			173	9.47	10	173	11.54	12		
			177	9.39	10	177	11.46	12		
			167	9.23	10	167	11.36	12		
		40	175	9.19	10	175	11.40	12		
			80	171	9.32	10	171	11.33	12	
	160	163	9.22	10	177	11.19	12			

WLAN 6G 2TX SISO (PAD Mode)																					
OFDM mode specified maximum output power at an antenna port	Frequency	Mode	BW	SISO-Main(TX1)			SISO-Aux(TX2)			Frequency	Mode	BW	SISO-Main(TX1)			SISO-Aux(TX2)					
				Chain B			Chain A						Chain B			Chain A					
				CH	AV	AV	CH	AV	AV				CH	AV	AV	CH	AV	AV	CH	AV	AV
					Power	Target		Power	Target					Power	Target		Power	Target		Power	Target
OFDM mode specified maximum output power at an antenna port	U-NII-5 (5925~6425MHz)	ax (HE)	20	1	4.37	5.0	1	4.28	5	U-NII-7 (6525~6875MHz)	ax (HE)	20	117	4.29	4.5	117	4.71	5			
				45	4.19	4.5	45	4.47	5				149	4.35	5.0	149	4.51	5			
				93	4.11	4.5	93	4.36	5				181	4.32	4.5	181	4.73	5.5			
			40	3	7.34	7.5	3	7.98	8.5			40	115	7.78	8.5	115	7.76	8			
				43	7.21	7.5	43	7.75	8				147	7.85	8.0	147	7.62	8			
				91	7.75	8.0	91	7.78	8				179	7.16	7.5	179	7.78	8			
			80	7	10.14	10.5	7	10.02	10.5			80	119	10.39	10.5	119	9.98	10.5			
				39	10.35	10.5	39	10.07	10.5				135	10.11	10.5	135	9.73	10			
				87	10.25	10.5	87	9.75	10				151	10.13	10.5	151	9.92	10.5			
			160	15	10.43	10.5	15	11.46	11.5			160	167	9.71	10.0	167	10.01	10.5			
				47	10.39	10.5	47	11.43	11.5				183	9.97	10.5	183	10.02	10.5			
				79	10.37	10.5	79	11.42	11.5				143	10.42	10.5	143	11.44	11.5			
	U-NII-6 (6425~6525MHz)	ax (HE)	20	97	4.20	5.0	97	4.43	5	U-NII-8 (6875~7125MHz)	ax (HE)	20	175	10.41	10.5	175	11.42	11.5			
				105	4.61	5.5	105	4.61	5				185	4.38	5.0	185	4.76	5.5			
				113	4.58	5.0	113	4.74	5				209	4.31	5.0	209	4.58	5.5			
			40	99	7.69	8.0	99	7.81	8.5			40	233	0.09	0.5	233	0.80	1			
				107	7.76	8.5	107	7.80	8				187	7.64	8.0	187	7.89	8			
				80	10.21	10.5	103	9.92	10.5				227	7.58	8.0	227	8.06	8.5			
			160	111	10.44	10.5	111	11.47	11.5			80	199	9.93	10.5	199	10.67	11			
													215	9.88	10.5	215	10.25	10.5			
													160	207	10.43	10.5	207	11.41	11.5		

※NR not required

BT Only Support Aux						
Bluetooth mode maximum output power	Frequency	Mode	Modulation	SISO-Aux(TX2) Chain A		
				CH	AV Power	AV Target
	BT 2.4GHz	BR	GFSK	0	10.27	10.5
39				10.33	10.5	
78				10.29	10.5	
EDR		8DPSK	0	8.99	9.5	
			39	9.08	9.5	
			78	9.07	9.5	
BLE		GFSK	0	8.36	9.0	
			19	8.81	9.0	
			39	8.94	9.0	

Test Mode : 802.11b Aux Port

Reverse Step 1	
Close Mode To Tablet Mode	
Angle(10° /Step)	Power (dBm)
0°~300°	19.08-19.29
310°	19.11
320°	19.09
330°	15.72
340°	15.79

Reverse Step 2	
Tablet Mode To Laptop Mode	
Angle(5° /Step)	Power (dBm)
340°~335°	15.56-15.80
330°	15.53
325°	15.56
320°	19.12
315°	19.09

Note: When the panel of the device is on the 0 degrees (close mode) the output power is the same as the laptop mode.

Reverse Step 3	
Laptop Mode To Tablet Mode	
Angle(1° /Step)	Power (dBm)
315°~320°	19.15-19.26
321°	19.21
322°	19.13
323°	19.15
324°	19.10
325°	15.60
326°	15.58
327°	15.57
328°	15.63
329°	15.61
330°	15.59
-	-

Reverse Step 4 & Step 5	
Tablet Mode To Open Mode	
Angle(10° /Step)	Power (dBm)
340°	15.57
350°	15.68
360°	15.71
-	-
-	-
-	-
-	-
-	-
-	-
-	-
-	-
-	-

Test Mode : 802.11b Aux Port

**Reverse Step 1**

<b>Open Mode To Tablet Mode</b>	
Angle(10° /Step)	Power (dBm)
360°~350°	15.55~15.65
340°	15.57
330°	15.58
320°	19.21
310°	19.23

**Reverse Step 2**

<b>Laptop Mode Back To Tablet Mode</b>	
Angle(5° /Step)	Power (dBm)
310°	19.17
315°	19.25
320°	19.23
325°	15.60
330°	15.63

**Reverse Step 3**

<b>Tablet Mode To Laptop Mode</b>	
Angle(1° /Step)	Power (dBm)
330°~325°	15.57-15.80
324°	15.77
323°	15.69
322°	15.67
321°	15.75
320°	19.12
319°	19.13
318°	19.13
317°	19.08
316°	19.09
315°	19.11
-	-
-	-
-	-
-	-
-	-
-	-
-	-
-	-

**Reverse Step 4 & Step 5**

<b>Laptop Mode To Close Mode</b>	
Angle(10° /Step)	Power (dBm)
310°~180°	19.25-19.10
170°	19.18
160°	19.15
150°	19.10
140°	19.16
130°	19.13
120°	19.11
110°	19.14
100°	19.13
90°	19.08
80°	19.16
70°	19.17
60°	19.09
50°	19.13
40°	19.09
30°	19.14
20°	19.12
10°	19.11
0°	19.12

Test Mode : 802.11a Aux Port

Reverse Step 1	
Close Mode To Tablet Mode	
Angle(10° /Step)	Power (dBm)
0°~300°	19.14-19.38
310°	19.30
320°	19.35
330°	11.13
340°	11.11

Reverse Step 2	
Tablet Mode To Laptop Mode	
Angle(5° /Step)	Power (dBm)
340°~335°	11.11-11.26
330°	11.19
325°	11.12
320°	19.22
315°	19.23

Note: When the panel of the device is on the 0 degrees (close mode) the output power is the same as the laptop mode.

Reverse Step 3	
Laptop Mode To Tablet Mode	
Angle(1° /Step)	Power (dBm)
315°~320°	19.21-19.33
321°	19.21
322°	19.23
323°	19.25
324°	19.24
325°	11.15
326°	11.14
327°	11.12
328°	11.15
329°	11.16
330°	11.13
-	-

Reverse Step 4 & Step 5	
Tablet Mode To Open Mode	
Angle(10° /Step)	Power (dBm)
340°	11.14
350°	11.15
360°	11.16
-	-
-	-
-	-
-	-
-	-
-	-
-	-
-	-
-	-

Test Mode : 802.11a Aux Port

**Reverse Step 1**

<b>Open Mode To Tablet Mode</b>	
Angle(10° /Step)	Power (dBm)
360°~350°	11.16
340°	11.14
330°	11.11
320°	19.18
310°	19.23

**Reverse Step 2**

<b>Laptop Mode Back To Tablet Mode</b>	
Angle(5° /Step)	Power (dBm)
310°	19.21
315°	19.24
320°	19.21
325°	11.11
330°	11.13

**Reverse Step 3**

<b>Tablet Mode To Laptop Mode</b>	
Angle(1° /Step)	Power (dBm)
330°~325°	11.11-11.16
324°	11.11
323°	11.13
322°	11.12
321°	11.17
320°	19.19
319°	19.15
318°	19.17
317°	19.22
316°	19.21
315°	19.18
-	-
-	-
-	-
-	-
-	-
-	-
-	-
-	-

**Reverse Step 4 & Step 5**

<b>Laptop Mode To Close Mode</b>	
Angle(10° /Step)	Power (dBm)
310°~180°	19.18~19.22
170°	19.18
160°	19.21
150°	19.21
140°	19.25
130°	19.21
120°	19.28
110°	19.29
100°	19.29
90°	19.24
80°	19.20
70°	19.17
60°	19.22
50°	19.22
40°	19.27
30°	19.25
20°	19.19
10°	19.16
0°	19.15

Test Mode : 802.11ax Aux Port

Reverse Step 1	
Close Mode To Tablet Mode	
Angle(10° /Step)	Power (dBm)
0°~300°	12.51-12.69
310°	12.56
320°	12.51
330°	10.53
340°	10.51

Reverse Step 2	
Tablet Mode To Laptop Mode	
Angle(5° /Step)	Power (dBm)
340°~335°	10.52-10.56
330°	10.59
325°	10.62
320°	12.58
315°	12.53

Note: When the panel of the device is on the 0 degrees (close mode) the output power is the same as the laptop mode.

Reverse Step 3	
Laptop Mode To Tablet Mode	
Angle(1° /Step)	Power (dBm)
315°~320°	12.51-12.53
321°	12.51
322°	12.53
323°	12.55
324°	12.53
325°	10.55
326°	10.54
327°	10.51
328°	10.57
329°	10.56
330°	10.53
-	-

Reverse Step 4 & Step 5	
Tablet Mode To Open Mode	
Angle(10° /Step)	Power (dBm)
340°	10.54
350°	10.55
360°	10.58
-	-
-	-
-	-
-	-
-	-
-	-
-	-
-	-
-	-



Test Mode : 802.11ax Aux Port

**Reverse Step 1**

<b>Open Mode To Tablet Mode</b>	
Angle(10° /Step)	Power (dBm)
360°~350°	10.51-10.53
340°	10.51
330°	10.55
320°	12.58
310°	12.55

**Reverse Step 2**

<b>Laptop Mode Back To Tablet Mode</b>	
Angle(5° /Step)	Power (dBm)
310°	12.51
315°	12.54
320°	12.51
325°	10.59
330°	10.53

**Reverse Step 3**

<b>Tablet Mode To Laptop Mode</b>	
Angle(1° /Step)	Power (dBm)
330°~325°	10.51-10.56
324°	10.52
323°	10.58
322°	10.52
321°	10.51
320°	12.59
319°	12.54
318°	12.59
317°	12.58
316°	12.61
315°	12.58
-	-
-	-
-	-
-	-
-	-
-	-
-	-
-	-

**Reverse Step 4 & Step 5**

<b>Laptop Mode To Close Mode</b>	
Angle(10° /Step)	Power (dBm)
310°~180°	12.55~12.62
170°	12.57
160°	12.59
150°	12.61
140°	12.54
130°	12.51
120°	12.58
110°	12.58
100°	12.59
90°	12.54
80°	12.51
70°	12.57
60°	12.52
50°	12.52
40°	12.56
30°	12.55
20°	12.54
10°	12.56
0°	12.51

**Overview of Result:**

802.11b							
Close Mode To Laptop Mode		Laptop Mode To Tablet Mode		Open Mode To Tablet Mode		Tablet Mode To Laptop Mode	
Angle	Power(dBm)	Angle	Power(dBm)	Angle	Power(dBm)	Angle	Power(dBm)
0° - 324°	19.08-19.29	325°	15.60	360° - 321°	15.55-15.80	320°	19.12

802.11a							
Close Mode To Laptop Mode		Laptop Mode To Tablet Mode		Open Mode To Tablet Mode		Tablet Mode To Laptop Mode	
Angle	Power(dBm)	Angle	Power(dBm)	Angle	Power(dBm)	Angle	Power(dBm)
0° - 324°	19.14-19.38	325°	11.15	360° - 321°	11.11-11.26	320°	19.19

802.11ax							
Close Mode To Laptop Mode		Laptop Mode To Tablet Mode		Open Mode To Tablet Mode		Tablet Mode To Laptop Mode	
Angle	Power(dBm)	Angle	Power(dBm)	Angle	Power(dBm)	Angle	Power(dBm)
0° - 324°	12.51-12.69	325°	10.55	360° - 321°	10.51-10.62	320°	12.59

## 9. Test Results

### 9.1 Test Results Summary

SAR MEASUREMENT								
Ambient Temperature (°C): 23.3±2					Relative Humidity (%): 51%			
Liquid Temperature (°C): 22.3±2					Depth of Liquid (cm): >15			
Test Position	Dist. (mm)	Frequency		Conducted Power (dBm)		SAR (W/kg)		Plot No.
		Ch.	MHz	Meas.	Tune-Up Limit	Meas-1g	Scaled-1g	
Test Mode: WLAN2.4GHz_802.11b-1M_Ant Main								
Back(NB)	25	6	2437	19.96	20	0.090	0.094	
Back(PAD)	0	6	2437	15.42	15.5	0.147	0.154	
Right-side(PAD)	0	1	2412	15.37	15.5	0.987	1.049	
Right-side(PAD)	0	6	2437	15.42	15.5	1.000	1.050	
Right-side(PAD)	0	11	2462	15.39	15.5	0.889	0.940	
Top(PAD)	0	6	2437	15.42	15.5	0.413	0.434	
Test Mode: WLAN2.4GHz_802.11b-1M_Ant Aux								
Back(NB)	25	6	2437	19.83	20	0.075	0.080	
Back(PAD)	0	6	2437	16.39	16.5	0.163	0.172	
Left-side(PAD)	0	1	2412	16.37	16.5	1.010	1.073	
Left-side(PAD)	0	6	2437	16.39	16.5	1.070	<b>1.131</b>	28
Left-side(PAD)	0	11	2462	16.31	16.5	0.958	1.032	
Top(PAD)	0	6	2437	16.39	16.5	0.492	0.520	
Test Mode: Bluetooth_BT-1M_Ant Aux								
Back(NB)	25	39	2441	10.33	10.5	0.002	0.003	
Left-side(PAD)	0	39	2441	10.33	10.5	0.101	0.136	34
Top(PAD)	0	39	2441	10.33	10.5	0.071	0.095	

Note:

- When the highest reported SAR for DSSS is adjusted by the ratio of OFDM to DSSS specified maximum output power and the adjusted SAR is  $\leq 1.2$  W/kg, SAR is not required.
- When the reported SAR of the highest measured maximum output power channel for the exposure configuration is  $\leq 0.8$  W/kg, no further SAR testing is required for 802.11b DSSS in that exposure configuration.

SAR MEASUREMENT								
Ambient Temperature (°C): 23.1±2					Relative Humidity (%):50 %			
Liquid Temperature (°C): 22.1 ±2					Depth of Liquid (cm): >15			
Test Position	Dist. (mm)	Frequency		Conducted Power (dBm)		SAR (W/kg)		Plot No.
		Ch.	MHz	Meas.	Tune-Up Limit	Meas-1g	Scaled-1g	
Test Mode: WLAN5GHz_802.11n40-HT0_Ant Main								
Back(NB)	25	54	5270	19.94	20	0.074	0.077	
Test Mode: WLAN5GHz_802.11ac80-VHT0_Ant Main								
Back(PAD)	0	58	5290	9.92	10	0.144	0.150	
Right-side(PAD)	0	58	5290	9.92	10	0.632	0.657	
Top(PAD)	0	58	5290	9.92	10	0.072	0.075	
Test Mode: WLAN5GHz_802.11n40-HT0_Ant Aux								
Back(NB)	25	54	5270	19.96	20	0.068	0.070	
Test Mode: WLAN5GHz_802.11ac80-VHT0_Ant Aux								
Back(PAD)	0	58	5290	11.91	12	0.149	0.155	
Left-side(PAD)	0	58	5290	11.91	12	0.837	0.872	11
Top(PAD)	0	58	5290	11.91	12	0.137	0.143	
Test Mode: WLAN5GHz_802.11ac80-VHT0_Ant Main								
Back(NB)	25	138	5690	19.92	20	0.097	0.100	
Back(PAD)	0	106	5530	9.96	10	0.237	0.244	
Right-side(PAD)	0	106	5530	9.96	10	0.977	1.006	9
Right-side(PAD)	0	122	5610	9.81	10	0.925	0.986	
Right-side(PAD)	0	138	5690	9.95	10	0.859	0.886	
Top(PAD)	0	106	5530	9.96	10	0.112	0.115	
Test Mode: WLAN5GHz_802.11ac80-VHT0_Ant Aux								
Back(NB)	25	138	5690	19.91	20	0.072	0.075	
Back(PAD)	0	106	5530	11.95	12	0.196	0.202	
Left-side(PAD)	0	106	5530	11.95	12	0.927	0.956	
Left-side(PAD)	0	122	5610	11.80	12	0.810	0.865	
Left-side(PAD)	0	138	5690	11.94	12	0.972	1.005	
Top(PAD)	0	106	5530	11.95	12	0.165	0.170	
Test Mode: WLAN5GHz_802.11ac80-VHT0_Ant Main								
Back(NB)	25	155	5775	19.96	20	0.081	0.083	
Back(NB)	25	171	5855	19.93	20	0.091	0.094	
Back(PAD)	0	155	5775	9.91	10	0.016	0.017	
Back(PAD)	0	171	5855	9.85	10	0.022	0.023	
Right-side(PAD)	0	155	5775	9.91	10	0.879	0.915	
Right-side(PAD)	0	171	5855	9.85	10	0.807	0.852	
Top(PAD)	0	155	5775	9.91	10	0.095	0.099	
Top(PAD)	0	171	5855	9.85	10	0.154	0.163	
Test Mode: WLAN5GHz_802.11ac80-VHT0_Ant Aux								
Back(NB)	25	155	5775	19.89	20	0.050	0.053	
Back(NB)	25	171	5855	19.88	20	0.033	0.035	
Back(PAD)	0	155	5775	11.92	12	0.025	0.026	
Back(PAD)	0	171	5855	11.94	12	0.017	0.018	
Left-side(PAD)	0	155	5775	11.92	12	0.962	0.999	13
Left-side(PAD)	0	171	5855	11.94	12	0.793	0.820	
Top(PAD)	0	155	5775	11.92	12	0.165	0.171	
Top(PAD)	0	171	5855	11.94	12	0.171	0.177	

Note:

1. When the reported SAR of the highest measured maximum output power channel for the exposure configuration is  $\leq 0.8$  W/kg, no further SAR testing is required for 802.11b DSSS in that exposure configuration.
2. When multiple transmission modes have the same specified maximum output power, largest channel bandwidth, lowest order modulation and lowest data rate, the lowest order 802.11 mode is selected.
3. When the reported SAR of the highest measured maximum U-NII-2A for the exposure configuration is  $\leq 1.2$  W/kg, SAR is not required for U-NII-1 band.

SAR MEASUREMENT									
Ambient Temperature (°C): 23.4 ±2					Relative Humidity (%): 52%				
Liquid Temperature (°C): 22.4±2					Depth of Liquid (cm): >15				
Test Position	Dist. (mm)	Frequency		Conducted Power (dBm)		SAR (W/kg)		APD (W/m <sup>2</sup> )	Plot No.
		Ch.	MHz	Meas.	Tune-Up Limit	Meas-1g	Scaled-1g	Meas-4cm <sup>2</sup>	
Test Mode: WLAN6GHz_802.11ax160-HE0_Ant Main									
Back(NB)	25	111	6505	12.83	13.5	0.012	0.014	0.089	
Back(PAD)	0	111	6505	10.44	10.5	0.027	0.028	0.212	
Right-side(PAD)	0	15	6025	10.43	10.5	0.968	<b>1.003</b>	5.140	14
Right-side(PAD)	0	47	6185	10.39	10.5	0.848	0.887	4.420	
Right-side(PAD)	0	111	6505	10.44	10.5	0.837	0.866	4.310	
Right-side(PAD)	0	175	6825	10.41	10.5	0.714	0.744	3.740	
Right-side(PAD)	0	207	6985	10.43	10.5	0.524	0.543	2.540	
Top(PAD)	0	111	6505	10.44	10.5	0.171	0.177	0.958	
Test Mode: WLAN6GHz_802.11ax160-HE0_Ant Aux									
Back(NB)	25	111	6505	12.84	13.5	0.015	0.018	0.118	
Back(PAD)	0	111	6505	11.47	11.5	0.022	0.023	0.163	
Left-side(PAD)	0	15	6025	11.46	11.5	0.858	0.883	4.610	
Left-side(PAD)	0	47	6185	11.43	11.5	0.836	0.867	4.480	
Left-side(PAD)	0	111	6505	11.47	11.5	0.837	0.860	4.330	
Left-side(PAD)	0	175	6825	11.42	11.5	0.649	0.674	3.400	
Left-side(PAD)	0	207	6985	11.41	11.5	0.583	0.607	2.940	
Top(PAD)	0	111	6505	11.47	11.5	0.148	0.152	0.892	

Note:

1. When the reported SAR of the highest measured maximum output power channel for the exposure configuration is ≤ 0.8 W/kg, no further SAR testing is required for 802.11b DSSS in that exposure configuration.
2. When multiple transmission modes have the same specified maximum output power, largest channel bandwidth, lowest order modulation and lowest data rate, the lowest order 802.11 mode is selected.

PD MEASUREMENT											
Ambient Temperature (°C): 23.4±2						Relative Humidity (%): 52%					
Test Position	Dist. (mm)	Frequency		Conducted Power (dBm)		psPDn+ (W/m²)		psPDtot+ (W/m²)		Uncertainty	Plot No.
		Ch.	MHz	Meas.	Tune-Up Limit	Meas-4cm²	Scaled-4cm²	Meas-4cm²	Scaled-4cm²	Uncertainty Scaling Factor	
Test Mode: WLAN6GHz_802.11ax160-HE0_Ant Main											
Right-side(PAD)	0	15	6025	10.43	10.5	3.230	5.190	3.620	<b>5.816</b>	1.550	1
Right-side(PAD)	0	47	6185	10.39	10.5	2.710	4.394	3.020	4.897	1.550	
Right-side(PAD)	0	111	6505	10.44	10.5	2.540	4.072	3.250	5.210	1.550	
Right-side(PAD)	0	175	6825	10.41	10.5	2.710	4.374	3.120	5.036	1.550	
Test Mode: WLAN6GHz_802.11ax160-HE0_Ant Aux											
Left-side(PAD)	0	207	6985	11.41	11.5	1.970	3.180	2.380	3.842	1.550	

Note: Per WLAN 6 GHz interim test procedure in Oct. 2020 TCBS Workshop notes. At least 5 channels for BW 160MHz should be tested.

## 9.2 Simultaneous Transmission

Simultaneous Transmission Configurations	
1	WLAN 2.4 GHz ANT Main + Bluetooth Aux
2	WLAN 2.4 GHz ANT Main + WLAN 2.4 GHz ANT Aux
3	WLAN 5 GHz ANT Main + Bluetooth Aux
4	WLAN 5 GHz ANT Main + WLAN 5 GHz ANT Aux
5	WLAN 5 GHz ANT Main + WLAN 5 GHz ANT Aux + Bluetooth Aux
6	WLAN 6 GHz ANT Main + Bluetooth Aux
7	WLAN 6 GHz ANT Main + WLAN 6 GHz ANT Aux
8	WLAN 6 GHz ANT Main + WLAN 6 GHz ANT Aux + Bluetooth Aux

### 9.2.1 Simultaneous transmission test exclusion considerations

Test Position	1	2	3	4	5	6	7	1+7	1+2	3+7	3+4	3+4+7	5+7	5+6	5+6+7
	WLAN2.4G Hz ANT Main (W/kg)	WLAN2.4G Hz ANT Aux (W/kg)	WLAN5GH z ANT Main (W/kg)	WLAN5GH z ANT Aux (W/kg)	WLAN6GH z ANT Main (W/kg)	WLAN6GH z ANT Aux (W/kg)	Bluetooth ANT Aux (W/kg)	Σ 1-g SAR	Σ 1-g SAR	Σ 1-g SAR	Σ 1-g SAR	Σ 1-g SAR	Σ 1-g SAR	Σ 1-g SAR	Σ 1-g SAR
Back(NB) at 25 mm	0.094	0.080	0.100	0.075	0.014	0.018	0.003	0.097	0.174	0.103	0.175	0.178	0.017	0.032	0.035
Top(PAD) at 0 mm	0.434	0.520	0.163	0.177	0.177	0.152	0.095	0.529	0.954	0.258	0.340	0.435	0.272	0.329	0.424
Right-side(PAD) at 0 mm	1.050	-	1.006	-	1.003	-	-	1.050	1.050	1.006	1.006	1.006	1.003	1.003	1.003
Left-side(PAD) at 0 mm	-	1.131	-	1.005	-	0.883	0.136	0.136	1.131	0.136	1.005	1.141	0.136	0.883	1.019
Back(PAD) at 0 mm	0.154	0.172	0.244	0.202	0.028	0.023	-	0.154	0.326	0.244	0.446	0.446	0.028	0.051	0.051

When the sum of SAR is larger than the limit, The ratio is determined by  $(SAR1 + SAR2)^{1.5/Ri}$ , rounded to two decimal digits, and must be  $\leq 0.04$  for all antenna pairs in the configuration to qualify for 1-g SAR test exclusion.



## 10. SAR measurement variability

- 1) Repeated measurement is not required when the original highest measured SAR is  $< 0.80$  W/kg; steps 2) through 4) do not apply.
- 2) When the original highest measured SAR is  $\geq 0.80$  W/kg, repeat that measurement once.
- 3) Perform a second repeated measurement only if the ratio of largest to smallest SAR for the original and first repeated measurements is  $> 1.20$  or when the original or repeated measurement is  $\geq 1.45$  W/kg (~ 10% from the 1-g SAR limit).
- 4) Perform a third repeated measurement only if the original, first or second repeated measurement is  $\geq 1.5$  W/kg and the ratio of largest to smallest SAR for the original, first and second repeated measurements is  $> 1.20$ .

Frequency		SAR 1g (W/kg)		
Channel	MHz	Original	First Repeated	
			Value	Ratio
6	2437	1.070	1.030	1.039
106	5530	0.977	0.970	1.007
15	6025	0.968	0.948	1.021

---

**Appendix**

**Appendix A. System Check Data**

**Appendix B. Highest measurement Data**

**Appendix C. Test Setup Photographs**

**Appendix D. Probe Calibration Data**

**Appendix E. Dipole Calibration Data**

**Appendix F. Product Photos-Please refer to the file: 23A0004R-Product Photos**