



## FCC Part 15.247

### TEST REPORT

For

## Acer Incorporated

8F, 88, Sec.1, Xintai 5th Rd. Xizhi, New Taipei City 221, Taiwan

**FCC ID: HLZAMR031**

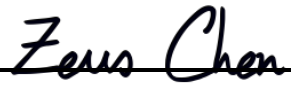
Report Type	Original Report
Product Name:	ACER MOUSE RS DONGLE
Model Name:	AMR031
Report Number :	RXZ200723002-01-00A
Report Date :	2020/08/27
Reviewed By :	Zeus Chen 
Prepared By:	Bay Area Compliance Laboratories Corp.(Linkou Laboratory) No. 6, Wende 2Rd., Guishan Dist., Taoyuan City 33382, Taiwan (R.O.C.) Tel: +886 (3)3961072; Fax: +886 (3) 3961027 www.bacl.com.tw

**Note:** This test report is prepared for the customer shown above and for the device described herein. It may not be duplicated or used in part without prior written consent from Bay Area Compliance Laboratories Corp. (Linkou Laboratory)

### Revision History

Revision	Report Number	Issue Date	Description
1.0	RXZ200723002-01-00A	2020/08/27	Original Report

**TABLE OF CONTENTS**

**1 GENERAL INFORMATION ..... 4**

1.1 PRODUCT DESCRIPTION FOR EQUIPMENT UNDER TEST (EUT) ..... 4

1.2 OPERATION CONDITION OF EUT ..... 4

1.3 OBJECTIVE AND TEST METHODOLOGY ..... 5

1.4 MEASUREMENT UNCERTAINTY ..... 5

1.5 TEST FACILITY ..... 5

**2 SYSTEM TEST CONFIGURATION..... 6**

2.1 TEST CHANNELS AND DESCRIPTION OF WORST TEST CONFIGURATION ..... 6

2.2 SUPPORT EQUIPMENT LIST AND EXTERNAL CABLE LIST..... 6

2.3 BLOCK DIAGRAM OF TEST SETUP ..... 6

2.4 DUTY CYCLE ..... 7

2.5 ENVIRONMENTAL CONDITIONS AND TEST DATE..... 7

**3 SUMMARY OF TEST RESULTS ..... 8**

**4 FCC §15.247(I), §1.1307, § 2.1093 – RF EXPOSURE ..... 9**

4.1 APPLICABLE STANDARD..... 9

4.2 RF EXPOSURE EVALUATION RESULT ..... 9

**5 FCC §15.203 - ANTENNA REQUIREMENTS .....10**

5.1 APPLICABLE STANDARD..... 10

5.2 ANTENNA LIST AND DETAILS ..... 10

**6 FCC §15.207 - AC LINE CONDUCTED EMISSIONS.....11**

6.1 APPLICABLE STANDARD..... 11

6.2 EUT SETUP AND TEST PROCEDURE ..... 11

6.3 TEST EQUIPMENT LIST AND DETAILS..... 12

6.4 TEST RESULT..... 13

**7 FCC §15.209, §15.205, §15.247(D) – SPURIOUS EMISSIONS .....14**

7.1 APPLICABLE STANDARD..... 14

7.2 EUT SETUP AND TEST PROCEDURE ..... 16

7.3 TEST EQUIPMENT LIST AND DETAILS..... 17

7.4 TEST RESULT..... 18

**8 FCC §15.247(A)(2) – 6 DB EMISSION BANDWIDTH .....22**

8.1 APPLICABLE STANDARD..... 22

8.2 TEST PROCEDURE ..... 22

8.3 TEST EQUIPMENT LIST AND DETAILS..... 22

8.4 TEST RESULTS ..... 23

**9 FCC §15.247(B) (3) – MAXIMUM OUTPUT POWER .....24**

9.1 APPLICABLE STANDARD..... 24

9.2 TEST PROCEDURE ..... 24

9.3 TEST EQUIPMENT LIST AND DETAILS..... 24

9.4 TEST RESULTS ..... 24

**10 FCC §15.247(D) – 100 KHZ BANDWIDTH OF FREQUENCY BAND EDGE .....25**

10.1 APPLICABLE STANDARD..... 25

10.2 TEST PROCEDURE ..... 25

10.3 TEST EQUIPMENT LIST AND DETAILS..... 26

10.4 TEST RESULTS ..... 26

**11 FCC §15.247(E) – POWER SPECTRAL DENSITY.....27**

11.1 APPLICABLE STANDARD..... 27

11.2 TEST PROCEDURE ..... 27

11.3 TEST EQUIPMENT LIST AND DETAILS..... 27

11.4 TEST RESULTS ..... 28

# 1 General Information

## 1.1 Product Description for Equipment under Test (EUT)

<b>Applicant</b>	<b>Acer Incorporated</b> 8F, 88, Sec.1, Xintai 5th Rd. Xizhi, New Taipei City 221, Taiwan
<b>Manufacturer</b>	<b>Acer Incorporated</b> 8F, 88, Sec.1, Xintai 5th Rd. Xizhi, New Taipei City 221, Taiwan
<b>Brand Name</b>	acer
<b>Product (Equipment)</b>	ACER MOUSE RS DONGLE
<b>Model Name</b>	AMR031
<b>Frequency Range</b>	2405 - 2474 MHz
<b>Number of Channels</b>	12 Channels
<b>Output Power</b>	-2.36 dBm (0.0006 W)
<b>Modulation Type</b>	GFSK
<b>Related Submittal(s)/Grant(s)</b>	N/A
<b>Received Date</b>	Aug 05, 2020
<b>Date of Test</b>	Aug. 07, 2020 - Aug. 12, 2020

*\*All measurement and test data in this report was gathered from production sample serial number: 200723002-01*

*Assigned by BACL, Linkou Laboratory).*

## 1.2 Operation Condition of EUT

<b>Power Operation (Voltage Range)</b>	<input type="checkbox"/> AC 120 V/60 Hz <input type="checkbox"/> Adapter <input type="checkbox"/> By Power Cord.
	<input checked="" type="checkbox"/> DC Type <input checked="" type="checkbox"/> From Host System 5Vdc <input type="checkbox"/> Battery: 1.5V <input type="checkbox"/> External from USB Cable <input type="checkbox"/> External DC Adapter

### 1.3 Objective and Test Methodology

The Objective of this Test Report was to document the compliance of the Acer Incorporated. Appliance (Model: AMR031) to the requirements of the following Standards:

- Part 2, Subpart J, Part 15, Subparts A and C, section 15.247 of the Federal Communication Commission’s rules.
- ANSI C63.10-2013 of t American National Standard of Procedures for Compliance Testing of Unlicensed Wireless Devices.

### 1.4 Measurement Uncertainty

Parameter	Expanded Measurement uncertainty
RF output power	± 1.488 dB
Occupied Channel Bandwidth	± 453.927 Hz
RF Conducted Emission test	± 2.77 dB
AC Power Line Conducted Emission	± 2.66 dB
Radiated Below 1G	± 3.57 dB
Radiated Above 1G	± 5.32 dB

The test results with statement of conformity, the decision rules are based on the specifications and standards. The test results will not take the measurement uncertainty into account.

### 1.5 Test Facility

The Test site used by Bay Area Compliance Laboratories Corp. (Linkou Laboratory) to collect test data is located on

- No.6, Wende 2Rd., Guishan Dist., Taoyuan City 33382, Taiwan (R.O.C.).

Bay Area Compliance Laboratories Corp. (Linkou Laboratory) Lab is accredited to ISO 17025 by Taiwan Accreditation Foundation (TAF code: 3546) by Mutual Recognition Agreement (MRA). The test site has been approved by the FCC under the KDB 974614 D01 and is listed in the FCC Public Access Link (PAL) database. The FCC Registration No.: 0027578244. Designation No.: TW1119. The Test Firm Registration No.: 311381. ISED#: 25102 and CAB identifier is TW3546.

## 2 System Test Configuration

### 2.1 Test Channels and Description of Worst Test Configuration

The system was configured for testing in testing mode which was provided by manufacturer.

No special accessory, No modification was made to the EUT and No special equipment used during test.

Channel	Frequency (MHz)	Channel	Frequency (MHz)
1	2405	7	2442
2	2407	8	2447
3	2418	9	2458
4	2426	10	2469
5	2430	11	2471
6	2437	12	2474

For SRD: Channel 1, 7 and 12 were tested.

Worst Case of Power Setting				
EUT Exercise Software		EMI Test		
Configuration	NTX	Low CH	Mid CH	High CH
SRD	1	4	4	4

### 2.2 Support Equipment List and External Cable List

No.	Description	Manufacturer	Model Number
1.	Notebook	DELL	Latitude E5550

### 2.3 Block Diagram of Test Setup

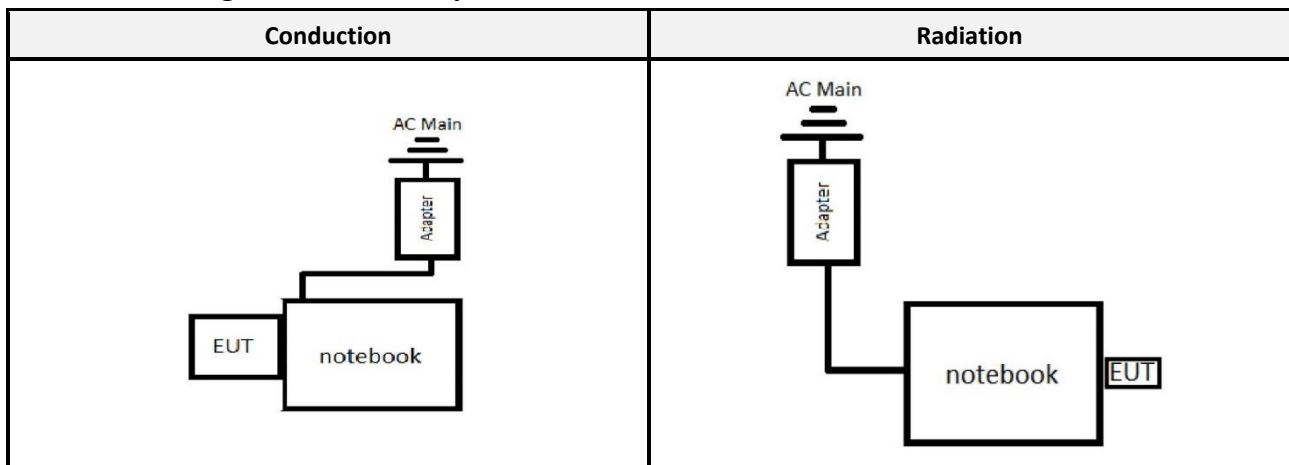

## 2.4 Duty Cycle

All measurements are to be performed with the EUT transmitting at 100% duty cycle at its maximum power control level; however, if 100% duty cycle cannot be achieved, measurements of duty cycle, x, and maximum power transmission duration, T, are required for each tested mode of operation.

Configuration	On Time (ms)	Period (ms)	Duty Cycle (%)	Duty Factor (dB)
SRD	0.44	0.55	80.00	0.97

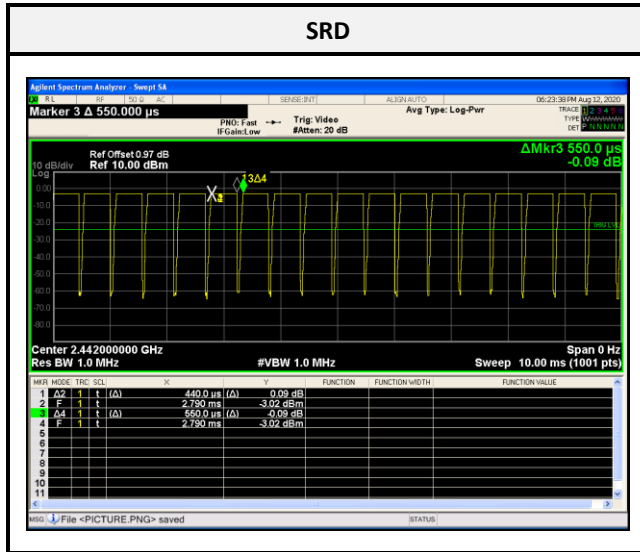

\*Note: Duty Factor = 10\*log (1/Duty cycle)

## 2.5 Environmental Conditions and Test Date

Test Site	Test Date	Temperature (°C)	Relative Humidity (% RH)	Test Engineer
Conduction (Con-01)	Aug. 10, 2020	25.4	58	Blake Wang
Radiated (966A)	Aug. 07, 2020	21.8	53	Leo Cheng
Conducted (TH-02)	Aug. 12, 2020	22.5	60	Ethan Shao

### 3 Summary of Test Results

FCC Rules	Description of Test	Result
§15.247(i), §1.1307, § 2.1093	RF Exposure	Compliance
§15.203	Antenna Requirement	Compliance
§15.207(a)	AC Line Conducted Emissions	Compliance
§15.205, §15.209, §15.247(d)	Spurious Emissions	Compliance
§15.247(a)(2)	6 dB Emission Bandwidth	Compliance
§15.247(b)(3)	Maximum Peak Output Power	Compliance
§15.247(d)	100 kHz Bandwidth of Frequency Band Edge	Compliance
§15.247(e)	Power Spectral Density	Compliance



## 4 FCC §15.247(i), §1.1307, § 2.1093 – RF Exposure

### 4.1 Applicable Standard

According to FCC §2.1093 and §1.1307(b) (1), systems operating under the provisions of this section shall be operated in a manner that ensure that the public is not exposed to radio frequency energy level in excess of the Commission’s guideline.

According to KDB 447498 D01 General RF Exposure Guidance v06

The 1-g and 10-g SAR test exclusion thresholds for 100 MHz to 6 GHz at test separation distances ≤ 50 mm are determined by:

$$[(\text{max. power of channel, including tune-up tolerance, mW})/(\text{min. test separation distance, mm})] \cdot$$

$$[\sqrt{f(\text{GHz})}] \leq 3.0 \text{ for 1-g SAR and } \leq 7.5 \text{ for 10-g extremity SAR, where}$$

1. f(GHz) is the RF channel transmit frequency in GHz.
2. Power and distance are rounded to the nearest mW and mm before calculation.
3. The result is rounded to one decimal place for comparison.
4. 3.0 and 7.5 are referred to as the numeric thresholds in the step 2 below

The test exclusions are applicable only when the minimum test separation distance is ≤ 50 mm, and for transmission frequencies between 100 MHz and 6 GHz. When the minimum test separation distance is < 5 mm, a distance of 5 mm according to 4.1 f) is applied to determine SAR test exclusion.

### 4.2 RF Exposure Evaluation Result

**RF Exposure Evaluation:**

Frequency (MHz)	Turn-up Power		Evaluation Distance (mm)	SAR Exclusion Result	Extremity SAR Exclusion Limit (1-g SAR)
	(dBm)	(mW)			
2405-2474	-2.00	0.631	5	0.2008	3

**Result:** SAR evaluation is not necessary.

## 5 FCC §15.203 - Antenna Requirements

### 5.1 Applicable Standard

According to § 15.203, an intentional radiator shall be designed to ensure that no antenna other than that furnished by the responsible party shall be used with the device. The use of a permanently attached antenna or of an antenna that uses a unique coupling to the intentional radiator shall be considered sufficient to comply with the provisions of this section. The manufacturer may design the unit so that a broken antenna can be replaced by the user, but the user of a standard antenna jack or electrical connector is prohibited.

And according to FCC 47 CFR section 15.247 (b), if the transmitting antennas of directional gain greater than 6dBi are used, the power shall be reduced by the amount in dB that the directional gain of the antenna does not exceed 6dBi

### 5.2 Antenna List and Details

Antenna Type	Brand	Model	Antenna Gain	Result
PCB Antenna	acer	AMR031	-3.28 dBi	Compliance

*The EUT has an internal dedicated antennas arrangement, fulfill the requirement of this section.*

## 6 FCC §15.207 - AC Line Conducted Emissions

### 6.1 Applicable Standard

According to FCC §15.207,

For an intentional radiator that is designed to be connected to the public utility (AC) power line, the radio frequency voltage that is conducted back onto the AC power line on any frequency or frequencies within the band 150 kHz to 30 MHz shall not exceed the limits in the following table, as measured using a 50 μH/50 ohms line impedance stabilization network (LISN). Compliance with the provisions of this paragraph shall be based on the measurement of the radio frequency voltage between each power line and ground at the power terminal. The lower limit applies at the boundary between the frequencies ranges.

Frequency (MHz)	Conducted Limit (dBuV)	
	Quasi-Peak	Average
0.15-0.5	66 to 56 <sup>Note 1</sup>	56 to 46 <sup>Note 2</sup>
0.5-5	56	46
5-30	60	50

Note 1: Decreases with the logarithm of the frequency. Note 2: A linear average detector is required

### 6.2 EUT Setup and Test Procedure

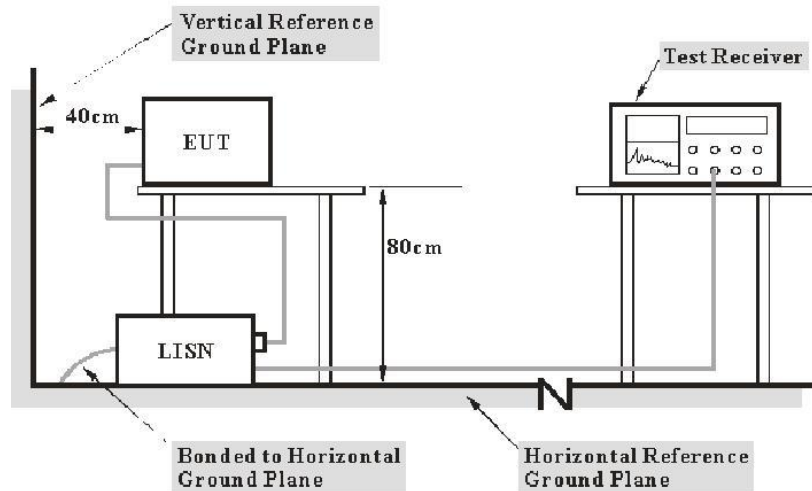

- Note: 1. Support units were connected to second LISN.  
 2. Both of LISNs (AMN) 80 cm from EUT and at the least 80 cm from other units and other metal planes support units.

The setup of EUT is according with per ANSI C63.10-2013 measurement procedure. The specification used was with the FCC Part 15.207 limits

The EMI test receiver was set to investigate the spectrum from 150 kHz to 30 MHz. During the conducted emission test, the EMI test receiver was set with the following configurations

Frequency Range	Receiver RBW
150 kHz - 30 MHz	9 kHz

During the conducted emission test, the adapter was connected to the outlet of the LISN. Maximizing procedure was performed on the six (6) highest emissions of the EUT. All data was recorded in the Quasi-peak and average detection mode.

### 6.3 Test Equipment List and Details

Description	Manufacture	Model	Serial No.	Cal. Date.	Cal. Due.
<b>AC Line Conduction Room (CON-01)</b>					
LISN	Rohde & Schwarz	ENV216	100010	2019/09/02	2020/09/01
EMI Test Receiver	Rohde & Schwarz	ESR3	102430	2020/05/07	2021/05/06
Pulse Limiter	SCHWARZBECK	VSTD 9561-F	00432	2019/08/28	2020/08/27
RF Cable	EMCI	EMCCFD300-BM-BM-8000	180526	2020/08/07	2021/08/06
Software	Audix	e3 v9	E3LK-03	N.C.R	N.C.R

**\*Statement of Traceability:** The testing equipment's listed above have finished the calibration by Electronics Testing Center, Taiwan (ETC) or other laboratories which were accredited by TAF or equivalent organizations. The calibration result could be traceable to the International System of Units (SI).

### 6.4 Test Result

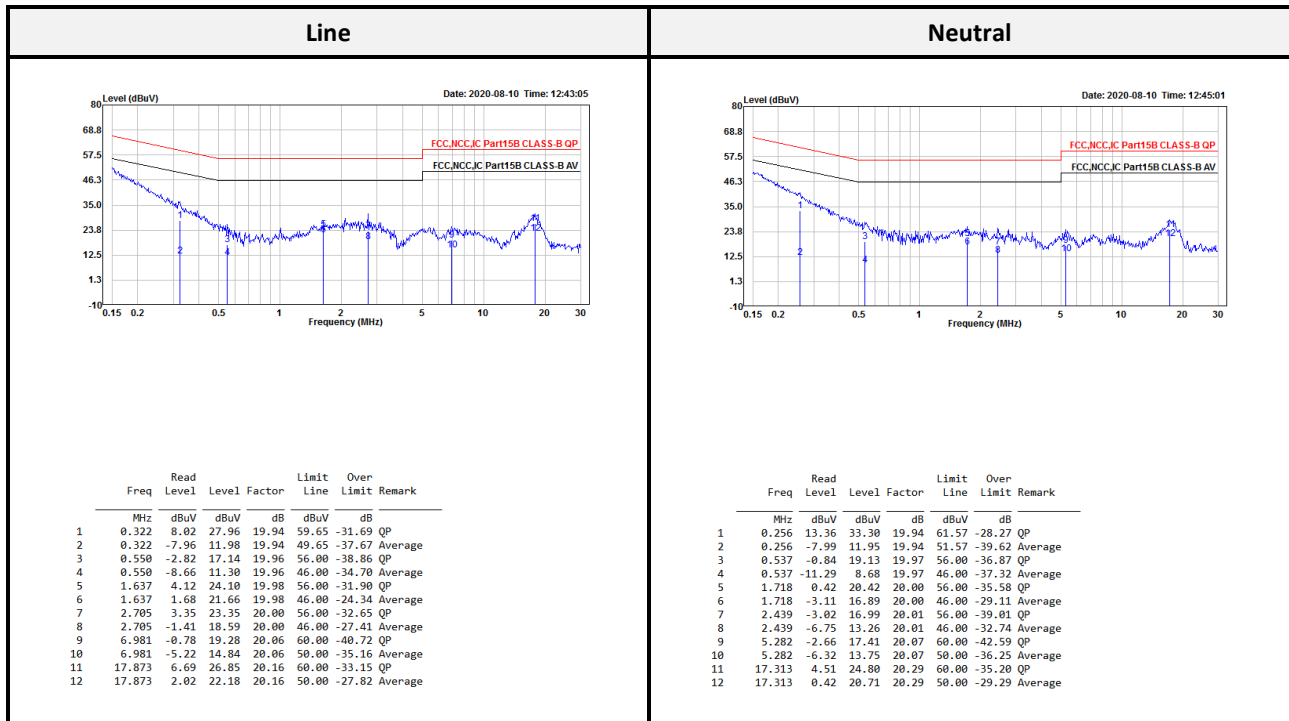

Note1: Transmit mode

Note2:

$Level = Read\ Level + Factor$

$Over\ Limit\ (Margin) = Level - Limit\ Line$

$Factor = (LISN, ISN, PLC\ or\ current\ probe)\ Factor + Cable\ Loss + Attenuator$

## 7 FCC §15.209, §15.205, §15.247(d) – Spurious Emissions

### 7.1 Applicable Standard

As per FCC §15.35(d): Unless otherwise specified, on any frequency or frequencies above 1000 MHz, the radiated emission limits are based on the use of measurement instrumentation employing an average detector function.

Unless otherwise specified, measurements above 1000 MHz shall be performed using a minimum resolution bandwidth of 1MHz.

As Per FCC §15.205(a) except as show in paragraph (d) of this section, only spurious emissions are permitted in any of the frequency bands listed below:

MHz	MHz	MHz	GHz
0.090-0.110	13.36-13.41	399.9-410	4.5-5.15
0.495-0.505	16.42-16.423	608-614	5.35-5.46
2.1735-2.1905	16.69475-16.69525	960-1240	7.25-7.75
4.125-4.128	25.5-25.67	1300-1427	8.025-8.5
4.17725-4.17775	37.5-38.25	1435-1626.5	9.0-9.2
4.20725-4.20775	73-74.6	1645.5-1646.5	9.3-9.5
6.215-6.218	74.8-75.2	1660-1710	10.6-12.7
6.26775-6.26825	108-121.94	1718.8-1722.2	13.25-13.4
6.31175-6.31225	123-138	2200-2300	14.47-14.5
8.291-8.294	149.9-150.05	2310-2390	15.35-16.2
8.362-8.366	156.52475-156.52525	2483.5-2500	17.7-21.4
8.37625-8.38675	156.7-156.9	2690-2900	22.01-23.12
8.41425-8.41475	162.0125-167.17	3260-3267	23.6-24.0
12.29-12.293	167.72-173.2	3332-3339	31.2-31.8
12.51975-12.52025	240-285	3345.8-3358	36.43-36.5
12.57675-12.57725	322-335.4	3600-4400	Above 38.6

As per FCC §15.209(a): Except as provided elsewhere in this Subpart, the emissions from an intentional radiator shall not exceed the field strength levels specified in the following table:

Frequency (MHz)	Field Strength (micro volts/meter)	Measurement Distance (meters)
0.009 - 0.490	2400/F(kHz)	300
0.490 - 1.705	24000/F(kHz)	30
1.705 - 30.0	30	30
30 - 88	100**	3
88 - 216	150**	3
216 - 960	200**	3
Above 960	500	3

\*\* Except as provided in paragraph (g), fundamental emissions from intentional radiators operating under this Section shall not be located in the frequency bands 54-72 MHz, 76-88 MHz, 174-216 MHz or 470-806MHz. However, operation within these frequency bands is permitted under other sections of this Part, e.g., Sections 15.231 and 15.241.

As per FCC §15.247 (d) In any 100 kHz bandwidth outside the frequency band in which the spread spectrum or digitally modulated intentional radiator is operating, the radio frequency power that is produced by the intentional radiator shall be at least 20 dB below that in the 100 kHz bandwidth within the band that contains the highest level of the desired power, based on either an RF conducted or a radiated measurement, provided the transmitter demonstrates compliance with the peak conducted power limits. If the transmitter complies with the conducted power limits based on the use of RMS averaging over a time interval, as permitted under paragraph (b)(3) of this section, the attenuation required under this paragraph shall be 30 dB instead of 20dB. Attenuation below the general limits specified in §15.209(a) is not required. In addition, radiated emissions which fall in the restricted bands, as defined in §15.205(a), must also comply with the radiated emission limits specified in §15.209(a) (see §15.205(c)).

## 7.2 EUT Setup and Test Procedure

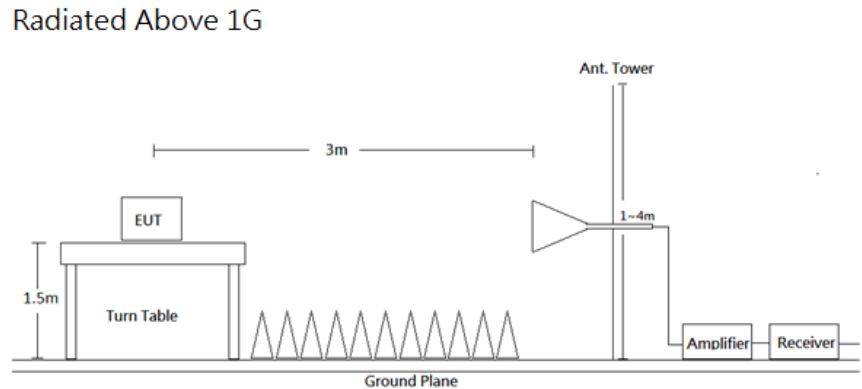
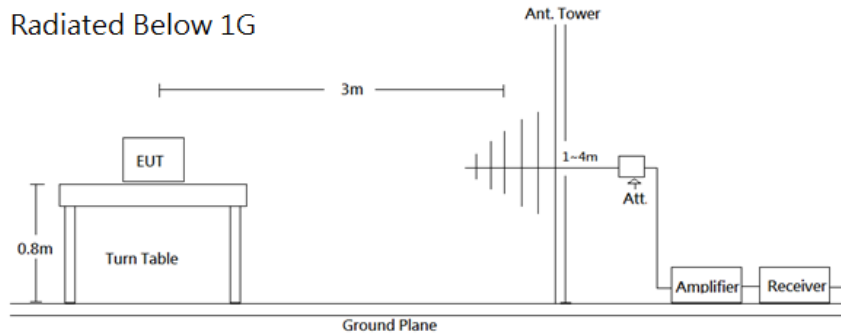

Radiated emission tests were performed in the 3 meters chamber test site, using the setup accordance with the ANSI C63.10-2013. The specification used was the FCC Part 15.209 and FCC 15.247 Limits.

The system was investigated from 30 MHz to 26.5 GHz. During the radiated emission test, the EMI test receiver was set with the following configurations measurement method 6.3 in ANSI C63.10.

Frequency Range	RBW	VBW	Duty cycle	Measurement method
30-1000 MHz	120 kHz	/	-	QP
Above 1 GHz	1 MHz	3 MHz	-	PK
	1 MHz	10 Hz	>98%	Ave
	1 MHz	1/T	<98%	Ave

Maximizing procedure was performed on the highest emissions to ensure that the EUT complied with all installation combinations. All data was recorded in the Quasi-peak detector mode from 30 MHz to 1 GHz and PK and average detector modes for frequencies above 1 GHz.



### 7.3 Test Equipment List and Details

Description	Manufacture	Model	Serial No.	Cal. Date.	Cal. Due.
<b>Radiation 3M Room (966A)</b>					
Active Loop	EMCO	6502	0001-3322	2020/03/16	2021/03/15
Bilog Antenna/6 dB Attenuator	SUNOL SCIENCES & EMEC /EMCI	JB3/N-6-06	A111513/AT-N0668	2020/03/19	2021/03/18
Horn Antenna	ETS-Lindgren	3115	00085775	2019/09/11	2020/09/10
Horn Antenna	ETS-Lindgren	3160-09	00123853	2019/09/12	2020/09/11
Preamplifier	A.H. Systems	PAM-0118	470	2020/03/16	2021/03/15
Preamplifier	A.H. Systems	PAM-1840VH	174	2020/03/25	2021/03/24
Signal Analyzer 40GHZ	Rohde & Schwarz	FSV40-N	102248	2019/09/11	2020/09/10
Microflex Cable (1m)	EMCI	EMC106-SM-SM-2000	180515	2020/08/06	2021/08/05
Microflex Cable (2m)	MTJ	H0919	00000-MT28A-100	2020/08/06	2021/08/05
Microflex Cable (8m)	UTIFLEX	UFA210A-1-3149-300300	MFR 64639 232490-001	2020/08/06	2021/08/05
Turn Table	Chaintek	T-200-S-1	003501	N.C.R	N.C.R
Antenna Tower	Chaintek	MBD-400-1	003504	N.C.R	N.C.R
Controller	Chaintek	3000-1	003507	N.C.R	N.C.R
Software	Audix	e3 v9	E3LK-01	N.C.R	N.C.R
<b>Conducted Room (TH-02)</b>					
Signal Analyzer 40GHZ	Rohde & Schwarz	FSV40-N	102248	2019/09/11	2020/09/10
RF Cable	MTJ	MT40S	MT40S-001	Each Use	/

**\*Statement of Traceability:** The testing equipment's listed above have finished the calibration by Electronics Testing Center, Taiwan (ETC) or other laboratories which were accredited by TAF or equivalent organizations. The calibration result could be traceable to the International System of Units (SI).

### 7.4 Test Result

#### Below 1G (30 MHz-1 GHz)

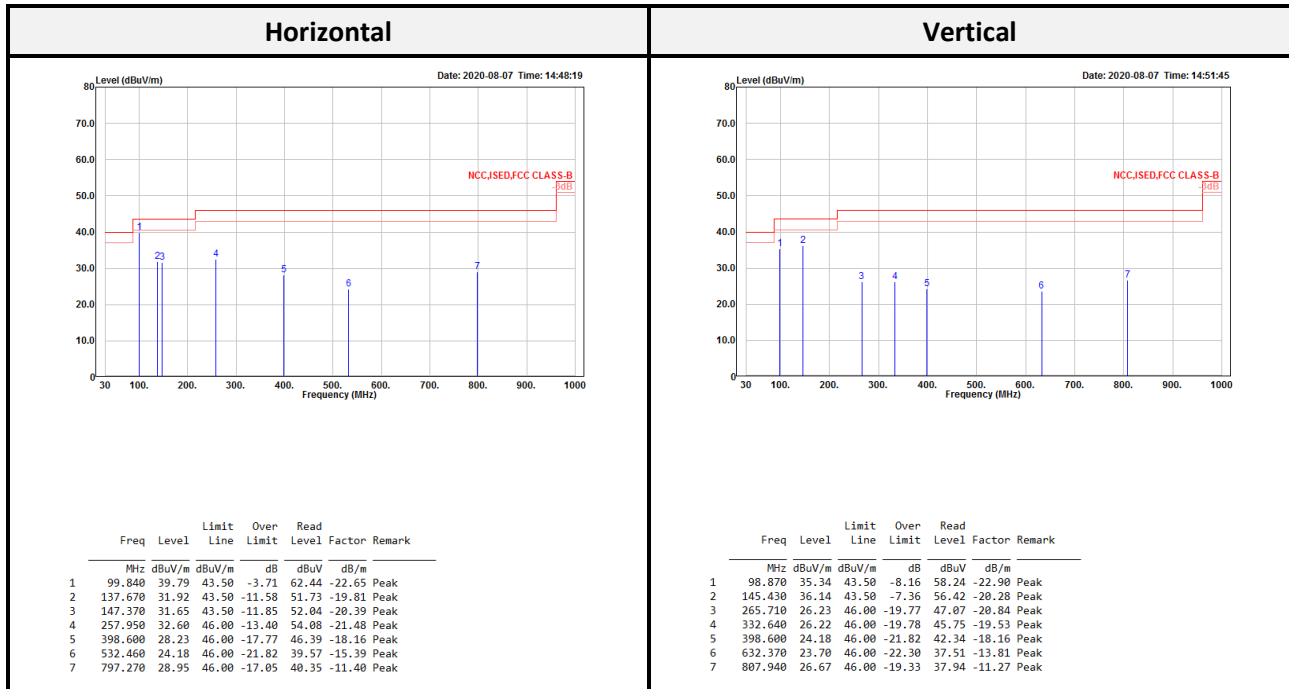

Result = Reading + Correct Factor

Margin = Result – Limit

Correct Factor = Antenna Factor + Cable Loss – Amplifier Gain

Spurious emissions more than 20 dB below the limit were not reported

**Above 1G (1 GHz-26.5 GHz)**

Low CH													
Horizontal							Vertical						
Freq	Level	Limit Line	Over Limit	Read Level	Factor	Remark	Freq	Level	Limit Line	Over Limit	Read Level	Factor	Remark
MHz	dBuV/m	dBuV/m	dB	dBuV	dB/m		MHz	dBuV/m	dBuV/m	dB	dBuV	dB/m	
2389.300	33.46	54.00	-20.54	42.70	-9.24	Average	2387.800	31.85	54.00	-22.15	41.10	-9.25	Average
2389.300	49.62	74.00	-24.38	58.86	-9.24	Peak	2387.800	47.59	74.00	-26.41	56.84	-9.25	Peak
2405.300	88.40			97.58	-9.18	Average	2405.100	82.76			91.94	-9.18	Average
2405.300	94.02			103.20	-9.18	Peak	2405.100	88.21			97.39	-9.18	Peak
4810.000	40.14	54.00	-13.86	42.86	-2.72	Average	4810.000	30.98	54.00	-23.02	33.70	-2.72	Average
4810.000	48.03	74.00	-25.97	50.75	-2.72	Peak	4810.000	43.58	74.00	-30.42	46.30	-2.72	Peak
7215.000	50.21	54.00	-3.79	47.81	2.40	Average	7215.000	38.17	54.00	-15.83	35.77	2.40	Average
7215.000	56.96	74.00	-17.04	54.56	2.40	Peak	7215.000	48.99	74.00	-25.01	46.59	2.40	Peak

Middle CH													
Horizontal							Vertical						
Freq	Level	Limit Line	Over Limit	Read Level	Factor	Remark	Freq	Level	Limit Line	Over Limit	Read Level	Factor	Remark
MHz	dBuV/m	dBuV/m	dB	dBuV	dB/m		MHz	dBuV/m	dBuV/m	dB	dBuV	dB/m	
2367.112	33.25	54.00	-20.75	42.59	-9.34	Average	2385.262	31.57	54.00	-22.43	40.84	-9.27	Average
2367.112	45.32	74.00	-28.68	54.66	-9.34	Peak	2385.262	45.66	74.00	-28.34	54.93	-9.27	Peak
2442.374	88.91			97.93	-9.02	Average	2442.132	83.31			92.34	-9.03	Average
2442.374	94.46			103.48	-9.02	Peak	2442.132	88.45			97.48	-9.03	Peak
2506.262	34.36	54.00	-19.64	43.11	-8.75	Average	2491.258	32.76	54.00	-21.24	41.57	-8.81	Average
2506.262	46.54	74.00	-27.46	55.29	-8.75	Peak	2491.258	46.08	74.00	-27.92	54.89	-8.81	Peak
4884.000	42.89	54.00	-11.11	45.38	-2.49	Average	4884.000	33.30	54.00	-20.70	35.79	-2.49	Average
4884.000	49.95	74.00	-24.05	52.44	-2.49	Peak	4884.000	44.15	74.00	-29.85	46.64	-2.49	Peak
7326.000	51.09	54.00	-2.91	48.32	2.77	Average	7326.000	40.09	54.00	-13.91	37.32	2.77	Average
7326.000	58.51	74.00	-15.49	55.74	2.77	Peak	7326.000	49.64	74.00	-24.36	46.87	2.77	Peak

High CH													
Horizontal							Vertical						
Freq	Level	Limit Line	Over Limit	Read Level	Factor	Remark	Freq	Level	Limit Line	Over Limit	Read Level	Factor	Remark
MHz	dBuV/m	dBuV/m	dB	dBuV	dB/m		MHz	dBuV/m	dBuV/m	dB	dBuV	dB/m	
2474.018	89.23			98.11	-8.88	Average	2473.936	83.32			92.20	-8.88	Average
2474.018	94.74			103.62	-8.88	Peak	2473.936	88.51			97.39	-8.88	Peak
2483.694	34.45	54.00	-19.55	43.29	-8.84	Average	2485.416	32.55	54.00	-21.45	41.39	-8.84	Average
2483.694	55.06	74.00	-18.94	63.90	-8.84	Peak	2485.416	51.05	74.00	-22.95	59.89	-8.84	Peak
4948.000	43.63	54.00	-10.37	45.89	-2.26	Average	4948.000	38.10	54.00	-15.90	40.36	-2.26	Average
4948.000	51.29	74.00	-22.71	53.55	-2.26	Peak	4948.000	47.34	74.00	-26.66	49.60	-2.26	Peak
7422.000	53.08	54.00	-0.92	49.98	3.10	Average	7422.000	41.80	54.00	-12.20	38.70	3.10	Average
7422.000	60.82	74.00	-13.18	57.72	3.10	Peak	7422.000	51.34	74.00	-22.66	48.24	3.10	Peak

**Above 1G (1 GHz-26.5 GHz)**

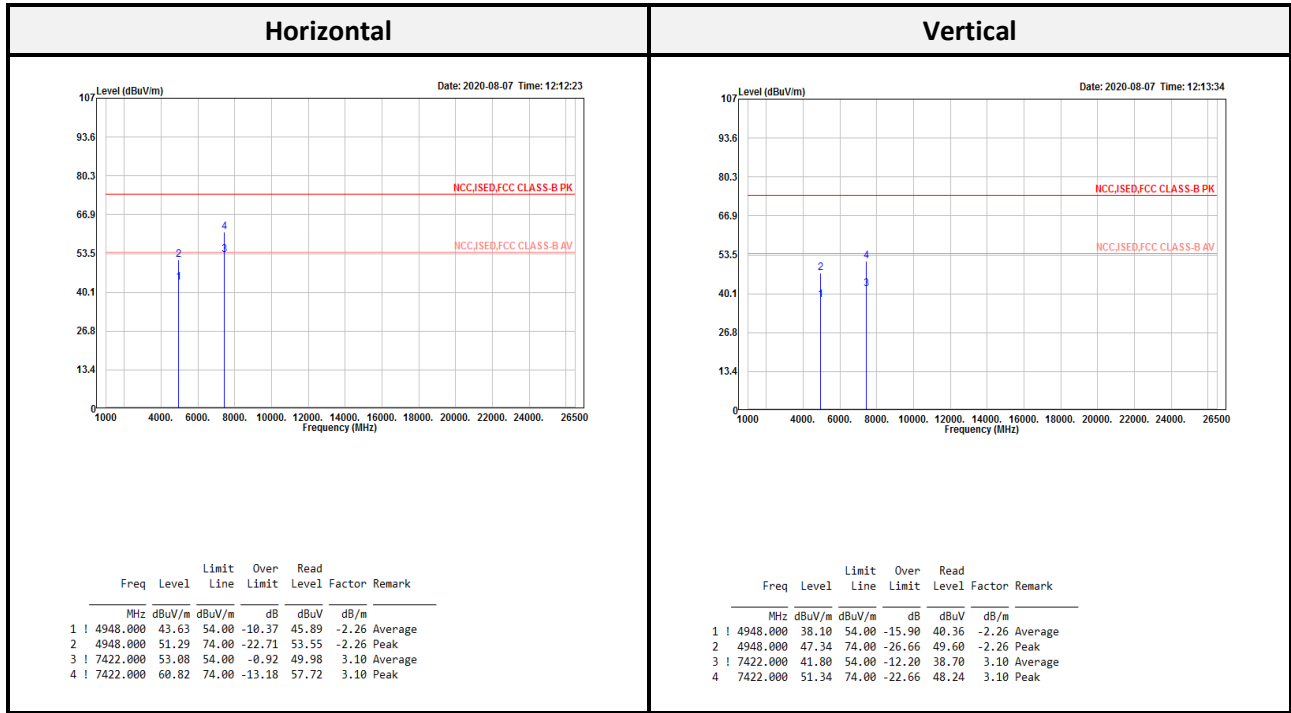

*Level = Read Level + Factor*

*Over Limit = Level – Limit*

*Correct Factor = Antenna Factor + Cable Loss – Amplifier Gain*

*Spurious emissions more than 20 dB below the limit were not reported*

**Conducted Spurious Emissions:**

Configuration	Channel	Frequency (MHz)	Delta Peak to Band Emission (dBc)	Limit (dBc)	Result
SRD	Low	2405	42.95	≥ 20	Compliance
	Mid	2442	38.67	≥ 20	Compliance
	High	2474	37.40	≥ 20	Compliance



## 8 FCC §15.247(a)(2) – 6 dB Emission Bandwidth

### 8.1 Applicable Standard

According to FCC §15.247(a) (2),

Systems using digital modulation techniques may operate in the 902–928 MHz, 2400–2483.5 MHz, and 5725–5850 MHz bands. The minimum 6 dB bandwidth shall be at least 500 kHz.

### 8.2 Test Procedure

According to ANSI C63.10-2013, the steps for the first option are as follows:

- (1) Set RBW = 100 kHz. (2) Set the VBW  $\geq [3 \times \text{RBW}]$ . (3) Detector = peak. (4) Trace mode = max hold.
- (5) Sweep = auto couple. (6) Allow the trace to stabilize. (7) Measure the maximum width of the emission that is constrained by the frequencies associated with the two outermost amplitude points (upper and lower frequencies) that are attenuated by 6 dB relative to the maximum level measured in the fundamental emission.

### 8.3 Test Equipment List and Details

Description	Manufacture	Model	Serial No.	Cal. Date.	Cal. Due.
<b>Conducted Room(TH-02)</b>					
EXA Signal Analyzer	Agilent	N9010A	US47140126	2020/04/30	2021/04/29
Cable	MTJ	MT40S	620620-MT40S-100	Each Use	/

**\*Statement of Traceability:** The testing equipment's listed above have finished the calibration by Electronics Testing Center, Taiwan (ETC) or other laboratories which were accredited by TAF or equivalent organizations. The calibration result could be traceable to the International System of Units (SI).

### 8.4 Test Results

Configuration	Channel	Frequency (MHz)	6 dB BW (MHz)	6dB Limit (MHz)	Result
SRD	Low	2405	0.68	> 0.5	Compliance
	Middle	2442	0.71	> 0.5	Compliance
	High	2474	0.75	> 0.5	Compliance

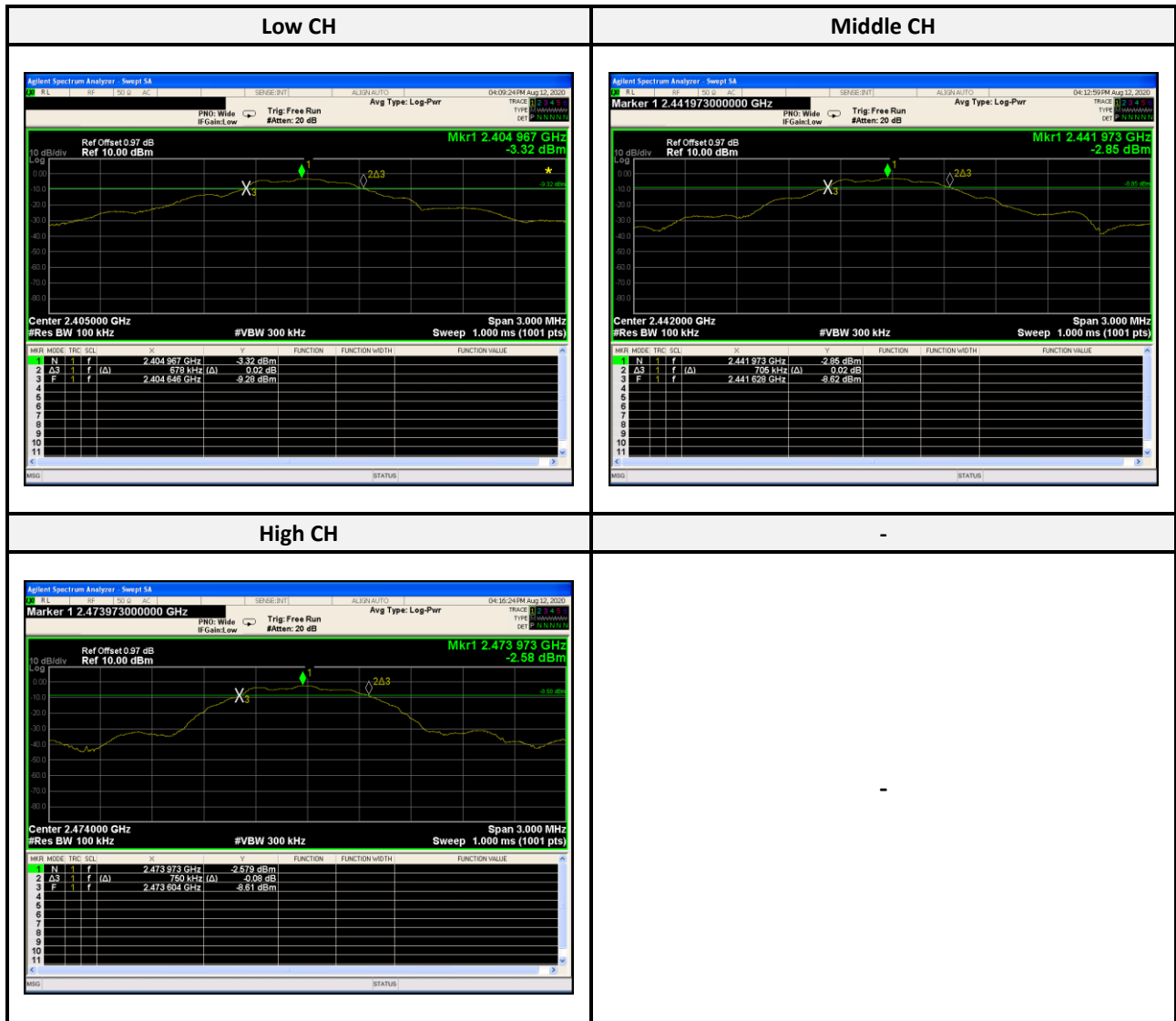

## 9 FCC §15.247(b) (3) – Maximum Output Power

### 9.1 Applicable Standard

According to FCC §15.247(b) (3),

Systems using digital modulation in the 902-928 MHz, 2400-2483.5 MHz, and 5725-5850 MHz bands: 1 Watt.

As an alternative to a peak power measurement, compliance with the one Watt limit can be based on a measurement of the maximum conducted output power. Maximum Conducted Output Power is defined as the total transmit power delivered to all antennas and antenna elements averaged across all symbols in the signaling alphabet when the transmitter is operating at its maximum power control level. Power must be summed across all antennas and antenna elements. The average must not include any time intervals during which the transmitter is off or is transmitting at a reduced power level. If multiple modes of operation are possible (e.g., alternative modulation methods), the maximum conducted output power is the highest total transmit power occurring in any mode.

### 9.2 Test Procedure

- (1) Place the EUT on a bench and set it in transmitting mode.
- (2) Remove the antenna from the EUT and then connect a low loss RF cable from the antenna port to measuring equipment.
- (3). Add a correction factor to the display.

### 9.3 Test Equipment List and Details

Description	Manufacture	Model	Serial No.	Cal. Date.	Cal. Due.
<b>Conducted Room(TH-02)</b>					
USB Wideband Power Sensor	Agilent	U2021XA	MY56120026	2019/09/06	2020/09/05
Cable	MTJ	MT40S	620620-MT40S-100	Each Use	/

*\*Statement of Traceability: The testing equipment's listed above have finished the calibration by Electronics Testing Center, Taiwan (ETC) or other laboratories which were accredited by TAF or equivalent organizations. The calibration result could be traceable to the International System of Units (SI).*

### 9.4 Test Results

Configuration	Channel	Frequency (MHz)	Maximum Peak Output Power		Limit (dBm)	Result
			(dBm)	(W)		
SRD	Low	2405	-2.68	0.0005	30	Compliance
	Middle	2442	-2.66	0.0005	30	Compliance
	High	2474	-2.36	0.0006	30	Compliance



---

## 10 FCC §15.247(d) – 100 kHz Bandwidth of Frequency Band Edge

---

### 10.1 Applicable Standard

According to FCC §15.247(d),

In any 100 kHz bandwidth outside the frequency band in which the spread spectrum or digitally modulated intentional radiator is operating, the radio frequency power that is produced by the intentional radiator shall be at least 20 dB below that in the 100 kHz bandwidth within the band that contains the highest level of the desired power, based on either an RF conducted or a radiated measurement, provided the transmitter demonstrates compliance with the peak conducted power limits.

If the transmitter complies with the conducted power limits based on the use of RMS averaging over a time interval, as permitted under paragraph (b)(3) of this section, the attenuation required under this paragraph shall be 30 dB instead of 20 dB.

Attenuation below the general limits specified in §15.209(a) is not required. In addition, radiated emissions which fall in the restricted bands, as defined in §15.205(a), must also comply with the radiated emission limits specified in §15.209(a) (see §15.205(c)).

### 10.2 Test Procedure

- (1) Check the calibration of the measuring instrument using either an internal calibrator or a known signal from an external generator.
- (2) Position the EUT without connection to measurement instrument. Turn on the EUT and connect its antenna terminal to measurement instrument via a low loss cable. Then set it to any one measured frequency within its operating range, and make sure the instrument is operated in its linear range.
- (3) Set RBW to 100 kHz and VBW of spectrum analyzer to 300 kHz with a convenient frequency span including 100 kHz bandwidth from band edge.
- (4) Measure the highest amplitude appearing on spectral display and set it as a reference level. Plot the graph with marking the highest point and edge frequency.

### 10.3 Test Equipment List and Details

Description	Manufacture	Model	Serial No.	Cal. Date.	Cal. Due.
<b>Conducted Room(TH-02)</b>					
EXA Signal Analyzer	Agilent	N9010A	US47140126	2020/04/30	2021/04/29
Cable	MTJ	MT40S	620620-MT40S-100	Each Use	/

*\*Statement of Traceability: The testing equipment's listed above have finished the calibration by Electronics Testing Center, Taiwan (ETC) or other laboratories which were accredited by TAF or equivalent organizations. The calibration result could be traceable to the International System of Units (SI).*

### 10.4 Test Results

Configuration	Channel	Frequency (MHz)	Delta Peak to Band Emission (dBc)	Limit (dBc)	Result
SRD	Low	2405	41.65	≥ 20	Compliance
	High	2474	51.68	≥ 20	Compliance

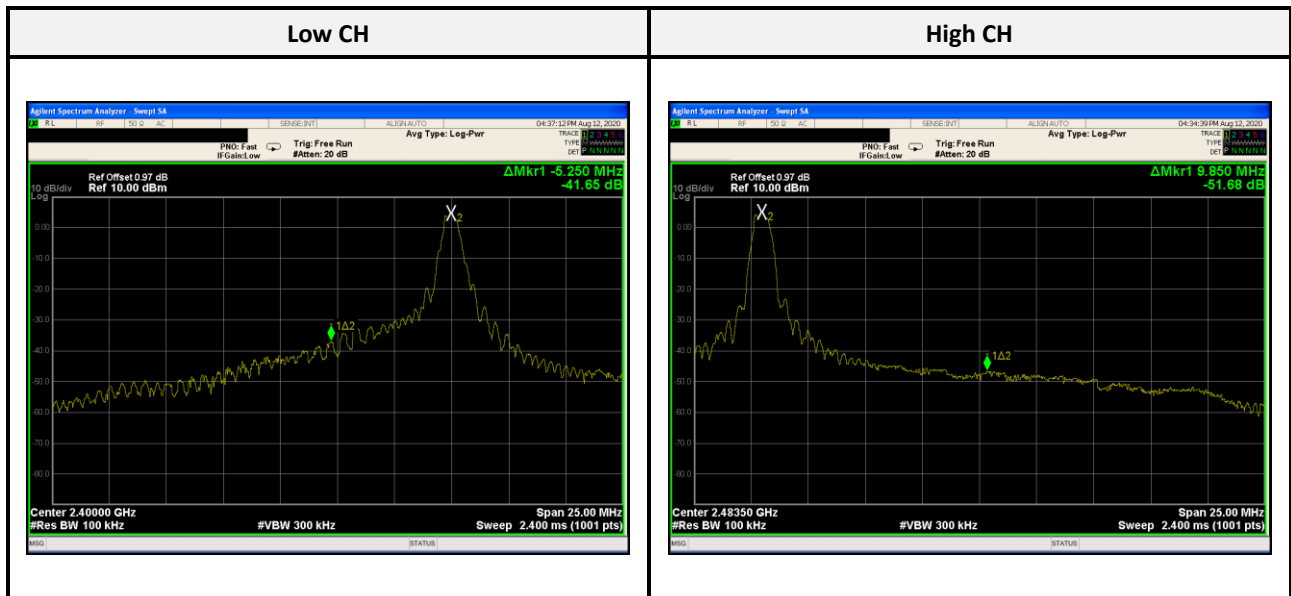

## 11 FCC §15.247(e) – Power Spectral Density

### 11.1 Applicable Standard

According to FCC §15.247(e),

For digitally modulated systems, the power spectral density conducted from the intentional radiator to the antenna shall not be greater than 8 dBm in any 3 kHz band during any time interval of continuous transmission. This power spectral density shall be determined in accordance with the provisions of paragraph (b) of this section. The same method of determining the conducted output power shall be used to determine the power spectral density.

### 11.2 Test Procedure

According to ANSI C63.10-2013,

- (1) Set analyzer center frequency to DTS channel center frequency.
- (2) Set the span to 1.5 times the DTS bandwidth. (3) Set the RBW to  $3 \text{ kHz} \leq \text{RBW} \leq 100 \text{ kHz}$ .
- (4) Set the VBW  $\geq [3 \times \text{RBW}]$ . (5) Detector = peak. (6) Sweep time = auto couple.
- (7) Trace mode = max hold. (8) Allow trace to fully stabilize.
- (9) Use the peak marker function to determine the maximum amplitude level within the RBW.
- (10) If measured value exceeds requirement, then reduce RBW (but no less than 3 kHz) and repeat.

### 11.3 Test Equipment List and Details

Description	Manufacture	Model	Serial No.	Cal. Date.	Cal. Due.
<b>Conducted Room(TH-02)</b>					
EXA Signal Analyzer	Agilent	N9010A	US47140126	2020/04/30	2021/04/29
Cable	MTJ	MT40S	620620-MT40S-100	Each Use	/

**\*Statement of Traceability:** The testing equipment's listed above have finished the calibration by Electronics Testing Center, Taiwan (ETC) or other laboratories which were accredited by TAF or equivalent organizations. The calibration result could be traceable to the International System of Units (SI).

### 11.4 Test Results

Configuration	Channel	Frequency (MHz)	PSD (dBm/3 kHz)	Limit (dBm/3 kHz)	Result
SRD	Low	2405	-5.39	8	Compliance
	Middle	2442	-5.00	8	Compliance
	High	2474	-4.36	8	Compliance

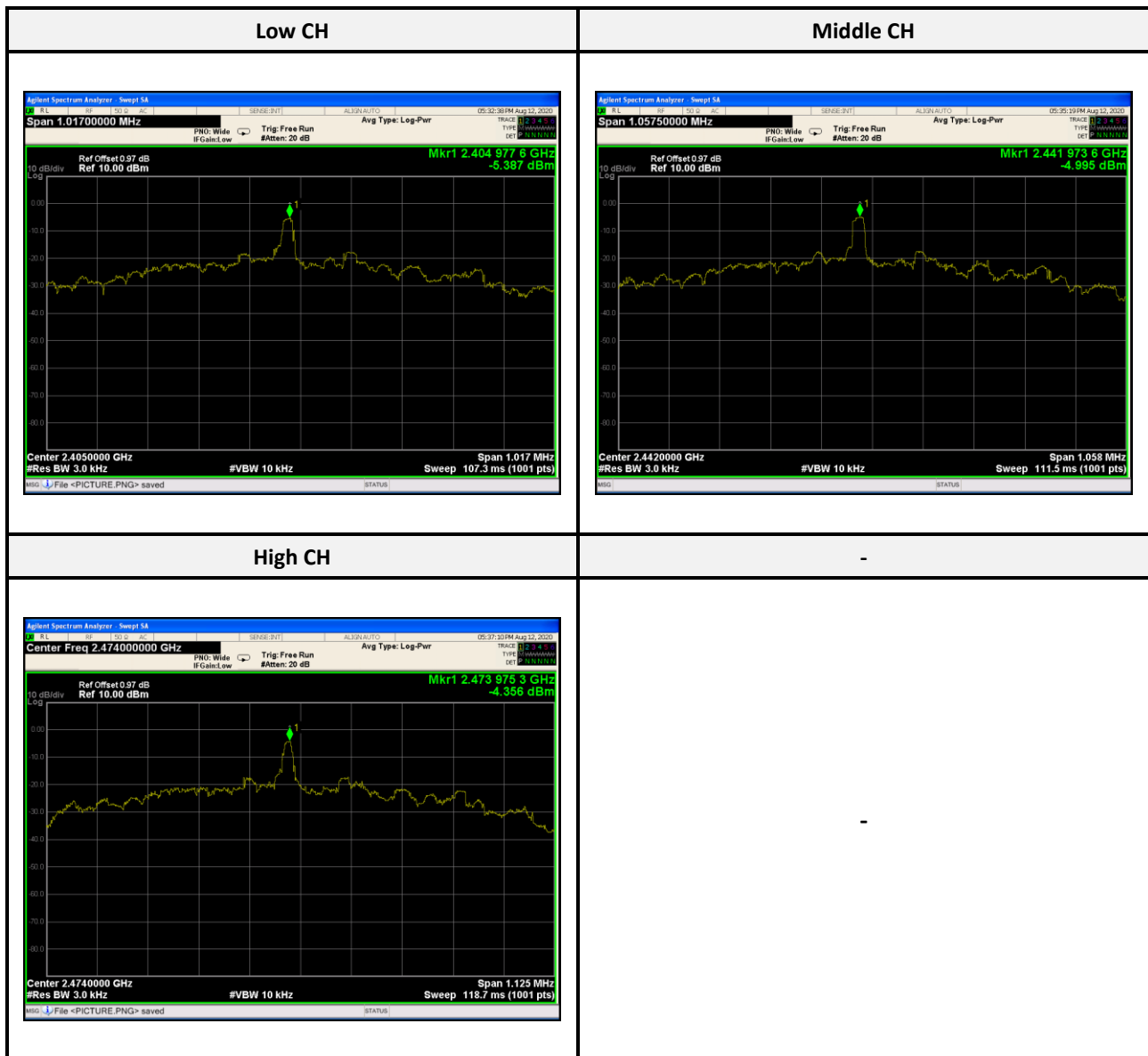

----- END OF REPORT -----