



FCC TEST REPORT

Application No: ZR/2019/40030
Applicant: Acer Incorporated
Address of Applicant: 8F.,NO.88,Sec. 1, Xintai 5 th Rd., Xizhi, New Taipei City 22181, Taiwan (R.O.C)
Manufacturer: SIM Technology Group Shanghai Simcom Limited
Address of Manufacturer: Building A,SIM Technology Building NO.633, Jinzhong Road.Changning District ,Shanghai P.R. China
Factory: Shanghai Sunrise SIMCOM LTD
Address of Factory: No.888 Shengli Road,QingPu District Shanghai China
EUT Description: Tablet Computer
Model No.: A8202
Trade Mark: 
FCC ID: HLZA8202
Standards: 47 CFR Part 2
 47 CFR Part 22 subpart H
 47 CFR Part 24 subpart E
 47 CFR Part 27 subpart C
Test Method: FCC KDB 971168 D01 Power Meas License Digital Systems V03r01 C63.26 (2015)
Date of Receipt: 2019/7/2
Date of Test: 2019/7/3 to 2019/7/20
Date of Issue: 2019/7/20

Test Result:	PASS *
---------------------	---------------

* In the configuration tested, the EUT detailed in this report complied with the standards specified above.

Authorized Signature:

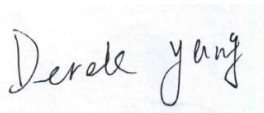

Derek Yang

Wireless Laboratory Manager



Unless otherwise agreed in writing, this document is issued by the Company subject to its General Conditions of Service printed overleaf, available on request or accessible at <http://www.sgs.com/en/Terms-and-Conditions.aspx> and, for electronic format documents, subject to Terms and Conditions for Electronic Documents at <http://www.sgs.com/en/terms-and-conditions/terms-e-document.aspx>. Attention is drawn to the limitation of liability, indemnification and jurisdiction issues defined therein. Any holder of this document is advised that information contained hereon reflects the Company's findings at the time of its intervention only and within the limits of Client's instructions, if any. The Company's sole responsibility is to its Client and this document does not exonerate parties to a transaction from exercising all their rights and obligations under the transaction documents. This document cannot be reproduced except in full, without prior written approval of the Company. Any unauthorized alteration, forgery or falsification of the content or appearance of this document is unlawful and offenders may be prosecuted to the fullest extent of the law. Unless otherwise stated the results shown in this test report refer only to the sample(s) tested and such sample(s) are retained for 30 days only.
 Attention: To check the authenticity of testing /inspection report & certificate, please contact us at telephone: (86-755) 8307 1443, or email: CN.Doccheck@sgs.com

1 Version

Revision Record				
Version	Chapter	Date	Modifier	Remark
00		2019/7/20		Original

Authorized for issue by:			
Tested By		 <hr/> (Mike Hu) /Project Engineer	2019/7/20 <hr/> Date
Checked By		 <hr/> (David Chen) /Reviewer	2019/7/20 <hr/> Date



Unless otherwise agreed in writing, this document is issued by the Company subject to its General Conditions of Service printed overleaf, available on request or accessible at <http://www.sgs.com/en/Terms-and-Conditions.aspx> and, for electronic format documents, subject to Terms and Conditions for Electronic Documents at <http://www.sgs.com/en/terms-and-conditions/terms-e-document.aspx>. Attention is drawn to the limitation of liability, indemnification and jurisdiction issues defined therein. Any holder of this document is advised that information contained hereon reflects the Company's findings at the time of its intervention only and within the limits of Client's instructions, if any. The Company's sole responsibility is to its Client and this document does not exonerate parties to a transaction from exercising all their rights and obligations under the transaction documents. This document cannot be reproduced except in full, without prior written approval of the Company. Any unauthorized alteration, forgery or falsification of the content or appearance of this document is unlawful and offenders may be prosecuted to the fullest extent of the law. Unless otherwise stated the results shown in this test report refer only to the sample(s) tested and such sample(s) are retained for 30 days only.
 Attention: To check the authenticity of testing /inspection report & certificate, please contact us at telephone: (86-755) 8307 1443, or email: CN.Doccheck@sgs.com

Content

1	VERSION	2
2	TEST SUMMARY	5
2.1	GSM850/UMTS BAND 5 & LTE BAND 5.....	5
2.2	GSM 1900/UMTS BAND 2 /LTE BAND 2	5
2.3	UMTS BAND 4 /LTE BAND 4.....	6
2.4	LTE BAND 12	6
2.5	LTE BAND 4 / 66	7
2.6	LTE BAND 71.....	7
3	GENERAL INFORMATION.....	9
3.1	CLIENT INFORMATION.....	9
3.2	TEST LOCATION.....	9
3.3	TEST FACILITY	9
3.4	GENERAL DESCRIPTION OF EUT	10
3.5	TEST MODE	10
3.6	TEST ENVIRONMENT.....	10
3.7	TECHNICAL SPECIFICATION.....	11
3.8	TEST FREQUENCIES	12
4	DESCRIPTION OF TESTS.....	16
4.1	CONDUCTED OUTPUT POWER	16
4.2	EFFECTIVE (ISOTROPIC) RADIATED POWER OF TRANSMITTER.....	16
4.3	OCCUPIED BANDWIDTH.....	17
4.4	BAND EDGE AT ANTENNA TERMINALS	18
4.5	SPURIOUS AND HARMONIC EMISSIONS AT ANTENNA TERMINAL	18
4.6	PEAK-AVERAGE RATIO.....	19
4.7	FIELD STRENGTH OF SPURIOUS RADIATION.....	20
4.8	FREQUENCY STABILITY / TEMPERATURE VARIATION	21
4.9	TEST SETUPS	22
4.9.1	Test Setup 1.....	22
4.9.2	Test Setup 2.....	22
4.9.3	Test Setup 3.....	23



Unless otherwise agreed in writing, this document is issued by the Company subject to its General Conditions of Service printed overleaf, available on request or accessible at <http://www.sgs.com/en/Terms-and-Conditions.aspx> and, for electronic format documents, subject to Terms and Conditions for Electronic Documents at <http://www.sgs.com/en/terms-and-conditions/Terms-e-Documents.aspx>. Attention is drawn to the limitation of liability, indemnification and jurisdiction issues defined therein. Any holder of this document is advised that information contained hereon reflects the Company's findings at the time of its intervention only and within the limits of Client's instructions, if any. The Company's sole responsibility is to its Client and this document does not exonerate parties to a transaction from exercising all their rights and obligations under the transaction documents. This document cannot be reproduced except in full, without prior written approval of the Company. Any unauthorized alteration, forgery or falsification of the content or appearance of this document is unlawful and offenders may be prosecuted to the fullest extent of the law. Unless otherwise stated the results shown in this test report refer only to the sample(s) tested and such sample(s) are retained for 30 days only.

Attention: To check the authenticity of testing /inspection report & certificate, please contact us at telephone: (86-755) 8307 1443, or email: CN.Doccheck@sgs.com



4.9.4 Test Setup 4..... 24

4.10 TEST CONDITIONS 25

5 MAIN TEST INSTRUMENTS27

6 MEASUREMENT UNCERTAINTY29

7 APPENDIXES.....29



Unless otherwise agreed in writing, this document is issued by the Company subject to its General Conditions of Service printed overleaf, available on request or accessible at <http://www.sgs.com/en/Terms-and-Conditions.aspx> and, for electronic format documents, subject to Terms and Conditions for Electronic Documents at <http://www.sgs.com/en/terms-and-conditions/terms-e-document.aspx>. Attention is drawn to the limitation of liability, indemnification and jurisdiction issues defined therein. Any holder of this document is advised that information contained hereon reflects the Company's findings at the time of its intervention only and within the limits of Client's instructions, if any. The Company's sole responsibility is to its Client and this document does not exonerate parties to a transaction from exercising all their rights and obligations under the transaction documents. This document cannot be reproduced except in full, without prior written approval of the Company. Any unauthorized alteration, forgery or falsification of the content or appearance of this document is unlawful and offenders may be prosecuted to the fullest extent of the law. Unless otherwise stated the results shown in this test report refer only to the sample(s) tested and such sample(s) are retained for 30 days only.

Attention: To check the authenticity of testing /inspection report & certificate, please contact us at telephone: (86-755) 8307 1443, or email: CN.Doccheck@sgs.com



2 Test Summary

2.1 GSM850/UMTS Band 5 & LTE Band 5

Test Item	FCC Rule No.	Requirements	Test Result	Verdict
Effective (Isotropic) Radiated Power Output Data	§2.1046, §22.913	FCC: ERP ≤ 7 W	Section 1 of Appendix B	Pass
Peak-Average Ratio	---	Limit ≤ 13 dB	Section 2 of Appendix B	Pass
Modulation Characteristics	§2.1047	Digital modulation	Section 3 of Appendix B	Pass
Bandwidth	§2.1049	OBW: No limit. EBW: No limit.	Section 4 of Appendix B	Pass
Band Edges Compliance	§2.1051, §22.917	≤ -13 dBm/1%*EBW, in 1 MHz bands immediately outside and adjacent to the frequency block.	Section 5 of Appendix B	Pass
Spurious Emission at Antenna Terminals	§2.1051, §22.917	FCC: ≤ -13 dBm/100 kHz, from 9 kHz to 10th harmonics but outside authorized operating frequency ranges.	Section 6 of Appendix B	Pass
Field Strength of Spurious Radiation	§2.1053, §22.917	FCC: ≤ -13 dBm/100 kHz.	Section 7 of Appendix B	Pass
Frequency Stability	§2.1055, §22.355	≤ ±2.5ppm.	Section 8 of Appendix B	Pass

Remark: For the verdict, the "N/A" denotes "not applicable", the "N/T" denotes "not tested".

2.2 GSM 1900/UMTS Band 2 /LTE Band 2

Test Item	FCC Rule No.	Requirements	Test Result	Verdict
Effective (Isotropic) Radiated Power Output Data	§2.1046, §24.232	EIRP ≤ 2 W	Section 1 of Appendix B	Pass
Peak-Average Ratio	§2.1046, §24.232	Limit ≤ 13 dB	Section 2 of Appendix B	Pass
Modulation Characteristics	§2.1047	Digital modulation	Section 3 of Appendix B	Pass
Bandwidth	§2.1049	OBW: No limit. EBW: No limit.	Section 4 of Appendix B	Pass
Band Edges Compliance	§2.1051, §24.238	≤ -13 dBm/1%*EBW, in 1 MHz bands immediately outside and adjacent to the frequency block.	Section 5 of Appendix B	Pass
Spurious Emission at Antenna Terminals	§2.1051, §24.238	≤ -13 dBm/1 MHz, from 9 kHz to 10 th harmonics but outside authorized operating frequency ranges.	Section 6 of Appendix B	Pass
Field Strength of Spurious Radiation	§2.1053, §24.238	≤ -13 dBm/1 MHz.	Section 7 of Appendix B	Pass
Frequency Stability	§2.1055, §24.235	≤ ±2.5 ppm.	Section 8 of Appendix B	Pass



Unless otherwise agreed in writing, this document is issued by the Company subject to its General Conditions of Service printed overleaf, available on request or accessible at <http://www.sgs.com/en/Terms-and-Conditions.aspx> and, for electronic format documents, subject to Terms and Conditions for Electronic Documents at <http://www.sgs.com/en/Terms-and-Conditions/Terms-e-Documents.aspx>. Attention is drawn to the limitation of liability, indemnification and jurisdiction issues defined therein. Any holder of this document is advised that information contained hereon reflects the Company's findings at the time of its intervention only and within the limits of Client's instructions, if any. The Company's sole responsibility is to its Client and this document does not exonerate parties to a transaction from exercising all their rights and obligations under the transaction documents. This document cannot be reproduced except in full, without prior written approval of the Company. Any unauthorized alteration, forgery or falsification of the content or appearance of this document is unlawful and offenders may be prosecuted to the fullest extent of the law. Unless otherwise stated the results shown in this test report refer only to the sample(s) tested and such sample(s) are retained for 30 days only.

Attention: To check the authenticity of testing/inspection report & certificate, please contact us at telephone: (86-755) 8307 1443, or email: CN.Doccheck@sgs.com



Test Item	FCC Rule No.	Requirements	Test Result	Verdict
Remark: For the verdict, the "N/A" denotes "not applicable", the "N/T" denotes "not tested".				

2.3 UMTS Band 4 /LTE Band 4

Test Item	FCC Rule No.	Requirements	Test Result	Verdict
Effective (Isotropic) Radiated Power Output Data	§2.1046, §27.50(d)	EIRP ≤ 1 W	Section 1 of Appendix B	Pass
Peak-Average Ratio	§2.1046, §27.50(d)	Limit≤13 dB	Section 2 of Appendix B	Pass
Modulation Characteristics	§2.1047	Digital modulation	Section 3 of Appendix B	Pass
Bandwidth	§2.1049	OBW: No limit. EBW: No limit.	Section 4 of Appendix B	Pass
Band Edges Compliance	§2.1051, §27.53(h)	≤ -13 dBm/1%*EBW, in 1 MHz bands immediately outside and adjacent to the frequency block.	Section 5 of Appendix B	Pass
Spurious Emission at Antenna Terminals	§2.1051, §27.53(h)	≤ -13 dBm/1 MHz, from 9 kHz to 10 th harmonics but outside authorized operating frequency ranges.	Section 6 of Appendix B	Pass
Field Strength of Spurious Radiation	§2.1053, §27.53(h)	≤ -13 dBm/1 MHz.	Section 7 of Appendix B	Pass
Frequency Stability	§2.1055, §27.54	≤ ±2.5 ppm.	Section 8 of Appendix B	Pass

Remark: For the verdict, the "N/A" denotes "not applicable", the "N/T" denotes "not tested".

2.4 LTE Band 12

Test Item	FCC Rule No	Requirements	Test Result	Verdict
Effective (Isotropic) Radiated Power Output Data	§27.50(c)	FCC: ERP ≤ 3 W.	Section 1 of Appendix B	Pass
Peak-Average Ratio	§2.1046, §27.50(c)	Limit≤13 dB	Section 2 of Appendix B	Pass
Modulation Characteristics	§2.1047	Digital modulation	Section 3 of Appendix B	Pass
Bandwidth	§2.1049	OBW: No limit. EBW: No limit.	Section 4 of Appendix B	Pass
Band Edges Compliance	§2.1051, §27.53(g)	≤ -13 dBm/1%*EBW, in 1 MHz bands immediately outside and adjacent to the frequency block.	Section 5 of Appendix B	Pass
Spurious Emission at Antenna Terminals	§2.1051, §27.53(g)	FCC: ≤ -13 dBm/100 kHz, from 9 kHz to 10 th harmonics but outside authorized operating frequency ranges.	Section 6 of Appendix B	Pass
Field Strength of Spurious Radiation	§2.1053, §27.53(g)	FCC: ≤ -13 dBm/100 kHz.	Section 7 of Appendix B	Pass
Frequency Stability	§2.1055,	≤ ±2.5ppm.	Section 8 of	Pass



Unless otherwise agreed in writing, this document is issued by the Company subject to its General Conditions of Service printed overleaf, available on request or accessible at <http://www.sgs.com/en/Terms-and-Conditions.aspx> and, for electronic format documents, subject to Terms and Conditions for Electronic Documents at <http://www.sgs.com/en/Terms-and-Conditions/Terms-e-Documents.aspx>. Attention is drawn to the limitation of liability, indemnification and jurisdiction issues defined therein. Any holder of this document is advised that information contained hereon reflects the Company's findings at the time of its intervention only and within the limits of Client's instructions, if any. The Company's sole responsibility is to its Client and this document does not exonerate parties to a transaction from exercising all their rights and obligations under the transaction documents. This document cannot be reproduced except in full, without prior written approval of the Company. Any unauthorized alteration, forgery or falsification of the content or appearance of this document is unlawful and offenders may be prosecuted to the fullest extent of the law. Unless otherwise stated the results shown in this test report refer only to the sample(s) tested and such sample(s) are retained for 30 days only.

Attention: To check the authenticity of testing /inspection report & certificate, please contact us at telephone: (86-755) 8307 1443, or email: CN.Doccheck@sgs.com



Test Item	FCC Rule No	Requirements	Test Result	Verdict
	§27.54		Appendix B	

Remark: For the verdict, the "N/A" denotes "not applicable", the "N/T" denotes "not tested".

2.5 LTE Band 4 / 66

Test Item	FCC Rule No.	Requirements	Test Result	Verdict
Effective (Isotropic) Radiated Power Output Data	§2.1046, §27.50(d)	EIRP ≤ 1 W	Section 1 of Appendix B	Pass
Peak-Average Ratio	§2.1046, §27.50(d)	Limit ≤ 13 dB	Section 2 of Appendix B	Pass
Modulation Characteristics	§2.1047	Digital modulation	Section 3 of Appendix B	Pass
Bandwidth	§2.1049	OBW: No limit. EBW: No limit.	Section 4 of Appendix B	Pass
Band Edges Compliance	§2.1051, §27.53(h)	≤ -13 dBm/1%*EBW, in 1 MHz bands immediately outside and adjacent to the frequency block.	Section 5 of Appendix B	Pass
Spurious Emission at Antenna Terminals	§2.1051, §27.53(h)	≤ -13 dBm/1 MHz, from 9 kHz to 10 th harmonics but outside authorized operating frequency ranges.	Section 6 of Appendix B	Pass
Field Strength of Spurious Radiation	§2.1053, §27.53(h)	≤ -13 dBm/1 MHz.	Section 7 of Appendix B	Pass
Frequency Stability	§2.1055, §27.54	≤ ±2.5 ppm.	Section 8 of Appendix B	Pass

Remark: For the verdict, the "N/A" denotes "not applicable", the "N/T" denotes "not tested".

2.6 LTE BAND 71

Test Item	FCC Rule No.	Requirements	Test Result	Verdict
Effective (Isotropic) Radiated Power Output Data	§2.1046, §27.50(c)	EIRP ≤ 3 W	Section 1 of Appendix B	Pass
Peak-Average Ratio	§2.1046,	Limit ≤ 13 dB	Section 2 of Appendix B	Pass
Modulation Characteristics	§2.1047	Digital modulation	Section 3 of Appendix B	Pass
Bandwidth	§2.1049	OBW: No limit. EBW: No limit.	Section 4 of Appendix B	Pass
Band Edges Compliance	§2.1051, §27.53(g)	≤ -13 dBm/1%*EBW, in 1 MHz bands immediately outside and adjacent to the frequency block.	Section 5 of Appendix B	Pass
Spurious Emission at Antenna Terminals	§2.1051, §27.53(g)	≤ -13 dBm/1 MHz, from 9 kHz to 10 th harmonics but outside authorized operating frequency ranges.	Section 6 of Appendix B	Pass
Field Strength of Spurious Radiation	§2.1053, §27.53(g)	≤ -13 dBm/1 MHz.	Section 7 of Appendix B	Pass



Unless otherwise agreed in writing, this document is issued by the Company subject to its General Conditions of Service printed overleaf, available on request or accessible at <http://www.sgs.com/en/Terms-and-Conditions.aspx> and, for electronic format documents, subject to Terms and Conditions for Electronic Documents at <http://www.sgs.com/en/Terms-and-Conditions/Terms-e-Documents.aspx>. Attention is drawn to the limitation of liability, indemnification and jurisdiction issues defined therein. Any holder of this document is advised that information contained hereon reflects the Company's findings at the time of its intervention only and within the limits of Client's instructions, if any. The Company's sole responsibility is to its Client and this document does not exonerate parties to a transaction from exercising all their rights and obligations under the transaction documents. This document cannot be reproduced except in full, without prior written approval of the Company. Any unauthorized alteration, forgery or falsification of the content or appearance of this document is unlawful and offenders may be prosecuted to the fullest extent of the law. Unless otherwise stated the results shown in this test report refer only to the sample(s) tested and such sample(s) are retained for 30 days only.

Attention: To check the authenticity of testing / inspection report & certificate, please contact us at telephone: (86-755) 8307 1443, or email: CN.Doccheck@sgs.com



Test Item	FCC Rule No.	Requirements	Test Result	Verdict
Frequency Stability	§2.1055, §27.54	within the authorized bands of operation.	Section 8 of Appendix B	Pass
Remark: For the verdict, the "N/A" denotes "not applicable", the "N/T" denotes "not tested".				



Unless otherwise agreed in writing, this document is issued by the Company subject to its General Conditions of Service printed overleaf, available on request or accessible at <http://www.sgs.com/en/Terms-and-Conditions.aspx> and, for electronic format documents, subject to Terms and Conditions for Electronic Documents at <http://www.sgs.com/en/terms-and-conditions/terms-e-document.aspx>. Attention is drawn to the limitation of liability, indemnification and jurisdiction issues defined therein. Any holder of this document is advised that information contained hereon reflects the Company's findings at the time of its intervention only and within the limits of Client's instructions, if any. The Company's sole responsibility is to its Client and this document does not exonerate parties to a transaction from exercising all their rights and obligations under the transaction documents. This document cannot be reproduced except in full, without prior written approval of the Company. Any unauthorized alteration, forgery or falsification of the content or appearance of this document is unlawful and offenders may be prosecuted to the fullest extent of the law. Unless otherwise stated the results shown in this test report refer only to the sample(s) tested and such sample(s) are retained for 30 days only.

Attention: To check the authenticity of testing /inspection report & certificate, please contact us at telephone: (86-755) 8307 1443, or email: CN.Doccheck@sgs.com

3 General Information

3.1 Client Information

Applicant:	Acer Incorporated
Address of Applicant:	8F.,NO.88,Sec. 1, Xintai 5 th Rd., Xizhi, New Taipei City 22181, Taiwan (R.O.C)
Manufacturer:	SIM Technology Group Shanghai Simcom Limited
Address of Manufacturer:	Building A,SIM Technology Building NO.633, Jinzhong Road.Changning District ,Shanghai P.R. China
Factory:	Shanghai Sunrise SIMCOM LTD
Address of Factory:	No.888 Shengli Road,QingPu District Shanghai China

3.2 Test Location

Company:	SGS-CSTC Standards Technical Services Co., Ltd. Shenzhen Branch
Address:	No. 1 Workshop, M-10, Middle section, Science & Technology Park, Shenzhen, Guangdong, China
Post code:	518057
Telephone:	+86 (0) 755 2601 2053
Fax:	+86 (0) 755 2671 0594
E-mail:	ee.shenzhen@sgs.com

3.3 Test Facility

The test facility is recognized, certified, or accredited by the following organizations:

- **CNAS (No. CNAS L2929)**

CNAS has accredited SGS-CSTC Standards Technical Services Co., Ltd. Shenzhen Branch EMC Lab to ISO/IEC 17025:2005 General Requirements for the Competence of Testing and Calibration Laboratories (CNAS-CL01 Accreditation Criteria for the Competence of Testing and Calibration Laboratories) for the competence in the field of testing.

- **A2LA (Certificate No. 3816.01)**

SGS-CSTC Standards Technical Services Co., Ltd., Shenzhen EMC Laboratory is accredited by the American Association for Laboratory Accreditation(A2LA). Certificate No. 3816.01.

- **VCCI**

The 3m Fully-anechoic chamber for above 1GHz, 10m Semi-anechoic chamber for below 1GHz, Shielded Room for Mains Port Conducted Interference Measurement and Telecommunication Port Conducted Interference Measurement of SGS-CSTC Standards Technical Services Co., Ltd. have been registered in accordance with the Regulations for Voluntary Control Measures with Registration No.: G-20026, R-14188, C-12383 and T-11153 respectively.

- **FCC –Designation Number: CN1178**

SGS-CSTC Standards Technical Services Co., Ltd., Shenzhen EMC Laboratory has been recognized as an accredited testing laboratory.

Designation Number: CN1178. Test Firm Registration Number: 406779.

- **Industry Canada (IC)**



Unless otherwise agreed in writing, this document is issued by the Company subject to its General Conditions of Service printed overleaf, available on request or accessible at <http://www.sgs.com/en/Terms-and-Conditions.aspx> and, for electronic format documents, subject to Terms and Conditions for Electronic Documents at <http://www.sgs.com/en/terms-and-conditions/terms-e-document.aspx>. Attention is drawn to the limitation of liability, indemnification and jurisdiction issues defined therein. Any holder of this document is advised that information contained hereon reflects the Company's findings at the time of its intervention only and within the limits of Client's instructions, if any. The Company's sole responsibility is to its Client and this document does not exonerate parties to a transaction from exercising all their rights and obligations under the transaction documents. This document cannot be reproduced except in full, without prior written approval of the Company. Any unauthorized alteration, forgery or falsification of the content or appearance of this document is unlawful and offenders may be prosecuted to the fullest extent of the law. Unless otherwise stated the results shown in this test report refer only to the sample(s) tested and such sample(s) are retained for 30 days only.

Attention: To check the authenticity of testing /inspection report & certificate, please contact us at telephone: (86-755) 8307 1443, or email: CN.Doccheck@sgs.com
 No.1 Workshop, M-10, Middle Section, Science & Technology Park, Shenzhen, China 518057 t (86-755) 26012053 f (86-755) 26710594 www.sgs.com.cn
 中国·深圳·科技园中区M-10栋一号厂房 邮编: 518057 t (86-755) 26012053 f (86-755) 26710594 sgs.china@sgs.com

Two 3m Semi-anechoic chambers and the 10m Semi-anechoic chamber of SGS-CSTC Standards Technical Services Co., Ltd. Shenzhen Branch EMC Lab have been registered by Certification and Engineering Bureau of Industry Canada for radio equipment testing with Registration No.: 4620C-1, 4620C-2, 4620C-3.

3.4 General Description of EUT

EUT Description::	Tablet Computer
Model No.:	A8202
Trade Mark:	
Hardware Version:	1.0
Software Version:	Acer_AV001_A8202_0.010.00_PA_CCI
Sample Type:	<input checked="" type="checkbox"/> Portable Device, <input type="checkbox"/> Module
Antenna Type:	<input type="checkbox"/> External, <input checked="" type="checkbox"/> Integrated
Antenna Gain:	LTE Band 2:-0.8dBi; LTE Band 4:-1.2dBi; LTE Band 5:-1.5dBi; LTE Band 12:-1.8dBi; LTE Band 66:-1.2dBi; LTE Band 71: -1.8dBi

3.5 Test Mode

Test Mode	Test Modes Description
LTE/TM1	LTE system, QPSK modulation
LTE/TM2	LTE system, 16QAM modulation

Remark: The test mode(s) are selected according to relevant radio technology specifications.

3.6 Test Environment

Environment Parameter	Selected Values During Tests	
Relative Humidity	52%	
Atmospheric Pressure:	101.32 KPa	
Temperature	NT	25 °C
Voltage:	LV	3.5V
	NV	3.8V
	HV	4.35V

Remark: LV= lower extreme test voltage; NV= nominal voltage
HV= upper extreme test voltage; NT= normal temperature



Unless otherwise agreed in writing, this document is issued by the Company subject to its General Conditions of Service printed overleaf, available on request or accessible at <http://www.sgs.com/en/Terms-and-Conditions.aspx> and, for electronic format documents, subject to Terms and Conditions for Electronic Documents at <http://www.sgs.com/en/terms-and-conditions/terms-e-document.aspx>. Attention is drawn to the limitation of liability, indemnification and jurisdiction issues defined therein. Any holder of this document is advised that information contained hereon reflects the Company's findings at the time of its intervention only and within the limits of Client's instructions, if any. The Company's sole responsibility is to its Client and this document does not exonerate parties to a transaction from exercising all their rights and obligations under the transaction documents. This document cannot be reproduced except in full, without prior written approval of the Company. Any unauthorized alteration, forgery or falsification of the content or appearance of this document is unlawful and offenders may be prosecuted to the fullest extent of the law. Unless otherwise stated the results shown in this test report refer only to the sample(s) tested and such sample(s) are retained for 30 days only.
Attention: To check the authenticity of testing /inspection report & certificate, please contact us at telephone: (86-755) 8307 1443, or email: CN.Doccheck@sgs.com

3.7 Technical Specification

Characteristics	Description		
Radio System Type	<input checked="" type="checkbox"/> LTE		
Supported Frequency Range	Band	TX	RX
	LTE Band 2	1850 to 1910 MHz	1930 to 1990 MHz
	LTE Band 4	1710 to 1755 MHz	2110 to 2155 MHz
	LTE Band 5	824 to 849 MHz	869 to 894 MHz
	LTE Band 12	699 to 716 MHz	729 to 746 MHz
	LTE Band 66	1710 to 1780 MHz	2110 to 2180 MHz
	LTE Band 71	663 to 698 MHz	617 to 652 MHz
Target TX Output Power	LTE Band 2: 23dBm LTE Band 4: 25dBm LTE Band 5: 25dBm LTE Band 12: 25dBm LTE Band 66: 22.5dBm LTE Band 71: 25dBm		
Supported Channel Bandwidth	LTE Band 2	<input checked="" type="checkbox"/> 1.4 MHz; <input checked="" type="checkbox"/> 3 MHz; <input checked="" type="checkbox"/> 5 MHz; <input checked="" type="checkbox"/> 10 MHz; <input checked="" type="checkbox"/> 15 MHz, <input checked="" type="checkbox"/> 20 MHz	
	LTE Band 4	<input checked="" type="checkbox"/> 1.4 MHz; <input checked="" type="checkbox"/> 3 MHz; <input checked="" type="checkbox"/> 5 MHz; <input checked="" type="checkbox"/> 10 MHz; <input checked="" type="checkbox"/> 15 MHz, <input checked="" type="checkbox"/> 20 MHz	
	LTE Band 5	<input checked="" type="checkbox"/> 1.4 MHz; <input checked="" type="checkbox"/> 3 MHz; <input checked="" type="checkbox"/> 5 MHz; <input checked="" type="checkbox"/> 10 MHz	
	LTE Band 12	<input checked="" type="checkbox"/> 1.4 MHz; <input checked="" type="checkbox"/> 3 MHz; <input checked="" type="checkbox"/> 5 MHz; <input checked="" type="checkbox"/> 10 MHz	
	LTE Band 66	<input checked="" type="checkbox"/> 1.4 MHz; <input checked="" type="checkbox"/> 3 MHz; <input checked="" type="checkbox"/> 5 MHz; <input checked="" type="checkbox"/> 10 MHz; <input checked="" type="checkbox"/> 15 MHz, <input checked="" type="checkbox"/> 20 MHz	
	LTE BAND 71	<input checked="" type="checkbox"/> 5 MHz; <input checked="" type="checkbox"/> 10 MHz; <input checked="" type="checkbox"/> 15 MHz, <input checked="" type="checkbox"/> 20 MHz	
	Characteristics	Description	
Designation of Emissions (Remark: the necessary bandwidth of which is the worst value from the measured occupied bandwidths for each type of channel bandwidth configuration.)	LTE Band 2	1M09G7D;1M09W7D; 2M69G7D;2M69W7D; 4M48G7D;4M50W7D; 8M93G7D;8M95W7D; 13M4G7D;13M4W7D; 17M8G7D;17M8W7D;	
	LTE Band 4	1M09G7D;1M09W7D; 2M70G7D;2M69W7D; 4M48G7D;4M50W7D; 8M93G7D;8M91W7D; 13M5G7D;13M4W7D; 17M9G7D;17M9W7D;	
	LTE Band 5	1M10G7D;1M09W7D; 2M70G7D;2M69W7D; 4M48G7D;4M49W7D; 8M93G7D;8M95W7D;	
	LTE Band 12	1M09G7D;1M09W7D; 2M69G7D;2M69W7D; 4M48G7D;4M50W7D; 8M93G7D;8M91W7D;	



Unless otherwise agreed in writing, this document is issued by the Company subject to its General Conditions of Service printed overleaf, available on request or accessible at <http://www.sgs.com/en/Terms-and-Conditions.aspx> and, for electronic format documents, subject to Terms and Conditions for Electronic Documents at <http://www.sgs.com/en/Terms-and-Conditions/Terms-e-Documents.aspx>. Attention is drawn to the limitation of liability, indemnification and jurisdiction issues defined therein. Any holder of this document is advised that information contained hereon reflects the Company's findings at the time of its intervention only and within the limits of Client's instructions, if any. The Company's sole responsibility is to its Client and this document does not exonerate parties to a transaction from exercising all their rights and obligations under the transaction documents. This document cannot be reproduced except in full, without prior written approval of the Company. Any unauthorized alteration, forgery or falsification of the content or appearance of this document is unlawful and offenders may be prosecuted to the fullest extent of the law. Unless otherwise stated the results shown in this test report refer only to the sample(s) tested and such sample(s) are retained for 30 days only.
 Attention: To check the authenticity of testing / inspection report & certificate, please contact us at telephone: (86-755) 8307 1443, or email: CN.Doccheck@sgs.com

LTE Band 66	1M09G7D;1M09W7D; 2M70G7D;2M69W7D; 4M48G7D;4M50W7D; 8M93G7D;8M91W7D; 13M5G7D;13M4W7D; 17M8G7D;17M9W7D;
LTE BAND 71	4M48G7D;4M50W7D; 8M93G7D;8M93W7D; 13M5G7D;13M5W7D; 17M9G7D;17M8W7D;

3.8 Test Frequencies

Test Mode	Bandwidth	TX / RX	RF Channel		
			Low (L)	Middle (M)	High (H)
LTE Band 2	1.4MHz	TX	Channel 18607	Channel 18900	Channel 19193
			1850.7 MHz	1880 MHz	1909.3 MHz
		RX	Channel 607	Channel 900	Channel 1193
			1930.7 MHz	1960 MHz	1989.3 MHz
	3MHz	TX	Channel 18615	Channel 18900	Channel 19185
			1851.5 MHz	1880 MHz	1908.5 MHz
		RX	Channel 615	Channel 900	Channel 1185
			1931.5 MHz	1960 MHz	1988.5 MHz
	5MHz	TX	Channel 18625	Channel 18900	Channel 19175
			1852.5 MHz	1880 MHz	1907.5 MHz
		RX	Channel 625	Channel 900	Channel 1175
			1932.5 MHz	1960 MHz	1987.5 MHz
	10MHz	TX	Channel 18650	Channel 18900	Channel 19150
			1855 MHz	1880 MHz	1905 MHz
		RX	Channel 650	Channel 900	Channel 1150
			1935 MHz	1960 MHz	1985 MHz
	15MHz	TX	Channel 18675	Channel 18900	Channel 19125
			1857.5 MHz	1880 MHz	1902.5 MHz
		RX	Channel 675	Channel 900	Channel 1125
			1937.5 MHz	1960 MHz	1982.5 MHz
	20MHz	TX	Channel 18700	Channel 18900	Channel 19100
			1860 MHz	1880 MHz	1900 MHz
		RX	Channel 700	Channel 900	Channel 1100
			1940 MHz	1960 MHz	1980 MHz



Unless otherwise agreed in writing, this document is issued by the Company subject to its General Conditions of Service printed overleaf, available on request or accessible at <http://www.sgs.com/en/Terms-and-Conditions.aspx> and, for electronic format documents, subject to Terms and Conditions for Electronic Documents at <http://www.sgs.com/en/Terms-and-Conditions/Terms-e-Documents.aspx>. Attention is drawn to the limitation of liability, indemnification and jurisdiction issues defined therein. Any holder of this document is advised that information contained hereon reflects the Company's findings at the time of its intervention only and within the limits of Client's instructions, if any. The Company's sole responsibility is to its Client and this document does not exonerate parties to a transaction from exercising all their rights and obligations under the transaction documents. This document cannot be reproduced except in full, without prior written approval of the Company. Any unauthorized alteration, forgery or falsification of the content or appearance of this document is unlawful and offenders may be prosecuted to the fullest extent of the law. Unless otherwise stated the results shown in this test report refer only to the sample(s) tested and such sample(s) are retained for 30 days only.

Attention: To check the authenticity of testing / inspection report & certificate, please contact us at telephone: (86-755) 8307 1443, or email: CN.Doccheck@sgs.com

Test Mode	Bandwidth	TX / RX	RF Channel		
			Low (L)	Middle (M)	High (H)
LTE Band 4	1.4MHz	TX	Channel 19957	Channel 20175	Channel 20393
			1710.7 MHz	1732.5 MHz	1754.3 MHz
		RX	Channel 1975	Channel 2175	Channel 2375
			2112.5 MHz	2132.5MHz	2152.5 MHz
	3MHz	TX	Channel 19965	Channel 20175	Channel 20385
			1711.5 MHz	1732.5 MHz	1753.5 MHz
		RX	Channel 2000	Channel 2175	Channel 2350
			2115 MHz	2132.5MHz	2150 MHz
	5MHz	TX	Channel 19975	Channel 20175	Channel 20375
			1712.5 MHz	1732.5 MHz	1752.5 MHz
		RX	Channel 1975	Channel 2175	Channel 2375
			2112.5 MHz	2132.5MHz	2152.5 MHz
	10MHz	TX	Channel 20000	Channel 20175	Channel 20350
			1715 MHz	1732.5 MHz	1750 MHz
		RX	Channel 2000	Channel 2175	Channel 2350
			2115 MHz	2132.5MHz	2150 MHz
	15MHz	TX	Channel 20025	Channel 20175	Channel 20325
			1717.5 MHz	1732.5 MHz	1747.5 MHz
		RX	Channel 2025	Channel 2175	Channel 2325
			2117.5 MHz	2132.5MHz	2147.5 MHz
20MHz	TX	Channel 20050	Channel 20175	Channel 20300	
		1720 MHz	1732.5 MHz	1745 MHz	
	RX	Channel 2050	Channel 2175	Channel 2300	
		2120 MHz	2132.5MHz	2145 MHz	

Test Mode	Bandwidth	TX / RX	RF Channel		
			Low (L)	Middle (M)	High (H)
LTE Band 5	1.4MHz	TX	Channel 20407	Channel 20525	Channel 20643
			824.7 MHz	836.5 MHz	848.3 MHz
		RX	Channel 2407	Channel 2525	Channel 2643
			869.7 MHz	881.5 MHz	893.3 MHz
	3MHz	TX	Channel 20415	Channel 20525	Channel 20635
			825.5 MHz	836.5 MHz	847.5 MHz
		RX	Channel 2415	Channel 2525	Channel 2635
			870.5 MHz	881.5 MHz	892.5 MHz
	5MHz	TX	Channel 20425	Channel 20525	Channel 20625
			826.5 MHz	836.5 MHz	846.5 MHz
		RX	Channel 2425	Channel 2525	Channel 2625
			871.5 MHz	881.5 MHz	891.5 MHz
	10MHz	TX	Channel 20450	Channel 20525	Channel 20600
			829 MHz	836.5 MHz	844 MHz
		RX	Channel 2450	Channel 2525	Channel 2600
			874 MHz	881.5 MHz	889 MHz



Unless otherwise agreed in writing, this document is issued by the Company subject to its General Conditions of Service printed overleaf, available on request or accessible at <http://www.sgs.com/en/Terms-and-Conditions.aspx> and, for electronic format documents, subject to Terms and Conditions for Electronic Documents at <http://www.sgs.com/en/Terms-and-Conditions/Terms-e-Documents.aspx>. Attention is drawn to the limitation of liability, indemnification and jurisdiction issues defined therein. Any holder of this document is advised that information contained hereon reflects the Company's findings at the time of its intervention only and within the limits of Client's instructions, if any. The Company's sole responsibility is to its Client and this document does not exonerate parties to a transaction from exercising all their rights and obligations under the transaction documents. This document cannot be reproduced except in full, without prior written approval of the Company. Any unauthorized alteration, forgery or falsification of the content or appearance of this document is unlawful and offenders may be prosecuted to the fullest extent of the law. Unless otherwise stated the results shown in this test report refer only to the sample(s) tested and such sample(s) are retained for 30 days only.

Attention: To check the authenticity of testing/inspection report & certificate, please contact us at telephone: (86-755) 8307 1443, or email: CN.Doccheck@sgs.com

Test Mode	Bandwidth	TX / RX	RF Channel		
			Low (L)	Middle (M)	High (H)
LTE Band12	1.4MHz	TX	Channel 23017	Channel 23095	Channel 23173
			699.7 MHz	707.5 MHz	715.3 MHz
		RX	Channel 5017	Channel 5095	Channel 5173
			729.7 MHz	737.5 MHz	745.3 MHz
	3MHz	TX	Channel 23025	Channel 23095	Channel 23165
			700.5 MHz	707.5 MHz	714.5 MHz
		RX	Channel 5025	Channel 5095	Channel 5165
			730.5 MHz	737.5 MHz	744.5 MHz
	5MHz	TX	Channel 23035	Channel 23095	Channel 23155
			701.5 MHz	707.5 MHz	713.5 MHz
		RX	Channel 5035	Channel 5095	Channel 5155
			731.5 MHz	737.5 MHz	743.5 MHz
10MHz	TX	Channel 23060	Channel 23095	Channel 23130	
		704 MHz	707.5 MHz	711 MHz	
	RX	Channel 5060	Channel 5095	Channel 5130	
		734 MHz	737.5 MHz	741 MHz	

Test Mode	Bandwidth	TX / RX	RF Channel		
			Low (L)	Middle (M)	High (H)
LTE Band 66	1.4MHz	TX	Channel 131979	Channel 132322	Channel 132665
			1710.7 MHz	1745 MHz	1779.3 MHz
		RX	Channel 66443	Channel 66786	Channel 67129
			2110.7 MHz	2145MHz	2179.3 MHz
	3MHz	TX	Channel 131987	Channel 132322	Channel 132657
			1711.5 MHz	1745 MHz	1778.5MHz
		RX	Channel 66451	Channel 66786	Channel 67121
			2111.5 MHz	2145MHz	2178.5MHz
	5MHz	TX	Channel 131997	Channel 132322	Channel 132647
			1712.5 MHz	1745 MHz	1777.5 MHz
		RX	Channel 66461	Channel 66786	Channel 67711
			2112.5 MHz	2145MHz	2177.5 MHz
	10MHz	TX	Channel 132022	Channel 132322	Channel 132622
			1715 MHz	1745 MHz	1775 MHz
		RX	Channel 66486	Channel 66786	Channel 67086
			2115 MHz	2145MHz	2175 MHz
	15MHz	TX	Channel 132047	Channel 132322	Channel 132597
			1717.5 MHz	1745 MHz	1772.5 MHz
		RX	Channel 66511	Channel 66786	Channel 67061
			2117.5 MHz	2145MHz	2172.5 MHz
	20MHz	TX	Channel 132072	Channel 132322	Channel 132572
			1720 MHz	1745 MHz	1770 MHz
		RX	Channel 66536	Channel 66786	Channel 67036
			2120 MHz	2145MHz	2170 MHz



Unless otherwise agreed in writing, this document is issued by the Company subject to its General Conditions of Service printed overleaf, available on request or accessible at <http://www.sgs.com/en/Terms-and-Conditions.aspx> and, for electronic format documents, subject to Terms and Conditions for Electronic Documents at <http://www.sgs.com/en/Terms-and-Conditions/Terms-e-Documents.aspx>. Attention is drawn to the limitation of liability, indemnification and jurisdiction issues defined therein. Any holder of this document is advised that information contained hereon reflects the Company's findings at the time of its intervention only and within the limits of Client's instructions, if any. The Company's sole responsibility is to its Client and this document does not exonerate parties to a transaction from exercising all their rights and obligations under the transaction documents. This document cannot be reproduced except in full, without prior written approval of the Company. Any unauthorized alteration, forgery or falsification of the content or appearance of this document is unlawful and offenders may be prosecuted to the fullest extent of the law. Unless otherwise stated the results shown in this test report refer only to the sample(s) tested and such sample(s) are retained for 30 days only.

Attention: To check the authenticity of testing /inspection report & certificate, please contact us at telephone: (86-755) 8307 1443, or email: CN.Doccheck@sgs.com

Test Mode		TX / RX	RF Channel		
			Low (L)	Middle (M)	High (H)
LTE Band 71	5MHz	TX	Channel 133147	Channel 133297	Channel 133447
			665.5 MHz	680.5 MHz	695.5 MHz
		RX	Channel 68611	Channel 68761	Channel 68911
			619.5 MHz	634.5 MHz	649.5 MHz
	10MHz	TX	Channel 133172	Channel 133297	Channel 133422
			668 MHz	680.5 MHz	693 MHz
		RX	Channel 68636	Channel 68761	Channel 68886
			622 MHz	634.5 MHz	647 MHz
	15MHz	TX	Channel 133197	Channel 133297	Channel 133397
			670.5 MHz	680.5 MHz	690.5 MHz
		RX	Channel 68661	Channel 68761	Channel 68861
			624.5 MHz	634.5 MHz	644.5 MHz
	20MHz	TX	Channel 133222	Channel 133297	Channel 133372
			673 MHz	680.5 MHz	688 MHz
		RX	Channel 68686	Channel 68761	Channel 68836
			627 MHz	634.5 MHz	642 MHz



Unless otherwise agreed in writing, this document is issued by the Company subject to its General Conditions of Service printed overleaf, available on request or accessible at <http://www.sgs.com/en/Terms-and-Conditions.aspx> and, for electronic format documents, subject to Terms and Conditions for Electronic Documents at <http://www.sgs.com/en/terms-and-conditions/terms-e-document.aspx>. Attention is drawn to the limitation of liability, indemnification and jurisdiction issues defined therein. Any holder of this document is advised that information contained hereon reflects the Company's findings at the time of its intervention only and within the limits of Client's instructions, if any. The Company's sole responsibility is to its Client and this document does not exonerate parties to a transaction from exercising all their rights and obligations under the transaction documents. This document cannot be reproduced except in full, without prior written approval of the Company. Any unauthorized alteration, forgery or falsification of the content or appearance of this document is unlawful and offenders may be prosecuted to the fullest extent of the law. Unless otherwise stated the results shown in this test report refer only to the sample(s) tested and such sample(s) are retained for 30 days only.
Attention: To check the authenticity of testing /inspection report & certificate, please contact us at telephone: (86-755) 8307 1443, or email: CN.Doccheck@sgs.com

4 Description of Tests

4.1 Conducted Output Power

Measurement Procedure: FCC KDB 971168 D01 V03r01

The transmitter output was connected to a calibrated coaxial cable, attenuator and power meter, the other end of which was connected to a Base Station Simulator. The Base Station Simulator was set to force the EUT to its maximum power setting. The power output at the transmitter antenna port was determined by adding the value of the cable insertion loss to the power reading. The tests were performed at three frequencies (low channel, middle channel and high channel) and on the highest power levels, which can be setup on the transmitters.

Remark: Reference test setup 1

4.2 Effective (Isotropic) Radiated Power of Transmitter

Measurement Procedure: FCC KDB 971168 D01 V03r01 ; C63.26 (2015)

Calculate power in dBm by the following formula:

ERP (dBm) = Conducted Power (dBm) + antenna gain (dBd)

EIRP(dBm) = Conducted Power (dBm) + antenna gain (dBi)

EIRP=ERP+2.15dB

Measurement Procedure: FCC KDB 971168 D01 V03r01 ; ANSI/C63.26 (2015)

Below 1GHz test procedure as below:

- 1). The EUT was powered ON and placed on a 0.8m high table in the chamber. The antenna of the transmitter was extended to its maximum length.
- 2). The disturbance of the transmitter was maximized on the test receiver display by raising and lowering from 1m to 4m the receive antenna and by rotating through 360° the turntable. After the fundamental emission was maximized, a field strength measurement was made.
- 3). Steps 1) and 2) were performed with the EUT and the receive antenna in both vertical and horizontal polarization.
- 4). The transmitter was then removed and replaced with another antenna. The center of the antenna was approximately at the same location as the center of the transmitter.
- 5). A signal at the disturbance was fed to the substitution antenna by means of a non-radiating cable. With both the substitution and the receive antennas horizontally polarized, the receive antenna was raised and lowered to obtain a maximum reading at the test receiver. The level of the signal generator was adjusted until the measured field strength level in step 2) is obtained for this set of conditions.
- 6). The output power into the substitution antenna was then measured.
- 7). Steps 5) and 6) were repeated with both antennas polarized.
- 8). Calculate power in dBm by the following formula:

$$\text{ERP (dBm)} = \text{Pg(dBm)} - \text{cable loss (dB)} + \text{antenna gain (dBd)}$$



Unless otherwise agreed in writing, this document is issued by the Company subject to its General Conditions of Service printed overleaf, available on request or accessible at <http://www.sgs.com/en/Terms-and-Conditions.aspx> and, for electronic format documents, subject to Terms and Conditions for Electronic Documents at <http://www.sgs.com/en/Terms-and-Conditions/Terms-e-Document.aspx>. Attention is drawn to the limitation of liability, indemnification and jurisdiction issues defined therein. Any holder of this document is advised that information contained hereon reflects the Company's findings at the time of its intervention only and within the limits of Client's instructions, if any. The Company's sole responsibility is to its Client and this document does not exonerate parties to a transaction from exercising all their rights and obligations under the transaction documents. This document cannot be reproduced except in full, without prior written approval of the Company. Any unauthorized alteration, forgery or falsification of the content or appearance of this document is unlawful and offenders may be prosecuted to the fullest extent of the law. Unless otherwise stated the results shown in this test report refer only to the sample(s) tested and such sample(s) are retained for 30 days only.

Attention: To check the authenticity of testing/inspection report & certificate, please contact us at telephone: (86-755) 8307 1443, or email: CN.Doccheck@sgs.com

Where:

P_g is the generator output power into the substitution antenna.

Above 1GHz test procedure as below:

- 1). Different between above is the test site, change from Semi- Anechoic Chamber to fully Anechoic Chamber
- 2). Calculate power in dBm by the following formula:
 $EIRP(dBm) = P_g(dBm) - \text{cable loss (dB)} + \text{antenna gain (dBi)}$
 $EIRP = ERP + 2.15dB$

Where:

P_g is the generator output power into the substitution antenna.

- 3). Test the EUT in the lowest channel, the middle channel the Highest channel
- 4). The radiation measurements are performed in X, Y, Z axis positioning. And found the X axis positioning which it is worse case, Only the test worst case mode is recorded in the report.
- 5). Repeat above procedures until all frequencies measured was complete.

Remark: Reference test setup 2

4.3 Occupied Bandwidth

Measurement Procedure: FCC KDB 971168 D01 V03r01 Section 4.2

The occupied bandwidth, that is the frequency bandwidth such that, below its lower and above its upper frequency limits, the mean powers radiated are each equal to 0.5 percent of the total mean power radiated by a given emission shall be measured. The transmitter output was connected to a calibrated coaxial cable, attenuator and Spectrum analyser, the other end of which was connected to a Base Station Simulator. The Base Station Simulator was set to force the EUT to its maximum power setting. The tests were performed at three frequencies (low channel, middle channel and high channel). The span of the analyzer shall be set to capture all products of the modulation process, including the emission skirts. The resolution bandwidth shall be set to as close to 1 percent of the selected span as is possible without being below 1 percent. The video bandwidth shall be set to 3 times the resolution bandwidth. Video averaging is not permitted. Where practical, a sampling detector shall be used since a peak or, peak hold, may produce a wider bandwidth than actual. The trace data points are recovered and are directly summed in linear terms. The recovered amplitude data points, beginning at the lowest frequency, are placed in a running sum until 0.5 percent of the total is reached and that frequency recorded. The process is repeated for the highest frequency data points. This frequency is recorded. The span between the two recorded frequencies is the occupied bandwidth.

Remark: Reference test setup 1



Unless otherwise agreed in writing, this document is issued by the Company subject to its General Conditions of Service printed overleaf, available on request or accessible at <http://www.sgs.com/en/Terms-and-Conditions.aspx> and, for electronic format documents, subject to Terms and Conditions for Electronic Documents at <http://www.sgs.com/en/terms-and-conditions/terms-e-document.aspx>. Attention is drawn to the limitation of liability, indemnification and jurisdiction issues defined therein. Any holder of this document is advised that information contained hereon reflects the Company's findings at the time of its intervention only and within the limits of Client's instructions, if any. The Company's sole responsibility is to its Client and this document does not exonerate parties to a transaction from exercising all their rights and obligations under the transaction documents. This document cannot be reproduced except in full, without prior written approval of the Company. Any unauthorized alteration, forgery or falsification of the content or appearance of this document is unlawful and offenders may be prosecuted to the fullest extent of the law. Unless otherwise stated the results shown in this test report refer only to the sample(s) tested and such sample(s) are retained for 30 days only.
 Attention: To check the authenticity of testing /inspection report & certificate, please contact us at telephone: (86-755) 8307 1443, or email: CN.Doccheck@sgs.com

Test Settings

1. The signal analyzer's automatic bandwidth measurement capability was used to perform the 99% occupied bandwidth and the 26dB bandwidth. The bandwidth measurement was not influenced by any intermediate power nulls in the fundamental emission.
2. RBW = 1 – 5% of the expected OBW
3. VBW \geq 3 x RBW
4. Detector = Peak
5. Trace mode = max hold
6. Sweep = auto couple
7. The trace was allowed to stabilize
8. If necessary, steps 2 – 7 were repeated after changing the RBW such that it would be within 1 – 5% of the 99% occupied bandwidth observed in Step 7

4.4 Band Edge at Antenna Terminals

Measurement Procedure: FCC KDB 971168 D01 V03r01 Section 6.0

The transmitter output was connected to a calibrated coaxial cable, attenuator and Spectrum analyser, the other end of which was connected to a Base Station Simulator. The Base Station Simulator was set to force the EUT to its maximum power setting. The tests were performed at two frequencies (low channel and high channel). in the 1MHz bands immediately outside and adjacent to the frequency block a resolution bandwidth of 100kHz or 1% of the emission bandwidth of the fundamental emission of the transmitter may be employed. The EUT emission bandwidth is measured as the width of the signal between two points, outside of which all emission are attenuated at least 26dB below the transmitter power. The video bandwidth of the spectrum analyzer was set at thrice the resolution bandwidth. Detector Mode was set to peak or peak hold power.

Remark: Reference test setup 1

Test Settings

1. Start and stop frequency were set such that the band edge would be placed in the center of the plot
2. Span was set large enough so as to capture all out of band emissions near the band edge
3. RBW \geq 1% of the emission bandwidth
4. VBW \geq 3 x RBW
5. Detector = RMS
6. Number of sweep points \geq 2 x Span/RBW
7. Trace mode = trace average for continuous emissions, max hold for pulse emissions
8. Sweep time = auto couple
9. The trace was allowed to stabilize

4.5 Spurious And Harmonic Emissions at Antenna Terminal

Measurement Procedure: FCC KDB 971168 D01 V03r01



Unless otherwise agreed in writing, this document is issued by the Company subject to its General Conditions of Service printed overleaf, available on request or accessible at <http://www.sgs.com/en/Terms-and-Conditions.aspx> and, for electronic format documents, subject to Terms and Conditions for Electronic Documents at <http://www.sgs.com/en/Terms-and-Conditions/Terms-e-Documents.aspx>. Attention is drawn to the limitation of liability, indemnification and jurisdiction issues defined therein. Any holder of this document is advised that information contained hereon reflects the Company's findings at the time of its intervention only and within the limits of Client's instructions, if any. The Company's sole responsibility is to its Client and this document does not exonerate parties to a transaction from exercising all their rights and obligations under the transaction documents. This document cannot be reproduced except in full, without prior written approval of the Company. Any unauthorized alteration, forgery or falsification of the content or appearance of this document is unlawful and offenders may be prosecuted to the fullest extent of the law. Unless otherwise stated the results shown in this test report refer only to the sample(s) tested and such sample(s) are retained for 30 days only.

Attention: To check the authenticity of testing / inspection report & certificate, please contact us at telephone: (86-755) 8307 1443, or email: CN.Doccheck@sgs.com

The transmitter output was connected to a calibrated coaxial cable, attenuator and Spectrum analyzer, the other end of which was connected to a Base Station Simulator. The Base Station Simulator was set to force the EUT to its maximum power setting. The tests were performed at three frequencies (low channel and high channel). The level of the carrier and the various conducted spurious and harmonic frequencies is measured by means of a calibrated spectrum analyzer. The spectrum is scanned from the lowest frequency generated in the equipment up to a frequency including its 10th harmonic. On any frequency outside a licensee's frequency block, the power of any emission shall be attenuated below the transmitter power (P) by at least $43 + 10 \log(P)$ dB. Compliance with these provisions is based on the use of measurement instrumentation employing a resolution bandwidth of 1 MHz or greater. However, in the 1 MHz bands immediately outside and adjacent to the frequency block a resolution bandwidth of at least one percent of the emission bandwidth of the fundamental emission of the transmitter may be employed. The emission bandwidth is defined as the width of the signal between two points, one below the carrier center frequency and one above the carrier center frequency, outside of which all emission are attenuated at least 26 dB below the transmitter power.

Remark: Reference test setup 1

Test Settings

1. Start frequency was set to 30MHz and stop frequency was set to at least $10 \times$ the fundamental frequency (separated into at least two plots per channel)
2. Detector = RMS
3. Trace mode = trace average for continuous emissions, max hold for pulse emissions
4. Sweep time = auto couple
5. The trace was allowed to stabilize
6. Please see test notes below for RBW and VBW settings

4.6 Peak-Average Ratio

Measurement Procedure: FCC KDB 971168 D01 V03r01 Section 5.7.1

A peak to average ratio measurement is performed at the conducted port of the EUT. For WCDMA signals, the spectrum analyzers Complementary Cumulative Distribution Function (CCDF) measurement profile is used to determine the largest deviation between the average and the peak power of the EUT in a given bandwidth. The CCDF curve shows how much time the peak waveform spends at or above a given average power level. The percent of time the signal spends at or above the level defines the probability for that particular power level. For GSM signals, an average and a peak trace are used on a spectrum analyzer to determine the largest deviation between the average and the peak power of the EUT in a bandwidth greater than the emission bandwidth. The traces are generated with the spectrum analyzer set to zero span mode.

Remark: Reference test setup 1



Unless otherwise agreed in writing, this document is issued by the Company subject to its General Conditions of Service printed overleaf, available on request or accessible at <http://www.sgs.com/en/Terms-and-Conditions.aspx> and, for electronic format documents, subject to Terms and Conditions for Electronic Documents at <http://www.sgs.com/en/Terms-and-Conditions/Terms-e-Document.aspx>. Attention is drawn to the limitation of liability, indemnification and jurisdiction issues defined therein. Any holder of this document is advised that information contained hereon reflects the Company's findings at the time of its intervention only and within the limits of Client's instructions, if any. The Company's sole responsibility is to its Client and this document does not exonerate parties to a transaction from exercising all their rights and obligations under the transaction documents. This document cannot be reproduced except in full, without prior written approval of the Company. Any unauthorized alteration, forgery or falsification of the content or appearance of this document is unlawful and offenders may be prosecuted to the fullest extent of the law. Unless otherwise stated the results shown in this test report refer only to the sample(s) tested and such sample(s) are retained for 30 days only.
Attention: To check the authenticity of testing /inspection report & certificate, please contact us at telephone: (86-755) 8307 1443, or email: CN.Doccheck@sgs.com

Test Settings

1. The signal analyzer's CCDF measurement profile is enabled
2. Frequency = carrier center frequency
3. Measurement BW > Emission bandwidth of signal
4. The signal analyzer was set to collect one million samples to generate the CCDF curve
5. The measurement interval was set depending on the type of signal analyzed. For continuous signals (>98% duty cycle), the measurement interval was set to 1ms. For burst transmissions, the spectrum analyzer is set to use an internal "RF Burst" trigger that is synced with an incoming pulse and the measurement interval is set to less than the duration of the "on time" of one burst to ensure that energy is only captured during a time in which the transmitter is operating at maximum power

4.7 Field Strength of Spurious Radiation

Measurement Procedure: FCC KDB 971168 D01 V03r01

Below 1GHz test procedure as below:

- 1). The EUT was powered ON and placed on a 80cm high table in the chamber. The antenna of the transmitter was extended to its maximum length.
- 2). The disturbance of the transmitter was maximized on the test receiver display by raising and lowering from 1m to 4m (for the test frequency of below 30MHz, the antenna was tuned to heights 1 meter) the receive antenna and by rotating through 360° the turntable. After the fundamental emission was maximized, a field strength measurement was made.
- 3). Steps 1) and 2) were performed with the EUT and the receive antenna in both vertical and horizontal polarization.
- 4). The transmitter was then removed and replaced with another antenna. The center of the antenna was approximately at the same location as the center of the transmitter.
- 5). A signal at the disturbance was fed to the substitution antenna by means of a non-radiating cable. With both the substitution and the receive antennas horizontally polarized, the receive antenna was raised and lowered to obtain a maximum reading at the test receiver. The level of the signal generator was adjusted until the measured field strength level in step 2) is obtained for this set of conditions.
- 6). The output power into the substitution antenna was then measured.
- 7). Steps 5) and 6) were repeated with both antennas polarized.
- 8) Calculate power in dBm by the following formula:

$$\text{ERP(dBm)} = \text{Pg(dBm)} - \text{cable loss (dB)} + \text{antenna gain (dBd)}$$

Where:

Pd is the dipole equivalent power, Pg is the generator output into the substitution antenna, and the antenna gain is the gain of the substitute antenna used relative to either a half-wave dipole (dBd) or an isotropic source (dBi). The substitute level is equal to Pg [dBm] – cable loss [dB]. The calculated Pd levels are then compared to the absolute spurious emission limit of -13dBm which is equivalent to the required minimum attenuation of 43 + 10log10(Power [Watts]).

Above 1GHz test procedure as below:

- 1) Different between above is the test site, change from Semi- Anechoic Chamber to fully Anechoic Chamber



Unless otherwise agreed in writing, this document is issued by the Company subject to its General Conditions of Service printed overleaf, available on request or accessible at <http://www.sgs.com/en/Terms-and-Conditions.aspx> and, for electronic format documents, subject to Terms and Conditions for Electronic Documents at <http://www.sgs.com/en/terms-and-conditions/terms-e-document.aspx>. Attention is drawn to the limitation of liability, indemnification and jurisdiction issues defined therein. Any holder of this document is advised that information contained hereon reflects the Company's findings at the time of its intervention only and within the limits of Client's instructions, if any. The Company's sole responsibility is to its Client and this document does not exonerate parties to a transaction from exercising all their rights and obligations under the transaction documents. This document cannot be reproduced except in full, without prior written approval of the Company. Any unauthorized alteration, forgery or falsification of the content or appearance of this document is unlawful and offenders may be prosecuted to the fullest extent of the law. Unless otherwise stated the results shown in this test report refer only to the sample(s) tested and such sample(s) are retained for 30 days only.

Attention: To check the authenticity of testing /inspection report & certificate, please contact us at telephone: (86-755) 8307 1443, or email: CN.Doccheck@sgs.com

2) Calculate power in dBm by the following formula:

$$\text{EIRP(dBm)} = \text{Pg(dBm)} - \text{cable loss (dB)} + \text{antenna gain (dBi)}$$

$$\text{EIRP} = \text{ERP} + 2.15 \text{dB}$$

Where:

Pg is the generator output power into the substitution antenna.

3. Test the EUT in the lowest channel, the middle channel the Highest channel

4. The radiation measurements are performed in X, Y, Z axis positioning. And found the X axis positioning which it is worse case, Only the test worst case mode is recorded in the report.

5. Repeat above procedures until all frequencies measured was complete

Remark: Reference test setup 3

4.8 Frequency Stability / Temperature Variation

Measurement Procedure:

Frequency stability testing is performed in accordance with the guidelines of FCC KDB 971168 D01 V03r01; ANSI/C63.26 (2015)

. The frequency stability of the transmitter is measured by:

- a.) **Temperature:** The temperature is varied from -30°C to +50°C in 10°C increments using an environmental chamber.
- b.) **Primary Supply Voltage:** The primary supply voltage is varied from 85% to 115% of the nominal value for non hand-carried battery and AC powered equipment. For hand-carried, battery-powered equipment, primary supply voltage is reduced to the battery operating end point which shall be specified by the manufacturer.

Specification – The frequency stability shall be sufficient to ensure that the fundamental emission stays within the authorized frequency block. The frequency stability of the transmitter shall be maintained within $\pm 0.00025\%$ (± 2.5 ppm) of the center frequency.

Time Period and Procedure:

1. The carrier frequency of the transmitter is measured at room temperature (20°C to provide a reference).
2. The equipment is turned on in a “standby” condition for fifteen minutes before applying power to the transmitter. Measurement of the carrier frequency of the transmitter is made within one minute after applying power to the transmitter.
3. Frequency measurements are made at 10°C intervals ranging from -30°C to +50°C. A period of at least one half-hour is provided to allow stabilization of the equipment at each temperature level.

Remark: Reference test setup 4



Unless otherwise agreed in writing, this document is issued by the Company subject to its General Conditions of Service printed overleaf, available on request or accessible at <http://www.sgs.com/en/Terms-and-Conditions.aspx> and, for electronic format documents, subject to Terms and Conditions for Electronic Documents at <http://www.sgs.com/en/terms-and-conditions/terms-e-document.aspx>. Attention is drawn to the limitation of liability, indemnification and jurisdiction issues defined therein. Any holder of this document is advised that information contained hereon reflects the Company's findings at the time of its intervention only and within the limits of Client's instructions, if any. The Company's sole responsibility is to its Client and this document does not exonerate parties to a transaction from exercising all their rights and obligations under the transaction documents. This document cannot be reproduced except in full, without prior written approval of the Company. Any unauthorized alteration, forgery or falsification of the content or appearance of this document is unlawful and offenders may be prosecuted to the fullest extent of the law. Unless otherwise stated the results shown in this test report refer only to the sample(s) tested and such sample(s) are retained for 30 days only.
Attention: To check the authenticity of testing /inspection report & certificate, please contact us at telephone: (86-755) 8307 1443, or email: CN.Doccheck@sgs.com

4.9 Test Setups

4.9.1 Test Setup 1

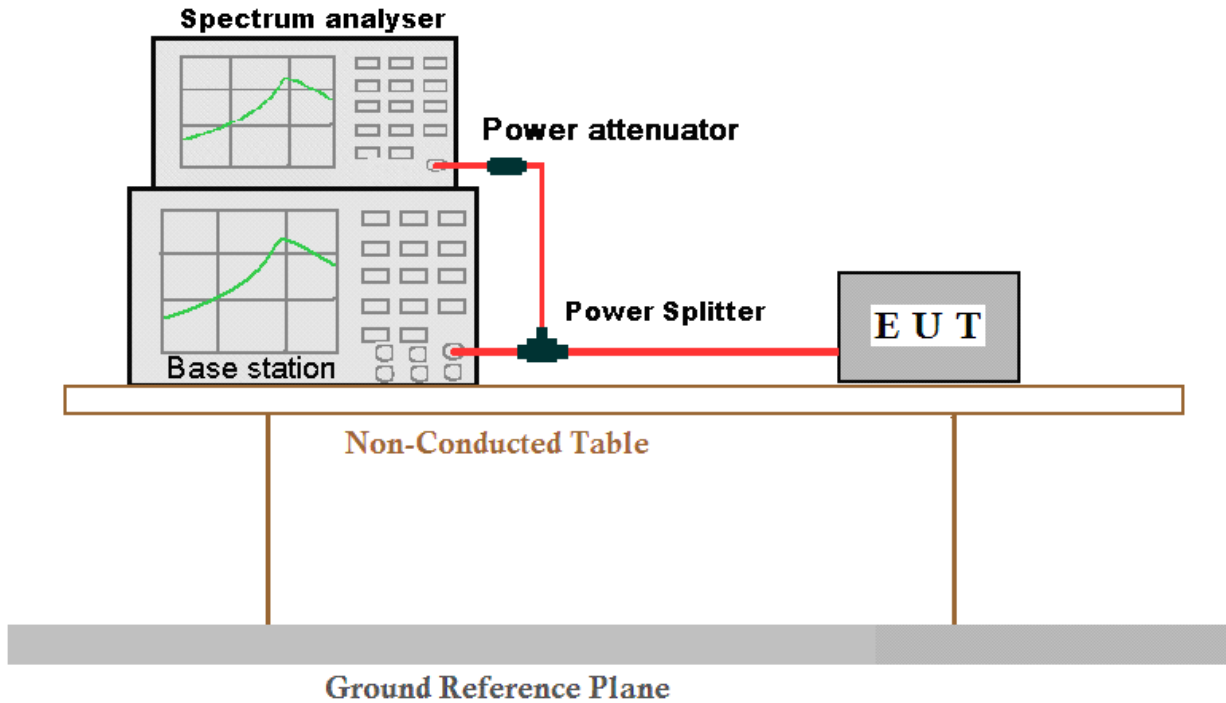

4.9.2 Test Setup 2

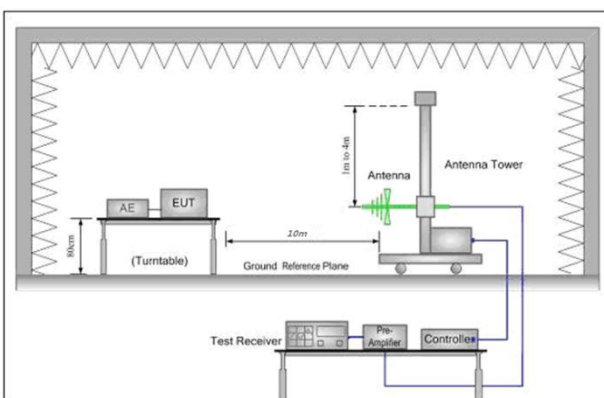

Figure 1. 30MHz to 1GHz

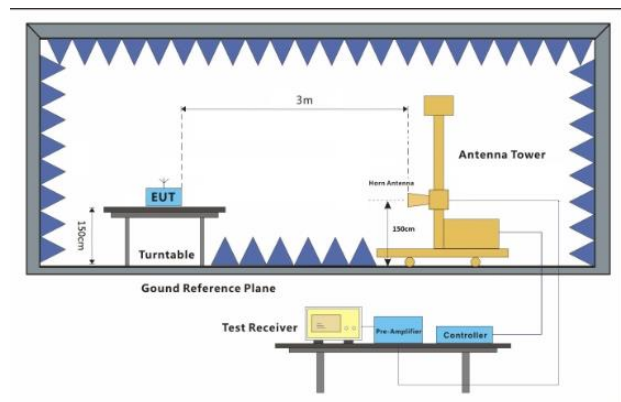

Figure 2. above 1GHz



Unless otherwise agreed in writing, this document is issued by the Company subject to its General Conditions of Service printed overleaf, available on request or accessible at <http://www.sgs.com/en/Terms-and-Conditions.aspx> and, for electronic format documents, subject to Terms and Conditions for Electronic Documents at <http://www.sgs.com/en/Terms-and-Conditions/Terms-e-Documents.aspx>. Attention is drawn to the limitation of liability, indemnification and jurisdiction issues defined therein. Any holder of this document is advised that information contained hereon reflects the Company's findings at the time of its intervention only and within the limits of Client's instructions, if any. The Company's sole responsibility is to its Client and this document does not exonerate parties to a transaction from exercising all their rights and obligations under the transaction documents. This document cannot be reproduced except in full, without prior written approval of the Company. Any unauthorized alteration, forgery or falsification of the content or appearance of this document is unlawful and offenders may be prosecuted to the fullest extent of the law. Unless otherwise stated the results shown in this test report refer only to the sample(s) tested and such sample(s) are retained for 30 days only.

4.9.3 Test Setup 3

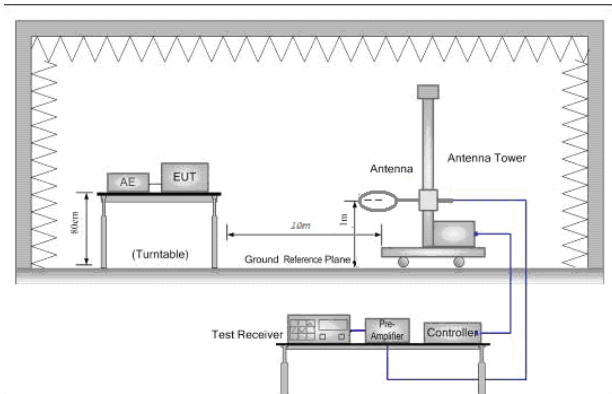

Figure 1. Below 30MHz

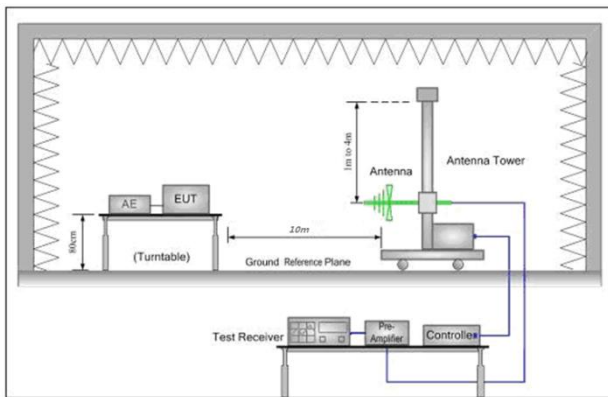

Figure 2. 30MHz to 1GHz

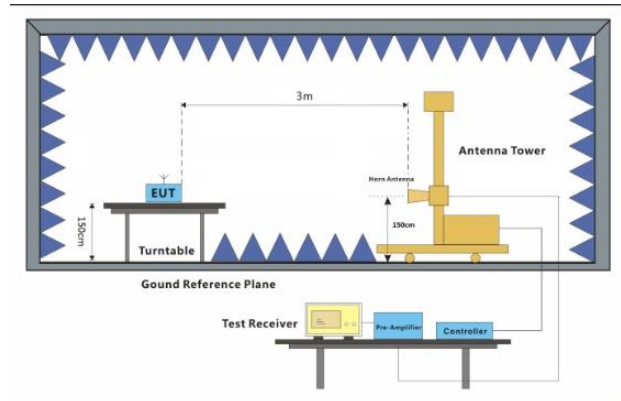
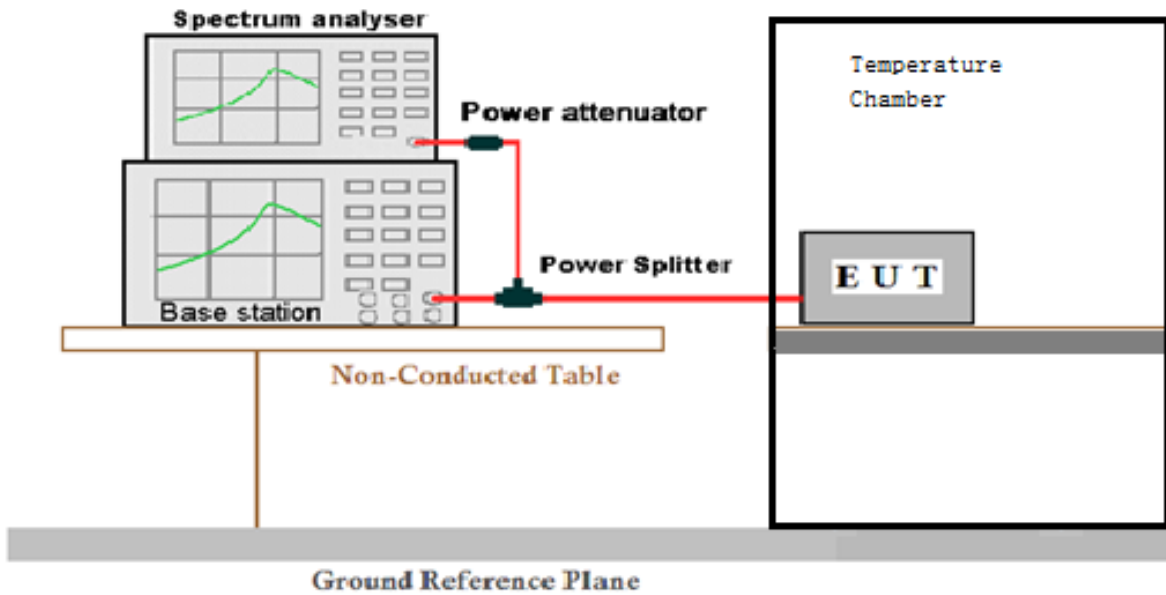

Figure 3. above 1GHz



Unless otherwise agreed in writing, this document is issued by the Company subject to its General Conditions of Service printed overleaf, available on request or accessible at <http://www.sgs.com/en/Terms-and-Conditions.aspx> and, for electronic format documents, subject to Terms and Conditions for Electronic Documents at <http://www.sgs.com/en/terms-and-conditions/terms-e-document.aspx>. Attention is drawn to the limitation of liability, indemnification and jurisdiction issues defined therein. Any holder of this document is advised that information contained hereon reflects the Company's findings at the time of its intervention only and within the limits of Client's instructions, if any. The Company's sole responsibility is to its Client and this document does not exonerate parties to a transaction from exercising all their rights and obligations under the transaction documents. This document cannot be reproduced except in full, without prior written approval of the Company. Any unauthorized alteration, forgery or falsification of the content or appearance of this document is unlawful and offenders may be prosecuted to the fullest extent of the law. Unless otherwise stated the results shown in this test report refer only to the sample(s) tested and such sample(s) are retained for 30 days only.

4.9.4 Test Setup 4



Unless otherwise agreed in writing, this document is issued by the Company subject to its General Conditions of Service printed overleaf, available on request or accessible at <http://www.sgs.com/en/Terms-and-Conditions.aspx> and, for electronic format documents, subject to Terms and Conditions for Electronic Documents at <http://www.sgs.com/en/terms-and-conditions/terms-e-document.aspx>. Attention is drawn to the limitation of liability, indemnification and jurisdiction issues defined therein. Any holder of this document is advised that information contained hereon reflects the Company's findings at the time of its intervention only and within the limits of Client's instructions, if any. The Company's sole responsibility is to its Client and this document does not exonerate parties to a transaction from exercising all their rights and obligations under the transaction documents. This document cannot be reproduced except in full, without prior written approval of the Company. Any unauthorized alteration, forgery or falsification of the content or appearance of this document is unlawful and offenders may be prosecuted to the fullest extent of the law. Unless otherwise stated the results shown in this test report refer only to the sample(s) tested and such sample(s) are retained for 30 days only.
Attention: To check the authenticity of testing /inspection report & certificate, please contact us at telephone: (86-755) 8307 1443, or email: CN.Doccheck@sgs.com

4.10 Test Conditions

Test Case		Test Conditions	
Transmit Output Power Data	Average Power, Total	Test Environment	Ambient Climate & Rated Voltage
		Test Setup	Test Setup 1
		RF Channels (TX)	L, M, H (L= low channel, M= middle channel, H= high channel)
		Test Mode	LTE/TM1;LTE/TM2
	Average Power, Spectral Density (if required)	Test Environment	Ambient Climate & Rated Voltage
		Test Setup	Test Setup 1
		RF Channels (TX)	L, M, H (L= low channel, M= middle channel, H= high channel)
		Test Mode	LTE/TM1;LTE/TM2
Peak-to-Average Ratio (if required)	Test Environment	Ambient Climate & Rated Voltage	
	Test Setup	Test Setup 1	
	RF Channels (TX)	L, M, H (L= low channel, M= middle channel, H= high channel)	
	Test Mode	LTE/TM1;LTE/TM2	
Modulation Characteristics	Test Environment	Ambient Climate & Rated Voltage	
	Test Setup	Test Setup 1	
	RF Channels (TX)	M (M= middle channel)	
	Test Mode	LTE/TM1;LTE/TM2	
Bandwidth	Occupied Bandwidth	Test Environment	Ambient Climate & Rated Voltage
		Test Setup	Test Setup 1
		RF Channels (TX)	L, M, H (L= low channel, M= middle channel, H= high channel)
		Test Mode	LTE/TM1;LTE/TM2
	Emission Bandwidth (if required)	Test Environment	Ambient Climate & Rated Voltage
		Test Setup	Test Setup 1
		RF Channels (TX)	L, M, H (L= low channel, M= middle channel, H= high channel)
		Test Mode	LTE/TM1;LTE/TM2
Band Edges Compliance	Test Environment	Ambient Climate & Rated Voltage	
	Test Setup	Test Setup 1	
	RF Channels (TX)	L, H (L= low channel, H= high channel)	
	Test Mode	LTE/TM1;LTE/TM2	
Spurious Emission at	Test Environment	Ambient Climate & Rated Voltage	



Unless otherwise agreed in writing, this document is issued by the Company subject to its General Conditions of Service printed overleaf, available on request or accessible at <http://www.sgs.com/en/Terms-and-Conditions.aspx> and, for electronic format documents, subject to Terms and Conditions for Electronic Documents at <http://www.sgs.com/en/terms-and-conditions/terms-e-document.aspx>. Attention is drawn to the limitation of liability, indemnification and jurisdiction issues defined therein. Any holder of this document is advised that information contained hereon reflects the Company's findings at the time of its intervention only and within the limits of Client's instructions, if any. The Company's sole responsibility is to its Client and this document does not exonerate parties to a transaction from exercising all their rights and obligations under the transaction documents. This document cannot be reproduced except in full, without prior written approval of the Company. Any unauthorized alteration, forgery or falsification of the content or appearance of this document is unlawful and offenders may be prosecuted to the fullest extent of the law. Unless otherwise stated the results shown in this test report refer only to the sample(s) tested and such sample(s) are retained for 30 days only.
 Attention: To check the authenticity of testing/inspection report & certificate, please contact us at telephone: (86-755) 8307 1443, or email: CN.Doccheck@sgs.com

Antenna Terminals	Test Setup	Test Setup 1
	RF Channels (TX)	L,M, H (L= low channel, M= middle channel, H= high channel)
	Test Mode	LTE/TM1;LTE/TM2
Field Strength of Spurious Radiation	Test Environment	Ambient Climate & Rated Voltage
	Test Setup	Test Setup 2
	Test Mode	LTE/TM1;LTE/TM2 Remark: If applicable, the EUT conf. that has maximum power density (based on the equivalent power level) is selected.
	RF Channels (TX)	L, M, H (L= low channel, M= middle channel, H= high channel)
Frequency Stability	Test Environment	(1) -30 °C to +50 °C with step 10 °C at Rated Voltage; (2) VL, VN and VH of Rated Voltage at Ambient Climate.
	Test Setup	Test Setup 4
	RF Channels (TX)	L, M, H (L= low channel, M= middle channel, H= high channel)
	Test Mode	LTE/TM1;LTE/TM2



Unless otherwise agreed in writing, this document is issued by the Company subject to its General Conditions of Service printed overleaf, available on request or accessible at <http://www.sgs.com/en/Terms-and-Conditions.aspx> and, for electronic format documents, subject to Terms and Conditions for Electronic Documents at <http://www.sgs.com/en/terms-and-conditions/terms-e-document.aspx>. Attention is drawn to the limitation of liability, indemnification and jurisdiction issues defined therein. Any holder of this document is advised that information contained hereon reflects the Company's findings at the time of its intervention only and within the limits of Client's instructions, if any. The Company's sole responsibility is to its Client and this document does not exonerate parties to a transaction from exercising all their rights and obligations under the transaction documents. This document cannot be reproduced except in full, without prior written approval of the Company. Any unauthorized alteration, forgery or falsification of the content or appearance of this document is unlawful and offenders may be prosecuted to the fullest extent of the law. Unless otherwise stated the results shown in this test report refer only to the sample(s) tested and such sample(s) are retained for 30 days only.
Attention: To check the authenticity of testing /inspection report & certificate, please contact us at telephone: (86-755) 8307 1443, or email: CN.Doccheck@sgs.com

5 Main Test Instruments

RE in Chamber					
Test Equipment	Manufacturer	Model No.	Inventory No.	Cal. date	Cal. Due date
				(yyyy-mm-dd)	(yyyy-mm-dd)
3m Semi-Anechoic Chamber	AUDIX	N/A	SEM001-02	2018/3/13	2021/3/12
Spectrum Analyzer (20Hz-43GHz)	Rohde & Schwarz	FSU43	SEM004-08	2019/3/2	2020/3/1
BiConiLog Antenna (26-3000MHz)	ETS-Lindgren	3142C	SEM003-01	2017/6/27	2020/6/26
Horn Antenna (800MHz-18GHz)	Rohde & Schwarz	HF907	SEM003-07	2018/4/13	2021/4/12
Horn Antenna (15-40GHz)	Schwarzbeck	BBHA 9170	SEM003-15	2017/10/17	2020/10/16
Amplifier (0.1-1300MHz)	HP	8447D	SEM005-02	2018/9/2	2019/9/2
Low Noise Amplifier (100MHz-18GHz)	Black Diamond Series	BDLNA-0118-352810	SEM005-05	2018/9/2	2019/9/2
Pre-Amplifier (0.1-26.5GHz)	Compliance Directions Systems Inc.	PAP-0126	EMC2063	2018/10/20	2019/10/19
Pre-amplifier (26-40GHz)	Compliance Directions Systems Inc.	PAP-2640-50	SEM005-08	2019/3/2	2020/3/1
Band filter	N/A	N/A	N/A	N/A	N/A
Measurement Software	AUDIX	e3 V8.2014-6-27	N/A	N/A	N/A
Coaxial Cable	SGS	N/A	SEM026-01	2019/6/12	2020/6/11
Wideband Radio Communication Tester	Anristu	MT8821C	6201462742	2019/4/3	2020/4/3
Wideband Radio Communication Tester	Rohde & Schwarz	CMW500	W005-02	2019/1/13	2020/1/12

RF conducted test					
Test Equipment	Manufacturer	Model No.	Inventory No.	Cal. date	Cal. Due date
				(yyyy-mm-dd)	(yyyy-mm-dd)
Dual Output Mobile Communication DC Source	Agilent Technologies Inc	66311B	W009-09	2018/11/2	2019/11/1
Signal Analyzer	Rohde & Schwarz	FSV	W005-02	2019/3/2	2020/3/1
Coaxial Cable	SGS	N/A	SEM031-01	2019/6/12	2020/6/11
Attenuator	Weinschel Associates	WA41	SEM021-09	N/A	N/A
Signal Generator	KEYSIGHT	N5173B	SEM006-05	2018/11/2	2019/11/1
Humidity/ Temperature Indicator	Shanghai Meteorological Industry Factory	HTC-1	W006-17	2018/11/2	2019/11/1
Temperature Chamber	GIANT FORCE	ICT-150-40-CP-AR	W027-03	2018/11/2	2019/11/1
Wideband Radio Communication Tester	Anristu	MT8821C	6201462742	2019/3/2	2020/3/1
Wideband Radio Communication Tester	Rohde & Schwarz	CMW500	W005-02	2018/11/2	2019/11/1



Unless otherwise agreed in writing, this document is issued by the Company subject to its General Conditions of Service printed overleaf, available on request or accessible at <http://www.sgs.com/en/Terms-and-Conditions.aspx> and, for electronic format documents, subject to Terms and Conditions for Electronic Documents at <http://www.sgs.com/en/terms-and-conditions/terms-e-document.aspx>. Attention is drawn to the limitation of liability, indemnification and jurisdiction issues defined therein. Any holder of this document is advised that information contained hereon reflects the Company's findings at the time of its intervention only and within the limits of Client's instructions, if any. The Company's sole responsibility is to its Client and this document does not exonerate parties to a transaction from exercising all their rights and obligations under the transaction documents. This document cannot be reproduced except in full, without prior written approval of the Company. Any unauthorized alteration, forgery or falsification of the content or appearance of this document is unlawful and offenders may be prosecuted to the fullest extent of the law. Unless otherwise stated the results shown in this test report refer only to the sample(s) tested and such sample(s) are retained for 30 days only.

Attention: To check the authenticity of testing / inspection report & certificate, please contact us at telephone: (86-755) 8307 1443, or email: CN.Doccheck@sgs.com



Test Equipment	Manufacturer	Model No.	Inventory No.	Cal. Date (yyyy-mm-dd)	Cal. Due date (yyyy-mm-dd)
3m Semi-Anechoic Chamber	AUDIX	N/A	SEM001-02	2018/3/13	2021/3/12
Wideband Radio Communication Tester	Anristu	MT8821C	6201462742	2019/4/3	2020/4/3
Wideband Radio Communication Tester	Rohde & Schwarz	CMW500	W005-02	2019/1/13	2020/1/12
EXA Signal Analyzer (10Hz-26.5GHz)	Agilent Technologies Inc	N9010A	SEM004-09	2019/3/13	2020/3/12
Spectrum Analyzer (20Hz-43GHz)	Rohde & Schwarz	FSU43	SEM004-08	2019/3/2	2020/3/1
BiConiLog Antenna (26-3000MHz)	ETS-Lindgren	3142C	SEM003-01	2017/6/27	2020/6/26
Horn Antenna (800MHz-18GHz)	Rohde & Schwarz	HF907	SEM003-07	2018/4/13	2021/4/12
Horn Antenna (15-40GHz)	Schwarzbeck	BBHA 9170	SEM003-15	2017/10/17	2020/10/16
Amplifier (0.1-1300MHz)	HP	8447D	SEM005-02	2018/9/25	2019/9/24
Pre-Amplifier (0.1-26.5GHz)	Compliance Directions Systems Inc.	PAP-0126	SEM004-11	2018/9/27	2019/9/26
Pre-amplifier (26-40GHz)	Compliance Directions Systems Inc.	PAP-2640-50	SEM005-08	2019/3/2	2020/3/1
Band filter	N/A	N/A	N/A	N/A	N/A
Coaxial Cable	SGS	N/A	SEM026-01	2019/6/12	2020/6/11
Tunable Notch Filter WRCD1700/2000-0.2/40-10EEK	WAINRIGHT Instruments GMBH	N/A	N/A	N/A	N/A
Tunable Notch Filter WRCD800/960-0.2/40-10EEK	WAINRIGHT Instruments GMBH	N/A	N/A	N/A	N/A
HighPass Filter WHK1.2/15G-10SS	WAINRIGHT Instruments GMBH	N/A	N/A	N/A	N/A
HighPass Filter WHKX10-2700-3000-18000-40SS	WAINRIGHT Instruments GMBH	N/A	N/A	N/A	N/A
HighPass Filter WHKX7.0/26.5G-6SS	WAINRIGHT Instruments GMBH	N/A	N/A	N/A	N/A
Band Reject Filter WRCG 824/849-814/859-40/8SS	WAINRIGHT Instruments GMBH	N/A	N/A	N/A	N/A
Band Reject Filter WRCG 1850/1910-1835/1925-40/8SS	WAINRIGHT Instruments GMBH	N/A	N/A	N/A	N/A
Measurement Software	AUDIX	e3 V8.2014-6-27	N/A	N/A	N/A



Unless otherwise agreed in writing, this document is issued by the Company subject to its General Conditions of Service printed overleaf, available on request or accessible at <http://www.sgs.com/en/Terms-and-Conditions.aspx> and, for electronic format documents, subject to Terms and Conditions for Electronic Documents at <http://www.sgs.com/en/terms-and-conditions/terms-e-document.aspx>. Attention is drawn to the limitation of liability, indemnification and jurisdiction issues defined therein. Any holder of this document is advised that information contained hereon reflects the Company's findings at the time of its intervention only and within the limits of Client's instructions, if any. The Company's sole responsibility is to its Client and this document does not exonerate parties to a transaction from exercising all their rights and obligations under the transaction documents. This document cannot be reproduced except in full, without prior written approval of the Company. Any unauthorized alteration, forgery or falsification of the content or appearance of this document is unlawful and offenders may be prosecuted to the fullest extent of the law. Unless otherwise stated the results shown in this test report refer only to the sample(s) tested and such sample(s) are retained for 30 days only.

Attention: To check the authenticity of testing /inspection report & certificate, please contact us at telephone: (86-755) 8307 1443, or email: CN.Doccheck@sgs.com

6 Measurement Uncertainty

For a 95% confidence level ($k = 2$), the measurement expanded uncertainties for defined systems, in accordance with the recommendations of ISO 17025 as following:

Test Item	Extended Uncertainty	Data
Transmit Output Power Data	Power [dBm]	$U = \pm 0.37$ dB
Bandwidth	Magnitude [%]	$U = \pm 0.2\%$
Band Edge Compliance	Disturbance Power [dBm]	$U = \pm 2.0$ dB
Spurious Emissions, Conducted	Disturbance Power [dBm]	$U = \pm 2.0$ dB
Field Strength of Spurious Radiation	ERP[dBm]/EIRP [dBm]	For 3 m Chamber: $U = \pm 4.5$ dB (30 MHz to 1GHz) $U = \pm 3.3$ dB (above 1 GHz) For 10 m Chamber: $U = \pm 4.5$ dB (30 MHz to 1GHz) $U = \pm 3.2$ dB (above 1 GHz)
Frequency Stability	Frequency Accuracy [ppm]	$U = \pm 0.24$ ppm

7 Appendixes

Appendix A	Photographs of EUT Constructional Details for ZR201940030
Appendix B.1	LTE Band 2
Appendix B.2	LTE Band 4
Appendix B.3	LTE Band 5
Appendix B.4	LTE Band 12
Appendix B.5	LTE Band 66
Appendix B.6	LTE Band 71

The End



Unless otherwise agreed in writing, this document is issued by the Company subject to its General Conditions of Service printed overleaf, available on request or accessible at <http://www.sgs.com/en/Terms-and-Conditions.aspx> and, for electronic format documents, subject to Terms and Conditions for Electronic Documents at <http://www.sgs.com/en/terms-and-conditions/terms-e-document.aspx>. Attention is drawn to the limitation of liability, indemnification and jurisdiction issues defined therein. Any holder of this document is advised that information contained hereon reflects the Company's findings at the time of its intervention only and within the limits of Client's instructions, if any. The Company's sole responsibility is to its Client and this document does not exonerate parties to a transaction from exercising all their rights and obligations under the transaction documents. This document cannot be reproduced except in full, without prior written approval of the Company. Any unauthorized alteration, forgery or falsification of the content or appearance of this document is unlawful and offenders may be prosecuted to the fullest extent of the law. Unless otherwise stated the results shown in this test report refer only to the sample(s) tested and such sample(s) are retained for 30 days only.
 Attention: To check the authenticity of testing /inspection report & certificate, please contact us at telephone: (86-755) 8307 1443, or email: CN.Doccheck@sgs.com