



FCC 47 CFR PART 15 SUBPART C

for

Tablet Computer

Model: A8003

Marketing Name: B3-A50XXX(X=A-Z, a-z, 0-9 or black)

Brand: acer

Test Report Number:

C180521Z03-RP1-3

Issued Date: June 25, 2018

Issued for

Acer Incorporated

8F, 88, Sec 1, Xintai 5th Rd. Xizhi, New Taipei City 221 Taiwan, R.O.C

Issued by:

Compliance Certification Services (Shenzhen) Inc.

No.10-1 Mingkeda Logistics park, No.18, Huanguan South Rd.,

Guan Lan Town, Baoan District, Shenzhen, China

TEL: 86-755-28055000

FAX: 86-755-28055221

E-Mail: service@ccssz.com



中国认可
国际互认
检测

TESTING

CNAS L4818



Certificate Number: 2861.01

Note: This report shall not be reproduced except in full, without the written approval of Compliance Certification Services (Shenzhen) Inc. This document may be altered or revised by Compliance Certification Services (Shenzhen) Inc. personnel only, and shall be noted in the revision section of the document. The client should not use it to claim product endorsement by TAF, A2LA, NVLAP, NIST or any government agencies. The test results in the report only apply to the tested sample.



Revision History

Rev.	Issue Date	Revisions	Effect Page	Revised By
00	June 25, 2018	Initial Issue	ALL	Sinphy Xie



TABLE OF CONTENTS

1 TEST CERTIFICATION 4

2 TEST RESULT SUMMARY 5

3 EUT DESCRIPTION..... 6

4 TEST METHODOLOGY..... 8

 4.1. DESCRIPTION OF TEST MODES 8

5 SETUP OF EQUIPMENT UNDER TEST 10

 5.1. DESCRIPTION OF SUPPORT UNITS..... 10

 5.2. CONFIGURATION OF SYSTEM UNDER TEST 10

6 FACILITIES AND ACCREDITATIONS 11

 6.1. FACILITIES 11

 6.2. ACCREDITATIONS 11

 6.3. MEASUREMENT UNCERTAINTY..... 11

7 FCC PART 15.247 REQUIREMENTS 12

 7.1. POWER LINE CONDUCTED EMISSIONS MEASUREMENT 12

 7.2. SPURIOUS EMISSIONS MEASUREMENT 19

 7.3. 6dB BANDWIDTH MEASUREMENT 55

 7.4. ANTENNA GAIN 63

 7.5. PEAK OUTPUT POWER 64

 7.6. BAND EDGES MEASUREMENT 66

 7.7. PEAK POWER SPECTRAL DENSITY MEASUREMENT..... 84



1 TEST CERTIFICATION

Product	Tablet Computer
Model	A8003
Marketing Name	B3-A50XXX(X=A-Z, a-z, 0-9 or black)
Brand	acer
Tested	May21~ June 25, 2018
Applicant	Acer Incorporated 8F, 88, Sec 1, Xintai 5th Rd. Xizhi, New Taipei City 221 Taiwan, R.O.C
Manufacturer	Acer Incorporated 8F, 88, Sec 1, Xintai 5th Rd. Xizhi, New Taipei City 221 Taiwan, R.O.C

APPLICABLE STANDARDS			
Standard	Test Type	Standard	Test Type
15.207(a)	Power Line Conducted Emissions	15.247(d) 15.209(a)	<ul style="list-style-type: none"> ● Spurious Emissions ● Conducted Measurement ● Radiated Emissions
15.247(a)(2)	6dB Bandwidth Measurement	15.247(b)(3) 15.247(b)(4)	Peak Power Measurement
15.247(d)	Band Edges Measurement	15.247(e)	Peak Power Spectral Density

We hereby certify that:

The above equipment was tested by Compliance Certification Services (Shenzhen) Inc. The test data, data evaluation, test procedures, and equipment configurations shown in this report were made in accordance with the procedures given in **ANSI C63.10: 2013** and the energy emitted by the sample EUT tested as described in this report is in compliance with the requirements of FCC Rules Part 15.207, 15.209, 15.247.

The test results of this report relate only to the tested sample EUT identified in this report.

Approved by:

Reviewed by:

Eve Wang
Supervisor of EMC Dept.
Compliance Certification Services (Shenzhen)
Inc.

Nancy Fu
Supervisor of Report Dept.
Compliance Certification Services (Shenzhen)
Inc.



2 TEST RESULT SUMMARY

APPLICABLE STANDARDS			
Standard	Test Type	Result	Remark
15.247(a)(2)	6dB Bandwidth Measurement	Pass	Meet the requirement of limit.
15.247(b)(3) 15.247(b)(4)	Peak Power Measurement	Pass	Meet the requirement of limit.
15.247(d)	Band Edges Measurement	Pass	Meet the requirement of limit.
15.247(e)	Peak Power Spectral Density	Pass	Meet the requirement of limit.
15.247(d) 15.209(a)	<ul style="list-style-type: none">● Spurious Emissions● Conducted Measurement● Radiated Emissions	Pass	Meet the requirement of limit.
15.207(a)	Power line Conducted Emissions	Pass	Meet the requirement of limit.

Note: 1. The statements of test result on the above are decided by the request of test standard only; the measurement uncertainties are not factored into this compliance determination.
2. The information of measurement uncertainty is available upon the customer's request.



3 EUT DESCRIPTION

Product	Tablet Computer
Model Number	A8003
Marketing Name	B3-A50XXX(X=A-Z, a-z, 0-9 or black)
Brand	acer
Model Discrepancy	N/A
Identify Number	C180521Z03-RP1-3
Received Date	May 21, 2018
Power Supply	DC5.35V or DC5.2V supplied by the Adapter or DC3.7V supplied by the battery
Adapter Specification	Adapter 1: DELTA ELECTRONICS, INC. MODEL: ADP-10HW A INPUT: 100-240Vac 0.4A 50/60Hz OUTPUT: 5.35Vdc 2A Adapter 2: LITE-ON TECHNOLOGY (CHANGZHOU)CO., LTD. MODEL: PA-1100-25 INPUT: 100-240Vac 0.3A 50/60Hz OUTPUT: 5.2Vdc 2.0A
Rechargeable Li-ion Polymer Battery Pack Specification	Battery 1: TCL Hyperpower Batteries Inc. Model: PR-279594N(1ICP3/95/94-2) Rating: 3.7V Charge Limited Voltage: 4.2V Rated Capacity: 6000mAh Rated Power: 22.2Wh Battery 2: Huizhou Highpower Technology Co.,LTD Model: HPP279594AB(1ICP3/95/94-2) Rating: 3.7V Charge Limited Voltage: 4.2V Rated Capacity/ Rated Power: Nominal 6100mAh/22.57Wh Minimum 6000mAh/22.20Wh
USB-Micro USB cable	Cable 1: Baisitai Unshielded, 0.80m Cable 2: Haixin Unshielded, 0.80m
Transmit Power	IEEE 802.11b mode: 16.01dBm IEEE 802.11g mode: 21.51dBm IEEE 802.11n HT20 MHz mode: 20.06dBm IEEE 802.11n HT40 MHz mode: 20.19dBm
Modulation Technique	IEEE 802.11b mode: DSSS(CCK,QPSK, BPSK) IEEE 802.11g mode: OFDM (BPSK/QPSK/16QAM/64QAM) IEEE 802.11n HT20 MHz mode: OFDM (BPSK/QPSK/16QAM/64QAM) IEEE 802.11n HT40 MHz mode: OFDM (BPSK/QPSK/16QAM/64QAM)



Transmit Data Rate	IEEE 802.11b: 11Mbps(CCK) with fall back rates of 5.5/2/1Mbps IEEE 802.11g: 54Mbps with fall back rates of 48/36/24/18/12/9 /6Mbps IEEE 802.11n HT20: 65Mbps with fall back rates of 65/58.5/52/ 39/26/19.5/13/6.5Mbps IEEE 802.11n HT40: 135Mbps with fall back rates of 135/121.5/108/ 81/54/40.5/27/13.5Mbps
Number of Channels	IEEE 802.11b mode: 11 Channels IEEE 802.11g mode: 11 Channels IEEE 802.11n HT20 MHz mode: 11 Channels IEEE 802.11n HT40 MHz mode: 7 Channels
Antenna Specification	FPC antenna with 1.59dBi gain (Max)
Channels Spacing	IEEE 802.11b/g ,802.11n HT20/HT40 : 5MHz
Temperature Range	0°C ~ +35°C
Hardware Version	A10L3_MB_V1.2
Software Version	Acer_AV000_B3-A50_RV00RB00_WW_GEN1

- Note:** 1. The sample selected for test was engineering sample that approximated to production product and was provided by manufacturer.
2. This submittal(s) (test report) is intended for FCC ID: HLZA8003 filing to comply with Section 15.207, 15.209 and 15.247 of the FCC Part 15, Subpart C Rules.



4 TEST METHODOLOGY

4.1. DESCRIPTION OF TEST MODES

The EUT has been tested under operating condition.

Used the “EngineerMode” software to control the EUT for staying in continuous transmitting and receiving mode is programmed.

Test Item	Test mode	Worse mode
All test modes are tested in the following test environments [WiFi worst(2.4G/5G) Link +BT Link +GPS/Glonass Link]		
Conducted Emission	Mode 1: Charge(Adapter 1+Cable 1+Battery 1)+Play Video (USB2.0)(AC120V/60Hz)	<input type="checkbox"/>
	Mode 2: Charge(Adapter 1+Cable 2+Battery 1)+Play Video (USB2.0) (AC120V/60Hz)	<input type="checkbox"/>
	Mode 3: Charge(Adapter 2+Cable 1+Battery 1)+Play Video(USB2.0)(AC120V/60Hz)	<input type="checkbox"/>
	Mode 4: Charge(Adapter 2+Cable 2+Battery 1)+Play Video(USB2.0)(AC120V/60Hz)	<input checked="" type="checkbox"/>
	Mode 5: Charge(Adapter 1+Cable 1+Battery 1)+ Record Video(TF Card) (AC120V/60Hz)	<input type="checkbox"/>
	Mode 6: Charge(Adapter 1+Cable 2+Battery 1)+ Record Video(TF Card) (AC120V/60Hz)	<input type="checkbox"/>
	Mode 7: Charge(Adapter 2+Cable 1+Battery 1)+Record Video (TF Card) (AC120V/60Hz)	<input type="checkbox"/>
	Mode 8: Charge(Adapter 2+Cable 2+Battery 1)+Record Video (TF Card) (AC120V/60Hz)	<input type="checkbox"/>
	Mode 9: Charge(Adapter 1+Cable 1+Battery 2)+Play Video(USB2.0) (AC120V/60Hz)	<input type="checkbox"/>
	Mode 10: Charge(Adapter 1+Cable 2+Battery 2)+Play Video(USB2.0) (AC120V/60Hz)	<input type="checkbox"/>
	Mode 11: Charge(Adapter 2+Cable 1+Battery 2)+Play Video(USB2.0)(AC120V/60Hz)	<input type="checkbox"/>
	Mode 12: Charge(Adapter 2+Cable 2+Battery 2)+Play Video(USB2.0)(AC120V/60Hz)	<input type="checkbox"/>
	Mode 13: Charge(Adapter 1+Cable 1+Battery 2)+Record Video(TF Card) (AC120V/60Hz)	<input type="checkbox"/>
	Mode 14: Charge(Adapter 1+Cable 2+Battery 2)+Record Video(TF Card) (AC120V/60Hz)	<input type="checkbox"/>
	Mode 15: Charge(Adapter 2+Cable 1+ Battery 2)+ Record Video (TF Card) (AC120V/60Hz)	<input type="checkbox"/>
	Mode 16: Charge(Adapter 2+Cable 2+ Battery 2)+ Record Video (TF Card) (AC120V/60Hz)	<input type="checkbox"/>
	Mode 17: Charge(Adapter 1+Cable 1+Battery 1)+Play Video (USB2.0)(AC240V/50Hz)	<input type="checkbox"/>
	Mode 18: Charge(Adapter 1+Cable 2+Battery 1)+Play Video (USB2.0) (AC240V/50Hz)	<input type="checkbox"/>
	Mode 19: Charge(Adapter 2+Cable 1+Battery 1)+Play Video(USB2.0)(AC240V/50Hz)	<input type="checkbox"/>
	Mode 20: Charge(Adapter 2+Cable 2+Battery 1)+Play Video(USB2.0)(AC240V/50Hz)	<input checked="" type="checkbox"/>
	Mode 21: Charge(Adapter 1+Cable 1+Battery 1)+ Record Video(TF Card)(AC240V/50Hz)	<input type="checkbox"/>
	Mode 22: Charge(Adapter 1+Cable 2+Battery 1)+ Record Video(TF Card)(AC240V/50Hz)	<input type="checkbox"/>
	Mode 23: Charge(Adapter 2+Cable 1+Battery 1)+Record Video (TF Card)(AC240V/50Hz)	<input type="checkbox"/>
	Mode 24: Charge(Adapter 2+Cable 2+Battery 1)+Record Video (TF Card)(AC240V/50Hz)	<input type="checkbox"/>
	Mode 25: Charge(Adapter 1+Cable 1+Battery 2)+Play Video(USB2.0) (AC240V/50Hz)	<input type="checkbox"/>



Conducted Emission	Mode 26: Charge(Adapter 1+Cable 2+Battery 2)+Play Video(USB2.0)(AC240V/50Hz)	<input type="checkbox"/>
	Mode 27: Charge(Adapter 2+Cable 1+Battery 2)+Play Video(USB2.0)(AC240V/50Hz)	<input type="checkbox"/>
	Mode 28: Charge(Adapter 2+Cable 2+Battery 2)+Play Video(USB2.0)(AC240V/50Hz)	<input type="checkbox"/>
	Mode 29: Charge(Adapter 1+Cable 1+Battery 2)+Record Video(TF Card)(AC240V/50Hz)	<input type="checkbox"/>
	Mode 30: Charge(Adapter 1+Cable 2+Battery 2)+Record Video(TF Card)(AC240V/50Hz)	<input type="checkbox"/>
	Mode 31: Charge(Adapter 2+Cable 1+ Battery 2)+ Record Video (TF Card)(AC240V/50Hz)	<input type="checkbox"/>
	Mode 32: Charge(Adapter 2+Cable 2+ Battery 2)+ Record Video (TF Card)(AC240V/50Hz)	<input type="checkbox"/>
Radiated Emission	Mode 1: Continuously Transmitting	<input checked="" type="checkbox"/>

After verification, all tests were carried out with the worst case test modes as shown below except radiated spurious emission below 1GHz, which worst case was in normal link mode only, and power line conducted emission below 30MHz, which worst case was in normal link mode.

IEEE802.11b mode: Channel Low (2412MHz), Channel Mid (2437MHz) and Channel High (2462MHz) with 1Mbps data rate were chosen for full testing.

IEEE802.11g mode: Channel Low (2412MHz), Channel Mid (2437MHz) and Channel High (2462MHz) with 6Mbps data rate were chosen for full testing.

IEEE 802.11n HT20 MHz mode: Channel Low (2412MHz), Channel Mid (2437MHz) and Channel High (2462MHz) with 6.5Mbps data rate were chosen for full testing.

IEEE 802.11n HT40 MHz mode: Channel Low (2422MHz), Channel Mid (2437MHz) and Channel High (2452MHz) with 13.5Mbps data rate were chosen for full testing.



5 SETUP OF EQUIPMENT UNDER TEST

5.1. DESCRIPTION OF SUPPORT UNITS

The EUT has been tested as an independent unit together with other necessary accessories or support units. The following support units or accessories were used to form a representative test configuration during the tests.

No.	Equipment	Model No.	Serial No.	FCC ID	Brand	Data Cable	Power Cord
1	Notebook	Thinkpad S2	SL 10K92342	N/A	Lenovo	N/A	Unshielded 1.00m (AC Cable) Unshielded 1.80m (DC Cable)
2	Earphone	G-3	N/A	N/A	GSG	Unshielded 1.20m	N/A
3	TF Card	MB-MP 16DA	N/A	N/A	SAMSUNG	N/A	N/A

Note:

Grounding was established in accordance with the manufacturer's requirements and conditions for the intended use.

5.2. CONFIGURATION OF SYSTEM UNDER TEST

See test photographs attached in Appendix II for the actual connections between EUT and support equipment.



6 FACILITIES AND ACCREDITATIONS

6.1. FACILITIES

All measurement facilities used to collect the measurement data are located at **No.10-1 Mingkeda Logistics park, No.18, Huanguan South Rd., Guan Lan Town, Baoan District, Shenzhen, China**

The sites are constructed in conformance with the requirements of ANSI C63.10, ANSI C63.7 and CISPR Publication 22. All receiving equipment conforms to CISPR Publication 16-1, "Radio Interference Measuring Apparatus and Measurement Methods."

6.2. ACCREDITATIONS

Our laboratories are accredited and approved by the following accreditation body according to ISO/IEC 17025.

USA	A2LA
China	CNAS

The measuring facility of laboratories has been authorized or registered by the following approval agencies.

USA	FCC
Japan	VCCI (C-4815,R-4320,T-2317, G-10624)
Canada	INDUSTRY CANADA

Copies of granted accreditation certificates are available for downloading from our web site, <http://www.ccssz.com>

6.3. MEASUREMENT UNCERTAINTY

Where relevant, the following measurement uncertainty levels have been estimated for tests performed on the EUT as specified in CISPR 16-4-2:

Parameter	Uncertainty
Radiated Emission, 30 to 200 MHz Test Site : 966(2)	+/-3.6880dB
Radiated Emission, 200 to 1000 MHz Test Site : 966(2)	+/-3.6695dB
Radiated Emission, 1 to 8 GHz	+/-5.1782dB
Radiated Emission, 8 to 18 GHz	+/-5.2173dB
Conducted Emissions	+/-3.6836dB
Band Width	178kHz
Peak Output Power MU	+/-1.906dB
Band Edge MU	+/-0.182dB
Channel Separation MU	416.178Hz
Duty Cycle MU	0.054ms
Frequency Stability MU	226Hz

This uncertainty represents an expanded uncertainty expressed at approximately the 95% confidence level using a coverage factor of k=2.

The measured result is above (below) the specification limit by a margin less than the measurement uncertainty; it is therefore not possible to state compliance based on the 95% level of confidence. However, the result indicates that compliance (non-compliance) is more probable than non-compliance) with the specification limit.



7 FCC PART 15.247 REQUIREMENTS

7.1. POWER LINE CONDUCTED EMISSIONS MEASUREMENT

7.1.1. LIMITS OF CONDUCTED EMISSIONS MEASUREMENT

According to §15.207(a), except as shown in paragraphs (b) and (c) of this section, for an intentional radiator that is designed to be connected to the public utility (AC) power line, the radio frequency voltage that is conducted back onto the AC power line on any frequency or frequencies within the band 150 kHz to 30 MHz shall not exceed the limits in the following table, as measured using a 50 μ H/50 ohms line impedance stabilization network (LISN). Compliance with the provisions of this paragraph shall be based on the measurement of the radio frequency voltage between each power line and ground at the power terminal. The lower limit applies at the boundary between the frequency ranges.

Frequency Range (MHz)	Limits (dB μ V)	
	Quasi-peak	Average
0.15 to 0.50	66 to 56*	56 to 46*
0.50 to 5	56	46
5 to 30	60	50

NOTE:

- (1) The lower limit shall apply at the transition frequencies.
- (2) The limit decreases in line with the logarithm of the frequency in the range of 0.15 to 0.50 MHz.
- (3) All emanations from a class A/B digital device or system, including any network of conductors and apparatus connected thereto, shall not exceed the level of field strengths specified above.

7.1.2. TEST INSTRUMENTS

Conducted Emission Test Site					
Name of Equipment	Manufacturer	Model Number	Serial Number	Last Calibration	Due Calibration
EMI TEST RECEIVER	ROHDE&SCHWARZ	ESCI	100783	01/27/2018	01/26/2019
LISN(EUT)	ROHDE&SCHWARZ	ENV216	101543-WX	01/27/2018	01/26/2019
LISN	EMCO	3825/2	8901-1459	01/27/2018	01/26/2019
Temp. / Humidity Meter	VICTOR	HTC-1	N/A	01/29/2018	01/28/2019
Test S/W	FARAD	EZ-EMC/ CCS-3A1-CE			

- NOTE:**
1. The calibration interval of the above test instruments is 12 months and the calibrations are traceable to NML/ROC and NIST/USA.
 2. N.C.R = No Calibration Request.



7.1.3. TEST PROCEDURES (please refer to measurement standard)

- The EUT and Support equipment, if needed, was placed on a non-conducted table, which is 0.8m above the ground plane and 0.4m away from the conducted wall.
- The test equipment EUT installed received AC main power, through a Line Impedance Stabilization Network (LISN), which supplied power source and was grounded to the ground plane. All support equipment power received from a second LISN. The two LISNs provide 50 ohm/ 50uH of coupling impedance for the measuring instrument.
- The EUT test program was started. Emissions were measured on each current carrying line of the EUT using an EMI Test Receiver connected to the LISN powering the EUT.
- The frequency range from 150 kHz to 30 MHz was searched. The test data of the worst-case condition(s) was recorded. Emission levels under limit 20dB were not recorded.



7.1.4. TEST SETUP

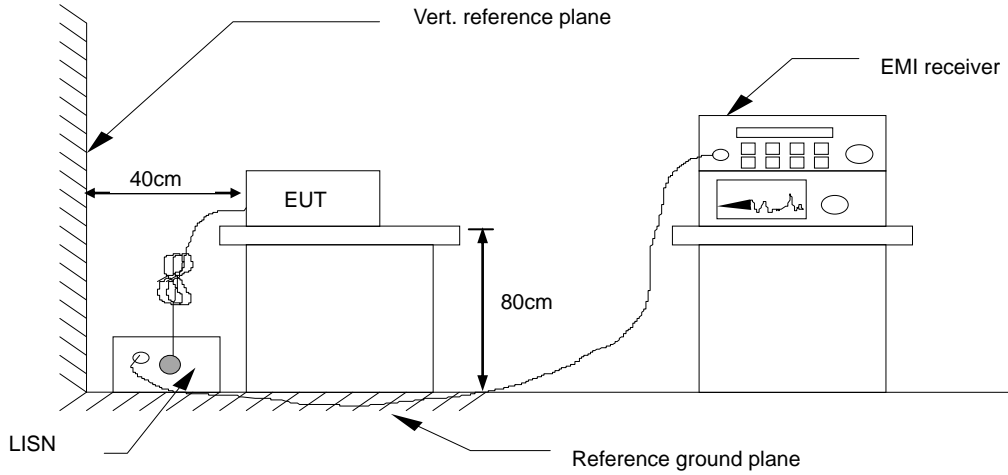

For the actual test configuration, please refer to the related item - Photographs of the Test Configuration.

7.1.5. DATA SAMPLE

Frequency (MHz)	QuasiPeak Reading (dBuV)	Average Reading (dBuV)	Correction Factor (dB)	QuasiPeak Result (dBuV)	Average Result (dBuV)	QuasiPeak Limit (dBuV)	Average Limit (dBuV)	QuasiPeak Margin (dB)	Average Margin (dB)	Remark (Pass/Fail)
X.XXXX	32.69	25.65	11.52	44.21	37.17	65.78	55.79	-21.57	-18.62	Pass

- Factor = Insertion loss of LISN + Cable Loss
- Result = Quasi-peak Reading/ Average Reading + Factor
- Limit = Limit stated in standard
- Margin = Result (dBuV) – Limit (dBuV)



7.1.6. TEST RESULTS

Model No.	A8003	RBW,VBW	9 kHz
Environmental Conditions	22°C, 45% RH	Test Mode	Mode 4
Tested by	Eason Nie	Line	L1
Test Date	May 30, 2018	Test Voltage	AC 120V/60Hz

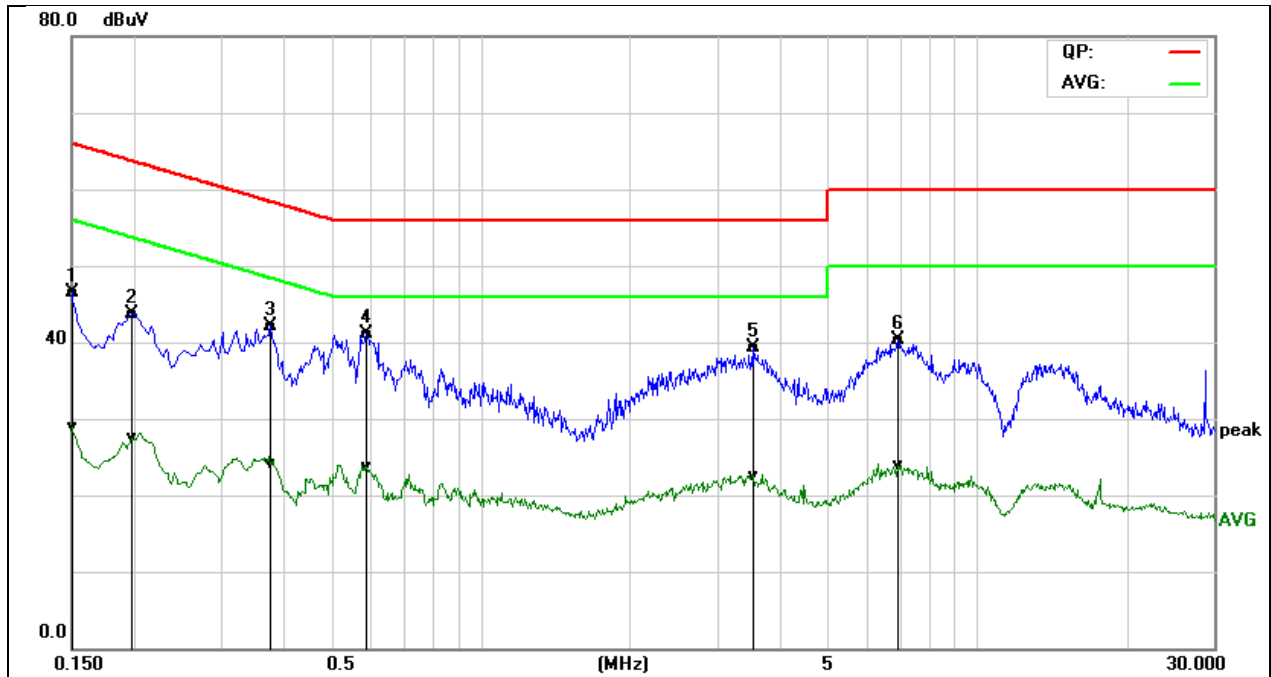

Frequency (MHz)	QuasiPeak Reading (dBuV)	Average Reading (dBuV)	Correction Factor (dB)	QuasiPeak Result (dBuV)	Average Result (dBuV)	QuasiPeak Limit (dBuV)	Average Limit (dBuV)	QuasiPeak Margin (dB)	Average Margin (dB)	Remark (Pass/Fail)
0.1500	26.80	9.38	19.62	46.42	29.00	65.99	56.00	-19.57	-27.00	Pass
0.1980	23.98	7.85	19.64	43.62	27.49	63.69	53.69	-20.07	-26.20	Pass
0.3780	22.53	4.60	19.57	42.10	24.17	58.32	48.32	-16.22	-24.15	Pass
0.5899	21.51	4.14	19.57	41.08	23.71	56.00	46.00	-14.92	-22.29	Pass
3.5380	19.61	2.75	19.73	39.34	22.48	56.00	46.00	-16.66	-23.52	Pass
6.9420	20.55	4.01	19.83	40.38	23.84	60.00	50.00	-19.62	-26.16	Pass

REMARKS: L1 = Line One (Live Line)



Model No.	A8003	RBW,VBW	9 kHz
Environmental Conditions	22°C, 45% RH	Test Mode	Mode 4
Tested by	Eason Nie	Line	L2
Test Date	May 30, 2018	Test Voltage	AC 120V/60Hz

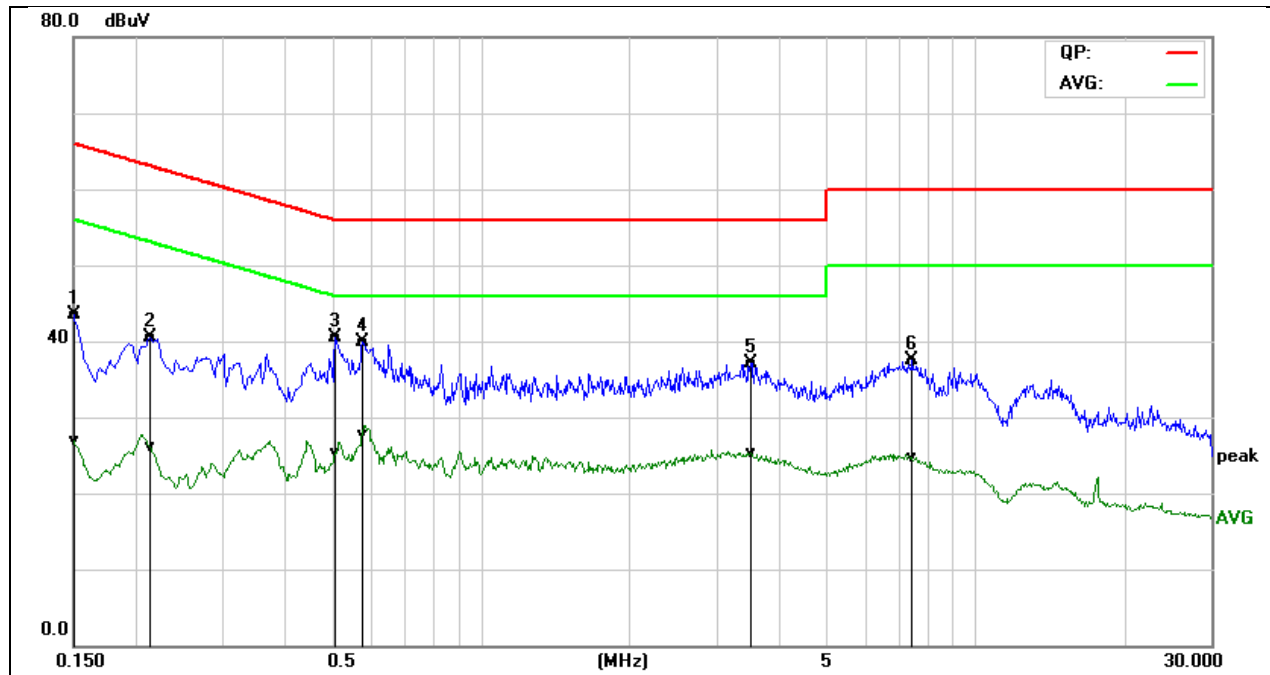

Frequency (MHz)	QuasiPeak Reading (dBuV)	Average Reading (dBuV)	Correction Factor (dB)	QuasiPeak Result (dBuV)	Average Result (dBuV)	QuasiPeak Limit (dBuV)	Average Limit (dBuV)	QuasiPeak Margin (dB)	Average Margin (dB)	Remark (Pass/Fail)
0.1500	23.93	7.37	19.52	43.45	26.89	65.99	56.00	-22.54	-29.11	Pass
0.2140	21.05	6.56	19.54	40.59	26.10	63.04	53.05	-22.45	-26.95	Pass
0.5100	20.93	5.73	19.53	40.46	25.26	56.00	46.00	-15.54	-20.74	Pass
0.5780	20.44	8.21	19.56	40.00	27.77	56.00	46.00	-16.00	-18.23	Pass
3.5140	17.33	5.47	19.77	37.10	25.24	56.00	46.00	-18.90	-20.76	Pass
7.4660	17.52	4.76	19.88	37.40	24.64	60.00	50.00	-22.60	-25.36	Pass

REMARKS: L2 = Line Two (Neutral Line)



Model No.	A8003	RBW,VBW	9 kHz
Environmental Conditions	22°C, 45% RH	Test Mode	Mode 20
Tested by	Eason Nie	Line	L1
Test Date	May 30, 2018	Test Voltage	AC 240V/50Hz

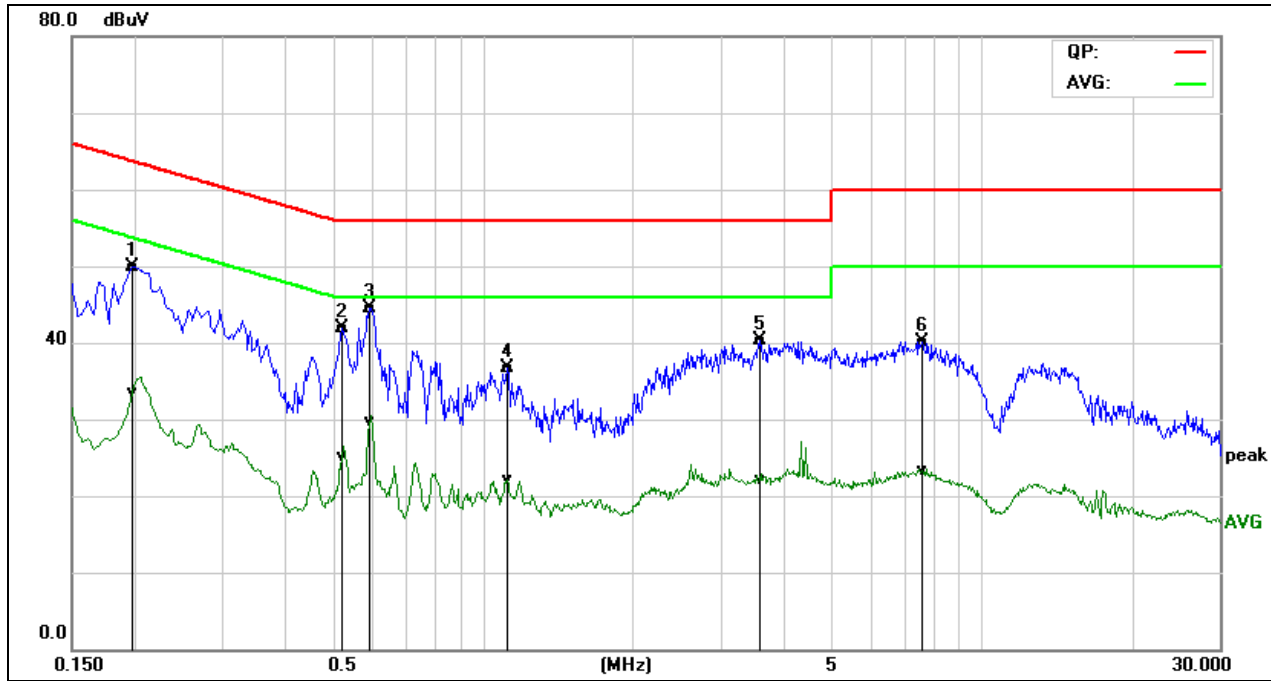

Frequency (MHz)	QuasiPeak Reading (dBuV)	Average Reading (dBuV)	Correction Factor (dB)	QuasiPeak Result (dBuV)	Average Result (dBuV)	QuasiPeak Limit (dBuV)	Average Limit (dBuV)	QuasiPeak Margin (dB)	Average Margin (dB)	Remark (Pass/Fail)
0.1980	30.30	13.78	19.64	49.94	33.42	63.69	53.69	-13.75	-20.27	Pass
0.5220	22.40	5.58	19.54	41.94	25.12	56.00	46.00	-14.06	-20.88	Pass
0.5940	25.01	10.06	19.57	44.58	29.63	56.00	46.00	-11.42	-16.37	Pass
1.1180	17.10	2.56	19.57	36.67	22.13	56.00	46.00	-19.33	-23.87	Pass
3.6020	20.53	2.46	19.73	40.26	22.19	56.00	46.00	-15.74	-23.81	Pass
7.6460	20.18	3.45	19.90	40.08	23.35	60.00	50.00	-19.92	-26.65	Pass

REMARKS: L1 = Line One (Live Line)



Model No.	A8003	RBW,VBW	9 kHz
Environmental Conditions	22°C, 45% RH	Test Mode	Mode 20
Tested by	Eason Nie	Line	L2
Test Date	May 30, 2018	Test Voltage	AC 240V/50Hz

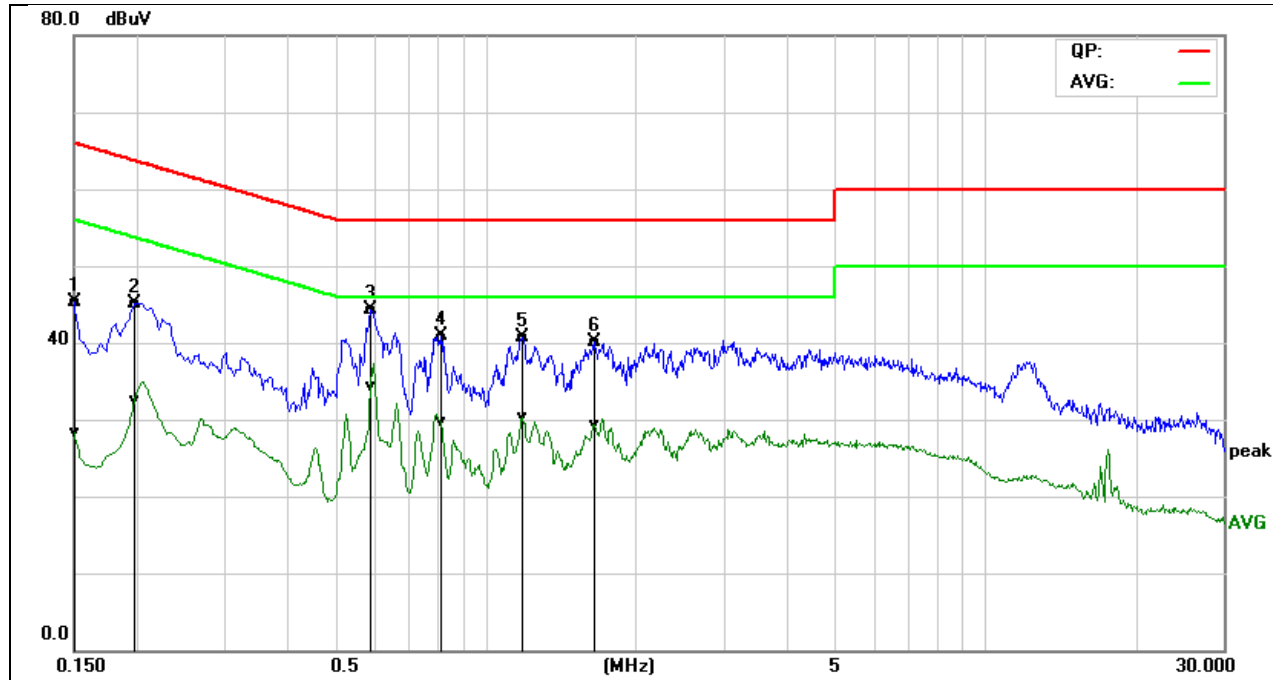

Frequency (MHz)	QuasiPeak Reading (dBuV)	Average Reading (dBuV)	Correction Factor (dB)	QuasiPeak Result (dBuV)	Average Result (dBuV)	QuasiPeak Limit (dBuV)	Average Limit (dBuV)	QuasiPeak Margin (dB)	Average Margin (dB)	Remark (Pass/Fail)
0.1500	25.74	8.75	19.52	45.26	28.27	65.99	56.00	-20.73	-27.73	Pass
0.1980	25.55	12.95	19.54	45.09	32.49	63.69	53.69	-18.60	-21.20	Pass
0.5899	24.65	14.79	19.57	44.22	34.36	56.00	46.00	-11.78	-11.64	Pass
0.8139	21.21	10.15	19.59	40.80	29.74	56.00	46.00	-15.20	-16.26	Pass
1.1900	21.05	10.77	19.58	40.63	30.35	56.00	46.00	-15.37	-15.65	Pass
1.6500	20.44	9.73	19.66	40.10	29.39	56.00	46.00	-15.90	-16.61	Pass

REMARKS: L2 = Line Two (Neutral Line)



7.2. SPURIOUS EMISSIONS MEASUREMENT

7.2.1. CONDUCTED EMISSIONS MEASUREMENT

7.2.1.1. LIMITS OF CONDUCTED EMISSIONS MEASUREMENT

§15.247(d) specifies that in any 100 kHz bandwidth outside of the authorized frequency band, the power shall be attenuated according to the following conditions:

If the peak output power procedure is used to measure the fundamental emission power to demonstrate compliance to 15.247(b)(3) requirements, then the peak conducted output power measured within any 100 kHz outside the authorized frequency band shall be attenuated by at least 20 dB relative to the maximum measured in-band peak PSD level.

If the average output power procedure is used to measure the fundamental emission power to demonstrate compliance to 15.247(b) (3) requirements, then the power in any 100 kHz outside of the authorized frequency band shall be attenuated by at least 30 dB relative to the maximum measured in-band average PSD level.

In addition, radiated emissions which fall in the restricted bands, as defined in §15.205(a), must also comply with the radiated emission limits specified in 15.209(a) (see Section 15.205(c)).

7.2.1.2. TEST INSTRUMENTS

Name of Equipment	Manufacturer	Model	Serial Number	Last Calibration	Due Calibration
Spectrum Analyzer	Agilent	N9010A	MY55370330	01/27/2018	01/26/2019

7.2.1.3. TEST PROCEDURE (please refer to measurement standard)

Conducted RF measurements of the transmitter output were made to confirm that the EUT antenna port conducted emissions meet the specified limit and to identify any spurious signals that require further investigation or measurements on the radiated emissions site.

The transmitter output is connected to the spectrum analyzer. The resolution bandwidth is set to 100 kHz. The video bandwidth is set to 300 kHz.

Measurements are made over the 9 kHz to 26GHz range with the transmitter set to the lowest, middle, and highest channels. No emission found between lowest internal used/generated frequency to 10MHz · it is only recorded 10MHz to 26GHz.



7.2.1.4. TEST RESULTS

Test Plot IEEE 802.11b mode

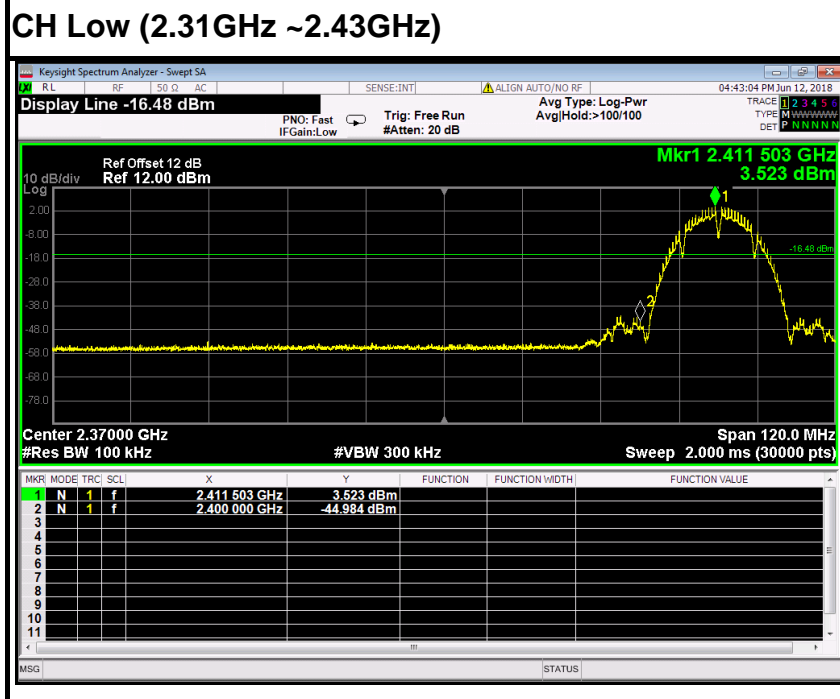
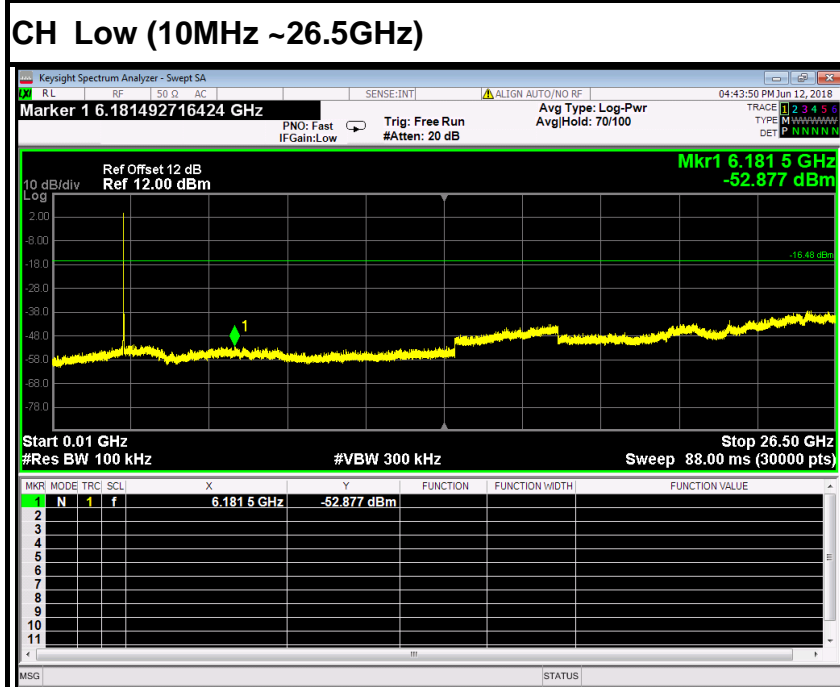

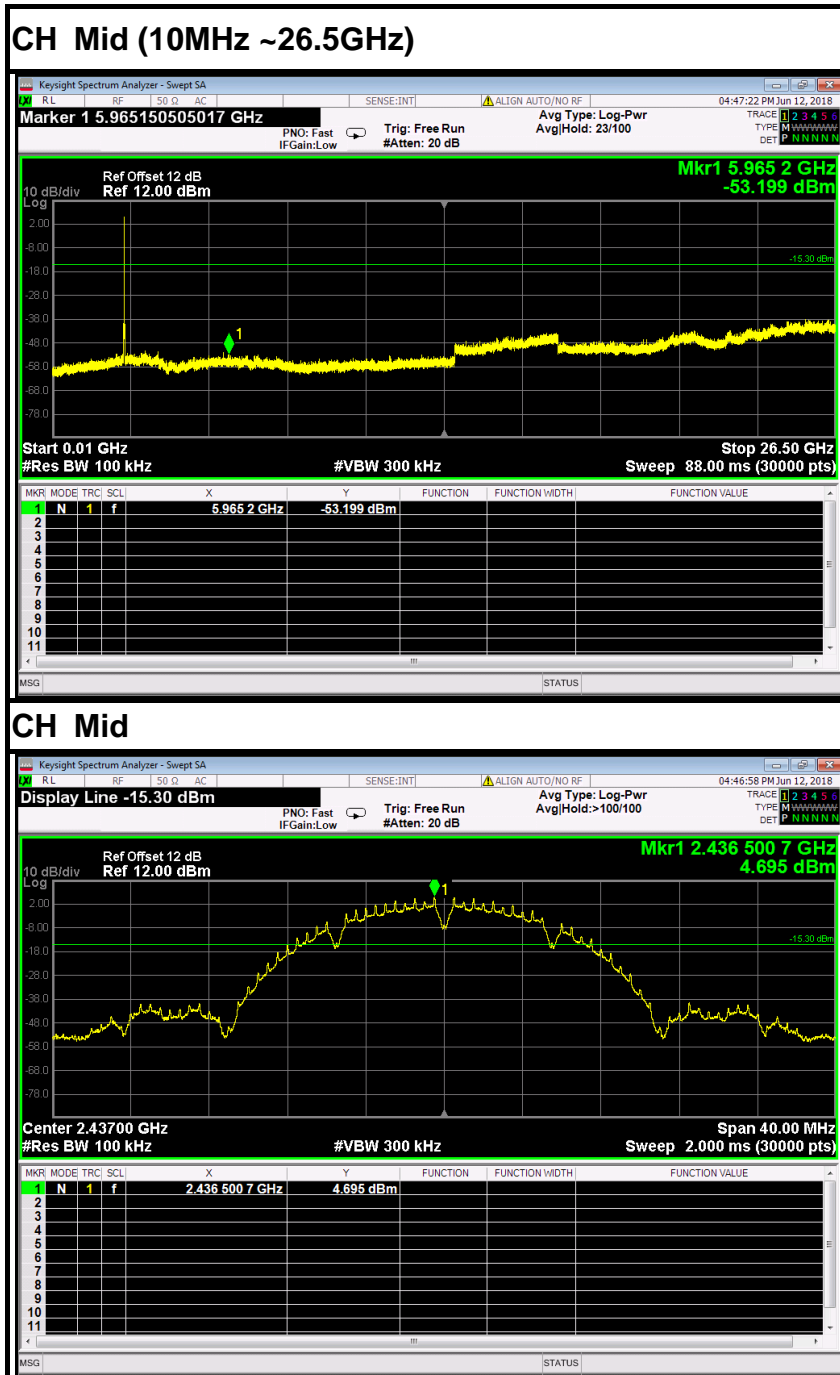

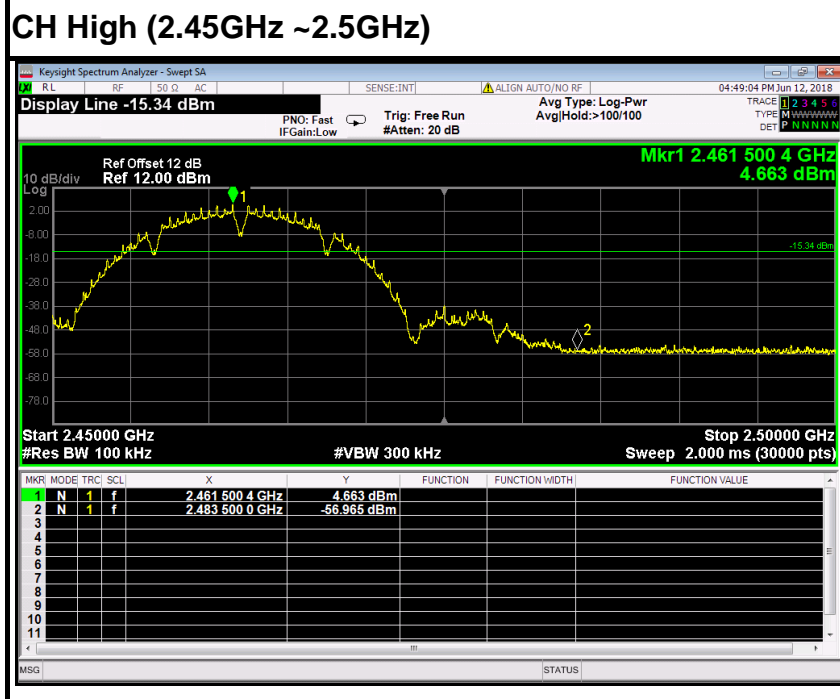
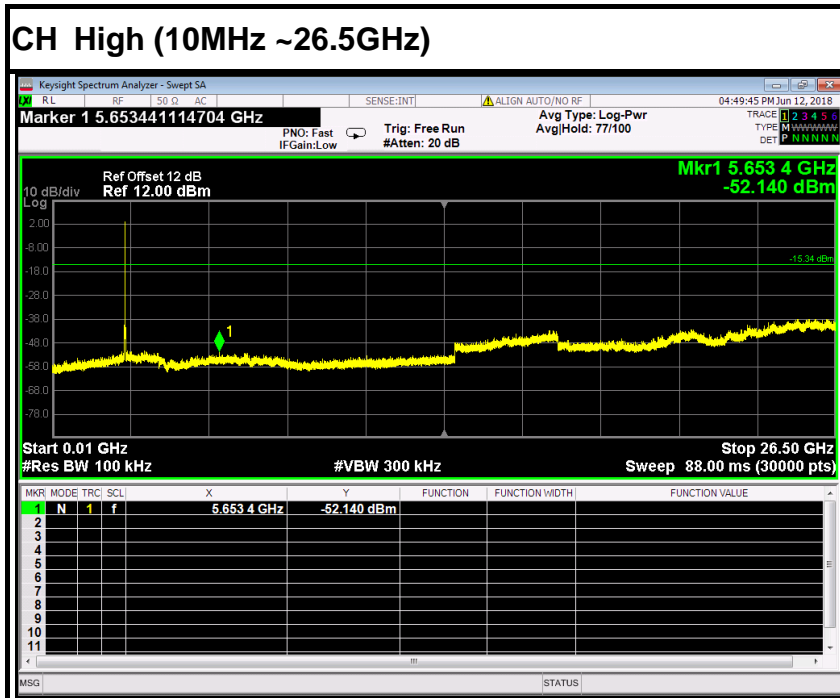



IEEE 802.11g mode

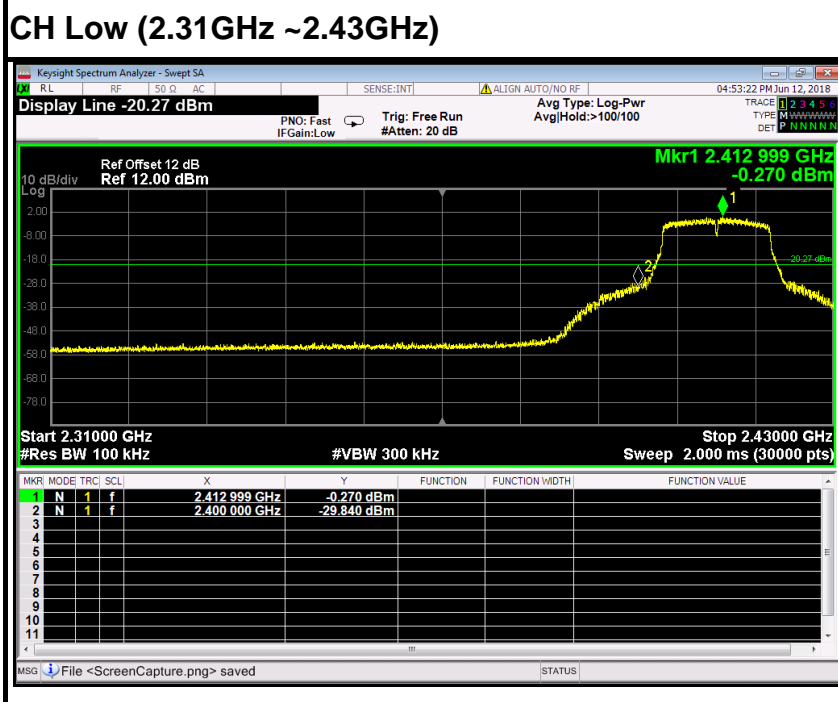
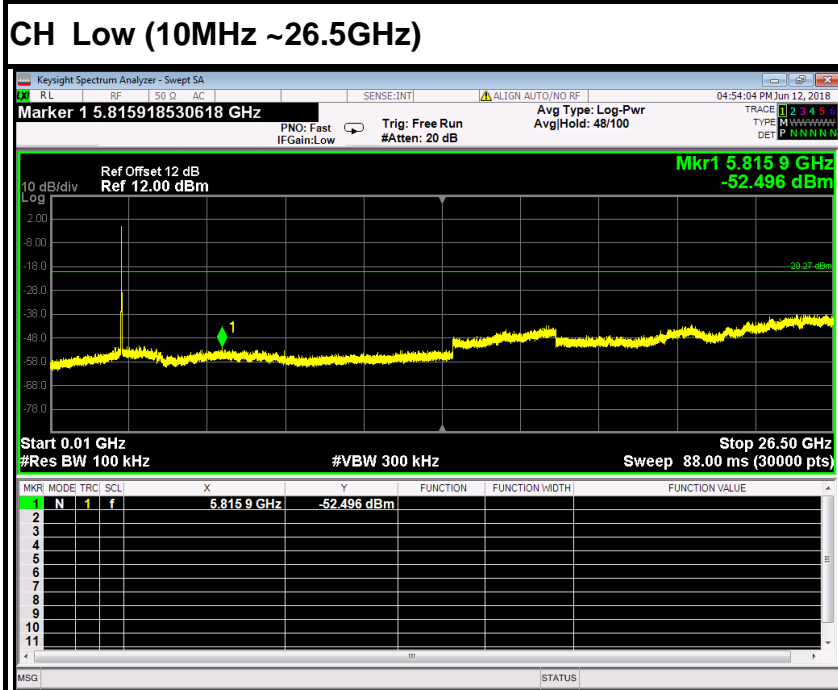

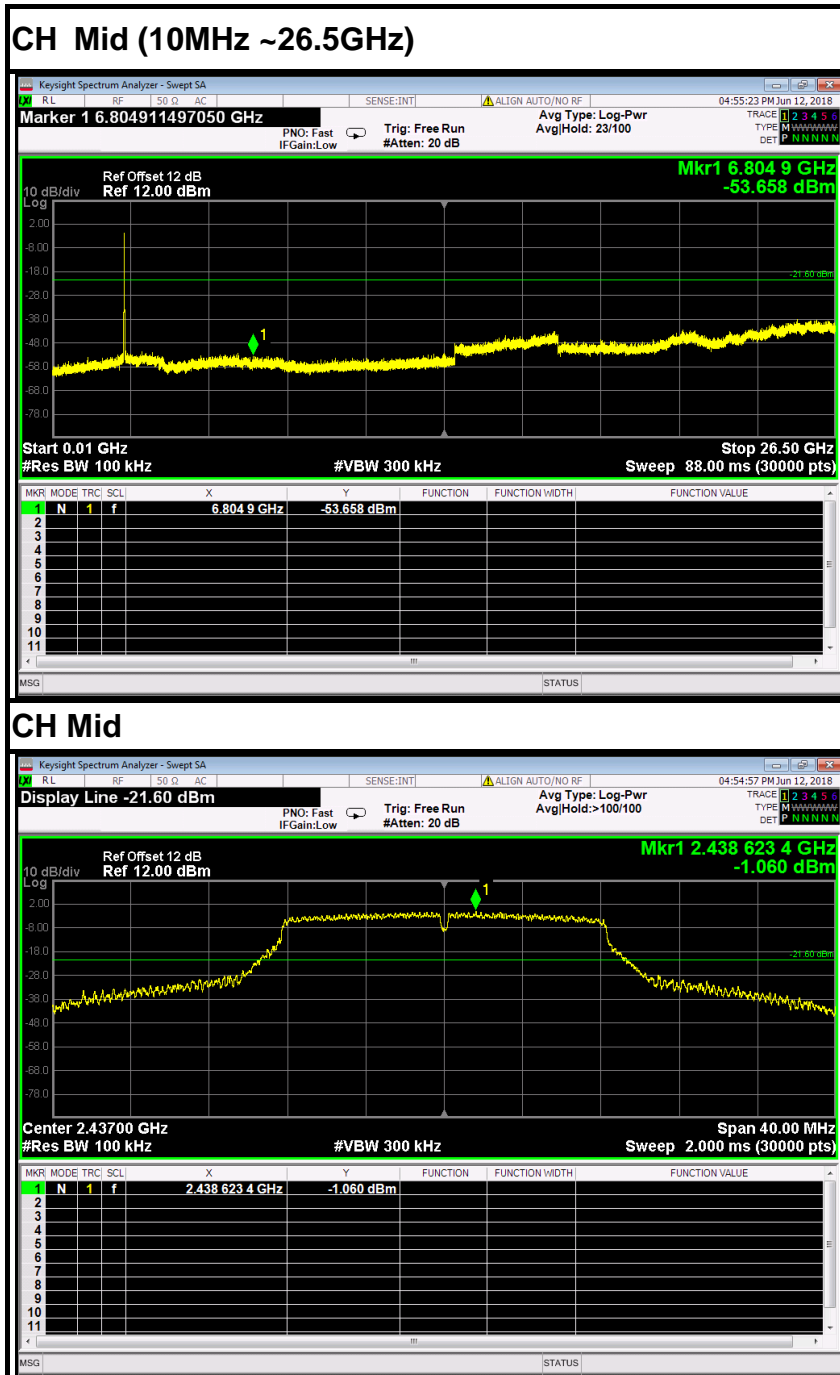

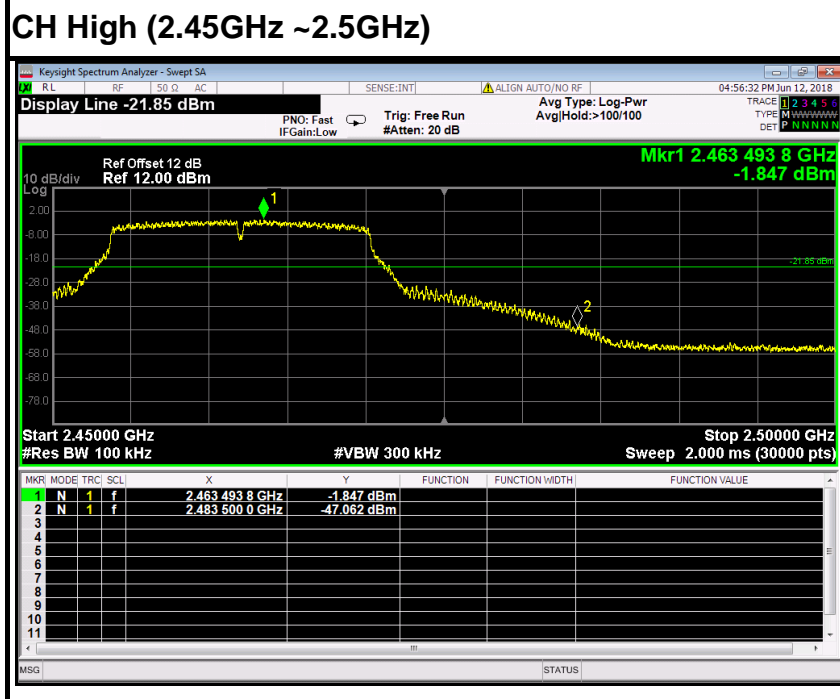
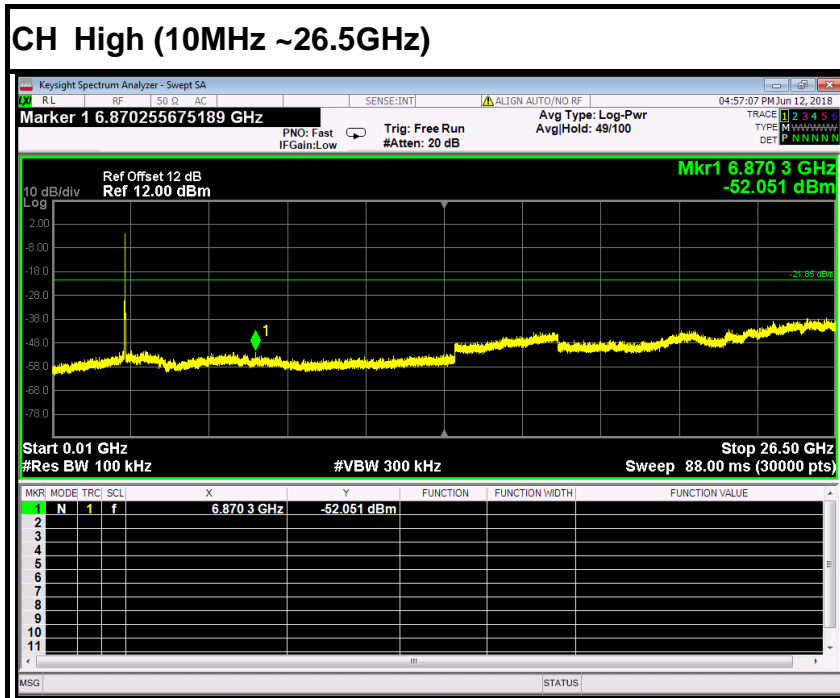



IEEE 802.11n HT20 MHz mode

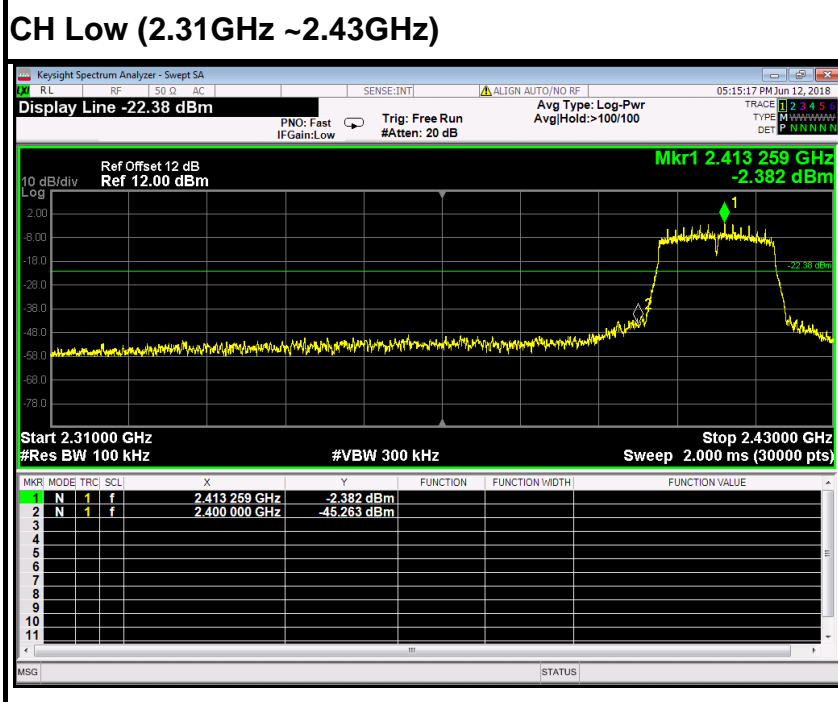
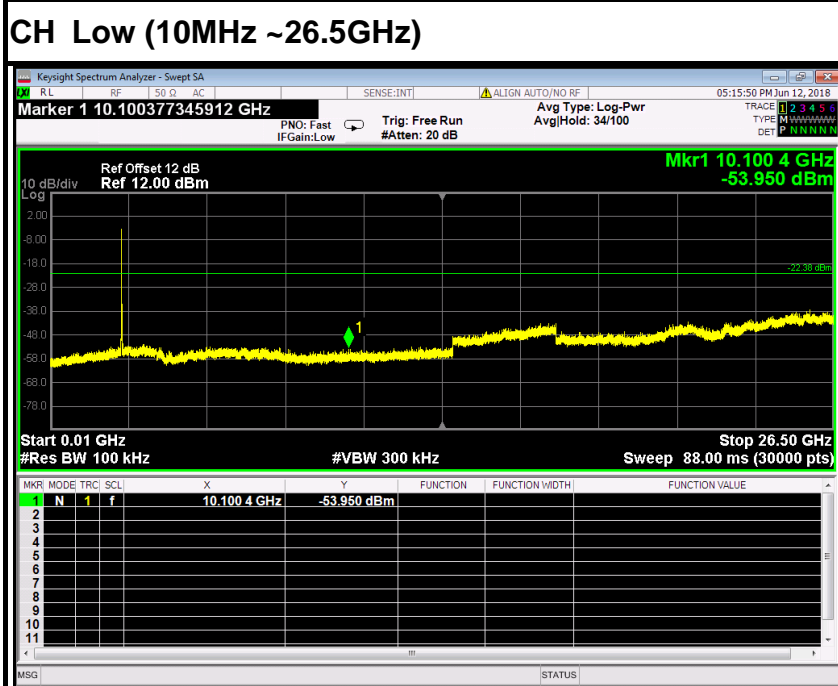

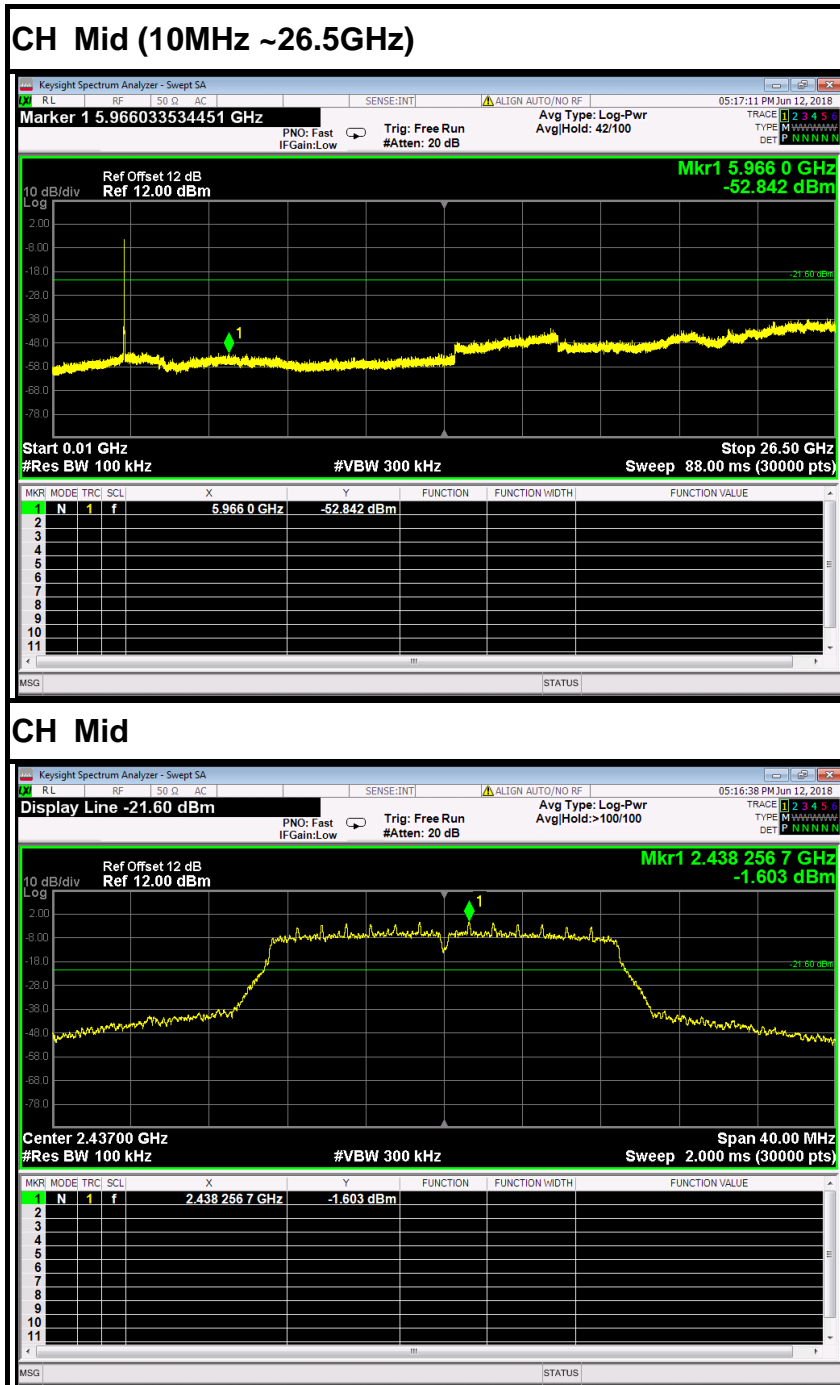

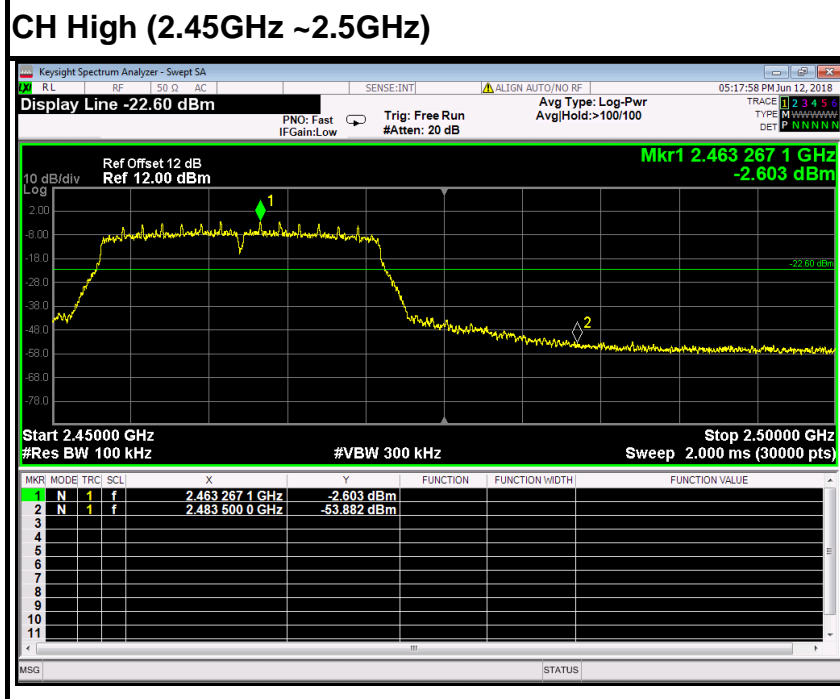
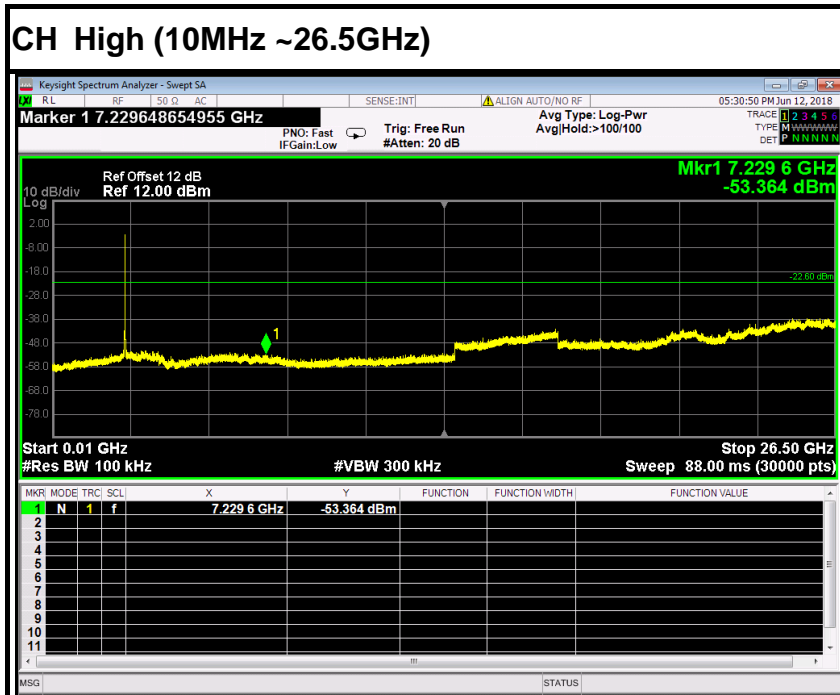



IEEE 802.11n HT40 MHz mode

CH Low (10MHz ~26.5GHz)

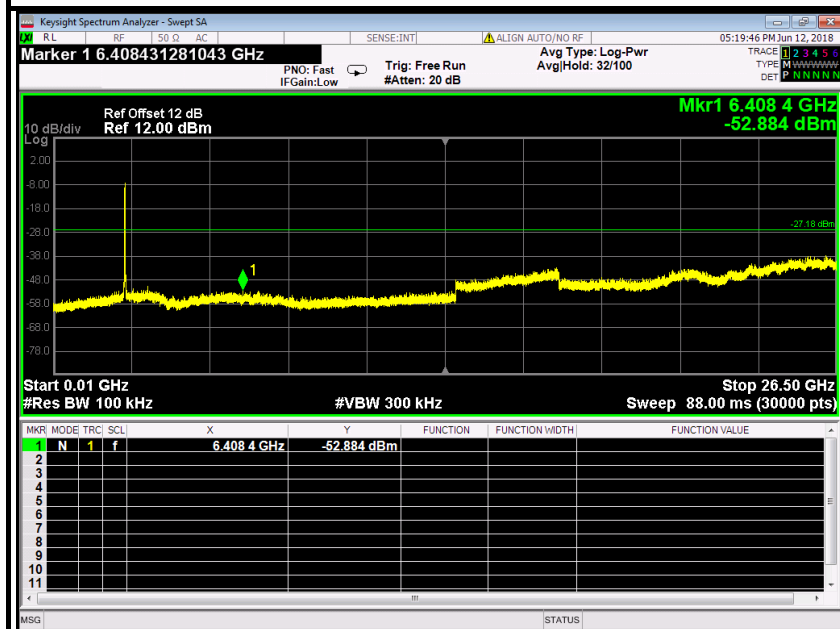

CH Low (2.31GHz ~2.45GHz)

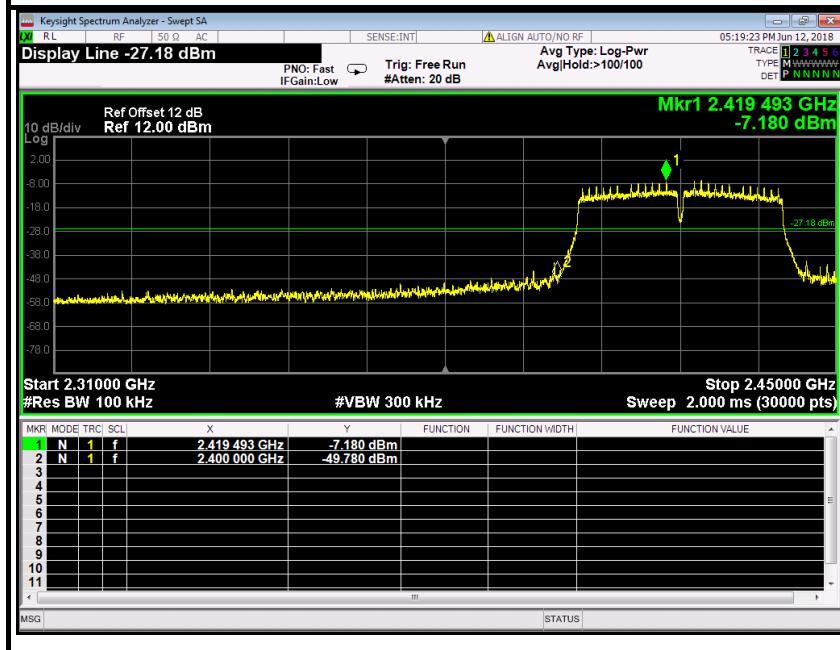

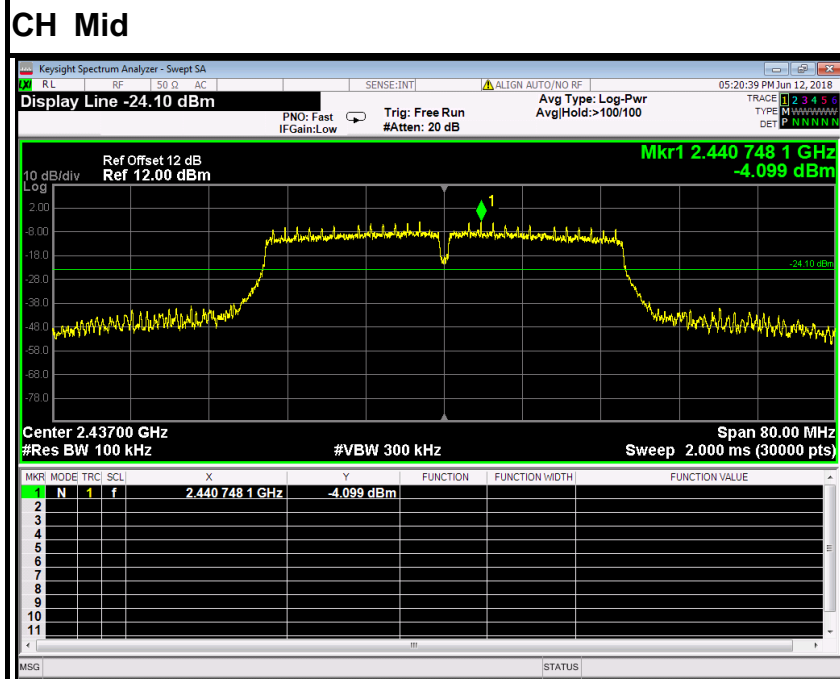
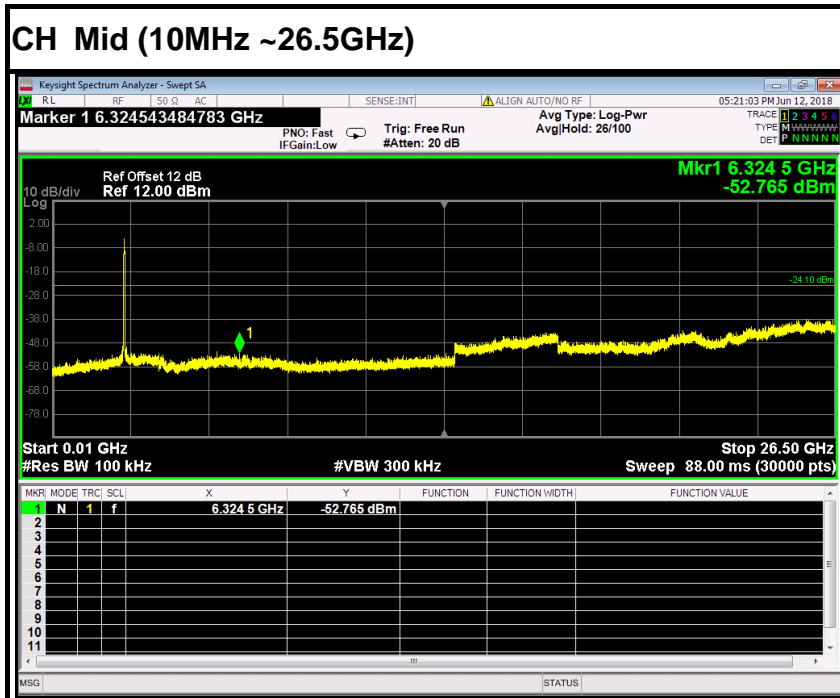

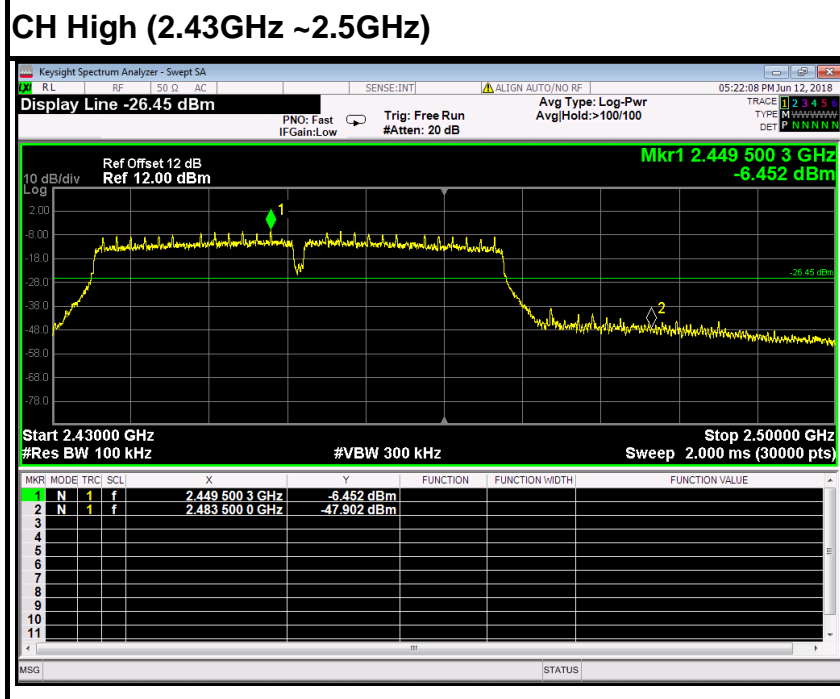
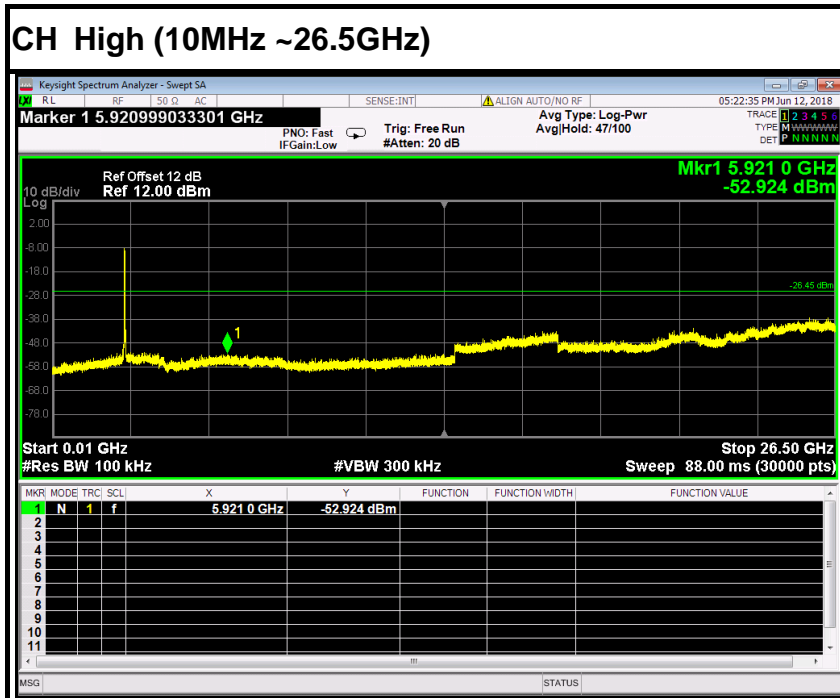



7.2.2. RADIATED EMISSIONS MEASUREMENT

7.2.2.1. LIMITS OF RADIATED EMISSIONS MEASUREMENT

According to §15.209(a), except as provided elsewhere in this Subpart, the emissions from an intentional radiator shall not exceed the field strength levels specified in the following table:

Frequency (MHz)	Field Strength (mV/m)	Measurement Distance (m)
0.009-0.490	2400/F(kHz)	300
0.490-1.705	24000/F(kHz)	30
1.705-30.0	30	30
30-88	100*	3
88-216	150*	3
216-960	200*	3
Above 960	500	3

Remark: Except as provided in paragraph (g), fundamental emissions from intentional radiators operating under this Section shall not be located in the frequency bands 54-72 MHz, 76-88 MHz, 174-216 MHz or 470-806 MHz. However, operation within these frequency bands is permitted under other sections of this Part, e.g., Sections 15.231 and 15.241.

1. In the emission table above, the tighter limit applies at the band edges.

Frequency (MHz)	Field Strength (µV/m at 3-meter)	Field Strength (dBµV/m at 3-meter)
30-88	100	40
88-216	150	43.5
216-960	200	46
Above 960	500	54

NOTE:(1) The lower limit shall apply at the transition frequencies.
 (2) Emission level (dBuV/m) = 20 log Emission level (uV/m).

**7.2.2.2. TEST INSTRUMENTS**

Radiated Emission Test Site 966 (2)					
Name of Equipment	Manufacturer	Model Number	Serial Number	Last Calibration	Due Calibration
PSA Series Spectrum Analyzer	Agilent	N9010A	MY52221469	01/27/2018	01/26/2019
EMI TEST RECEIVER	ROHDE&SCHWARZ	ESCI	100783	02/21/2018	02/20/2019
Amplifier	EMEC	EM330	060661	03/18/2018	03/17/2019
High Noise Amplifier	Agilent	8449B	3008A01838	02/21/2018	02/20/2019
Loop Antenna	COM-POWER	AL-130	121044	09/25/2017	09/24/2018
Bilog Antenna	SCHAFFNER	CBL6143	5082	02/21/2018	02/20/2019
Horn Antenna	SCHWARZBECK	BBHA9120	D286	02/27/2018	02/27/2019
Board-Band Horn Antenna	Schwarzbeck	BBHA 9170	9170-497	02/27/2018	02/27/2019
Turn Table	N/A	N/A	N/A	N.C.R	N.C.R
Antenna Tower	SUNOL	TLT2	N/A	N.C.R	N.C.R
Controller	Sunol Sciences	SC104V	022310-1	N.C.R	N.C.R
Controller	CT	N/A	N/A	N.C.R	N.C.R
Temp. / Humidity Meter	Anymetre	JR913	N/A	01/29/2018	01/28/2019
Test S/W	FARAD	LZ-RF / CCS-SZ-3A2			

NOTE: 1. The calibration interval of the above test instruments is 12 months and the calibrations are traceable to NML/ROC and NIST/USA.

2. The FCC Site Registration number is 101879.

3. N.C.R = No Calibration Required.



7.2.2.3. Measuring Instruments and Setting

The following table is the setting of spectrum analyzer and receiver.

Spectrum Parameter	Setting
Attenuation	Auto
Start Frequency	1000 MHz
Stop Frequency	10th carrier harmonic
RB / VB (Emission in restricted band)	1MHz / 1MHz for Peak, 1 MHz / 1/T for Average
RB / VB (Emission in non-restricted band)	1MHz / 1MHz for Peak, 1 MHz / 1/T for Average

Receiver Parameter	Setting
Attenuation	Auto
Start ~ Stop Frequency	9kHz~150kHz / RB 200Hz for QP/AVG
Start ~ Stop Frequency	150kHz~30MHz / RB 9kHz for QP/AVG
Start ~ Stop Frequency	30MHz~1000MHz / RB 100kHz for QP

7.2.2.4. TEST PROCEDURE (please refer to measurement standard)

1) Sequence of testing 9 kHz to 30 MHz

Setup:

- The equipment was set up to simulate a typical usage like described in the user manual or described by manufacturer.
- If the EUT is a tabletop system, a rotatable table with 0.8 m height is used.
- If the EUT is a floor standing device, it is placed on the ground.
- Auxiliary equipment and cables were positioned to simulate normal operation conditions.
- The AC power port of the EUT (if available) is connected to a power outlet below the turntable.
- The measurement distance is 3 meter.
- The EUT was set into operation.

Pre measurement:

- The turntable rotates from 0° to 315° using 45° steps.
- The antenna height is 0.8 meter.
- At each turntable position the analyzer sweeps with peak detection to find the maximum of all emissions



Final measurement:

--- Identified emissions during the pre measurement the software maximizes by rotating the turntable position (0° to 360°) and by rotating the elevation axes (0° to 360°).

--- The final measurement will be done in the position (turntable and elevation) causing the highest emissions with QPK detector.

--- The final levels, frequency, measuring time, bandwidth, turntable position, correction factor, margin to the limit and limit will be recorded. Also a plot with the graph of the pre measurement and the limit will be stored.

2) Sequence of testing 30 MHz to 1 GHz

Setup:

--- The equipment was set up to simulate a typical usage like described in the user manual or described by manufacturer.

--- If the EUT is a tabletop system, a table with 0.8 m height is used, which is placed on the ground plane.

--- If the EUT is a floor standing device, it is placed on the ground plane with insulation between both.

--- Auxiliary equipment and cables were positioned to simulate normal operation conditions

--- The AC power port of the EUT (if available) is connected to a power outlet below the turntable.

--- The measurement distance is 3 meter.

--- The EUT was set into operation.

Pre measurement:

--- The turntable rotates from 0° to 315° using 45° steps.

--- The antenna is polarized vertical and horizontal.

--- The antenna height changes from 1 to 3 meter.

--- At each turntable position, antenna polarization and height the analyzer sweeps three times in peak to find the maximum of all emissions.



Final measurement:

- The final measurement will be performed with minimum the six highest peaks.
- According to the maximum antenna and turntable positions of premeasurement the software maximize the peaks by changing turntable position ($\pm 45^\circ$) and antenna movement between 1 and 4 meter.
- The final measurement will be done with QP detector with an EMI receiver.
- The final levels, frequency, measuring time, bandwidth, antenna height, antenna polarization, turntable angle, correction factor, margin to the limit and limit will be recorded. Also a plot with the graph of the premeasurement with marked maximum final measurements and the limit will be stored.

3) Sequence of testing 1 GHz to 18 GHz

Setup:

- The equipment was set up to simulate a typical usage like described in the user manual or described by manufacturer.
- If the EUT is a tabletop system, a rotatable table with 1.5 m height is used.
- If the EUT is a floor standing device, it is placed on the ground plane with insulation between both.
- Auxiliary equipment and cables were positioned to simulate normal operation conditions
- The AC power port of the EUT (if available) is connected to a power outlet below the turntable.
- The measurement distance is 3 meter.
- The EUT was set into operation.

Pre measurement:

- The turntable rotates from 0° to 315° using 45° steps.
- The antenna is polarized vertical and horizontal.
- The antenna height scan range is 1 meter to 2.5 meter.
- At each turntable position and antenna polarization the analyzer sweeps with peak detection to find the maximum of all emissions.



Final measurement:

--- The final measurement will be performed with minimum the six highest peaks.

--- According to the maximum antenna and turntable positions of premeasurement the software maximize the peaks by changing turntable position ($\pm 45^\circ$) and antenna movement between 1 and 4 meter. This procedure is repeated for both antenna polarizations.

--- The final measurement will be done in the position (turntable, EUT-table and antenna polarization) causing the highest emissions with Peak and Average detector.

--- The final levels, frequency, measuring time, bandwidth, turntable position, EUT-table position, antenna polarization, correction factor, margin to the limit and limit will be recorded. Also a plot with the graph of the pre measurement with marked maximum final measurements and the limit will be stored.

4) Sequence of testing above 18 GHz

Setup:

--- The equipment was set up to simulate a typical usage like described in the user manual or described by manufacturer.

--- If the EUT is a tabletop system, a rotatable table with 1.5 m height is used.

--- If the EUT is a floor standing device, it is placed on the ground plane with insulation between both.

--- Auxiliary equipment and cables were positioned to simulate normal operation conditions

--- The AC power port of the EUT (if available) is connected to a power outlet below the turntable.

--- The measurement distance is 1 meter.

--- The EUT was set into operation.

Pre measurement:

--- The antenna is moved spherical over the EUT in different polarisations of the antenna.

Final measurement:

--- The final measurement will be performed at the position and antenna orientation for all detected emissions that were found during the premeasurements with Peak and Average detector.

--- The final levels, frequency, measuring time, bandwidth, correction factor, margin to the limit and limit will be recorded. Also a plot with the graph of the premeasurement and the limit will be stored.



7.2.2.5. TEST SETUP

Below 30MHz

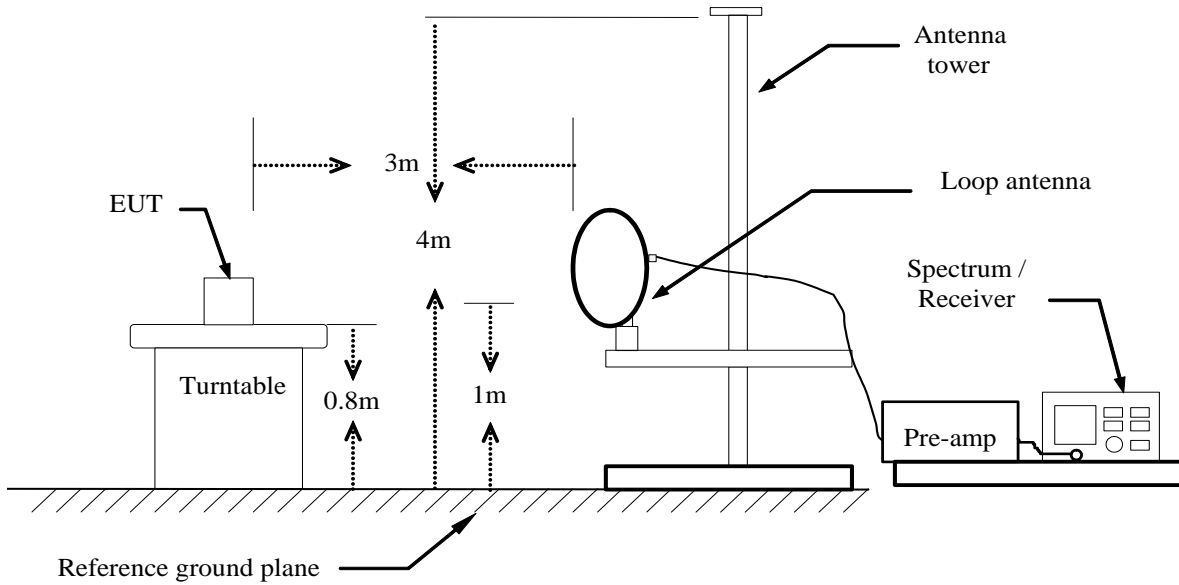

Below 1 GHz

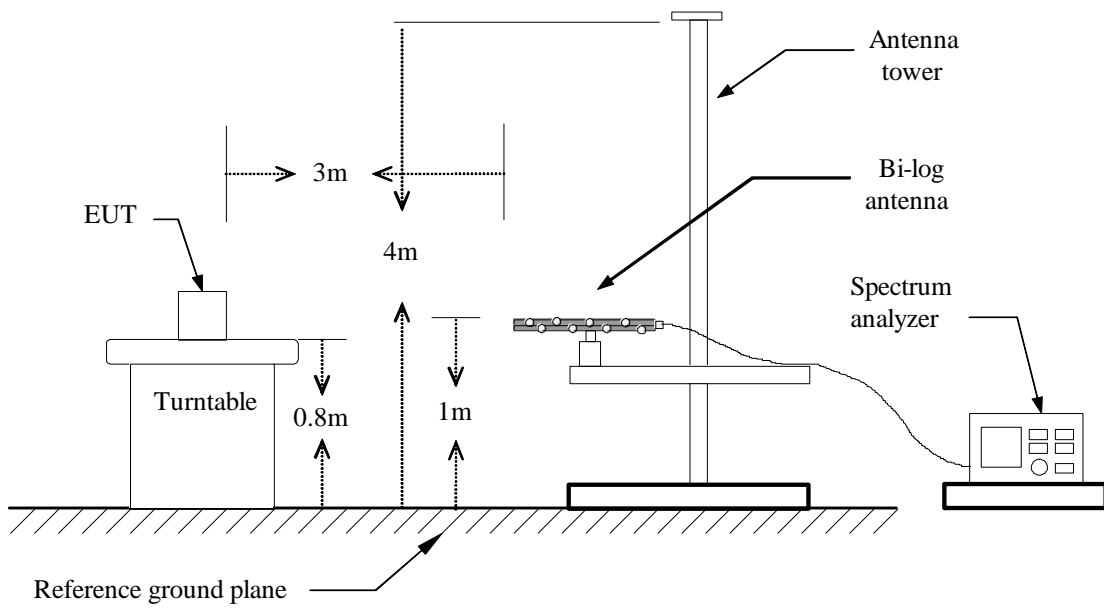



Above 1 GHz

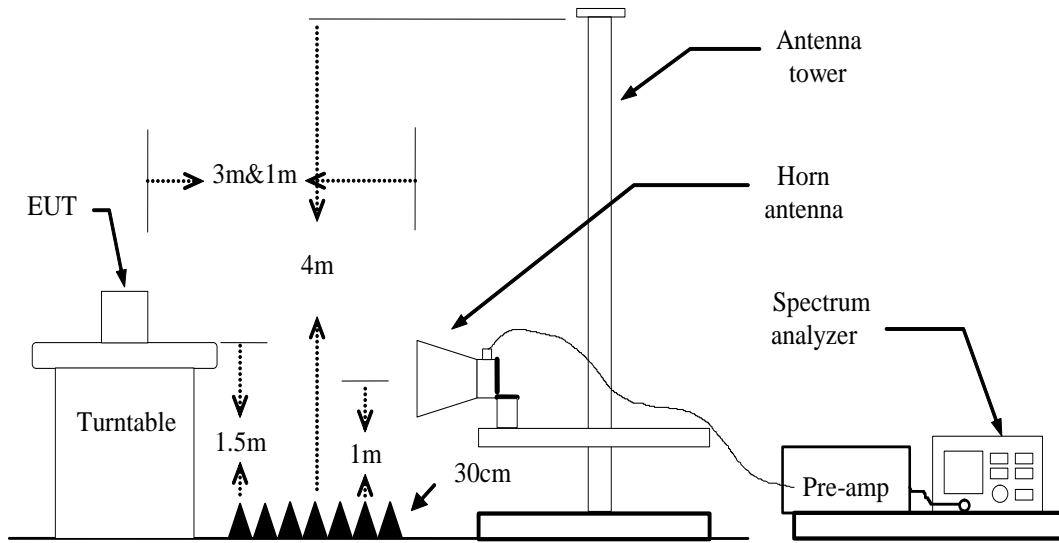

For the actual test configuration, please refer to the related item – Photographs of the Test Configuration.



7.2.2.6. DATA SAPLE

Below 1GHz

Frequency (MHz)	Reading (dBuV)	Correct Factor (dB/m)	Result (dBuV/m)	Limit (dBuV/m)	Margin (dB)	Antenna Pole (V/H)	Remark
XXX.XXXX	36.37	-12.20	24.17	40.00	-15.83	V	QP

Frequency (MHz) = Emission frequency in MHz
 Reading (dBuV) = Uncorrected Analyzer / Receiver reading
 Correct Factor (dB/m) = Antenna factor + Cable loss – Amplifier gain
 Result (dBuV/m) = Reading (dBuV) + Corr. Factor (dB/m)
 Limit (dBuV/m) = Limit stated in standard
 Margin (dB) = Result (dBuV/m) – Limit (dBuV/m)
 Q.P. = Quasi-peak Reading

Above 1GHz

Frequency (MHz)	Reading (dBuV)	Correction Factor (dB/m)	Result (dBuV/m)	Limit (dBuV/m)	Margin (dB)	Antenna Pole (V/H)	Remark
XXXX.XXXX	62.09	-11.42	50.67	74.00	-23.33	V	Peak
XXXX.XXXX	49.78	-11.42	38.36	54.00	-15.64	V	AVG

Frequency (MHz) = Emission frequency in MHz
 Reading (dBuV) = Uncorrected Analyzer / Receiver reading
 Correction Factor (dB/m) = Antenna factor + Cable loss – Amplifier gain
 Result (dBuV/m) = Reading (dBuV) + Corr. Factor (dB/m)
 Limit (dBuV/m) = Limit stated in standard
 Margin (dB) = Result (dBuV/m) – Limit (dBuV/m)
 Peak = Peak Reading
 AVG = Average Reading

Calculation Formula

Margin (dB) = Result (dBuV/m) – Limits (dBuV/m)
 Result (dBuV/m) = Reading (dBuV) + Correction Factor

**7.2.2.7. TEST RESULTS****Below 1 GHz****Test Mode:** TX / IEEE 802.11b(CH Low)**Tested by:** Saber Huang**Ambient temperature:** 24°C **Relative humidity:** 52% RH**Date:** May 25, 2018

Frequency (MHz)	Reading (dBuV)	Correction Factor (dB/m)	Result (dBuV/m)	Limit (dBuV/m)	Margin (dB)	Antenna Pole (V/H)	Remark
182.2900	48.91	-22.93	25.98	43.50	-17.52	V	QP
416.0600	33.19	-15.49	17.70	46.00	-28.30	V	QP
558.6500	28.56	-13.24	15.32	46.00	-30.68	V	QP
705.1200	29.70	-11.92	17.78	46.00	-28.22	V	QP
879.7200	31.17	-9.98	21.19	46.00	-24.81	V	QP
917.5500	27.98	-9.41	18.57	46.00	-27.43	V	QP
130.8800	44.13	-20.79	23.34	43.50	-20.16	H	QP
181.3200	52.31	-22.94	29.37	43.50	-14.13	H	QP
453.8900	30.87	-15.35	15.52	46.00	-30.48	H	QP
676.9900	30.12	-12.34	17.78	46.00	-28.22	H	QP
713.8500	29.97	-11.88	18.09	46.00	-27.91	H	QP
854.5000	29.63	-10.66	18.97	46.00	-27.03	H	QP

Notes:

1. No emission found between lowest internal used/generated frequency to 30MHz.
2. Pre-scan all mode and recorded the worst case results in this report (802.11b (Low Channel))

Remark:

1. Radiated emissions measured in frequency range from 9 kHz to 1GHz were made with an instrument using Quasi-peak detector mode.
2. Data of measurement within this frequency range shown "---" in the table above means the reading of emissions are attenuated more than 20dB below the permissible limits or the field strength is too small to be measured.
3. The IF bandwidth of Receiver between 30MHz to 1GHz was 120 kHz.
4. Frequency (MHz). = Emission frequency in MHz
Reading (dBμV/m) = Receiver reading
Correction Factor (dB) = Antenna factor + Cable loss – Amplifier gain
Limit (dBμV/m) = Limit stated in standard
Margin (dB) = Measured (dBμV/m) – Limits (dBμV/m)
Antenna Pole (H/V) = Current carrying line of reading



Vertical

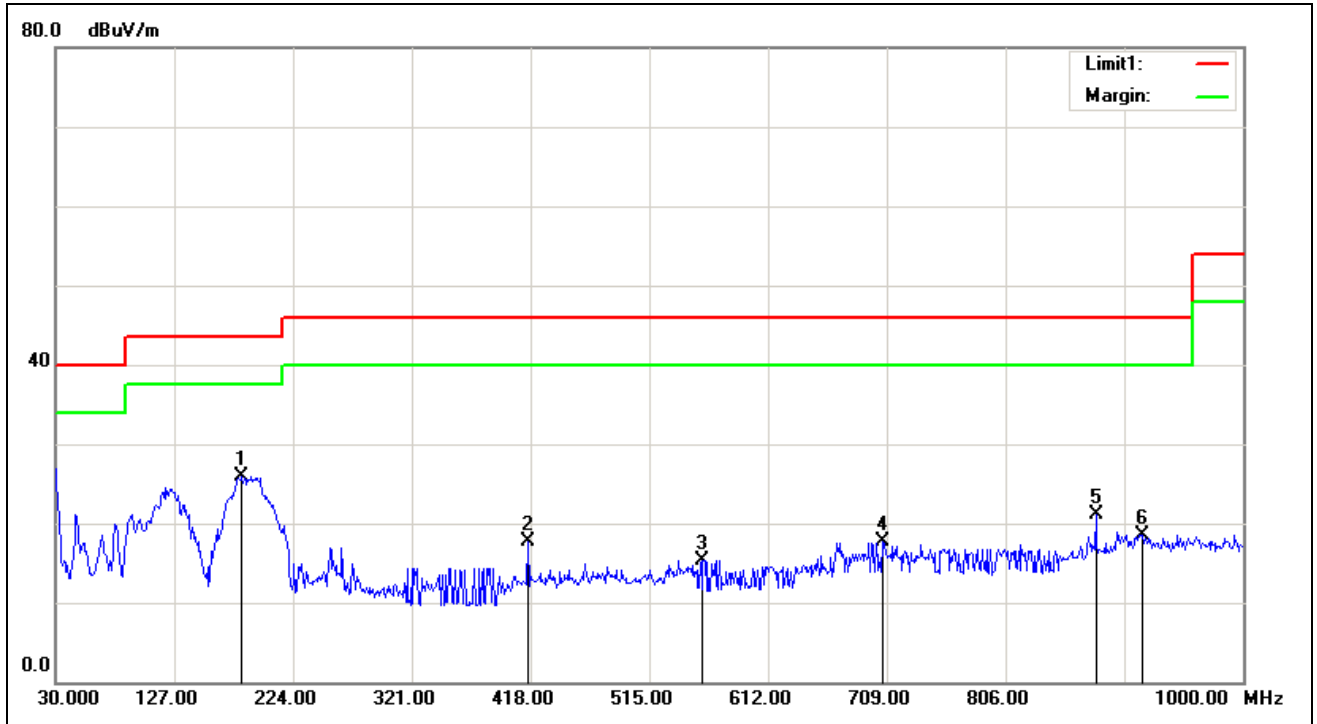

Horizontal

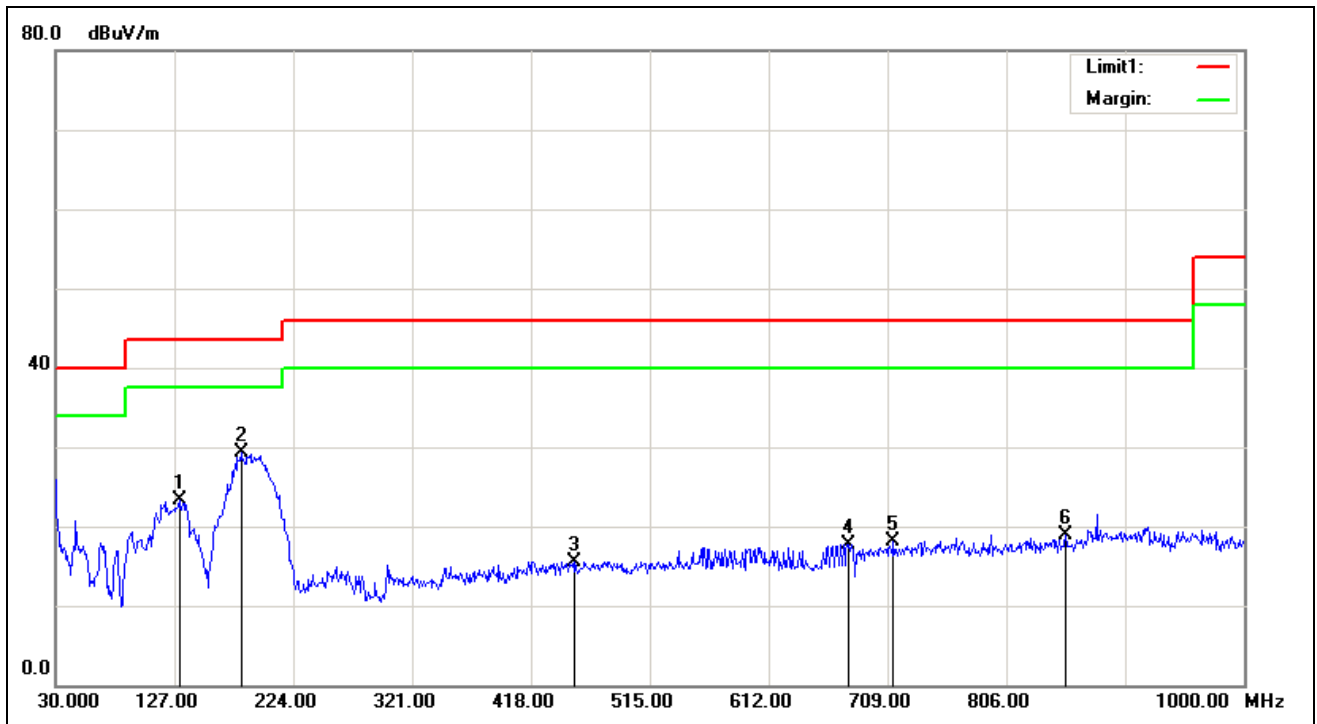



Above 1 GHz

Test Mode: TX / IEEE 802.11b(CH Low)

Tested by: Saber Huang

Ambient temperature: 24°C **Relative humidity:** 52% RH

Date: May 25, 2018

Frequency (MHz)	Reading (dBuV)	Correction Factor (dB/m)	Result (dBuV/m)	Limit (dBuV/m)	Margin (dB)	Antenna Pole (V/H)	Remark
1468.000	45.98	-6.94	39.04	74.00	-34.96	V	peak
2233.000	44.35	-3.72	40.63	74.00	-33.37	V	peak
2899.000	44.33	-1.54	42.79	74.00	-31.21	V	peak
3619.000	44.25	-0.02	44.23	74.00	-29.77	V	peak
4438.000	41.93	3.13	45.06	74.00	-28.94	V	peak
4762.000	41.20	4.20	45.40	74.00	-28.60	V	peak
2251.000	45.37	-3.62	41.75	74.00	-32.25	H	Peak
2692.000	45.17	-1.91	43.26	74.00	-30.74	H	Peak
3169.000	46.48	-1.08	45.40	74.00	-28.60	H	Peak
3961.000	42.80	1.43	44.23	74.00	-29.77	H	Peak
4321.000	42.73	2.72	45.45	74.00	-28.55	H	peak
5005.000	42.20	4.99	47.19	74.00	-26.81	H	peak

Remark:

1. Measuring frequencies from 1 GHz to the 10th harmonic of highest fundamental frequency.
2. Radiated emissions measured in frequency above 1000MHz were made with an instrument using peak/average detector mode.
3. Average test would be performed if the peak result were greater than the average limit or as required by the applicant.
4. Data of measurement within this frequency range shown " --- " in the table above means the reading of emissions are attenuated more than 20dB below the permissible limits or the field strength is too small to be measured.
5. Measurements above show only up to 6 maximum emissions noted, or would be lesser, with " N/A " remark, if no specific emissions from the EUT are recorded (ie: margin>20dB from the applicable limit) and considered that's already beyond the background noise floor.
6. Margin (dB) = Remark result (dBuV/m) – Average limit (dBuV/m).



Test Mode: TX / IEEE 802.11b (CH Mid)

Tested by: Saber Huang

Ambient temperature: 24°C Relative humidity: 52% RH

Date: May 25, 2018

Frequency (MHz)	Reading (dBuV)	Correction Factor (dB/m)	Result (dBuV/m)	Limit (dBuV/m)	Margin (dB)	Antenna Pole (V/H)	Remark
2791.000	43.20	-1.74	41.46	74.00	-32.54	V	Peak
3313.000	41.92	-0.83	41.09	74.00	-32.91	V	Peak
3385.000	44.39	-0.71	43.68	74.00	-30.32	V	Peak
3826.000	41.39	0.86	42.25	74.00	-31.75	V	Peak
4132.000	41.45	2.05	43.50	74.00	-30.50	V	Peak
4402.000	41.77	3.01	44.78	74.00	-29.22	V	Peak
2026.000	45.86	-4.86	41.00	74.00	-33.00	H	Peak
2674.000	46.04	-1.95	44.09	74.00	-29.91	H	Peak
3961.000	42.64	1.43	44.07	74.00	-29.93	H	Peak
4240.000	42.59	2.43	45.02	74.00	-28.98	H	Peak
5041.000	41.53	5.05	46.58	74.00	-27.42	H	Peak
5554.000	42.55	5.89	48.44	74.00	-25.56	H	Peak

Remark:

1. Measuring frequencies from 1 GHz to the 10th harmonic of highest fundamental frequency.
2. Radiated emissions measured in frequency above 1000MHz were made with an instrument using peak/average detector mode.
3. Average test would be performed if the peak result were greater than the average limit or as required by the applicant.
4. Data of measurement within this frequency range shown " --- " in the table above means the reading of emissions are attenuated more than 20dB below the permissible limits or the field strength is too small to be measured.
5. Measurements above show only up to 6 maximum emissions noted, or would be lesser, with " N/A " remark, if no specific emissions from the EUT are recorded (ie: margin>20dB from the applicable limit) and considered that's already beyond the background noise floor.
6. Margin (dB) = Remark result (dBuV/m) – Average limit (dBuV/m).



Test Mode: TX / IEEE 802.11b (CH High)

Tested by: Saber Huang

Ambient temperature: 24°C

Relative humidity: 52% RH

Date: May 25, 2018

Frequency (MHz)	Reading (dBuV)	Correction Factor (dB/m)	Result (dBuV/m)	Limit (dBuV/m)	Margin (dB)	Antenna Pole (V/H)	Remark
1333.000	47.14	-7.30	39.84	74.00	-34.16	V	Peak
1468.000	46.74	-6.94	39.80	74.00	-34.20	V	Peak
2215.000	46.55	-3.82	42.73	74.00	-31.27	V	Peak
2926.000	44.58	-1.49	43.09	74.00	-30.91	V	Peak
3601.000	42.71	-0.09	42.62	74.00	-31.38	V	Peak
4510.000	41.30	3.38	44.68	74.00	-29.32	V	Peak
1315.000	48.23	-7.37	40.86	74.00	-33.14	H	Peak
2170.000	46.23	-4.07	42.16	74.00	-31.84	H	Peak
2665.000	45.22	-1.96	43.26	74.00	-30.74	H	Peak
3601.000	43.97	-0.09	43.88	74.00	-30.12	H	Peak
4654.000	40.51	3.85	44.36	74.00	-29.64	H	Peak
5176.000	40.71	5.29	46.00	74.00	-28.00	H	Peak

Remark:

1. Measuring frequencies from 1 GHz to the 10th harmonic of highest fundamental frequency.
2. Radiated emissions measured in frequency above 1000MHz were made with an instrument using peak/average detector mode.
3. Average test would be performed if the peak result were greater than the average limit or as required by the applicant.
4. Data of measurement within this frequency range shown " --- " in the table above means the reading of emissions are attenuated more than 20dB below the permissible limits or the field strength is too small to be measured.
5. Measurements above show only up to 6 maximum emissions noted, or would be lesser, with " N/A " remark, if no specific emissions from the EUT are recorded (ie: margin>20dB from the applicable limit) and considered that's already beyond the background noise floor.
6. Margin (dB) = Remark result (dBuV/m) – Average limit (dBuV/m).



Test Mode: TX / IEEE 802.11g(CH Low)

Tested by: Saber Huang

Ambient temperature: 24°C Relative humidity: 52% RH

Date: May 25, 2018

Frequency (MHz)	Reading (dBuV)	Correction Factor (dB/m)	Result (dBuV/m)	Limit (dBuV/m)	Margin (dB)	Antenna Pole (V/H)	Remark
1315.000	47.81	-7.37	40.44	74.00	-33.56	V	Peak
2242.000	45.33	-3.67	41.66	74.00	-32.34	V	Peak
2674.000	45.94	-1.95	43.99	74.00	-30.01	V	Peak
3772.000	41.64	0.63	42.27	74.00	-31.73	V	Peak
4258.000	42.12	2.50	44.62	74.00	-29.38	V	Peak
5419.000	39.44	5.73	45.17	74.00	-28.83	V	Peak
1351.000	47.56	-7.24	40.32	74.00	-33.68	H	Peak
2080.000	47.10	-4.56	42.54	74.00	-31.46	H	Peak
2647.000	45.83	-2.00	43.83	74.00	-30.17	H	Peak
3961.000	42.65	1.43	44.08	74.00	-29.92	H	Peak
4303.000	42.79	2.66	45.45	74.00	-28.55	H	Peak
5005.000	42.07	4.99	47.06	74.00	-26.94	H	Peak

Remark:

1. Measuring frequencies from 1 GHz to the 10th harmonic of highest fundamental frequency.
2. Radiated emissions measured in frequency above 1000MHz were made with an instrument using peak/average detector mode.
3. Average test would be performed if the peak result were greater than the average limit or as required by the applicant.
4. Data of measurement within this frequency range shown " --- " in the table above means the reading of emissions are attenuated more than 20dB below the permissible limits or the field strength is too small to be measured.
5. Measurements above show only up to 6 maximum emissions noted, or would be lesser, with " N/A " remark, if no specific emissions from the EUT are recorded (ie: margin>20dB from the applicable limit) and considered that's already beyond the background noise floor.
6. Margin (dB) = Remark result (dBuV/m) – Average limit (dBuV/m).



Test Mode: TX / IEEE 802.11g (CH Mid)

Tested by: Saber Huang

Ambient temperature: 24°C

Relative humidity: 52% RH

Date: May 25, 2018

Frequency (MHz)	Reading (dBuV)	Correction Factor (dB/m)	Result (dBuV/m)	Limit (dBuV/m)	Margin (dB)	Antenna Pole (V/H)	Remark
1468.000	48.33	-6.94	41.39	74.00	-32.61	V	Peak
2251.000	46.52	-3.62	42.90	74.00	-31.10	V	Peak
2638.000	46.09	-2.01	44.08	74.00	-29.92	V	Peak
3655.000	42.97	0.13	43.10	74.00	-30.90	V	Peak
4195.000	42.72	2.28	45.00	74.00	-29.00	V	Peak
5113.000	42.07	5.18	47.25	74.00	-26.75	V	Peak
1315.000	47.09	-7.37	39.72	74.00	-34.28	H	Peak
2197.000	46.95	-3.92	43.03	74.00	-30.97	H	Peak
2665.000	45.28	-1.96	43.32	74.00	-30.68	H	Peak
3178.000	43.33	-1.06	42.27	74.00	-31.73	H	Peak
4105.000	42.13	1.96	44.09	74.00	-29.91	H	Peak
4357.000	41.81	2.85	44.66	74.00	-29.34	H	Peak

Remark:

1. Measuring frequencies from 1 GHz to the 10th harmonic of highest fundamental frequency.
2. Radiated emissions measured in frequency above 1000MHz were made with an instrument using peak/average detector mode.
3. Average test would be performed if the peak result were greater than the average limit or as required by the applicant.
4. Data of measurement within this frequency range shown " --- " in the table above means the reading of emissions are attenuated more than 20dB below the permissible limits or the field strength is too small to be measured.
5. Measurements above show only up to 6 maximum emissions noted, or would be lesser, with " N/A " remark, if no specific emissions from the EUT are recorded (ie: margin>20dB from the applicable limit) and considered that's already beyond the background noise floor.
6. Margin (dB) = Remark result (dBuV/m) – Average limit (dBuV/m).



Test Mode: TX / IEEE 802.11g (CH High)

Tested by: Saber Huang

Ambient temperature: 24°C Relative humidity: 52% RH

Date: May 25, 2018

Frequency (MHz)	Reading (dBuV)	Correction Factor (dB/m)	Result (dBuV/m)	Limit (dBuV/m)	Margin (dB)	Antenna Pole (V/H)	Remark
1360.000	48.52	-7.21	41.31	74.00	-32.69	V	Peak
2224.000	45.74	-3.77	41.97	74.00	-32.03	V	Peak
2665.000	46.06	-1.96	44.10	74.00	-29.90	V	Peak
3385.000	43.19	-0.71	42.48	74.00	-31.52	V	Peak
4330.000	42.86	2.75	45.61	74.00	-28.39	V	Peak
5023.000	42.34	5.02	47.36	74.00	-26.64	V	Peak
1360.000	48.52	-7.21	41.31	74.00	-32.69	H	Peak
1720.000	48.61	-6.44	42.17	74.00	-31.83	H	Peak
2665.000	46.06	-1.96	44.10	74.00	-29.90	H	Peak
3160.000	45.44	-1.09	44.35	74.00	-29.65	H	Peak
4231.000	42.94	2.40	45.34	74.00	-28.66	H	Peak
4582.000	42.46	3.62	46.08	74.00	-27.92	H	Peak

Remark:

1. Measuring frequencies from 1 GHz to the 10th harmonic of highest fundamental frequency.
2. Radiated emissions measured in frequency above 1000MHz were made with an instrument using peak/average detector mode.
3. Average test would be performed if the peak result were greater than the average limit or as required by the applicant.
4. Data of measurement within this frequency range shown " --- " in the table above means the reading of emissions are attenuated more than 20dB below the permissible limits or the field strength is too small to be measured.
5. Measurements above show only up to 6 maximum emissions noted, or would be lesser, with " N/A " remark, if no specific emissions from the EUT are recorded (ie: margin>20dB from the applicable limit) and considered that's already beyond the background noise floor.
6. Margin (dB) = Remark result (dBuV/m) – Average limit (dBuV/m).



Test Mode: TX / IEEE 802.11n HT20 MHz (CH Low)

Tested by: Saber Huang

Ambient temperature: 24°C Relative humidity: 52% RH

Date: May 25, 2018

Frequency (MHz)	Reading (dBuV)	Correction Factor (dB/m)	Result (dBuV/m)	Limit (dBuV/m)	Margin (dB)	Antenna Pole (V/H)	Remark
2251.000	45.83	-3.62	42.21	74.00	-31.79	V	Peak
2674.000	45.04	-1.95	43.09	74.00	-30.91	V	Peak
3367.000	43.04	-0.74	42.30	74.00	-31.70	V	Peak
3655.000	43.96	0.13	44.09	74.00	-29.91	V	Peak
3898.000	41.50	1.16	42.66	74.00	-31.34	V	Peak
5014.000	42.41	5.00	47.41	74.00	-26.59	V	Peak
1351.000	48.06	-7.24	40.82	74.00	-33.18	H	Peak
2206.000	46.17	-3.87	42.30	74.00	-31.70	H	Peak
2674.000	44.90	-1.95	42.95	74.00	-31.05	H	Peak
3961.000	43.56	1.43	44.99	74.00	-29.01	H	Peak
4636.000	42.25	3.79	46.04	74.00	-27.96	H	Peak
5104.000	42.12	5.17	47.29	74.00	-26.71	H	Peak

Remark:

1. Measuring frequencies from 1 GHz to the 10th harmonic of highest fundamental frequency.
2. Radiated emissions measured in frequency above 1000MHz were made with an instrument using peak/average detector mode.
3. Average test would be performed if the peak result were greater than the average limit or as required by the applicant.
4. Data of measurement within this frequency range shown " --- " in the table above means the reading of emissions are attenuated more than 20dB below the permissible limits or the field strength is too small to be measured.
5. Measurements above show only up to 6 maximum emissions noted, or would be lesser, with " N/A " remark, if no specific emissions from the EUT are recorded (ie: margin>20dB from the applicable limit) and considered that's already beyond the background noise floor.
6. Margin (dB) = Remark result (dBuV/m) – Average limit (dBuV/m).



Test Mode: TX / IEEE 802.11n HT20 MHz (CH Mid)

Tested by: Saber Huang

Ambient temperature: 24°C Relative humidity: 52% RH

Date: May 25, 2018

Frequency (MHz)	Reading (dBuV)	Correction Factor (dB/m)	Result (dBuV/m)	Limit (dBuV/m)	Margin (dB)	Antenna Pole (V/H)	Remark
2647.000	45.35	-2.00	43.35	74.00	-30.65	V	Peak
3700.000	44.04	0.32	44.36	74.00	-29.64	V	Peak
4429.000	41.79	3.10	44.89	74.00	-29.11	V	Peak
4987.000	42.30	4.94	47.24	74.00	-26.76	V	Peak
5059.000	42.63	5.09	47.72	74.00	-26.28	V	Peak
5725.000	41.90	5.96	47.86	74.00	-26.14	V	Peak
1342.000	47.99	-7.27	40.72	74.00	-33.28	H	Peak
2206.000	46.14	-3.87	42.27	74.00	-31.73	H	Peak
2665.000	46.33	-1.96	44.37	74.00	-29.63	H	Peak
3655.000	43.57	0.13	43.70	74.00	-30.30	H	Peak
4501.000	42.57	3.35	45.92	74.00	-28.08	H	Peak
5599.000	41.30	5.91	47.21	74.00	-26.79	H	Peak

Remark:

1. Measuring frequencies from 1 GHz to the 10th harmonic of highest fundamental frequency.
2. Radiated emissions measured in frequency above 1000MHz were made with an instrument using peak/average detector mode.
3. Average test would be performed if the peak result were greater than the average limit or as required by the applicant.
4. Data of measurement within this frequency range shown " --- " in the table above means the reading of emissions are attenuated more than 20dB below the permissible limits or the field strength is too small to be measured.
5. Measurements above show only up to 6 maximum emissions noted, or would be lesser, with " N/A " remark, if no specific emissions from the EUT are recorded (ie: margin>20dB from the applicable limit) and considered that's already beyond the background noise floor.
6. Margin (dB) = Remark result (dBuV/m) – Average limit (dBuV/m).

Test Mode: TX / EEE 802.11n HT20 MHz (CH High)Tested by: Saber HuangAmbient temperature: 24°C Relative humidity: 52% RHDate: May 25, 2018

Frequency (MHz)	Reading (dBuV)	Correction Factor (dB/m)	Result (dBuV/m)	Limit (dBuV/m)	Margin (dB)	Antenna Pole (V/H)	Remark
2656.000	44.37	-1.98	42.39	74.00	-31.61	V	Peak
3439.000	43.76	-0.62	43.14	74.00	-30.86	V	Peak
3961.000	41.83	1.43	43.26	74.00	-30.74	V	Peak
4384.000	42.62	2.94	45.56	74.00	-28.44	V	Peak
4825.000	41.47	4.41	45.88	74.00	-28.12	V	Peak
5068.000	41.75	5.10	46.85	74.00	-27.15	V	Peak
1450.000	47.48	-6.97	40.51	74.00	-33.49	H	Peak
1927.000	45.02	-5.46	39.56	74.00	-34.44	H	Peak
2188.000	45.62	-3.97	41.65	74.00	-32.35	H	Peak
3466.000	43.12	-0.58	42.54	74.00	-31.46	H	Peak
3961.000	43.71	1.43	45.14	74.00	-28.86	H	Peak
4384.000	42.59	2.94	45.53	74.00	-28.47	H	Peak

Remark:

1. Measuring frequencies from 1 GHz to the 10th harmonic of highest fundamental frequency.
2. Radiated emissions measured in frequency above 1000MHz were made with an instrument using peak/average detector mode.
3. Average test would be performed if the peak result were greater than the average limit or as required by the applicant.
4. Data of measurement within this frequency range shown " --- " in the table above means the reading of emissions are attenuated more than 20dB below the permissible limits or the field strength is too small to be measured.
5. Measurements above show only up to 6 maximum emissions noted, or would be lesser, with " N/A " remark, if no specific emissions from the EUT are recorded (ie: margin>20dB from the applicable limit) and considered that's already beyond the background noise floor.
6. Margin (dB) = Remark result (dBuV/m) – Average limit (dBuV/m).



Test Mode: TX / IEEE 802.11n HT40 MHz (CH Low)

Tested by: Saber Huang

Ambient temperature: 24°C Relative humidity: 52% RH

Date: May 25, 2018

Frequency (MHz)	Reading (dBuV)	Correction Factor (dB/m)	Result (dBuV/m)	Limit (dBuV/m)	Margin (dB)	Antenna Pole (V/H)	Remark
1396.000	47.66	-7.07	40.59	74.00	-33.41	V	Peak
2251.000	45.84	-3.62	42.22	74.00	-31.78	V	Peak
2665.000	45.18	-1.96	43.22	74.00	-30.78	V	Peak
3484.000	43.03	-0.55	42.48	74.00	-31.52	V	Peak
4033.000	41.96	1.71	43.67	74.00	-30.33	V	Peak
4960.000	41.47	4.85	46.32	74.00	-27.68	V	Peak
1477.000	46.60	-6.92	39.68	74.00	-34.32	H	Peak
2188.000	46.38	-3.97	42.41	74.00	-31.59	H	Peak
3169.000	45.76	-1.08	44.68	74.00	-29.32	H	Peak
3961.000	43.90	1.43	45.33	74.00	-28.67	H	Peak
4762.000	45.79	4.20	49.99	74.00	-24.01	H	Peak
5554.000	42.35	5.89	48.24	74.00	-25.76	H	Peak

Remark:

1. Measuring frequencies from 1 GHz to the 10th harmonic of highest fundamental frequency.
2. Radiated emissions measured in frequency above 1000MHz were made with an instrument using peak/average detector mode.
3. Average test would be performed if the peak result were greater than the average limit or as required by the applicant.
4. Data of measurement within this frequency range shown " --- " in the table above means the reading of emissions are attenuated more than 20dB below the permissible limits or the field strength is too small to be measured.
5. Measurements above show only up to 6 maximum emissions noted, or would be lesser, with " N/A " remark, if no specific emissions from the EUT are recorded (ie: margin>20dB from the applicable limit) and considered that's already beyond the background noise floor.
6. Margin (dB) = Remark result (dBuV/m) – Average limit (dBuV/m).



Test Mode: TX / IEEE 802.11n HT40 MHz (CH Mid)

Tested by: Saber Huang

Ambient temperature: 24°C Relative humidity: 52% RH

Date: May 25, 2018

Frequency (MHz)	Reading (dBuV)	Correction Factor (dB/m)	Result (dBuV/m)	Limit (dBuV/m)	Margin (dB)	Antenna Pole (V/H)	Remark
2134.000	46.37	-4.27	42.10	74.00	-31.90	V	Peak
2683.000	45.45	-1.93	43.52	74.00	-30.48	V	Peak
3223.000	41.98	-0.99	40.99	74.00	-33.01	V	Peak
3844.000	41.70	0.93	42.63	74.00	-31.37	V	Peak
4330.000	42.93	2.75	45.68	74.00	-28.32	V	Peak
4762.000	43.19	4.20	47.39	74.00	-26.61	V	Peak
1333.000	47.93	-7.30	40.63	74.00	-33.37	H	Peak
2197.000	46.08	-3.92	42.16	74.00	-31.84	H	Peak
2674.000	46.47	-1.95	44.52	74.00	-29.48	H	Peak
3169.000	51.89	-1.08	50.81	74.00	-23.19	H	Peak
4411.000	42.24	3.04	45.28	74.00	-28.72	H	Peak
4762.000	44.53	4.20	48.73	74.00	-25.27	H	Peak

Remark:

1. Measuring frequencies from 1 GHz to the 10th harmonic of highest fundamental frequency.
2. Radiated emissions measured in frequency above 1000MHz were made with an instrument using peak/average detector mode.
3. Average test would be performed if the peak result were greater than the average limit or as required by the applicant.
4. Data of measurement within this frequency range shown " --- " in the table above means the reading of emissions are attenuated more than 20dB below the permissible limits or the field strength is too small to be measured.
5. Measurements above show only up to 6 maximum emissions noted, or would be lesser, with " N/A " remark, if no specific emissions from the EUT are recorded (ie: margin>20dB from the applicable limit) and considered that's already beyond the background noise floor.
6. Margin (dB) = Remark result (dBuV/m) – Average limit (dBuV/m).



Test Mode: TX / EEE 802.11n HT40 MHz (CH High)

Tested by: Saber Huang

Ambient temperature: 24°C Relative humidity: 52% RH

Date: May 25, 2018

Frequency (MHz)	Reading (dBUV)	Correction Factor (dB/m)	Result (dBUV/m)	Limit (dBUV/m)	Margin (dB)	Antenna Pole (V/H)	Remark
2818.000	42.95	-1.69	41.26	74.00	-32.74	V	Peak
3061.000	41.93	-1.26	40.67	74.00	-33.33	V	Peak
3646.000	40.41	0.10	40.51	74.00	-33.49	V	Peak
4213.000	40.69	2.34	43.03	74.00	-30.97	V	Peak
4285.000	43.49	2.59	46.08	74.00	-27.92	V	Peak
4987.000	41.20	4.94	46.14	74.00	-27.86	V	Peak
1360.000	47.88	-7.21	40.67	74.00	-33.33	H	Peak
2206.000	46.34	-3.87	42.47	74.00	-31.53	H	Peak
2692.000	47.14	-1.91	45.23	74.00	-28.77	H	Peak
3169.000	49.29	-1.08	48.21	74.00	-25.79	H	Peak
4204.000	44.51	2.31	46.82	74.00	-27.18	H	Peak
4762.000	43.67	4.20	47.87	74.00	-26.13	H	Peak

Remark:

1. Measuring frequencies from 1 GHz to the 10th harmonic of highest fundamental frequency.
2. Radiated emissions measured in frequency above 1000MHz were made with an instrument using peak/average detector mode.
3. Average test would be performed if the peak result were greater than the average limit or as required by the applicant.
4. Data of measurement within this frequency range shown " --- " in the table above means the reading of emissions are attenuated more than 20dB below the permissible limits or the field strength is too small to be measured.
5. Measurements above show only up to 6 maximum emissions noted, or would be lesser, with " N/A " remark, if no specific emissions from the EUT are recorded (ie: margin>20dB from the applicable limit) and considered that's already beyond the background noise floor.
6. Margin (dB) = Remark result (dBUV/m) – Average limit (dBUV/m).



7.3. 6dB BANDWIDTH MEASUREMENT

7.3.1. LIMITS

According to §15.247(a)(2), systems using digital modulation techniques may operate in the 902 - 928 MHz, 2400 - 2483.5 MHz. The minimum 6 dB bandwidth shall be at least 500 kHz.

7.3.2. TEST INSTRUMENTS

Name of Equipment	Manufacturer	Model	Serial Number	Last Calibration	Calibration Due
Spectrum Analyzer	Agilent	N9010A	MY52221469	01/27/2018	01/26/2019

7.3.3. TEST PROCEDURES (please refer to measurement standard)

8.2 Option 2:

The automatic bandwidth measurement capability of an instrument may be employed using the X dB bandwidth mode with X set to 6 dB, if the functionality described above (i.e., $RBW = 100 \text{ kHz}$, $VBW \geq 3 \text{ RBW}$, peak detector with maximum hold) is implemented by the instrumentation function. When using this capability, care shall be taken so that the bandwidth measurement is not influenced by any intermediate power nulls in the fundamental emission that might be $\geq 6 \text{ dB}$.

7.3.4. TEST SETUP

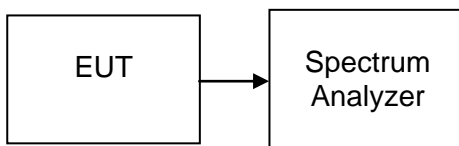



7.3.5. TEST RESULTS

No non-compliance noted

Test Data

Test mode: IEEE 802.11b

Channel	Frequency (MHz)	Bandwidth (kHz)	Limit (kHz)	Test Result
Low	2412	9038	>500	PASS
Mid	2437	9039		PASS
High	2462	9039		PASS

Test mode: IEEE 802.11g

Channel	Frequency (MHz)	Bandwidth (kHz)	Limit (kHz)	Test Result
Low	2412	16020	>500	PASS
Mid	2437	15890		PASS
High	2462	15550		PASS

Test mode: IEEE 802.11n HT20 MHz

Channel	Frequency (MHz)	Bandwidth (kHz)	Limit (kHz)	Test Result
Low	2412	16790	>500	PASS
Mid	2437	16900		PASS
High	2462	16780		PASS

Test mode: IEEE 802.11n HT40 MHz

Channel	Frequency (MHz)	Bandwidth (kHz)	Limit (kHz)	Test Result
Low	2422	35360	>500	PASS
Mid	2437	35350		PASS
High	2452	35340		PASS



Test Plot

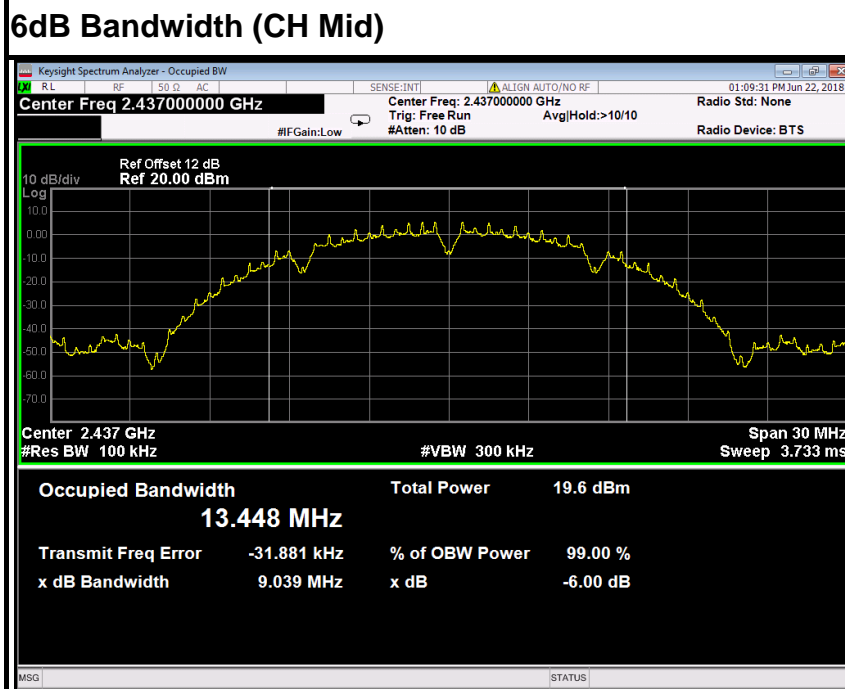
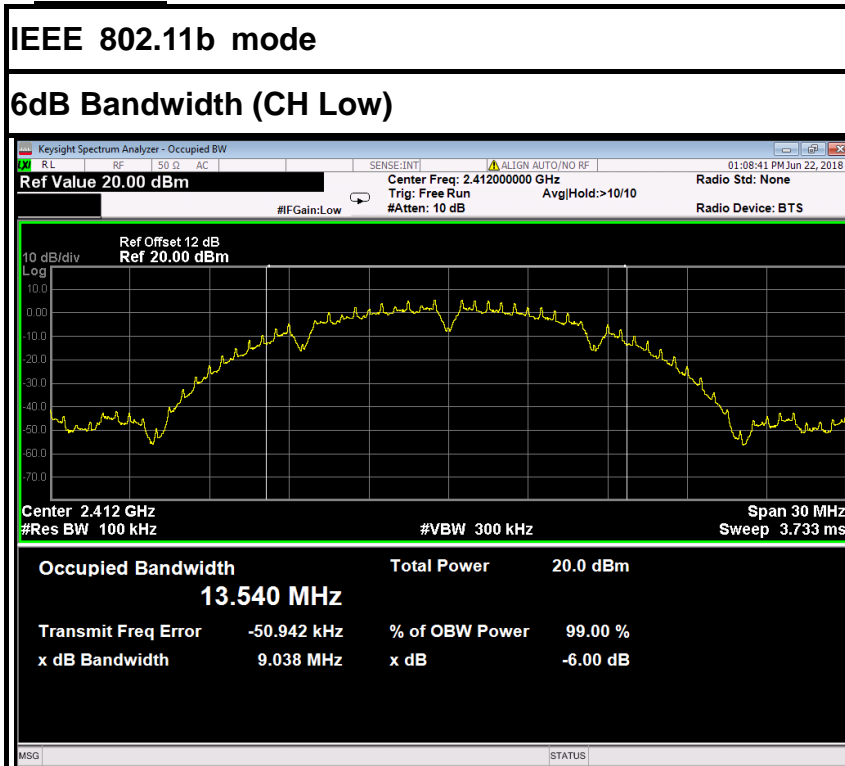

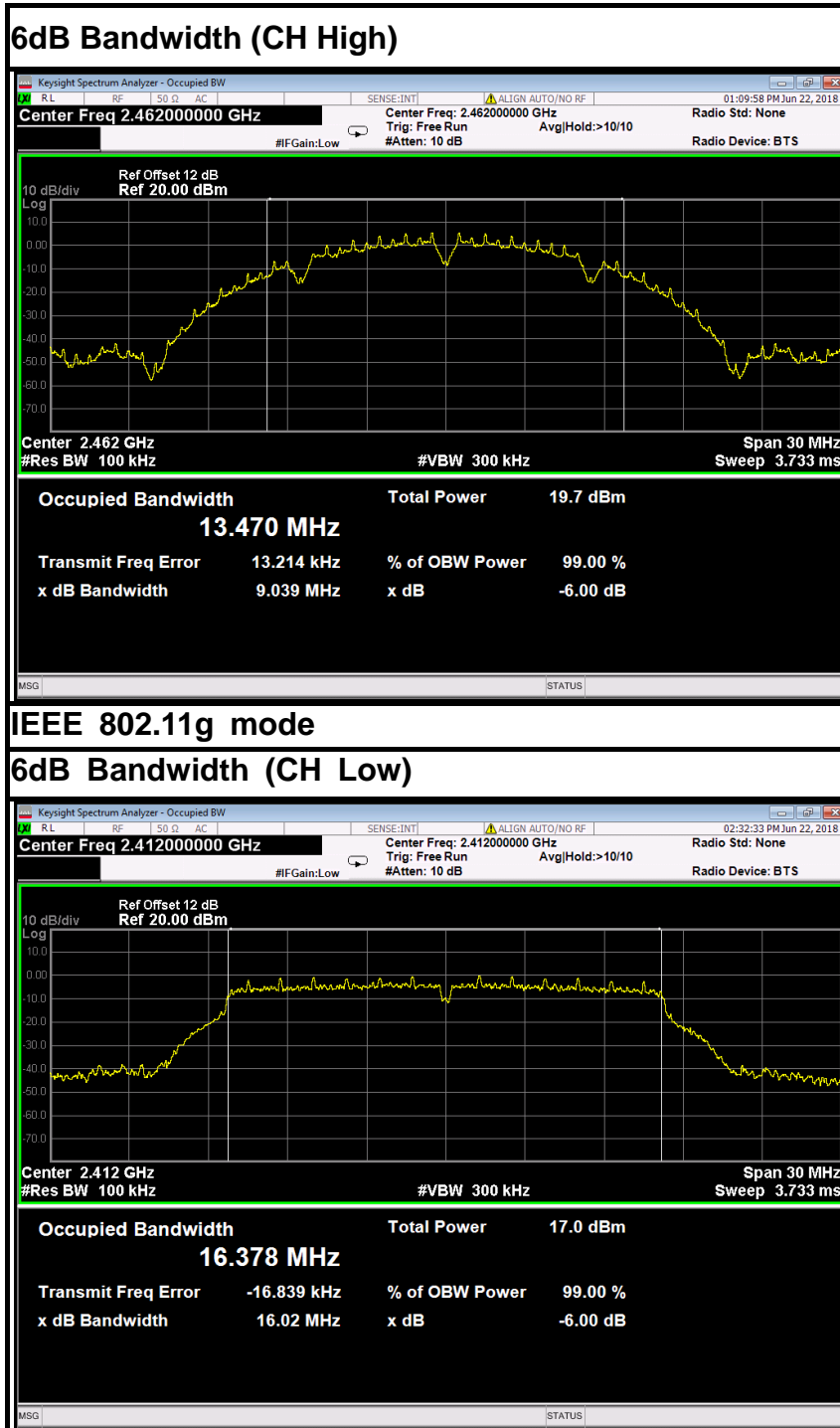

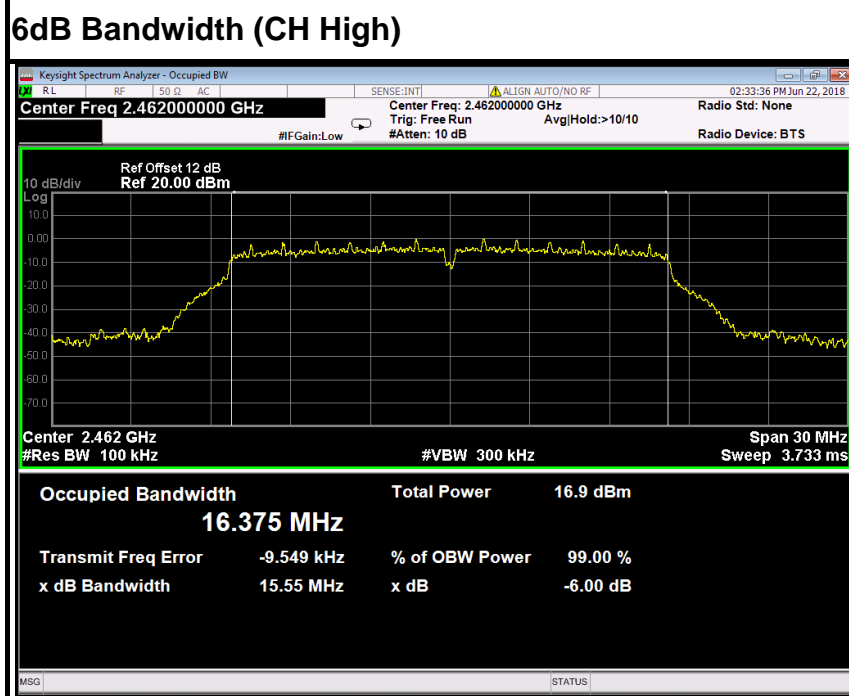
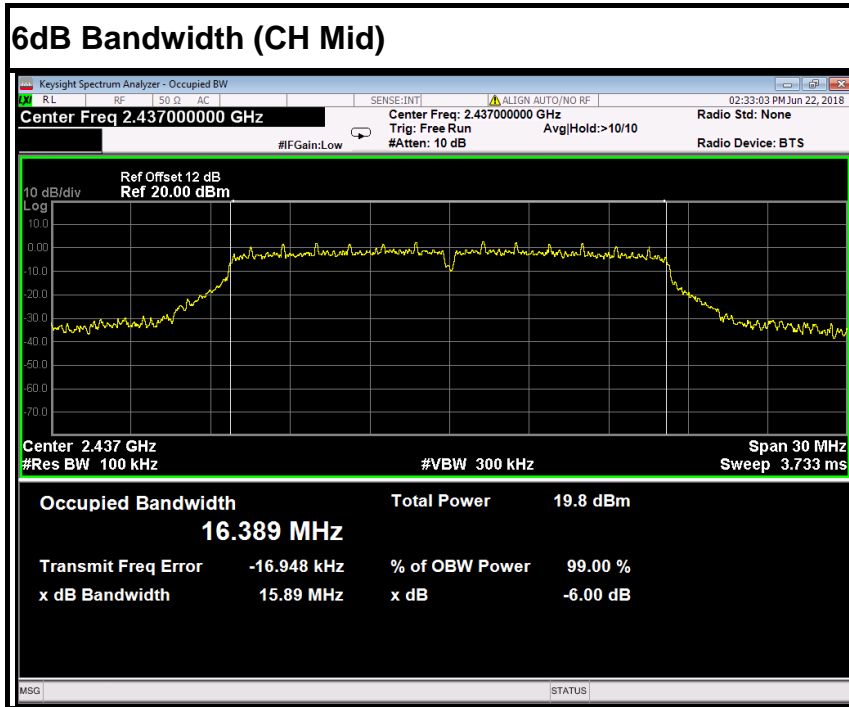



IEEE 802.11n HT20 MHz mode

6dB Bandwidth (CH Low)

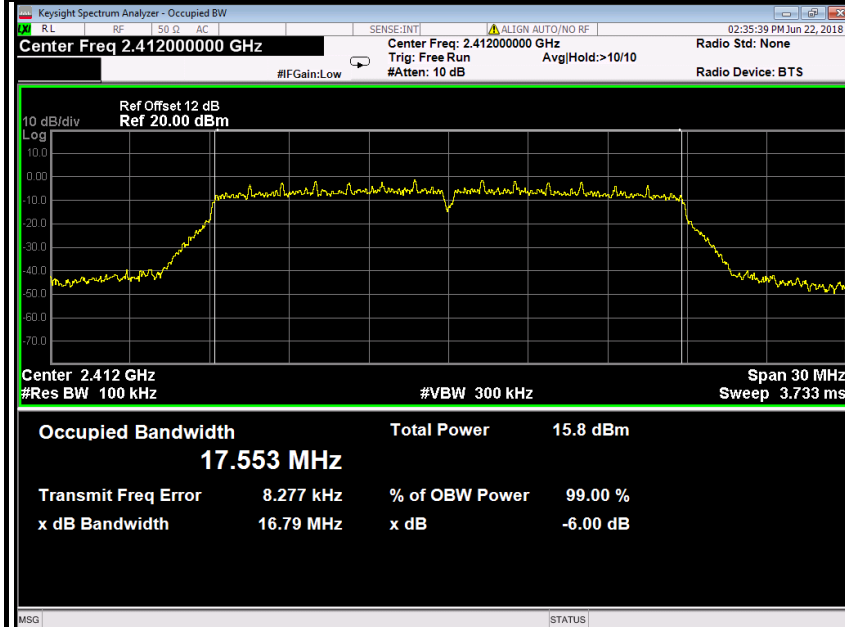

6dB Bandwidth (CH Mid)

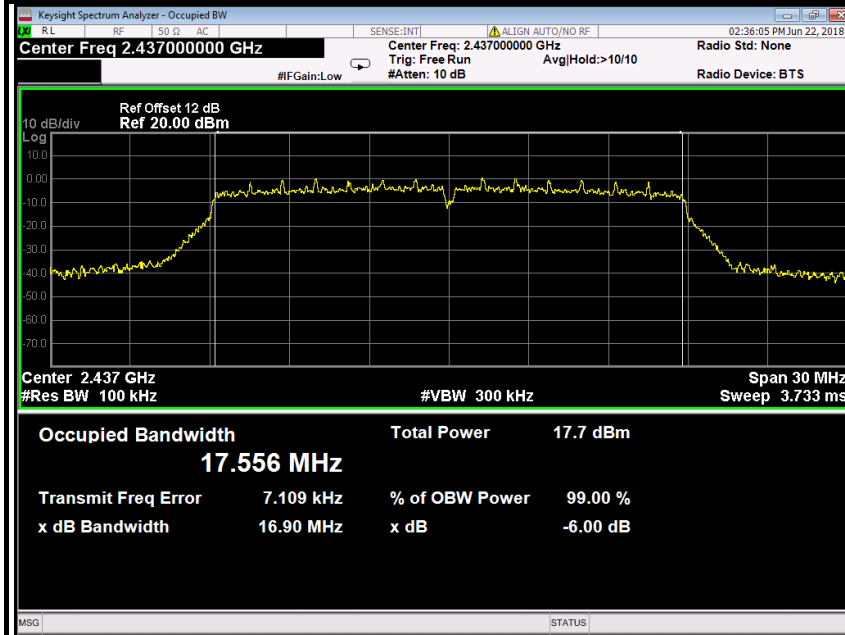

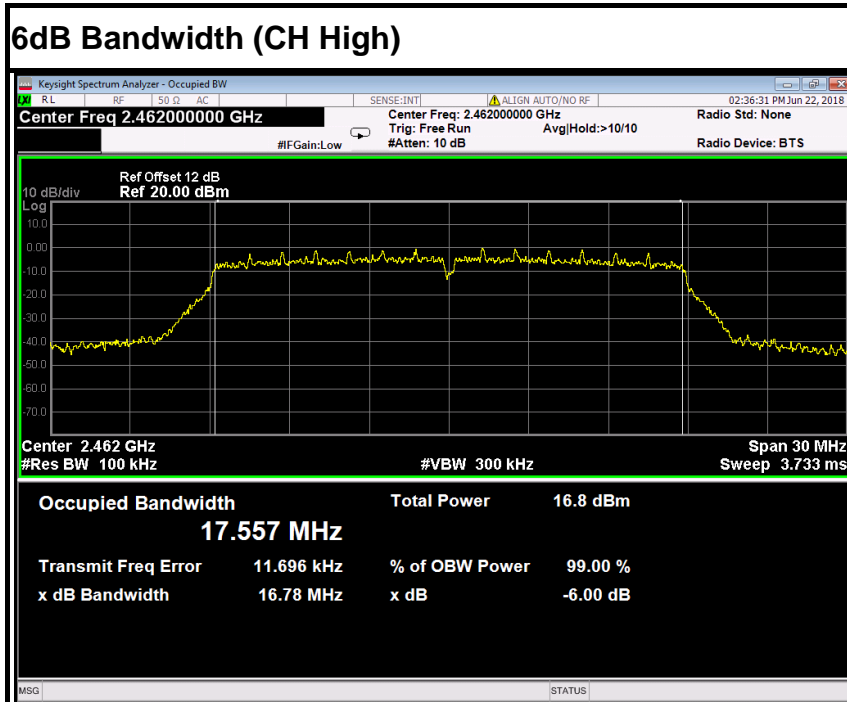

IEEE 802.11n HT40 MHz mode

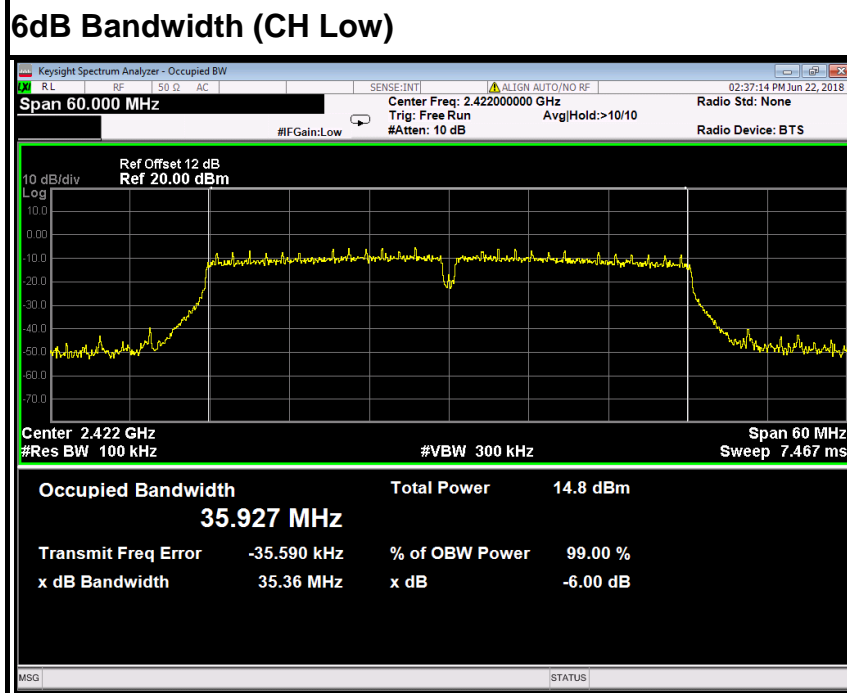

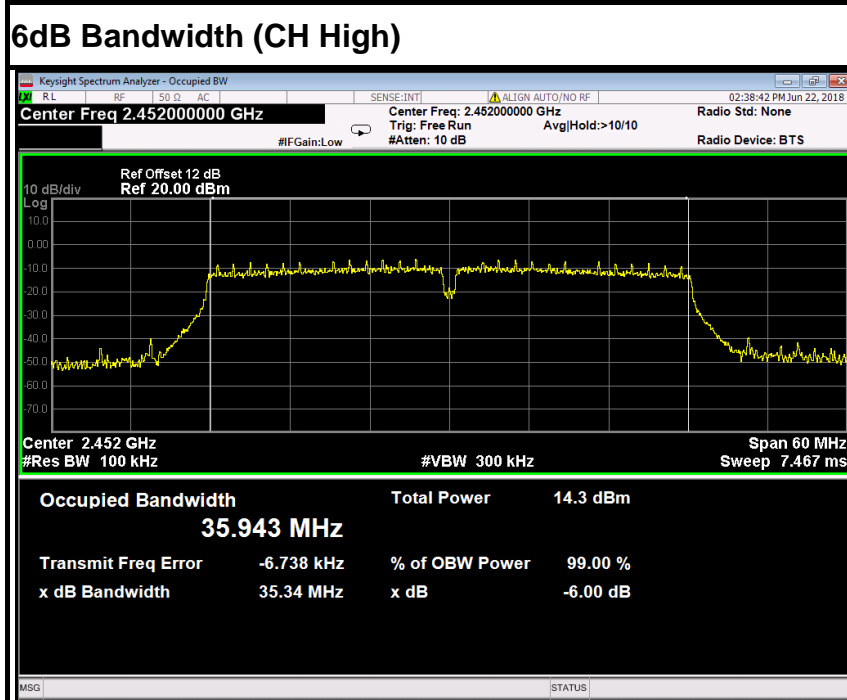
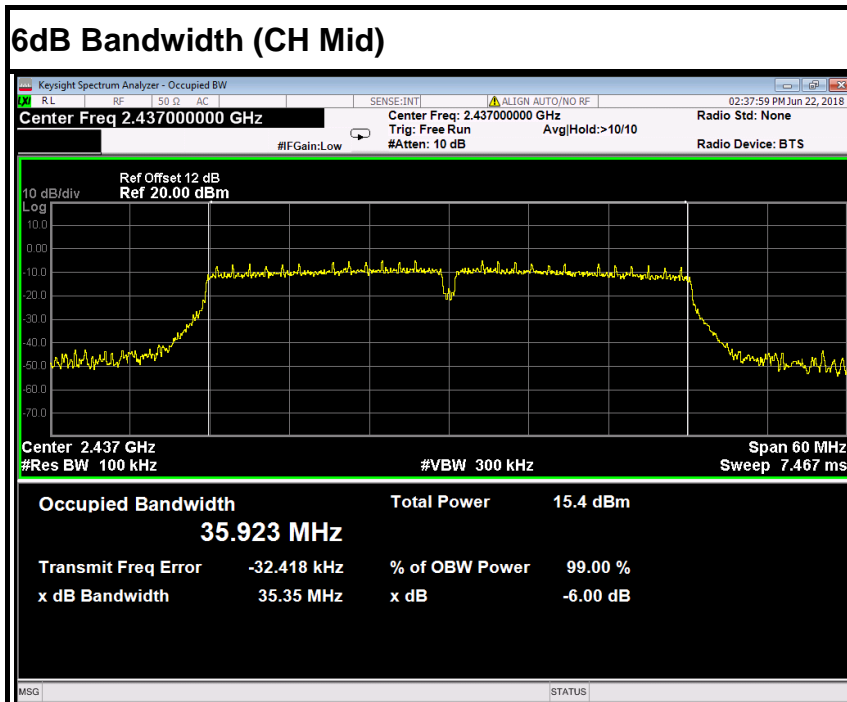



7.4. ANTENNA GAIN

MEASUREMENT

The antenna gain of the complete system is calculated by the difference of radiated power in EIRP and the conducted power of the module. For normal WLAN devices, the DSSS mode is used.

MEASUREMENT PARAMETERS

Measurement parameter	
Detector	Peak
Sweep time	Auto
Resolution bandwidth	3 MHz
Video bandwidth	3 MHz
Trace-Mode	Max hold

LIMITS

FCC	IC
Antenna Gain	
6 dBi	

TEST RESULTS

IEEE 802.11b

T _{nom}	V _{nom}	Lowest channel 2412MHz	Middle channel 2437MHz	Highest channel 2462MHz
Conducted power [dBm/MHz] Measured with DSSS modulation		4.55	4.54	4.66
Radiated power [dBm/MHz] Measured with DSSS modulation		5.67	5.75	5.82
Gain [dBi] Calculated		1.12	1.21	1.16
Measurement uncertainty		± 1.5 dB (cond.) / ± 3 dB (rad.)		



7.5. PEAK OUTPUT POWER

7.5.1. LIMITS

The maximum peak output power of the intentional radiator shall not exceed the following:

1. According to §15.247(b)(3), for systems using digital modulation in the bands of 902-928 MHz, 2400-2483.5 MHz, and 5725-5850 MHz: 1 Watt.
2. According to §15.247(b)(4), the conducted output power limit specified in paragraph (b) of this section is based on the use of antennas with directional gains that do not exceed 6 dBi. Except as shown in paragraph (c) of this section, if transmitting antennas of directional gain greater than 6 dBi are used, the conducted output power from the intentional radiator shall be reduced below the stated values in paragraphs (b)(1), (b)(2), and (b)(3) of this section, as appropriate, by the amount in dB that the directional gain of the antenna exceeds 6 dBi.

7.5.2. TEST INSTRUMENTS

Name of Equipment	Manufacturer	Model	Serial Number	Last Calibration	Calibration Due
Power Meter	Anritsu	ML2495A	1204003	02/21/2018	02/20/2019
Power Sensor	Anritsu	MA2411B	1126150	02/21/2018	02/20/2019

7.5.3. TEST PROCEDURES (please refer to measurement standard)

9.1.1 RBW ≥ DTS bandwidth

This procedure shall be used when the measurement instrument has available a resolution bandwidth that is greater than the *DTS bandwidth*.

- a) Set the RBW ≥ *DTS bandwidth*.
- b) Set VBW ≥ 3 RBW.
- c) Set span ≥ 3 x RBW
- d) Sweep time = auto couple.
- e) Detector = peak.
- f) Trace mode = max hold.
- g) Allow trace to fully stabilize.
- h) Use peak marker function to determine the peak amplitude level.

9.1.3 PKPM1 Peak power meter method

The maximum peak conducted output power may be measured using a broadband peak RF power meter. The power meter shall have a video bandwidth that is greater than or equal to the DTS bandwidth and shall utilize a fast-responding diode detector.

7.5.4. TEST SETUP

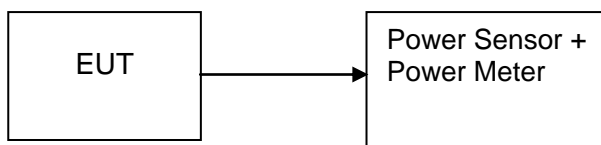



7.5.5. TEST RESULTS

No non-compliance noted

Test Data

Test mode: IEEE 802.11b

Channel	Frequency (MHz)	Output Power (dBm)	Output Power (W)	Peak / AVG	Limit (W)	Result
Low	2412	15.91	0.03899	Peak	1	PASS
Mid	2437	15.89	0.03882			PASS
High	2462	16.01	0.03990			PASS
Low	2412	13.97	0.02495	AVG	1	PASS
Mid	2437	13.93	0.02472			PASS
High	2462	14.09	0.02564			PASS

Test mode: IEEE 802.11g

Channel	Frequency (MHz)	Output Power (dBm)	Output Power (W)	Peak / AVG	Limit (W)	Result
Low	2412	21.51	0.14158	Peak	1	PASS
Mid	2437	21.17	0.13092			PASS
High	2462	20.82	0.12078			PASS
Low	2412	13.77	0.02382	AVG	1	PASS
Mid	2437	13.42	0.02198			PASS
High	2462	13.25	0.02113			PASS

Test mode: IEEE 802.11n HT20 MHz

Channel	Frequency (MHz)	Output Power (dBm)	Output Power (W)	Peak / AVG	Limit (W)	Result
Low	2412	19.75	0.09441	Peak	1	PASS
Mid	2437	20.06	0.10139			PASS
High	2462	20.02	0.10046			PASS
Low	2412	11.41	0.01384	AVG	1	PASS
Mid	2437	11.95	0.01567			PASS
High	2462	11.62	0.01452			PASS

Test mode: IEEE 802.11n HT40 MHz

Channel	Frequency (MHz)	Output Power (dBm)	Output Power (W)	Peak / AVG	Limit (W)	Result
Low	2422	19.27	0.08453	Peak	1	PASS
Mid	2437	20.19	0.10447			PASS
High	2452	19.00	0.07943			PASS
Low	2422	11.10	0.01288	AVG	1	PASS
Mid	2437	11.64	0.01459			PASS
High	2452	10.52	0.01127			PASS



7.6. BAND EDGES MEASUREMENT

7.6.1. LIMITS

According to §15.247(d), in any 100 kHz bandwidth outside the frequency bands in which the spread spectrum intentional radiator is operating, the radio frequency power that is produced by the intentional radiator shall be at least 20 dB below that in the 100 kHz bandwidth within the band that contains the highest level of the desired power, based on either an RF conducted or a radiated measurement, provided the transmitter demonstrates compliance with the peak conducted power limits. In addition, radiated emissions which fall in the restricted bands, as defined in §15.205(a), must also comply with the radiated emission limits specified in 15.209(a) (see Section 15.205(c)).

7.6.2. TEST INSTRUMENTS

Radiated Emission Test Site 966 (2)					
Name of Equipment	Manufacturer	Model Number	Serial Number	Last Calibration	Due Calibration
PSA Series Spectrum Analyzer	Agilent	N9010A	MY52221469	01/27/2018	01/26/2019
EMI TEST RECEIVER	ROHDE&SCHWARZ	ESCI	100783	02/21/2018	02/20/2019
Amplifier	EMEC	EM330	060661	03/18/2018	03/17/2019
High Noise Amplifier	Agilent	8449B	3008A01838	02/21/2018	02/20/2019
Loop Antenna	COM-POWER	AL-130	121044	09/25/2017	09/24/2018
Bilog Antenna	SCHAFFNER	CBL6143	5082	02/21/2018	02/20/2019
Horn Antenna	SCHWARZBECK	BBHA9120	D286	02/27/2018	02/27/2019
Board-Band Horn Antenna	Schwarzbeck	BBHA 9170	9170-497	02/27/2018	02/27/2019
Turn Table	N/A	N/A	N/A	N.C.R	N.C.R
Antenna Tower	SUNOL	TLT2	N/A	N.C.R	N.C.R
Controller	Sunol Sciences	SC104V	022310-1	N.C.R	N.C.R
Controller	CT	N/A	N/A	N.C.R	N.C.R
Temp. / Humidity Meter	Anymetre	JR913	N/A	01/29/2018	01/28/2019
Test S/W	FARAD	LZ-RF / CCS-SZ-3A2			

- NOTE:**
1. The calibration interval of the above test instruments is 12 months and the calibrations are traceable to NML/ROC and NIST/USA.
 2. The FCC Site Registration number is 101879.
 3. N.C.R = No Calibration Required.



7.6.3. TEST PROCEDURES (please refer to measurement standard)

1. The EUT is placed on a turntable, which is 1.5m above the ground plane.
2. The turntable shall be rotated for 360 degrees to determine the position of maximum emission level.
3. EUT is set 3m away from the receiving antenna, which is varied from 1m to 4m to find out the highest emission.
4. Set the spectrum analyzer in the following setting in order to capture the lower and upper band-edges of the emission:
 - (a) PEAK: RBW=1MHz / VBW=3MHz / Sweep=AUTO
 - (b) AVERAGE: RBW=1MHz / VBW=1/T / Sweep=AUTO / Detector=PEAK
5. Repeat the procedures until all the PEAK and AVERAGE versus POLARIZATION are measured.

7.6.4. TEST SETUP

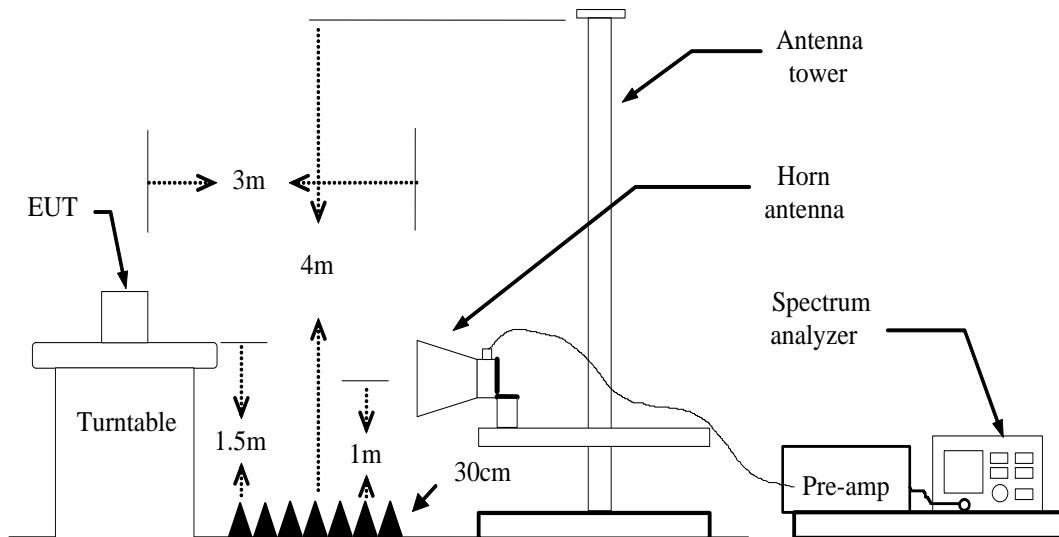



7.6.5. TEST RESULTS

Test Plot

IEEE 802.11b mode
Band Edges (CH Low)

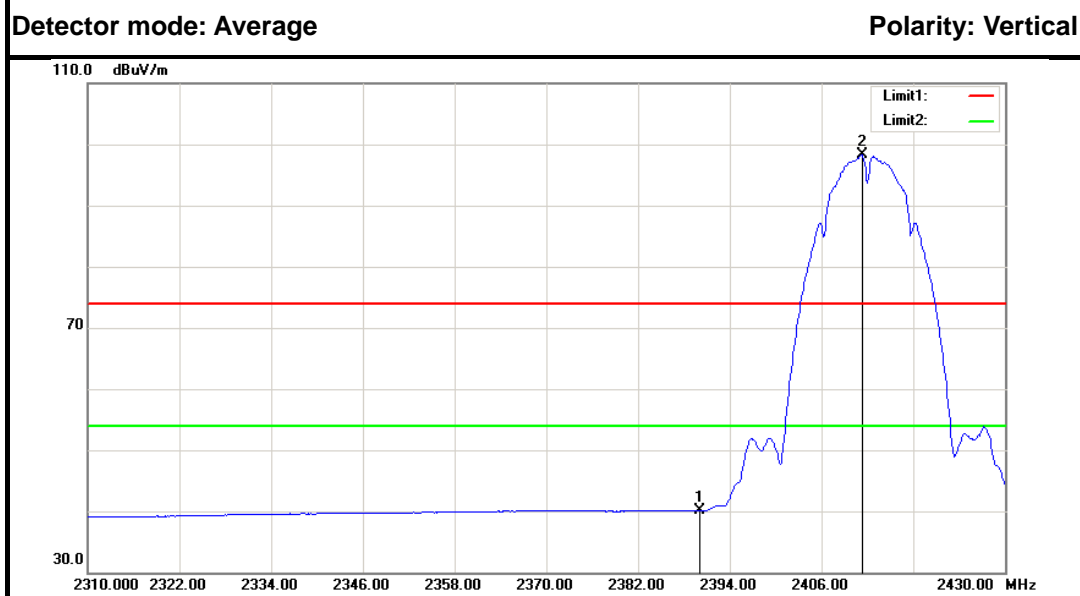
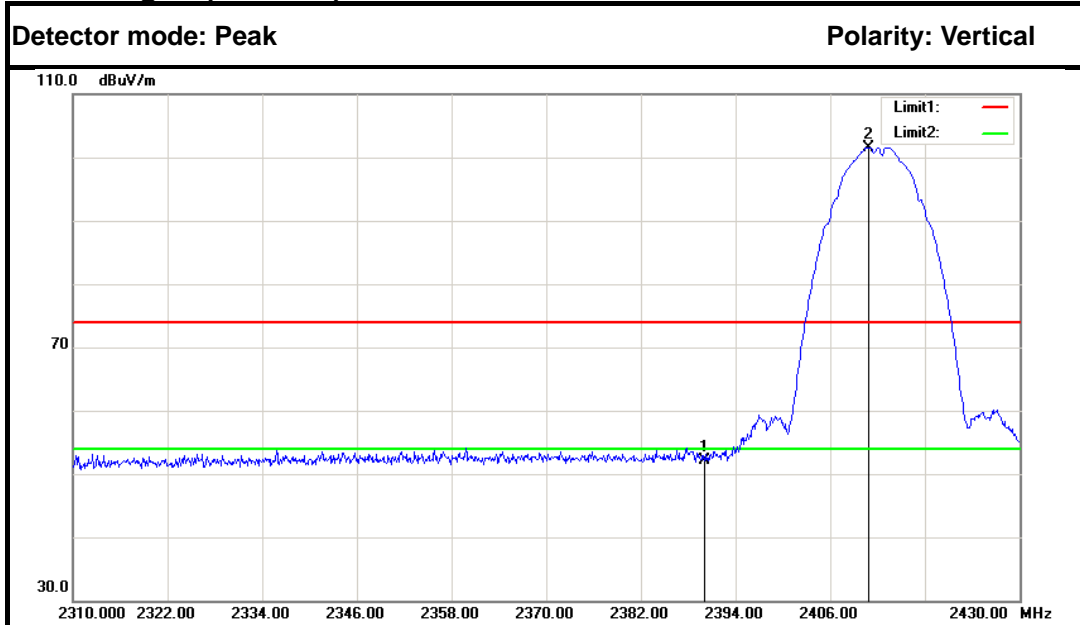

No.	Frequency (MHz)	Reading (dB)	Factor (dB/m)	Result (dB/m)	Limit (dB/m)	Margin (dB)	Remark	Antenna Polar
1.	2390.000	54.98	-2.86	52.12	74.00	-21.88	Peak	Vertical
2.	2410.920	104.35	-2.75	101.60	---	---	Peak	Vertical
1.	2390.000	42.90	-2.86	40.04	54.00	-13.96	Average	Vertical
2.	2411.280	100.99	-2.75	98.24	---	---	Average	Vertical

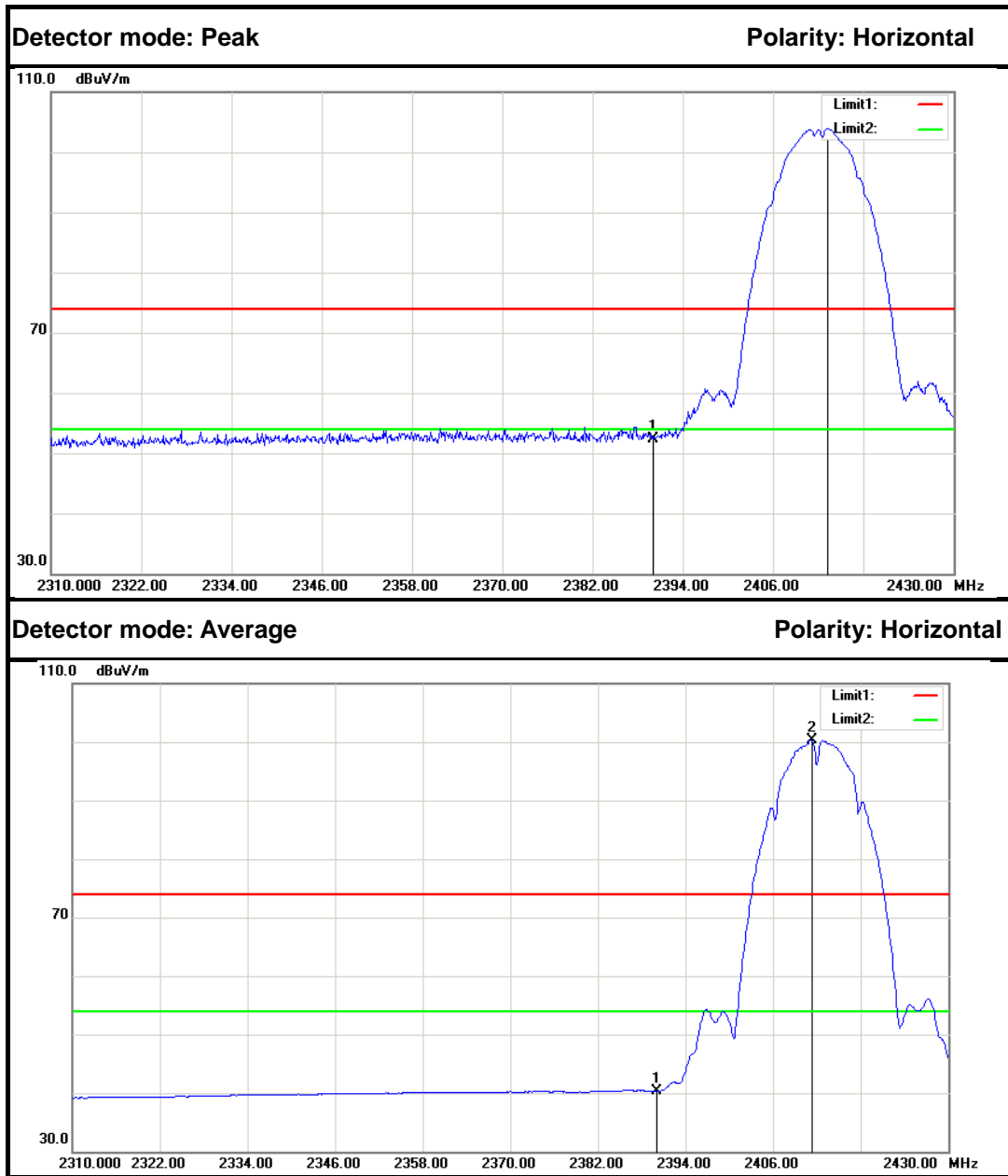

No.	Frequency (MHz)	Reading (dB)	Factor (dB/m)	Result (dB/m)	Limit (dB/m)	Margin (dB)	Remark	Antenna Polar
1.	2390.000	55.12	-2.86	52.26	74.00	-21.74	Peak	Horizontal
2.	2413.320	106.60	-2.73	103.87	---	---	Peak	Horizontal
1.	2390.000	43.20	-2.86	40.34	54.00	-13.66	Average	Horizontal
2.	2411.280	103.11	-2.75	100.36	---	---	Average	Horizontal



Band Edges (CH High)

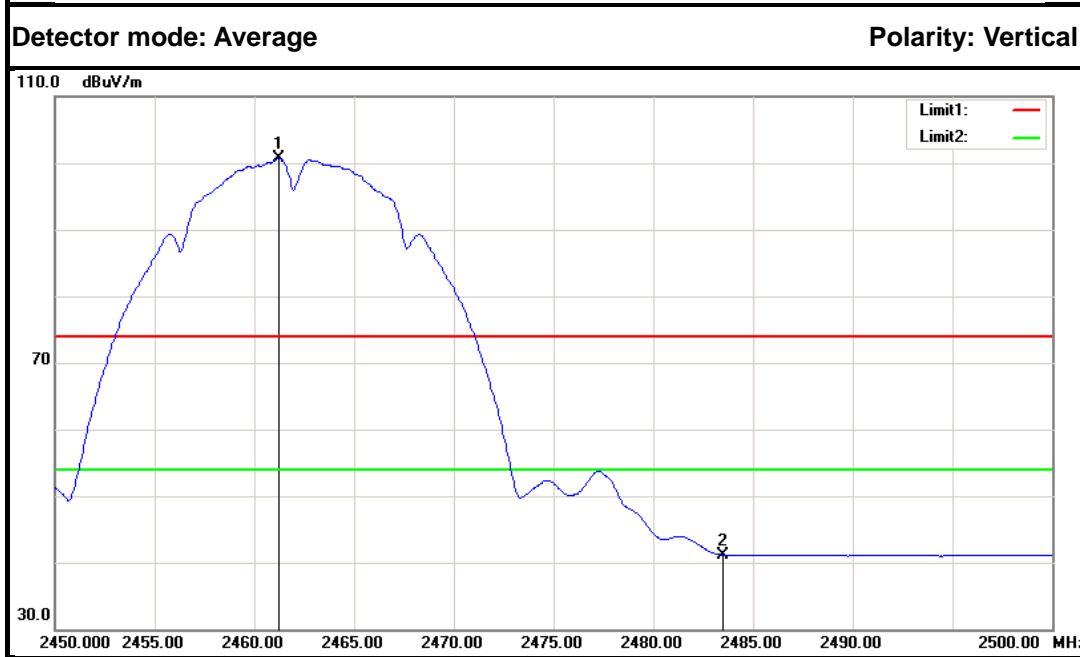
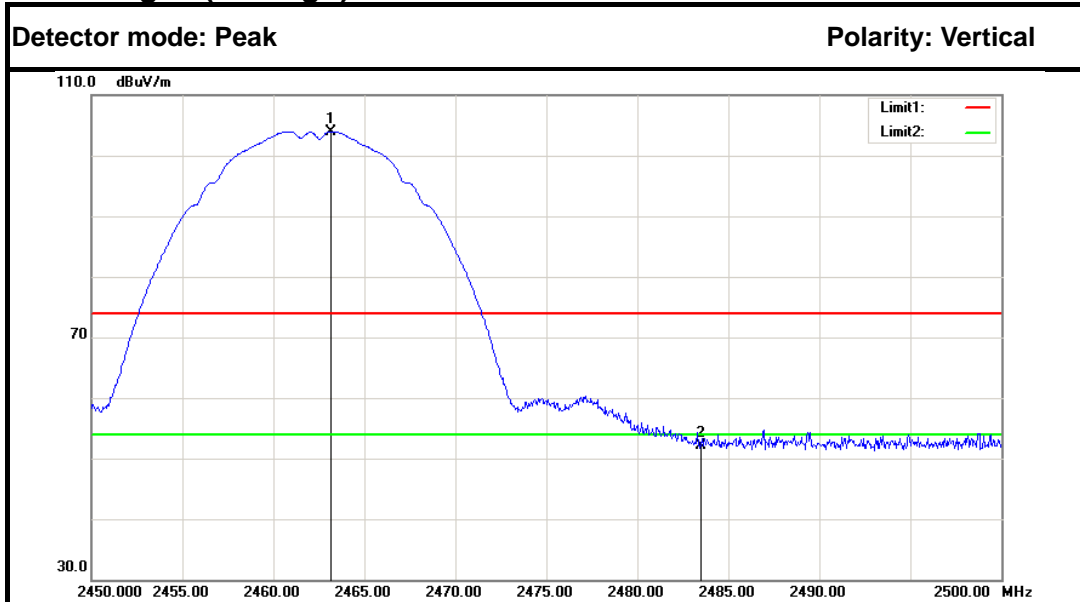

No.	Frequency (MHz)	Reading (dB)	Factor (dB/m)	Result (dB/m)	Limit (dB/m)	Margin (dB)	Remark	Antenna Polar
1.	2463.150	106.44	-2.46	103.98	---	---	Peak	Vertical
2.	2483.500	54.38	-2.35	52.03	74.00	-21.97	Peak	Vertical
1.	2461.200	103.12	-2.47	100.65	---	---	Average	Vertical
2.	2483.500	43.52	-2.35	41.17	54.00	-12.83	Average	Vertical

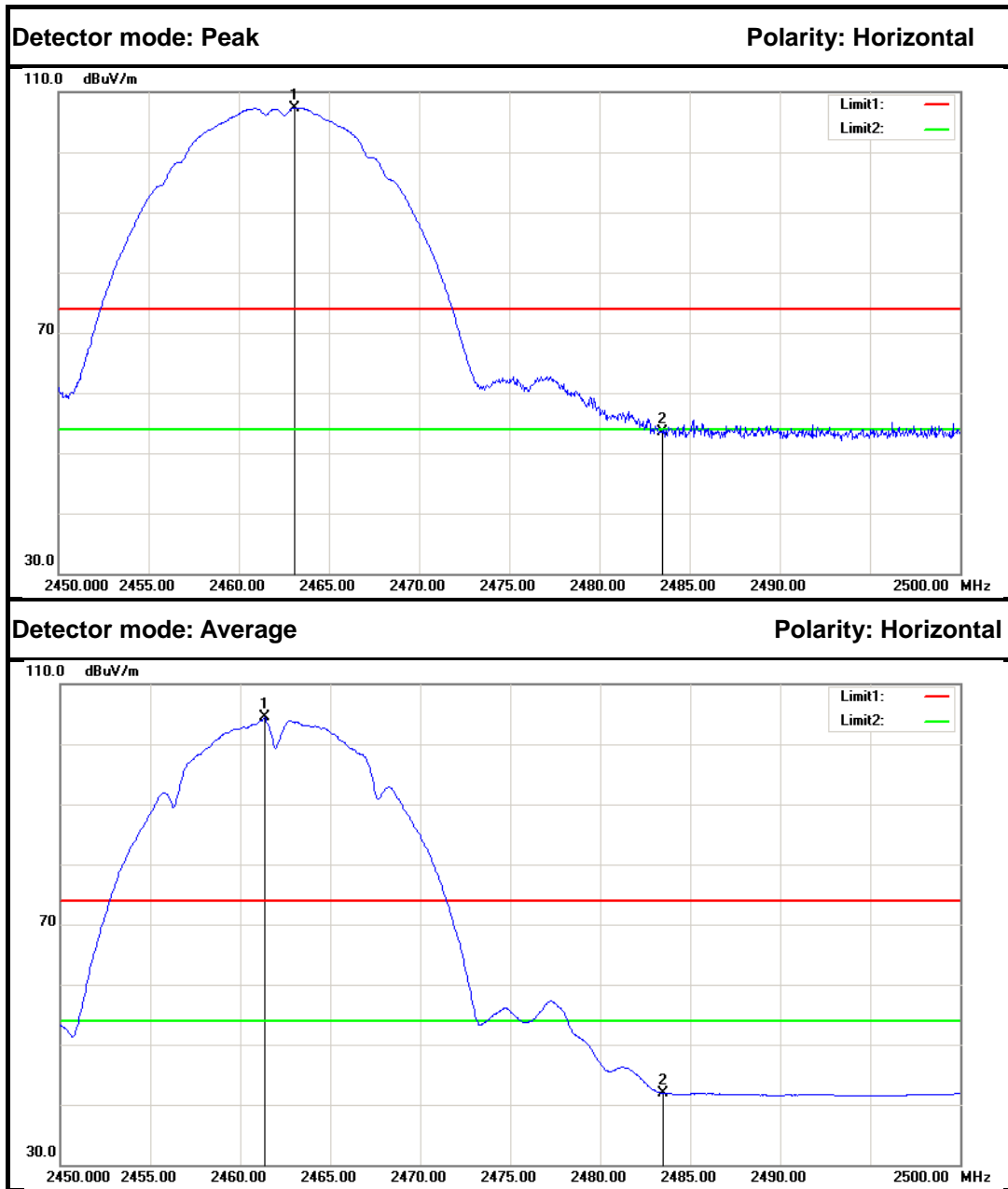

No.	Frequency (MHz)	Reading (dB)	Factor (dB/m)	Result (dB/m)	Limit (dB/m)	Margin (dB)	Remark	Antenna Polar
1.	2463.100	109.85	-2.46	107.39	---	---	Peak	Horizontal
2.	2483.500	55.85	-2.35	53.50	74.00	-20.50	Peak	Horizontal
1.	2461.350	106.89	-2.47	104.42	---	---	Average	Horizontal
2.	2483.500	44.26	-2.35	41.91	54.00	-12.09	Average	Horizontal



IEEE 802.11g mode
Band Edges (CH Low)

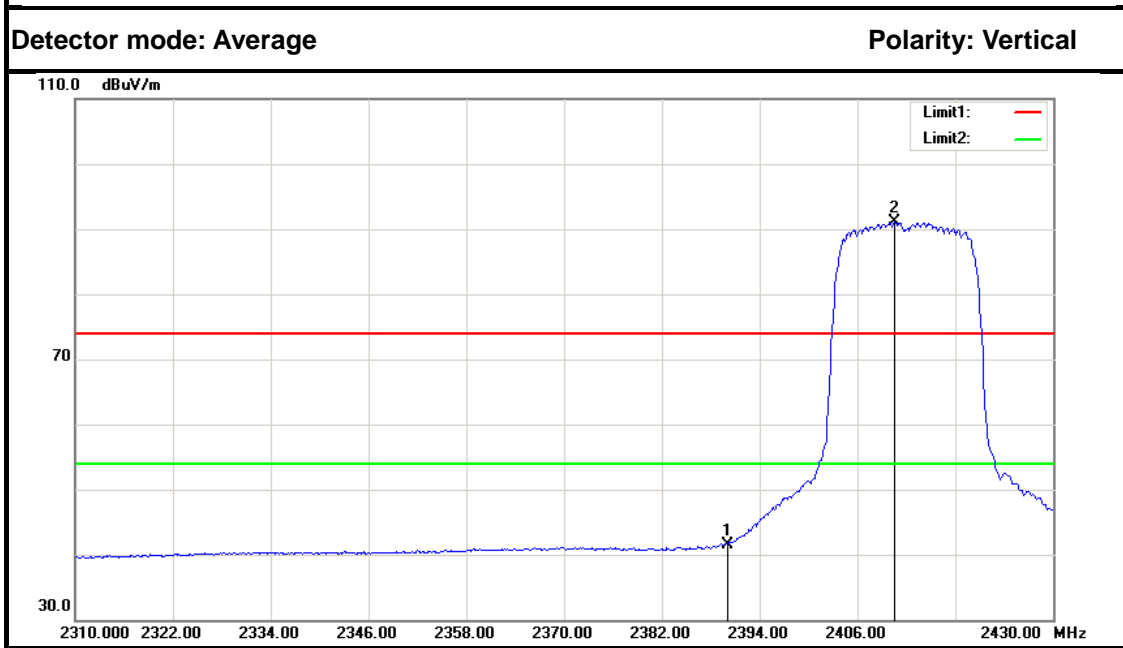
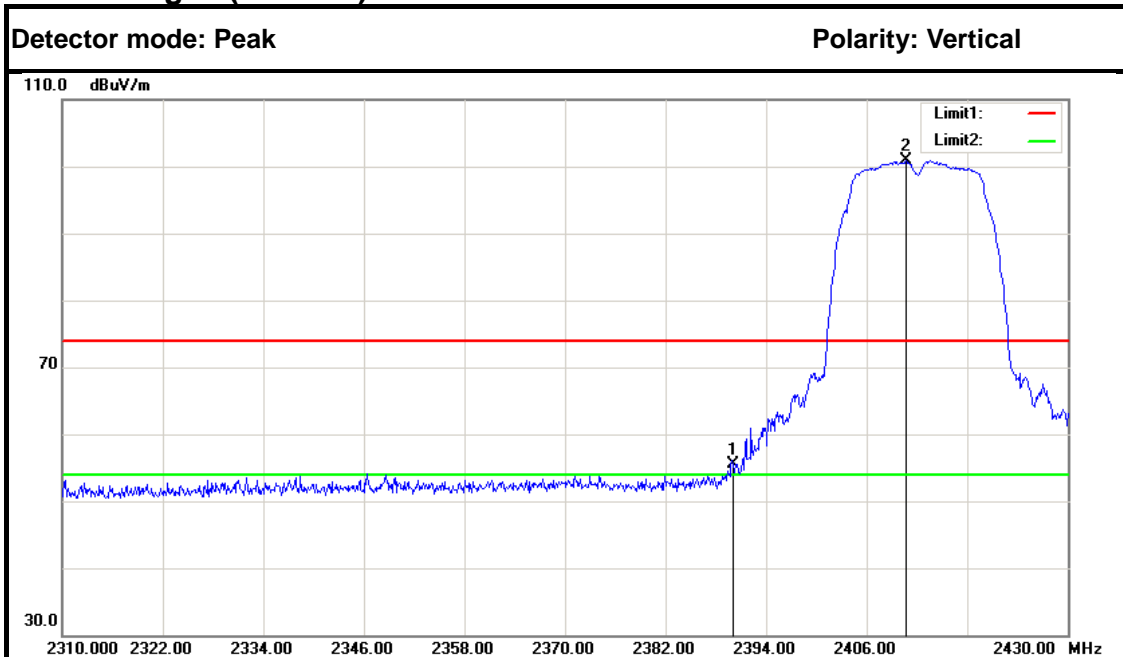

No.	Frequency (MHz)	Reading (dB)	Factor (dB/m)	Result (dB/m)	Limit (dB/m)	Margin (dB)	Remark	Antenna Polar
1.	2390.000	58.34	-2.86	55.48	74.00	-18.52	Peak	Vertical
2.	2410.680	103.56	-2.75	100.81	---	---	Peak	Vertical
1.	2390.000	44.45	-2.86	41.59	54.00	-12.41	Average	Vertical
2.	2410.560	93.85	-2.75	91.10	---	---	Average	Vertical

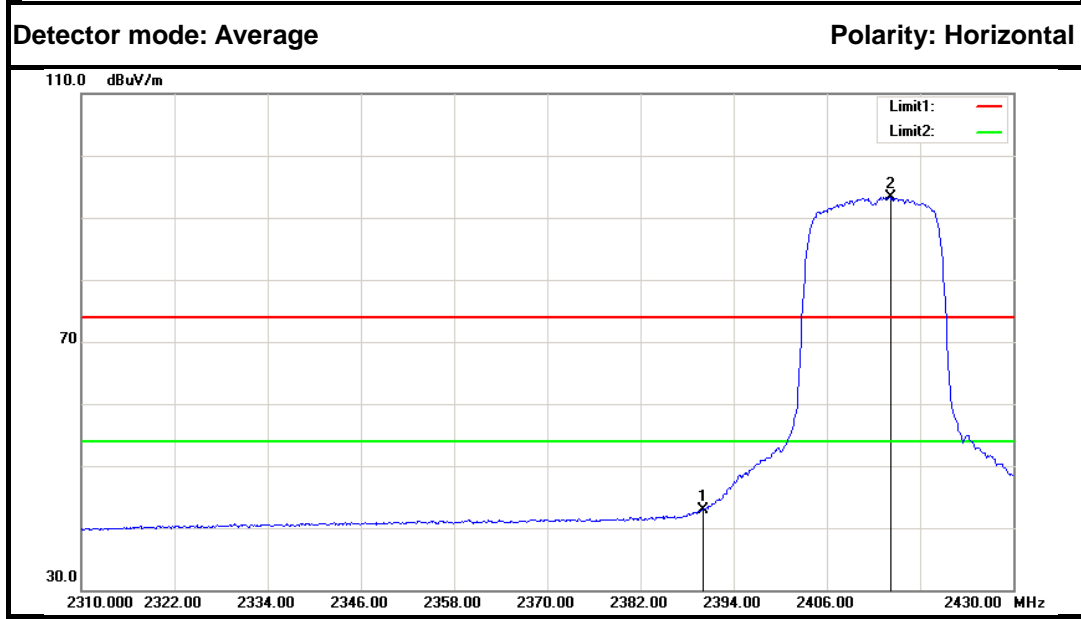
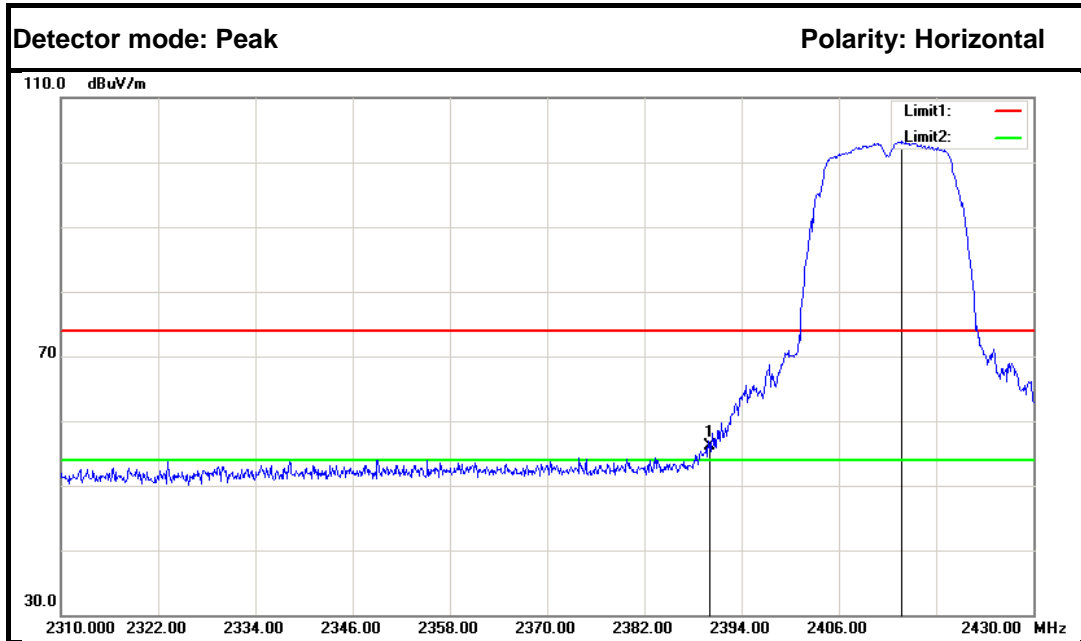

No.	Frequency (MHz)	Reading (dB)	Factor (dB/m)	Result (dB/m)	Limit (dB/m)	Margin (dB)	Remark	Antenna Polar
1.	2390.000	58.89	-2.86	56.03	74.00	-17.97	Peak	Horizontal
2.	2413.680	105.94	-2.73	103.21	---	---	Peak	Horizontal
1.	2390.000	45.83	-2.86	42.97	54.00	-11.03	Average	Horizontal
2.	2414.160	96.11	-2.73	93.38	---	---	Average	Horizontal



Band Edges (CH High)

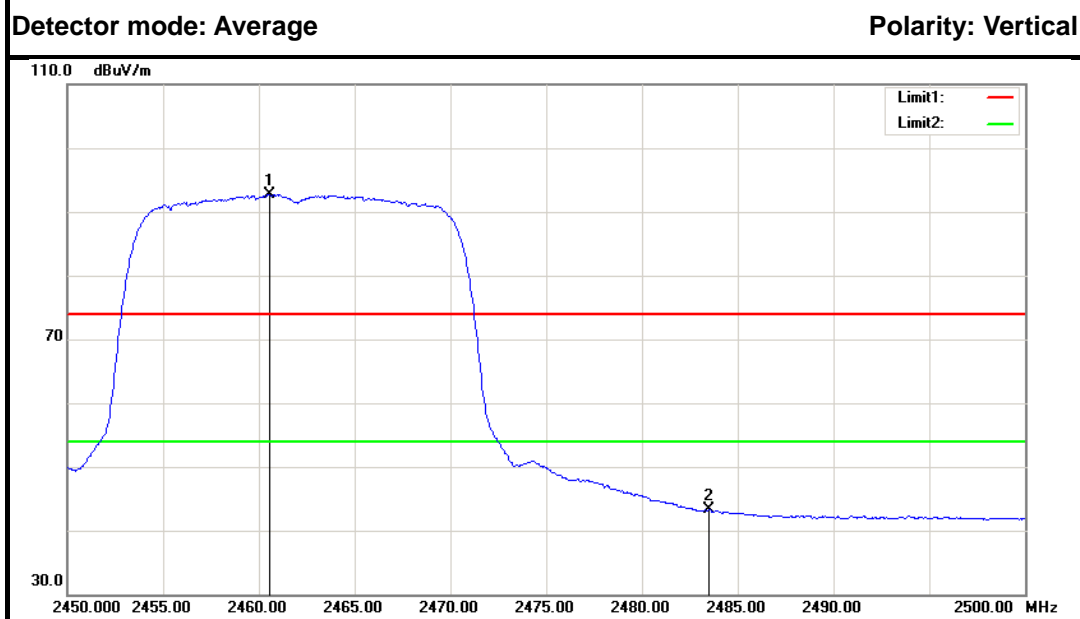
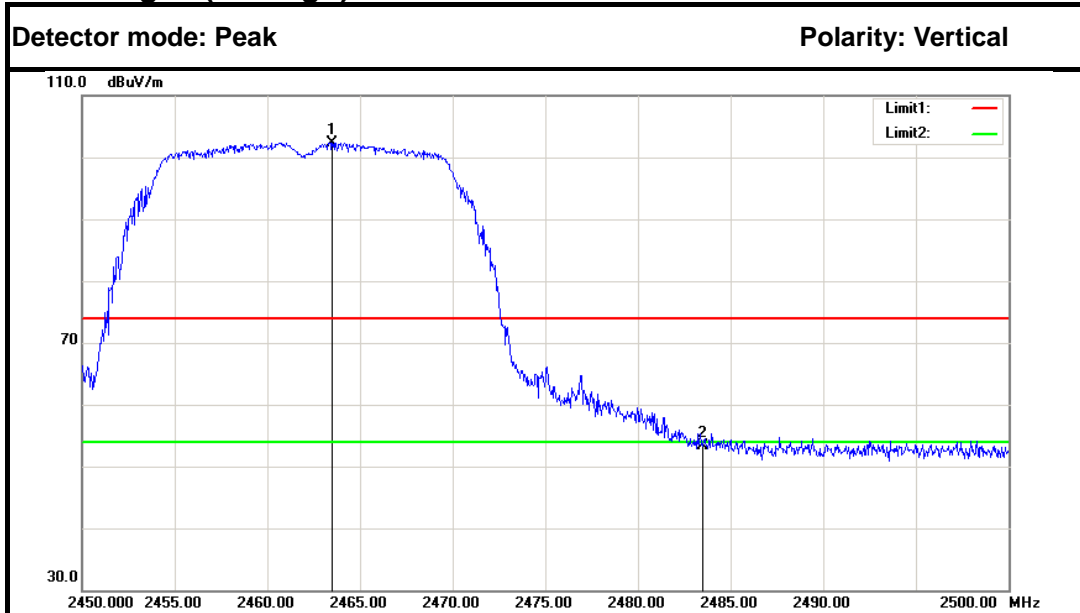

No.	Frequency (MHz)	Reading (dB)	Factor (dB/m)	Result (dB/m)	Limit (dB/m)	Margin (dB)	Remark	Antenna Polar
1.	2463.500	104.84	-2.46	102.38	---	---	Peak	Vertical
2.	2483.500	55.57	-2.35	53.22	74.00	-20.78	Peak	Vertical
1.	2460.550	95.20	-2.48	92.72	---	---	Average	Vertical
2.	2483.500	45.57	-2.35	43.22	54.00	-10.78	Average	Vertical

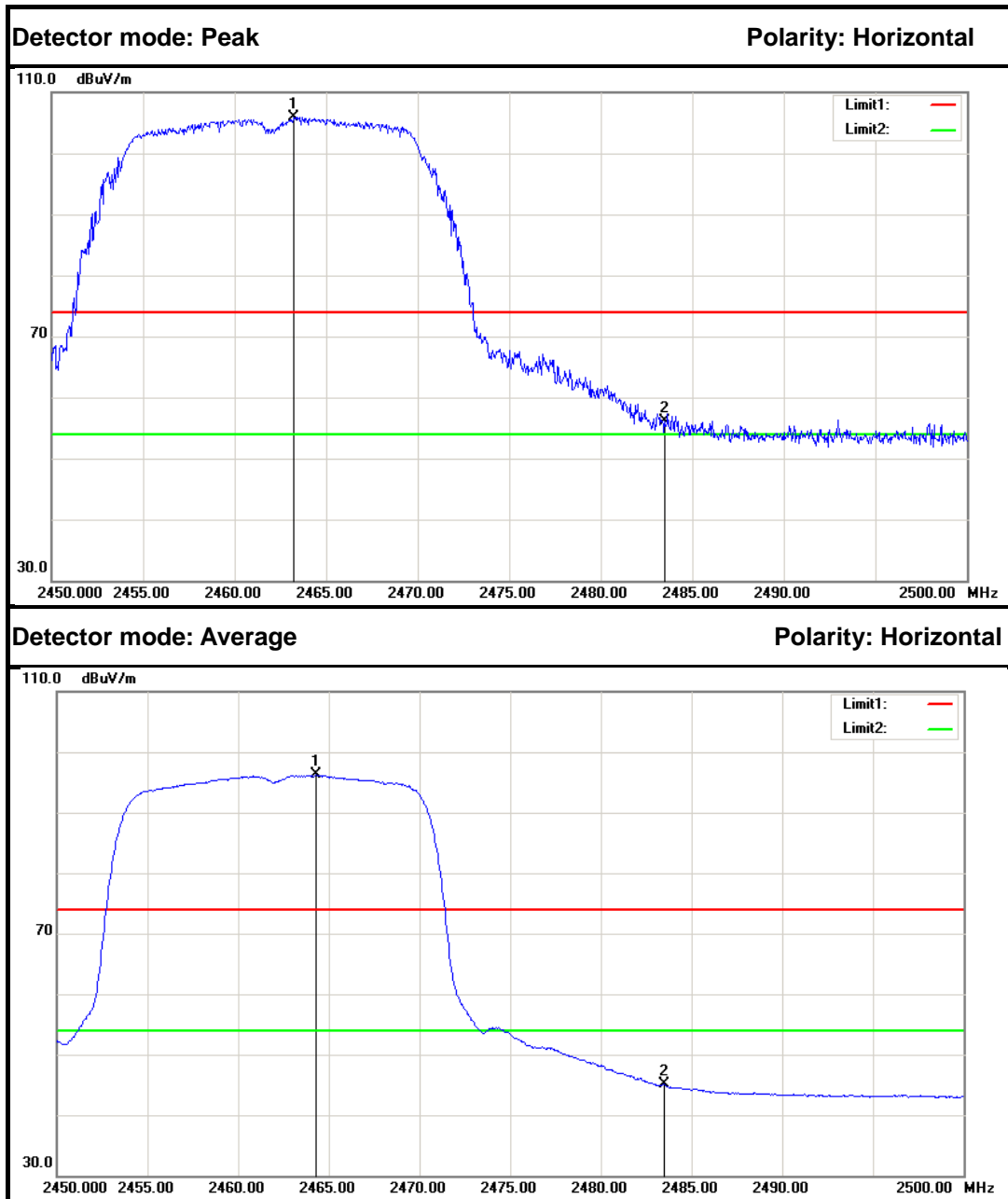

No.	Frequency (MHz)	Reading (dB)	Factor (dB/m)	Result (dB/m)	Limit (dB/m)	Margin (dB)	Remark	Antenna Polar
1.	2463.250	108.36	-2.46	105.90	---	---	Peak	Horizontal
2.	2483.500	58.48	-2.35	56.13	74.00	-17.87	Peak	Horizontal
1.	2464.300	98.68	-2.46	96.22	---	---	Average	Horizontal
2.	2483.500	47.43	-2.35	45.08	54.00	-8.92	Average	Horizontal



IEEE 802.11n HT20 MHz mode
Band Edges (CH Low)

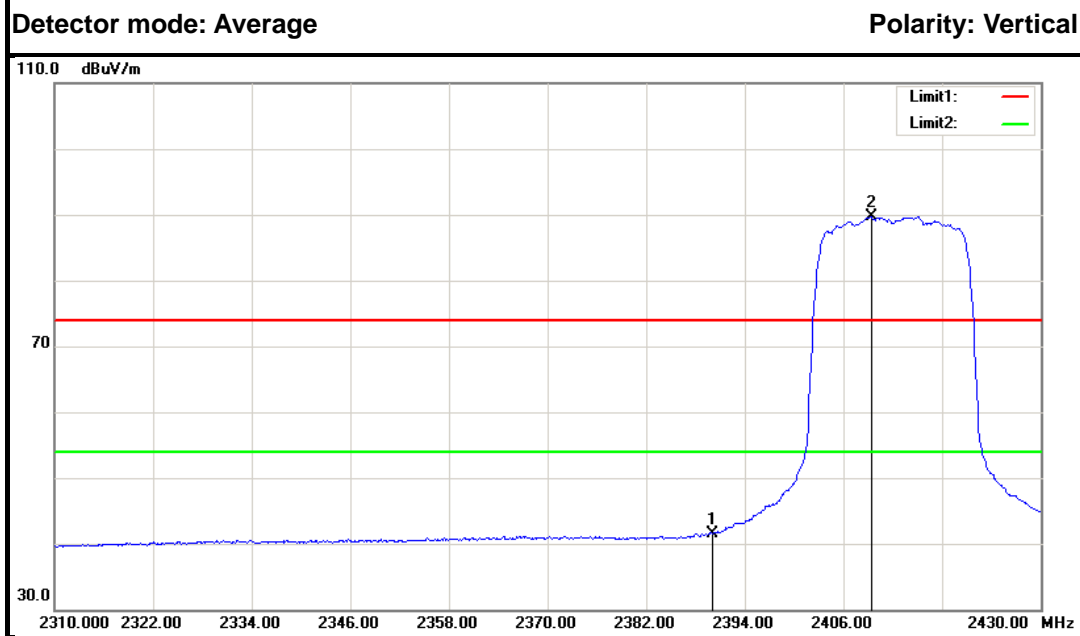
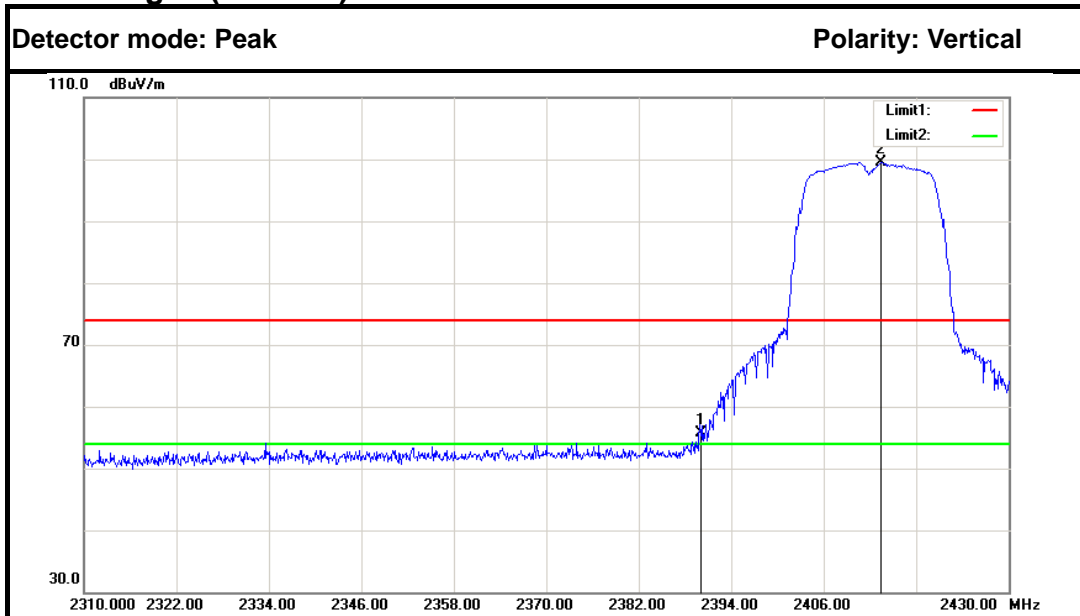

No.	Frequency (MHz)	Reading (dB)	Factor (dB/m)	Result (dB/m)	Limit (dB/m)	Margin (dB)	Remark	Antenna Polar
1.	2390.000	58.49	-2.86	55.63	74.00	-18.37	Peak	Vertical
2.	2413.440	102.17	-2.73	99.44	---	---	Peak	Vertical
1.	2390.000	44.42	-2.86	41.56	54.00	-12.44	Average	Vertical
2.	2409.360	92.49	-2.76	89.73	---	---	Average	Vertical

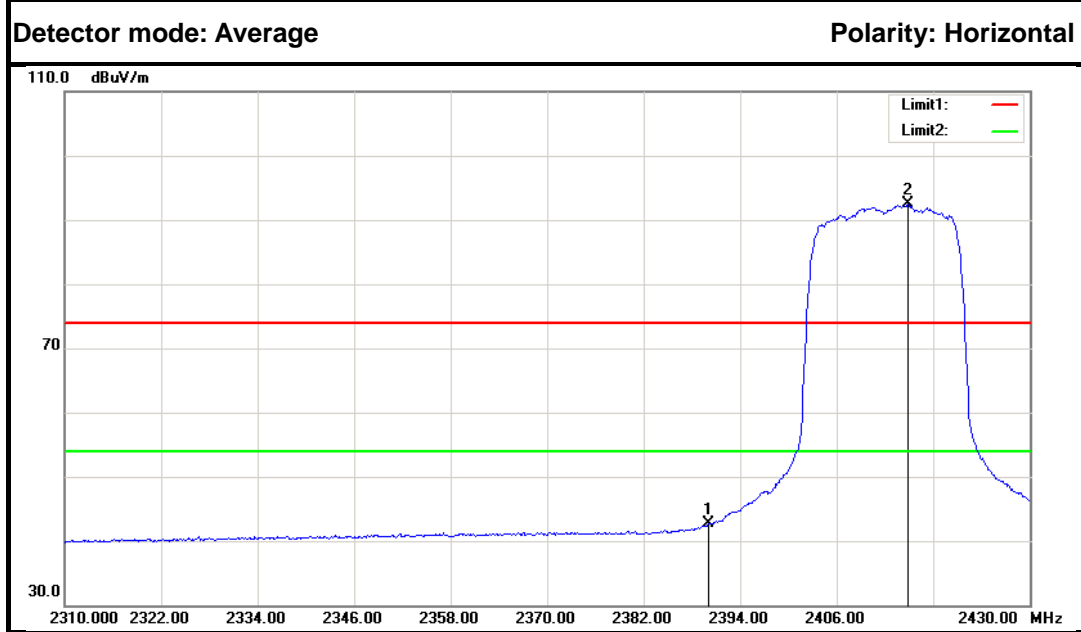
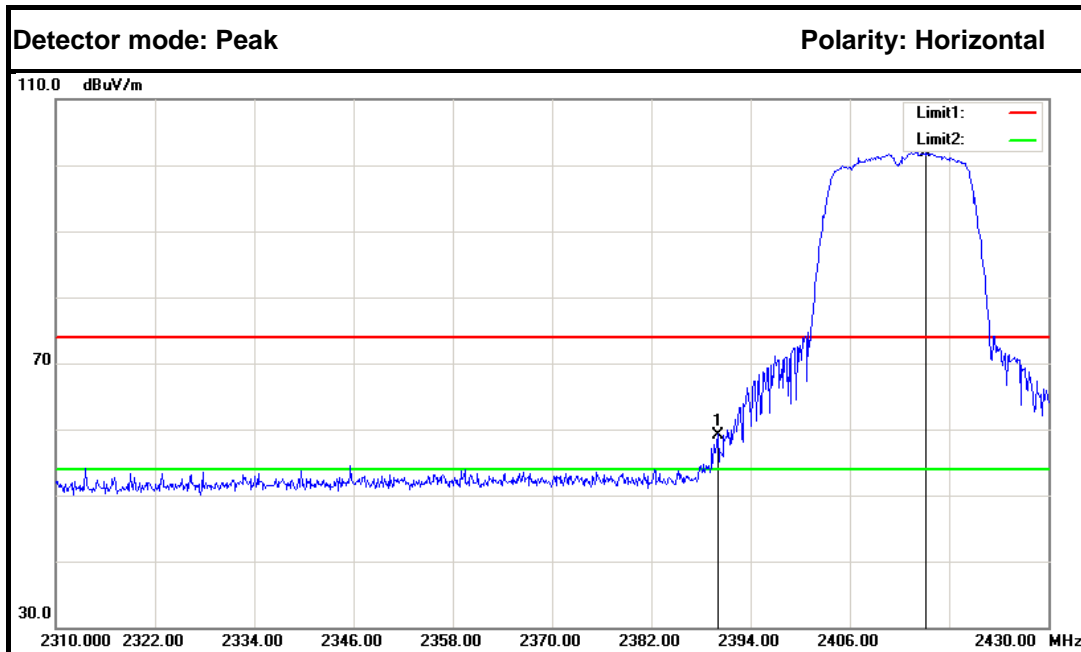

No.	Frequency (MHz)	Reading (dB)	Factor (dB/m)	Result (dB/m)	Limit (dB/m)	Margin (dB)	Remark	Antenna Polar
1.	2390.000	62.06	-2.86	59.20	74.00	-14.80	Peak	Horizontal
2.	2415.120	104.59	-2.73	101.86	---	---	Peak	Horizontal
1.	2390.000	45.46	-2.86	42.60	54.00	-11.40	Average	Horizontal
2.	2414.880	95.26	-2.73	92.53	---	---	Average	Horizontal



Band Edges (CH High)

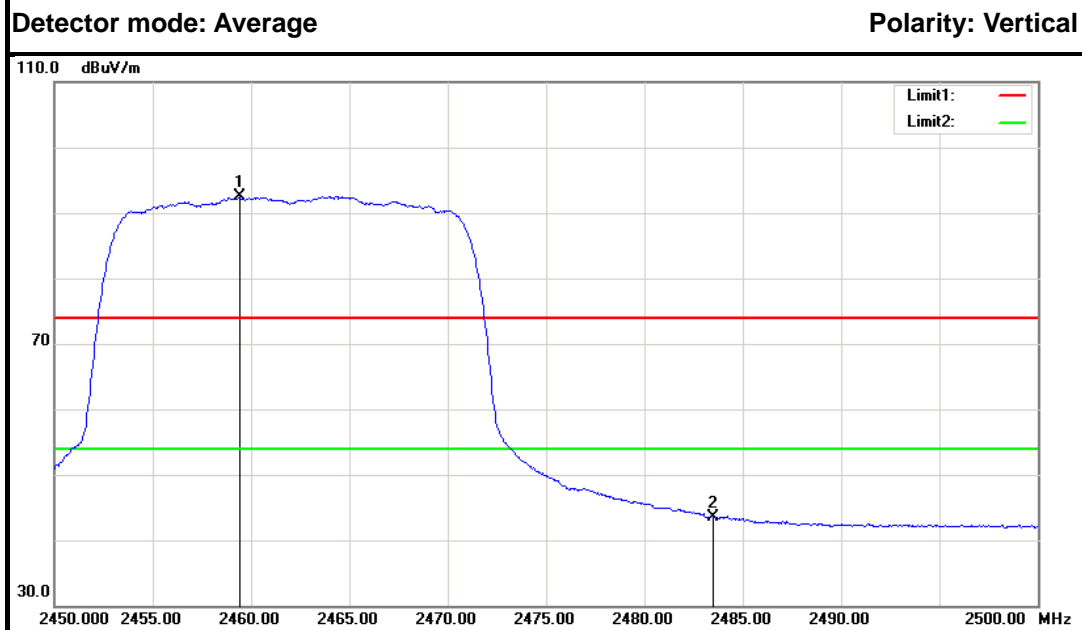
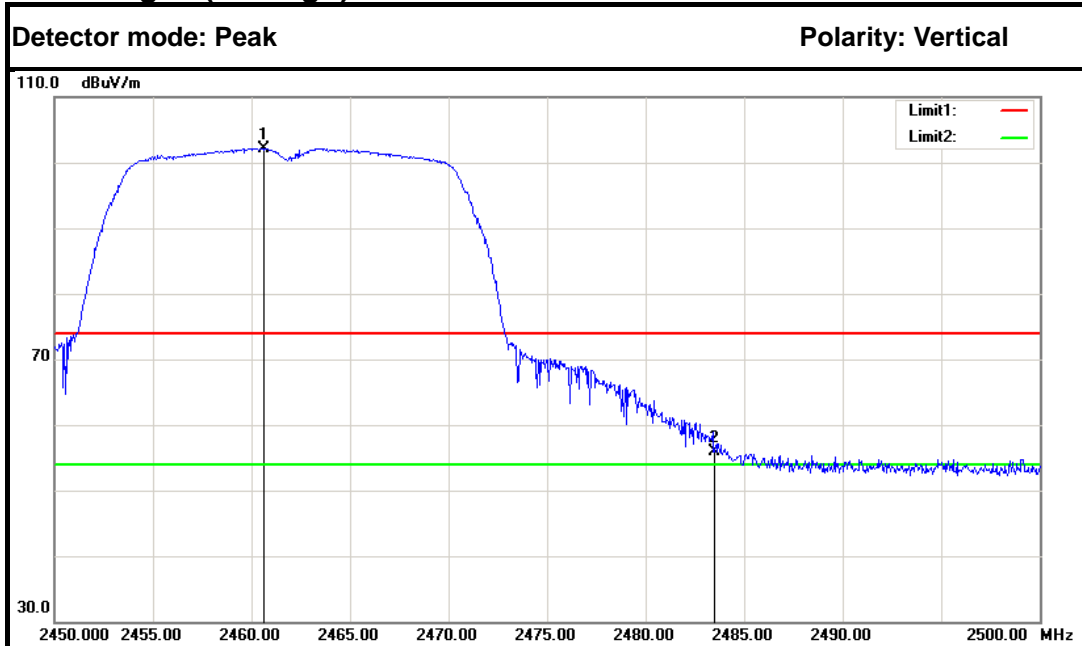

No.	Frequency (MHz)	Reading (dB)	Factor (dB/m)	Result (dB/m)	Limit (dB/m)	Margin (dB)	Remark	Antenna Polar
1.	2460.600	104.66	-2.48	102.18	---	---	Peak	Vertical
2.	2483.500	58.32	-2.35	55.97	74.00	-18.03	Peak	Vertical
1.	2459.400	94.90	-2.48	92.42	---	---	Average	Vertical
2.	2483.500	45.91	-2.35	43.56	54.00	-10.44	Average	Vertical

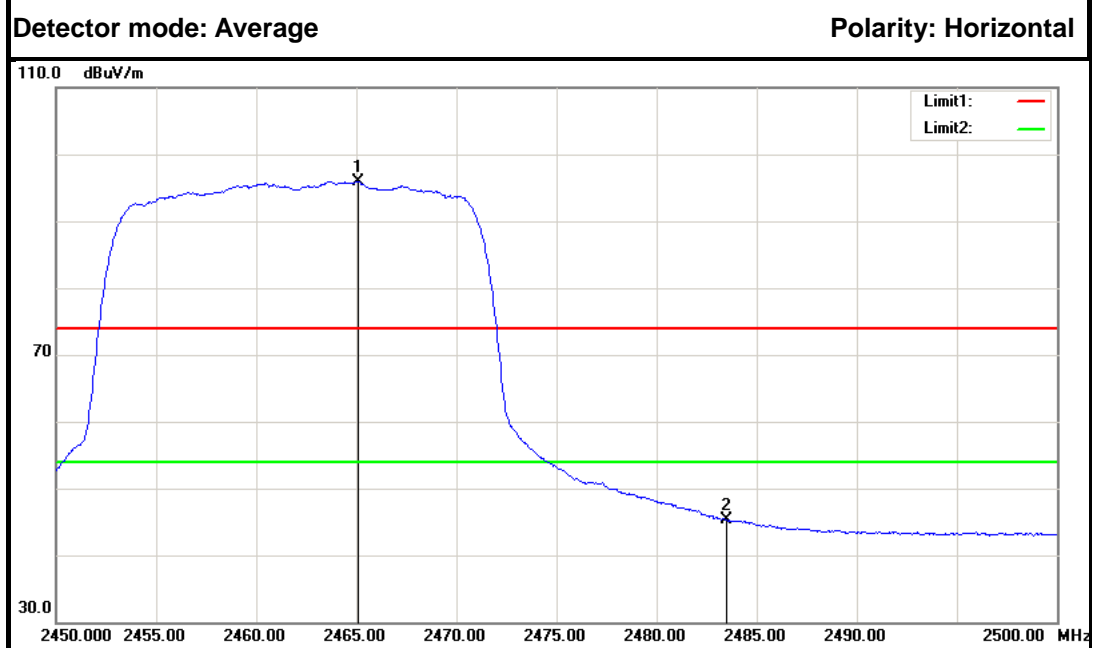
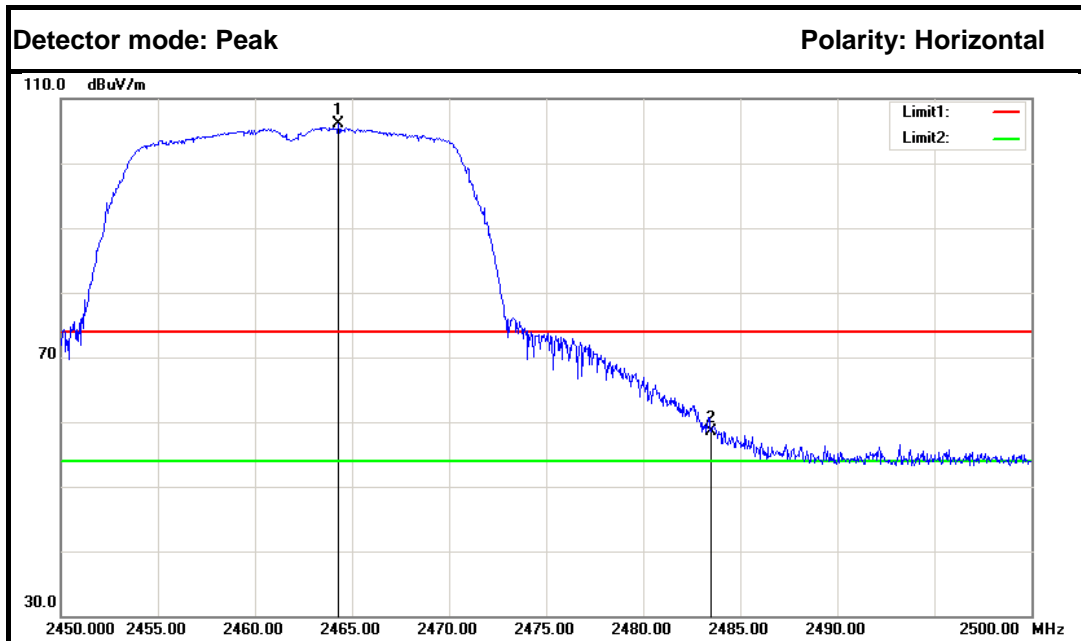

No.	Frequency (MHz)	Reading (dB)	Factor (dB/m)	Result (dB/m)	Limit (dB/m)	Margin (dB)	Remark	Antenna Polar
1.	2464.300	108.58	-2.46	106.12	---	---	Peak	Horizontal
2.	2483.500	60.88	-2.35	58.53	74.00	-15.47	Peak	Horizontal
1.	2465.100	98.39	-2.45	95.94	---	---	Average	Horizontal
2.	2483.500	47.61	-2.35	45.26	54.00	-8.74	Average	Horizontal



IEEE 802.11n HT40 MHz mode
Band Edges (CH Low)

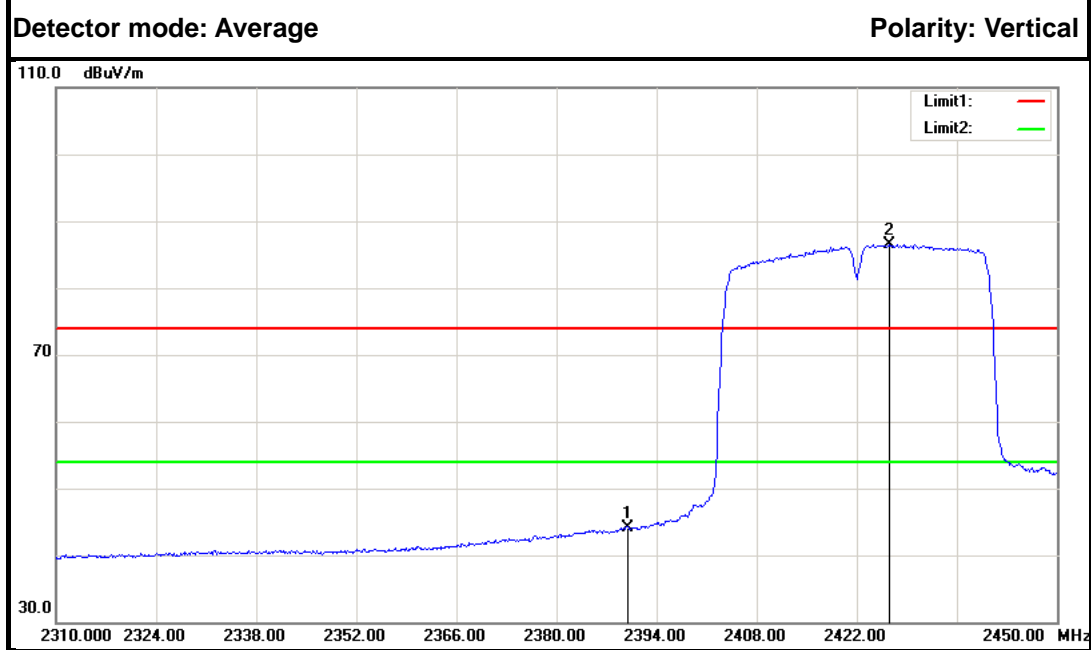
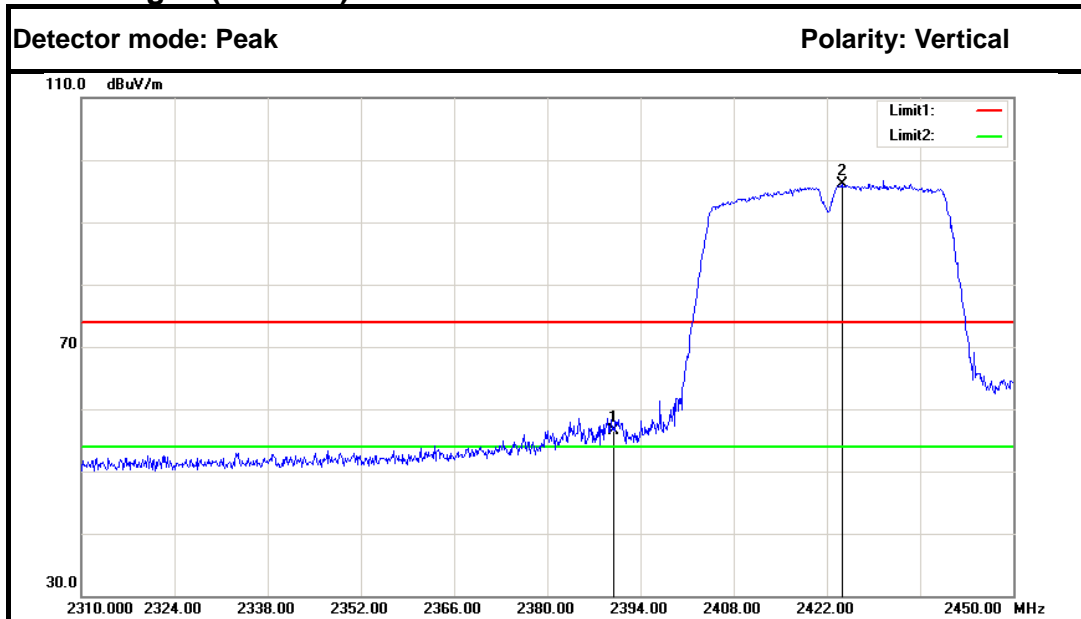

No.	Frequency (MHz)	Reading (dB)	Factor (dB/m)	Result (dB/m)	Limit (dB/m)	Margin (dB)	Remark	Antenna Polar
1.	2390.000	59.46	-2.86	56.60	74.00	-17.40	Peak	Vertical
2.	2424.240	98.72	-2.68	96.04	---	---	Peak	Vertical
1.	2390.000	46.91	-2.86	44.05	54.00	-9.95	Average	Vertical
2.	2426.480	89.21	-2.66	86.55	---	---	Average	Vertical

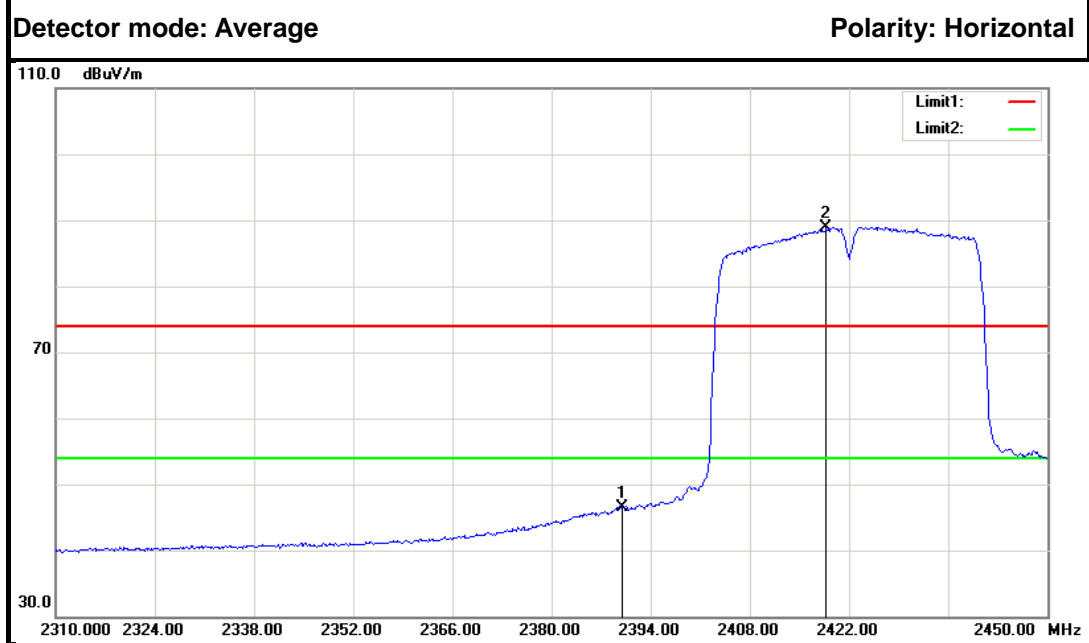
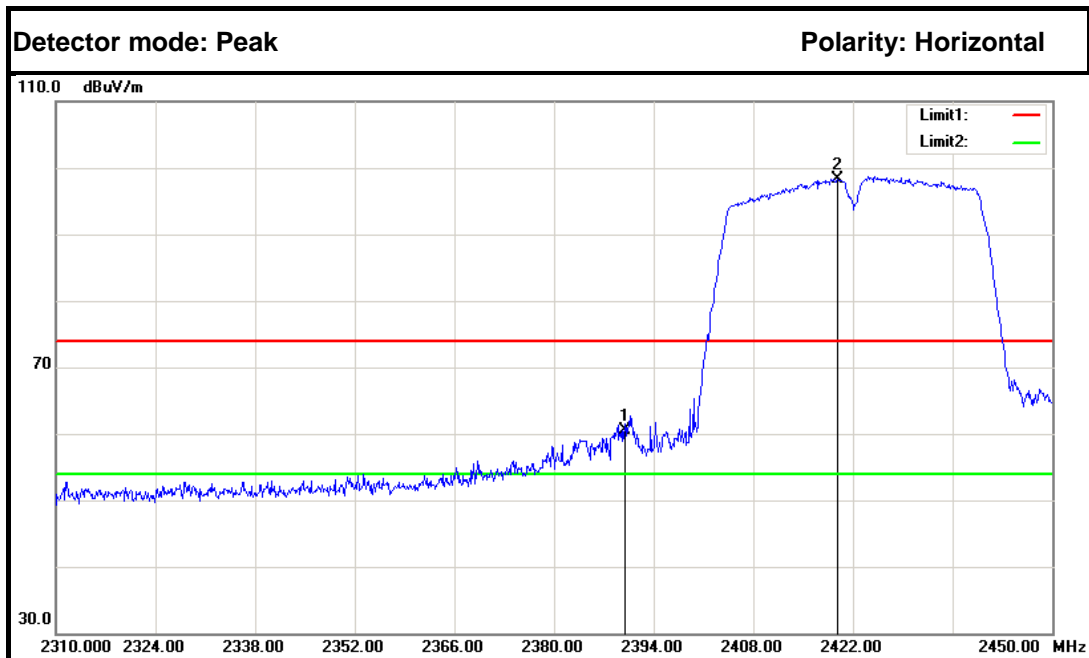

No.	Frequency (MHz)	Reading (dB)	Factor (dB/m)	Result (dB/m)	Limit (dB/m)	Margin (dB)	Remark	Antenna Polar
1	2390.000	63.34	-2.86	60.48	74.00	-13.52	Peak	Horizontal
2	2419.760	101.09	-2.70	98.39	---	---	Peak	Horizontal
1	2390.000	49.29	-2.86	46.43	54.00	-7.57	Peak	Horizontal
2	2418.780	91.64	-2.71	88.93	---	---	Average	Horizontal



Band Edges (CH High)

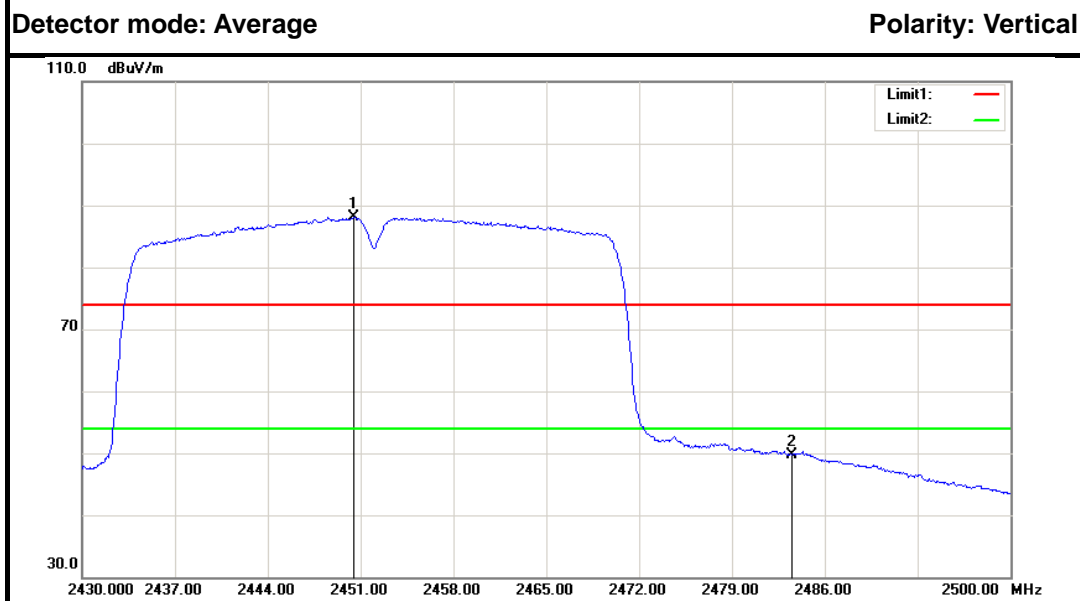
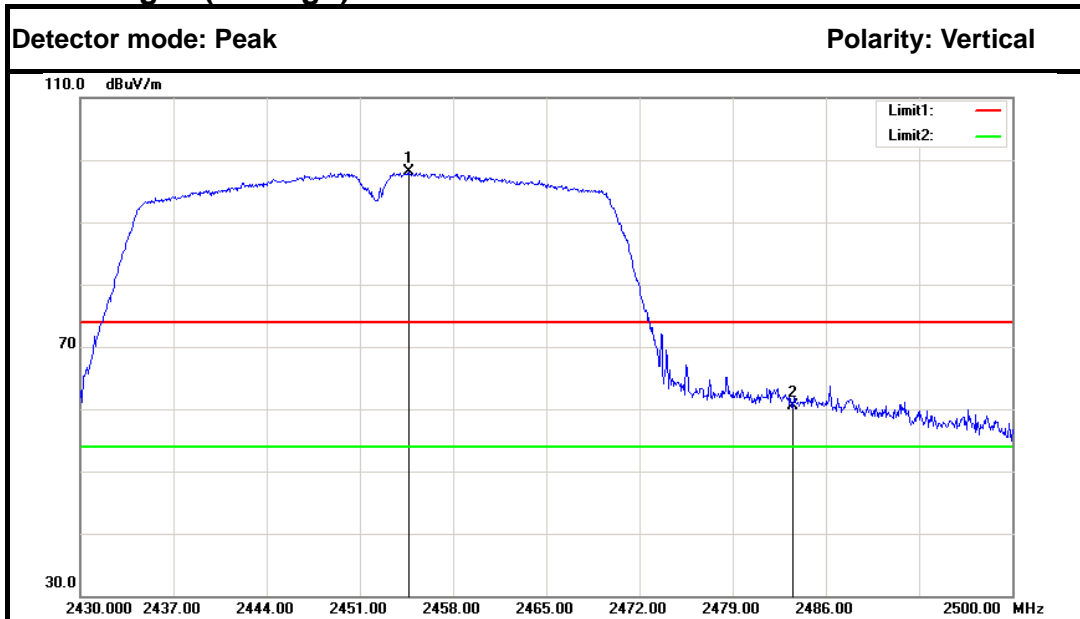

No.	Frequency (MHz)	Reading (dB)	Factor (dB/m)	Result (dB/m)	Limit (dB/m)	Margin (dB)	Remark	Antenna Polar
1.	2454.640	100.68	-2.51	98.17	---	---	Peak	Vertical
2.	2483.500	62.81	-2.35	60.46	74.00	-13.54	Peak	Vertical
1.	2450.510	90.61	-2.53	88.08	---	---	Average	Vertical
2.	2483.500	52.07	-2.35	49.72	54.00	-4.28	Average	Vertical

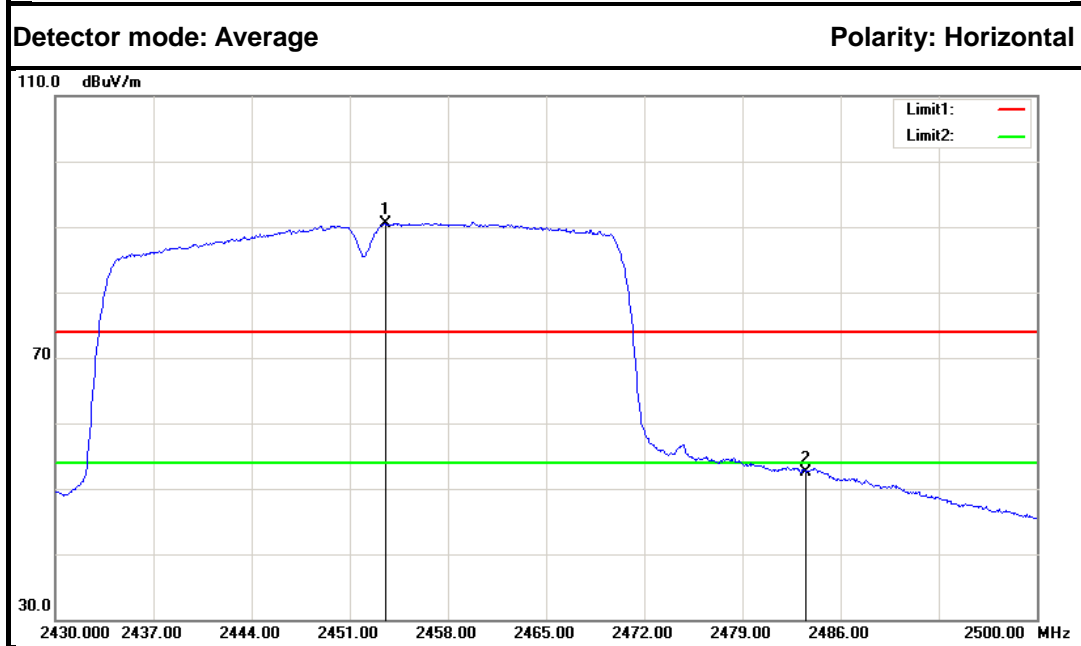
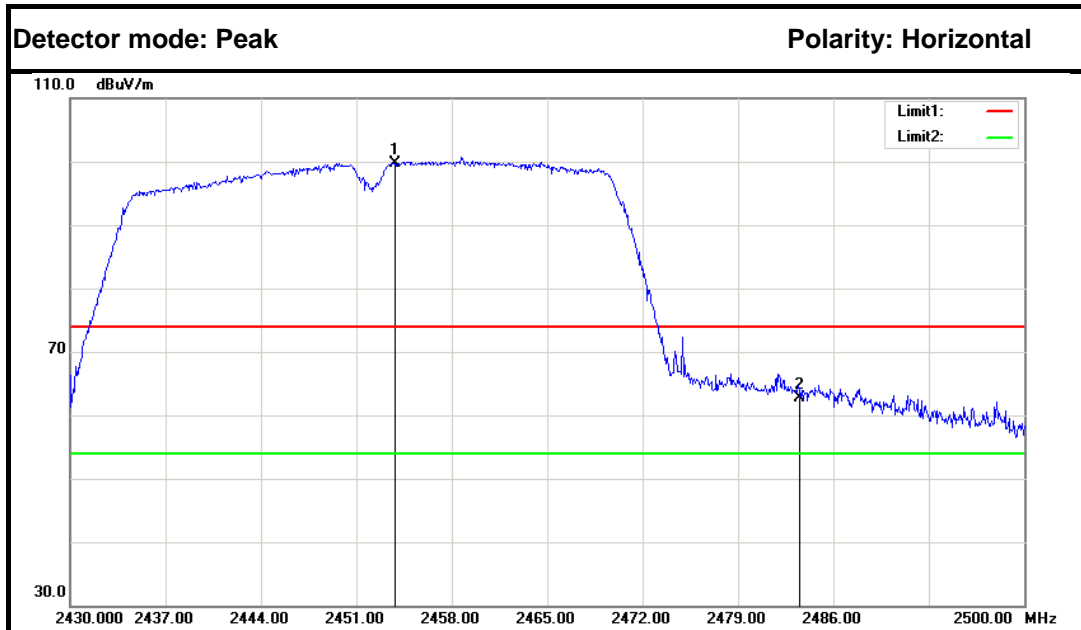

No.	Frequency (MHz)	Reading (dB)	Factor (dB/m)	Result (dB/m)	Limit (dB/m)	Margin (dB)	Remark	Antenna Polar
1.	2453.800	102.28	-2.51	99.77	---	---	Peak	Horizontal
2.	2483.500	65.10	-2.35	62.75	74.00	-11.25	Peak	Horizontal
1.	2453.520	93.06	-2.51	90.55	---	---	Average	Horizontal
2.	2483.500	54.88	-2.35	52.53	54.00	-1.47	Average	Horizontal



7.7. PEAK POWER SPECTRAL DENSITY MEASUREMENT

7.7.1. LIMITS

According to §15.247(e), for digitally modulated systems, the power spectral density conducted from the intentional radiator to the antenna shall not be greater than 8 dBm in any 3 kHz band during any time interval of continuous transmission.

According to §15.247(f), the digital modulation operation of the hybrid system, with the frequency hopping turned off, shall comply with the power density requirements of paragraph (d) of this section.

7.7.2. TEST INSTRUMENTS

Name of Equipment	Manufacturer	Model	Serial Number	Last Calibration	Calibration Due
Spectrum Analyzer	Agilent	N9010A	MY52221469	01/27/2018	01/26/2019

7.7.3. TEST PROCEDURES (please refer to measurement standard)

§15.247(e) specifies a conducted power spectral density (PSD) limit of 8 dBm in any 3 kHz band segment within the fundamental EBW during any time interval of continuous transmission. The same method as used to determine the conducted output power shall be used to determine the power spectral density (i.e., if peak-detected fundamental power was measured then use the peak PSD procedure and if average fundamental power was measured then use the average PSD procedure).

10.2 Method PKPSD (peak PSD)

1. Set analyzer center frequency to DTS channel center frequency.
2. Set the span to 1.5 times the DTS bandwidth.
3. Set the RBW to: $3 \text{ kHz} \leq \text{RBW} \leq 100 \text{ kHz}$.
4. Set the VBW $\geq 3 \times \text{RBW}$.
5. Detector = peak.
6. Sweep time = auto couple.
7. Trace mode = max hold.
8. Allow trace to fully stabilize.
9. Use the peak marker function to determine the maximum amplitude level within the RBW.
10. If measured value exceeds limit, reduce RBW (no less than 3 kHz) and repeat.

7.7.4. TEST SETUP

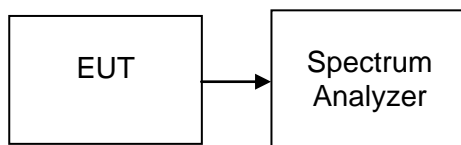



7.7.5. TEST RESULTS

No non-compliance noted

Test Data

Test mode: IEEE 802.11b

Channel	Frequency (MHz)	PPSD (dBm)	Limit (dBm)	Test Result
Low	2412	-9.944	8	PASS
Mid	2437	-10.591		PASS
High	2462	-9.891		PASS

Test mode: IEEE 802.11g

Channel	Frequency (MHz)	PPSD (dBm)	Limit (dBm)	Test Result
Low	2412	-11.843	8	PASS
Mid	2437	-10.720		PASS
High	2462	-10.660		PASS

Test mode: IEEE 802.11n HT20 MHz

Channel	Frequency (MHz)	PPSD (dBm)	Limit (dBm)	Test Result
Low	2412	-11.583	8	PASS
Mid	2437	-13.394		PASS
High	2462	-12.250		PASS

Test mode: IEEE 802.11n HT40 MHz

Channel	Frequency (MHz)	PPSD (dBm)	Limit (dBm)	Test Result
Low	2422	-14.334	8	PASS
Mid	2437	-15.314		PASS
High	2452	-15.618		PASS



Test Plot

IEEE 802.11b mode

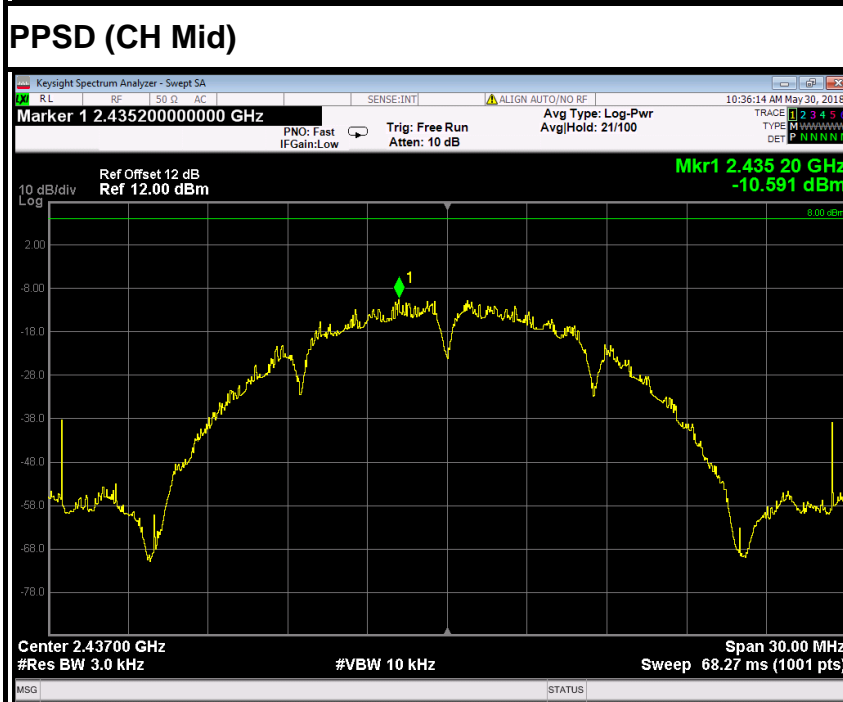
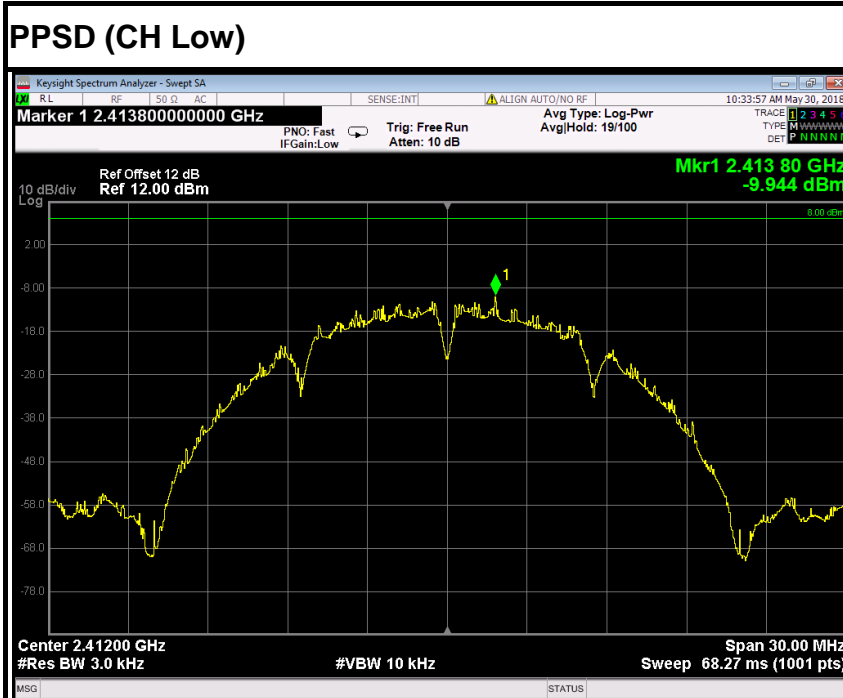

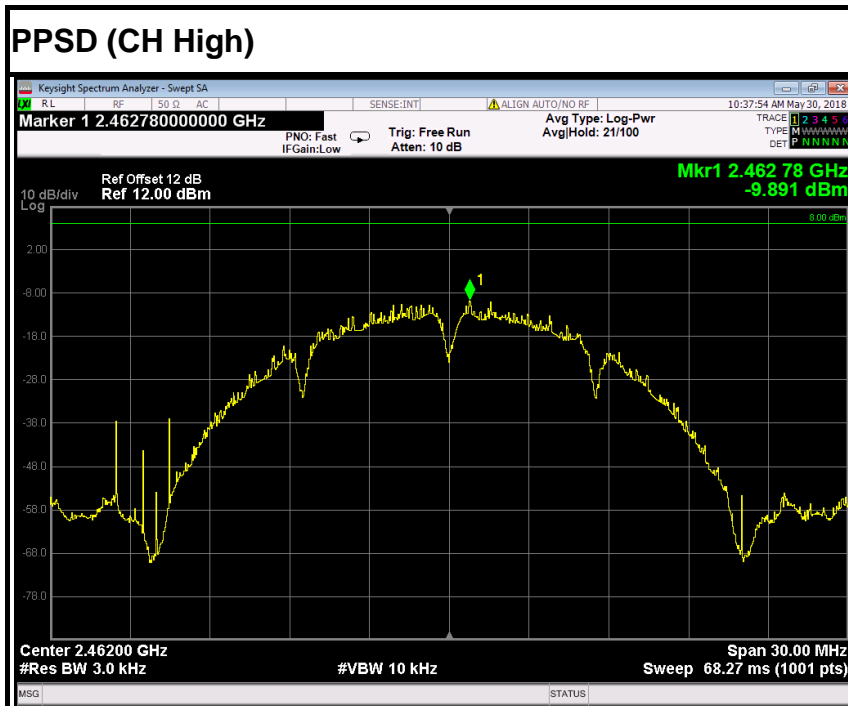

IEEE 802.11g mode

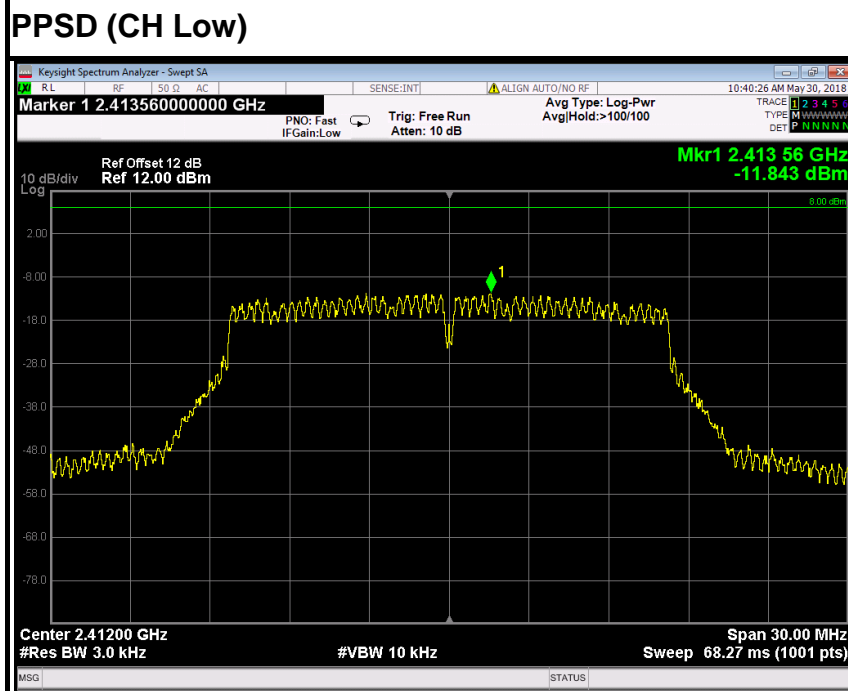

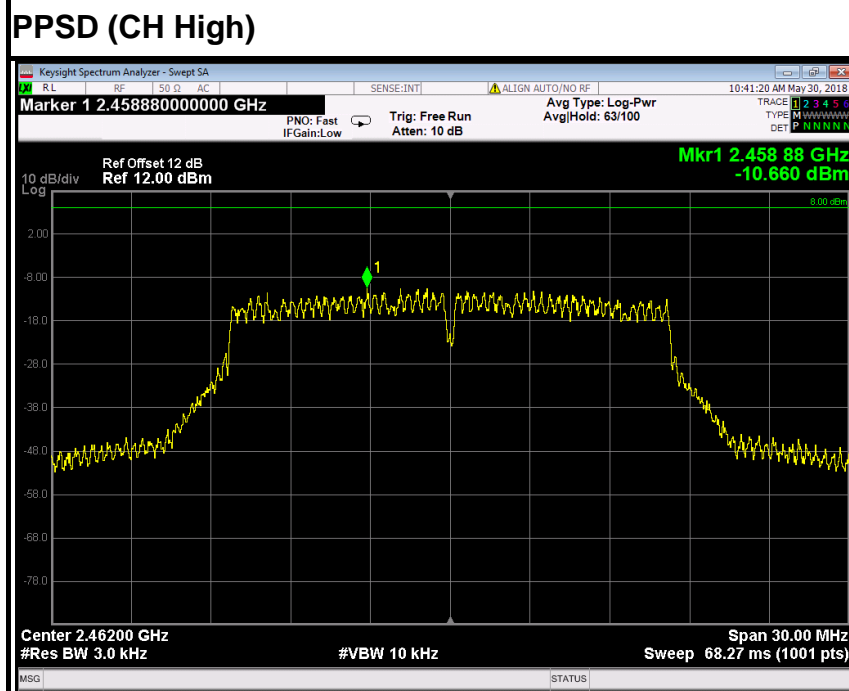
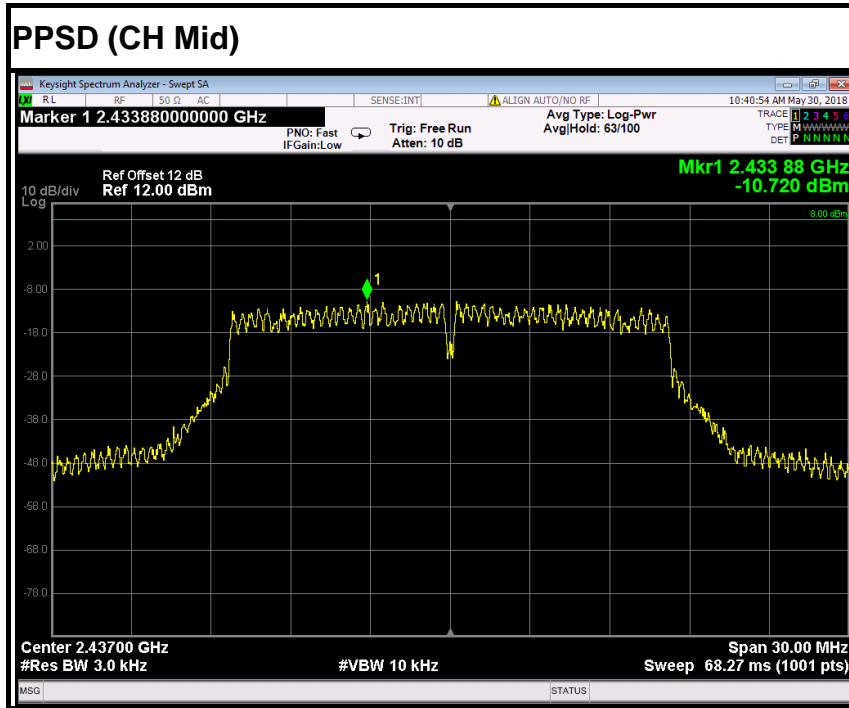



IEEE 802.11n HT20 MHz mode

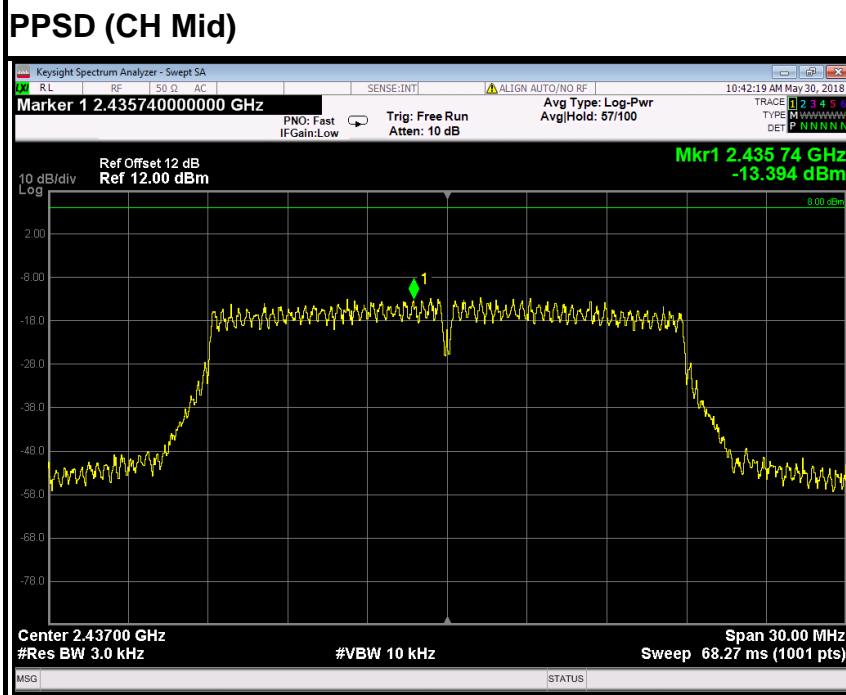
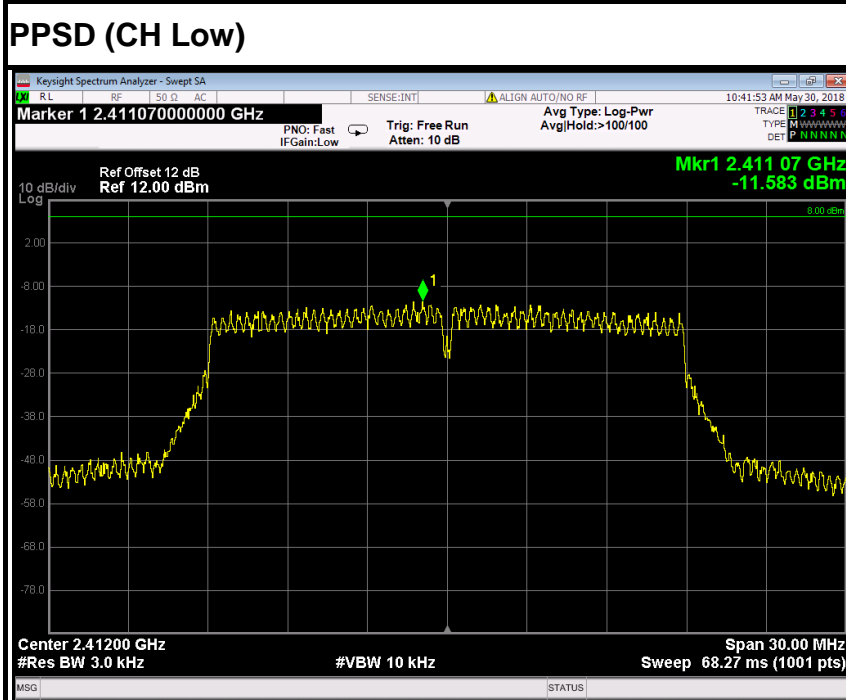

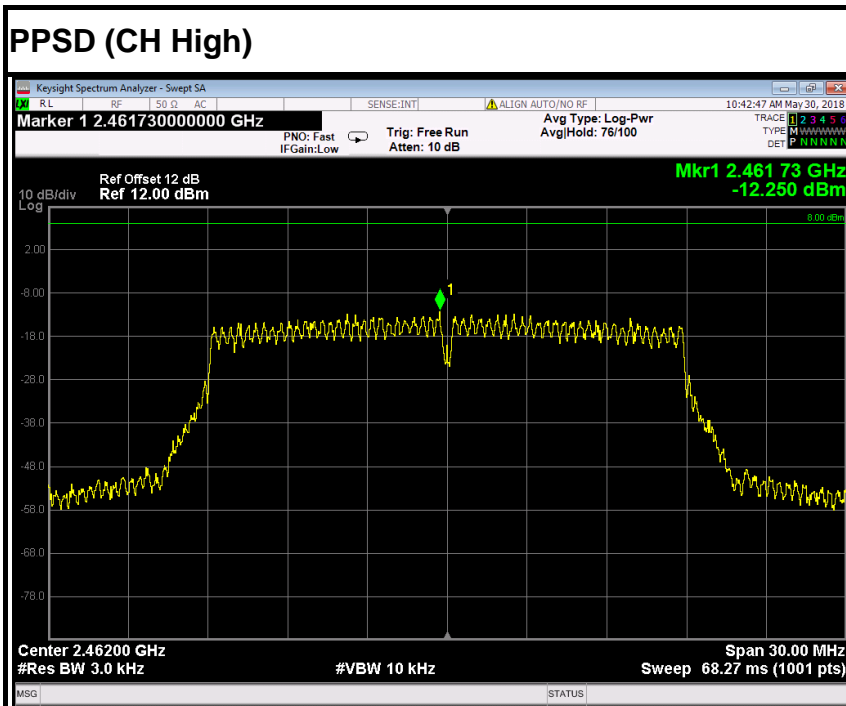

IEEE 802.11n HT40 MHz mode

