



FCC 47 CFR PART 15 SUBPART C

TEST REPORT

For

Tablet Computer

Model: A8003

Marketing Name: B3-A50XXX(X=A-Z, a-z, 0-9 or black)

Brand: acer

Test Report Number:

C180521Z03-RP1-1

Issued for

Acer Incorporated

8F, 88, Sec 1, Xintai 5th Rd. Xizhi, New Taipei City 221 Taiwan, R.O.C

Issued by:

COMPLIANCE CERTIFICATION SERVICES (SHENZHEN) INC.

No.10-1, Mingkeda Logistics Park, No.18, Huanguan South Rd.,
Guan Lan Town, Baoan District, Shenzhen China

TEL: 86-755-28055000

FAX: 86-755-28055221

E-Mail: service@ccssz.com

Issued Date: June 25, 2018



Certificate Number: 2861.01

Note: This report shall not be reproduced except in full, without the written approval of Compliance Certification Services (Shenzhen) Inc. This document may be altered or revised by Compliance Certification Services (Shenzhen) Inc. personnel only, and shall be noted in the revision section of the document. The client should not use it to claim product endorsement by TAF, A2LA, NVLAP, NIST, CNAS or any government agencies. The test result of this report relate only to the tested sample identified in this report.



Revision History

Rev.	Issue Date	Revisions	Effect Page	Revised By
00	June 25, 2018	Initial Issue	ALL	Sinphy Xie



TABLE OF CONTENTS

1. TEST RESULT CERTIFICATION	4
2. TEST RESULT SUMMARY	5
3. EUT DESCRIPTION	6
4. TEST METHODOLOGY	8
4.1 DESCRIPTION OF TEST MODES	8
5. FACILITIES AND ACCREDITATIONS	10
5.1 FACILITIES	10
5.2 ACCREDITATIONS	10
5.3 MEASUREMENT UNCERTAINTY	10
6. SETUP OF EQUIPMENT UNDER TEST	11
6.1 SETUP CONFIGURATION OF EUT	11
6.2 SUPPORT EQUIPMENT	11
7. FCC PART 15.247 REQUIREMENTS	12
7.1 20DB BANDWIDTH	12
7.2 ANTENNA GAIN	16
7.3 PEAK POWER.....	17
7.4 PEAK POWER SPECTRAL DENSITY	19
7.5 BAND EDGES MEASUREMENT	20
7.6 FREQUENCY SEPARATION	30
7.7 NUMBER OF HOPPING FREQUENCY	33
7.8 TIME OF OCCUPANCY (DWELL TIME)	35
7.9 SPURIOUS EMISSIONS	42
7.10 POWERLINE CONDUCTED EMISSIONS	65



1. TEST RESULT CERTIFICATION

Product	Tablet Computer
Model	A8003
Marketing Name	B3-A50XXX(X=A-Z, a-z, 0-9 or black)
Brand	acer
Tested	May 21~ June 25, 2018
Applicant	Acer Incorporated 8F, 88, Sec 1, Xintai 5th Rd. Xizhi, New Taipei City 221 Taiwan, R.O.C
Manufacturer	Acer Incorporated 8F, 88, Sec 1, Xintai 5th Rd. Xizhi, New Taipei City 221 Taiwan, R.O.C

APPLICABLE STANDARDS	
STANDARD	TEST RESULT
FCC 47 CFR Part 15 Subpart C	No non-compliance noted

We hereby certify that:

The above equipment was tested by Compliance Certification Services (Shenzhen) Inc. The test data, data evaluation, test procedures, and equipment configurations shown in this report were made in accordance with the procedures given in **ANSI C63.10: 2013** and the energy emitted by the sample EUT tested as described in this report is in compliance with the requirements of FCC Rules Part 15.207, 15.209, 15.247.

The test results of this report relate only to the tested sample EUT identified in this report.

Approved by:

Eve Wang
Supervisor of EMC Dept.
Compliance Certification Services (Shenzhen) Inc.

Reviewed by:

Nancy Fu
Supervisor of Report Dept.
Compliance Certification Services (Shenzhen) Inc.



2. TEST RESULT SUMMARY

APPLICABLE STANDARDS			
Standard	Test Type	Result	Remark
15.247(a)(1)	20dB Bandwidth Measurement	Pass	Meet the requirement of limit.
15.247(b)(3) 15.247(b)(4)	Peak Power Measurement	Pass	Meet the requirement of limit.
15.247(a)(1)	Frequency Separation	Pass	Meet the requirement of limit.
15.247(a)(1)(ii)	Number Of Hopping Frequency	Pass	Meet the requirement of limit.
15.247(a)(1)(iii)	Time Of Occupancy (Dwell Time)	Pass	Meet the requirement of limit.
15.247(d)	Band Edges Measurement	Pass	Meet the requirement of limit.
15.247(d)	<ul style="list-style-type: none">● Spurious Emissions● Conducted Measurement● Radiated Emissions	Pass	Meet the requirement of limit.
15.207(a)	Power line Conducted Emissions	Pass	Meet the requirement of limit.

Note:

1. The statements of test result on the above are decided by the request of test standard only; the measurement uncertainties are not factored into this compliance determination.
2. The information of measurement uncertainty is available upon the customer's request.



3. EUT DESCRIPTION

Product	Tablet Computer
Model Number	A8003
Marketing Name	B3-A50XXX(X=A-Z, a-z, 0-9 or black)
Brand	acer
Model Discrepancy	N/A
Identify Number	C180521Z03-RP1-1
Received Date	May 21, 2018
Power Supply	DC5.35V or DC5.2V supplied by the adapter or DC3.7V supplied by the battery
Adapter Specification	Adapter 1: DELTA ELECTRONICS, INC. MODEL: ADP-10HW A INPUT: 100-240Vac 0.4A 50/60Hz OUTPUT: 5.35Vdc 2A Adapter 2: LITE-ON TECHNOLOGY (CHANGZHOU)CO., LTD. MODEL: PA-1100-25 INPUT: 100-240Vac 0.3A 50/60Hz OUTPUT: 5.2Vdc 2.0A
Rechargeable Li-ion Polymer Battery Pack Specification	Battery 1: TCL Hyperpower Batteries Inc. Model: PR-279594N(1ICP3/95/94-2) Rating: 3.7V Charge Limited Voltage: 4.2V Rated Capacity: 6000mAh Rated Power: 22.2Wh Battery 2: Huizhou Highpower Technology Co.,LTD Model: HPP279594AB(1ICP3/95/94-2) Rating: 3.7V Charge Limited Voltage: 4.2V Rated Capacity/ Rated Power: Nominal 6100mAh/22.57Wh Minimum 6000mAh/22.20Wh
USB-Micro USB cable	Cable 1: Baisitai Unshielded, 0.80m Cable 2: Haoxin Unshielded, 0.80m
Frequency Range	2402 ~ 2480 MHz



Transmit Power	GFSK: 4.13dBm $\pi/4$ -DQPSK: 3.89dBm 8DPSK: 4.00dBm
Modulation Technique	FHSS (GFSK for 1Mbps, $\pi/4$ -DQPSK for 2Mbps, 8DPSK for 3Mbps)
Number of Channels	79 Channels
Antenna Specification	FPC antenna with 1.59dBi gain (Max)
Temperature Range	0°C ~ +35°C
Hardware Version	A10L3_MB_V1.2
Software Version	Acer_AV000_B3-A50_RV00RB00_WW_GEN1

Note: This submittal(s) (test report) is intended for FCC ID: HLZA8003 filing to comply with Section 15.207, 15.209 and 15.247 of the FCC Part 15, Subpart C Rules.



4. TEST METHODOLOGY

4.1 DESCRIPTION OF TEST MODES

The EUT has been tested under operating condition.

Use “EngineerMode” to control the EUT for staying in continuous transmitting and receiving mode.

Test Item	Test mode	Worse mode
All test modes are tested in the following test environments [WiFi worst(2.4G/5G) Link +BT Link +GPS/Glonass Link]		
Conducted Emission	Mode 1: Charge(Adapter 1+Cable 1+Battery 1)+Play Video (USB2.0)(AC120V/60Hz)	<input type="checkbox"/>
	Mode 2: Charge(Adapter 1+Cable 2+Battery 1)+Play Video (USB2.0) (AC120V/60Hz)	<input type="checkbox"/>
	Mode 3: Charge(Adapter 2+Cable 1+Battery 1)+Play Video(USB2.0)(AC120V/60Hz)	<input type="checkbox"/>
	Mode 4: Charge(Adapter 2+Cable 2+Battery 1)+Play Video(USB2.0)(AC120V/60Hz)	<input checked="" type="checkbox"/>
	Mode 5: Charge(Adapter 1+Cable 1+Battery 1)+ Record Video(TF Card) (AC120V/60Hz)	<input type="checkbox"/>
	Mode 6: Charge(Adapter 1+Cable 2+Battery 1)+ Record Video(TF Card) (AC120V/60Hz)	<input type="checkbox"/>
	Mode 7: Charge(Adapter 2+Cable 1+Battery 1)+Record Video (TF Card) (AC120V/60Hz)	<input type="checkbox"/>
	Mode 8: Charge(Adapter 2+Cable 2+Battery 1)+Record Video (TF Card) (AC120V/60Hz)	<input type="checkbox"/>
	Mode 9: Charge(Adapter 1+Cable 1+Battery 2)+Play Video(USB2.0) (AC120V/60Hz)	<input type="checkbox"/>
	Mode 10: Charge(Adapter 1+Cable 2+Battery 2)+Play Video(USB2.0) (AC120V/60Hz)	<input type="checkbox"/>
	Mode 11: Charge(Adapter 2+Cable 1+Battery 2)+Play Video(USB2.0)(AC120V/60Hz)	<input type="checkbox"/>
	Mode 12: Charge(Adapter 2+Cable 2+Battery 2)+Play Video(USB2.0)(AC120V/60Hz)	<input type="checkbox"/>
	Mode 13: Charge(Adapter 1+Cable 1+Battery 2)+Record Video(TF Card) (AC120V/60Hz)	<input type="checkbox"/>
	Mode 14: Charge(Adapter 1+Cable 2+Battery 2)+Record Video(TF Card) (AC120V/60Hz)	<input type="checkbox"/>
	Mode 15: Charge(Adapter 2+Cable 1+ Battery 2)+ Record Video (TF Card) (AC120V/60Hz)	<input type="checkbox"/>
	Mode 16: Charge(Adapter 2+Cable 2+ Battery 2)+ Record Video (TF Card) (AC120V/60Hz)	<input type="checkbox"/>
	Mode 17: Charge(Adapter 1+Cable 1+Battery 1)+Play Video (USB2.0)(AC240V/50Hz)	<input type="checkbox"/>
	Mode 18: Charge(Adapter 1+Cable 2+Battery 1)+Play Video (USB2.0) (AC240V/50Hz)	<input type="checkbox"/>
	Mode 19: Charge(Adapter 2+Cable 1+Battery 1)+Play Video(USB2.0)(AC240V/50Hz)	<input type="checkbox"/>
	Mode 20: Charge(Adapter 2+Cable 2+Battery 1)+Play Video(USB2.0)(AC240V/50Hz)	<input checked="" type="checkbox"/>
	Mode 21: Charge(Adapter 1+Cable 1+Battery 1)+ Record Video(TF Card)(AC240V/50Hz)	<input type="checkbox"/>
	Mode 22: Charge(Adapter 1+Cable 2+Battery 1)+ Record Video(TF Card)(AC240V/50Hz)	<input type="checkbox"/>
	Mode 23: Charge(Adapter 2+Cable 1+Battery 1)+Record Video (TF Card)(AC240V/50Hz)	<input type="checkbox"/>
	Mode 24: Charge(Adapter 2+Cable 2+Battery 1)+Record Video (TF Card)(AC240V/50Hz)	<input type="checkbox"/>
	Mode 25: Charge(Adapter 1+Cable 1+Battery 2)+Play Video(USB2.0) (AC240V/50Hz)	<input type="checkbox"/>
	Mode 26: Charge(Adapter 1+Cable 2+Battery 2)+Play Video(USB2.0) (AC240V/50Hz)	<input type="checkbox"/>



Conducted Emission	Mode 27: Charge(Adapter 2+Cable 1+Battery 2)+Play Video(USB2.0)(AC240V/50Hz)	<input type="checkbox"/>
	Mode 28: Charge(Adapter 2+Cable 2+Battery 2)+Play Video(USB2.0)(AC240V/50Hz)	<input type="checkbox"/>
	Mode 29: Charge(Adapter 1+Cable 1+Battery 2)+Record Video(TF Card)(AC240V/50Hz)	<input type="checkbox"/>
	Mode 30: Charge(Adapter 1+Cable 2+Battery 2)+Record Video(TF Card)(AC240V/50Hz)	<input type="checkbox"/>
	Mode 31: Charge(Adapter 2+Cable 1+ Battery 2)+ Record Video (TF Card)(AC240V/50Hz)	<input type="checkbox"/>
	Mode 32: Charge(Adapter 2+Cable 2+ Battery 2)+ Record Video (TF Card)(AC240V/50Hz)	<input type="checkbox"/>
Radiated Emission	Mode 1: Continuously Transmitting	<input checked="" type="checkbox"/>

Note:

1. Channel Low (2402MHz), Mid (2441MHz) and High (2480MHz) were chosen for pre-testing for GFSK, $\pi/4$ -DQPSK and 8DPSK, GFSK and 8DPSK were the worse case and print in the report.
2. Radiated band edges were tested with both fixed and hopping mode; the fixed mode was the worse case and recorded in the report.
3. For $\pi/4$ QPSK its same modulation type with 8-DPSK, and based exploratory test, there is no significant difference of that two types test result, so except output power, all other items final test were only performed with the worst case 8-DPSK and GFSK.



5. FACILITIES AND ACCREDITATIONS

5.1 FACILITIES

All measurement facilities used to collect the measurement data are located at

- No.10-1, Mingkeda Logistics Park, No.18, Huanguan South Rd., Guan Lan Town, Baoan District, Shenzhen, China**

The sites are constructed in conformance with the requirements of ANSI C63.10:2013, ANSI C63.7 and CISPR Publication 22. All receiving equipment conforms to CISPR Publication 16-1, "Radio Interference Measuring Apparatus and Measurement Methods."

5.2 ACCREDITATIONS

Our laboratories are accredited and approved by the following accreditation body according to ISO/IEC 17025.

USA	A2LA
China	CNAS

The measuring facility of laboratories has been authorized or registered by the following approval agencies.

USA	FCC
Japan	VCCI(C-4815, R-4320, T-2317, G-10624)
Canada	INDUSTRY CANADA

Copies of granted accreditation certificates are available for downloading from our web site, <http://www.ccscsz.com>

5.3 MEASUREMENT UNCERTAINTY

Where relevant, the following measurement uncertainty levels have been estimated for tests performed on the EUT as specified in CISPR 16-4-2:

Parameter	Uncertainty
Radiated Emission, 30 to 200 MHz Test Site : 966(2)	+/-3.6880dB
Radiated Emission, 200 to 1000 MHz Test Site : 966(2)	+/-3.6695dB
Radiated Emission, 1 to 8 GHz	+/-5.1782dB
Radiated Emission, 8 to 18 GHz	+/-5.2173dB
Conducted Emissions	+/-3.6836dB
Band Width	178kHz
Peak Output Power MU	+/-1.906dB
Band Edge MU	+/-0.182dB
Channel Separation MU	416.178Hz
Duty Cycle MU	0.054ms
Frequency Stability MU	226Hz

This uncertainty represents an expanded uncertainty expressed at approximately the 95% confidence level using a coverage factor of k=2.

The measured result is above (below) the specification limit by a margin less than the measurement uncertainty; it is therefore not possible to state compliance based on the 95% level of confidence. However, the result indicates that compliance (non-compliance) is more probable than non-compliance) with the specification limit.



6. SETUP OF EQUIPMENT UNDER TEST

6.1 SETUP CONFIGURATION OF EUT

See test photographs attached in Appendix 1 for the actual connections between EUT and support equipment.

6.2 SUPPORT EQUIPMENT

No.	Equipment	Model No.	Serial No.	FCC ID	Brand	Data Cable	Power Cord
1	Notebook	Thinkpad S2	SL 10K92342	N/A	Lenovo	N/A	Unshielded 1.00m (AC Cable) Unshielded 1.80m (DC Cable)
2	Earphone	G-3	N/A	N/A	GSG	Unshielded 1.20m	N/A
3	TF Card	MB-MP 16DA	N/A	N/A	SAMSUNG	N/A	N/A

Notes:

Grounding was established in accordance with the manufacturer's requirements and conditions for the intended use.



7. FCC PART 15.247 REQUIREMENTS

7.1 20DB BANDWIDTH

No limits

MEASUREMENT EQUIPMENT USED

Name of Equipment	Manufacturer	Model	Serial Number	Last Calibration	Due Calibration
Spectrum Analyzer	Agilent	N9010A	MY55370330	01/27/2018	01/26/2019

Remark: Each piece of equipment is scheduled for calibration once a year.

TEST CONFIGURATION

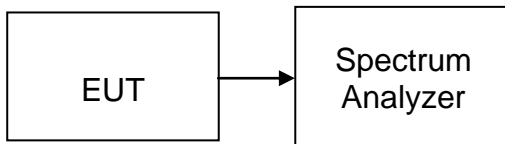

TEST PROCEDURE

1. Place the EUT on the table and set it in the transmitting mode.
2. Remove the antenna from the EUT, and then connect a low loss RF cable from antenna port to the spectrum analyzer.
3. Set the spectrum analyzer as RBW=30 kHz, VBW=100 kHz, Span=3MHz, Sweep = auto.
4. Mark the peak frequency and 20dB (upper and lower) frequency.
5. Repeat until all the test channels are investigated.

TEST RESULTS

No non-compliance noted



Test plot

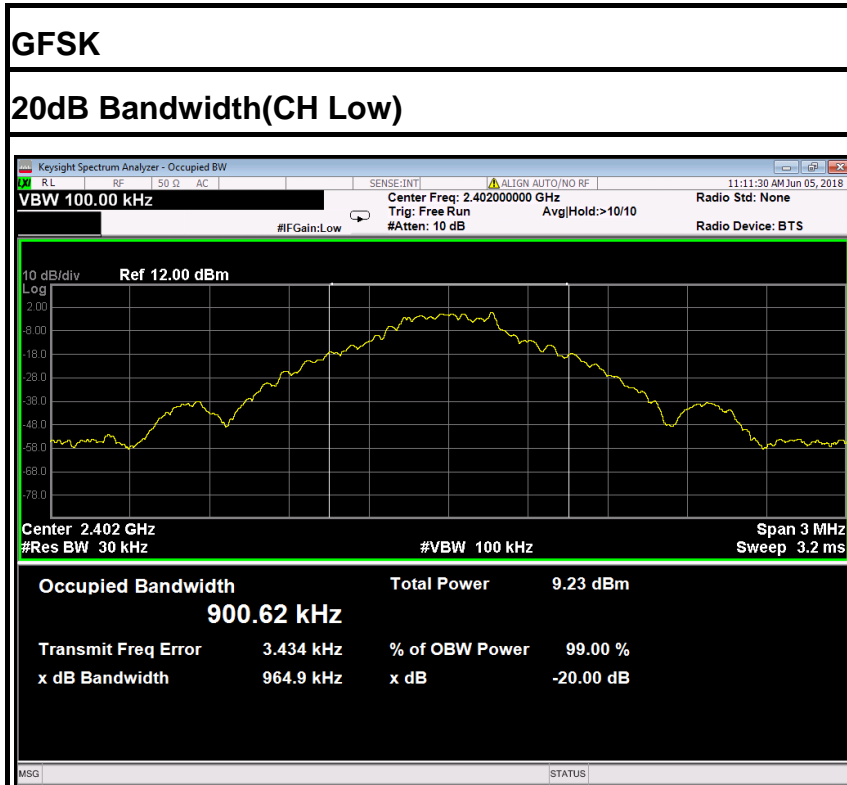

20dB Bandwidth (CH Mid)

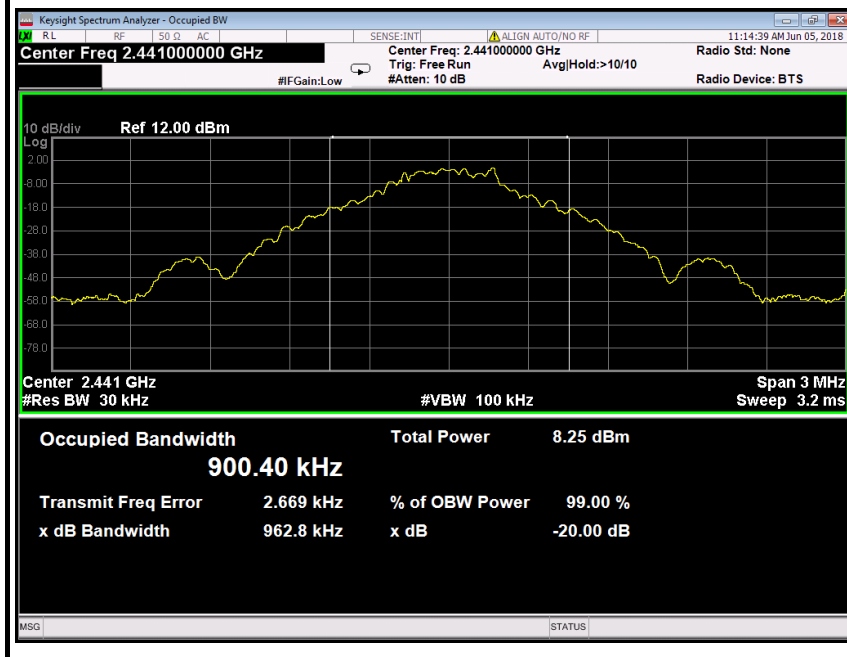



20dB Bandwidth (CH High)

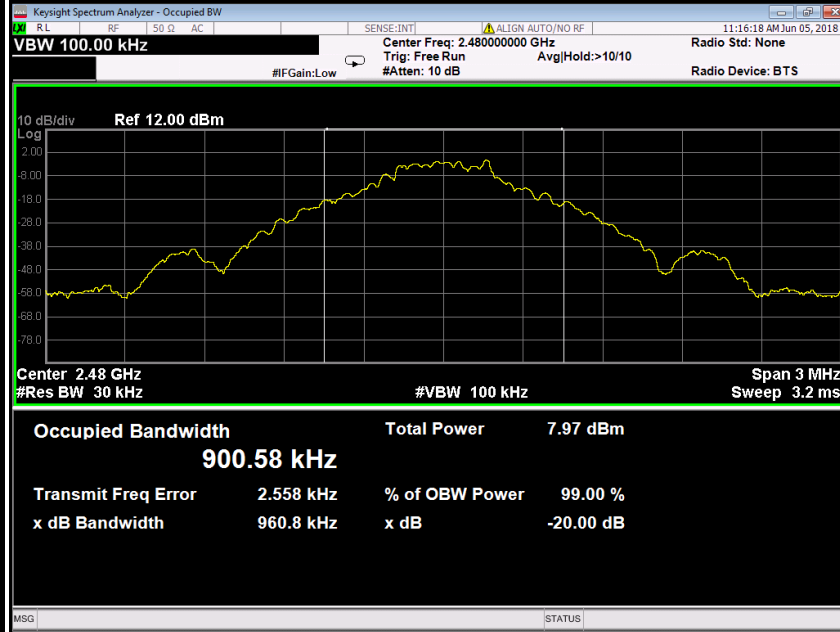

8DPSK

20dB Bandwidth (CH Low)

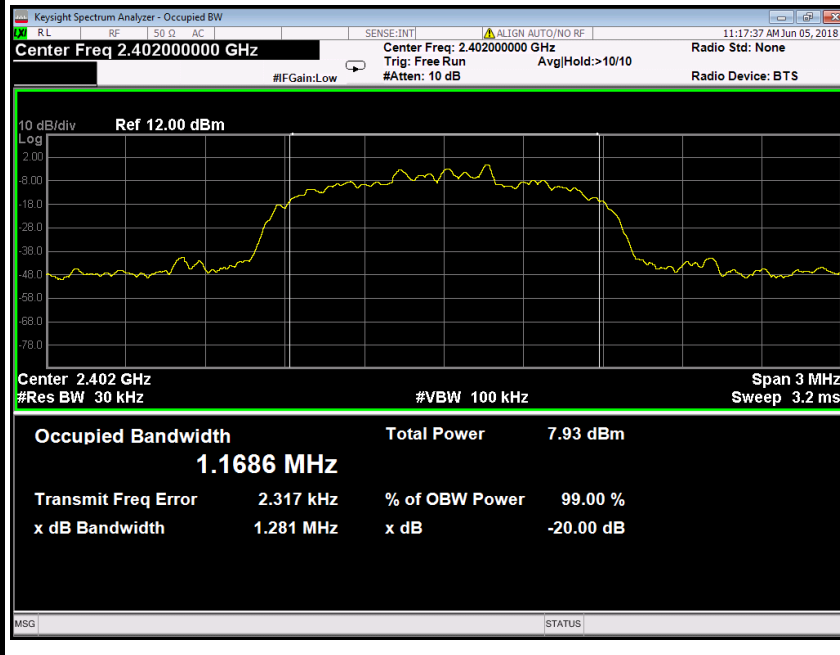



20dB Bandwidth (CH Mid)

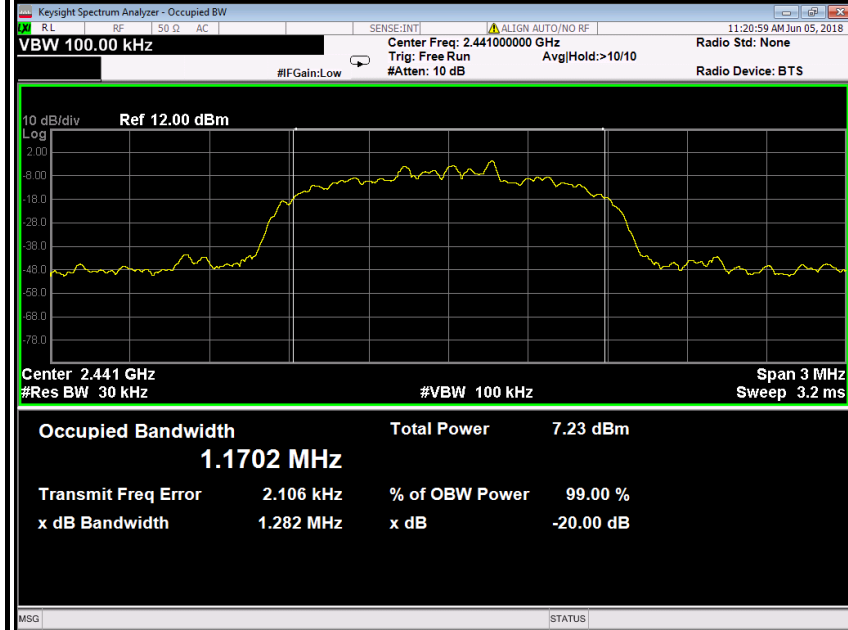

20dB Bandwidth (CH High)

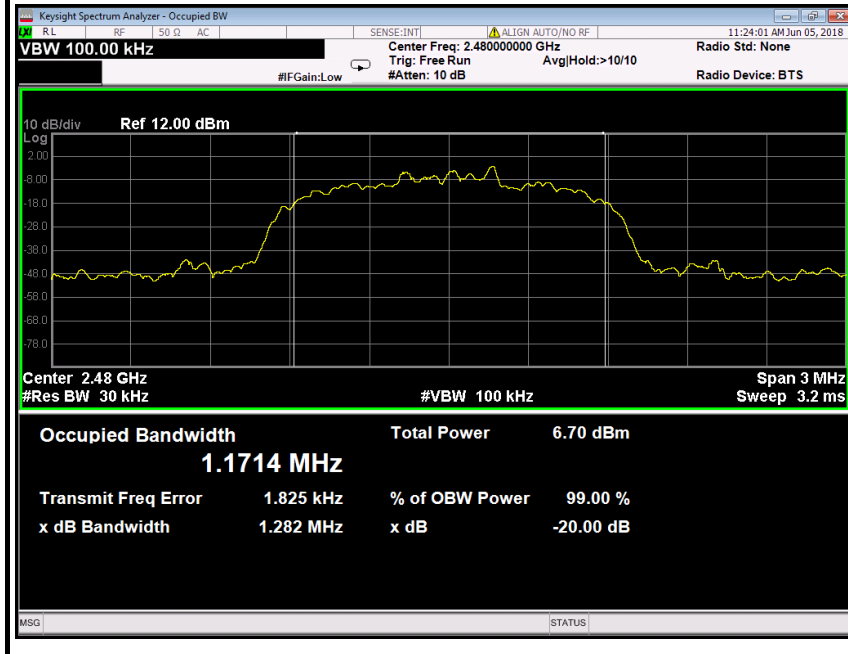



7.2 ANTENNA GAIN

MEASUREMENT

The antenna gain of the complete system is calculated by the difference of radiated power in EIRP and the conducted power of the module. For normal BT devices, the GFSK mode is used.

MEASUREMENT PARAMETERS

Measurement parameter	
Detector	Peak
Sweep time	Auto
Resolution bandwidth	3 MHz
Video bandwidth	3 MHz
Trace-Mode	Max hold

LIMITS

FCC	IC
Antenna Gain	
6 dBi	

TEST RESULTS

GFSK

T _{nom}	V _{nom}	Lowest channel 2402MHz	Middle channel 2441MHz	Highest channel 2480MHz
Conducted power [dBm] Measured with GFSK modulation		4.13	3.18	2.62
Radiated power [dBm] Measured with GFSK modulation		5.03	4.36	3.68
Gain [dBi] Calculated		0.90	1.18	1.06
Measurement uncertainty		± 1.5 dB (cond.) / ± 3 dB (rad.)		

8DPSK

T _{nom}	V _{nom}	Lowest channel 2402MHz	Middle channel 2441MHz	Highest channel 2480MHz
Conducted power [dBm] Measured with GFSK modulation		4.00	3.09	2.64
Radiated power [dBm] Measured with GFSK modulation		4.38	4.05	3.72
Gain [dBi] Calculated		0.38	0.96	1.08
Measurement uncertainty		± 1.5 dB (cond.) / ± 3 dB (rad.)		



7.3 PEAK POWER

LIMIT

The maximum peak output power of the intentional radiator shall not exceed the following:

1. For frequency hopping systems operating in the 2400-2483.5 MHz band employing at least 75 non-overlapping hopping channels: 1 watt. For all other frequency hopping systems in the 2400-2483.5 MHz band: 0.125 watts.
2. Except as shown in paragraphs (b)(3) (i), (ii) and (iii) of this section, if transmitting antennas of directional gain greater than 6dBi are used the peak output power from the intentional radiator shall be reduced below the stated values in paragraphs (b)(1) or (b)(2) of this section, as appropriate, by the amount in dB that the directional gain of the antenna exceeds 6dBi.
3. The conducted output power limit specified in paragraph (b) of this section is based on the use of antennas with directional gains that do not exceed 6 dBi. Except as shown in paragraph (c) of this section, if transmitting antennas of directional gain greater than 6 dBi are used, the conducted output power from the intentional radiator shall be reduced below the stated values in paragraphs (b)(1), (b)(2), and (b)(3) of this section, as appropriate, by the amount in dB that the directional gain of the antenna exceeds 6 dBi.

MEASUREMENT EQUIPMENT USED

Name of Equipment	Manufacturer	Model	Serial Number	Last Calibration	Due Calibration
Power Meter	Anritsu	ML2495A	1204003	02/21/2018	02/20/2019
Power Sensor	Anritsu	MA2411B	1126150	02/21/2018	02/20/2019

Remark: Each piece of equipment is scheduled for calibration once a year.

TEST CONFIGURATION

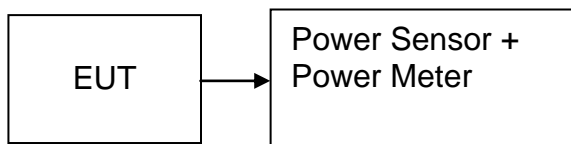

TEST PROCEDURE

The transmitter output is connected to the RF Power Meter. The RF Power Meter is set to the peak power detection.



TEST RESULTS

No non-compliance noted

Test Data

GFSK

Channel	Frequency (MHz)	Reading Power (dBm)	Cable loss (dB)	Output Power (dBm)	Output Power (W)	Limit (W)	Peak /AVG	Result
Low	2402	0.63	3.50	4.13	0.00259	0.125	peak	PASS
Mid	2441	-0.32	3.50	3.18	0.00208			PASS
High	2480	-0.88	3.50	2.62	0.00183			PASS
Low	2402	0.32	3.50	3.82	0.00241	0.125	AVG	PASS
Mid	2441	-0.61	3.50	2.89	0.00195			PASS
High	2480	-1.20	3.50	2.30	0.00170			PASS

$\pi/4$ -DQPSK

Channel	Frequency (MHz)	Reading Power (dBm)	Cable loss (dB)	Output Power (dBm)	Output Power (W)	Limit (W)	Peak /AVG	Result
Low	2402	0.39	3.50	3.89	0.00245	0.125	peak	PASS
Mid	2441	-0.57	3.50	2.93	0.00196			PASS
High	2480	-1.08	3.50	2.42	0.00175			PASS
Low	2402	-0.86	3.50	2.64	0.00184	0.125	AVG	PASS
Mid	2441	-1.85	3.50	1.65	0.00146			PASS
High	2480	-2.37	3.50	1.13	0.00130			PASS

8DPSK

Channel	Frequency (MHz)	Reading Power (dBm)	Cable loss (dB)	Output Power (dBm)	Output Power (W)	Limit (W)	Peak /AVG	Result
Low	2402	0.50	3.50	4.00	0.00251	0.125	peak	PASS
Mid	2441	-0.41	3.50	3.09	0.00204			PASS
High	2480	-0.86	3.50	2.64	0.00184			PASS
Low	2402	-1.12	3.50	2.38	0.00173	0.125	AVG	PASS
Mid	2441	-2.17	3.50	1.33	0.00136			PASS
High	2480	-2.33	3.50	1.17	0.00131			PASS



7.4 PEAK POWER SPECTRAL DENSITY

LIMIT

1. For direct sequence systems, the peak power spectral density conducted from the intentional radiator to the antenna shall not be greater than 8dBm in any 3kHz band during any time interval of continuous transmission.
2. The direct sequence operating of the hybrid system, with the frequency hopping operation turned off, shall comply with the power density requirements of paragraph (d) of this section.

MEASUREMENT EQUIPMENT USED

Name of Equipment	Manufacturer	Model	Serial Number	Last Calibration	Due Calibration
Spectrum Analyzer	Agilent	N9010A	MY55370330	01/27/2018	01/26/2019

Remark: Each piece of equipment is scheduled for calibration once a year.

TEST CONFIGURATION

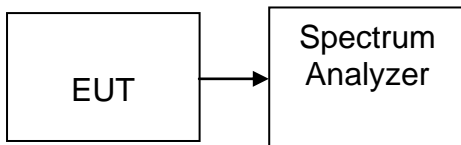

TEST PROCEDURE

1. Set analyzer center frequency to DTS channel center frequency.
2. Set the span to 1.5 times the DTS bandwidth.
3. Set the RBW to: $3 \text{ kHz} \leq \text{RBW} \leq 100 \text{ kHz}$.
4. Set the VBW $\geq 3 \times \text{RBW}$.
5. Detector = peak.
6. Sweep time = auto couple.
7. Trace mode = max hold.
8. Allow trace to fully stabilize.
9. Use the peak marker function to determine the maximum amplitude level within the RBW.
10. If measured value exceeds limit, reduce RBW (no less than 3 kHz) and repeat.

TEST RESULTS

Not applicable. Since EUT is the Bluetooth device.



7.5 BAND EDGES MEASUREMENT

LIMIT

According to §15.247(d), in any 100 kHz bandwidth outside the frequency bands in which the spread spectrum intentional radiator is operating, the radio frequency power that is produced by the intentional radiator shall be at least 20dB below that in the 100kHz bandwidth within the band that contains the highest level of the desired power, In addition, radiated emissions which fall in the restricted bands, as defined in §15.205(a), must also comply with the radiated emission limits specified in 15.209(a).

MEASUREMENT EQUIPMENT USED

Radiated Emission Test Site 966 (2)					
Name of Equipment	Manufacturer	Model Number	Serial Number	Last Calibration	Due Calibration
PSA Series Spectrum Analyzer	Agilent	N9010A	MY52221469	01/27/2018	01/26/2019
EMI TEST RECEIVER	ROHDE&SCHWARZ	ESCI	100783	02/21/2018	02/20/2019
Amplifier	EMEC	EM330	060661	03/18/2018	03/17/2019
High Noise Amplifier	Agilent	8449B	3008A01838	02/21/2018	02/20/2019
Loop Antenna	COM-POWER	AL-130	121044	09/25/2017	09/24/2018
Bilog Antenna	SCHAFFNER	CBL6143	5082	02/21/2018	02/20/2019
Horn Antenna	SCHWARZBECK	BBHA9120	D286	02/27/2018	02/27/2019
Board-Band Horn Antenna	Schwarzbeck	BBHA 9170	9170-497	02/27/2018	02/27/2019
Turn Table	N/A	N/A	N/A	N.C.R	N.C.R
Antenna Tower	SUNOL	TLT2	N/A	N.C.R	N.C.R
Controller	Sunol Sciences	SC104V	022310-1	N.C.R	N.C.R
Controller	CT	N/A	N/A	N.C.R	N.C.R
Temp. / Humidity Meter	Anymetre	JR913	N/A	01/29/2018	01/28/2019
Test S/W	FARAD	LZ-RF / CCS-SZ-3A2			



TEST CONFIGURATION

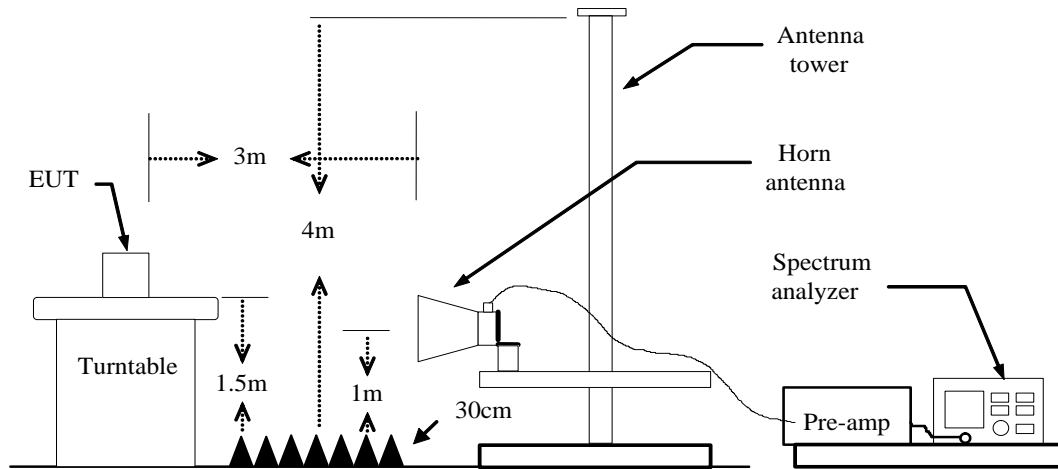

TEST PROCEDURE

1. The EUT is placed on a turntable, which is 1.5m above the ground plane.
2. The turntable shall be rotated for 360 degrees to determine the position of maximum emission level.
3. EUT is set 3m away from the receiving antenna, which is varied from 1m to 4m to find out the highest emission.
4. Set the spectrum analyzer in the following setting in order to capture the lower and upper band-edges of the emission:
 - (a) PEAK: RBW=1MHz / VBW=1MHz / Sweep=AUTO
 - (b) AVERAGE: RBW=1MHz / VBW=1/T / Sweep=AUTO
5. Repeat the procedures until all the PEAK and AVERAGE versus POLARIZATION are measured.

TEST RESULTS

Refer to attach spectrum analyzer data chart.



Test Data (GFSK)
Band Edges (CH Low)

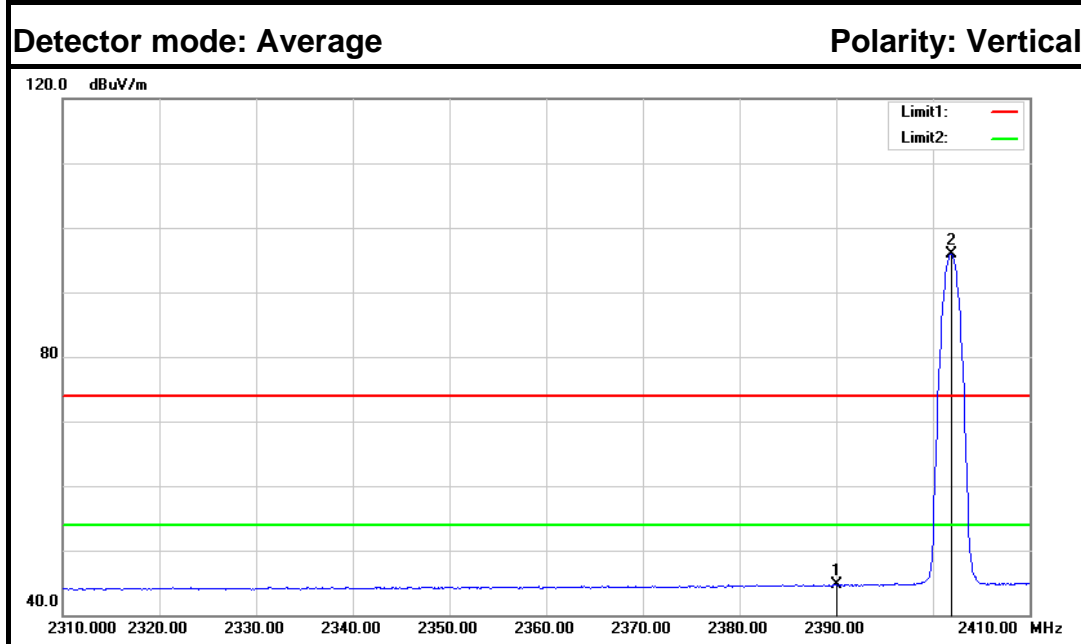
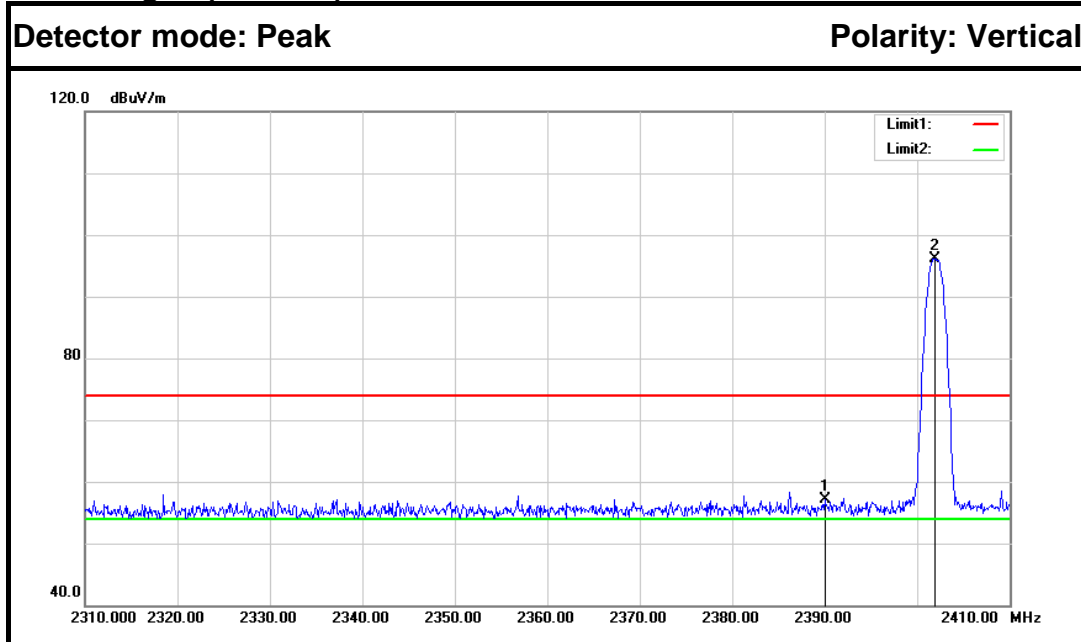

No.	Frequency (MHz)	Reading (dB)	Factor (dB/m)	Result (dB/m)	Limit (dB/m)	Margin (dB)	Remark	Antenna Polar
1	2390.000	59.88	-2.86	57.02	74.00	-16.98	Peak	Vertical
2	2401.900	98.94	-2.80	96.14	---	---	Peak	Vertical
1	2390.000	47.61	-2.86	44.75	54.00	-9.25	Average	Vertical
2	2401.900	98.64	-2.80	95.84	---	---	Average	Vertical

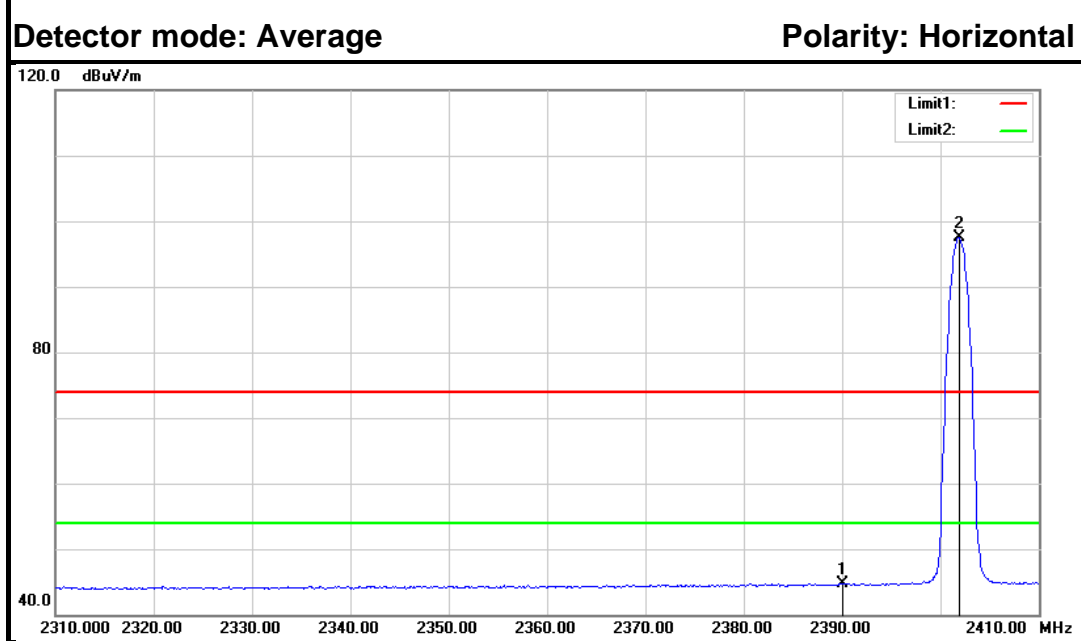
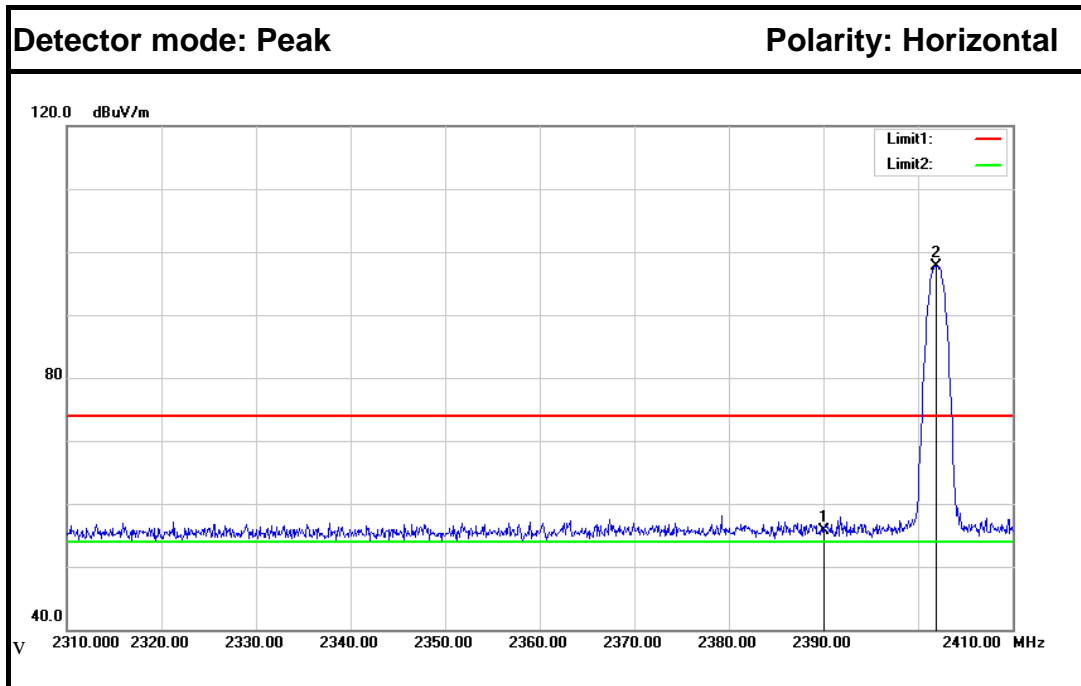

No.	Frequency (MHz)	Reading (dB)	Factor (dB/m)	Result (dB/m)	Limit (dB/m)	Margin (dB)	Remark	Antenna Polar
1	2390.000	58.61	-2.86	55.75	74.00	-18.25	Peak	Horizontal
2	2401.900	100.60	-2.80	97.80	---	---	Peak	Horizontal
1	2390.000	47.56	-2.86	44.70	54.00	-9.30	Average	Horizontal
2	2401.900	100.30	-2.80	97.50	---	---	Average	Horizontal



Band Edges (CH-High)

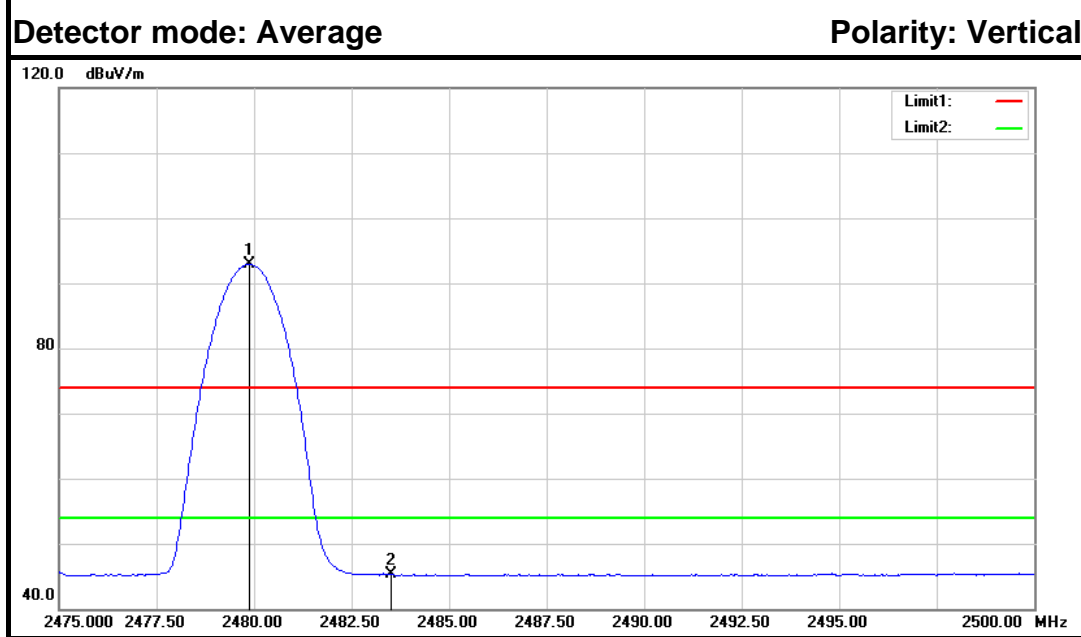
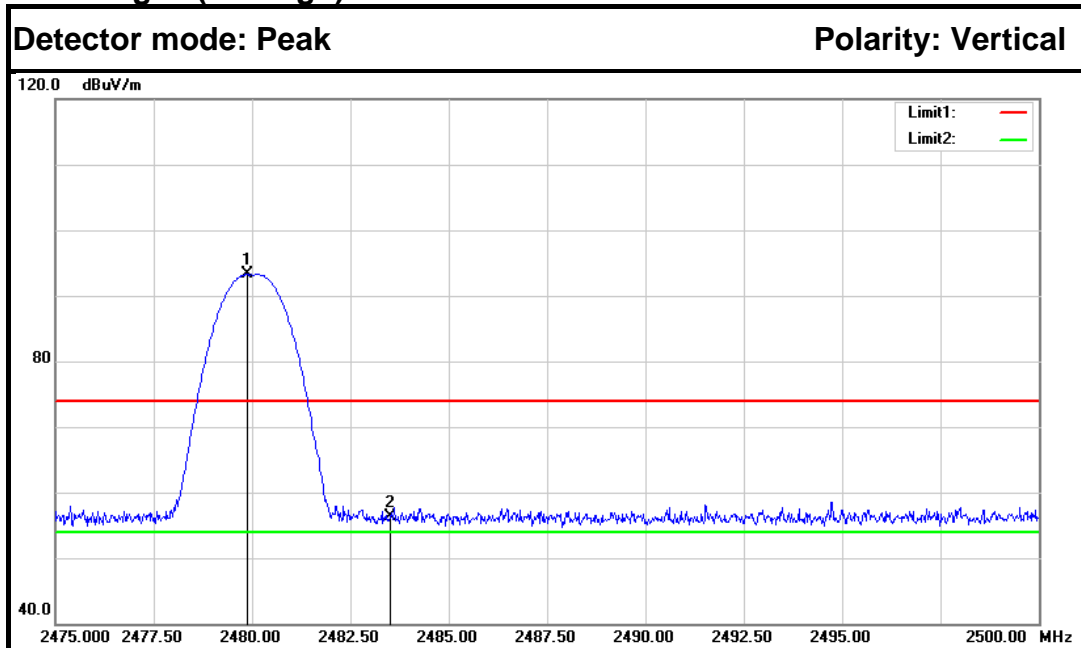

No.	Frequency (MHz)	Reading (dB)	Factor (dB/m)	Result (dB/m)	Limit (dB/m)	Margin (dB)	Remark	Antenna Polar
1	2479.875	95.63	-2.37	93.26	---	---	Peak	Vertical
2	2483.500	58.59	-2.35	56.24	74.00	-17.76	Peak	Vertical
1	2479.875	95.28	-2.37	92.91	---	---	Average	Vertical
2	2483.500	47.65	-2.35	45.30	54.00	-8.70	Average	Vertical

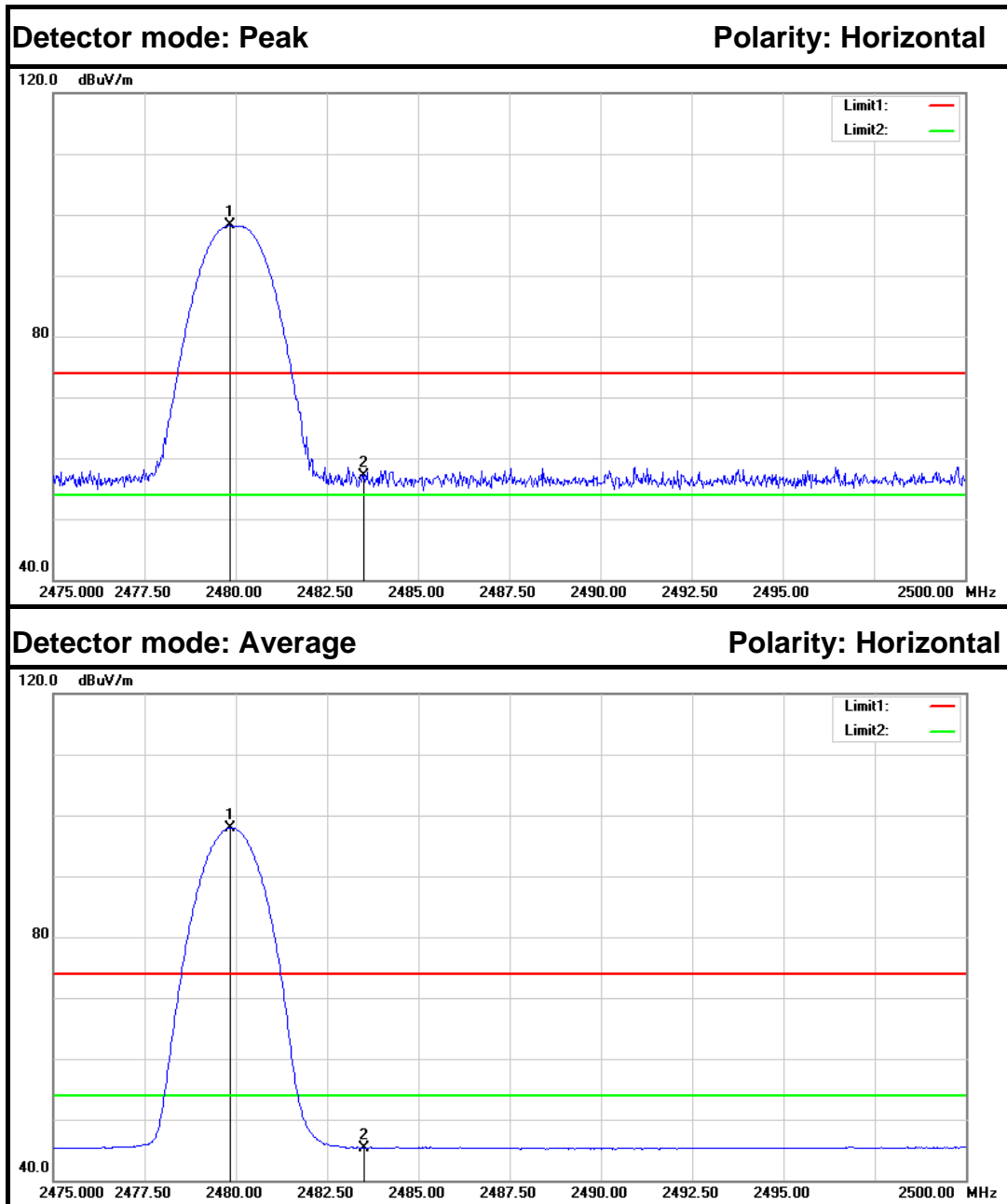

No.	Frequency (MHz)	Reading (dB)	Factor (dB/m)	Result (dB/m)	Limit (dB/m)	Margin (dB)	Remark	Antenna Polar
1	2479.850	100.58	-2.37	98.21	---	---	Peak	Horizontal
2	2483.500	59.51	-2.35	57.16	74.00	-16.84	Peak	Horizontal
1	2479.850	100.32	-2.37	97.95	---	---	Average	Horizontal
2	2483.500	47.68	-2.35	45.33	54.00	-8.67	Average	Horizontal



8DPSK
Band Edges (CH Low)

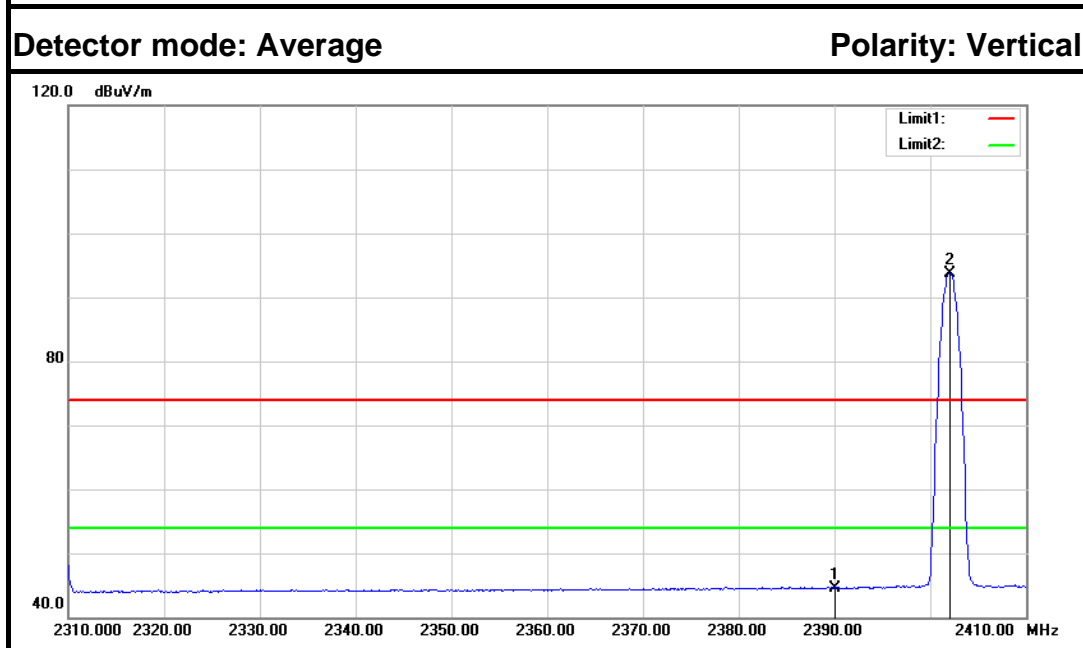
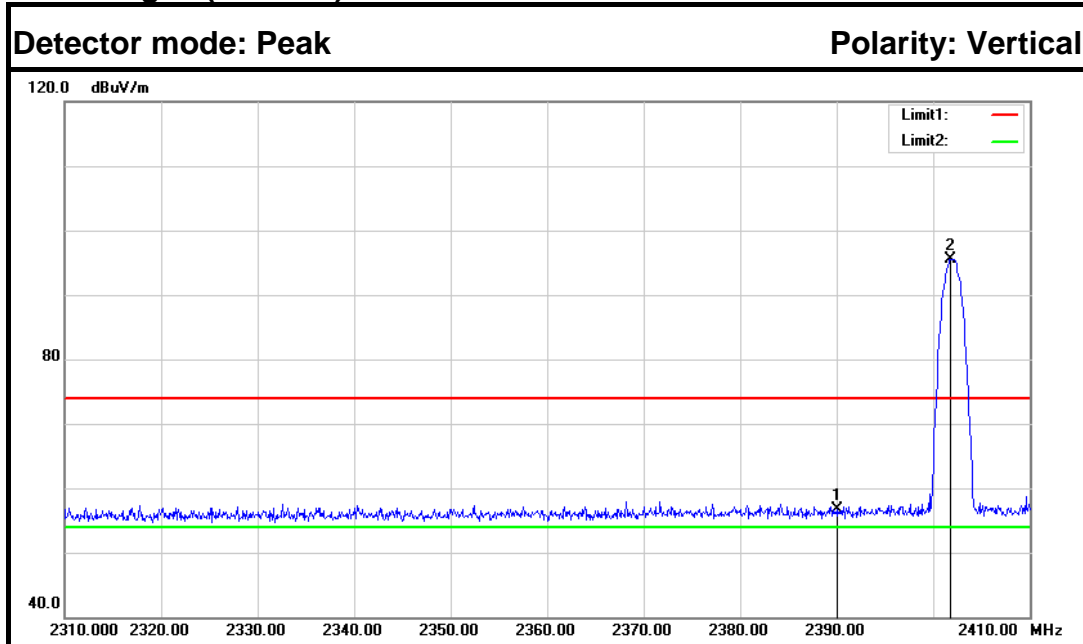

No.	Frequency (MHz)	Reading (dB)	Factor (dB/m)	Result (dB/m)	Limit (dB/m)	Margin (dB)	Remark	Antenna Polar
1	2390.000	59.47	-2.86	56.61	74.00	-17.39	Peak	Vertical
2	2401.800	98.29	-2.80	95.49	---	---	Peak	Vertical
1	2390.000	47.38	-2.86	44.52	54.00	-9.48	Average	Vertical
2	2402.100	96.60	-2.80	93.80	---	---	Average	Vertical

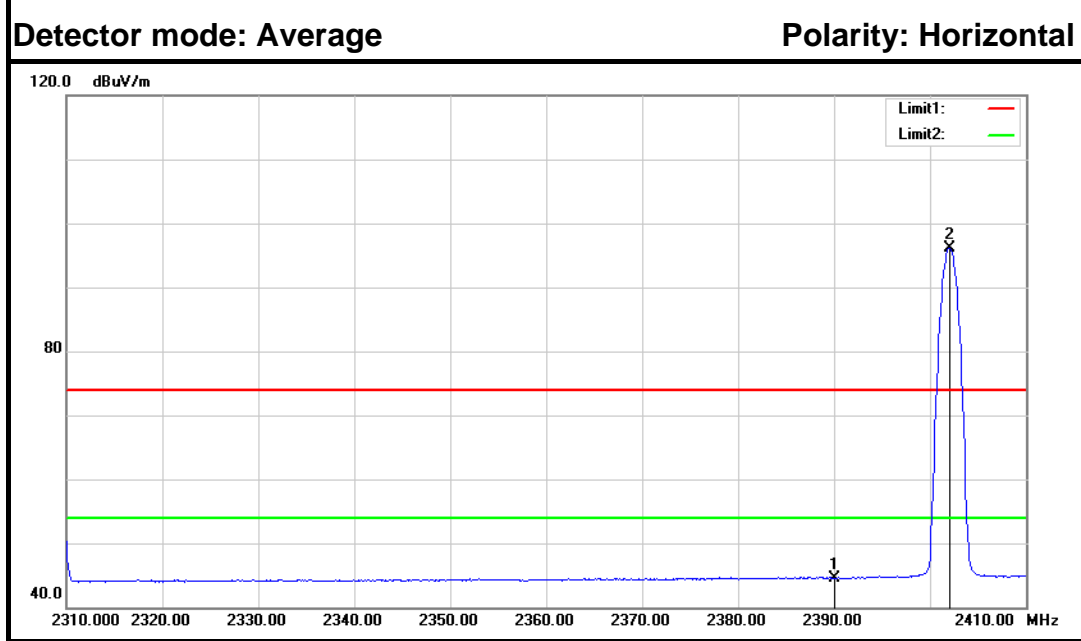
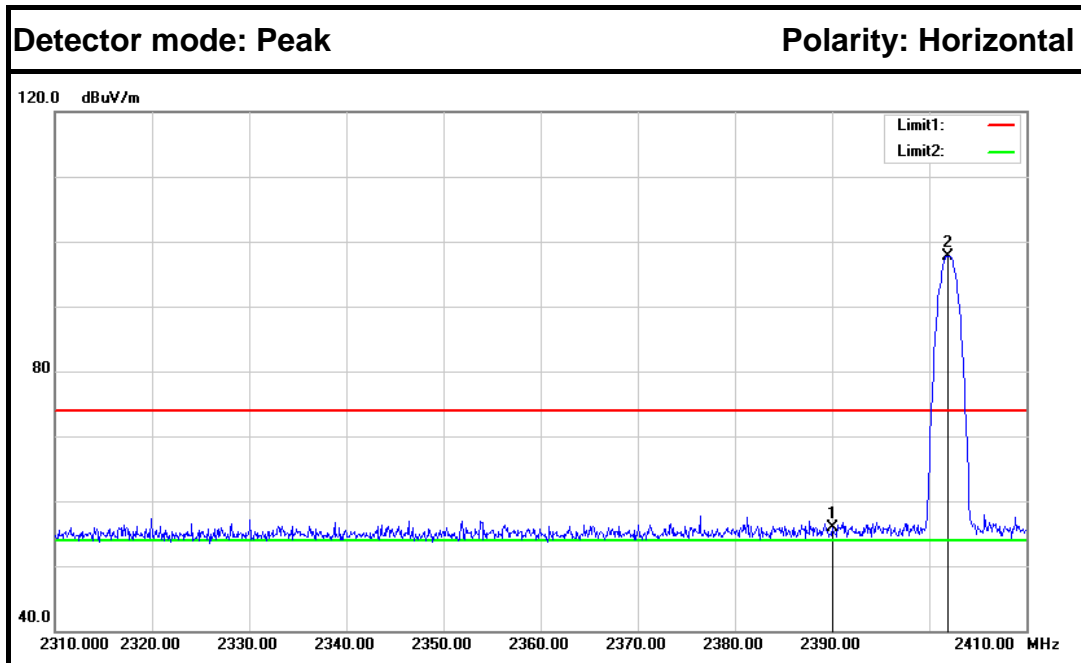

No.	Frequency (MHz)	Reading (dB)	Factor (dB/m)	Result (dB/m)	Limit (dB/m)	Margin (dB)	Remark	Antenna Polar
1	2390.000	58.67	-2.86	55.81	74.00	-18.19	Peak	Horizontal
2	2401.900	100.52	-2.80	97.72	---	---	Peak	Horizontal
1	2390.000	47.40	-2.86	44.54	54.00	-9.46	Average	Horizontal
2	2402.000	98.88	-2.80	96.08	---	---	Average	Horizontal



Band Edges (CH-High)

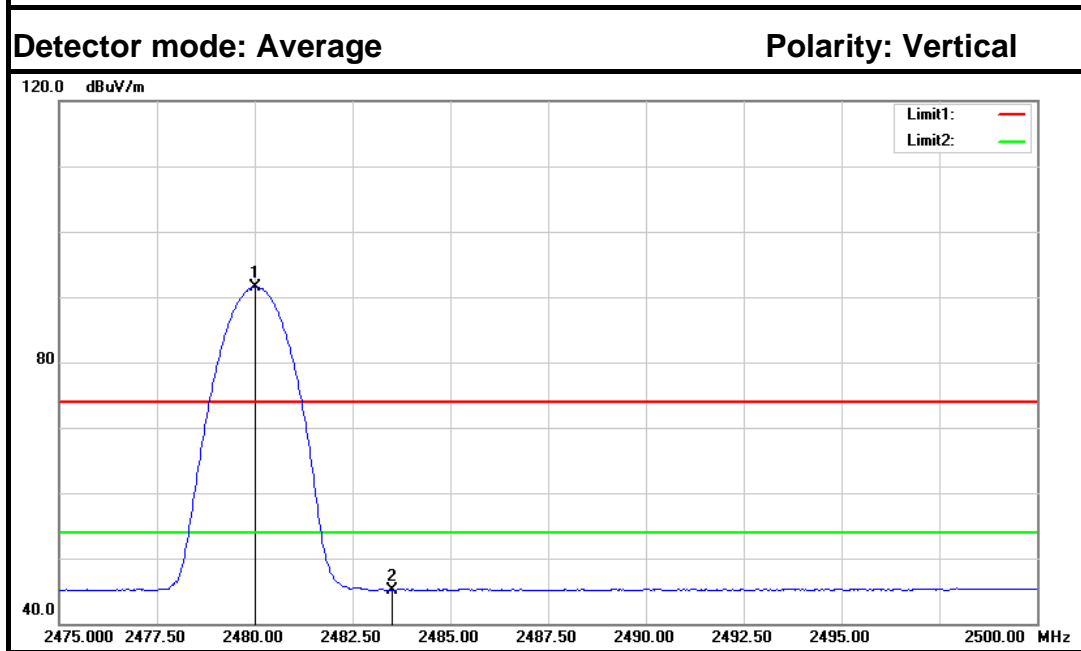
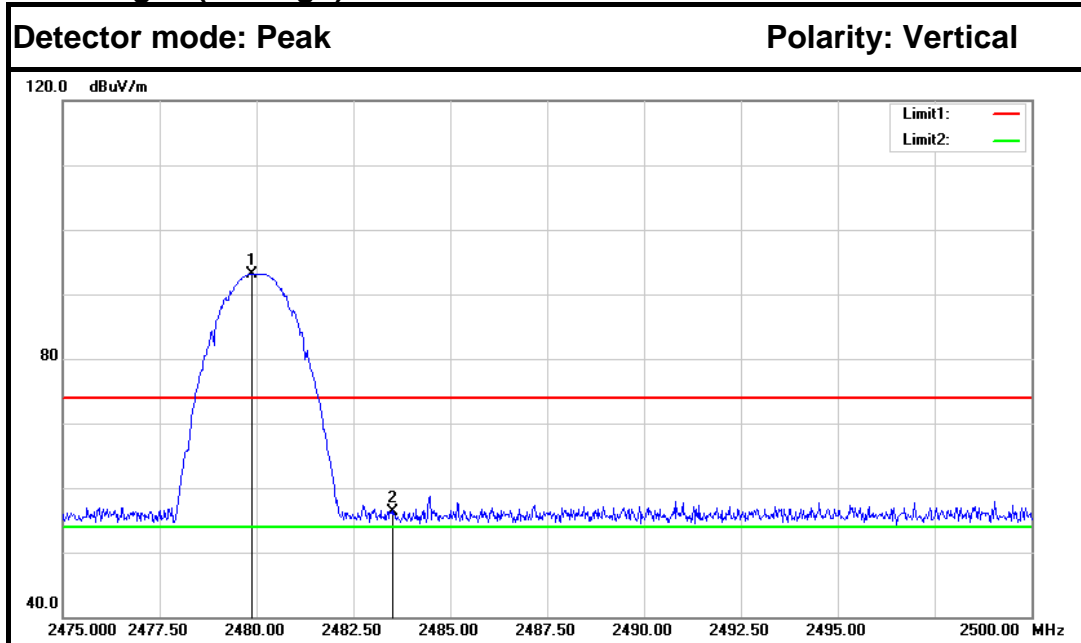

No.	Frequency (MHz)	Reading (dB)	Factor (dB/m)	Result (dB/m)	Limit (dB/m)	Margin (dB)	Remark	Antenna Polar
1	2479.875	95.52	-2.37	93.15	---	---	Peak	Vertical
2	2483.500	58.75	-2.35	56.40	74.00	-17.60	Peak	Vertical
1	2480.025	93.90	-2.37	91.53	---	---	Average	Vertical
2	2483.500	47.49	-2.35	45.14	54.00	-8.86	Average	Vertical

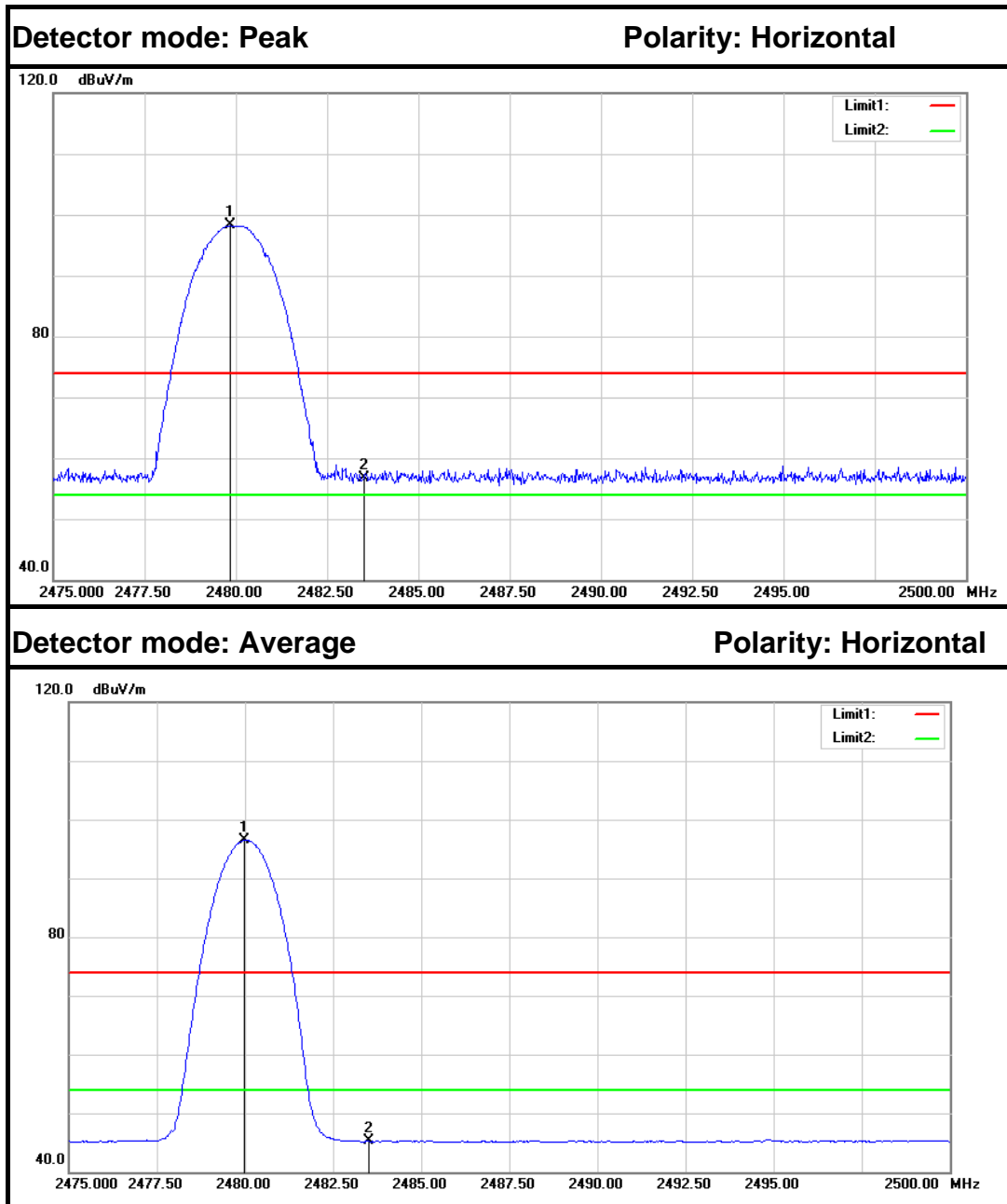

No.	Frequency (MHz)	Reading (dB)	Factor (dB/m)	Result (dB/m)	Limit (dB/m)	Margin (dB)	Remark	Antenna Polar
1	2479.850	100.58	-2.37	98.21	---	---	Peak	Horizontal
2	2483.500	59.09	-2.35	56.74	74.00	-17.26	Peak	Horizontal
1	2479.975	98.83	-2.37	96.46	---	---	Average	Horizontal
2	2483.500	47.64	-2.35	45.29	54.00	-8.71	Average	Horizontal



7.6 FREQUENCY SEPARATION

LIMIT

According to §15.247(a)(1), Frequency hopping systems shall have hopping channel carrier frequencies separated by a minimum of 25 kHz or the 20 dB bandwidth of the hopping channel, whichever is greater. Alternatively, frequency hopping systems operating in the 2400-2483.5 MHz band may have hopping channel carrier frequencies that are separated by 25 kHz or two-thirds of the 20 dB bandwidth of the hopping channel, whichever is greater, provided the systems operate with an output power no greater than 125 mW.

MEASUREMENT EQUIPMENT USED

Name of Equipment	Manufacturer	Model	Serial Number	Last Calibration	Due Calibration
Spectrum Analyzer	Agilent	N9010A	MY55370330	01/27/2018	01/26/2019

Remark: Each piece of equipment is scheduled for calibration once a year.

TEST CONFIGURATION

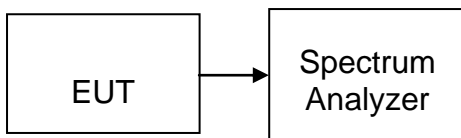

TEST PROCEDURE

1. Place the EUT on the table and set it in transmitting mode.
2. Remove the antenna from the EUT and then connect a low loss RF cable from the antenna port to the spectrum analyzer.
3. Set center frequency of spectrum analyzer = middle of hopping channel.
4. Set the spectrum analyzer as RBW=30kHz, VBW=30kHz, Adjust Span to 4 MHz, Sweep = auto.
5. Max hold. Mark 3 Peaks of hopping channel and record the 3 peaks frequency.

TEST RESULTS

No non-compliance noted

Test Data

GFSK

Channel Separation (MHz)	Two-thirds of the 20 dB Bandwidth (kHz)	Channel Separation Limit	Result
1.000	643.267	> Two-thirds of the 20 dB Bandwidth	Pass

8DPSK

Channel Separation (MHz)	Two-thirds of the 20 dB Bandwidth (kHz)	Channel Separation Limit	Result
1.000	854.667	> Two-thirds of the 20 dB Bandwidth	Pass



GFSK

Test Plot

Measurement of Channel Separation

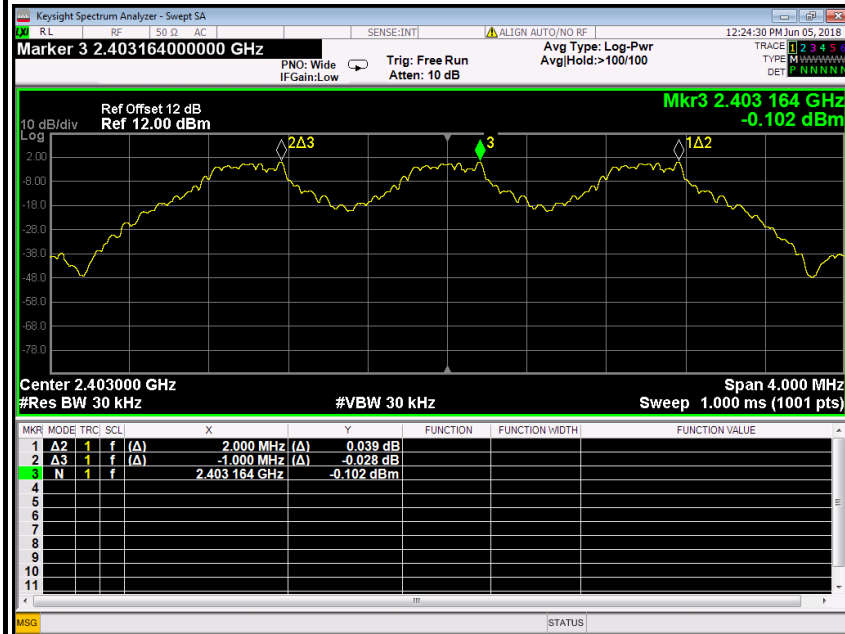

20 dB bandwidth(CH Low)

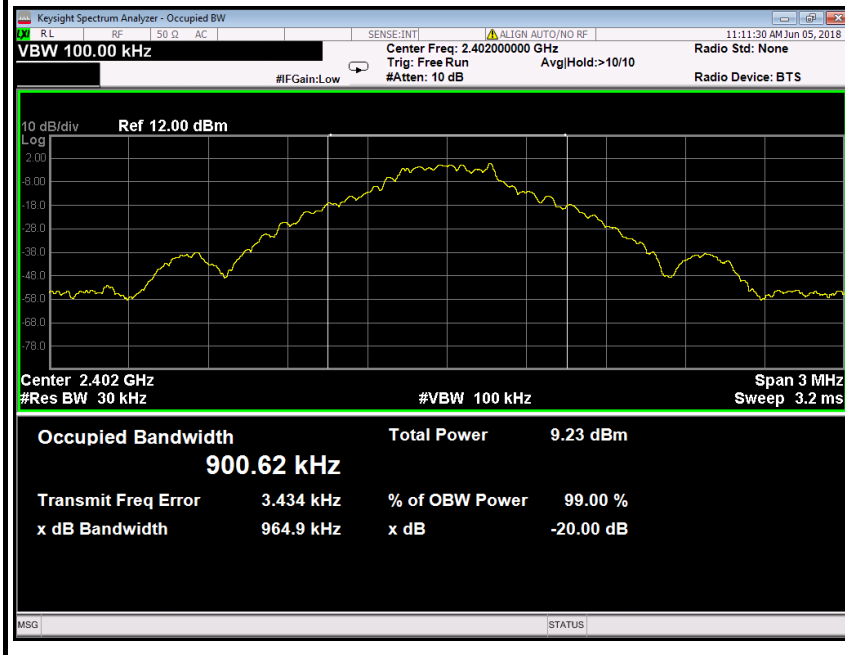



8DPSK

Test Plot

Measurement of Channel Separation

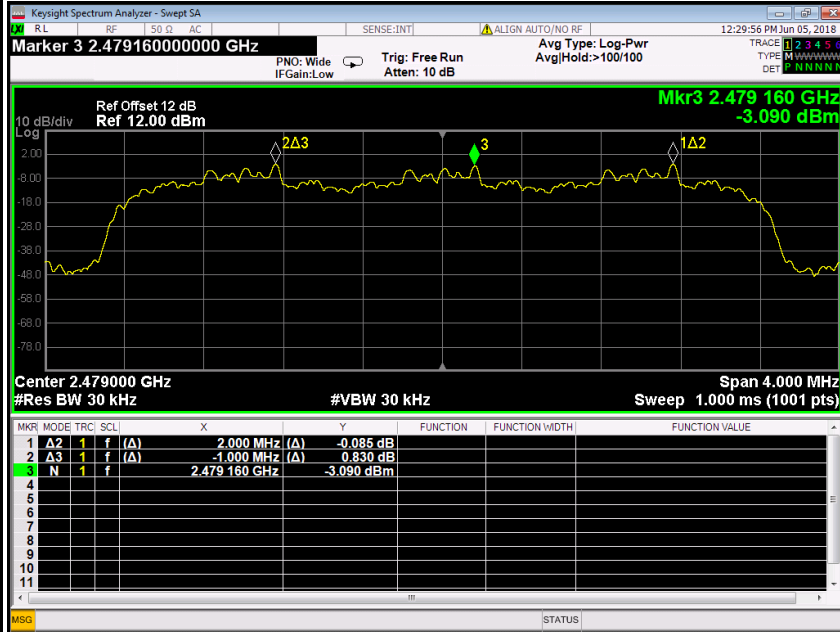

20 dB bandwidth(CH High)

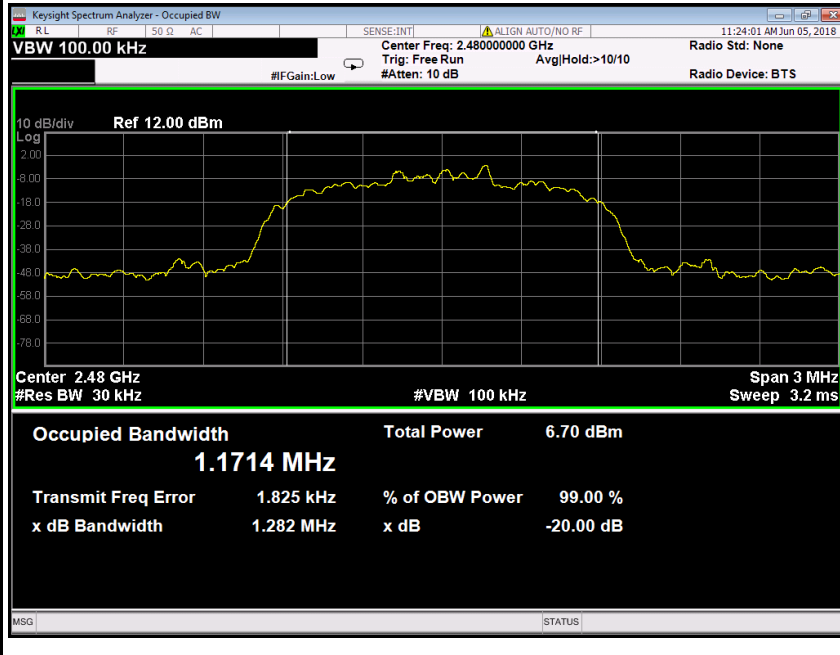



7.7 NUMBER OF HOPPING FREQUENCY

LIMIT

According to §15.247(a)(1)(ii), Frequency hopping systems operating in the 2400MHz-2483.5 MHz bands shall use at least 15 hopping frequencies.

MEASUREMENT EQUIPMENT USED

Name of Equipment	Manufacturer	Model	Serial Number	Last Calibration	Due Calibration
Spectrum Analyzer	Agilent	N9010A	MY55370330	01/27/2018	01/26/2019

Remark: Each piece of equipment is scheduled for calibration once a year.

TEST CONFIGURATION

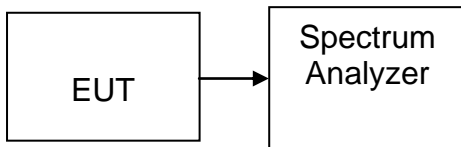

TEST PROCEDURE

1. Place the EUT on the table and set it in transmitting mode.
2. Remove the antenna from the EUT and then connect a low loss RF cable from the antenna port to the spectrum analyzer.
3. Set spectrum analyzer Start=2400MHz, Stop = 2483.5MHz, Sweep = 1ms.
4. Set the spectrum analyzer as RBW, VBW=300kHz,
5. Max hold, view and count how many channel in the band.

TEST RESULTS

No non-compliance noted

Test Data

Result (No. of CH)	Limit (No. of CH)	Result
79	>15	PASS



Test Plot

Channel Number

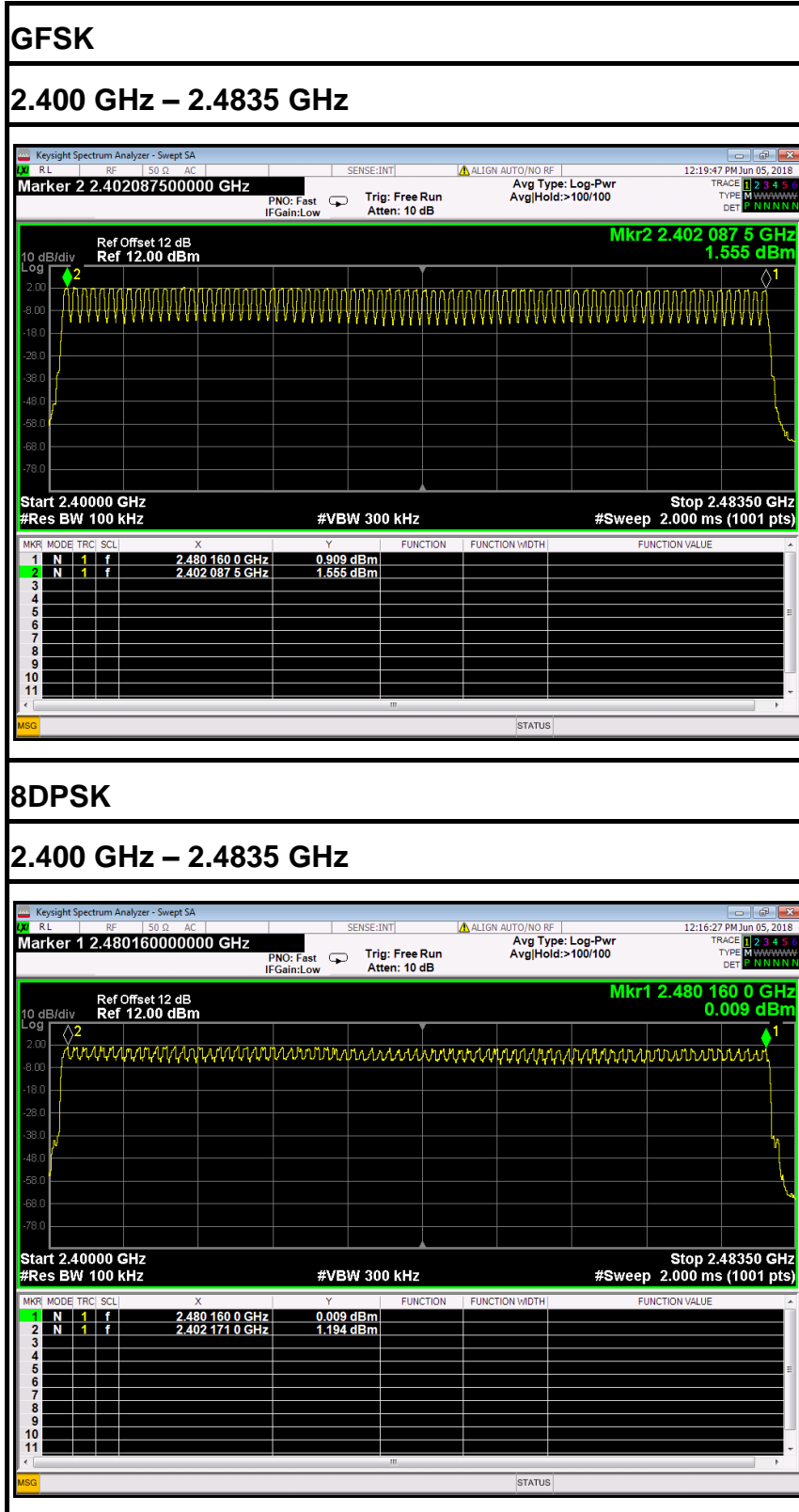

8DPSK

2.400 GHz – 2.4835 GHz

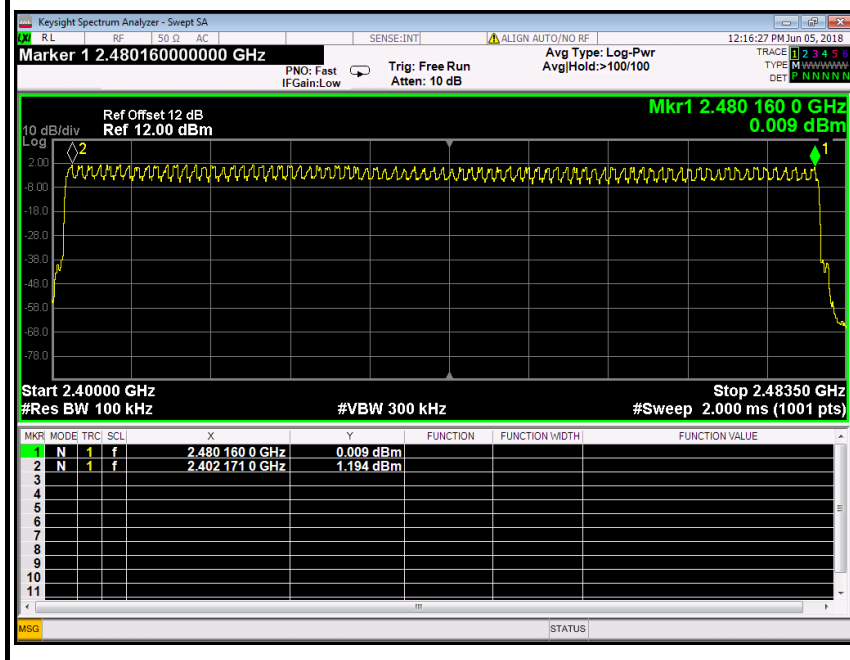



7.8 TIME OF OCCUPANCY (DWELL TIME)

LIMIT

According to §15.247(a)(1)(iii), Frequency hopping systems operating in the 2400MHz-2483.5 MHz bands. The average time of occupancy on any channels shall not greater than 0.4 s within a period 0.4s multiplied by the number of hopping channels employed.

MEASUREMENT EQUIPMENT USED

Name of Equipment	Manufacturer	Model	Serial Number	Last Calibration	Due Calibration
Spectrum Analyzer	Agilent	N9010A	MY55370330	01/27/2018	01/26/2019

Remark: Each piece of equipment is scheduled for calibration once a year.

TEST CONFIGURATION

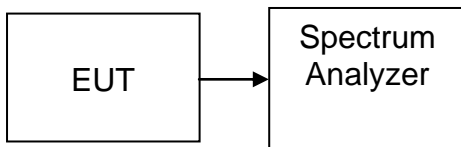

TEST PROCEDURE

1. Place the EUT on the table and set it in transmitting mode.
2. Remove the antenna from the EUT and then connect a low loss RF cable from the antenna port to the spectrum analyzer.
3. Set center frequency of spectrum analyzer = operating frequency.
4. Set the spectrum analyzer as RBW, VBW=1MHz, Span = 0Hz, Sweep = auto.
5. Repeat above procedures until all frequency measured were complete.



TEST RESULTS

No non-compliance noted

Test Data

GFSK

DH 1

CH Low: $0.599 * (1600/2)/79 * 31.6 = 191.68$ (ms)

CH	Pulse Time (ms)	Total of Dwell (ms)	Period Time (s)	Limit (ms)	Result
Low	0.599	191.68	31.60	400.00	PASS

DH 3

CH Low: $1.951 * (1600/4)/79 * 31.6 = 312.16$ (ms)

CH	Pulse Time (ms)	Total of Dwell (ms)	Period Time (s)	Limit (ms)	Result
Low	1.851	312.16	31.60	400.00	PASS

DH 5

CH Low: $2.908 * (1600/6)/79 * 31.6 = 310.19$ (ms)

CH	Pulse Time (ms)	Total of Dwell (ms)	Period Time (s)	Limit (ms)	Result
Low	2.908	310.19	31.60	400.00	PASS



8DPSK

3DH 1

CH Low: $0.599 * (1600/2)/79 * 31.6 = 191.68$ (ms)

CH	Pulse Time (ms)	Total of Dwell (ms)	Period Time (s)	Limit (ms)	Result
Low	0.599	191.68	31.60	400.00	PASS

3DH 3

CH Low: $1.851 * (1600/4)/79 * 31.6 = 312.16$ (ms)

CH	Pulse Time (ms)	Total of Dwell (ms)	Period Time (s)	Limit (ms)	Result
Low	1.851	312.16	31.60	400.00	PASS

3DH 5

CH Low: $2.900 * (1600/6)/79 * 31.6 = 309.33$ (ms)

CH	Pulse Time (ms)	Total of Dwell (ms)	Period Time (s)	Limit (ms)	Result
Low	2.900	309.33	31.60	400.00	PASS



Test Plot

GFSK

DH 1

CH Low

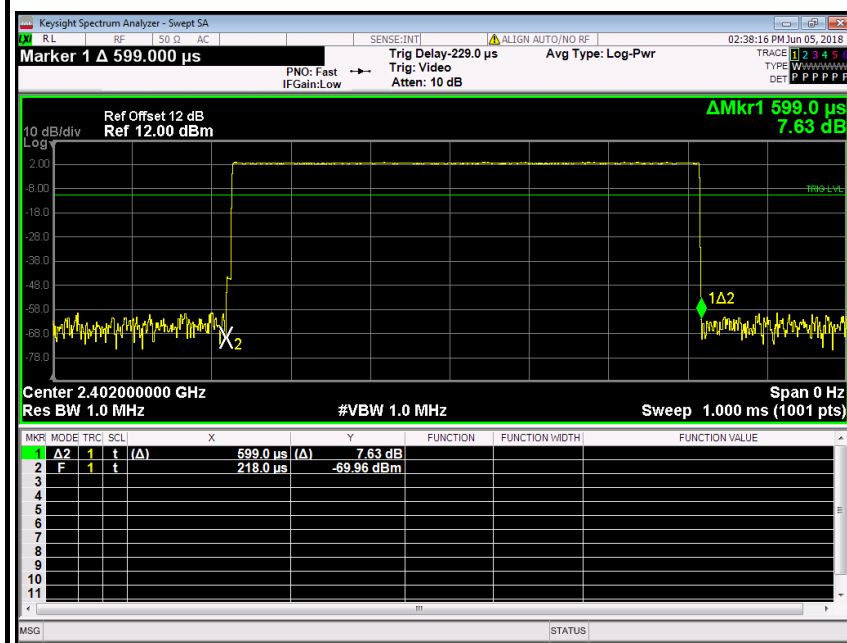

DH 3

CH Low

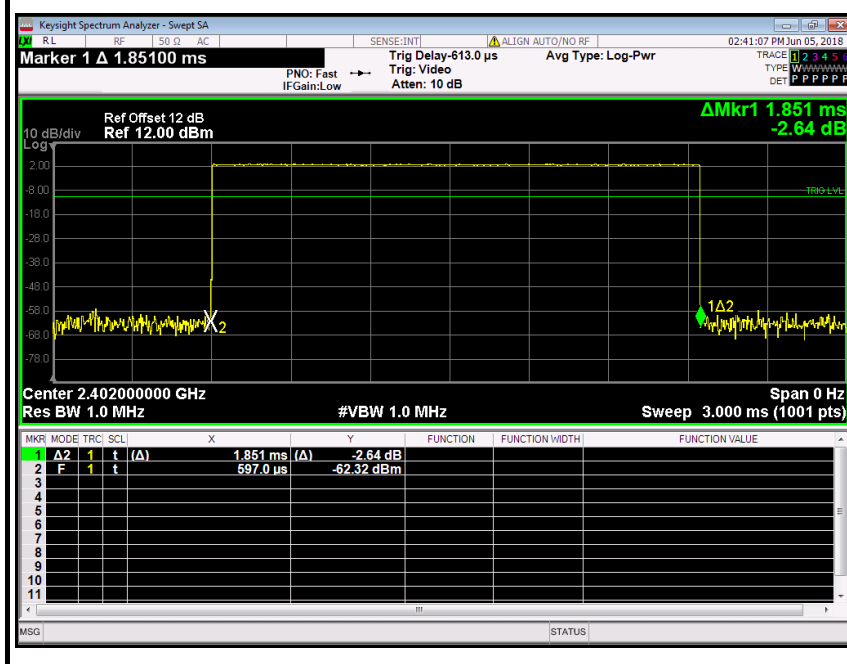

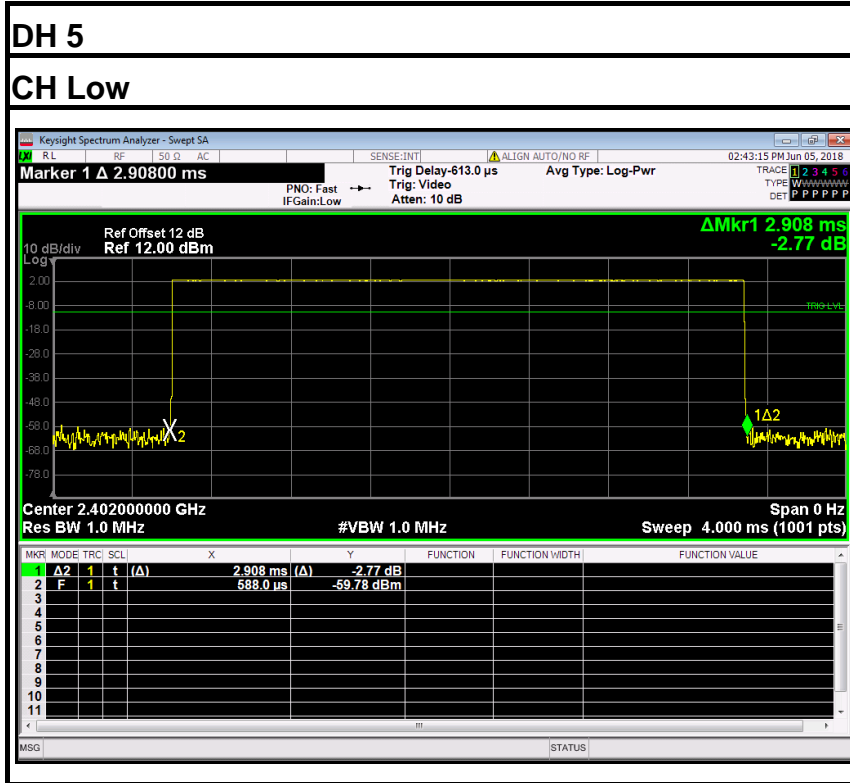



8DPSK

3DH 1

CH Low

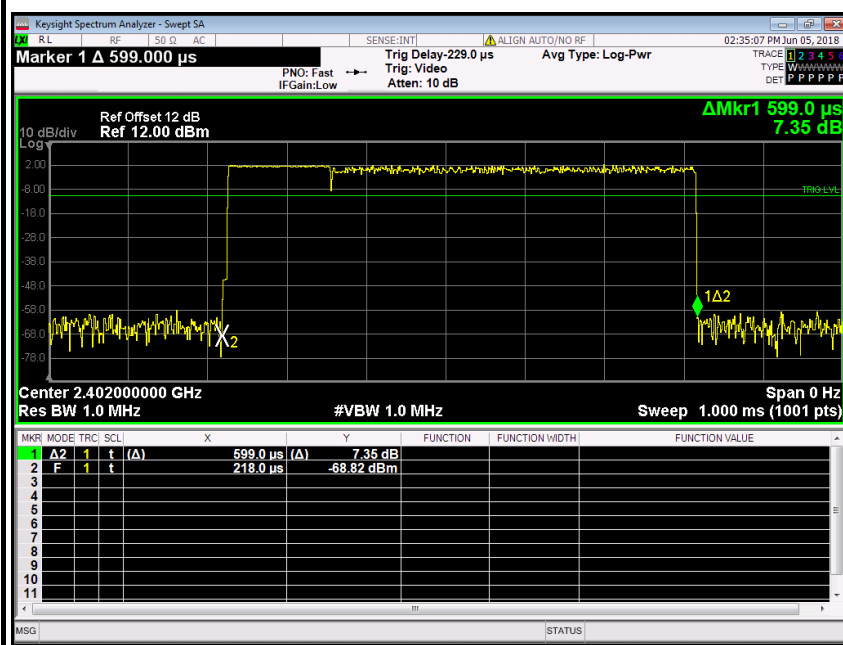

3DH 3

CH Low

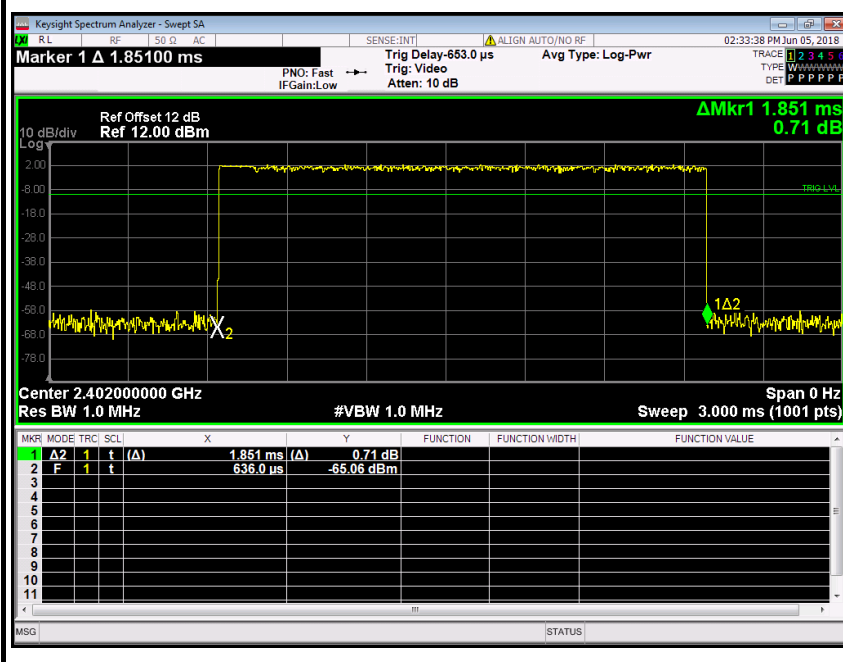

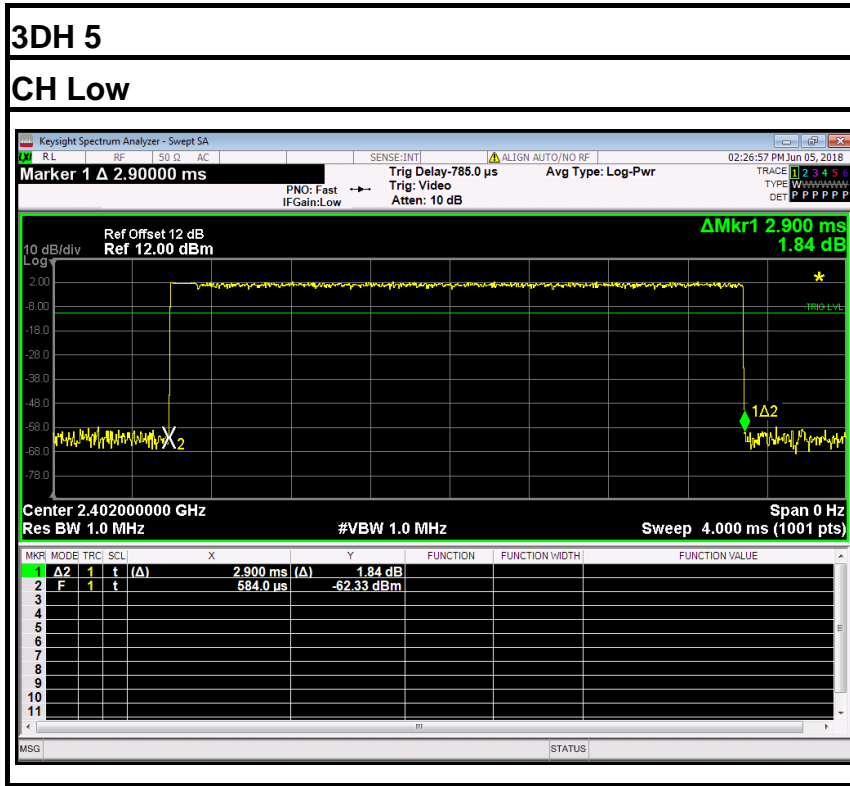



7.9 SPURIOUS EMISSIONS

7.9.1. CONDUCTED MEASUREMENT

LIMIT

In any 100 kHz bandwidth outside the frequency band in which the spread spectrum or digitally modulated intentional radiator is operating, the radio frequency power that is produced by the intentional radiator shall be at least 20 dB below that in the 100 kHz bandwidth within the band that contains the highest level of the desired power, based on either an RF conducted or a radiated measurement. Attenuation below the general limits specified in Section 15.209(a) is not required. In addition, radiated emissions which fall in the restricted bands, as defined in Section 15.205(a), must also comply with the radiated emission limits specified in Section 15.209(a) (see Section 15.205(c)).

MEASUREMENT EQUIPMENT USED

Name of Equipment	Manufacturer	Model	Serial Number	Last Calibration	Due Calibration
Spectrum Analyzer	Agilent	N9010A	MY55370330	01/27/2018	01/26/2019

Remark: Each piece of equipment is scheduled for calibration once a year.

TEST CONFIGURATION

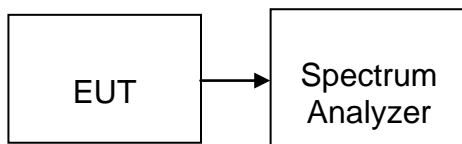

TEST PROCEDURE

Conducted RF measurements of the transmitter output were made to confirm that the EUT antenna port conducted emissions meet the specified limit and to identify any spurious signals that require further investigation or measurements on the radiated emissions site.

The transmitter output is connected to the spectrum analyzer. The resolution bandwidth is set to 100 kHz. The video bandwidth is set to 100 kHz.

Measurements are made over the 9 kHz to 26GHz range with the transmitter set to the lowest, middle, and highest channels, and highest channels. No emission found between lowest internal used/generated frequency to 10MHz , it is only recorded 10MHz to 26GHz.

TEST RESULTS

No non-compliance noted

Remark: The hopping on mode and hopping off mode were chosen for pre-test and the hopping off mode was the worse case and print in the report.



Hopping Off Test Plot (GFSK)

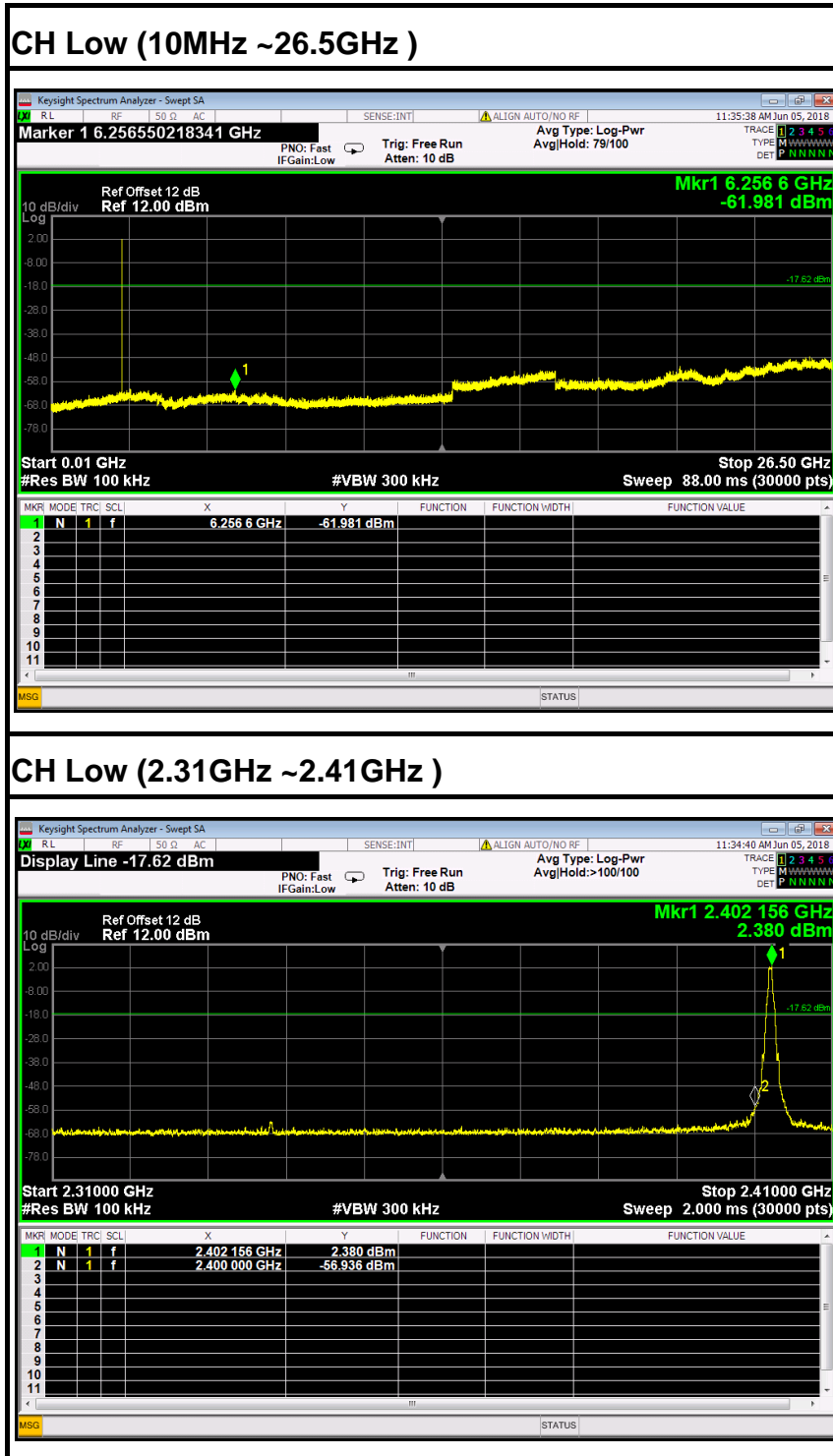

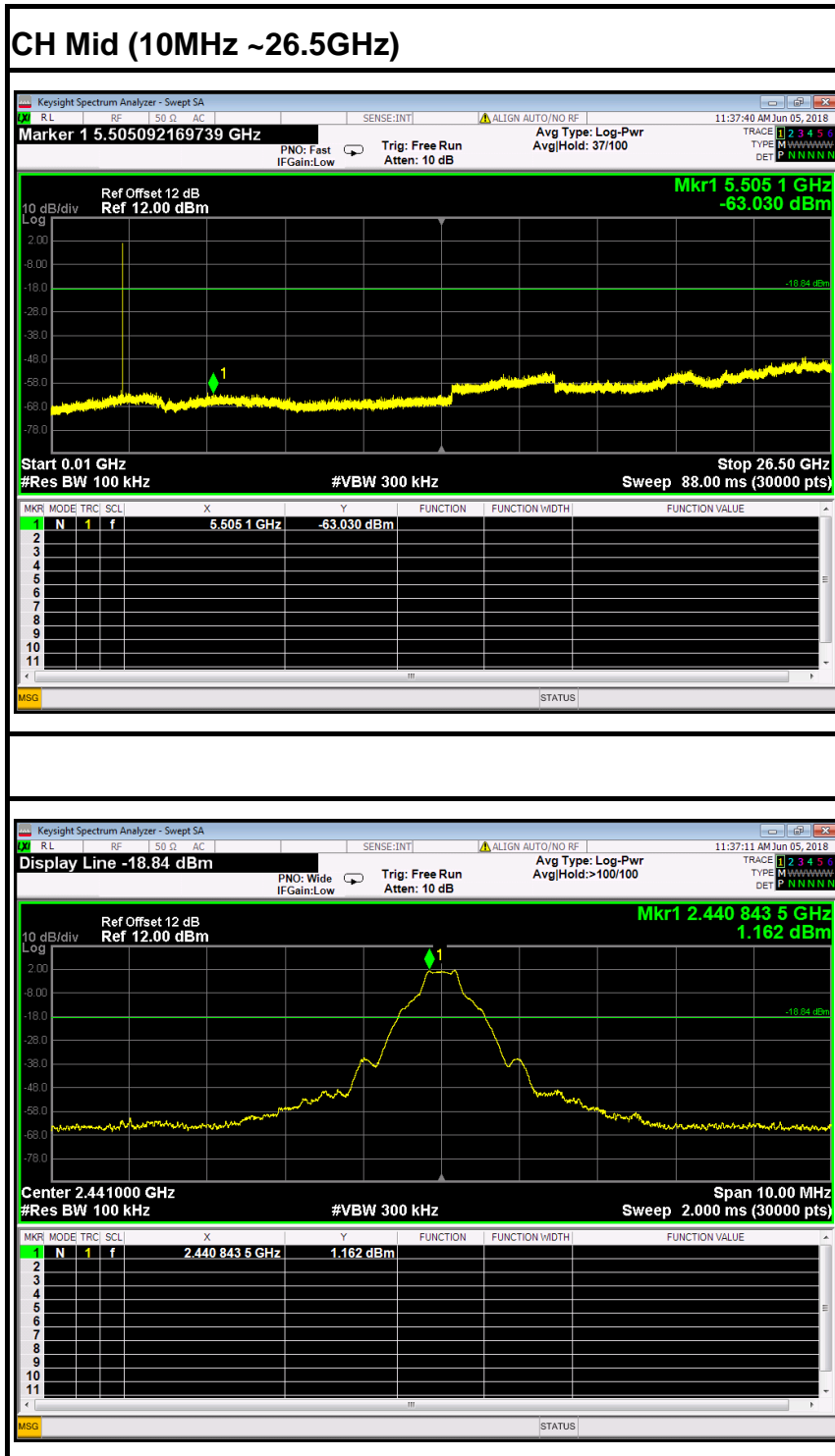

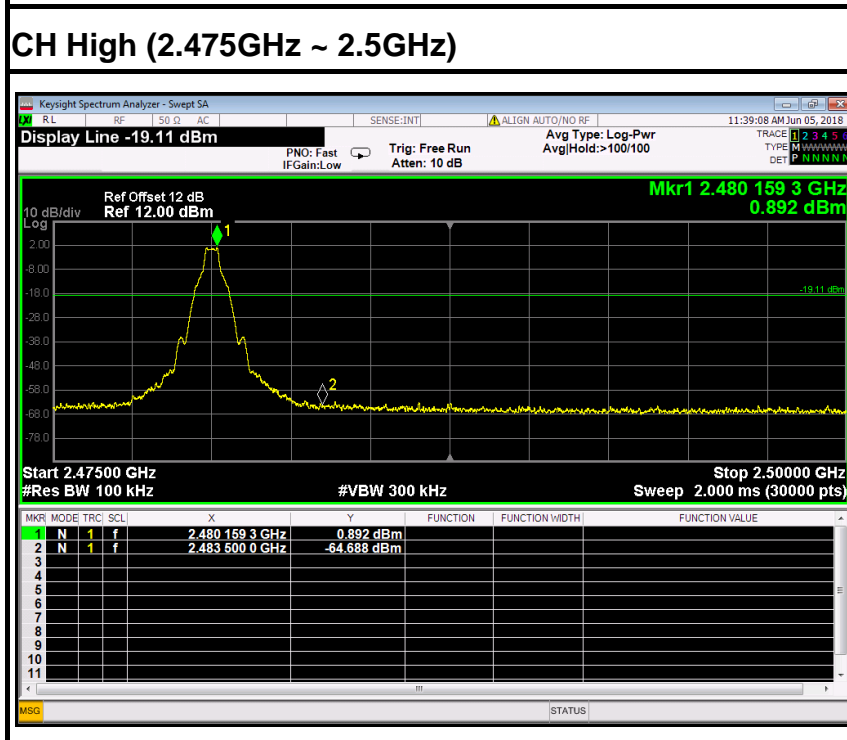
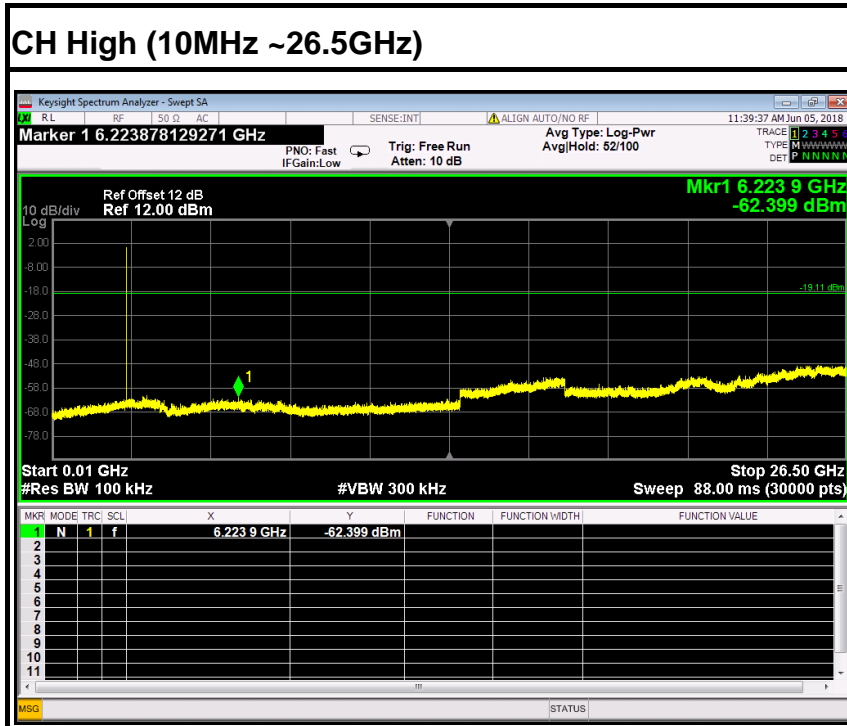



Test Plot (8DPSK)

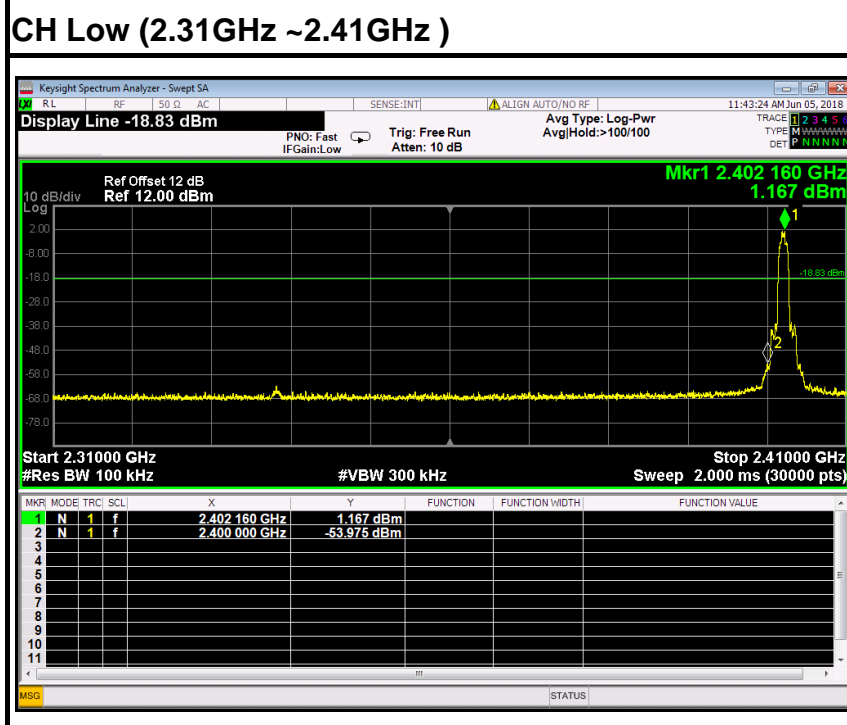
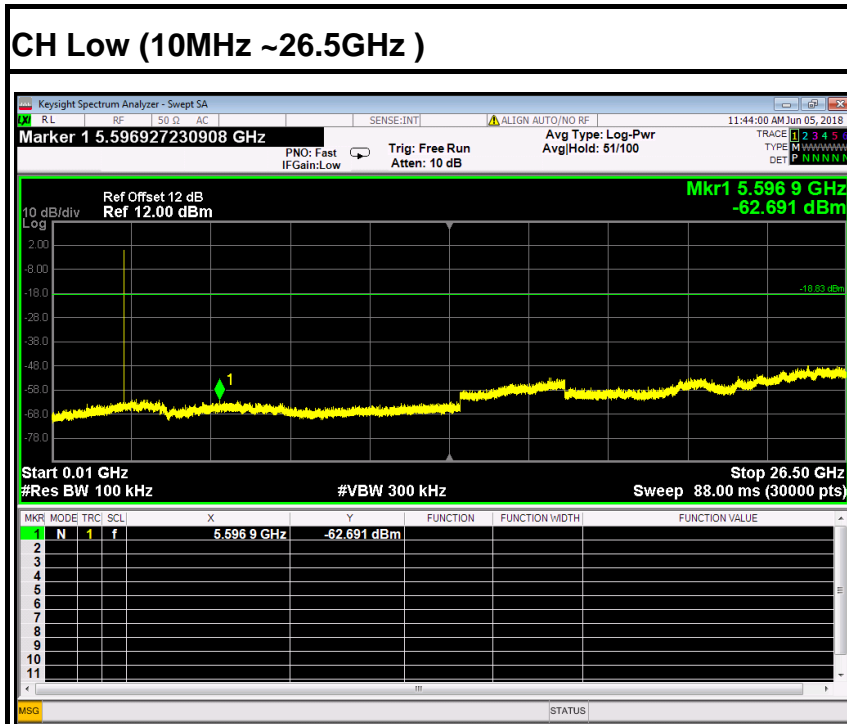





CH High (10MHz ~26.5GHz)

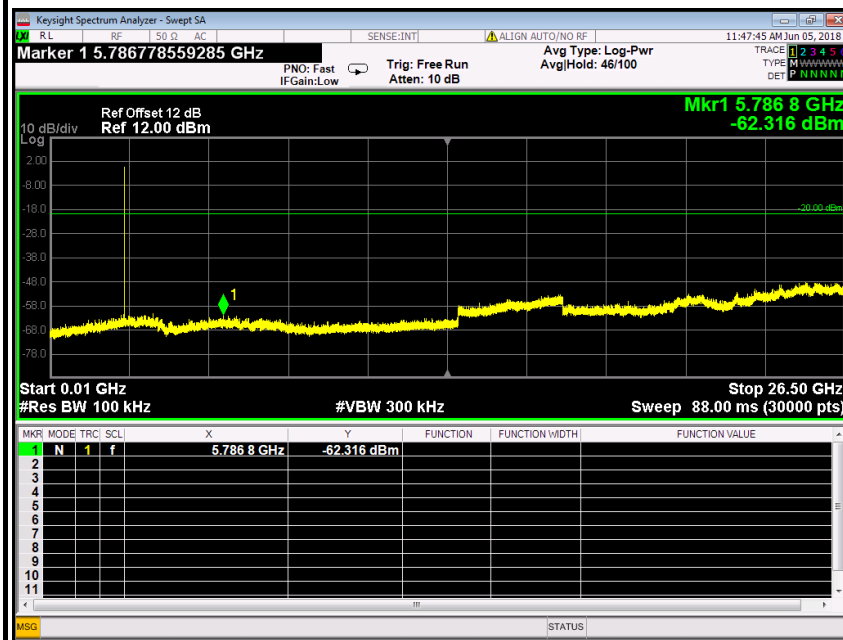

CH High (2.475GHz ~ 2.5GHz)

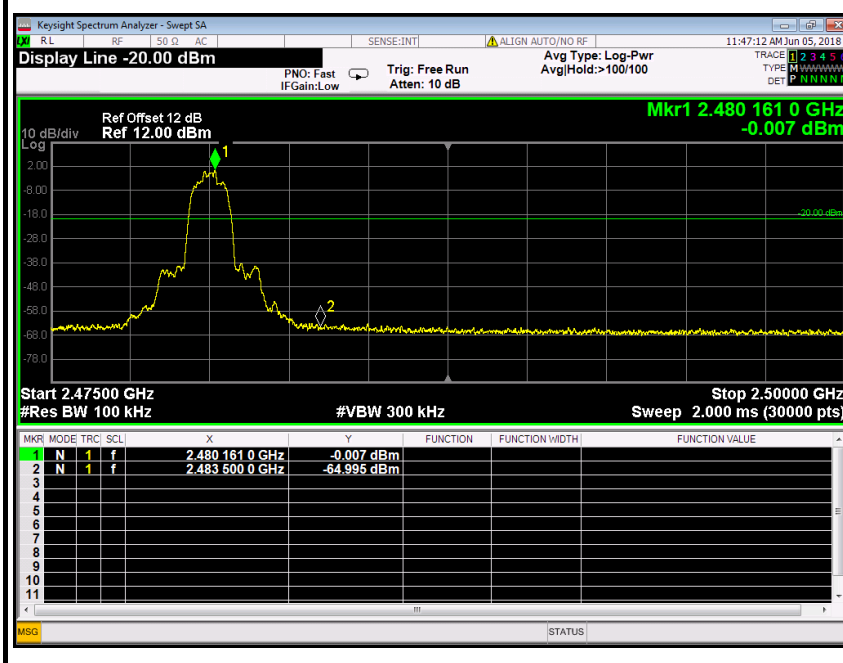



Hopping On

Test Data (GFSK)

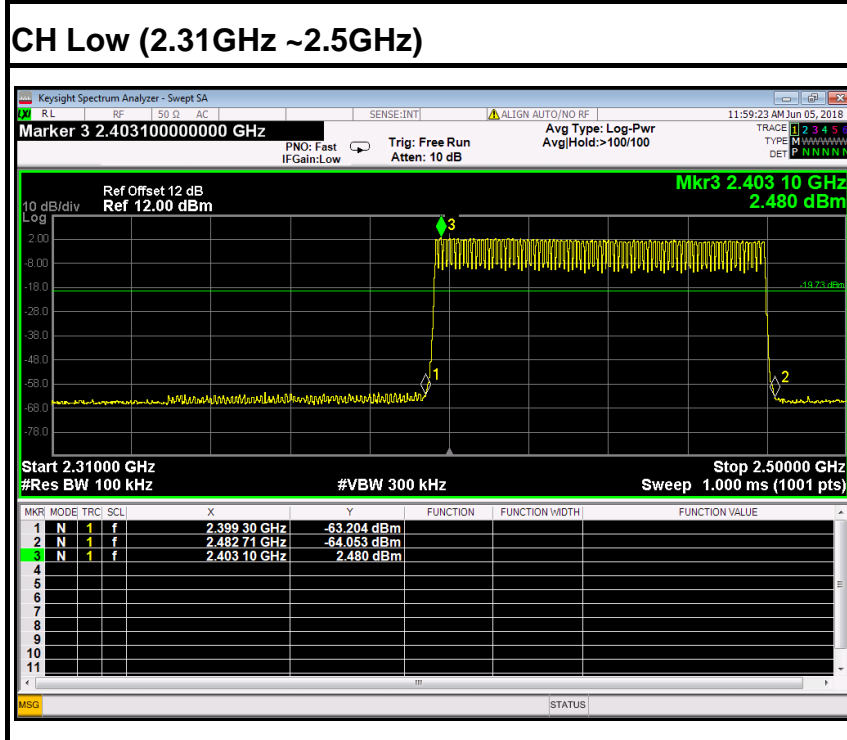

Test Data (8DPSK)

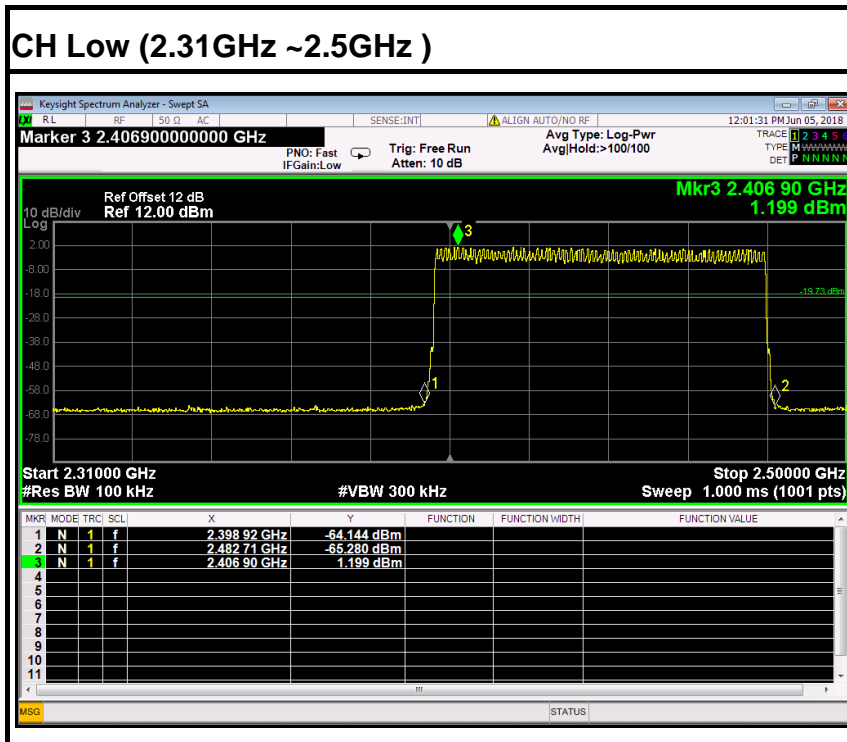



7.9.2. Radiated Emissions

LIMIT

1. Except as provided elsewhere in this Subpart, the emissions from an intentional radiator shall not exceed the field strength levels specified in the following table:

Frequency (MHz)	Field Strength (mV/m)	Measurement Distance (m)
0.009-0.490	2400/F(kHz)	300
0.490-1.705	24000/F(kHz)	30
1.705-30.0	30	30
30-88	100*	3
88-216	150*	3
216-960	200*	3
Above 960	500	3

Note: Except as provided in paragraph (g), fundamental emissions from intentional radiators operating under this Section shall not be located in the frequency bands 54-72 MHz, 76-88 MHz, 174-216 MHz or 470-806 MHz. However, operation within these frequency bands is permitted under other sections of this Part, e.g., Sections 15.231 and 15.241.

2. In the above emission table, the tighter limit applies at the band edges.

Frequency (Hz)	Field Strength ($\mu\text{V}/\text{m}$ at 3-meter)	Field Strength ($\text{dB}\mu\text{V}/\text{m}$ at 3-meter)
30-88	100	40
88-216	150	43.5
216-960	200	46
Above 960	500	54



MEASUREMENT EQUIPMENT USED

Radiated Emission Test Site 966 (2)					
Name of Equipment	Manufacturer	Model Number	Serial Number	Last Calibration	Due Calibration
PSA Series Spectrum Analyzer	Agilent	N9010A	MY52221469	01/27/2018	01/26/2019
EMI TEST RECEIVER	ROHDE&SCHWARZ	ESCI	100783	02/21/2018	02/20/2019
Amplifier	EMEC	EM330	060661	03/18/2018	03/17/2019
High Noise Amplifier	Agilent	8449B	3008A01838	02/21/2018	02/20/2019
Loop Antenna	COM-POWER	AL-130	121044	09/25/2017	09/24/2018
Bilog Antenna	SCHAFFNER	CBL6143	5082	02/21/2018	02/20/2019
Horn Antenna	SCHWARZBECK	BBHA9120	D286	02/27/2018	02/27/2019
Board-Band Horn Antenna	Schwarzbeck	BBHA 9170	9170-497	02/27/2018	02/27/2019
Turn Table	N/A	N/A	N/A	N.C.R	N.C.R
Antenna Tower	SUNOL	TLT2	N/A	N.C.R	N.C.R
Controller	Sunol Sciences	SC104V	022310-1	N.C.R	N.C.R
Controller	CT	N/A	N/A	N.C.R	N.C.R
Temp. / Humidity Meter	Anymetre	JR913	N/A	01/29/2018	01/28/2019
Test S/W	FARAD	LZ-RF / CCS-SZ-3A2			

Remark: Each piece of equipment is scheduled for calibration once a year.

Test Configuration

Below 30MHz

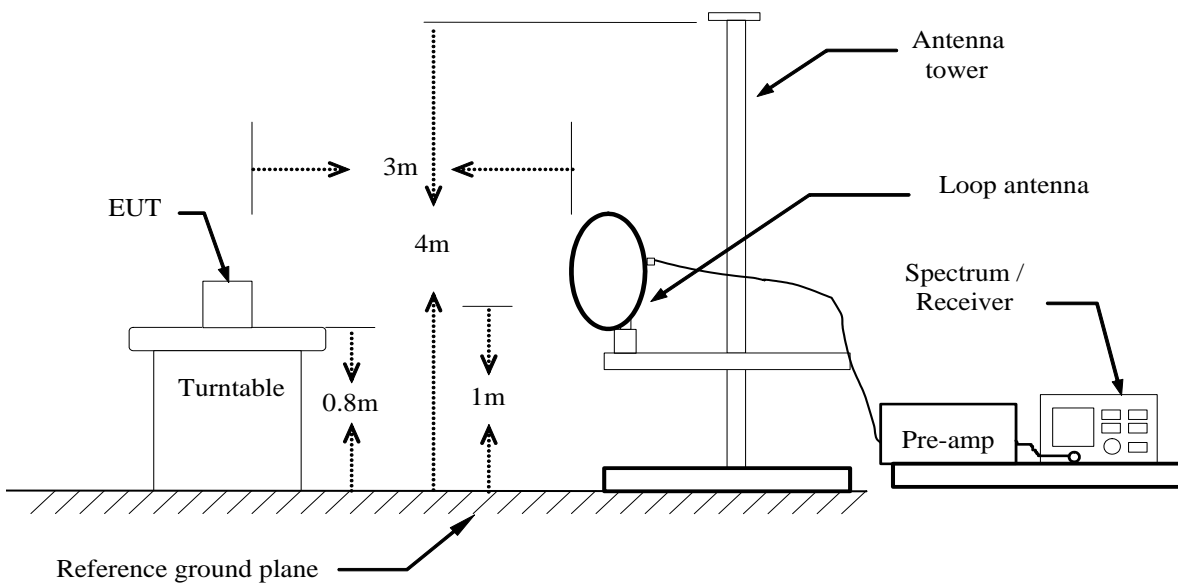



Below 1 GHz

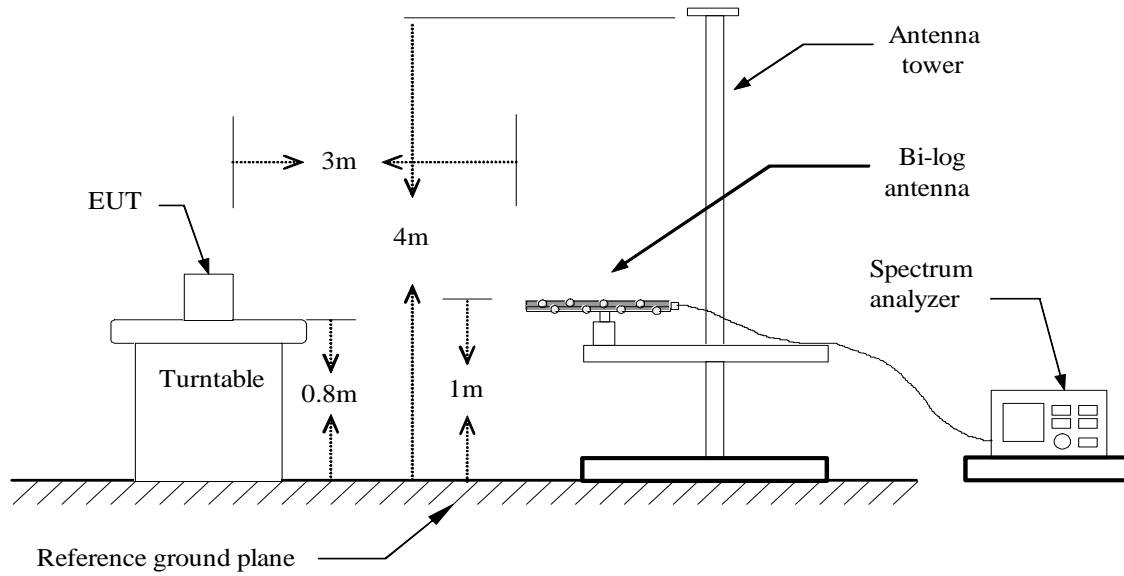

Above 1 GHz

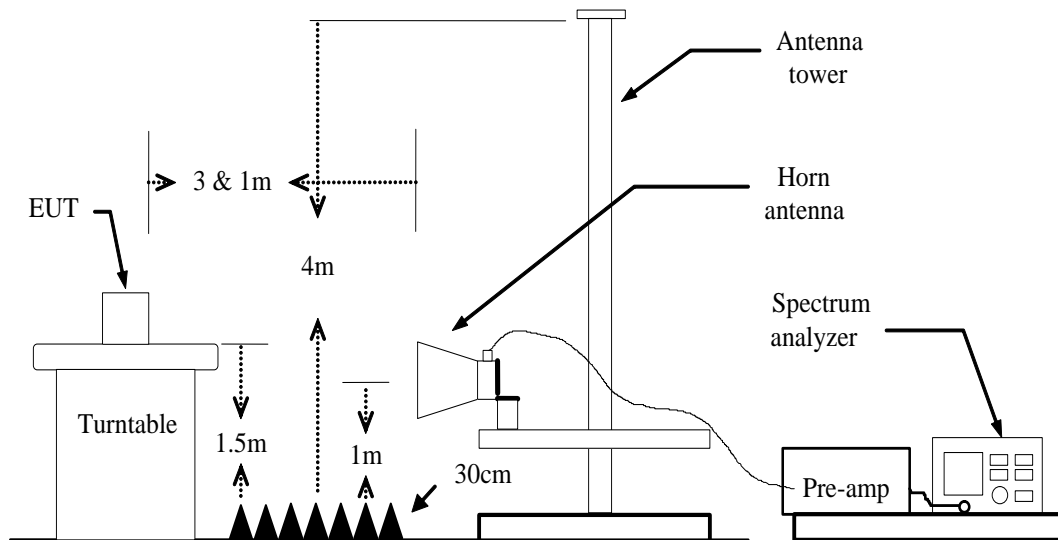



MEASURING SETTING

The following table is the setting of spectrum analyzer and receiver.

Spectrum Parameter	Setting
Attenuation	Auto
Start Frequency	1000 MHz
Stop Frequency	10th carrier harmonic
RB / VB (Emission in restricted band)	1MHz / 1MHz for Peak, 1 MHz / 1/T for Average
RB / VB (Emission in non-restricted band)	1MHz / 1MHz for Peak, 1 MHz / 1/T for Average

Receiver Parameter	Setting
Attenuation	Auto
Start ~ Stop Frequency	9kHz~150kHz / RB 200Hz for QP/AVG
Start ~ Stop Frequency	150kHz~30MHz / RB 9kHz for QP/AVG
Start ~ Stop Frequency	30MHz~1000MHz / RB 100kHz for QP

TEST PROCEDURE

1) Sequence of testing 9 kHz to 30 MHz

Setup:

- The equipment was set up to simulate a typical usage like described in the user manual or described by manufacturer.
- If the EUT is a tabletop system, a rotatable table with 0.8 m height is used.
- If the EUT is a floor standing device, it is placed on the ground.
- Auxiliary equipment and cables were positioned to simulate normal operation conditions.
- The AC power port of the EUT (if available) is connected to a power outlet below the turntable.
- The measurement distance is 3 meter.
- The EUT was set into operation.

Pre measurement:

- The turntable rotates from 0° to 315° using 45° steps.
- The antenna height is 0.8 meter.
- At each turntable position the analyzer sweeps with peak detection to find the maximum of all emissions



Final measurement:

--- Identified emissions during the pre measurement the software maximizes by rotating the turntable position (0° to 360°) and by rotating the elevation axes (0° to 360°).

--- The final measurement will be done in the position (turntable and elevation) causing the highest emissions with QPK detector.

--- The final levels, frequency, measuring time, bandwidth, turntable position, correction factor, margin to the limit and limit will be recorded. Also a plot with the graph of the pre measurement and the limit will be stored.

2) Sequence of testing 30 MHz to 1 GHz

Setup:

--- The equipment was set up to simulate a typical usage like described in the user manual or described by manufacturer.

--- If the EUT is a tabletop system, a table with 0.8 m height is used, which is placed on the ground plane.

--- If the EUT is a floor standing device, it is placed on the ground plane with insulation between both.

--- Auxiliary equipment and cables were positioned to simulate normal operation conditions

--- The AC power port of the EUT (if available) is connected to a power outlet below the turntable.

--- The measurement distance is 3 meter.

--- The EUT was set into operation.

Pre measurement:

--- The turntable rotates from 0° to 315° using 45° steps.

--- The antenna is polarized vertical and horizontal.

--- The antenna height changes from 1 to 3 meter.

--- At each turntable position, antenna polarization and height the analyzer sweeps three times in peak to find the maximum of all emissions.



Final measurement:

- The final measurement will be performed with minimum the six highest peaks.
- According to the maximum antenna and turntable positions of premeasurement the software maximize the peaks by changing turntable position ($\pm 45^\circ$) and antenna movement between 1 and 4 meter.
- The final measurement will be done with QP detector with an EMI receiver.
- The final levels, frequency, measuring time, bandwidth, antenna height, antenna polarization, turntable angle, correction factor, margin to the limit and limit will be recorded. Also a plot with the graph of the premeasurement with marked maximum final measurements and the limit will be stored.

3) Sequence of testing 1 GHz to 18 GHz

Setup:

- The equipment was set up to simulate a typical usage like described in the user manual or described by manufacturer.
- If the EUT is a tabletop system, a rotatable table with 1.5 m height is used.
- If the EUT is a floor standing device, it is placed on the ground plane with insulation between both.
- Auxiliary equipment and cables were positioned to simulate normal operation conditions
- The AC power port of the EUT (if available) is connected to a power outlet below the turntable.
- The measurement distance is 3 meter.
- The EUT was set into operation.

Pre measurement:

- The turntable rotates from 0° to 315° using 45° steps.
- The antenna is polarized vertical and horizontal.
- The antenna height scan range is 1 meter to 2.5 meter.
- At each turntable position and antenna polarization the analyzer sweeps with peak detection to find the maximum of all emissions.



Final measurement:

--- The final measurement will be performed with minimum the six highest peaks.

--- According to the maximum antenna and turntable positions of premeasurement the software maximize the peaks by changing turntable position ($\pm 45^\circ$) and antenna movement between 1 and 4 meter. This procedure is repeated for both antenna polarizations.

--- The final measurement will be done in the position (turntable, EUT-table and antenna polarization) causing the highest emissions with Peak and Average detector.

--- The final levels, frequency, measuring time, bandwidth, turntable position, EUT-table position, antenna polarization, correction factor, margin to the limit and limit will be recorded. Also a plot with the graph of the pre measurement with marked maximum final measurements and the limit will be stored.

4) Sequence of testing above 18 GHz

Setup:

--- The equipment was set up to simulate a typical usage like described in the user manual or described by manufacturer.

--- If the EUT is a tabletop system, a rotatable table with 1.5 m height is used.

--- If the EUT is a floor standing device, it is placed on the ground plane with insulation between both.

--- Auxiliary equipment and cables were positioned to simulate normal operation conditions

--- The AC power port of the EUT (if available) is connected to a power outlet below the turntable.

--- The measurement distance is 1 meter.

--- The EUT was set into operation.

Pre measurement:

--- The antenna is moved spherical over the EUT in different polarisations of the antenna.

Final measurement:

--- The final measurement will be performed at the position and antenna orientation for all detected emissions that were found during the premeasurements with Peak and Average detector.

--- The final levels, frequency, measuring time, bandwidth, correction factor, margin to the limit and limit will be recorded. Also a plot with the graph of the premeasurement and the limit will be stored.

**TEST RESULTS****Below 1 GHz****Test Mode:** TX / GFSK(CH Low)**Tested by:** Saber Huang**Ambient temperature:** 24°C **Relative humidity:** 52% RH**Date:** May 25, 2018

Frequency (MHz)	Reading (dBuV)	Correction Factor (dB/m)	Result (dBuV/m)	Limit (dBuV/m)	Margin (dB)	Antenna Pole (V/H)	Remark
48.4300	56.23	-20.43	35.80	40.00	-4.20	V	QP
199.7500	45.38	-22.73	22.65	43.50	-20.85	V	QP
416.0600	38.81	-15.49	23.32	46.00	-22.68	V	QP
668.2600	29.88	-12.16	17.72	46.00	-28.28	V	QP
764.2900	28.71	-11.07	17.64	46.00	-28.36	V	QP
879.7200	33.47	-9.98	23.49	46.00	-22.51	V	QP
127.0000	43.84	-20.87	22.97	43.50	-20.53	H	QP
197.8100	48.71	-22.76	25.95	43.50	-17.55	H	QP
431.5800	30.91	-15.60	15.31	46.00	-30.69	H	QP
516.9400	29.75	-14.17	15.58	46.00	-30.42	H	QP
599.3900	28.48	-12.88	15.60	46.00	-30.40	H	QP
851.5900	28.11	-10.68	17.43	46.00	-28.57	H	QP

****Remark:** 1. No emission found between lowest internal used/generated frequency to 30MHz.
2. Pre-scan all mode and recorded the worst case results in this report (TX-Low Channel(1Mbps)).

Notes:

1. Measuring frequencies from 9kHz to the 1GHz.
2. Radiated emissions measured in frequency range from 30MHz to 1GHz were made with an instrument using Peak/Quasi-peak detector mode.
3. Data of measurement within this frequency range shown " --- " in the table above means the reading of emissions are attenuated more than 20dB below the permissible limits or the field strength is too small to be measured.
4. The IF bandwidth of SPA between 30MHz to 1GHz was 120kHz.
5.

Frequency (MHz).	= Emission frequency in MHz
Reading (dBuV)	= Receiver reading
Correction Factor(dB/m)	= Antenna factor + Cable loss – Amplifier gain
Actual FS (dBuV/m)	= Reading (dBuV) + Corr. Factor (dB/m)
Limit (dBuV/m)	= Limit stated in standard
Margin(dB)	= Measured (dBuV/m) – Limits (dBuV/m)
Antenna Pole(V/H)	= Current carrying line of reading



Vertical

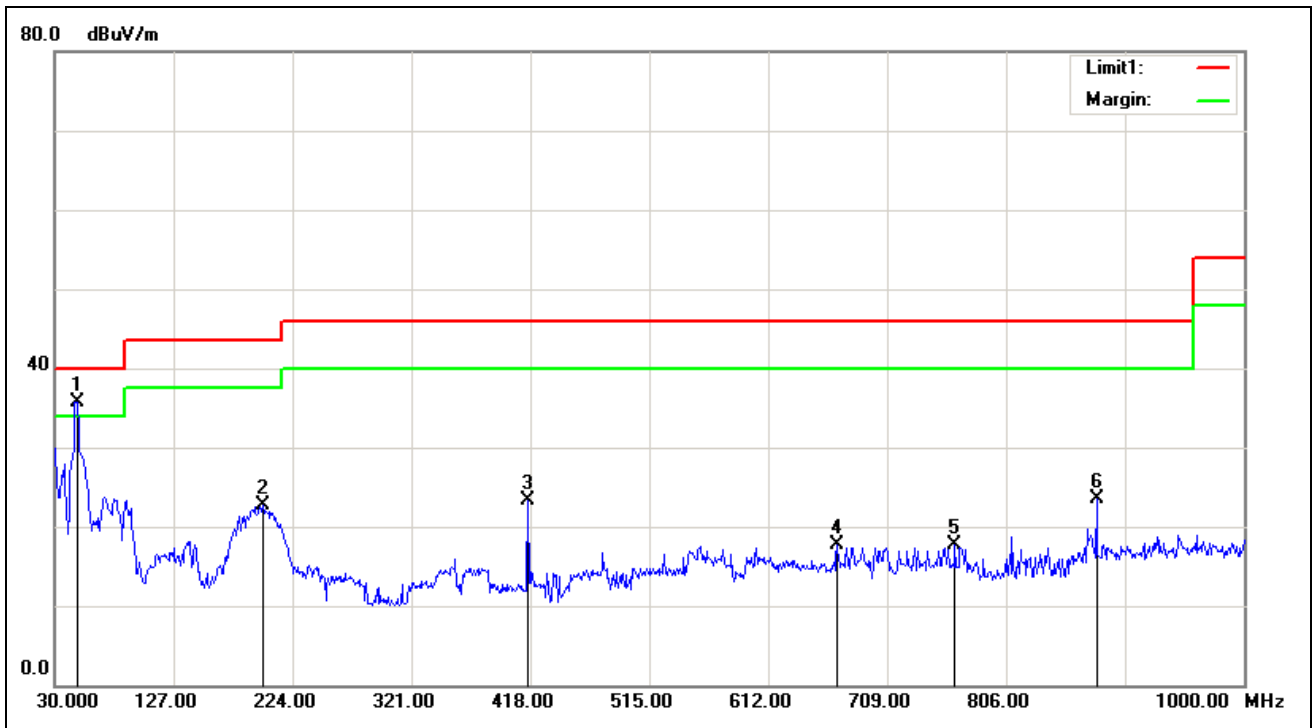

Horizontal

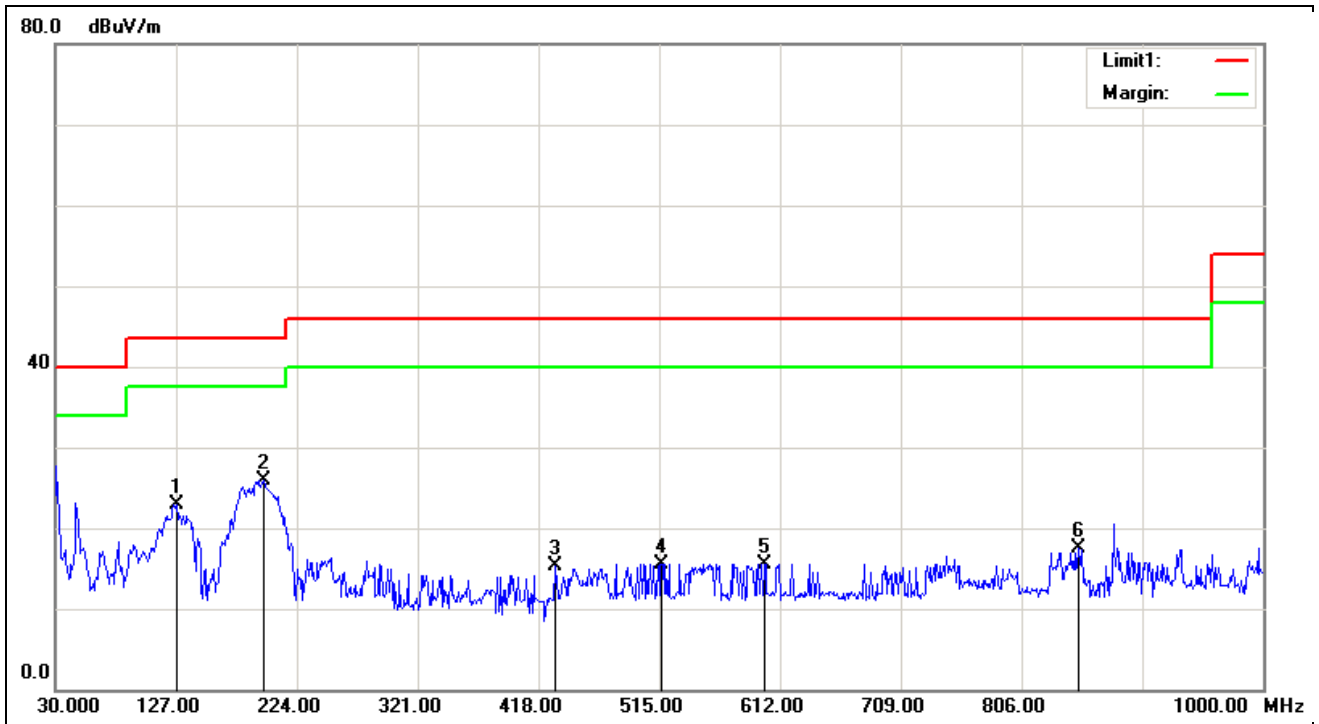



Above 1 GHz

GFSK

Test Mode: TX(CH Low)

Tested by: Saber Huang

Ambient temperature: 24°C **Relative humidity:** 52% RH

Date: May 25, 2018

Frequency (MHz)	Reading (dBuV)	Correction Factor (dB/m)	Result (dBuV/m)	Limit (dBuV/m)	Margin (dB)	Antenna Pole (V/H)	Remark
1342.000	48.61	-7.27	41.34	74.00	-32.66	V	peak
2206.000	45.74	-3.87	41.87	74.00	-32.13	V	peak
2683.000	45.74	-1.93	43.81	74.00	-30.19	V	peak
3646.000	43.14	0.10	43.24	74.00	-30.76	V	peak
4447.000	40.83	3.16	43.99	74.00	-30.01	V	peak
4762.000	42.35	4.20	46.55	74.00	-27.45	V	peak
1342.000	47.94	-7.27	40.67	74.00	-33.33	H	Peak
1720.000	45.99	-6.44	39.55	74.00	-34.45	H	Peak
2197.000	46.13	-3.92	42.21	74.00	-31.79	H	Peak
3646.000	43.75	0.10	43.85	74.00	-30.15	H	peak
4069.000	42.56	1.83	44.39	74.00	-29.61	H	peak
4753.000	42.02	4.17	46.19	74.00	-27.81	H	peak

Notes:

1. Measuring frequencies from 1 GHz to the 10th harmonic of highest fundamental frequency.
2. Measurements above show only up to 6 maximum emissions noted, or would be lesser if no specific emissions from the EUT are recorded (ie: margin>20dB from the applicable limit) and considered that's already beyond the background noise floor.
3. Radiated emissions measured in frequency above 1000MHz were made with an instrument using Peak detector mode and average detector mode of the emission shown in Actual FS column.
4. Spectrum setting:
 - a. Peak Setting 1GHz - 26GHz, RBW = 1MHz, VBW = 3MHz, Sweep time = auto.
 - b. AV Setting 1GHz - 26GHz, RBW = 1MHz, VBW = 10Hz, Sweep time = auto.
5. Frequency (MHz) = Emission frequency in MHz
 Reading (dBμV/m) =Uncorrected Analyzer / Receiver Reading
 Correction Factor (dB) = Antenna factor + Cable loss – Amplifier gain
 Limit (dBμV/m) = Limit stated in standard
 Margin (dB) = Result (dBμV/m)- Limit (dBμV/m)
 Pk = Peak Reading
 AV. = Average Reading
 Remark = Mark Peak Reading or Average Reading



Test Mode: TX(CH Mid)

Tested by: Saber Huang

Ambient temperature: 24°C

Relative humidity: 52% RH

Date: May 25, 2018

Frequency (MHz)	Reading (dBuV)	Correction Factor (dB/m)	Result (dBuV/m)	Limit (dBuV/m)	Margin (dB)	Antenna Pole (V/H)	Remark
1324.000	47.15	-7.34	39.81	74.00	-34.19	V	peak
2224.000	46.28	-3.77	42.51	74.00	-31.49	V	peak
2872.000	45.16	-1.59	43.57	74.00	-30.43	V	peak
3682.000	43.98	0.25	44.23	74.00	-29.77	V	peak
4177.000	42.51	2.21	44.72	74.00	-29.28	V	peak
5707.000	41.64	5.96	47.60	74.00	-26.40	V	peak
1306.000	47.50	-7.40	40.10	74.00	-33.90	H	Peak
2251.000	45.55	-3.62	41.93	74.00	-32.07	H	Peak
2674.000	45.96	-1.95	44.01	74.00	-29.99	H	Peak
3952.000	42.07	1.39	43.46	74.00	-30.54	H	peak
4807.000	40.46	4.35	44.81	74.00	-29.19	H	peak
5473.000	41.75	5.82	47.57	74.00	-26.43	H	peak

Notes:

1. Measuring frequencies from 1 GHz to the 10th harmonic of highest fundamental frequency.
2. Measurements above show only up to 6 maximum emissions noted, or would be lesser if no specific emissions from the EUT are recorded (ie: margin>20dB from the applicable limit) and considered that's already beyond the background noise floor.
3. Radiated emissions measured in frequency above 1000MHz were made with an instrument using Peak detector mode and average detector mode of the emission shown in Actual FS column.
4. Spectrum setting:
 - a. Peak Setting 1GHz - 26GHz, RBW = 1MHz, VBW = 3MHz, Sweep time = auto.
 - b. AV Setting 1GHz - 26GHz, RBW = 1MHz, VBW = 10Hz, Sweep time = auto.
5. Frequency (MHz) = Emission frequency in MHz
 Reading (dBuV/m) = Uncorrected Analyzer / Receiver Reading
 Correction Factor (dB) = Antenna factor + Cable loss – Amplifier gain
 Limit (dBuV/m) = Limit stated in standard
 Margin (dB) = Result (dBuV/m)- Limit (dBuV/m)
 Pk = Peak Reading
 AV = Average Reading
 Remark = Mark Peak Reading or Average Reading



Test Mode: TX(CH High)

Tested by: Saber Huang

Ambient temperature: 24°C

Relative humidity: 52% RH

Date: May 25, 2018

Frequency (MHz)	Reading (dBuV)	Correction Factor (dB/m)	Result (dBuV/m)	Limit (dBuV/m)	Margin (dB)	Antenna Pole (V/H)	Remark
1342.000	47.33	-7.27	40.06	74.00	-33.94	V	peak
2188.000	45.68	-3.97	41.71	74.00	-32.29	V	peak
3394.000	43.44	-0.70	42.74	74.00	-31.26	V	peak
4591.000	41.11	3.65	44.76	74.00	-29.24	V	peak
4996.000	42.11	4.97	47.08	74.00	-26.92	V	peak
5536.000	41.45	5.89	47.34	74.00	-26.66	V	peak
1342.000	46.29	-7.27	39.02	74.00	-34.98	H	Peak
1432.000	45.86	-7.00	38.86	74.00	-35.14	H	Peak
2044.000	45.75	-4.76	40.99	74.00	-33.01	H	Peak
2899.000	43.09	-1.54	41.55	74.00	-32.45	H	peak
4132.000	41.99	2.05	44.04	74.00	-29.96	H	peak
4591.000	41.89	3.65	45.54	74.00	-28.46	H	peak

Notes:

1. Measuring frequencies from 1 GHz to the 10th harmonic of highest fundamental frequency.
2. Measurements above show only up to 6 maximum emissions noted, or would be lesser if no specific emissions from the EUT are recorded (ie: margin>20dB from the applicable limit) and considered that's already beyond the background noise floor.
3. Radiated emissions measured in frequency above 1000MHz were made with an instrument using Peak detector mode and average detector mode of the emission shown in Actual FS column.
4. Spectrum setting:
 - a. Peak Setting 1GHz - 26GHz, RBW = 1MHz, VBW = 3MHz, Sweep time = auto.
 - b. AV Setting 1GHz - 26GHz, RBW = 1MHz, VBW = 10Hz, Sweep time = auto.
5. Frequency (MHz) = Emission frequency in MHz
 Reading (dBuV/m) =Uncorrected Analyzer / Receiver Reading
 Correction Factor (dB) = Antenna factor + Cable loss – Amplifier gain
 Limit (dBuV/m) = Limit stated in standard
 Margin (dB) = Result (dBuV/m)- Limit (dBuV/m)
 Pk = Peak Reading
 AV. = Average Reading
 Remark = Mark Peak Reading or Average Reading



8DPSK

Test Mode: TX(CH Low)

Tested by: Saber Huang

Ambient temperature: 24°C Relative humidity: 52% RH

Date: May 25, 2018

Frequency (MHz)	Reading (dBuV)	Correction Factor (dB/m)	Result (dBuV/m)	Limit (dBuV/m)	Margin (dB)	Antenna Pole (V/H)	Remark
2197.000	46.65	-3.92	42.73	74.00	-31.27	V	peak
2674.000	45.48	-1.95	43.53	74.00	-30.47	V	peak
3169.000	44.74	-1.08	43.66	74.00	-30.34	V	peak
4303.000	41.64	2.66	44.30	74.00	-29.70	V	peak
4762.000	42.59	4.20	46.79	74.00	-27.21	V	peak
5023.000	43.02	5.02	48.04	74.00	-25.96	V	peak
2179.000	45.30	-4.02	41.28	74.00	-32.72	H	Peak
2674.000	43.78	-1.95	41.83	74.00	-32.17	H	Peak
3709.000	44.68	0.36	45.04	74.00	-28.96	H	Peak
4267.000	42.82	2.53	45.35	74.00	-28.65	H	peak
4852.000	42.54	4.50	47.04	74.00	-26.96	H	peak
5788.000	42.24	5.99	48.23	74.00	-25.77	H	peak

Notes:

1. Measuring frequencies from 1 GHz to the 10th harmonic of highest fundamental frequency.
2. Measurements above show only up to 6 maximum emissions noted, or would be lesser if no specific emissions from the EUT are recorded (ie: margin>20dB from the applicable limit) and considered that's already beyond the background noise floor.
3. Radiated emissions measured in frequency above 1000MHz were made with an instrument using Peak detector mode and average detector mode of the emission shown in Actual FS column.
4. Spectrum setting:
 - a. Peak Setting 1GHz - 26GHz, RBW = 1MHz, VBW = 3MHz, Sweep time = auto.
 - b. AV Setting 1GHz - 26GHz, RBW = 1MHz, VBW = 10Hz, Sweep time = auto.
5. Frequency (MHz) = Emission frequency in MHz
 Reading (dBuV/m) = Uncorrected Analyzer / Receiver Reading
 Correction Factor (dB) = Antenna factor + Cable loss – Amplifier gain
 Limit (dBuV/m) = Limit stated in standard
 Margin (dB) = Result (dBuV/m)- Limit (dBuV/m)
 Pk = Peak Reading
 AV = Average Reading
 Remark = Mark Peak Reading or Average Reading



Test Mode: TX(CH Mid)

Tested by: Saber Huang

Ambient temperature: 24°C Relative humidity: 52% RH

Date: May 25, 2018

Frequency (MHz)	Reading (dBuV)	Correction Factor (dB/m)	Result (dBuV/m)	Limit (dBuV/m)	Margin (dB)	Antenna Pole (V/H)	Remark
2242.000	44.99	-3.67	41.32	74.00	-32.68	V	peak
2899.000	45.07	-1.54	43.53	74.00	-30.47	V	peak
3610.000	42.53	-0.06	42.47	74.00	-31.53	V	peak
4015.000	41.95	1.64	43.59	74.00	-30.41	V	peak
4321.000	41.70	2.72	44.42	74.00	-29.58	V	peak
4762.000	41.72	4.20	45.92	74.00	-28.08	V	peak
1477.000	46.28	-6.92	39.36	74.00	-34.64	H	Peak
2188.000	44.39	-3.97	40.42	74.00	-33.58	H	Peak
2908.000	43.81	-1.53	42.28	74.00	-31.72	H	Peak
3700.000	42.91	0.32	43.23	74.00	-30.77	H	peak
4240.000	42.27	2.43	44.70	74.00	-29.30	H	peak
5131.000	41.00	5.21	46.21	74.00	-27.79	H	peak

Notes:

1. Measuring frequencies from 1 GHz to the 10th harmonic of highest fundamental frequency.
2. Measurements above show only up to 6 maximum emissions noted, or would be lesser if no specific emissions from the EUT are recorded (ie: margin>20dB from the applicable limit) and considered that's already beyond the background noise floor.
3. Radiated emissions measured in frequency above 1000MHz were made with an instrument using Peak detector mode and average detector mode of the emission shown in Actual FS column.
4. Spectrum setting:
 - a. Peak Setting 1GHz - 26GHz, RBW = 1MHz, VBW = 3MHz, Sweep time = auto.
 - b. AV Setting 1GHz - 26GHz, RBW = 1MHz, VBW = 10Hz, Sweep time = auto.
5. Frequency (MHz) = Emission frequency in MHz
 Reading (dBuV/m) = Uncorrected Analyzer / Receiver Reading
 Correction Factor (dB) = Antenna factor + Cable loss – Amplifier gain
 Limit (dBuV/m) = Limit stated in standard
 Margin (dB) = Result (dBuV/m)- Limit (dBuV/m)
 Pk = Peak Reading
 AV = Average Reading
 Remark = Mark Peak Reading or Average Reading



Test Mode: TX(CH High)

Tested by: Saber Huang

Ambient temperature: 24°C Relative humidity: 52% RH

Date: May 25, 2018

Frequency (MHz)	Reading (dBuV)	Correction Factor (dB/m)	Result (dBuV/m)	Limit (dBuV/m)	Margin (dB)	Antenna Pole (V/H)	Remark
1711.000	47.47	-6.46	41.01	74.00	-32.99	V	peak
2251.000	46.98	-3.62	43.36	74.00	-30.64	V	peak
3169.000	45.54	-1.08	44.46	74.00	-29.54	V	peak
4123.000	42.89	2.02	44.91	74.00	-29.09	V	peak
4762.000	43.58	4.20	47.78	74.00	-26.22	V	peak
5068.000	41.81	5.10	46.91	74.00	-27.09	V	peak
1729.000	46.52	-6.42	40.10	74.00	-33.90	H	Peak
2233.000	45.65	-3.72	41.93	74.00	-32.07	H	Peak
2926.000	45.31	-1.49	43.82	74.00	-30.18	H	Peak
3628.000	43.57	0.02	43.59	74.00	-30.41	H	peak
4285.000	42.36	2.59	44.95	74.00	-29.05	H	peak
5131.000	42.75	5.21	47.96	74.00	-26.04	H	peak

Notes:

1. Measuring frequencies from 1 GHz to the 10th harmonic of highest fundamental frequency.
2. Measurements above show only up to 6 maximum emissions noted, or would be lesser if no specific emissions from the EUT are recorded (ie: margin>20dB from the applicable limit) and considered that's already beyond the background noise floor.
3. Radiated emissions measured in frequency above 1000MHz were made with an instrument using Peak detector mode and average detector mode of the emission shown in Actual FS column.
4. Spectrum setting:
 - a. Peak Setting 1GHz - 26GHz, RBW = 1MHz, VBW = 3MHz, Sweep time = auto.
 - b. AV Setting 1GHz - 26GHz, RBW = 1MHz, VBW = 10Hz, Sweep time = auto.
5. Frequency (MHz) = Emission frequency in MHz
 Reading (dBuV/m) = Uncorrected Analyzer / Receiver Reading
 Correction Factor (dB) = Antenna factor + Cable loss – Amplifier gain
 Limit (dBuV/m) = Limit stated in standard
 Margin (dB) = Result (dBuV/m)- Limit (dBuV/m)
 Pk = Peak Reading
 AV = Average Reading
 Remark = Mark Peak Reading or Average Reading



7.10 POWERLINE CONDUCTED EMISSIONS

LIMIT

For an intentional radiator which is designed to be connected to the public utility (AC) power line, the radio frequency voltage that is conducted back onto the AC power line on any frequency or frequencies within the band 150 kHz to 30 MHz shall not exceed 250 microvolts (The limit decreases linearly with the logarithm of the frequency in the range 0.15 MHz to 0.50 MHz). The limits at specific frequency range is listed as follows:

Frequency Range (MHz)	Limits (dB μ V)	
	Quasi-peak	Average
0.15 to 0.50	66 to 56	56 to 46
0.50 to 5	56	46
5 to 30	60	50

Compliance with this provision shall be based on the measurement of the radio frequency voltage between each power line (LINE and NEUTRAL) and ground at the power terminals.

MEASUREMENT EQUIPMENT USED

Conducted Emission Test Site					
Name of Equipment	Manufacturer	Model Number	Serial Number	Last Calibration	Due Calibration
EMI TEST RECEIVER	ROHDE&SCHWARZ	ESCI	100783	01/27/2018	01/26/2019
LISN(EUT)	ROHDE&SCHWARZ	ENV216	101543-WX	01/27/2018	01/26/2019
LISN	EMCO	3825/2	8901-1459	01/27/2018	01/26/2019
Temp. / Humidity Meter	VICTOR	HTC-1	N/A	01/29/2018	01/28/2019
Test S/W	FARAD	EZ-EMC/ CCS-3A1-CE			

Remark: Each piece of equipment is scheduled for calibration once a year.



TEST CONFIGURATION

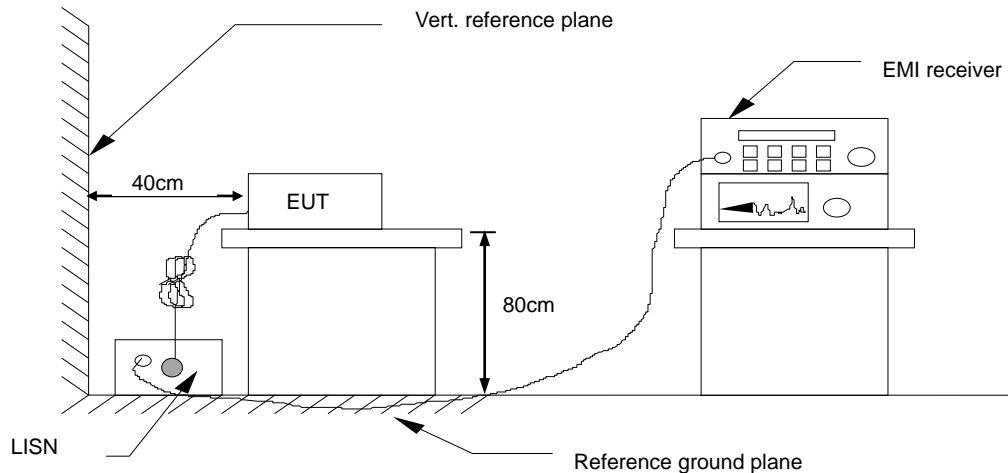

See test photographs attached in Appendix 1 for the actual connections between EUT and support equipment.

TEST PROCEDURE

1. The EUT was placed on a table, which is 0.8m above ground plane.
2. Maximum procedure was performed on the six highest emissions to ensure EUT compliance.
3. Repeat above procedures until all frequency measured were complete.

TEST RESULTS

The initial step in collecting conducted data is a spectrum analyzer peak scan of the measurement range. Significant peaks are then marked as shown on the following data page, and these signals are then quasi-peaked.



Test Data

Model No.	A8003	RBW,VBW	9 kHz
Environmental Conditions	22°C, 45% RH	Test Mode	Mode 4
Tested by	Eason Nie	Line	L1
Test Date	May 30, 2018		

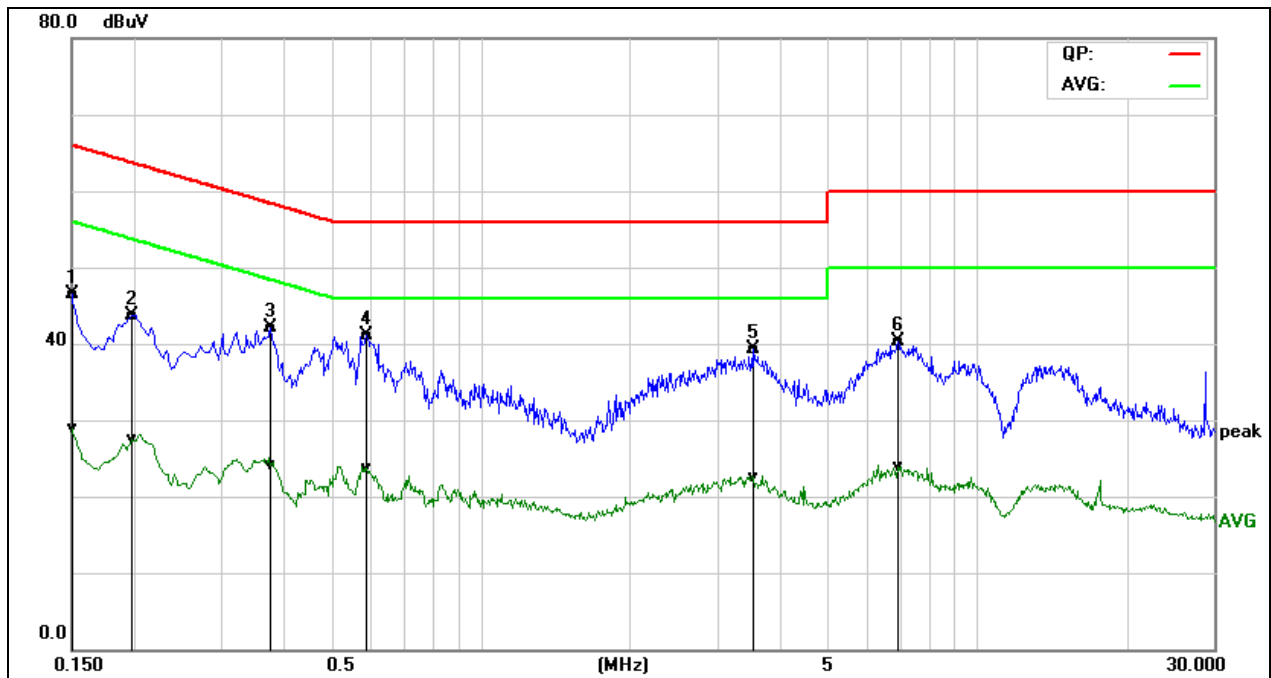

Frequency (MHz)	QuasiPeak Reading (dBuV)	Average Reading (dBuV)	Correction Factor (dB)	QuasiPeak Result (dBuV)	Average Result (dBuV)	QuasiPeak Limit (dBuV)	Average Limit (dBuV)	QuasiPeak Margin (dB)	Average Margin (dB)	Remark (Pass/Fail)
0.1500	26.80	9.38	19.62	46.42	29.00	65.99	56.00	-19.57	-27.00	Pass
0.1980	23.98	7.85	19.64	43.62	27.49	63.69	53.69	-20.07	-26.20	Pass
0.3780	22.53	4.60	19.57	42.10	24.17	58.32	48.32	-16.22	-24.15	Pass
0.5899	21.51	4.14	19.57	41.08	23.71	56.00	46.00	-14.92	-22.29	Pass
3.5380	19.61	2.75	19.73	39.34	22.48	56.00	46.00	-16.66	-23.52	Pass
6.9420	20.55	4.01	19.83	40.38	23.84	60.00	50.00	-19.62	-26.16	Pass

REMARKS: L1 = Line One (Live Line)



Model No.	A8003	RBW,VBW	9 kHz
Environmental Conditions	22°C, 45% RH	Test Mode	Mode 4
Tested by	Eason Nie	Line	L2
Test Date	May 30, 2018		

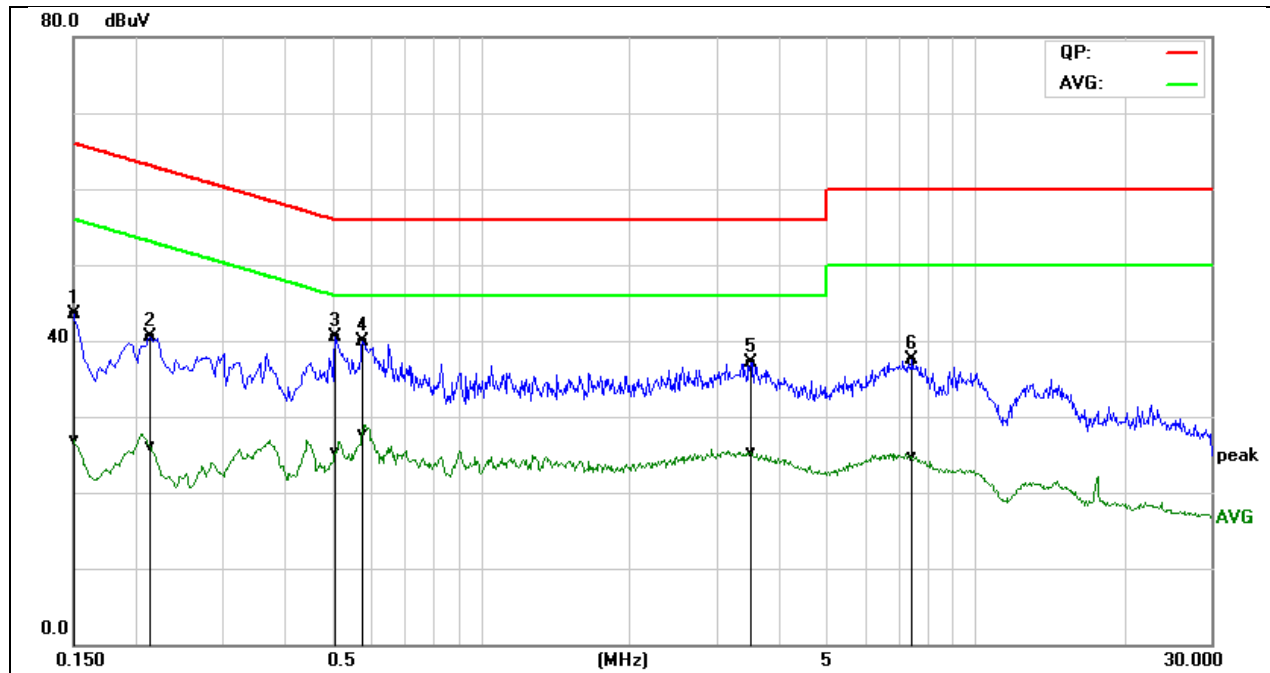

Frequency (MHz)	QuasiPeak Reading (dBuV)	Average Reading (dBuV)	Correction Factor (dB)	QuasiPeak Result (dBuV)	Average Result (dBuV)	QuasiPeak Limit (dBuV)	Average Limit (dBuV)	QuasiPeak Margin (dB)	Average Margin (dB)	Remark (Pass/Fail)
0.1500	23.93	7.37	19.52	43.45	26.89	65.99	56.00	-22.54	-29.11	Pass
0.2140	21.05	6.56	19.54	40.59	26.10	63.04	53.05	-22.45	-26.95	Pass
0.5100	20.93	5.73	19.53	40.46	25.26	56.00	46.00	-15.54	-20.74	Pass
0.5780	20.44	8.21	19.56	40.00	27.77	56.00	46.00	-16.00	-18.23	Pass
3.5140	17.33	5.47	19.77	37.10	25.24	56.00	46.00	-18.90	-20.76	Pass
7.4660	17.52	4.76	19.88	37.40	24.64	60.00	50.00	-22.60	-25.36	Pass

REMARKS: L2 = Line Two (Neutral Line)



Model No.	A8003	RBW,VBW	9 kHz
Environmental Conditions	22°C, 45% RH	Test Mode	Mode 20
Tested by	Eason Nie	Line	L1
Test Date	May 30, 2018	Test Voltage	AC 240V/50Hz

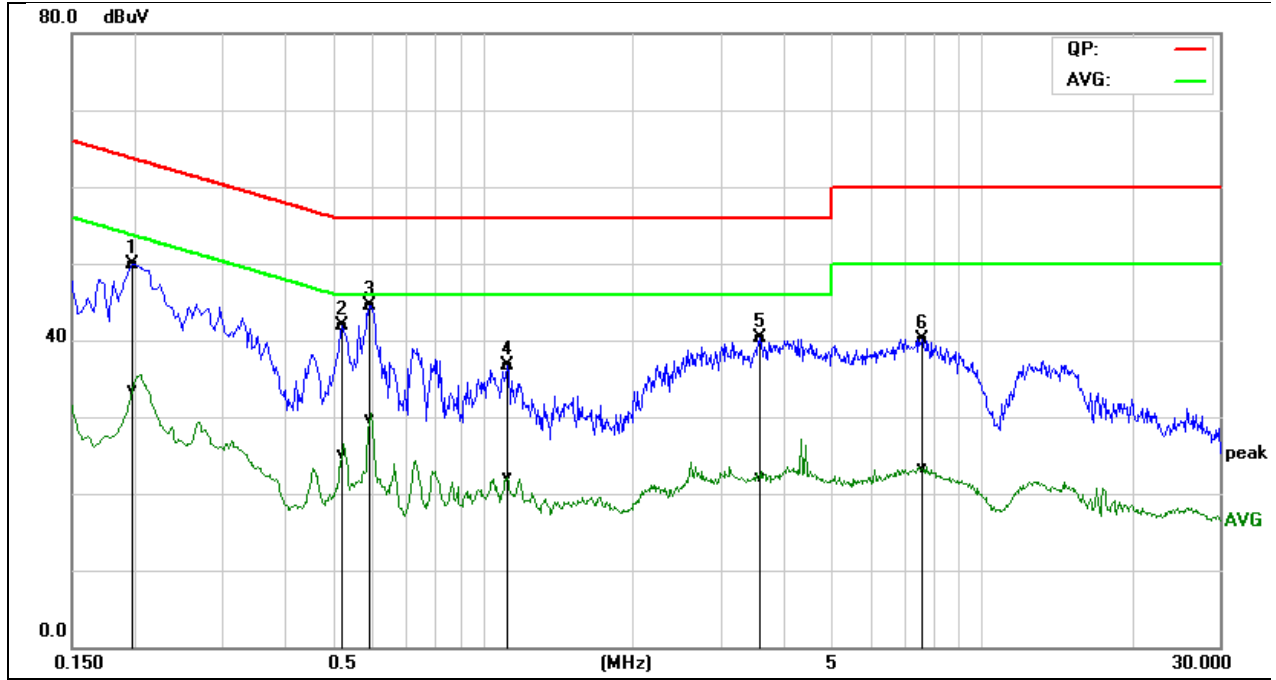

Frequency (MHz)	QuasiPeak Reading (dBuV)	Average Reading (dBuV)	Correction Factor (dB)	QuasiPeak Result (dBuV)	Average Result (dBuV)	QuasiPeak Limit (dBuV)	Average Limit (dBuV)	QuasiPeak Margin (dB)	Average Margin (dB)	Remark (Pass/Fail)
0.1980	30.30	13.78	19.64	49.94	33.42	63.69	53.69	-13.75	-20.27	Pass
0.5220	22.40	5.58	19.54	41.94	25.12	56.00	46.00	-14.06	-20.88	Pass
0.5940	25.01	10.06	19.57	44.58	29.63	56.00	46.00	-11.42	-16.37	Pass
1.1180	17.10	2.56	19.57	36.67	22.13	56.00	46.00	-19.33	-23.87	Pass
3.6020	20.53	2.46	19.73	40.26	22.19	56.00	46.00	-15.74	-23.81	Pass
7.6460	20.18	3.45	19.90	40.08	23.35	60.00	50.00	-19.92	-26.65	Pass

REMARKS: L1 = Line One (Live Line)



Model No.	A8003	RBW,VBW	9 kHz
Environmental Conditions	22°C, 45% RH	Test Mode	Mode 20
Tested by	Eason Nie	Line	L2
Test Date	May 30, 2018	Test Voltage	AC 240V/50Hz

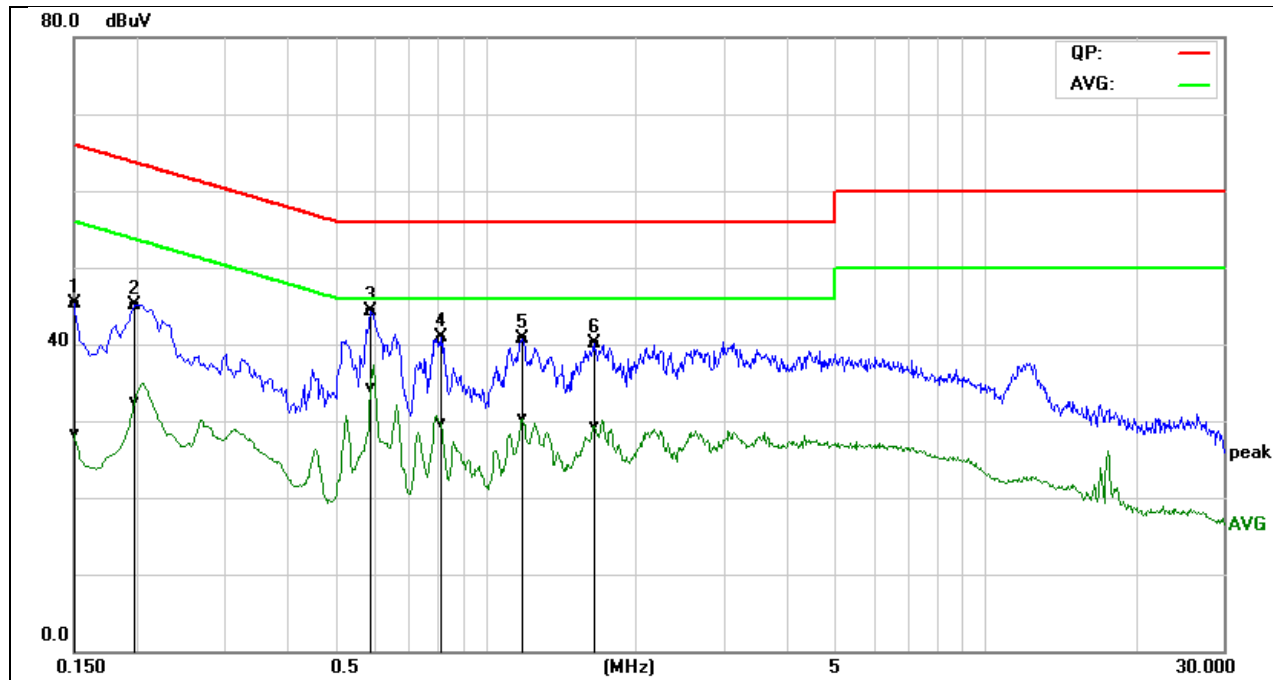

Frequency (MHz)	QuasiPeak Reading (dBuV)	Average Reading (dBuV)	Correction Factor (dB)	QuasiPeak Result (dBuV)	Average Result (dBuV)	QuasiPeak Limit (dBuV)	Average Limit (dBuV)	QuasiPeak Margin (dB)	Average Margin (dB)	Remark (Pass/Fail)
0.1500	25.74	8.75	19.52	45.26	28.27	65.99	56.00	-20.73	-27.73	Pass
0.1980	25.55	12.95	19.54	45.09	32.49	63.69	53.69	-18.60	-21.20	Pass
0.5899	24.65	14.79	19.57	44.22	34.36	56.00	46.00	-11.78	-11.64	Pass
0.8139	21.21	10.15	19.59	40.80	29.74	56.00	46.00	-15.20	-16.26	Pass
1.1900	21.05	10.77	19.58	40.63	30.35	56.00	46.00	-15.37	-15.65	Pass
1.6500	20.44	9.73	19.66	40.10	29.39	56.00	46.00	-15.90	-16.61	Pass

REMARKS: L2 = Line Two (Neutral Line)